

Antenna specification

Antenna Sample Confirmation From

Name of supplier	ShenZhen Aihui Technology Co. , Ltd				
Customer name	Ke Jing Ming				
Sample name	1098B				
model					
Sample size	Screen-printed DVD-AH size 21.89 * 18.49 line length; 110mm (0.81)4 generations				
Inspection item	Performance test	Visual inspection	Structure	In the news	Test results
Notes					
Quality Audit		Project Audit		Business confirmation	
The following is to be completed by the client					

Shenzhen Aihui Technology Co. , Ltd.

Power	Max: 2W	Impedance	50Ω
dBi	≥		
Test Equipment	HPE5071C、Shielding Room、3D automatic turntable		
<p>Antenna Description::</p> <p>1. Grounding processing and picture description: no</p> <p>2. Need to change the motherboard to match: no</p> <ul style="list-style-type: none">● Test voltage: 3.6V, check the antenna contact is good before testing.● The RF cable of the integrated tester is kept in a natural state and can not be curled. <p>Specification:test the specified power level, all indicators must conform to the specifications.</p>			

1. Project Image

2. Test Fixture

3. Antenna matching circuit

4. S11 test

5. Antenna passive efficiency and gain

6. Darkroom test equipment and data

7. Schematic diagram of antenna assembly

8. Antenna environment handling

9. Antenna mass production index

10. Structural drawing

1. Project Image

The final verification antenna performance prototype in our company for at least one year, easy to analyze and solve the problem of antenna mass production, to ensure the quality of antenna shipment

2. Test Fixture

Objective: to test the passive parameters of antenna as accurately as possible. Making Method: the handset is made of a 50 ohm coaxial cable, one end of which is connected to the test point of the back end of the matching circuit of the handset motherboard (front end of the RF test hole) , and the other end is connected to the SMA joint. The diagram is as follows:

3. Antenna matching circuit

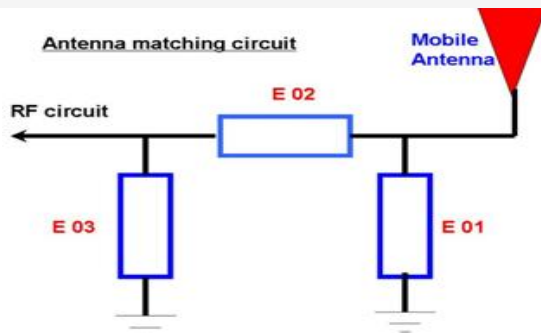

Modify

E01	E02	E03
No	No	No

Note: The match is unmodified.

4.S11 test

4.0 4.0s11 test method description of test equipment: Network Analyzer (E5071C) test method: a 50 ohm CABLE is used to export from the instrument test port. The SMA connector for connecting the handset is calibrated using a calibration piece, record the echo loss and standing wave ratio corresponding to the relevant frequency points. The test schematic is as follows:

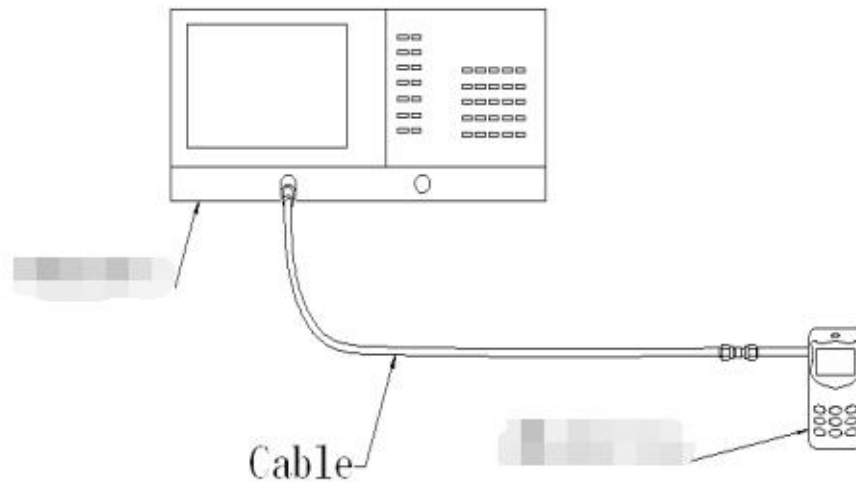

5.Darkroom test equipment and data

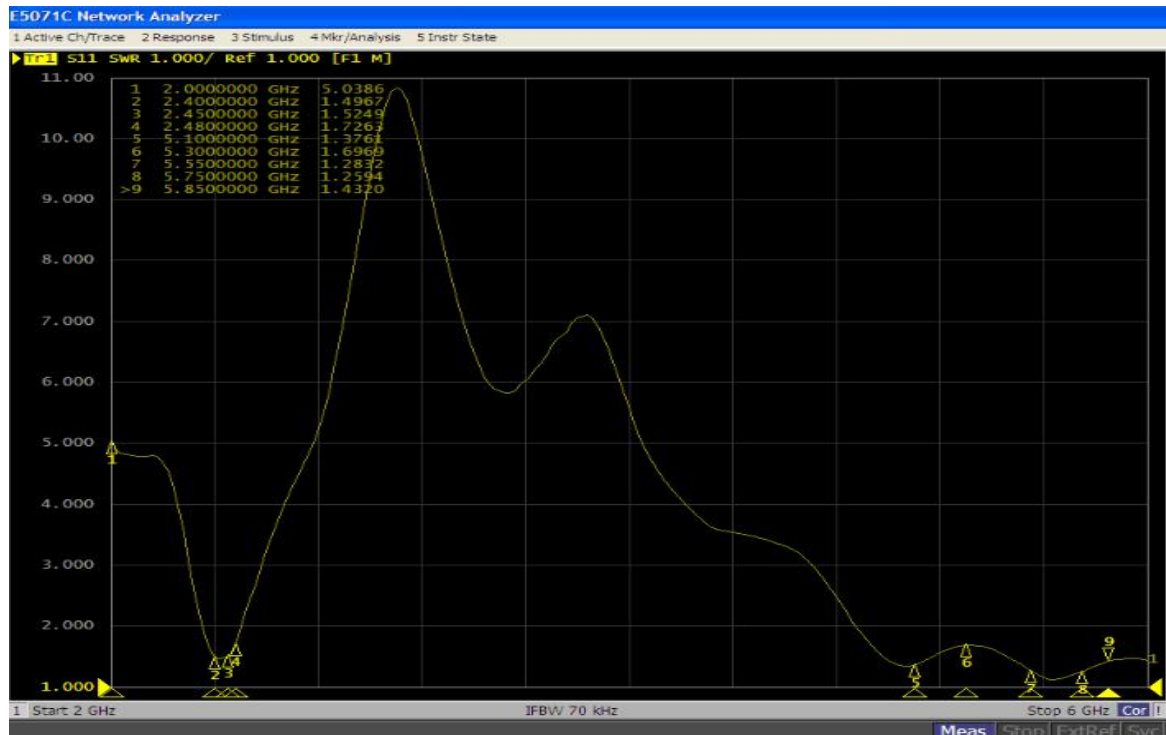

6.Test Equipment

Test system: shielded darkroom

The temperature was $22^{\circ}\text{C} \pm 3^{\circ}\text{C}$ and the humidity was $50\% \pm 15\%$

Test equipment: when testing passive data, use the Network analyzer AGILENTE5071C to test active data, use the omnibus CMW500



7.Active antenna test data



nce and
Shenzhen

Shenzhen Aihui Technology Co. , Ltd.

Frequency Band	2.4G-WIFI B模			2.4G-WIFI G模		
channel	L	M	H	L	M	H
TRP	13.28	13.65	13.81	11.73	11.69	11.86
TIS			-80.92			-68.02
Frequency Band	2.4G-WIFI N模					
channel	L	M	H			
TRP	11.72	11.48	11.71			
TIS			-67.19			

Gain&Efficiency 增益和效率			
frequency 频率(Hz)	gain 增益(dB)	efficiency 效率(dB)	efficiency 效率
2400M	1.46	-3.96	52.47%
2410M	1.32	-3.88	53.16%
2420M	1.54	-3.73	55.11%
2430M	1.61	-3.81	54.21%
2440M	1.26	-3.35	56.03%
2450M	1.39	-3.14	57.41%
2460M	1.73	-3.26	57.74%
2470M	1.68	-3.12	56.38%
2480M	1.63	-3.31	55.37%
2490M	1.43	-3.76	53.28%
2500M	1.44	-3.84	53.66%

Shenzhen Aihui Technology Co. , Ltd.

Gain&Efficiency			
frequency 频率(Hz)	gain 增益(dB)	efficiency 效率(dB)	efficiency 效率
5050M	1.9	-3.47	54.54%
5100M	2.01	-3.43	54.15%
5150M	2.37	-3.86	56.25%
5200M	2.55	-3.17	56.38%
5250M	2.09	-2.97	57.23%
5300M	2.16	-3.13	56.66%
5350M	2.73	-3.55	55.73%
5400M	2.12	-3.02	57.62%
5450M	1.98	-3.34	56.38%
5500M	1.83	-3.43	54.83%
5550M	2.06	-3.24	56.52%
5600M	2.14	-3.61	56.71%
5650M	2.27	-3.88	54.10%
5700M	2.12	-3.79	54.83%
5750M	1.85	-4.1	52.19%
5800M	1.8	-4.22	51.24%
5850M	1.76	-4.31	50.28%

2.4 G pattern

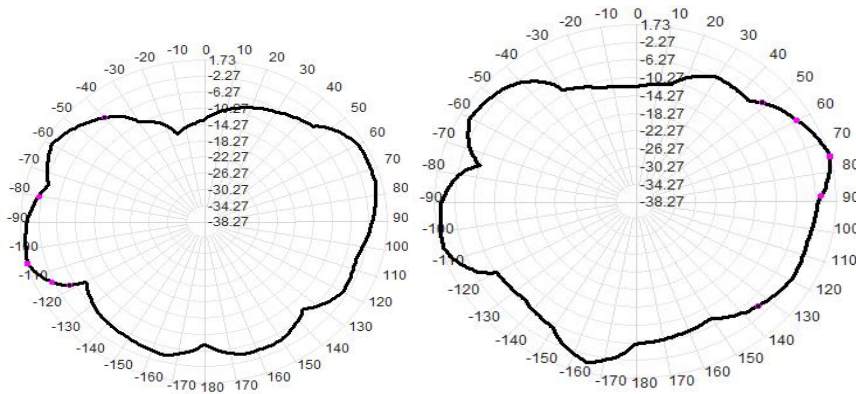
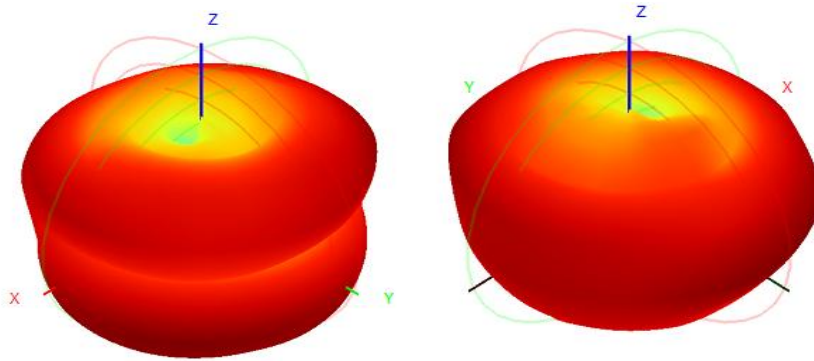

5.8 G pattern

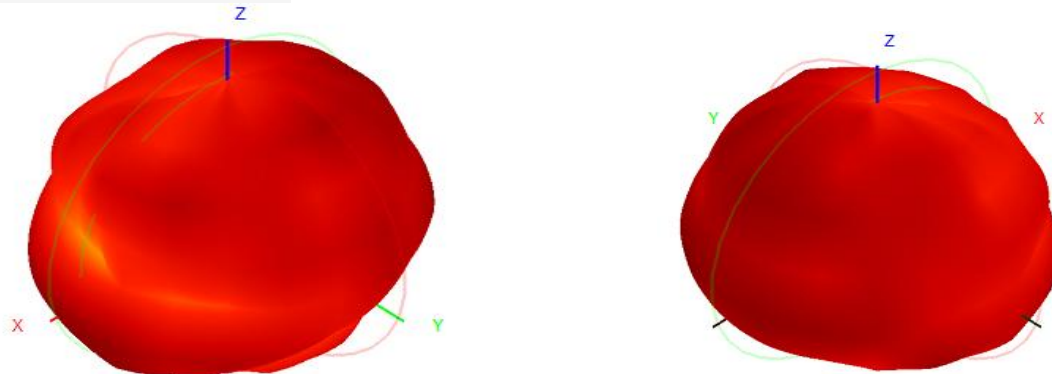

Shenzhen Aihui Technology Co. , Ltd.

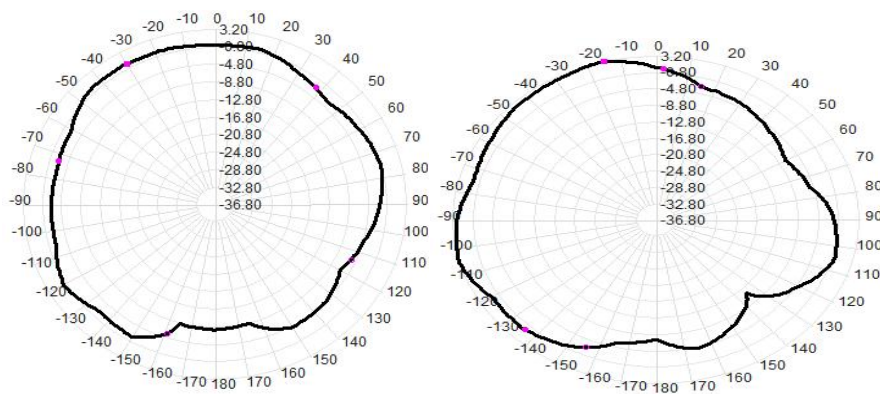
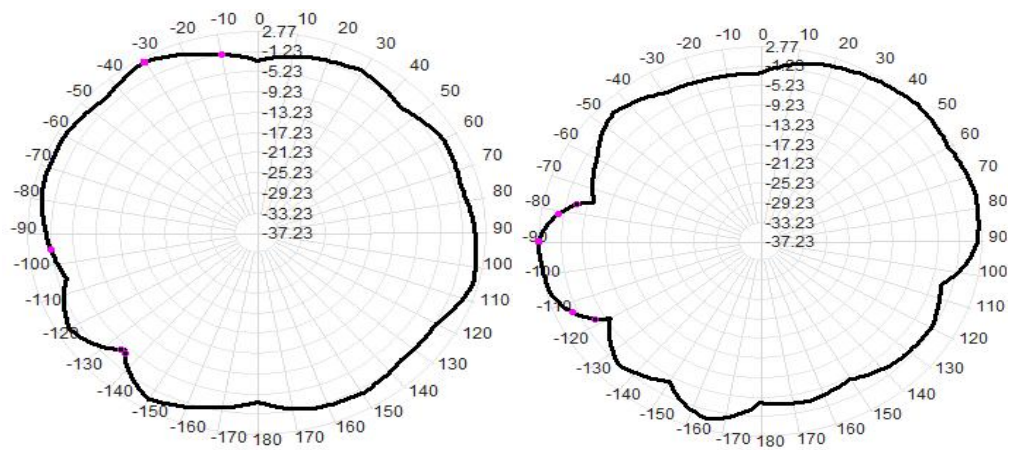

Address: 402TEL: 0755-23203435fax: 0755-23203435, Block C, Juxin Science and Technology Industrial Park, Nanchang community, xixiang, Baoan District, Shenzhen

5.2 wifi measurements

距离路由器10米，信号满格。
实测效果为；
2.4G -43.0s
5.8G -52.0s

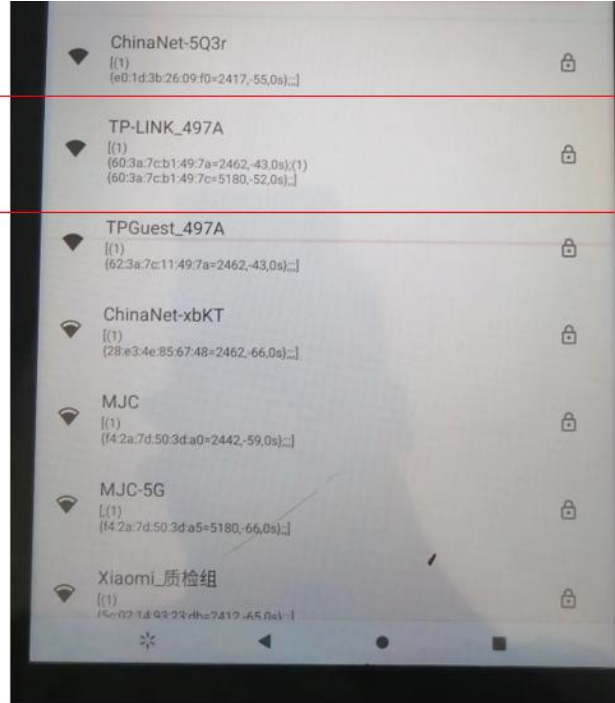

6.The panel matches the change schematic

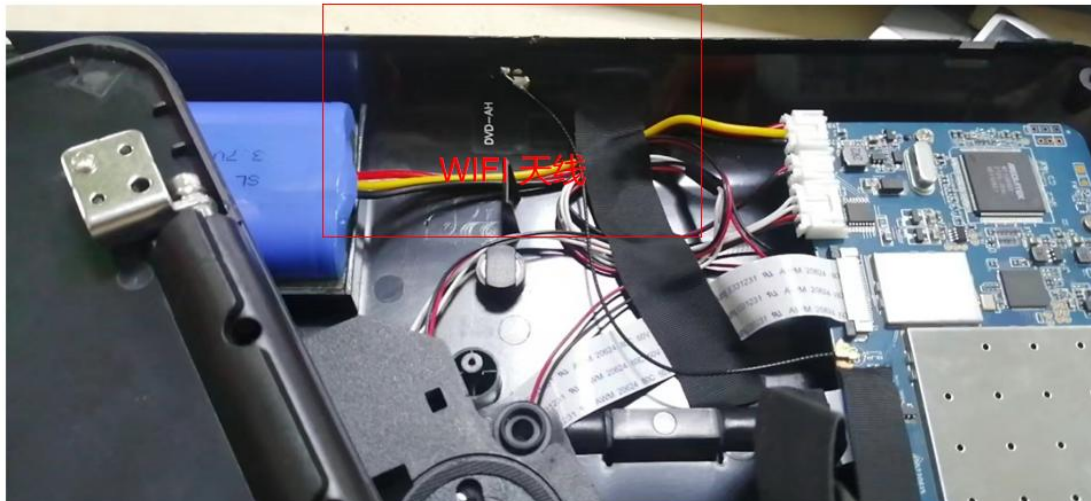

7. Antenna environment handling

The original environment, we do not do processing

8. Antenna mass production index

When the antenna is mass-produced, the standing wave ratio is taken as the mass-produced test standard.

Based on the differences of the project itself, the following criteria are given:

Frequency	Standard for volume production
2400 MHz -2500MHz 5100MHz-5850MHz	VSWR (Mass Production performance) & LT; VSWR(recognition performance) 0.5

Shenzhen Aihui Technology Co. , Ltd.

5100 MHZ -5800MHZ	VSWR (Mass Production performance) & LT; VSWR(recognition performance) 0.5
-------------------	---

9.Structural drawings

1	2	3	4	5	6	7	8																																																																								
A							A																																																																								
B	<p>Note 1 hit * as the key detection size, hole size to match as true. 2 unmarked fillet r = 0.30 mm, it is better to achieve the middle size in the drawing, other unmarked tolerances refer to the description in the drawing frame. 3. The material is electrolytic copper + Pi (half to half) , the whole thickness is less than 0.10 MM (not including 3m glue) . Four. Surface Black, back of the whole 3m 300lse adhesive. 5. Cross section section for Copper Line, part of the green diagonal section of copper, leaving the base material, play a connecting role. The overall shape follows the profile profile. 6. Do not scratch the surface of copper, poor plating, oxidation, notch, indentation, bubbles, tapered, burrs; and do not allow foreign body, dirty spots, deflection and other phenomena. Seven. Reference engineering seal sample. 8. Note the terminal port orientation.</p>						B																																																																								
C	<table border="1" style="width: 100%; border-collapse: collapse;"> <thead> <tr> <th colspan="2" style="text-align: left;">Material description</th> <th colspan="6" style="text-align: left;">Shenzhen Aihui Technology Co. , Ltd.</th> </tr> </thead> <tbody> <tr> <td style="text-align: center;">①</td> <td>FPC antenna</td> <td style="text-align: center;">Φ</td> <td>Type</td> <td>10988</td> <td>Date</td> <td colspan="2">2023/07/12</td> </tr> <tr> <td style="text-align: center;">②</td> <td>Coaxial line something 0.81(Black)</td> <td style="text-align: center;">○</td> <td>0.02</td> <td>Brand name</td> <td colspan="3">SEANZHANG</td> </tr> <tr> <td style="text-align: center;">③</td> <td>IPEN connector (Generation 4)</td> <td style="text-align: center;">⊗</td> <td>∅0.03</td> <td>Material</td> <td>DVD-AH</td> <td colspan="2">structure</td> </tr> <tr> <td style="text-align: center;">④</td> <td></td> <td style="text-align: center;">┴</td> <td>0.02</td> <td>Material number</td> <td>FPC</td> <td colspan="2">radio frequency</td> </tr> <tr> <td></td> <td></td> <td style="text-align: center;">≡</td> <td>0.04</td> <td>Material position</td> <td></td> <td colspan="2"></td> </tr> <tr> <td></td> <td></td> <td style="text-align: center;">∟</td> <td>0.02</td> <td>Die Treatment</td> <td>Confirm</td> <td colspan="2"></td> </tr> <tr> <td></td> <td></td> <td></td> <td>Appearance treatment</td> <td>Unit</td> <td>mfr</td> <td>approval</td> <td>FIT</td> </tr> <tr> <td></td> <td></td> <td></td> <td></td> <td>Version</td> <td>R: A</td> <td colspan="2"></td> </tr> </tbody> </table>						Material description		Shenzhen Aihui Technology Co. , Ltd.						①	FPC antenna	Φ	Type	10988	Date	2023/07/12		②	Coaxial line something 0.81(Black)	○	0.02	Brand name	SEANZHANG			③	IPEN connector (Generation 4)	⊗	∅0.03	Material	DVD-AH	structure		④		┴	0.02	Material number	FPC	radio frequency				≡	0.04	Material position						∟	0.02	Die Treatment	Confirm						Appearance treatment	Unit	mfr	approval	FIT					Version	R: A			C
Material description		Shenzhen Aihui Technology Co. , Ltd.																																																																													
①	FPC antenna	Φ	Type	10988	Date	2023/07/12																																																																									
②	Coaxial line something 0.81(Black)	○	0.02	Brand name	SEANZHANG																																																																										
③	IPEN connector (Generation 4)	⊗	∅0.03	Material	DVD-AH	structure																																																																									
④		┴	0.02	Material number	FPC	radio frequency																																																																									
		≡	0.04	Material position																																																																											
		∟	0.02	Die Treatment	Confirm																																																																										
			Appearance treatment	Unit	mfr	approval	FIT																																																																								
				Version	R: A																																																																										
D	<table border="1" style="width: 100%; border-collapse: collapse;"> <thead> <tr> <th colspan="2" style="text-align: left;">Material description</th> <th colspan="6" style="text-align: left;">Shenzhen Aihui Technology Co. , Ltd.</th> </tr> </thead> <tbody> <tr> <td style="text-align: center;">①</td> <td>FPC antenna</td> <td style="text-align: center;">Φ</td> <td>Type</td> <td>10988</td> <td>Date</td> <td colspan="2">2023/07/12</td> </tr> <tr> <td style="text-align: center;">②</td> <td>Coaxial line something 0.81(Black)</td> <td style="text-align: center;">○</td> <td>0.02</td> <td>Brand name</td> <td colspan="3">SEANZHANG</td> </tr> <tr> <td style="text-align: center;">③</td> <td>IPEN connector (Generation 4)</td> <td style="text-align: center;">⊗</td> <td>∅0.03</td> <td>Material</td> <td>DVD-AH</td> <td colspan="2">structure</td> </tr> <tr> <td style="text-align: center;">④</td> <td></td> <td style="text-align: center;">┴</td> <td>0.02</td> <td>Material number</td> <td>FPC</td> <td colspan="2">radio frequency</td> </tr> <tr> <td></td> <td></td> <td style="text-align: center;">≡</td> <td>0.04</td> <td>Material position</td> <td></td> <td colspan="2"></td> </tr> <tr> <td></td> <td></td> <td style="text-align: center;">∟</td> <td>0.02</td> <td>Die Treatment</td> <td>Confirm</td> <td colspan="2"></td> </tr> <tr> <td></td> <td></td> <td></td> <td>Appearance treatment</td> <td>Unit</td> <td>mfr</td> <td>approval</td> <td>FIT</td> </tr> <tr> <td></td> <td></td> <td></td> <td></td> <td>Version</td> <td>R: A</td> <td colspan="2"></td> </tr> </tbody> </table>						Material description		Shenzhen Aihui Technology Co. , Ltd.						①	FPC antenna	Φ	Type	10988	Date	2023/07/12		②	Coaxial line something 0.81(Black)	○	0.02	Brand name	SEANZHANG			③	IPEN connector (Generation 4)	⊗	∅0.03	Material	DVD-AH	structure		④		┴	0.02	Material number	FPC	radio frequency				≡	0.04	Material position						∟	0.02	Die Treatment	Confirm						Appearance treatment	Unit	mfr	approval	FIT					Version	R: A			D
Material description		Shenzhen Aihui Technology Co. , Ltd.																																																																													
①	FPC antenna	Φ	Type	10988	Date	2023/07/12																																																																									
②	Coaxial line something 0.81(Black)	○	0.02	Brand name	SEANZHANG																																																																										
③	IPEN connector (Generation 4)	⊗	∅0.03	Material	DVD-AH	structure																																																																									
④		┴	0.02	Material number	FPC	radio frequency																																																																									
		≡	0.04	Material position																																																																											
		∟	0.02	Die Treatment	Confirm																																																																										
			Appearance treatment	Unit	mfr	approval	FIT																																																																								
				Version	R: A																																																																										
1	2	3	4	5	6	7	8																																																																								

Address: 402TEL: 0755-23203435fax: 0755-23203435, Block C, Juxin Science and Technology Industrial Park, Nanchang community, xixiang, Baoan District, Shenzhen