

K3 投影仪说明书

说明书尺寸：110*140MM

说明书材质：封面157g，内页128g 铜板纸

彩色印刷

封二封三留白



HOME THEATER PROJECTOR

K3 USER MANUAL



REV1.0

Content

FCC WARNING STATEMENT	02
PACKING LIST	03
NOTICE	03
FUNCTION OVERVIEW	04
REMOTE CONTROL	05
QUICK START	06
PROJECTION DISTANCE & SIZE	07
PROJECTION MODE	07
INPUT SOURCE	08
PICTURE AND SOUND SETTINGS	09
BLUETOOTH SETTING	11
PROJECTION SETTINGS	14
WIFI CONNECTION & SCREEN MIRRORING	17
CEILING INSTALLATION	21
SPECIFICATION	22
TROUBLE SHOOTING	23

FCC WARNING STATEMENT

FCC Statement

This device complies with part 15 of the FCC rules. Operation is subject to the following two conditions:

- (1) This device may not cause harmful interference.
- (2) This device must accept any interference received, including interference that may cause undesired operation.
- (3) The manufacturer is not responsible for any radio or tv interference caused by unauthorized modifications or changes to this equipment. Such modifications or changes could void the user's authority to operate the equipment.

NOTE:

This equipment has been tested and found to comply with the limits for a Class B digital device, pursuant to part 15 of the FCC Rules. These limits are designed to provide reasonable protection against harmful interference in a residential installation. This equipment generates, uses, and can radiate radio frequency energy and, if not installed and used in accordance with the instructions, may cause harmful interference to radio communications. However, there is no guarantee that interference will not occur in particular installation. If this equipment does cause harmful interference to radio or television reception, which can be determined by turning the equipment off and on, the user is encouraged to try to correct the interference by one or more of the following measures:

- Reorient or relocate the receiving antenna.
- Increase the separation between the equipment and receiver. Connect the equipment into an outlet on a circuit different from that to which the receiver is connected.
- Consult the dealer or an experienced radio/TV technician for help.

Warning:

The device has been evaluated to meet general RF exposure requirements.

RF Exposure Information:

This equipment complies with FCC radiation exposure limits set forth for an uncontrolled environment.

This equipment should be installed and operated with minimum distance 20cm between the radiator and your body.

PACKING LIST

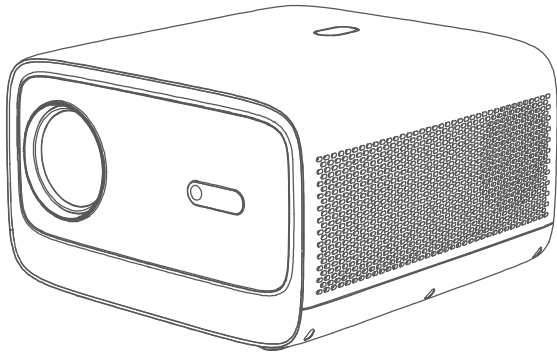

K3 Projector



Remote control



AAA Battery*2

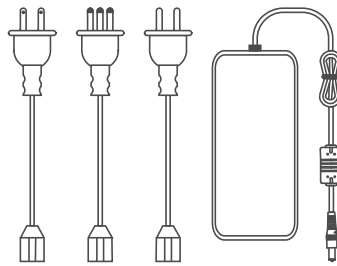

Power Cable



User Manual

NOTICE

 NOT Recommended

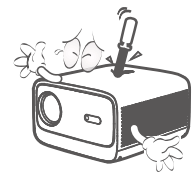
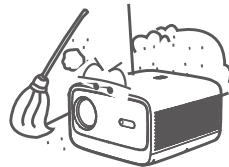
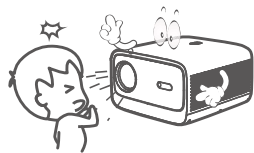
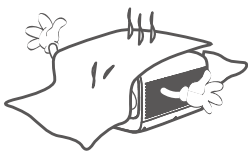
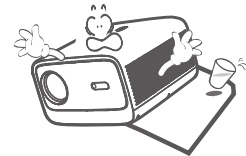
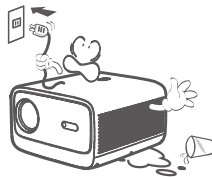
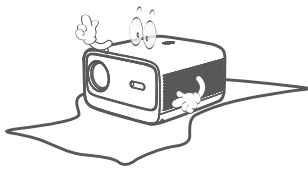

FUNCTION OVERVIEW

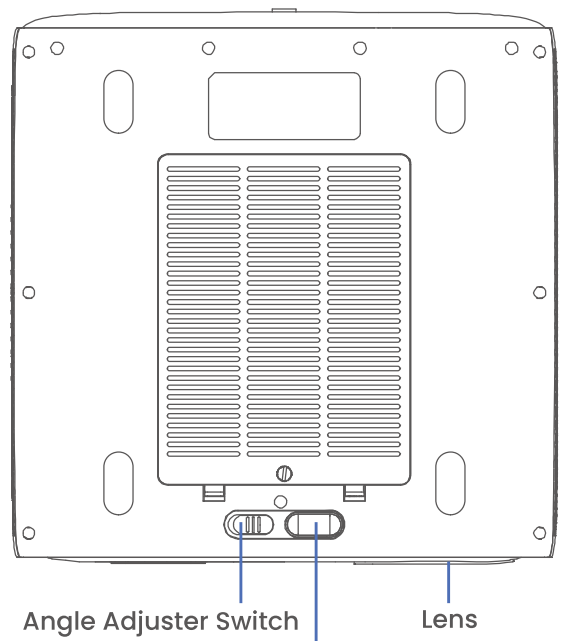
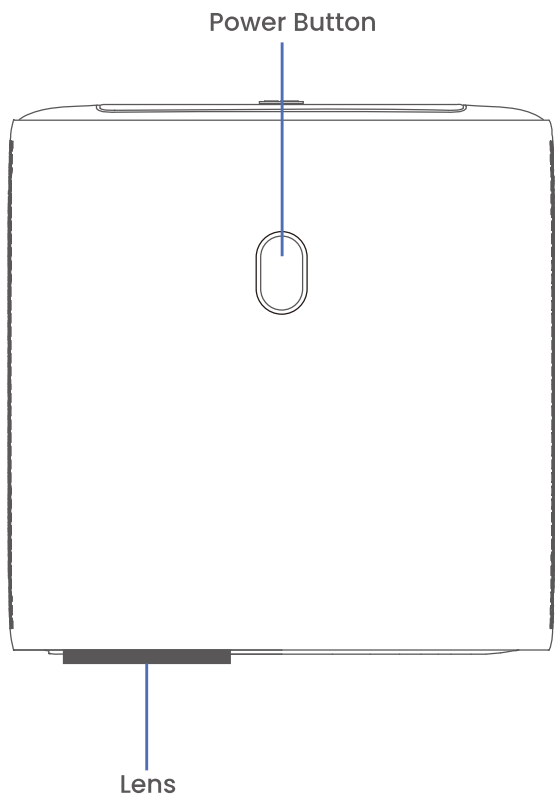
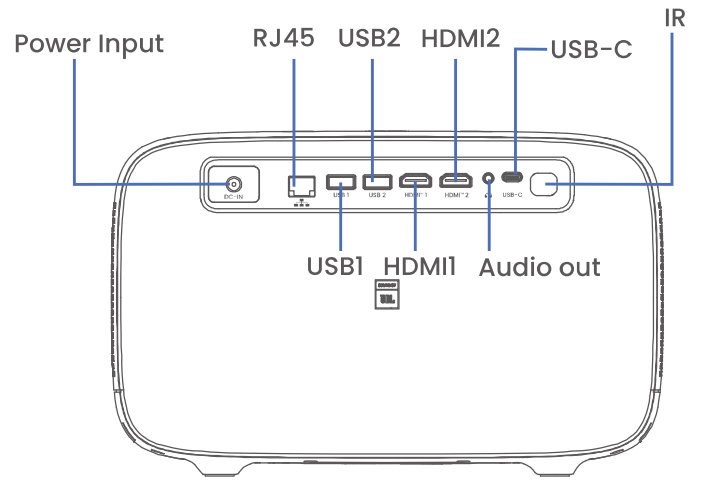
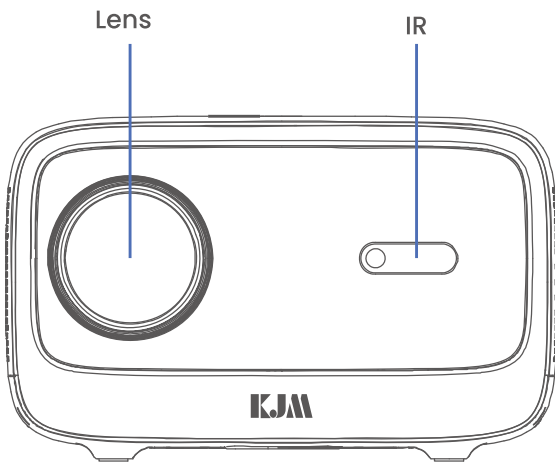

Angle Adjuster

Adjust the angle adjuster to fine-tune the display angle to a higher position

REMOTE CONTROL

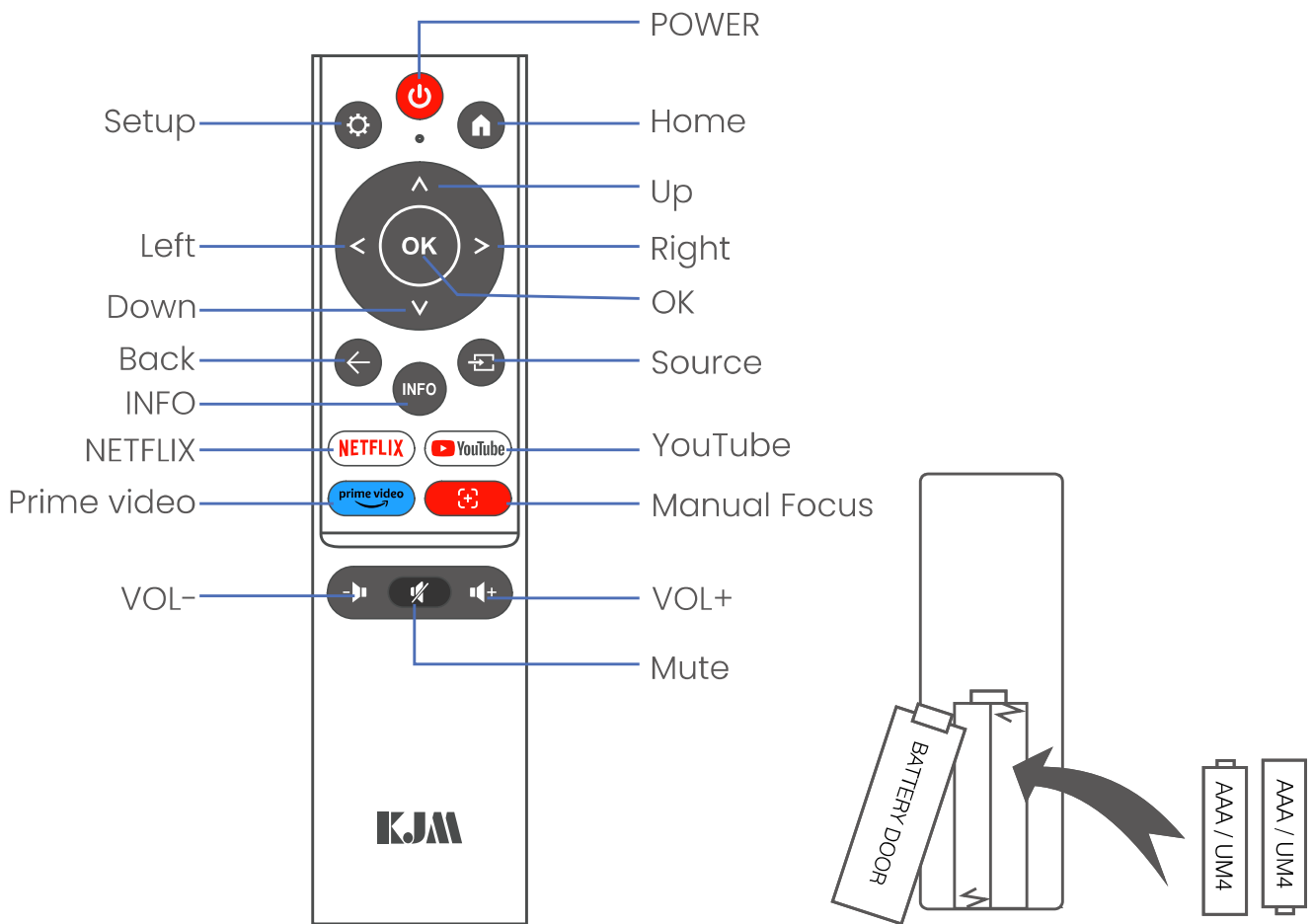

BATTERIES STATEMENT AND NOTICES

Remove the battery compartment cover on the back of your remote by carefully sliding to open. The battery cover can then be lifted away. Fit the correct batteries, referring to the polarity markings. Finally, replace the cover.

NOTE:

- When you receive the product and find that the batteries of the remote control is swollen or softened, please do not use it before you change it.
- Batteries shall not be exposed to excessive heat such as sunshine, fire.
- Make sure that the batteries are installed polarity correctly.
- Only same or equivalent type batteries as recommend are to be used.
- Do not dispose of batteries in fire, battery may explode or leak. Do not try to recharge a battery.
- Do not mix old and new batteries.
- Do not mix alkaline, standard(carbon-zinc), or rechargeable (ni-cad,ni-mh,etc) batteries.

QUICK START

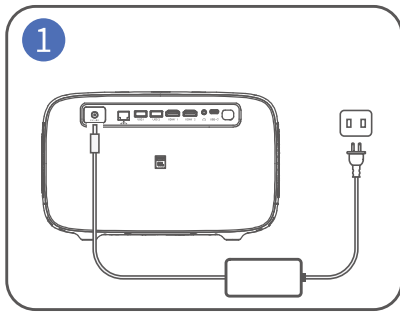

① Plug the power cord into an outlet

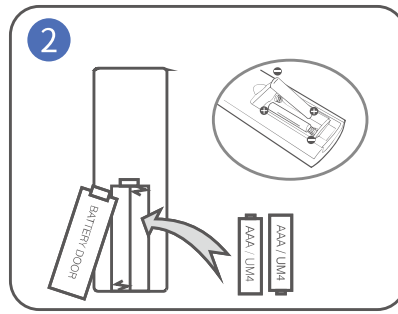

② Install batteries in the remote control

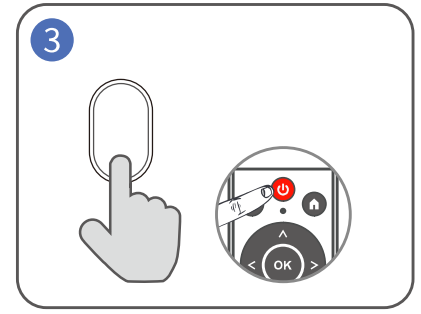

③ Turn on
Press the Power Button to turn on the projector

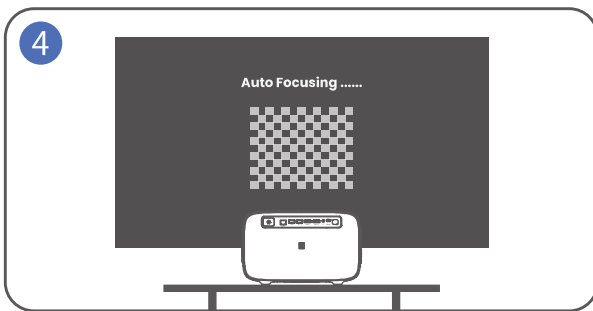

④ Automatically focus to adjust the picture clearer

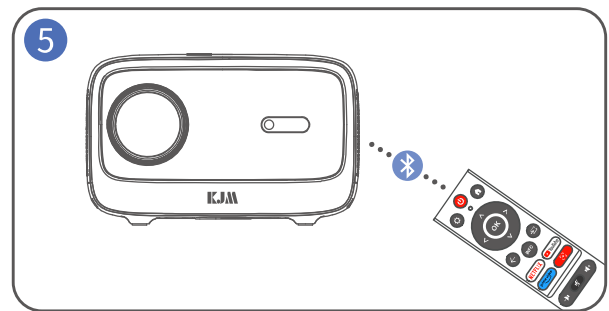

⑤ Connect your remote control to the projector via Bluetooth

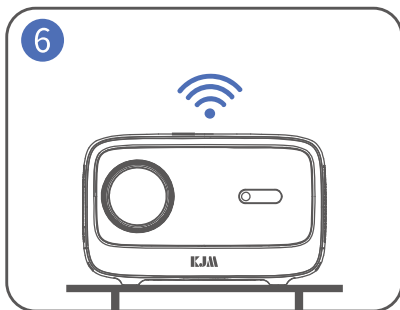

⑥ Connect to the Network



⑦ Back to "home" interface, select the video platform you want to log in

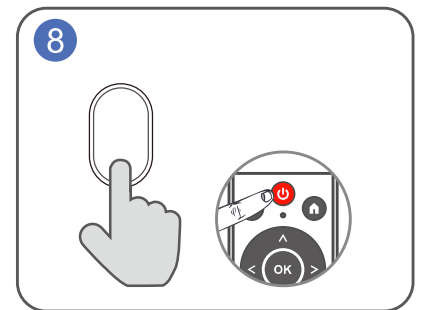

⑧ Turn off
Press the Power Button and choose **Yes** to turn off the projector

Tips:

1. To prolong the lifespan of the projector, we highly recommended unplug the power cable completely after each use, especially during a long time of no use.
2. After the projector is plugged into the power supply, it takes 10 seconds for the system to detect power on, so please wait for 10 seconds before pressing power to turn it on.
3. The bottom of the machine is the air inlet, please do not place the machine on items such as towels.

PROJECTION DISTANCE & SIZE

The recommended projection screen is around 100-120 inches with a distance of around 9.7-11.5ft.

To improve the clarity of your projected images, it is recommended to create ambient darkness and use a high-quality project screen. These factors work together to provide a visually stunning and immersive viewing experience.

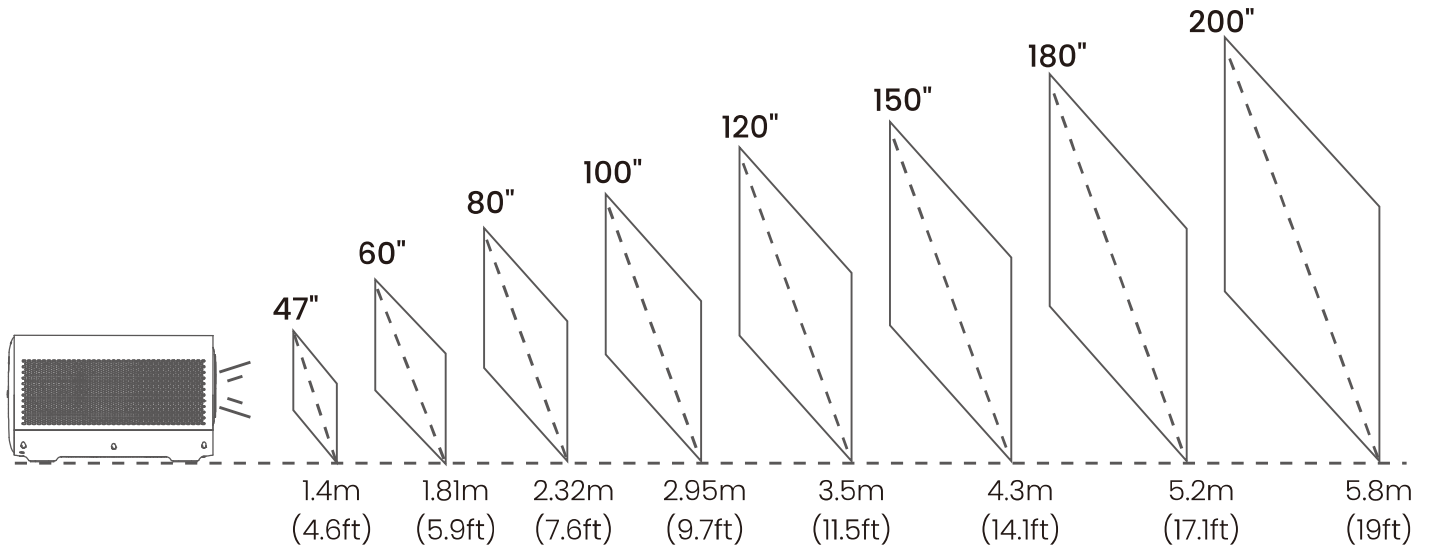

PROJECTION MODE

If you want to hang the projector to the ceiling, a projector mount will be needed.

If you want to project in different way, please select corresponding mode in the setting page.



FRONT TABLE

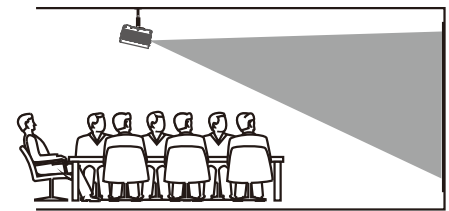

FRONT CEILING

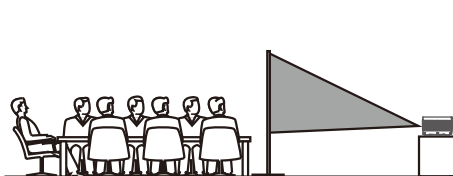

REAR TABLE

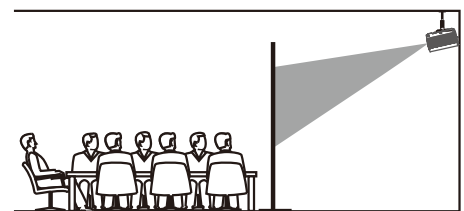

REAR CEILING

INPUT SOURCE

Press  on the remote to enter the interface of the Input Source.

A. HDMI Connection

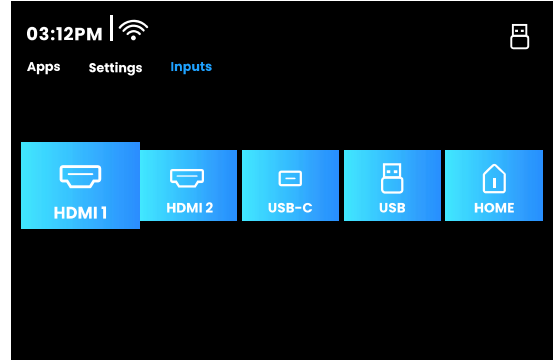
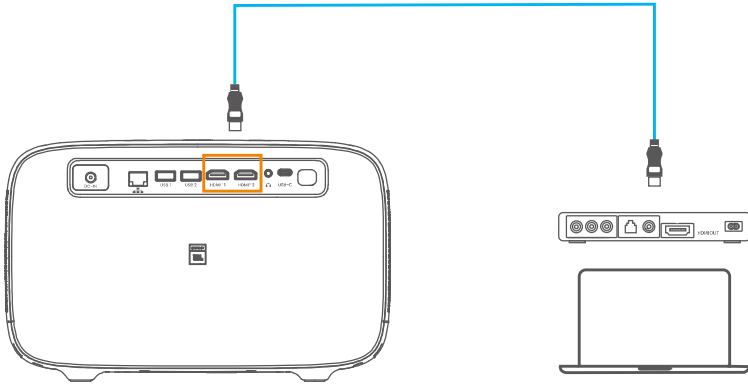

B. USB Connection

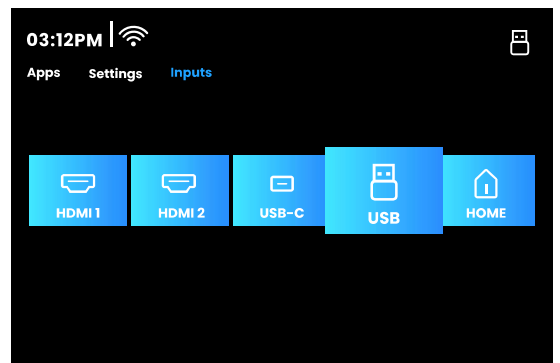
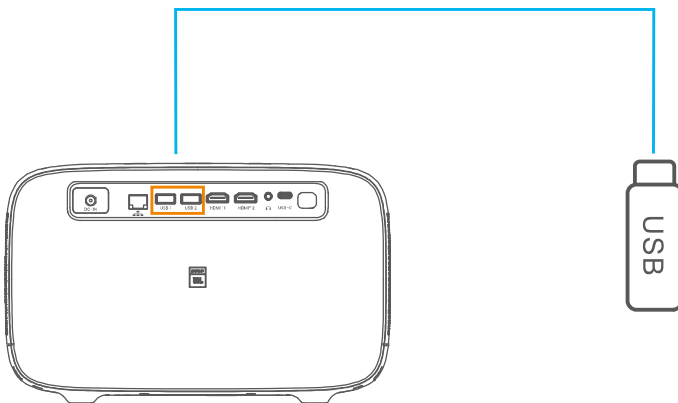

PICTURE AND SOUND SETTINGS

A. Picture Settings:

Go to **Settings** > **Picture Mode**

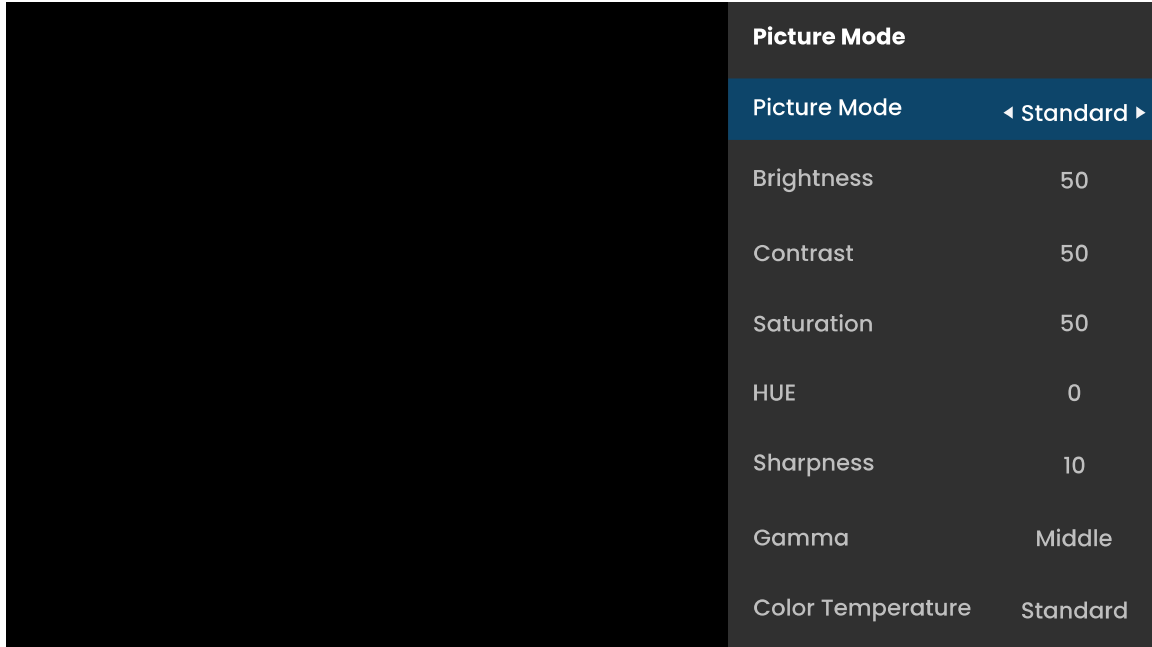

Picture Mode	Standard/Custom/Cinema/Sport/Vivid/Hi-Bright
Brightness	0~100
Contrast	0~100
Saturation	0~100
HUE	-50~50
Sharpness	0~20
Gamma	Middle/Bright/Dark
Color Temperature	User/Cool/Standard/Warm

B. Sound Settings:

Go to **Settings** > **Audio**

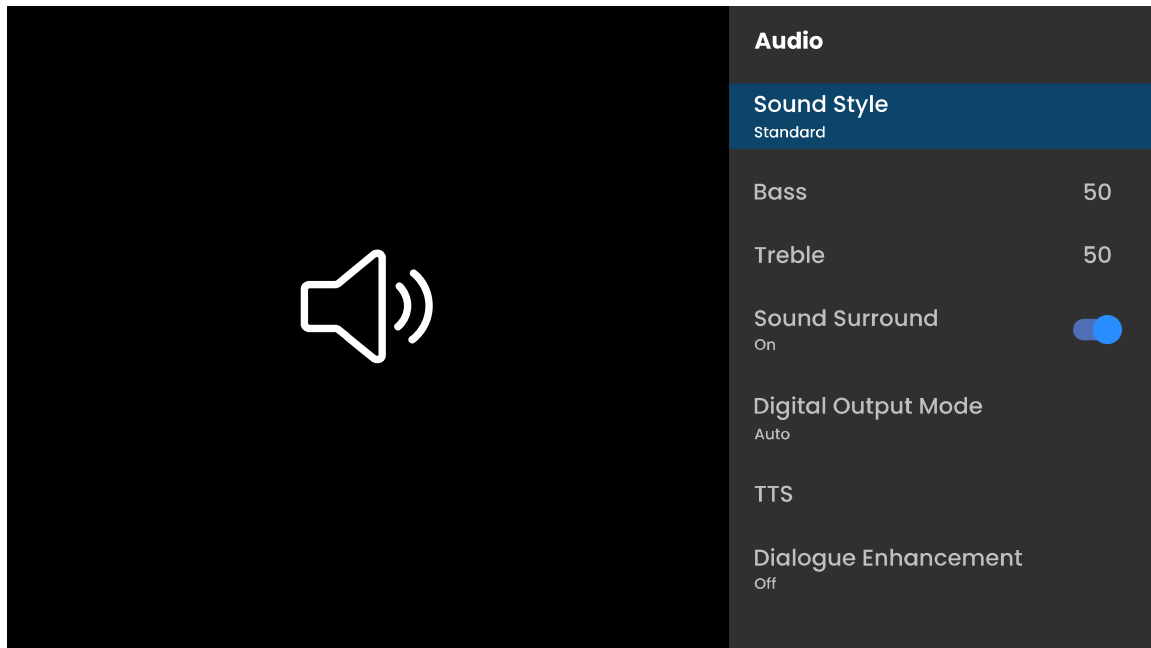

Sound Mode	User / Standard / Vivid / Sport / Movie / Music / News
Bass	0~100
Treble	0~100
Sound Surround	on/off
Digital Output Mode	Auto/PCM/Dolby Digital/Dolby Digital Plus
TTS	Voice Broadcast
Dialogue Enhancement	Off / Low / Medium / High

BLUETOOTH SETTING

A. Bluetooth Setting

1. Go to **Settings** > **Bluetooth**
2. Turn the Bluetooth Connection on and search for nearby Bluetooth devices.
3. Choose correct Bluetooth device to connect.

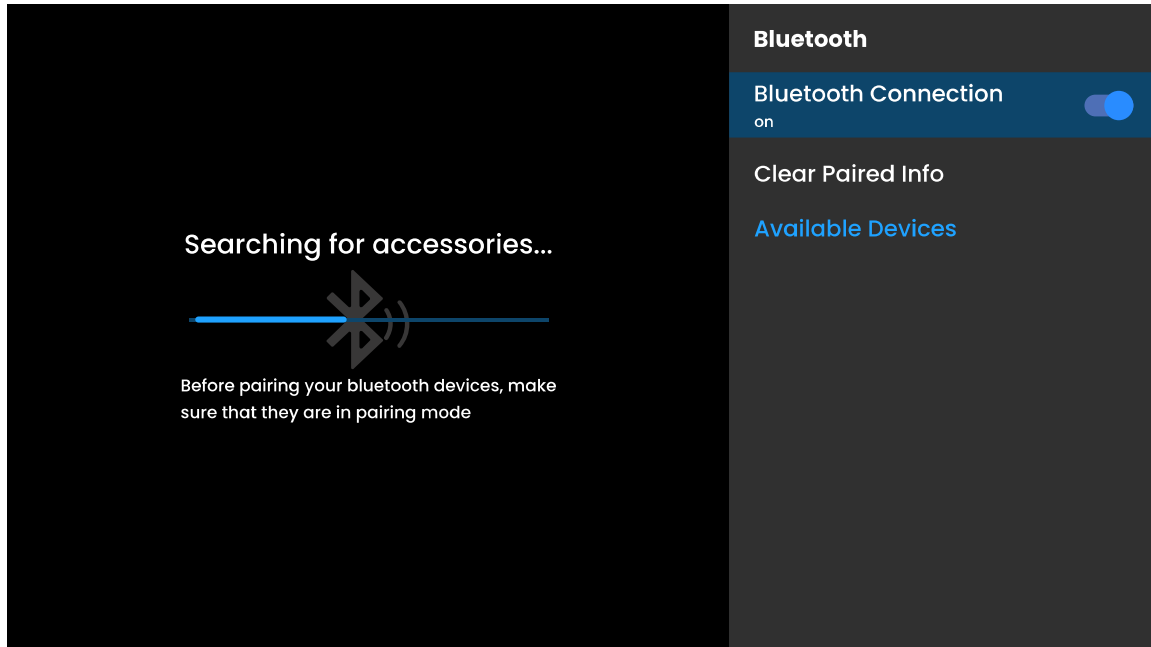

NOTE:

1. Due to compatibility issues with the Bluetooth protocol, some brands of Bluetooth speakers may not support connection to KJM projectors. If you have such an issue, feel free to let us know.
2. If you want to connect your headphone/ speaker to an audio port, please disconnect the Bluetooth audio device from the projector first.

B. Bluetooth Remote Control

1. For the first start of the projector, it will appear the following page to guide the Bluetooth remote control connecting.
2. Place the remote control close to the projector, press and hold the "LEFT" and "RIGHT" on remote control until indicator light flashes quickly.
3. After being connected, the operation of the remote control will be more sensitive and the coverage will be wider.

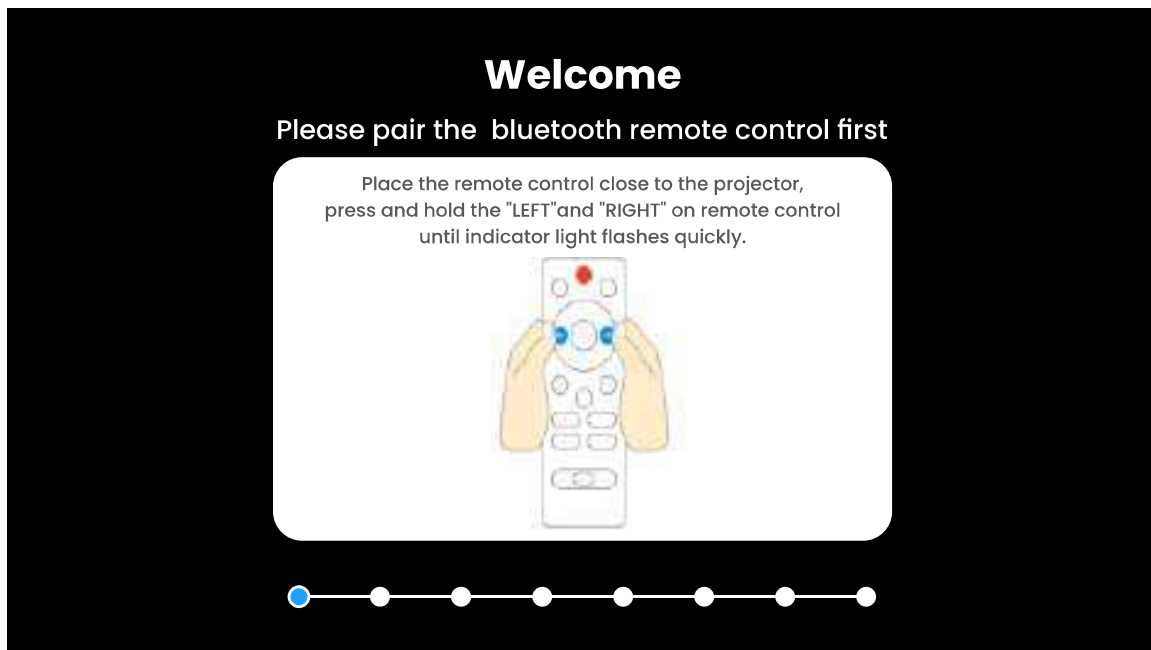

Two Working Modes of Remote:

1. **The Bluetooth control:** rare in the market, once connect the remote control to the projector via Bluetooth, it's no longer limited by the sensing area, which is more sensitive and convenient to use. (Recommend)
2. **Common IR sensing:** need to point at the IR window of the projector and operate within the IR sensing range.

Note:

- ① After the Bluetooth remote control is connected, the other Bluetooth audio devices can also be connected without conflict.
- ② Please keep the projector's Bluetooth ON to ensure the Bluetooth remote can connect and work as normal.

C. As A JBL Bluetooth Speaker

Press  button on remote control, select **Bluetooth Speaker** , and the projector can be used as a JBL Bluetooth speaker.

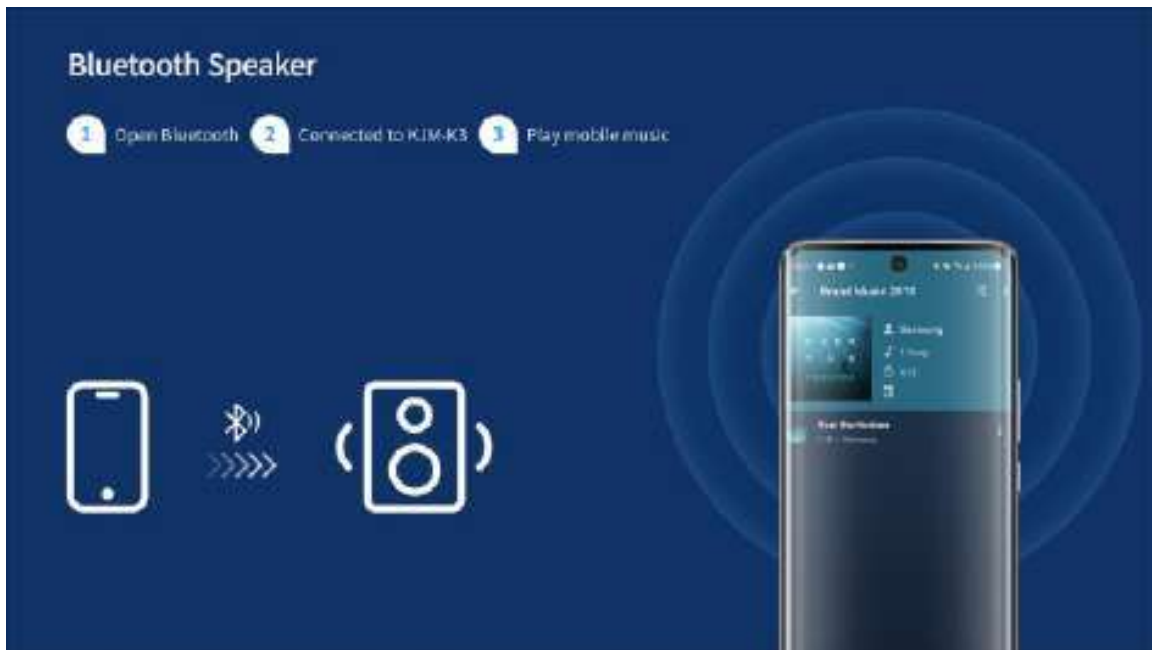
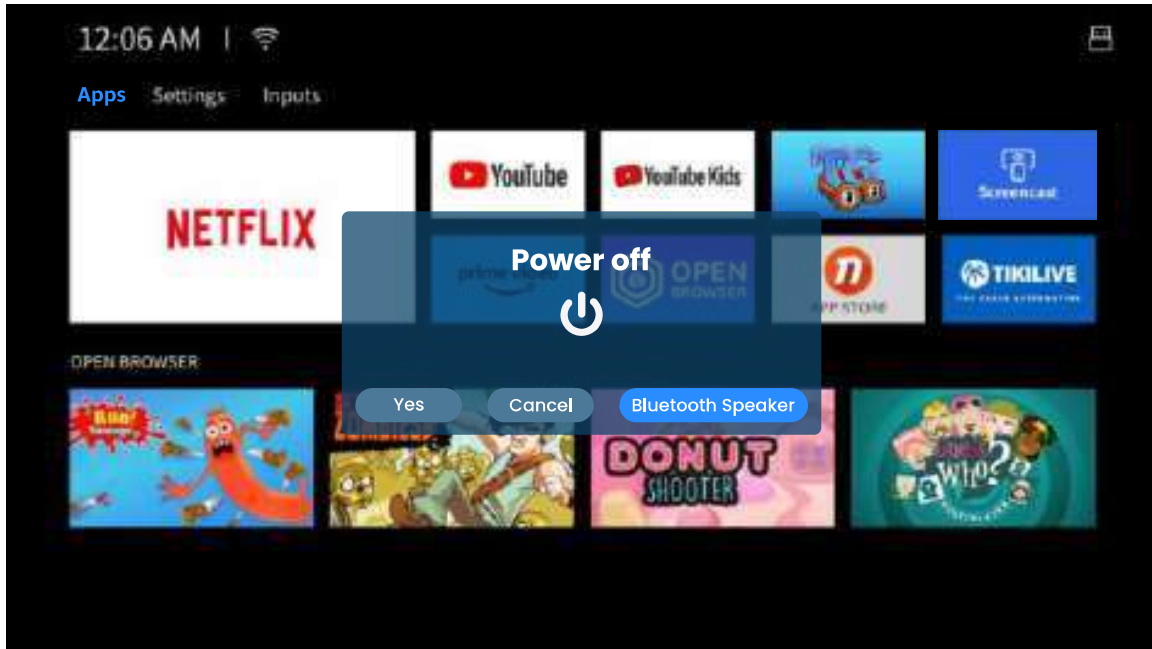

PROJECTION SETTINGS

A. Auto Focus

By default, the auto focus mode of the projector is enabled, allowing it to quickly detect and adjust to the optimal clarity of the screen when it is turned on.

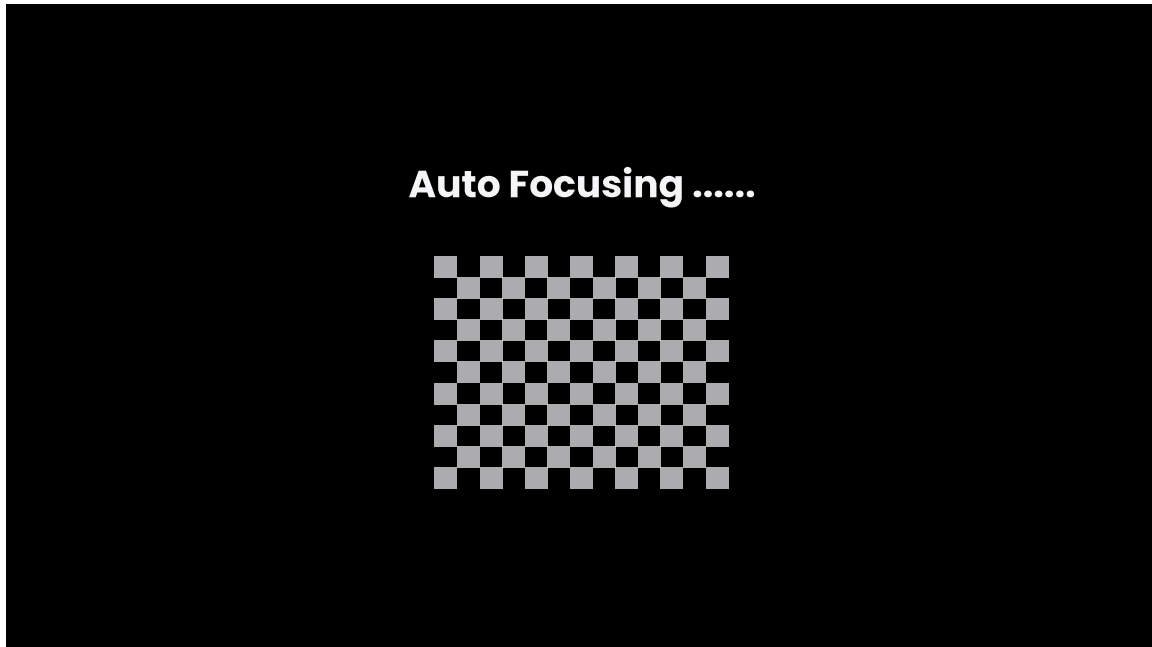

NOTE:

- ① Go to **Settings** > **Projection Settings**, you can turn off/on the auto focus function.
- ② Even after the projector has completed its autofocus, you can still manually focus to refine the picture clarity to your preferences. This gives you complete control over the image quality, ensuring that it meets your exact standards.

B. Manual Focus

1. Press  button on the remote.
2. Press **Down button** ∇ and **Up button** \blacktriangle to adjust the picture clarity.

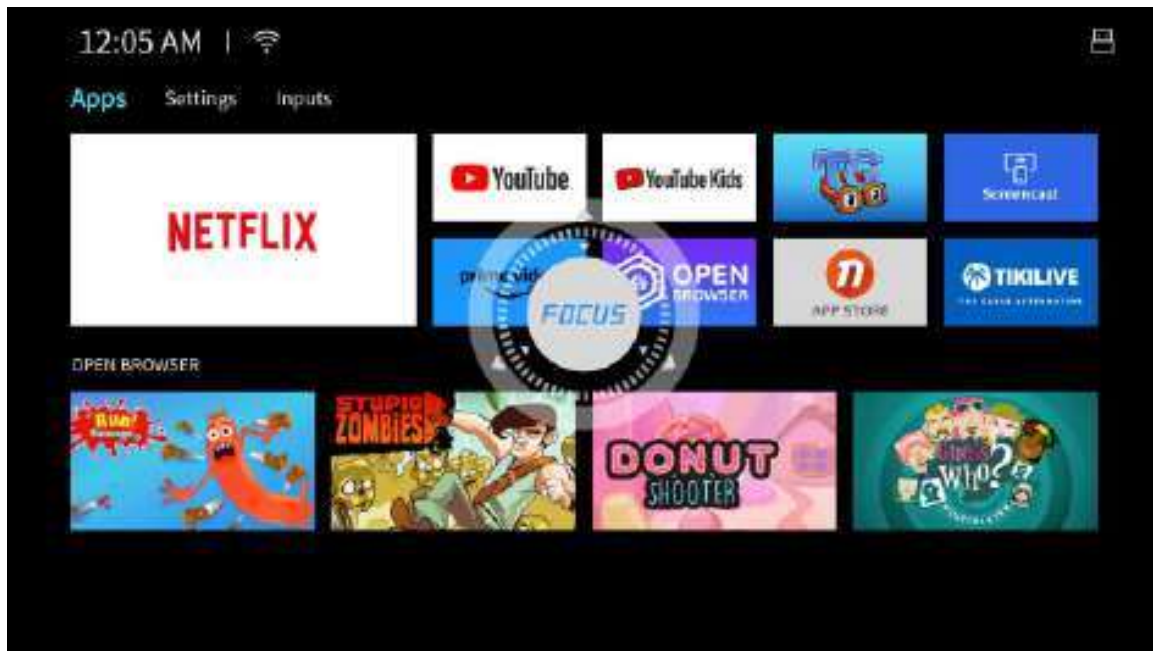

C. 4 Points Keystone

1. Go to **Settings** > **Projection Settings**
2. Choose **Four Points Correction**
3. Press **Direction Buttons**  to adjust the position, Press "OK" button to jump to the next corner adjustment, and when the circle in the center is a perfect circle, the screen ratio conforms to the system settings.

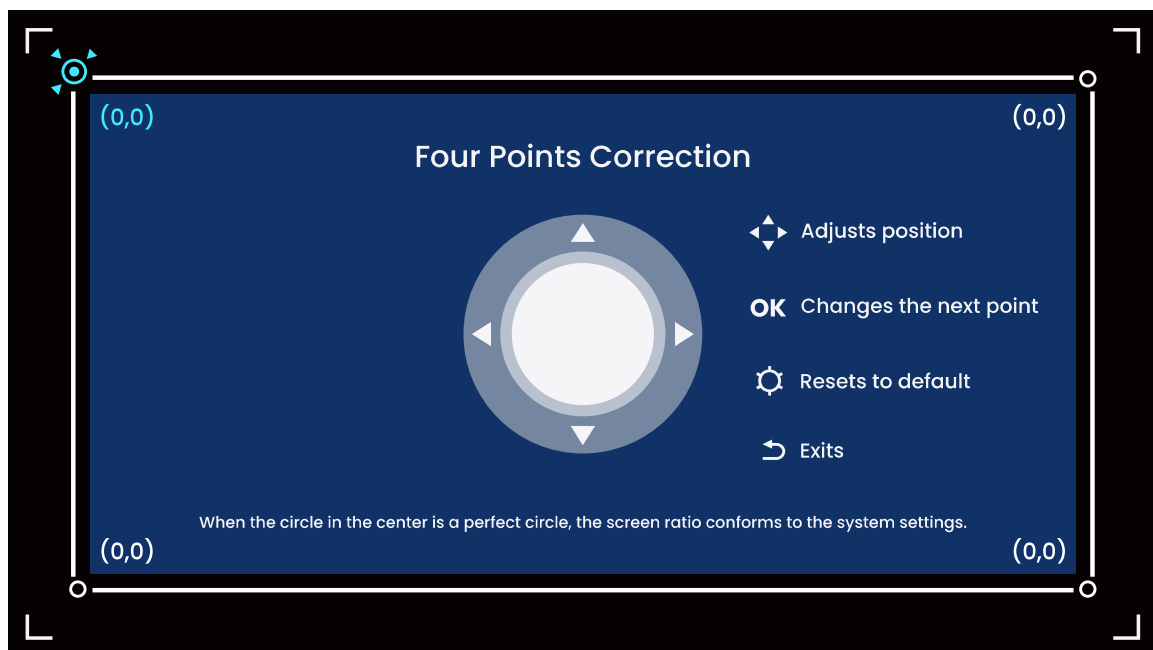

D. 4 Sides Correction

1. Go to **Settings** > **Projection Settings**
2. Choose **Four Sides Correction**
3. Press **Direction Buttons**  to adjust the position, when the circle in the center is a perfect circle, the screen ratio conforms to the system settings.

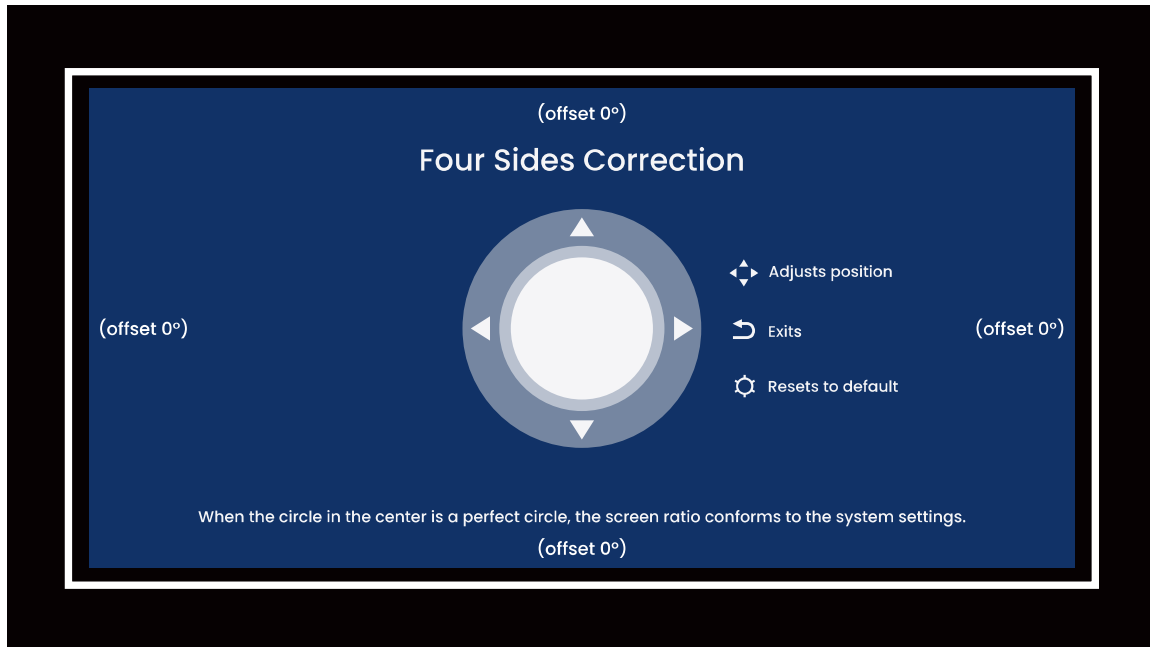

E. Digital Zoom

1. Go to **Settings** > **Projection Settings**
2. Choose **Zoom**
3. Press **Down button** ∇ to Zoom out (100%-70%) and **Up button** \blacktriangle to Zoom in (70%-100%).

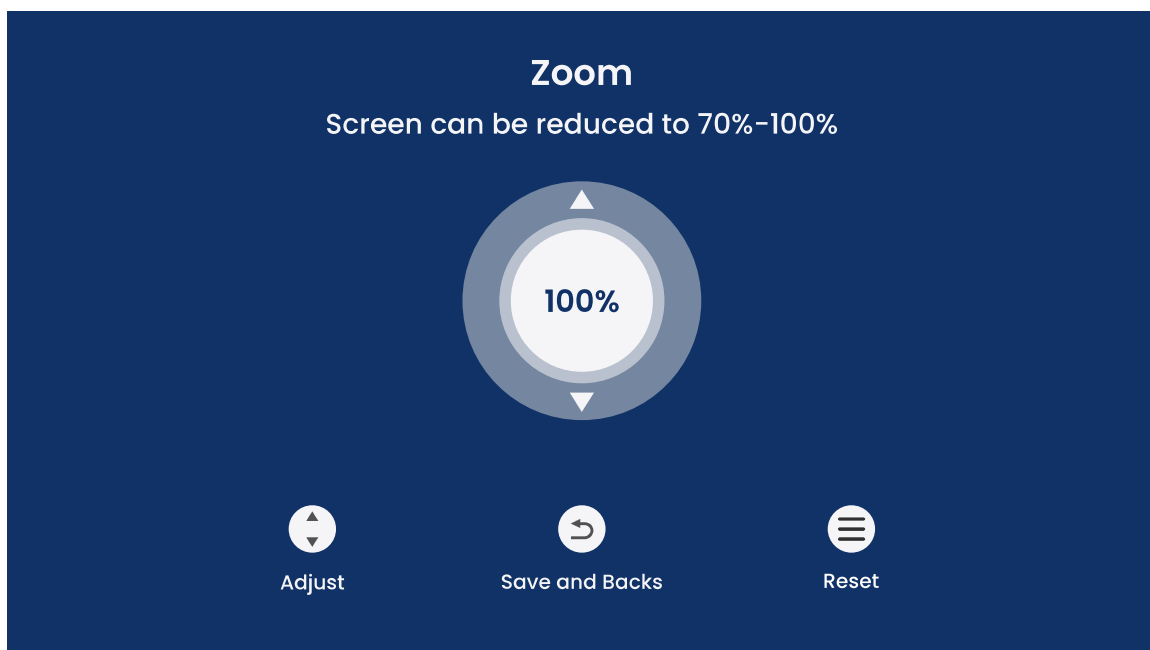

WIFI CONNECTION & SCREEN MIRRORING

Wi-Fi Connection

1. Go to **Settings** > **Network** > **Wi-Fi**
2. Scan and Choose your Wi-Fi, then enter password to connect.

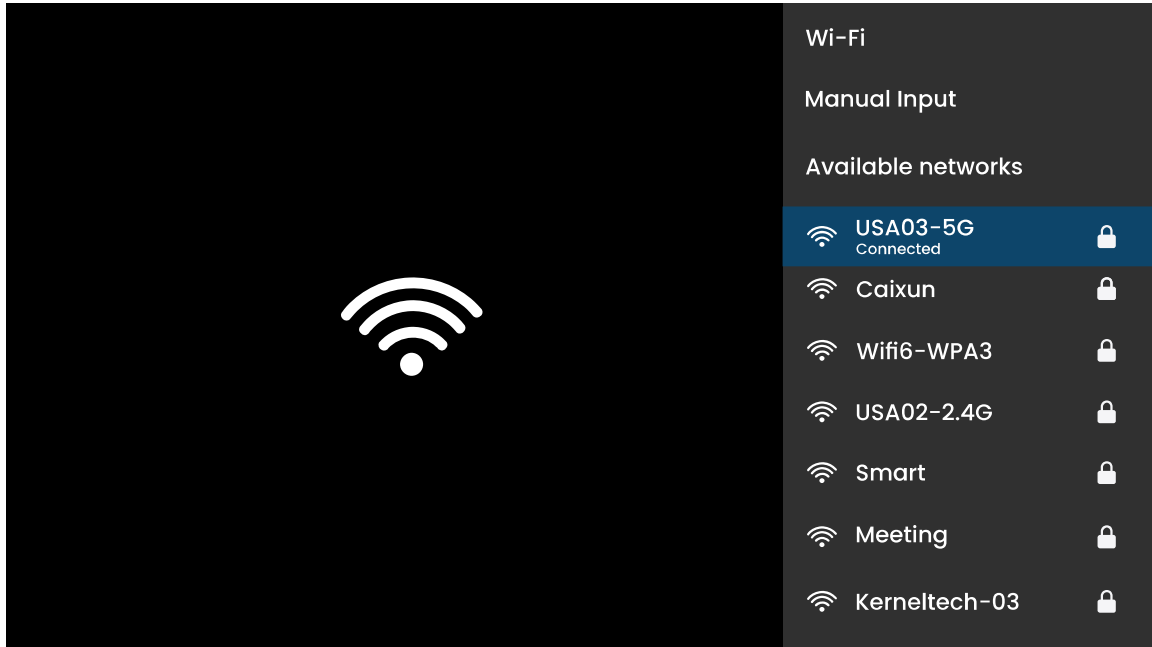

SCREENCAST(for Android and Windows System)

1. Go to **Home** > **ScreenCast**
2. On your Android device launch the Multiscreen /Wireless Display/Screen Mirroring/Smart View Function.
3. Looking for device that can be mirrored on.
4. Select "KJM-K3" from the list to connect.

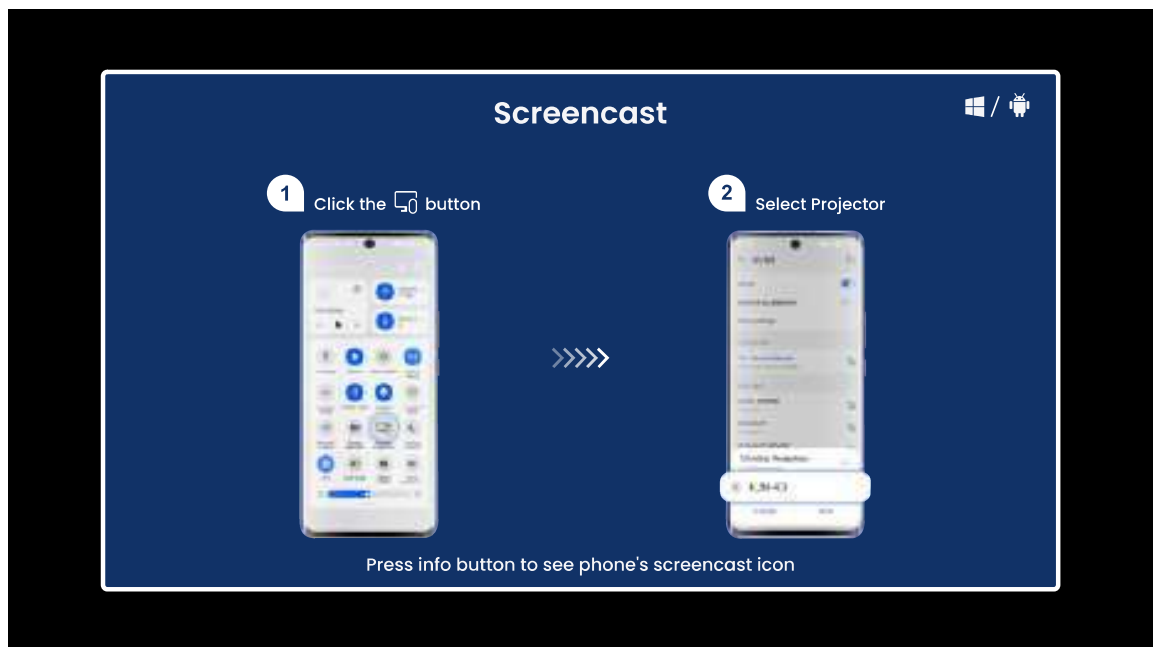
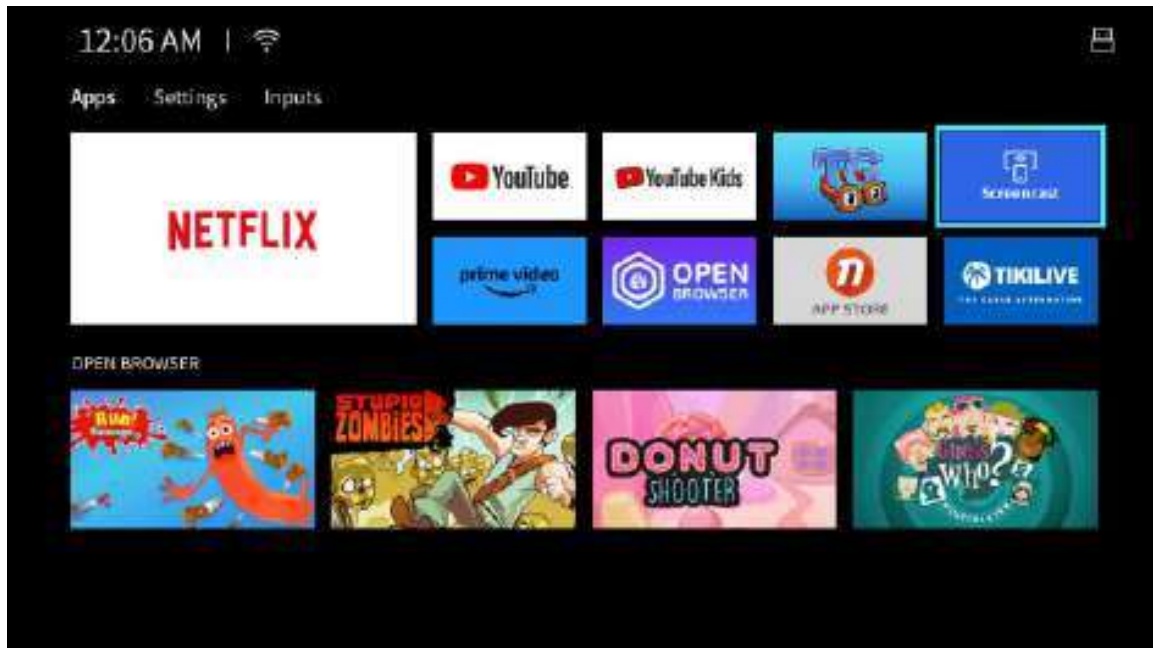

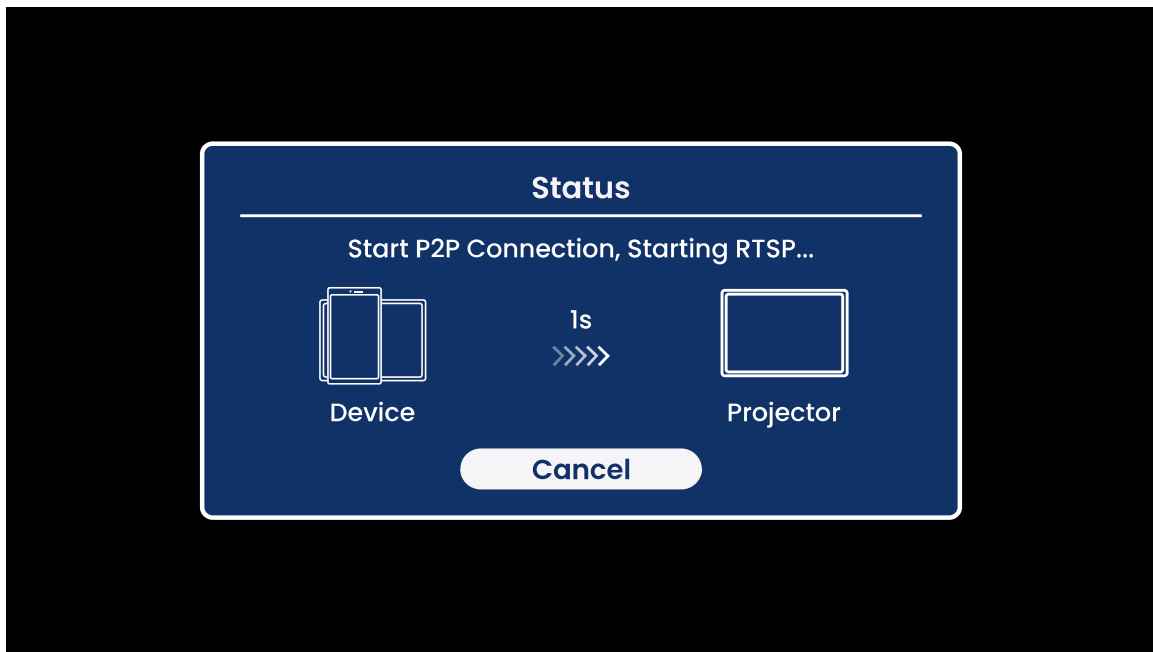

NOTE:

1. For your Android device, please ensure that the Wi-Fi function is turned on, but it is not necessary to connect to any Wi-Fi router. However, for a Windows system, you will need to connect to a Wi-Fi network.
2. When you disconnect Screencast, please manually reconnect the Wi-Fi in the projector settings, or wait 1-2 minutes to let the projector automatically restore the Wi-Fi connection.

DLNA (for Android and iOS Device)

1. Make sure that your device is connected to the same network as your projector.
2. Open your video player software.
3. Click the  icon and select the projector name to connect.



NOTE:

1. The DLNA connection can be operated on any page of the projector.
2. Make sure that your device is connected to the same network as your projector.
3. After being connected via DLNA, the phone can continue to use as normal, the projected video will keep playing while the mobile phone interface will not be shown synchronously.
4. The DLNA connection only supports the built-in APP application of the projector.
5. Some streaming videos cannot be screen-casting due to copyright restrictions, which has nothing to do with the projector itself.

CEILING INSTALLATION

How to Mount a Projector on the Ceiling?

Mounting a projector on the ceiling is a great way to make your home theater or presentation space look professional and save valuable floor space. Follow these steps to mount your projector securely.

Tools you'll need	1. Mount	5. Screwdriver
	2. kit Ladder or step ladder	6. Tape measure
	3. Drill	7. Pencil (for marking)
	4. Wrench or Allen wrench (depending on the mount)	

Note: None of the above tools are included in the accessories, and you need to purchase a ceiling mounting bracket separately.

Step 1: Determine the position of your projector to the screen

Position your projector and screen so that the throw distance is sufficient for your needs. The lens should be between the upper third and upper half of the screen for optimal picture clarity. Mark the position with a pencil.

Note: Ensure there are no obstructions blocking the projector's beam, and that there is an available power socket nearby.

Step 2: Attach the mount to the projector

Flip the projector upside down and attach the mounting bracket according to the instructions included with the mount.

Step 3: Attach the mount and projector to the ceiling

Ensure the mounting bracket can attach along a ceiling joist, then make marks for screw holes and drill preliminary holes. Use suitable screws to securely fasten the bracket to the ceiling. Check that it is securely fastened to the ceiling by trying to wiggle it around.

Step 4: Aligning the projector

Adjust the zoom, focus, pitch, and yaw of the projector as necessary to ensure a properly aligned image with the screen.

Step 5: Connect Power

Please plug in the power cord to both the projector and a nearby power outlet. Once the connection is confirmed, turn on the projector to test the connection.

Step 6: Final adjustments

Make any final adjustments to the image and lock down the mount to prevent movement.

By following these steps, you can create a stunning and functional projection system.

SPECIFICATION

Display Technology	LCD
Light Source	LED
Resolution	1080P
Input Signal	HDMI / USB /USB-C
Aspect Ratio	16:9
Focus	AUTO/Manual
Keystone	AUTO + 4P/4D + Manual
Speaker	2*12W, JBL
Bluetooth	Version 5.0
Power Input	100-240V
Power Output	240W
Photo Format Supported	JPEG/PNG/BMP/GIF
Audio Format Supported	mp3/wav/asf/wmv/divx/mkv/3gp/mp4/mov/m4a/ts/trp tp/mpeg/mpg/vob/dat/mka/eac3/webm/ac4/mts/m2ts
Video Format Supported	mkv/webm/mp4/mov/3gp/ts/trp/tp/mpeg/mpg/vob dat/asf/wmv
Operating Temperature	0°C ~ 38°C / 32°F ~ 100.4°F
Storage Temperature	-20°C ~ 45°C / -4°F ~ 113°F
Temperature Protection	Over 80°C temp auto-shutdown
Ports	HDMI1 / HDMI2 / USB1 / USB2 / USB-C / RJ45 / 3.5mm Audio
Unit Dimension	28.2*28*16.9 cm
Unit Net Weight	4.08KG/9LB

TROUBLE SHOOTING



Remote control not work?

- Make sure the batteries are effective and installed in the correct way.
- Make sure the remote control has connected Bluetooth.

A



Blurry Image?

- Manual focus to get the best image.
- The quality of the projection screen will also affect the image quality. Recommended to use it on a white wall or a better quality screen. Not suggest to use it on a thin white gauze screen, which will reduce the image quality.

A



No Sound?

- The mute button on the remote was be pressed accidentally.

A



Automatic shut-down?

- Overheating protection. Please use in a ventilated environment.
- The bottom of the projector is the air inlet, please do not put the projector on the towel to use.
- It is recommended to unplug the power supply after use to prolong the service life.

A



Upside down image?

- Please enter "Projection Mode" to select the corresponding mode.

A



Video can not be mirrored or cast?

- Due to copyright restrictions, some videos cannot be mirrored or projected.
- The cast function only supports the built-in APP application of the projector.

A



Black spot on the screen?

- Wipe the lens with dry and clean cloth to remove dust on the lens.
- Slap the top, left, and right sides of the machine several times with a little force to remove the dust inside the lens.

A



Missing accessories?

- If the device is damaged or any accessories missing, please contact our after-sales department for help.

A



HOME THEATER PROJECTOR

K3 USER MANUAL

REV1.0