

# FANGOR

**F-802**

## SMART Wi-Fi LCD VIDEO PROJECTOR USER MANUAL

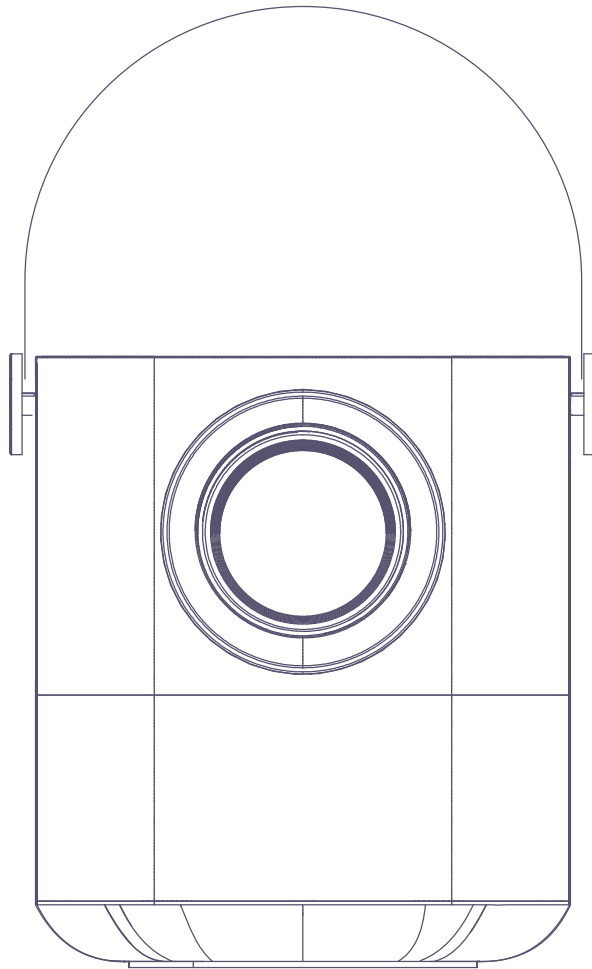

## ACTIVATE YOUR 12-MONTH WARRANTY & GET YOUR EXCLUSIVE GIFT

GET YOUR FREE GIFT AT:

✉ [us-projector@fangor.cn](mailto:us-projector@fangor.cn)



**NOTE**

1. Only suitable for home entertainment in a dark environment. NOT for presentation purposes.
2. The FANGOR F-802 Wi-Fi projector compatible with TV Stick, HDMI, USB, AV, Ps4/ (No Battery). It can also be Wireless Connection to Smartphone/ Pad, or Pairing to Bluetooth Wireless Speakers or SoundBar.
3. For Android phones, iPhones and iPads, in addition to using a wireless HDMI adapter to connect to the Fangor F-802 projector, you can also use a USB cable to connect to the projector's USB interface to achieve screen mirroring.

## A Big Thank You

We're thrilled that you have chosen to purchase the smart Wi-Fi F-802 projector. At FANGOR, we're committed to providing you with products that enhance your daily life. We also aim to give our customers excellent support. Should you have any questions or feedback about your new product, simply get in touch with our customer support team by email at

[us-projector@fangor.cn](mailto:us-projector@fangor.cn)

Enjoy your new product!

User Manual.....	English 1-30
取扱説明書.....	日本語 31-61

## CONTENTS

Accessory List.....	01
FCC Warning.....	02
Safety Notice.....	03
Functional Overview.....	04
IR Transmitter.....	05
Playing Your Projector.....	06
Placing Your Projector On Ceiling.....	07
User Manual.....	08
Menu option: Picture.....	24
Menu option: Sound.....	25
Menu option: Option.....	26
Menu option: Time.....	27
FAQ.....	28
Specifications.....	30

## **ACCESSORY LIST**

1 x Remote control (battery not included)

1 x HDMI cable

1 x Power Cable

1 x User manual

1 x Warranty card

## FCC Warning

This device complies with Part 15 of the FCC rules.

Operation is subject to the following two conditions:

- (1) This device may not cause harmful interference.
- (2) this device must accept any interference received, including interference that may cause undesired operation.

NOTE: This equipment has been tested and found to comply with the limits for a Class B digital device, pursuant to Part 15 of the FCC Rules. These limits are designed to provide reasonable protection against harmful interference in a residential installation. This equipment generates, uses, and can radiate radio frequency energy and, if not installed and used in accordance with the instructions, may cause harmful interference to radio communications. However, there is no guarantee that interference will not occur in a particular installation. If this equipment does cause harmful interference to radio or television reception, which can be determined by turning the equipment off and on, the user is encouraged to try to correct the interference by one or more of the following measures:

- Reorient or relocate the receiving antenna.
- Increase the separation between the equipment and receiver.
- Connect the equipment into an outlet on a circuit different from that to which the receiver is connected.
- Consult the dealer or an experienced radio/TV technician for help.

Warning: Changes or modifications to this unit not expressly approved by the party responsible for compliance could void the user's authority to operate the equipment.

### Radiation Exposure Statement

**This equipment complies with FCC radiation exposure limits set forth for an uncontrolled environment. This equipment should be installed and operated with minimum distance 20cm between the radiator and your body.**

## **SAFETY NOTICE**

1. Please read the user manual carefully before using the projector.
2. Please use a standard power cord with ground wire to ensure stable power supply.
3. Please use the same power voltage as marked on the projector.
4. Please do not disassemble the projector by yourself; otherwise the warranty will be void.
5. Please do not look into the lens when the projector is operating, otherwise it may hurt your eyes.
6. Please do not cover the projector ventilation holes with any material.
7. Please keep the projector away from water or any other liquid as it is not waterproof.
8. Please don't put the projector in wet or moist conditions to prevent electric shock.
9. Please turn off and unplug from the power supply if not using the projector for a long time.
10. Please use the original packing foam or other anti-shock material when relocating the projector.
11. Please contact our customer support if the projector has any problems. This mini projector comes with a full 12-month warranty. Please contact us if you want to know more information about the warranty. (Warranty service does not include the frame, manual, packing and subjective ideas about the video, sound or image aspects)

# Functional Overview

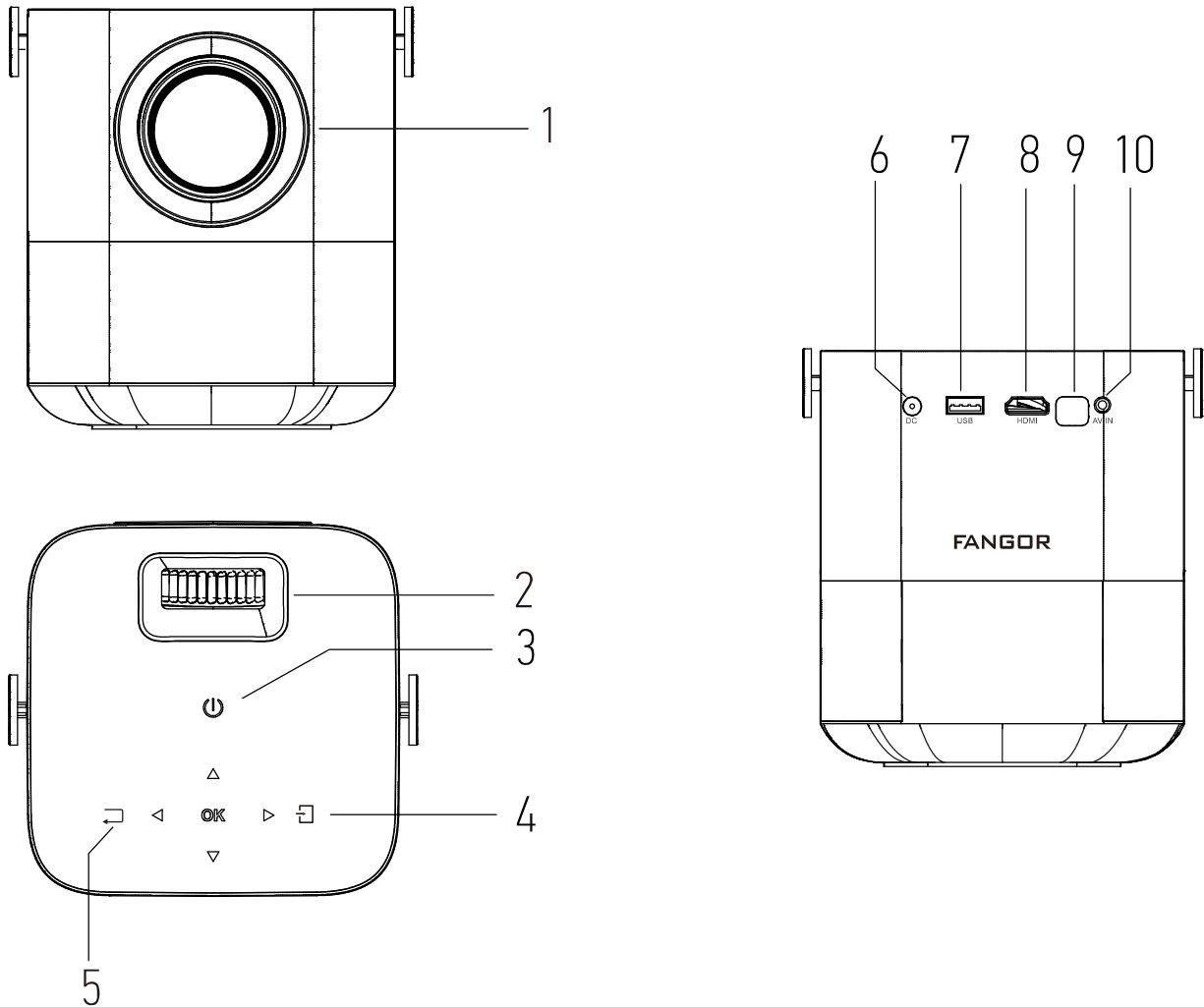

- 1.Lens
- 2.Manual focus
- 3.Power Button

- 4.Menu
- 5.ESC
- 6.DC

- 7.USB
- 8.HDMI
- 9.IR Window
- 10.AV IN



# IR TRANSMITTER

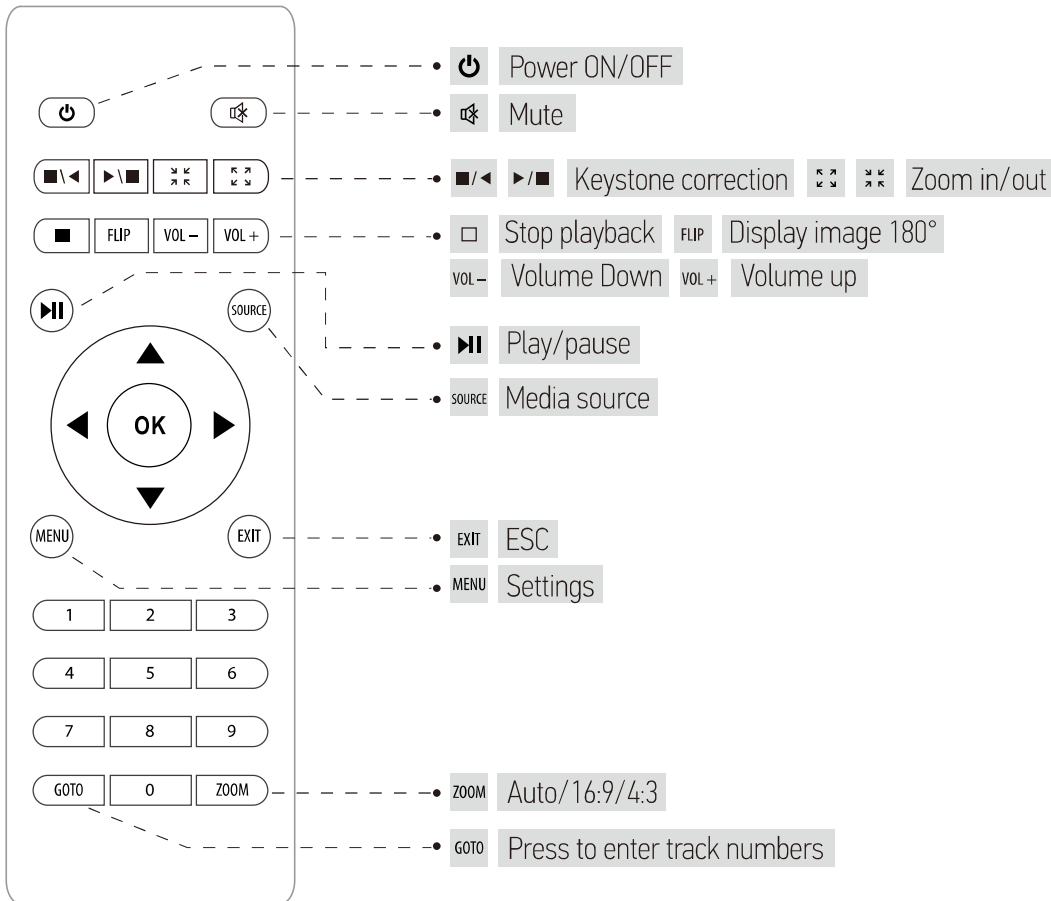

## Caution

Do not submerge the remote control in water.

Do not put the remote control near fire or in wet/hot places.

Do not use old and new batteries together in the remote control.

Please take the batteries out if not using the remote control for a long time to avoid battery leakage.

Please point the remote control at the IR receiver.

# Playing Your Projector



Front Table:

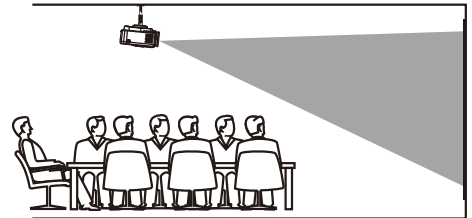

Front Ceiling:

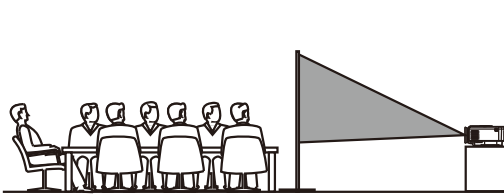

Rear Table:

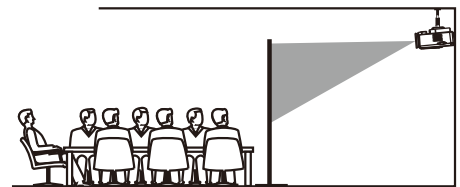

Rear Ceiling:

Projection distance and screen size.

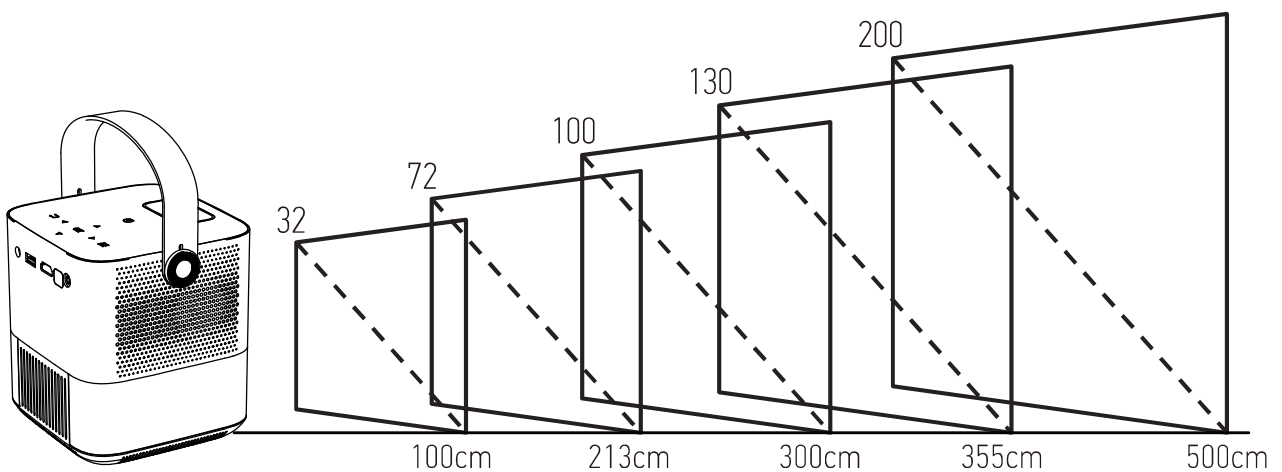

For reference only. The projection distance and screen size differ based on the configuration of the projector.

## Placing Your Projector On Ceiling

1. When installing the projector in the ceiling, please purchase a projector mount recommended by an installation professional and follow the instructions that come with the mount.

2. Before installing the projector in the ceiling, please check to make sure the ceiling structure can support the weight of the projector and the mount.

- NOTE: Projector mount and screw(s) not included.

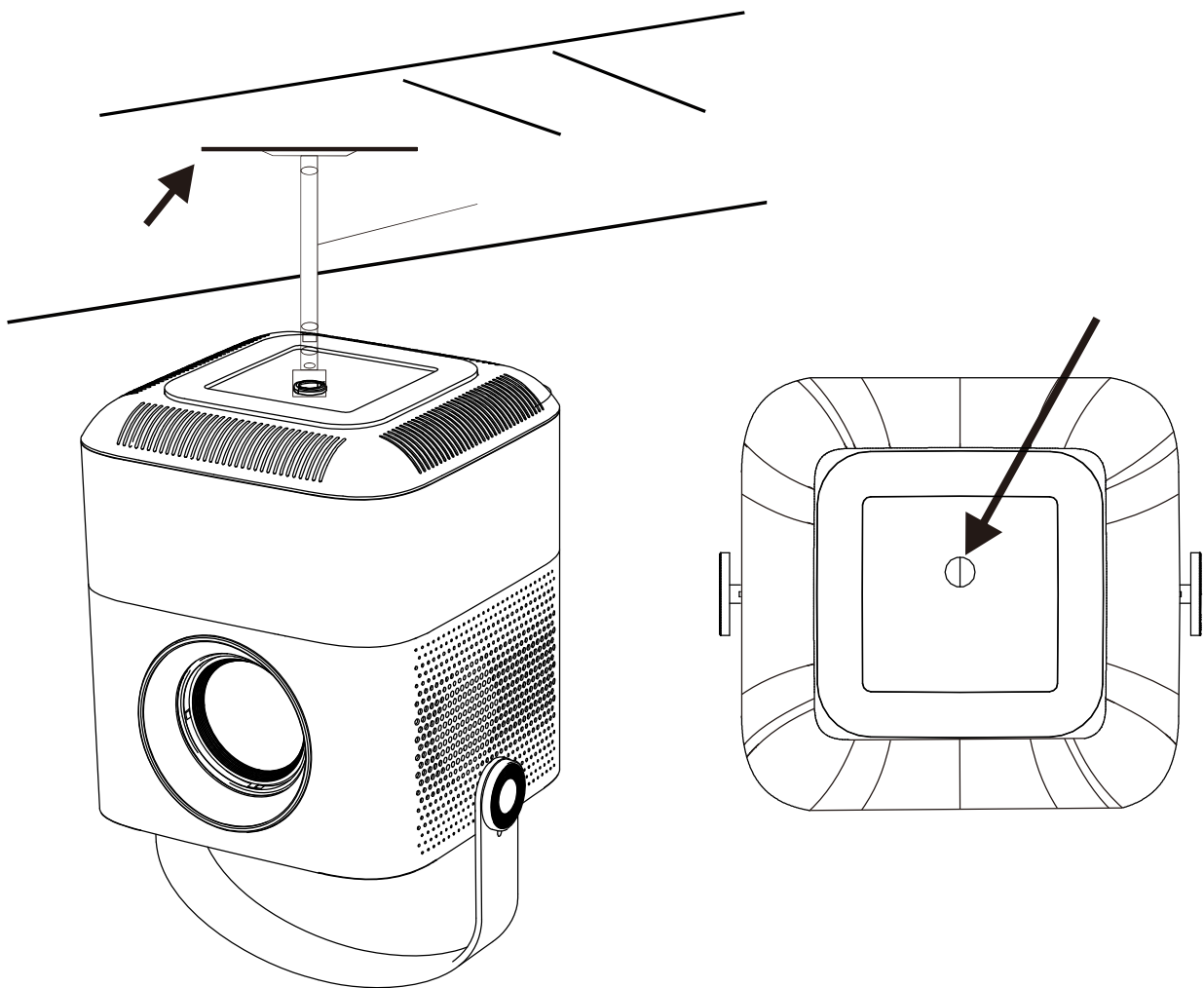

# USER MANUAL

## 1.1 Connecting the projector to power

Step1 Connect the power cable to the projector.

Step 2 The projector will display an indicator light when connected to power.

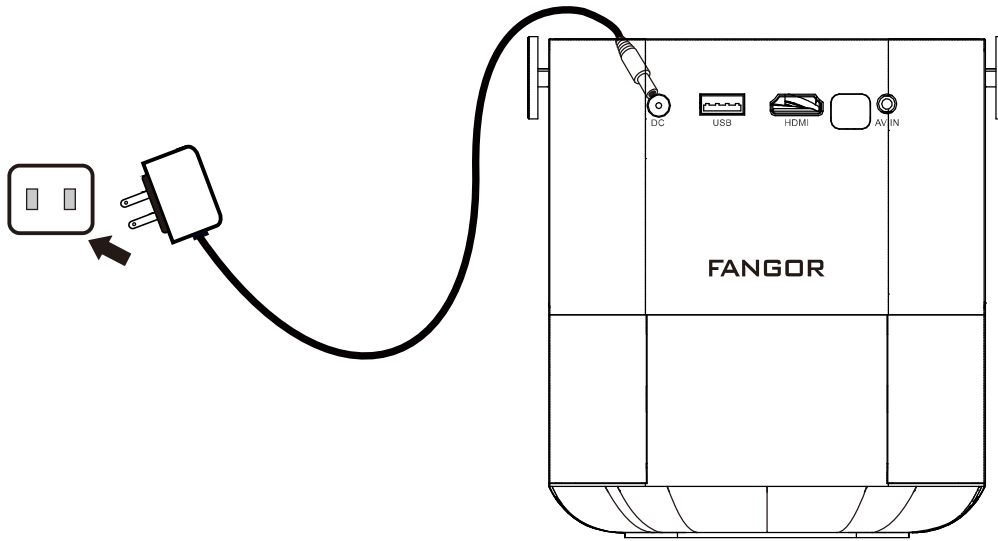

Step3 Press the “  ” button on the projector or on the remote control to power on.

Step 4 After 2-5 seconds, the multimedia screen will be displayed.

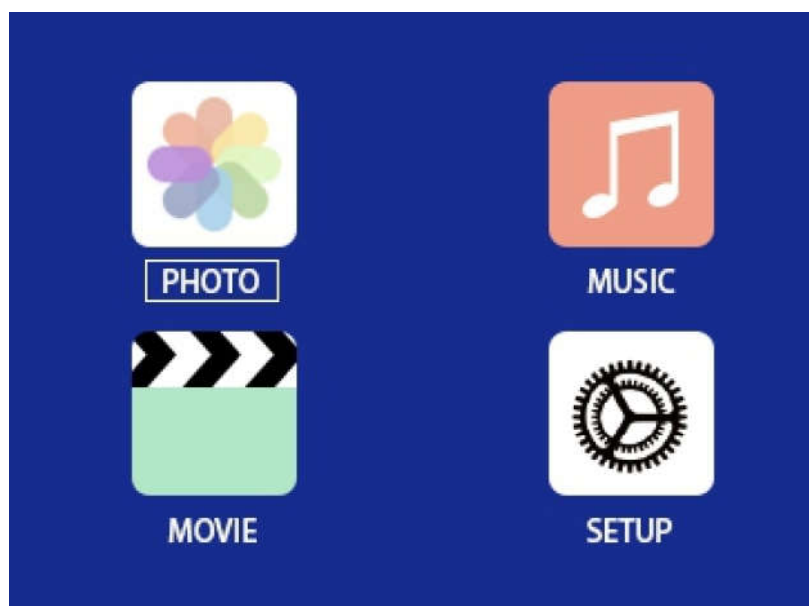

## 1.2 keystone correction & Focus

1.2.1 This projector uses the optical keystone correction function. If the image is displayed in a trapezoidal shape (picture), you can use the remote control or the keystone correction function in the menu to adjust it. Therefore the image can be adjusted as follows:

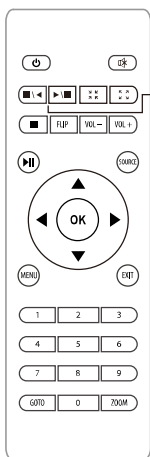
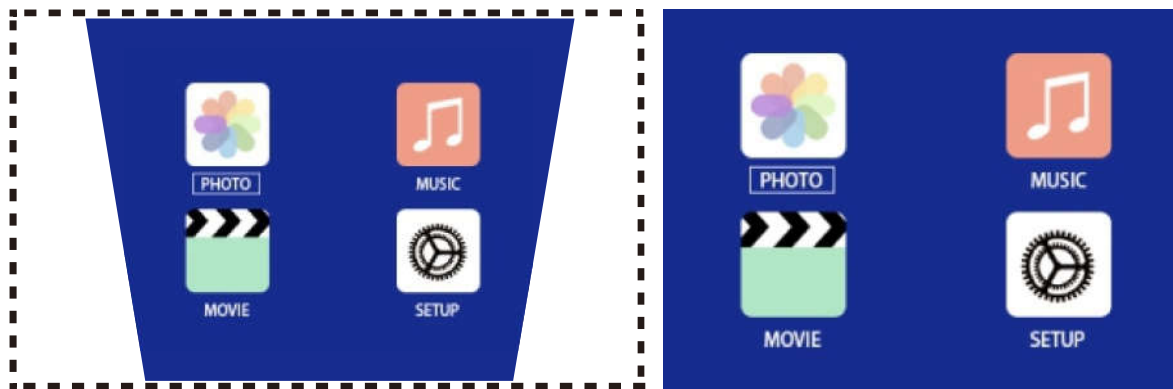

keystone correction

or

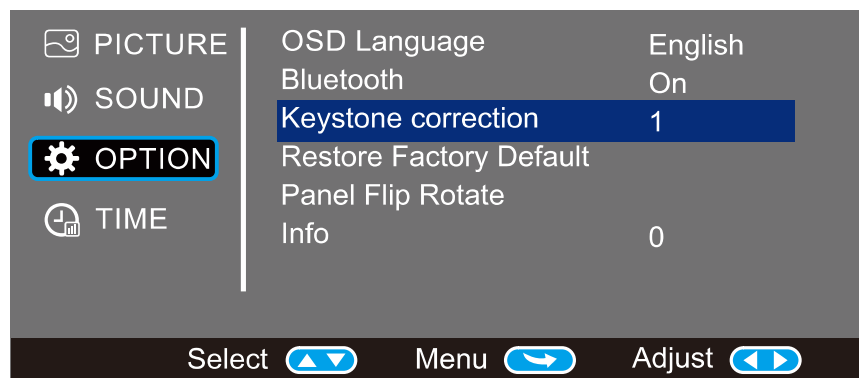

### 1.2.2 Image focusing

Make sure the projector is horizontal to the projector screen and adjust the focus by pressing button 2.

You can display video or the menu to check adjustment.

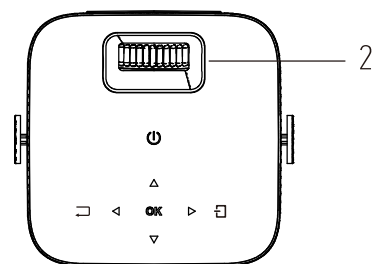

## 2.1 Playing media from a USB

2.1.1 Insert the USB into the slot.

2.1.2 Click the “Media” on the home page.

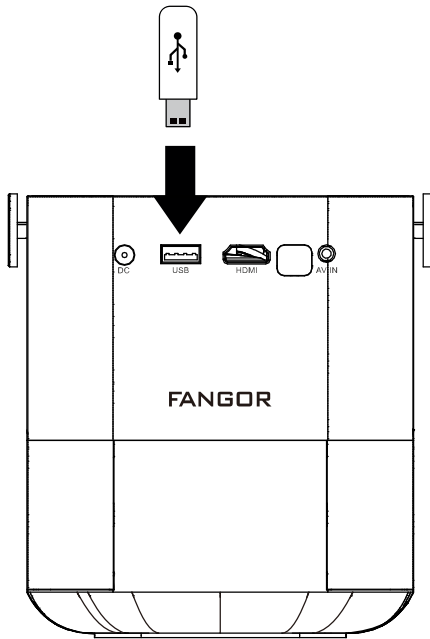

2.1.3 Choose the content which you need to display: Video/music/photos/text. And press “OK” button to access it.

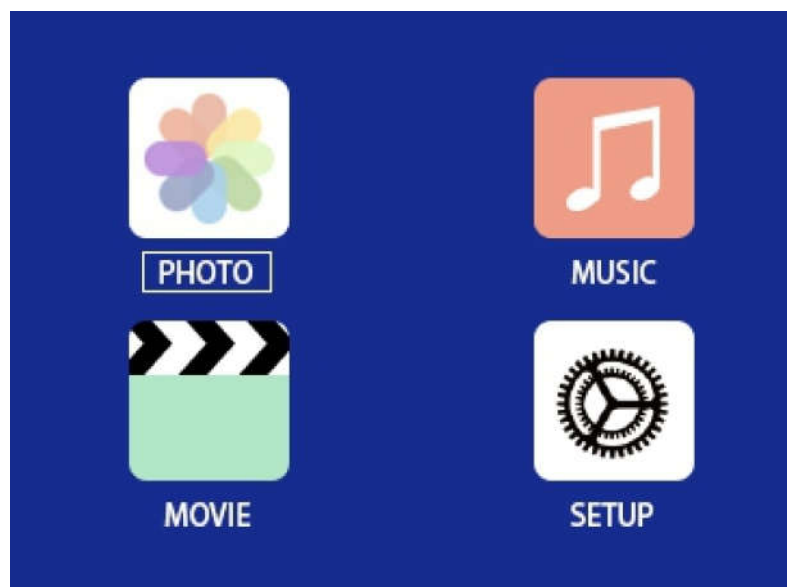

2.1.4 Choose the file you want to display. Press“▲”to display or stop.

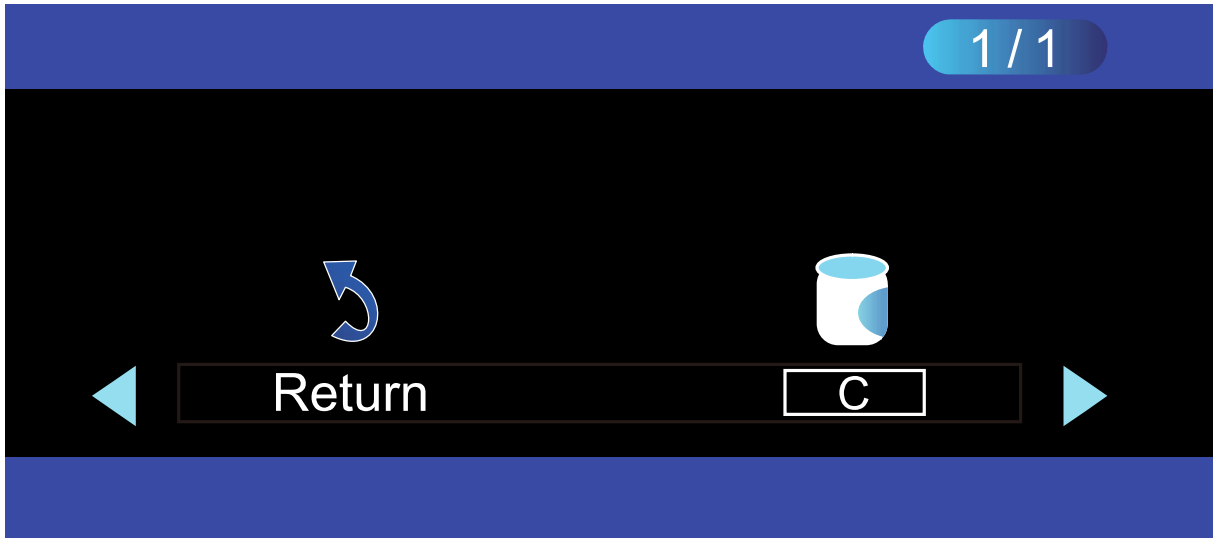

Supported multimedia formats

Multimedia	Audio file	MP3/WMA/OGG/AAC/MF4/FLAC/APE/WAV
	Picture file	JPEG/BMP/PNG
	Video flie	MPEG1,MPEG2,FLV,MPEG4,RM,AVI/RMVB, MOV, MKV,DIVX,FVOB M-JPEG
	Text file	Not support TXT

## Settings of playing video on Media Player

When you playing videos from the Media player (like USB drive etc), press the "OK" button to enter the setting options like following showed:

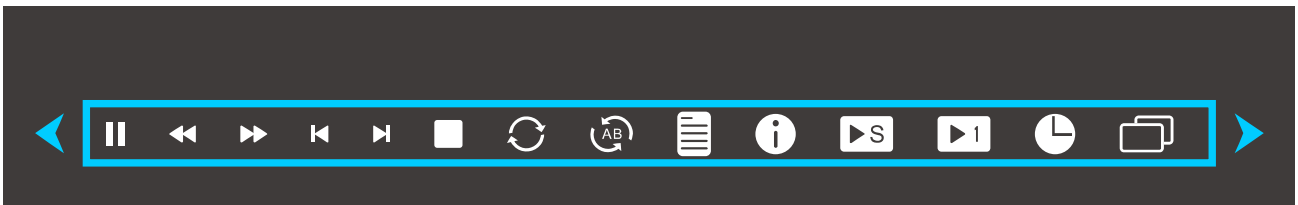

Icon	Parameter	Option
	Play/Pause	Press to play or pause a individual chapter or track
	FB	FB2X,FB4X,FB8X,FB16X,FB32X
	FF	FF2X,FF4X,FF8X,FF16X,FF32X
	Prev.	Press to play previous video
	Next	Press to play next video
	Stop	Press to stop playback and return to the root menu
	Repeat All	Repeat None, Repeat 1, Repeat All
	Set A/B	Set A, Set B, None
	Play List	Press to open the playing list
	Info	Video's parameters: Resolution, audio track, Subtitle, Sync, Code Page, Program, Size.
	Slow Forward	SF2X,SF4X,SF8X,SF16X
	Step Forward	Each frame moves forward slowly
	Goto time	Set and jump to your desired time
	Aspect Ratio	Auto/16:9/4:3



## Setting of playing Picture on Media Player

When you playing Pictures from the Media player (like USB drive etc), press the "OK " button to enter the setting options like following showed:

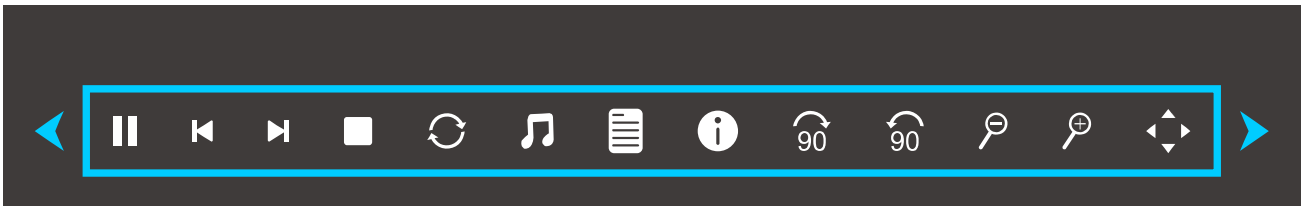

Icon	Parameter	Option
	Play/Pause	Press to play or pause a individual chapter or track
	Prev.	Press to play previous video
	Next	Press to play next video
	Stop	Press to stop playback and return to the root menu
	Repeat All	Repeat None, Repeat 1, Repeat All
	Set A/B	Music
	Play List	Press to open the playing list
	Info	Video's parameters: Resolution, audio track, Subtitle, Sync, Code Page, Program, Size.
	Rotate	Clockwise:90 Degree, 180 Degree, 270 Degree
	Rotate	Counterclockwise:90 Degree, 180 Degree, 270 Degree
	Zoom in	X1/2, X1/4
	Zoom out	X1, X2, X4, X8
	Move view	Picture is zoom in mode, you can use this button to move this picture

### 3.1 HDMI connection

3.1.1 Use the HDMI slot to connect computers and HDMI compatible devices. Once connected, press“ the /SOURCE ”button to HDMI mode.

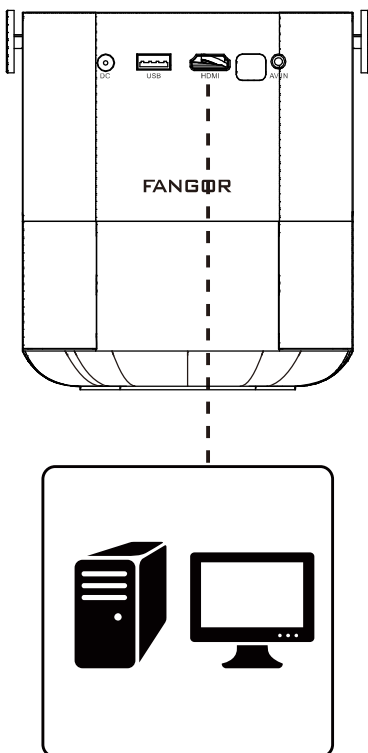

Supported resolutions:

576P, 480P, 720P, 1080P, 640x480, 800x600, 1024x768, 1280x1024, 1280x720, 1440x900, 1366x768, 1920x1080, 1280x800, 1440x960, 680x1050

## 4.1 AV video connection

### 4.1 AV video connection (DVD player)

4.1.1 Use a 3-in-1 AV cable (Not included) to connect to the projector as shown below. Once connected, select the AV signal source. Supports NTSC/PAL.

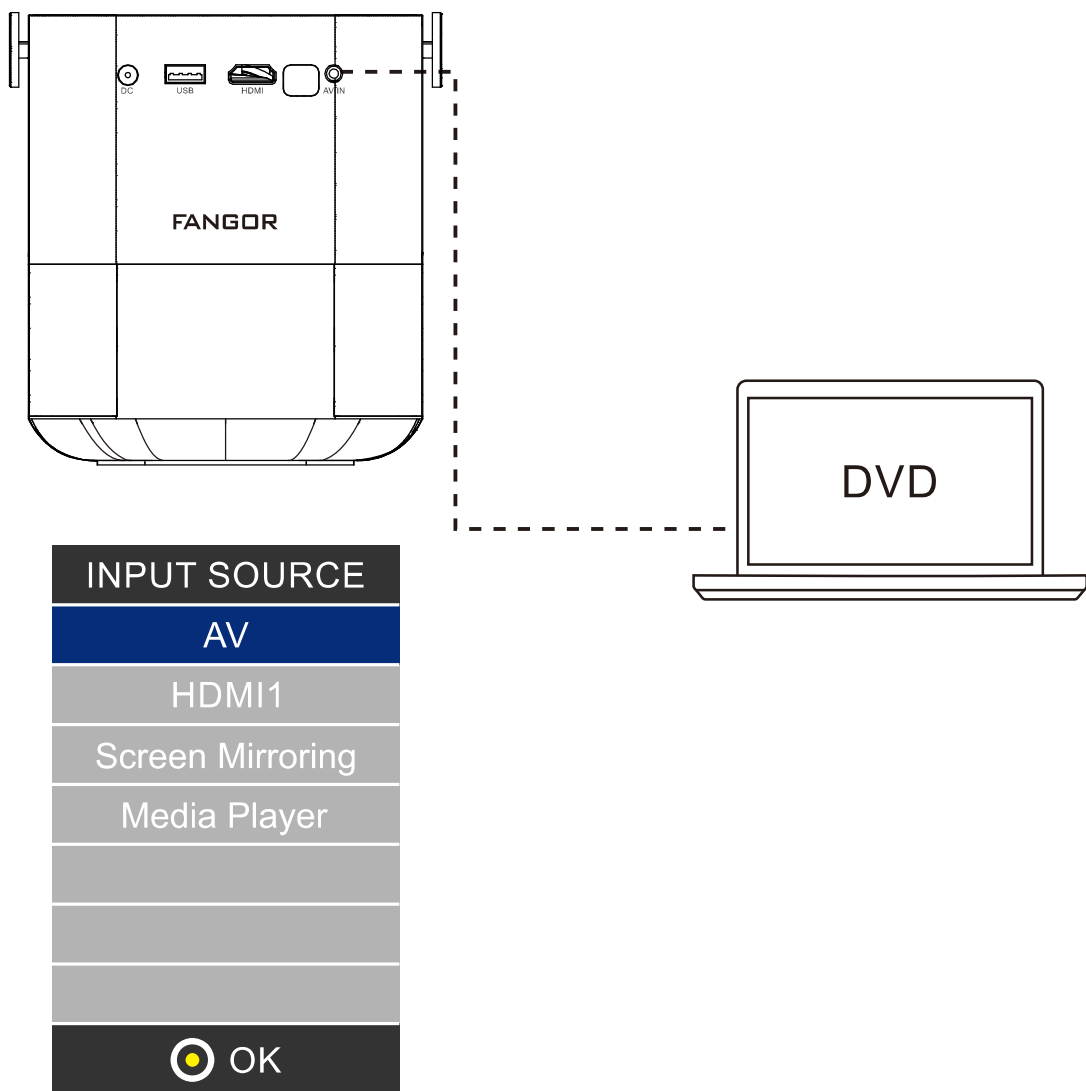

## 5.1 Pairing to Bluetooth Wireless Speakers or Sound Bar

5.1.1 Power on the projector and make sure the projector's Bluetooth is ON from the OPTIONS Menu. The projector will begin searching for near by Bluetooth devices to connect to, the Bluetooth devices will be shown on the screen, select it to connect it.

5.1.2 When successfully paired, the projector will display the Bluetooth receiver's name on the top right portion of the Main Menu screen, and sound played from the projector will be heard through the Bluetooth receiver.

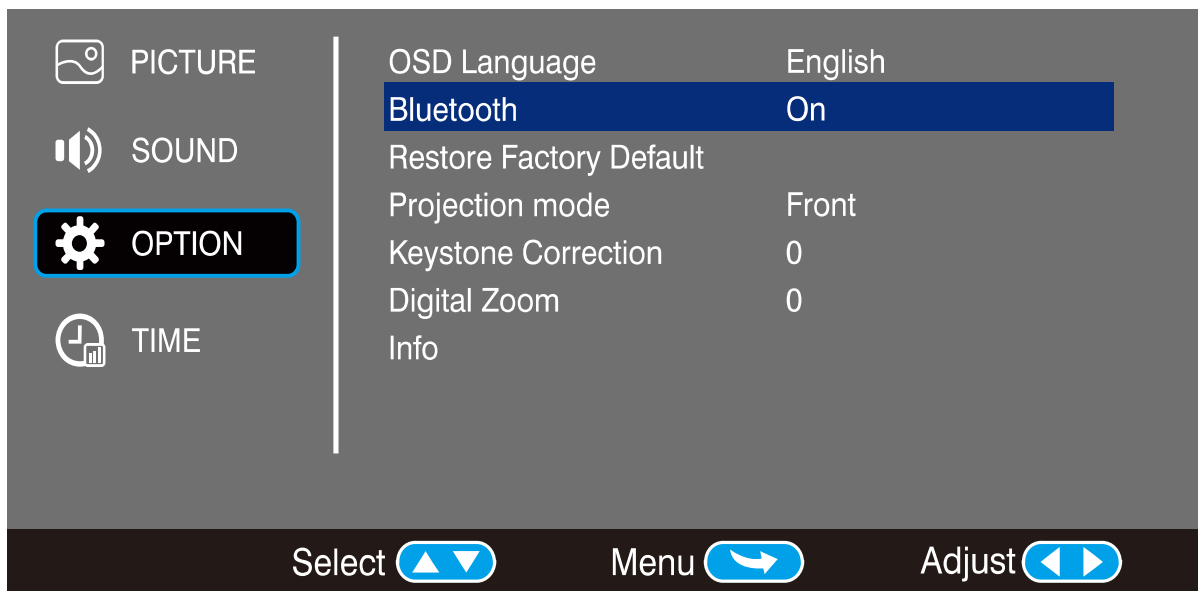

### NOTE:

- 1) After initial pairing, the projector and the Bluetooth speakers will keep the pairing status all the time when Bluetooth functions for both devices are opened. So we suggest that you turn off the Bluetooth function before you are ready to turn off the projector each time.
- 2) When you try to connect a new blue tooth speaker, please turn off the previous speaker/ headphone.
- 3) Devices such as smartphones, tablets, or computers are not Bluetooth receivers and will not connect to the projector. To eliminate confusion, you should disable Bluetooth on all receivers to which you do not wish to connect.

## 6.1 Wireless Connection to Smartphone/Pad

### 6.1.1 Wireless Connection to iPhone/iPad.(iOS)

For IOS device, considering there are two different operating environments :

**A. With WiFi environment.**

**B. Without WiFi environment.**

#### A.iOS device with WiFi Environment.(Recommended)

Step1: Turn on the projector and press the "source" button on the remote control or projector's button. Click to enter the "Screen Mirroring" on the projector. (Loading time 5-10 seconds)



Step2: Open the WiFi function on your smartphone/pad, and connect to the projector's SSID (name and password showed on the screen).

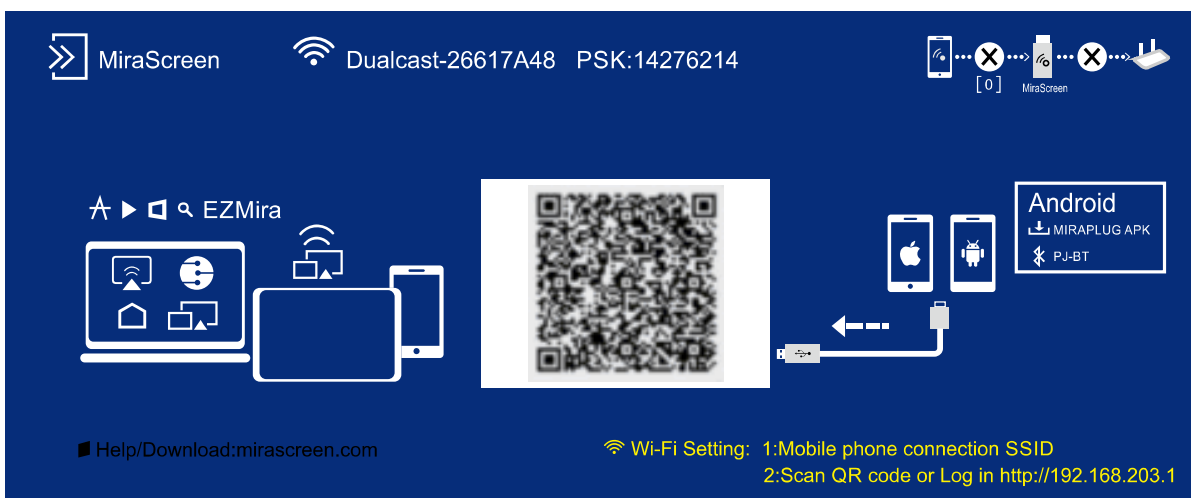

Step3: Enter the URL:http://192.168.203.1 on the browser(or scan the QR code)

Step4: Connect your Home WiFi on the browser page.

Step5: Open the Screen Mirroring on you phone , and choose the correct SSID name.Then the connection is succeeded.



Tips: When you connect for the second time, please make sure the phone is connected to the SSID;Switch the projector to the “screen mirroring” page, and click the “screen mirroring” on your phone,the connection is successful.

### B:IOS device without WiFi environment.(Use the phone's network data)

Step1: Turn on the projector and press the "source" button on the remote control or projector's button. Click to enter the "Screen Mirroring" on the projector.(Loading time 5-10 seconds)

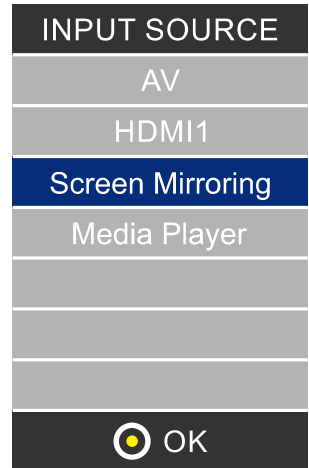

Step2: Open the WiFi function on your smartphone/pad, and connect to the projector's SSID (name and password showed on the screen).

Step3: Choose "Cellular Data" and turn on it.

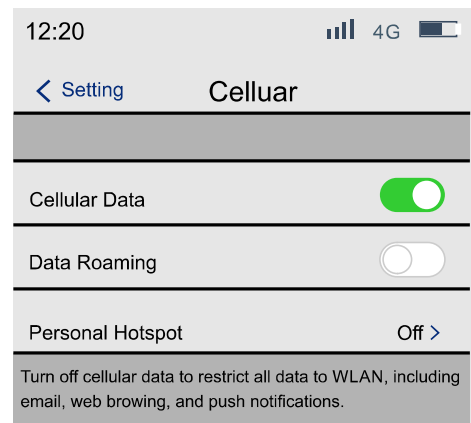

Step4: Open the Screen Mirroring , and choose the correct SSID name. Then the connection is succeeded.

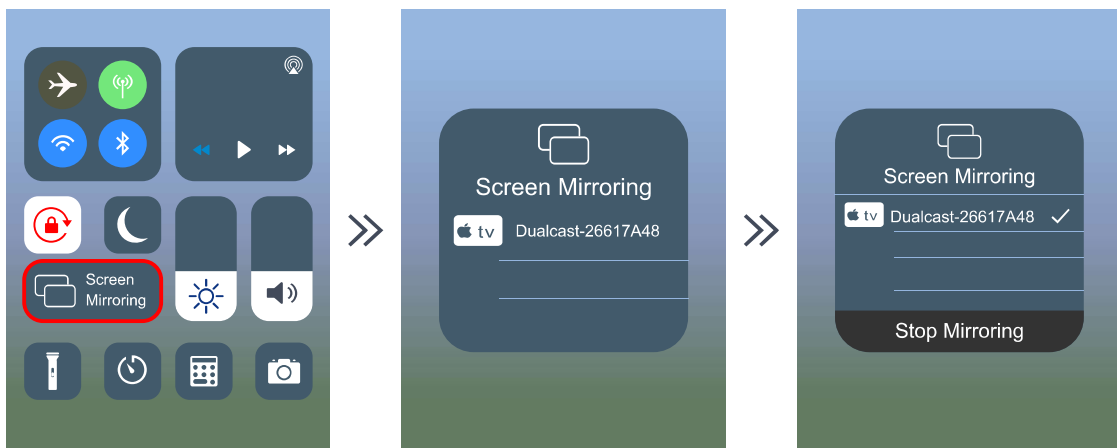

### 6.1.2 Wireless Connection to Android Phone.

For Android device, considering there are two different operating environments :

**A)With WiFi environment.**

**B)Without WiFi environment.**

#### **A: Android device with WiFi Environment.**

Step1: Turn on the projector and press the "source" button on the remote control or projector's button. Click to enter the "Screen Mirroring" on the projector. (Loading time 5-10 seconds)

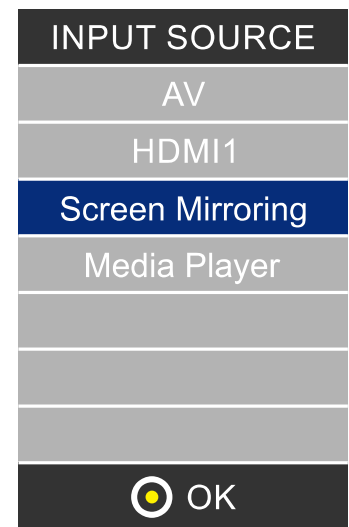

Step2: Open the WiFi function on your smartphone/pad, and connect to the projector's SSID (name and password showed on the screen)

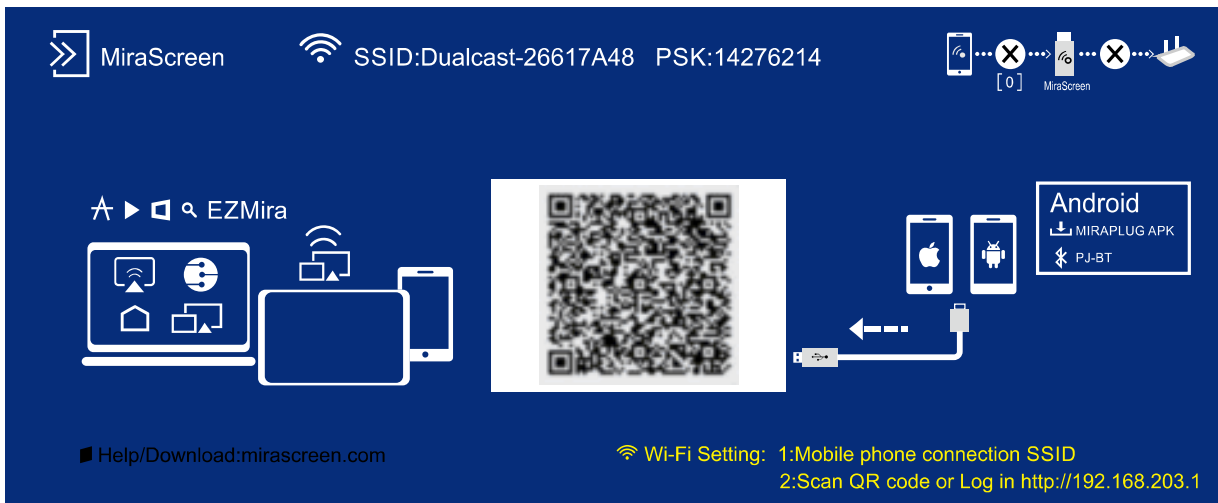

Step3: Enter the URL: <http://192.168.203.1> on the browser (or scan the QR code)

Step4: Connect your home WiFi on the browser page.



Step5: Open the “Multi-screen/ Miracast” function on the Android device.

Step 6: Choose the correct SSID name, then the connection is succeeded.

Due to the diversification of Android Phone, when you open the Multi-screen function, there may appear two WiFi names. How to choose?

- ① Choose the one with the WiFi logo  ,
- ② If there is no WiFi icon , the first one is selected by default.

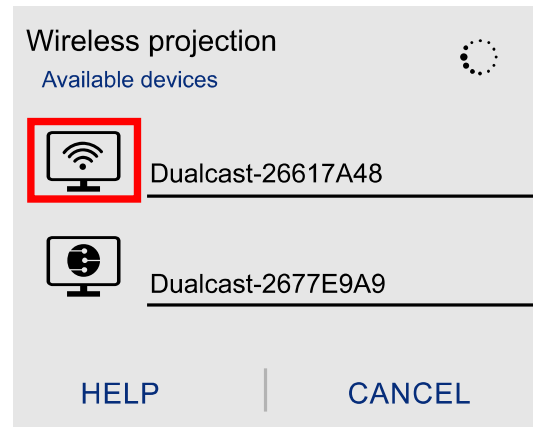

● Tips: When you connect for the second time, Switch the projector to the "Screen Mirroring" page, and click the "Screen Mirroring" on your phone, the connection is successful. (No need to perform the Step 1-4)

**B: Android device Without WiFi environment.(Use the phone’s network data)**

Step1: Turn on the projector and Open the "source" with the remote control or projector’s button. Click to enter the "Screen Mirroring" on the projector. (Loading time 5-10 seconds)

Step2: Click “WiFi” on your Android device, turn on the “WiFi-Scan” But do not connect any WiFi.

Step3: Choose “Phone Network Data” and turn on it.

Step4: Open the Multi-screen/Miracast on your Android device , choose the correct SSID name. Then the connection is succeeded.

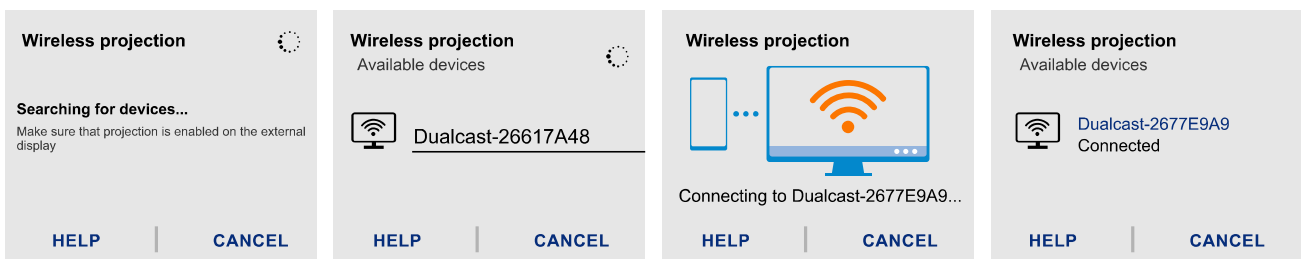
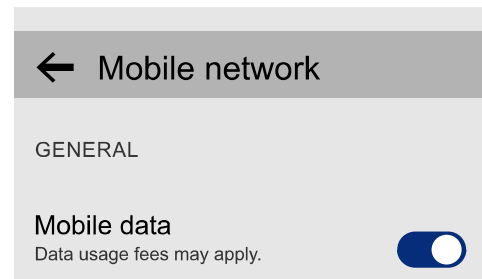

## 6.2 Wired Connection to Smartphone/Pad

### 6.2.1 Wired Connection to iOS. (iPhone/iPad)

Step1: Turn on the projector and press the "source" with the remote control or projector's button. Click to enter the "Screen Mirroring" on the projector. (Loading time 5-10 seconds)



Step2: Connect your IOS device with the projector's USB port via USB to Lightning Cable.

Step3: Click "Trust" and input your screen lock password.

If no password, ignore it.

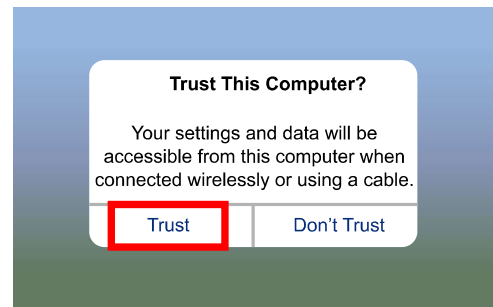

Step4: Then the connection is succeeded.

### 6.2.2 Wired Connection to Android Phone.(Need to download the APP : MiraPlug)

Step1: Turn on the projector and Open the "source" with the remote control or projector's button. Click to enter the "Screen Mirroring" on the projector.(Loading time 5-10 seconds)

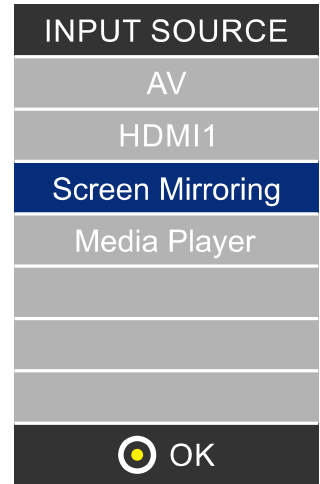

Step2: Connect your Android device with the projector's USB port via USB to Micro/Type C Cable.  
Step3: Choose USB Transfer Method(Transfer files)and open USB debugging.

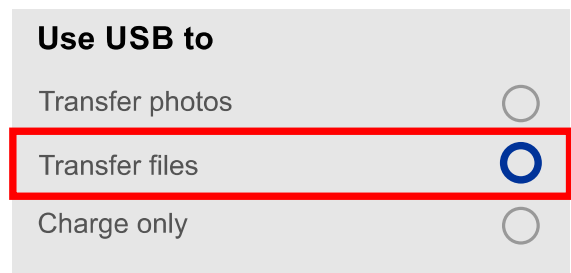

Step4:Follow the prompts of the APP.

- ①DownLoad MiraPlug;
- ②Re-plug the USB Cable to activate the APP;
- ③Click ,Connect Bluetooth according to the prompt tone (Bluetooth name : PJ-BT);
- ④Back to UI interface.Then the connection is succeeded.

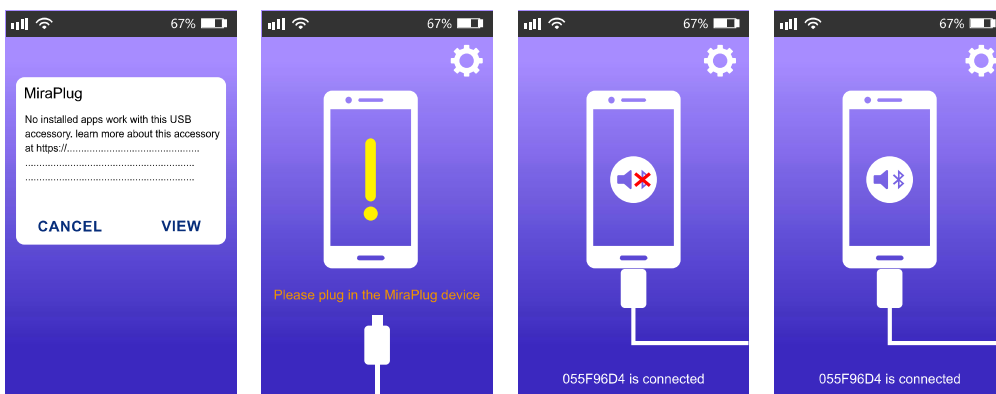

## Menu option: Picture

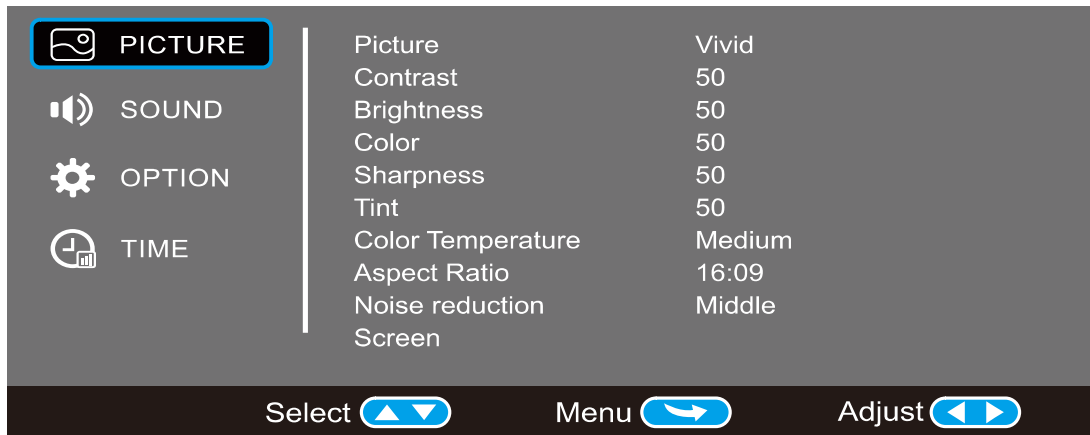

Parameter	Option
Picture mode	Vivid User Soft Standard
Contrast	Value: 1-100
Brightness	Value: 1-100
Color	Value: 1-100
Sharpness	Value: 1-100
Tint	Value: 1-100
Color Temperature	Medium Warm Cool
Aspect Ratio	16:9 4:3 Auto Point to point Panorama Just Scan Zoom 2 Zoom 1
Noise reduction	Middle High Low
Screen	

### ● Note:

User: In this mode, some parameters become variable to manual setting (the font color will turn white). In other modes, the parameter becomes preset and cannot be set (the parameter font color is gray).

### ● Operating

Select: ▲ / ▼ Return to the previous menu: ↶ Return to the desktop: ↷ Adjust: ◀ / ▶

## Menu option: Sound

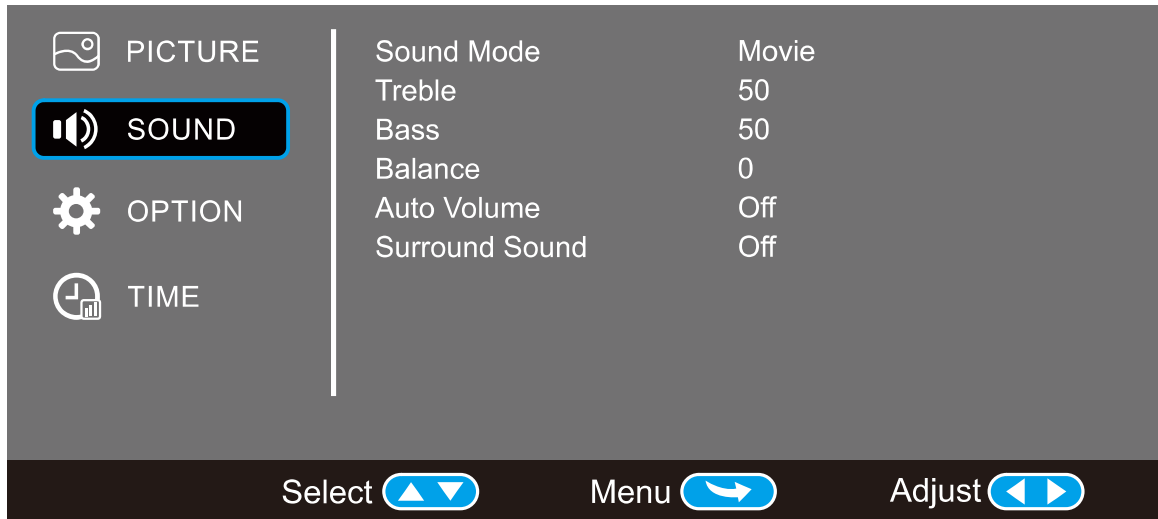

Parameter	Option
sound mode	Movie Sport User Standard Music
treble	Value: 1-100
bass	Value: 1-100
balance	0
auto volume	Off ON
surround sound	Off Surround

### ● Note:

User: In this mode, some parameters become variable to manual setting (the font color will turn white). In other modes, the parameter becomes preset and cannot be set (the parameter font color is gray).

### ● Operating

Select: ▲ / ▼ Return to the previous menu: ↶ Return to the desktop: ↷ Adjust: ◀ / ▶

### How do you know that the operation is in effect?

The selection takes effect based on the selected parameters.

Figure: Surround Sound Off → At this time, the Surround mode is off.

## Menu option: Option

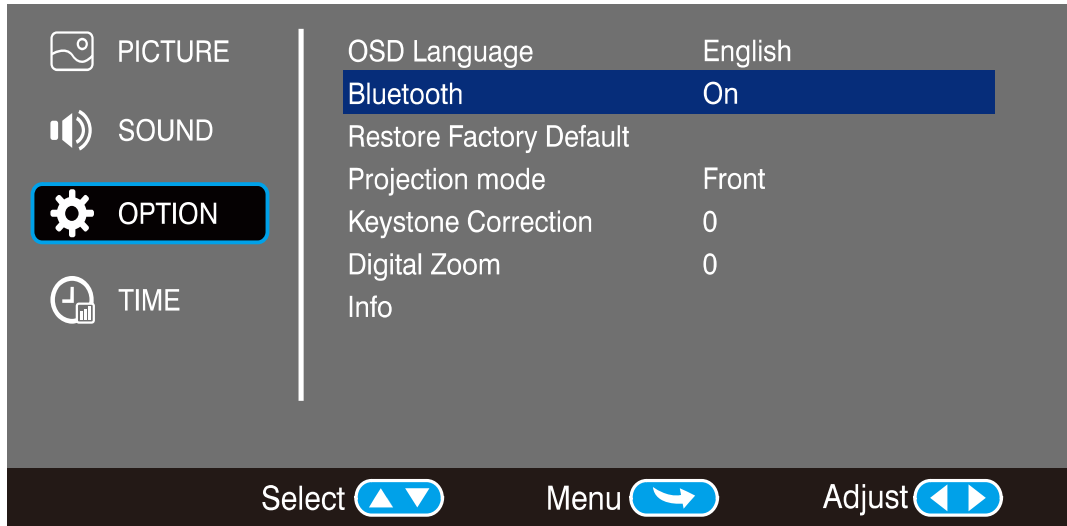

Parameter	Option
OSD Language	Czech English Francais Dansk 日本語 Hrvatski Deutsch Espanol Italiano Magyar Polski Slovencina Nederlands Portugues Srpski Norsk Romaneste Suomi Svenska Slovensky 中文
Bluetooth	Off On
Restore Factory Default	
Projection Model	Front, Rear, F/Ceiling, Rear/Ceiling
Digital Zoom	0, 8, 16, 24, 32, 40, 48, 56, 64, 72, 80
Info	

● **Note:**

User: In this mode, some parameters become variable to manual setting (the font color will turn white). In other modes, the parameter becomes preset and cannot be set (the parameter font color is gray).

● **Operating**

Select: ▲ / ▼ Return to the previous menu: ↶ Return to the desktop: ↷ Adjust: ◀ / ▶

**How do I know if Bluetooth is turned on?**

The selection takes effect based on the selected parameters.

Figure: **Bluetooth On** → At this time, the bluetooth function is ON.

## Menu option: Time

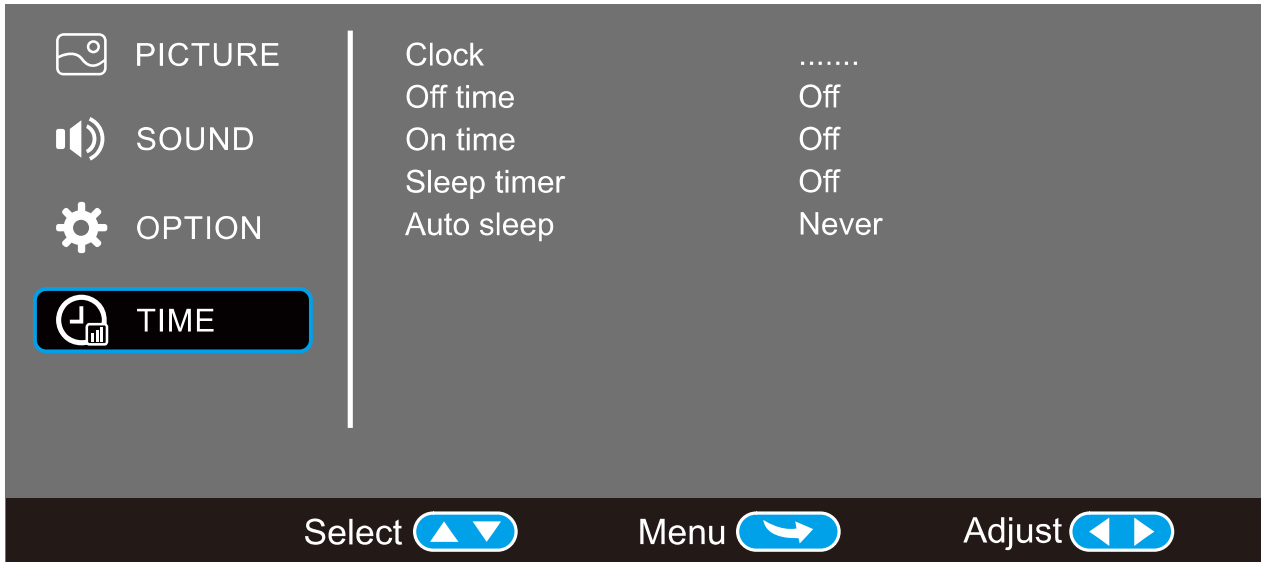

Parameter	Option
Clock	
Off time	Off Once
On time	Off Once
Sleep timer	Off 10min 20min 30min 60min 90min 120min
Auto sleep	Never 4 Hour 6 Hour 8 Hour

### Illustration

Clock	Off time	On time
Date	Day	Hour 00
Mouth	Hour	Minute 00
Year	Minutes	AV
Hour		...
Minute		Volume 30

Press ◀ / ▶ to select the range of values.

Date	1-30
Mouth	1-12
Year	1-----
Hour	1-24
Minute	1-60
Volume	1-100

## FAQ

**Q:Why can my projector not be turned on?**

A:Please be sure that the AC power cable is plugged in tightly,and press the power switch on the projector's panel or use the remote controller to turn it on.

**Q:The projector is turned on,but no image is displayed**

A:①Please make sure your device is connected to the projector correctly.

②Check the lens cover has been removed.

③Check if the input signal source is correct,and then switch into projection mode,Wait for a while and operate it again.

④Please make sure that the video source is equal or under 720P.

⑤If it is still not working,please contact us for further support.

**Q:The Lamp(Bulb) switches off after a period of time.**

A:1.Leave the projector to cool for a few moments.

2.Once cooled,check if anything is blocking the ventilation vents.

3.Turn on the projector.

If the issue persists please contact us.

**Q:When playing a video,we see the image but I hear no sound**

A:If you connect to your laptop via a HDMI adapter.The audio cable of the adapter needs to be plugged into the audio output port from your laptop to the projector using a 3.5mm audio jack.

**Q:The projection is not bright enough**

A:We recommend using the projector in a relatively dark environment to bring out the best image brightness.

This projector is designed for Home Entertainment and is not recommended for Powerpoint or other business presentations.

**Q:Spots on the screen.**

Using a vacuum cleaner to clean the lens.If cleaning does not resolve things,please contact your support provider for further assistance.



## FAQ

**Q: I get a blurry image?**

A: The recommended projection distance is 3-9ft. Please adjust the Keystone correction to get a rectangular image first, then adjust the Focus to get a clear image. The optimal focus is obtained when the pixels are clearly visible. If the projection size is too large, the focus near the screen edges may be less sharp than at the screen center.

Q: My projector noise is too loud, is it broken?

**Q: My projector noise is too loud, is it broken?**

A: The projector noise comes from the fan of its cooling system. Projector generates heat during operation as the light bulb produces strong light to make a bright image. It is normal for the projector to make a loud noise. Brighter the image, louder the sound is. You can place the projector far from where you are, or you can connect a loudspeaker to the projector to cover up the noise.

**Q: Bluetooth not work.**

A: Please note the Bluetooth function is not support to connect with a smartphone or pad etc. If the Bluetooth speaker or earphone is not able to connect, please contact our customer service, we will help to solve soon.

**Q: After scanning the QR code, it prompts to upgrade the system?**

A: We will continue to improve customer experience based on market feedback (such as mobile phone system upgrades), so we will upgrade (regularly).

**Q: Can you adjust the brightness/Sharpness of the video?**

A: Path: Set up (Click "Source") - Picture Picture Mode (Choose "User") - Adjust via remote control. For non-professionals, we recommend using the default value.

**Need to know more....**

**www.fangor-store.com / us-projector@fangor.cn**

You can find the operation video on FANGOR official website

## Specifications

Model	F-802
Imaging Technology	LCD
Highest Resolution Supported	1920*1080
Keystone	Correction $\pm 10^\circ$
Signal Port	AV/ HDMI/USB
USB Port	Up to 32GB
Display Color	7000-8000K
Power Voltage	100V-240V 50/60Hz
Power Input	DC 12V 3.5A
Power Consumption	72W
Weight	1.08kg
Dimension	145mm*145mm*155mm

Ideal for dark viewing environments for optimal performance .