

# FANGOR

F-206

MULTIMEDIA PROJECTOR  
INSTRUCTION MANUAL



English  
1-23

日本語  
24-47

Deutsch  
48-71

Français  
72-95

Español  
96-119

Italiano  
120-143

# Table of Contents

Important Safety Instructions .....	2
Additional Warnings and Precautions .....	2
Note&Tips .....	3
FCC Warning .....	3
Package Listing .....	4
Remove & Close the Lens Cover .....	5
Placing Your Projector .....	5
To Reduce Image Distortion .....	6
Distance Between The Projector And Screen .....	6
Placing Your Projector On Ceiling .....	6
Adjust the Vertical Location .....	7
Adjust the Focus and Keystone .....	7
Controls of Remote .....	8
Install & Remove Battery Of Remote .....	8
Functional Overview .....	9
Controls of Projector .....	10
AC Adapter Installation Instruction .....	10
AC Adapter Remove Instruction .....	11
Install Power Adapter .....	11
Connect HDMI .....	12
Connect AV .....	12
Connect VGA .....	13
Connect Audio Output (Aux Out / Line Out / Earphones) .....	14
Using USB & Micro SD Card Playback .....	14
Settings of playing video on Media / HDMI / VGA / AV .....	15
Setting of playing Picture on Media / HDMI / VGA / AV .....	16
Using Bluetooth playback .....	17
WIFI Connection and IOS Cast .....	18
Miracast .....	21
Specifications .....	22
Troubleshooting .....	23
Warranty .....	23

# Important Safety Instructions

1. Read these Instructions.
2. Keep these Instructions.
3. Heed all Warnings.
4. Follow all instructions.
5. Do not use this apparatus near water.
6. Clean only with a dry cloth.
7. Do not block any ventilation openings. Install in accordance with the manufacturer's instructions.
8. Do not install near any heat sources such as radiators, heat registers, stoves, or other apparatus (including amplifier) that product heat.
9. Protect the power cord from being walked on or pinched particularly at plugs, convenience receptacles, and the point where they exit from the apparatus.
10. Only use attachments/accessories specified by the manufacturer.
11. Unplug this apparatus during lightning storms or when unused for long periods of time.
12. Refer all servicing to qualified service personnel. Servicing is required when the apparatus has been damaged in any way, such as power-supply cord or plug is damaged, liquid has been spilled or objects have fallen into the apparatus, the apparatus has been exposed to rain or moisture, does not operate normally, or has been dropped.
13. Use only with a cart, stand, tripod, bracket, or table specified by the manufacturer or sold with the apparatus. When a cart is used, use caution when moving the cart/ apparatus combination to avoid injury from tip-over.



# Additional Warnings and Precautions

1. Do not look directly into the projector light.
2. Don't touch the projector lens
3. Mains adapter is used as disconnect device and it should remain readily operable during intended use. In order to disconnect the apparatus from the mains completely, the mains plug should be disconnected from the mains socket outlet completely.
4. **CAUTION:** Use of controls or adjustments or performance of procedures other than those specified may result in hazardous radiation exposure.
5. **WARNING:** Changes or modified to this unit not expressly approved by the party responsible for compliance could void the user's authority to operate the equipment.
6. **WARNING:** Use of this unit near fluorescent lighting may cause interference regarding use of the remote. If the unit is displaying erratic behavior move away from any fluorescent lighting, as it may be the cause.
7. **WARNING:** Shock hazard - Do Not Open.
8. Caution and marking information is located at the rear or bottom of the apparatus.
9. **WARNING:** To reduce the risk of fire or electric shock, do not expose this apparatus to rain, moisture, dripping, or splashing.
10. Objects fill with liquids, such as vases, shall not be placed on the apparatus.

## Note & Tips

### 1. Connect to computer

Please use the HDMI cable in the package.

The USB interface is used to connect USB Flash Drive.

### 2. Blurry Image

Adjust the keystone, focus ring, and the projection distance.

### 3. Bluetooth not work

Please note the Bluetooth function is not support to connect with smart phone or pad etc.

If the Bluetooth speaker or earphone is not able to connect, please contact our customer service, we will help solving soon.

## FCC Warning

This device complies with Part 15 of the FCC rules.

Operation is subject to the following two conditions:

(1) This device may not cause harmful interference.

(2) this device must accept any interference received, including interference that may cause undesired operation.

**NOTE:** This equipment has been tested and found to comply with the limits for a Class B digital device, pursuant to Part 15 of the FCC Rules. These limits are designed to provide reasonable protection against harmful interference in a residential installation. This equipment generates, uses, and can radiate radio frequency energy and, if not installed and used in accordance with the instructions, may cause harmful interference to radio communications. However, there is no guarantee that interference will not occur in a particular installation. If this equipment does cause harmful interference to radio or television reception, which can be determined by turning the equipment off and on, the user is encouraged to try to correct the interference by one or more of the following measures:

- Reorient or relocate the receiving antenna.
- Increase the separation between the equipment and receiver.
- Connect the equipment into an outlet on a circuit different from that to which the receiver is connected.
- Consult the dealer or an experienced radio/TV technician for help.

**Warning:** Changes or modifications to this unit not expressly approved by the party responsible for compliance could void the user's authority to operate the equipment.

#### Radiation Exposure Statement

This equipment complies with FCC radiation exposure limits set forth for an uncontrolled environment. This equipment should be installed and operated with minimum distance 20cm between the radiator and your body.

# Package Listing

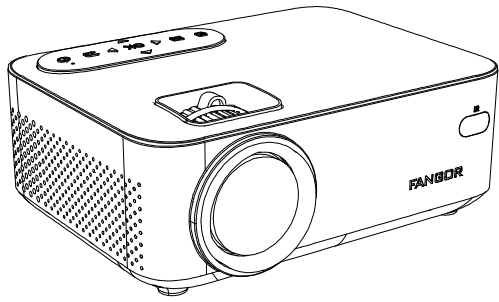

Projector

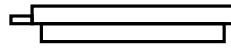

Lens Cover

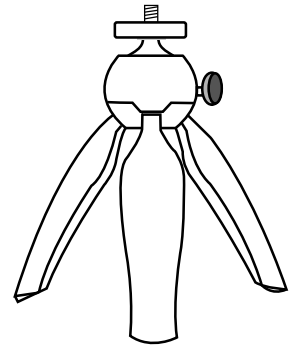

Tripod

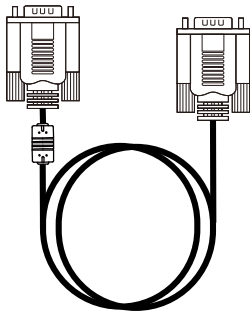

VGA Cable

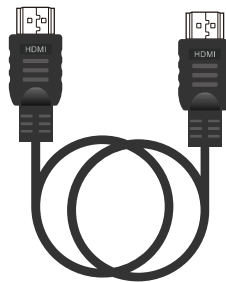

HDMI Cable

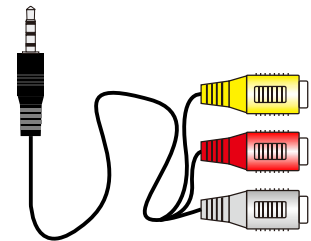

AV Cable

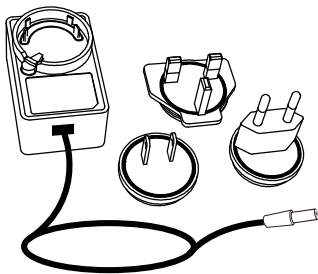

3-in-1 Power Adapter



Remote Control



Carrying Bag



User Manual

# Remove & Close The Lens Cover

Remove the lens cover before using

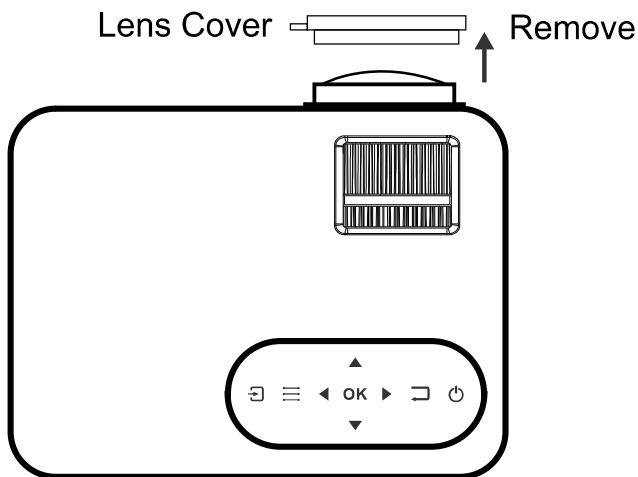

Close the lens cover when unit not using

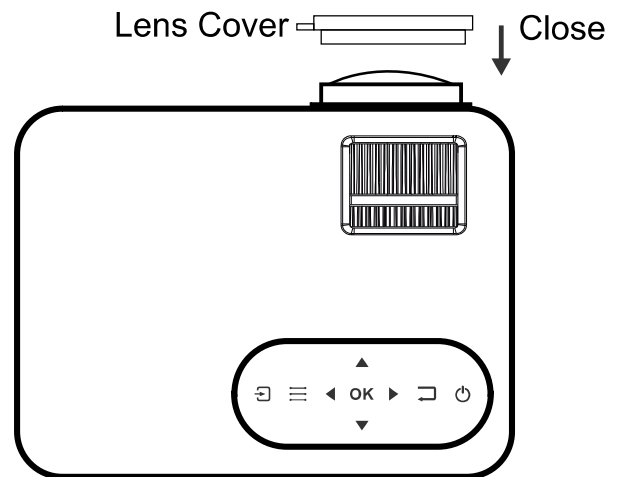

# Playing Your Projector

Your projector can be installed in four different configurations ( see picture below):

## Front Table:

Select this location with the projector placed near the floor in front of the screen. This is the most common way to position the projector for quick setup and portability.



FRONT TABLE

## Front Ceiling:

Select this location with the projector suspended upside-down from the ceiling in front of the screen.

**NOTE:** A projector mount is required to in-stall the projector in a ceiling.

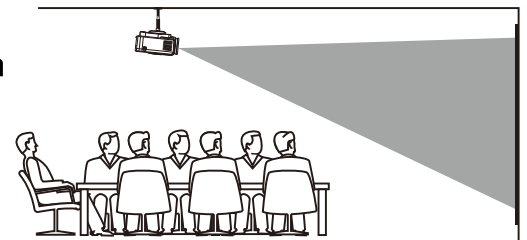

FRONT CEILING

## Rear Table:

Select this location with the projector placed near the floor behind the screen.

**NOTE:** That a special rear projection screen is required.



REAR TABLE

## Rear Ceiling:

Select this location with the projector suspended upside-down from the ceiling behind the screen.

**NOTE:** A projector mount is required to install the projector in a ceiling. A special rear projection screen is required.

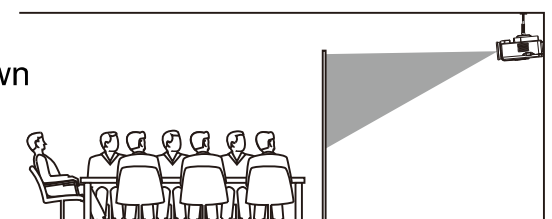

REAR CEILING

## To Reduce Image Distortion

It is recommended to move the projector as close to center of screen.

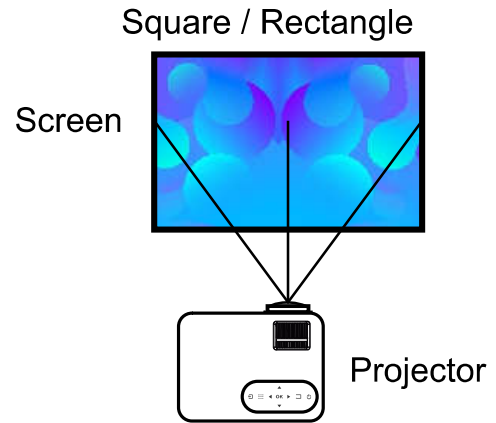

## Distance Between The Projector And Screen

Measure the distance between the projector and where you want to position the screen. This is the projection distance.

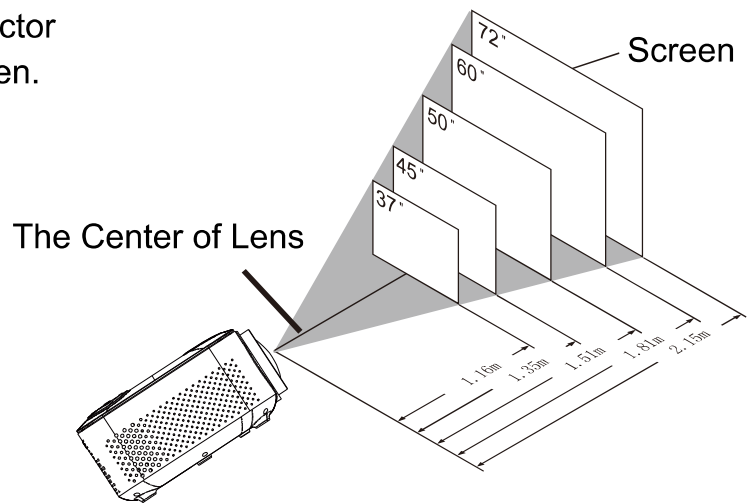

## Placing Your Projector On Ceiling

When installing the projector in the ceiling, please purchase a projector mount recommended by an installation professional and follow the instructions that come with the mount.

Before installing the projector in the ceiling, please check to make sure the ceiling structure can support the weight of the projector and the mount. If in doubt, please ask the advice from an installation professional.

**NOTE:** Projector mount and screw(s) not included

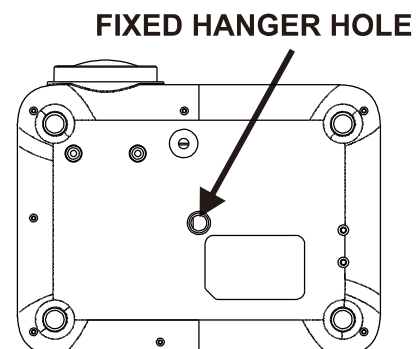
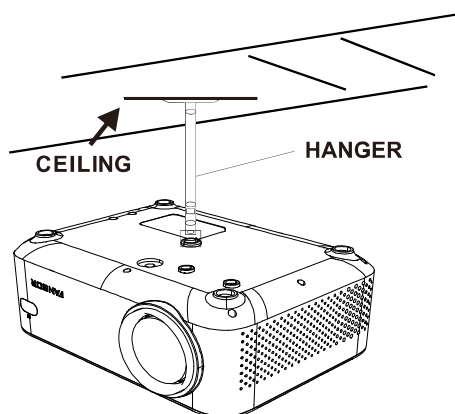

# Adjust the Vertical Location

Follow below picture to adjust the vertical location

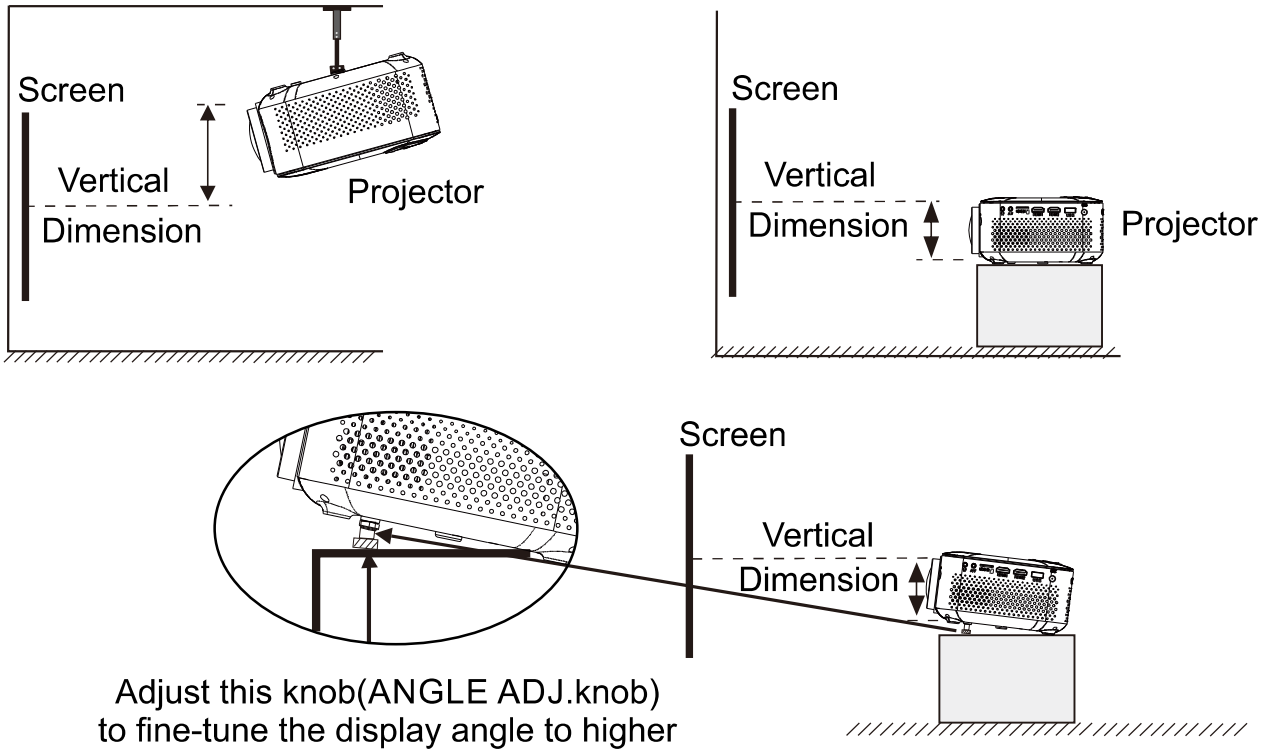

# Adjust the Focus and Keystone

Follow below picture to adjust the focus and trapezoidal screen.

- ★ Adjust the focus by turning the knob while observing the image pixels near the center of the screen. Optimal focus is obtained when the pixels are clearly visible. Depending on the projected screen size, the focus near the screen edges maybe less sharp than the screen center.

## FOCUS ADJ.KNOB

Then sharpen the image by rotating focus knob.

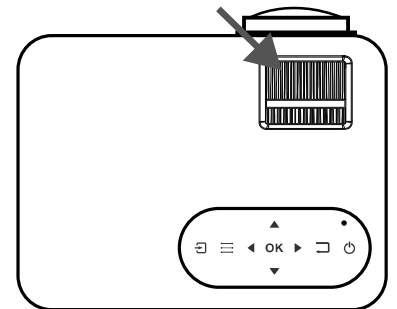

- ★ Keystone image is created when the projector beam is projected to the screen in an angle. Keystone correction will restore the distorted image to a rectangular or square shape.

## TRAPEZOIDAL ADJ.KNOB

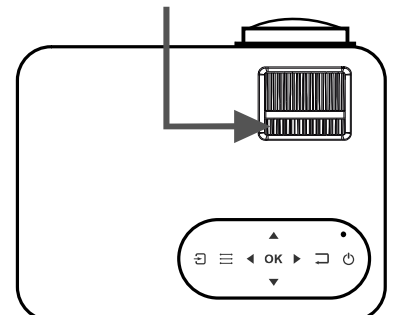



## Controls of Remote

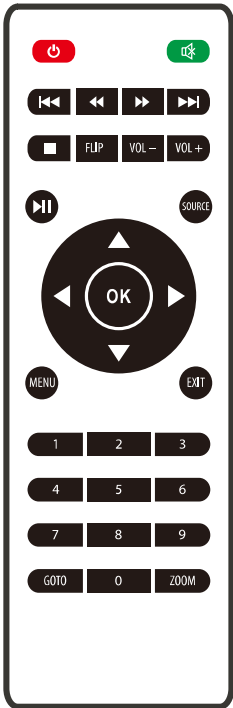

Power	Press to power ON. Press and hold to power OFF.
Previous/Next	Press to skip between chapters or tracks
STOP	Press to stop playback
FLIP	Press to flip display image 180°
Play/Pause	Press to play or pause an individual chapter or track
Arrows/OK	Press to navigate and confirm selections in Settings and other menus
MENU	Press to access projector Settings
GoTo Number Keypad	Press to enter specific chapter or track numbers. Use play button to begin playing
MUTE	Press to mute volume
back/fwd	Press to reverse or fast forward during playing video/music
VOL+/VOL-	Press to adjust audio level.
SOURCE	Press to select media source (AV, PC, HDMI, MEDIA).
EXIT	Press to exit menus.
ZOOM	Press to adjust the aspect ratio during playing video (Auto/16:9/4:3).

## Install & Remove Battery Of Remote

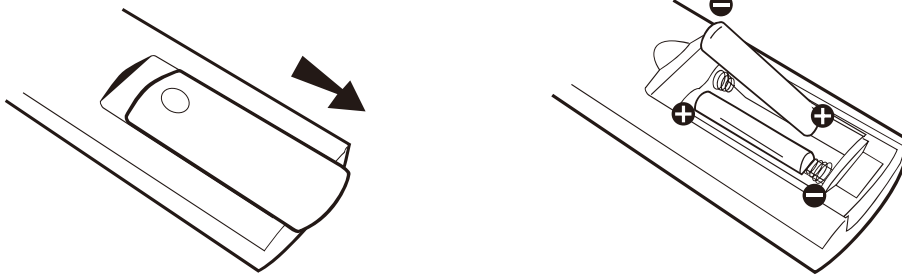





Remove the battery compartment cover on the back of your remote by carefully sliding to open. The battery cover can then be lifted away. Fit the correct batteries (2XAAA batteries not included), referring to the polarity markings. Finally, replace the cover.

### NOTE:

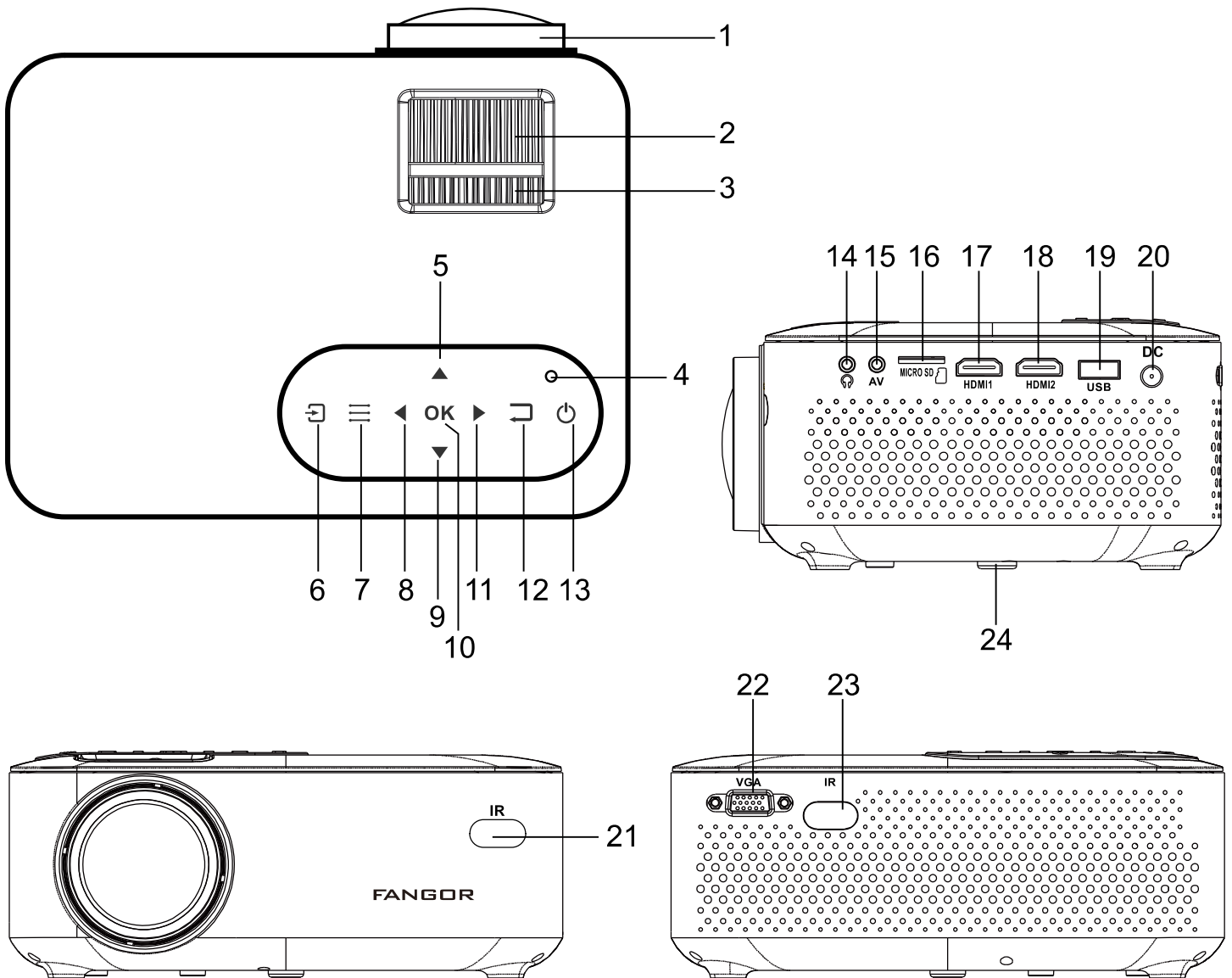
- Batteries shall not be exposed to excessive heat such as sunshine, fire.
- Make sure that the batteries are installed polarity correctly.
- Only same or equivalent type batteries as recommend are to be used.
- Do not dispose of batteries in fire, battery may explode or leak. Do not try to recharge a battery.
- Do not mix old and new batteries.
- Do not mix alkaline, standard(carbon-zinc), or rechargeable(ni-cad,ni-mh,etc) batteries.

# Functional Overview



- |   |   |
|---|---|
| <ul style="list-style-type: none"> <li>1. LENS</li> <li>2. FOCUS ADJ. Knob</li> <li>3. TRAPEZOIDAL ADJ. Knob</li> <li>4. POWER on Indicator</li> <li>5. UP</li> <li>6. SOURCE  Button</li> <li>7. MENU  Button</li> <li>8. LEFT</li> <li>9. DOWN</li> <li>10. OK</li> <li>11. RIGHT</li> <li>12. RETURN  Button</li> </ul> | <ul style="list-style-type: none"> <li>13. POWER  Button</li> <li>14. EAR PHONE Jack</li> <li>15. AV IN Jack</li> <li>16. Micro SD Card</li> <li>17. HDMI Port 1</li> <li>18. HDMI Port 2</li> <li>19. USB Port</li> <li>20. DC IN jack</li> <li>21. IR Window ( Front Side)</li> <li>22. VGA Port</li> <li>23. IR Window ( Rear Side)</li> <li>24. ANGEL ADJ. Knob</li> </ul> |
|---|---|

# Controls of Projector

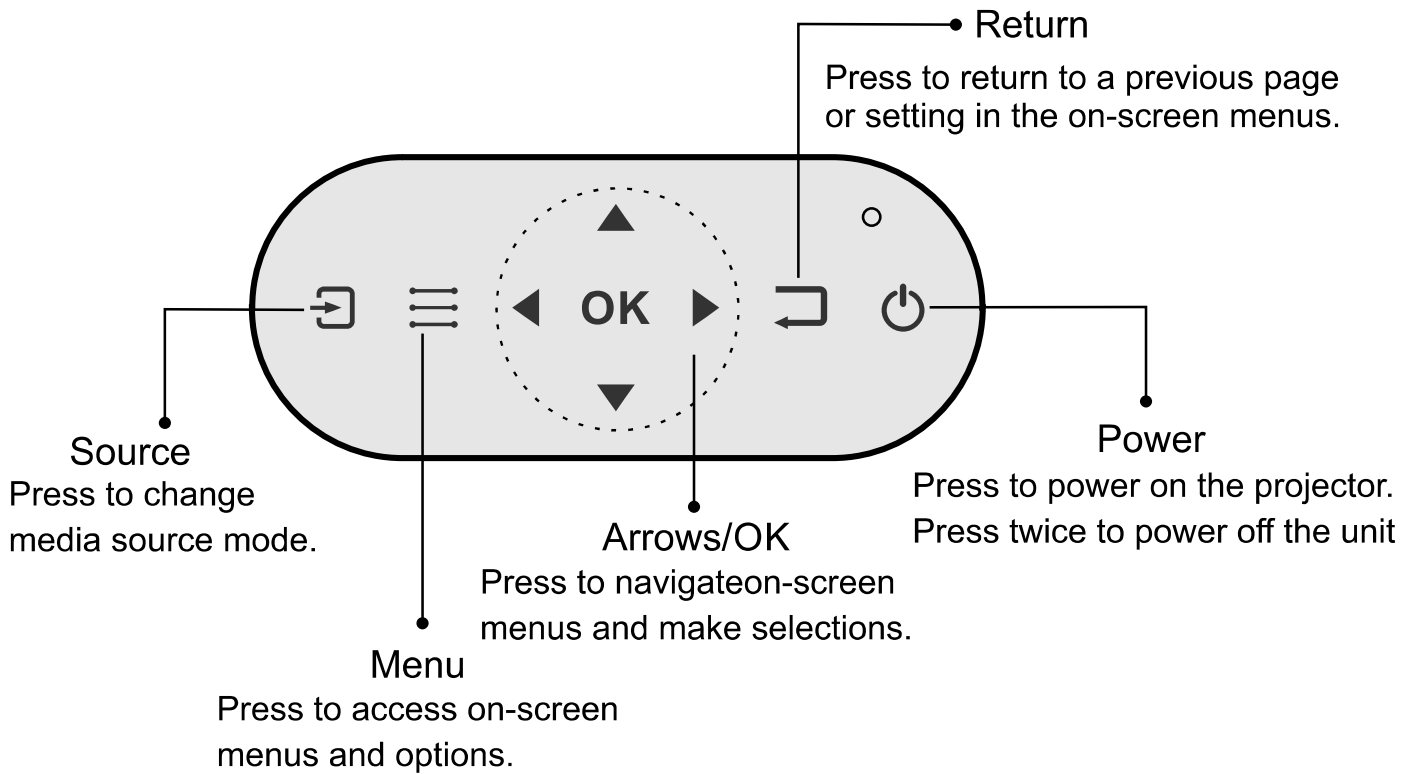

# AC Adapter Installation Instruction

- 1: Choose one types of plug that you need (UL Plug, EU Plug, UK Plug)
- 2: Aim the hole of the charging head at the charging base pin.
- 3: Turn the charging head to the right with a little bit of force to lock.

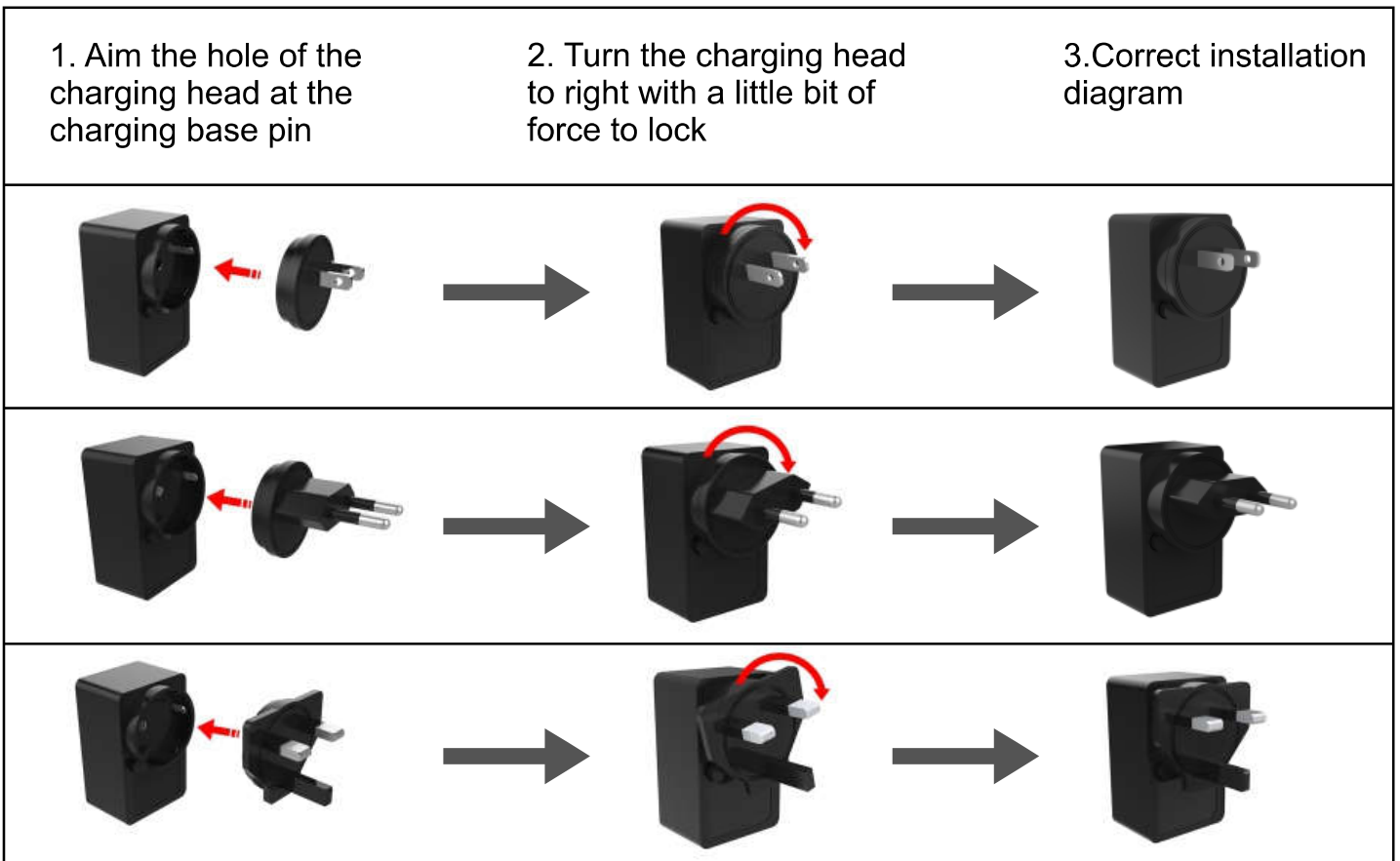

# AC Adapter Remove Instruction

- 1: Press it with a little force
- 2: Turn the charging head to the left with a little bit of force to open
- 3: Disassemble display drawing

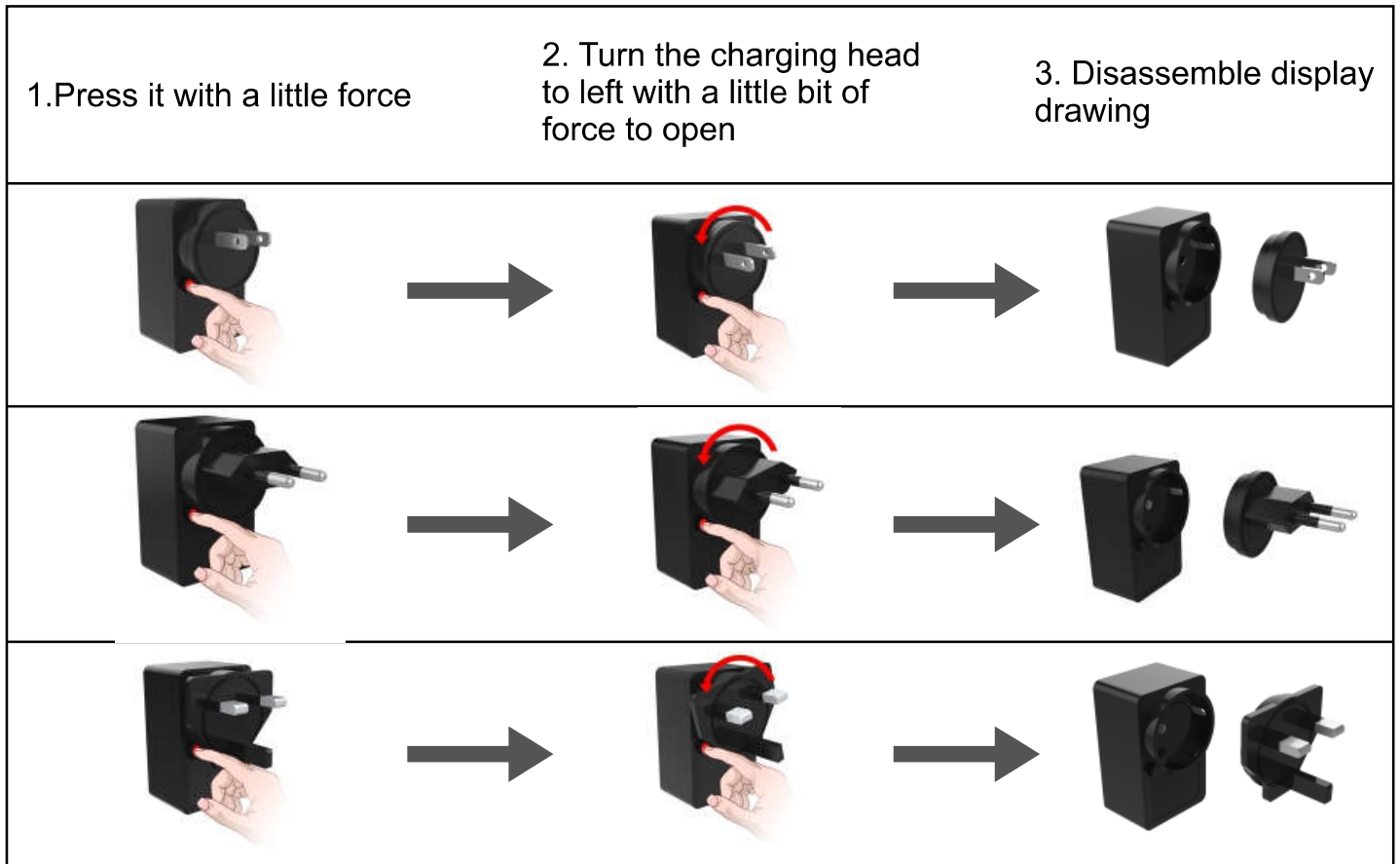

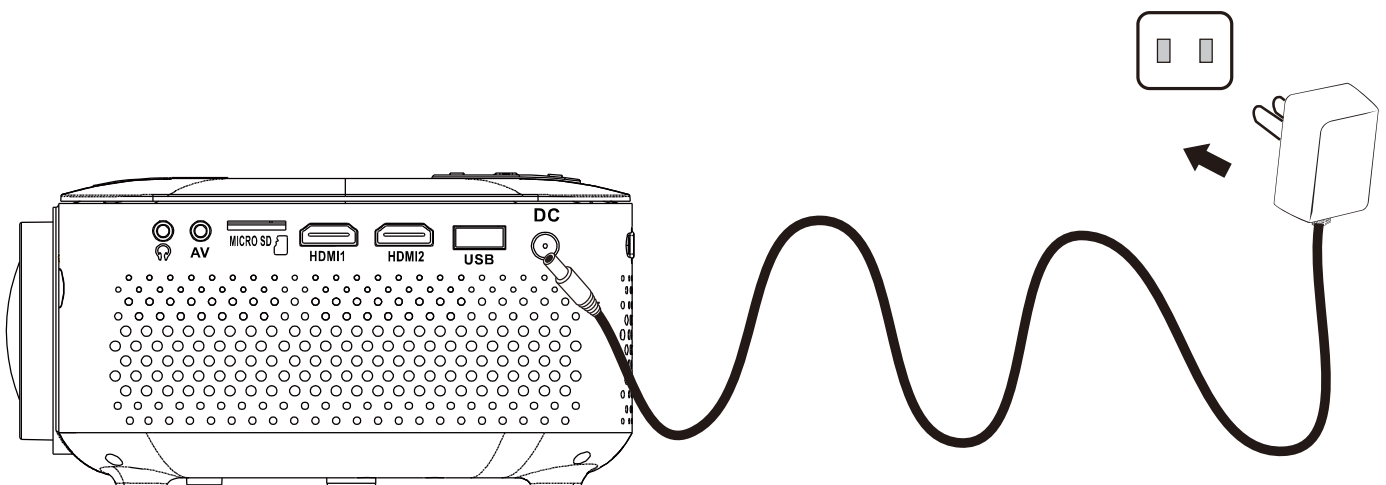

# Install Power Adapter

Follow below picture to connect power adapter.  
Connect small end of adapter **FIRST**. Plug the adapter body to power outlet.



## Connect HDMI

Follow below picture to connect HDMI cable and device.

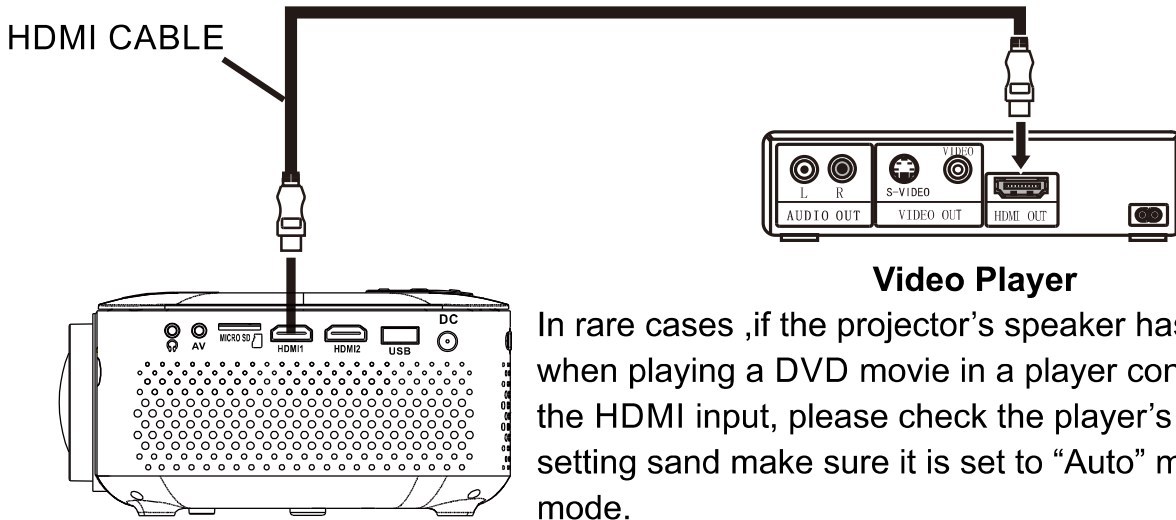

1. Turn off the unit before connect HDMI cable.
2. After connect, press the  button to turn on unit and power indicator will light green.
3. Press the  /SOURCE button to HDMI mode and the video of HDMI device will show on projector screen. There are 2 HDMI input, HDMI1 interface corresponds to HDMI1 in **SOURCE** mode, and HDMI2 interface corresponds to HDMI2 in **SOURCE** mode.

**HDMI HD signal input: this interface can be input with HD player  
HDMI output at the connection**



## Connect AV

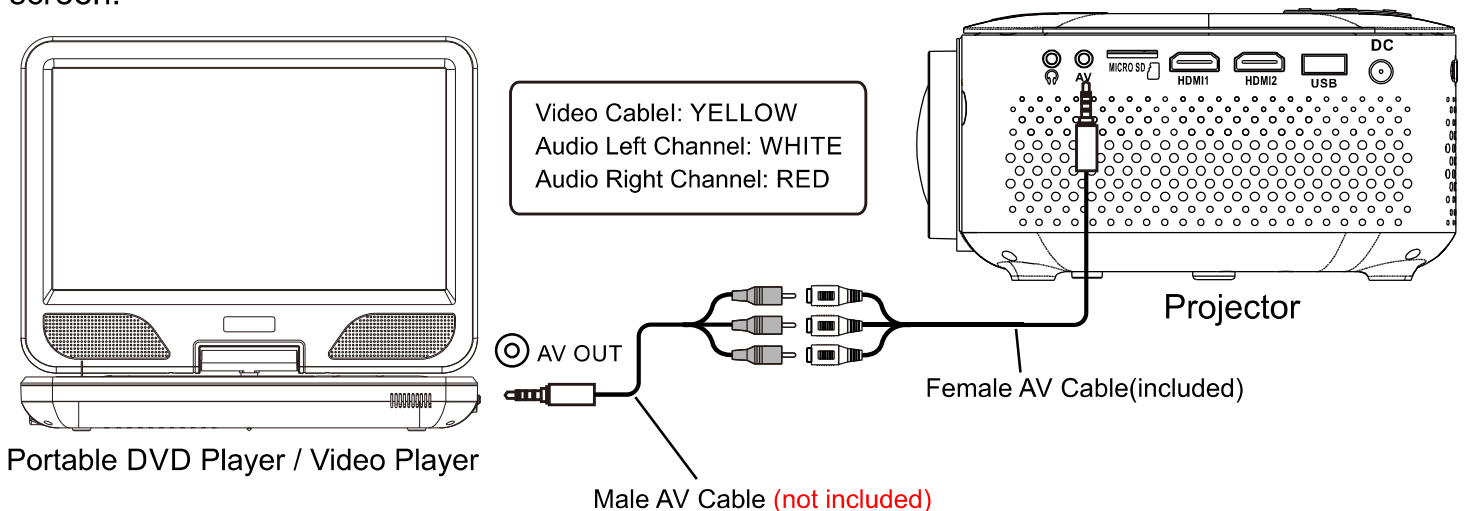

Follow below picture to connect AV cable and device.

1. Turn off the unit before connect AV cable.
2. Connect the end of 3 heads for both Female AV cable and Male AV cable together first, and then connect the other ends of Female cable to the AV IN of projector. Similarly, connect the other ends of male AV cable to the AV OUT of the DVD player or other Electronic device which supported AV out.
3. After connect, press the  button to turn on unit and power indicator will light green.
4. Press the  /SOURCE button to AV mode and the video of AV device will show on projector screen.



# Connect VGA

Follow below picture to connect VGA cable and device.

1. Turn off the unit before connect VGA cable.
2. Press the  button to turn off power of your projector before connection.
3. After connect, press the  button to turn on unit and power indicator will light green.
4. Press the  /SOURCE button to VGA mode and the video of VGA device will show on projector screen.

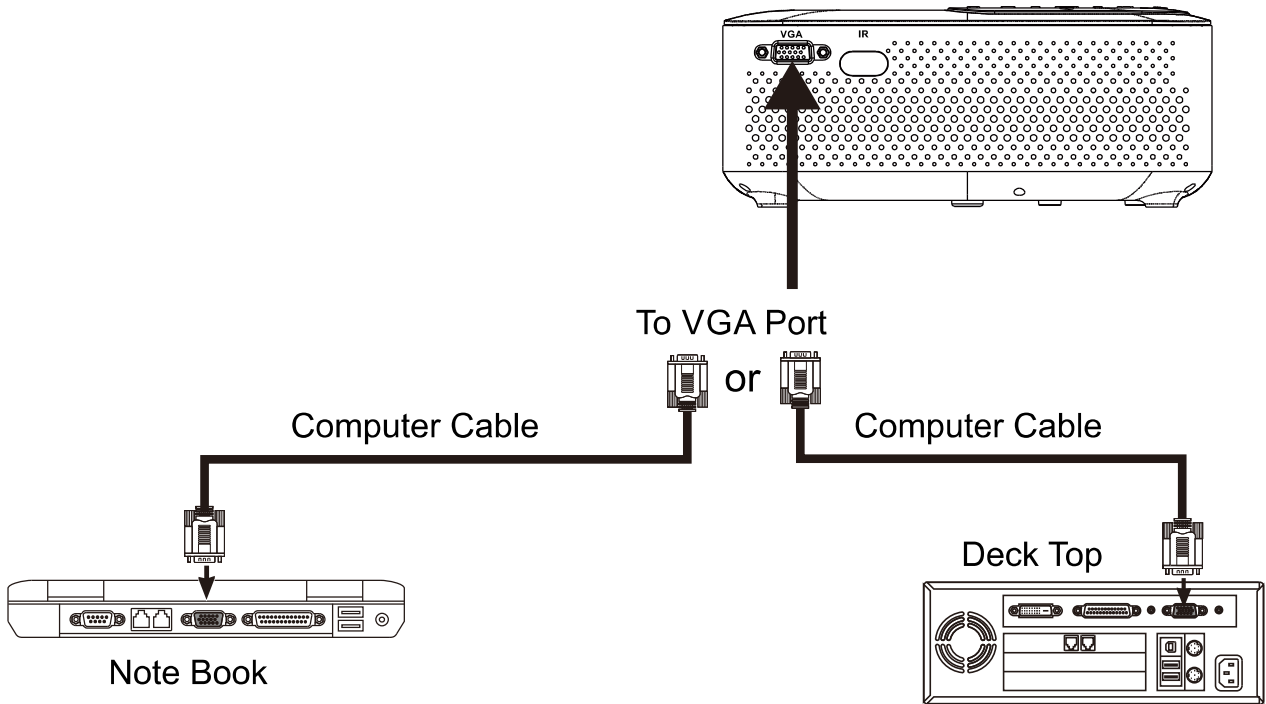

Please refer to the following table to adjust the output signal from computer.

Type	Resolution		Frequency	Field Frequency
PC	VGA	640x480	31.5	60
			34.7	70
			37.9	72
			37.5	75
	SVGA	800x600	31.4	50
			35.1	56
			37.9	60
			46.6	70
			48.1	72
			46.9	75
	XGA	1024x768	40.3	50
			48.4	60
56.5			70	



## Connect Audio Output (Aux Out / Line Out / Earphones)

Follow below picture to connect AUDIO cable and device.

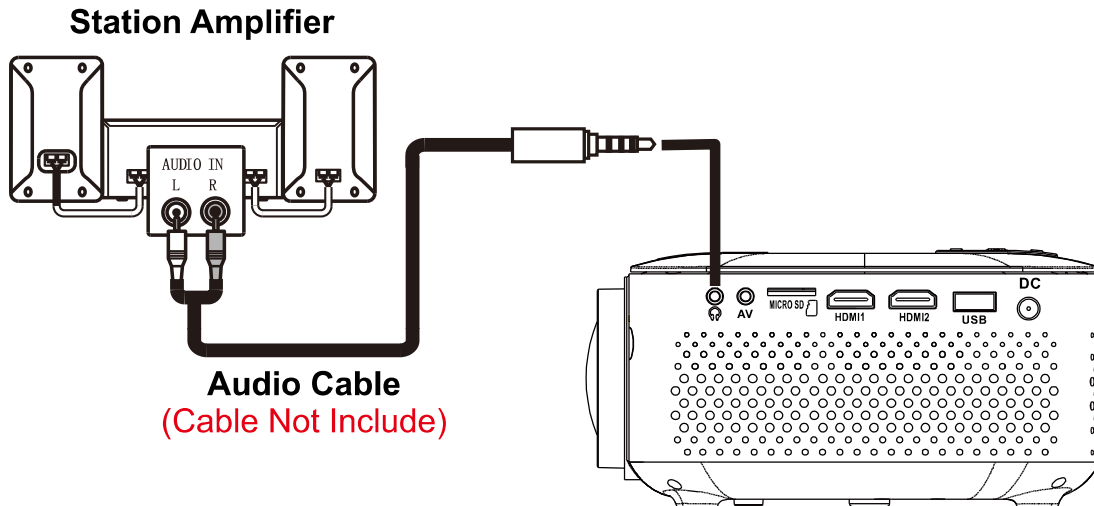
1. Press the  button to turn off power of your projector before connection.
2. Use audio cable to connect follow below figure.
3. After connect and turn on both units. Your projector sound from external device now.
4. After using, turn off both unit.



## Using USB & Micro SD Card Playback

- 1: Insert the USB/Micro SD card into USB port before turn on device;
- 2: Turn on device by pressing the  button;
- 3: Click the “Media” on the home page;
- 4: Choose the file you want to open by  button, and press  button to access it. There are 4 sub-menu (Movie, Music, Photo, Text) on page after access the Media. Please choose correct sub-menu before playing, or it is not able to play.

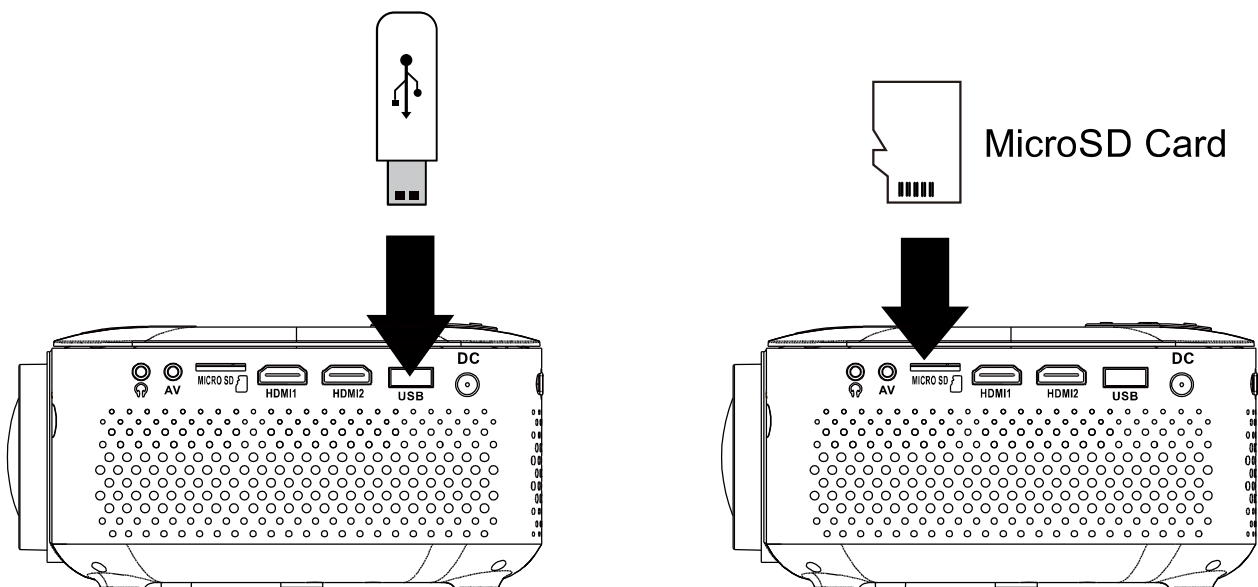

## Settings of playing video on Media / HDMI / VGA / AV

When you playing videos from the Media / HDMI / VGA/ AV, press “Menu” button to enter the setting options like following showed:

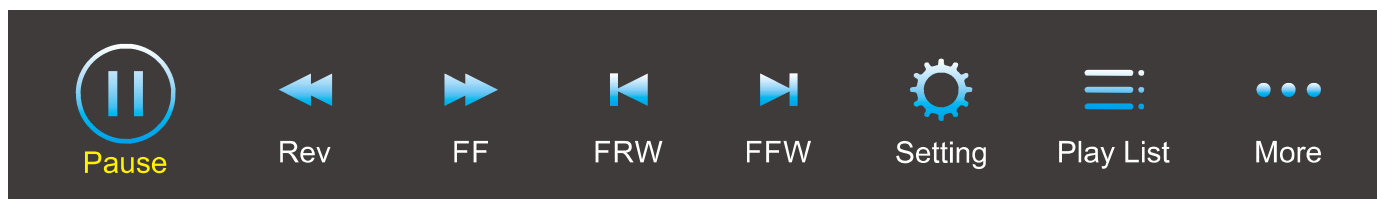

Parameter	Option	
Play/Pause	Press to play or pause a individual chapter or track	
Rev	Reverse: X1, X2, X4, X8, X16	
FF	Fast Forward: X1, X2, X4, X8, X16	
FRW	Press to play previous video	
FFW	Press to play next video	
Setting	Image Mode	Standard/ Soft/ Vivid/ User
	Aspect Ratio	Auto/ 16:9/ 4:3
	Brightness	0-100
	Contrast	0-100
	Color	0-100
	Sharpness	0-100
	Digital Zoom	60-100
	Sound Mode	Standard/ Music/ News/ Theater
Play List	Press to open the playing list	
More	Subtitle	1/1, Off
	Audio	1/10 - 10/10
	Repeat	Random, Sequence, Single, List



## Setting of playing Picture on Media / HDMI / VGA / AV

When you playing Pictures from the Media / HDMI / VGA/ AV, press “Menu” button to enter the setting options like following showed:

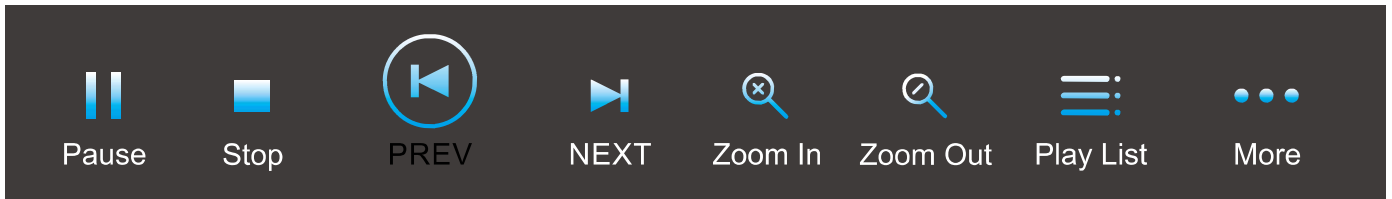

Parameter	Option	
Play/Pause	Press to play or pause a individual chapter or track	
Stop	Press to stop playback and return to the root menu	
PREV	Press to play previous picture	
NEXT	Press to play next picture	
Zoom In	Press to zoom in the picture	
Zoom Out	Press to zoom out the picture	
Play List	Press to open the playing list	
More	Repeat Mode	Random, Sequence, Single, List
	Slide Time	5s, 10s, 20s, 30s
	Rotation	Normal, 90 Degree, 180 Degree, 270 Degree

**Note:** It will automatically enter “Play” mode when you open the picture, please manually switch to "Pause" if you want to stop the automatic playback.

# Using Bluetooth playback

## Pairing to Bluetooth Wireless Speakers or Sound Bar

**NOTE: Bluetooth is OFF by default when the projector first powers ON.**

**Bluetooth can be turned ON or OFF from the OPTIONS Menu.**

1. Enable Bluetooth on the receiver (external speakers, sound bar, etc.) to which you wish to connect. Devices such as smartphones, tablets, or computers are not Bluetooth receivers and will not connect to the projector. To eliminate confusion, you should disable Bluetooth on all receivers to which you do not wish to connect.
2. Power on the projector and make sure the projector's Bluetooth is ON (see note above). The projector will begin searching for near by Bluetooth devices to connect to, the Bluetooth devices will be shown on the screen, select it and press the OK key to connect it.
3. When successfully paired, the Bluetooth receiver should indicate it is connected, usually with a chime or other audible noise. Check the user manual on your Bluetooth receiver for more information.
4. When successfully connected, the projector will display the Bluetooth receiver's name on the top right portion of the Main Menu screen, and sound played from the projector will be heard through the Bluetooth receiver.

After initial pairing, the projector and the Bluetooth speakers will stay paired unless unpaired manually by the user, or erased due to a reset of either device. If this occurs, or you find either unit is unable to connect, repeat the above steps.

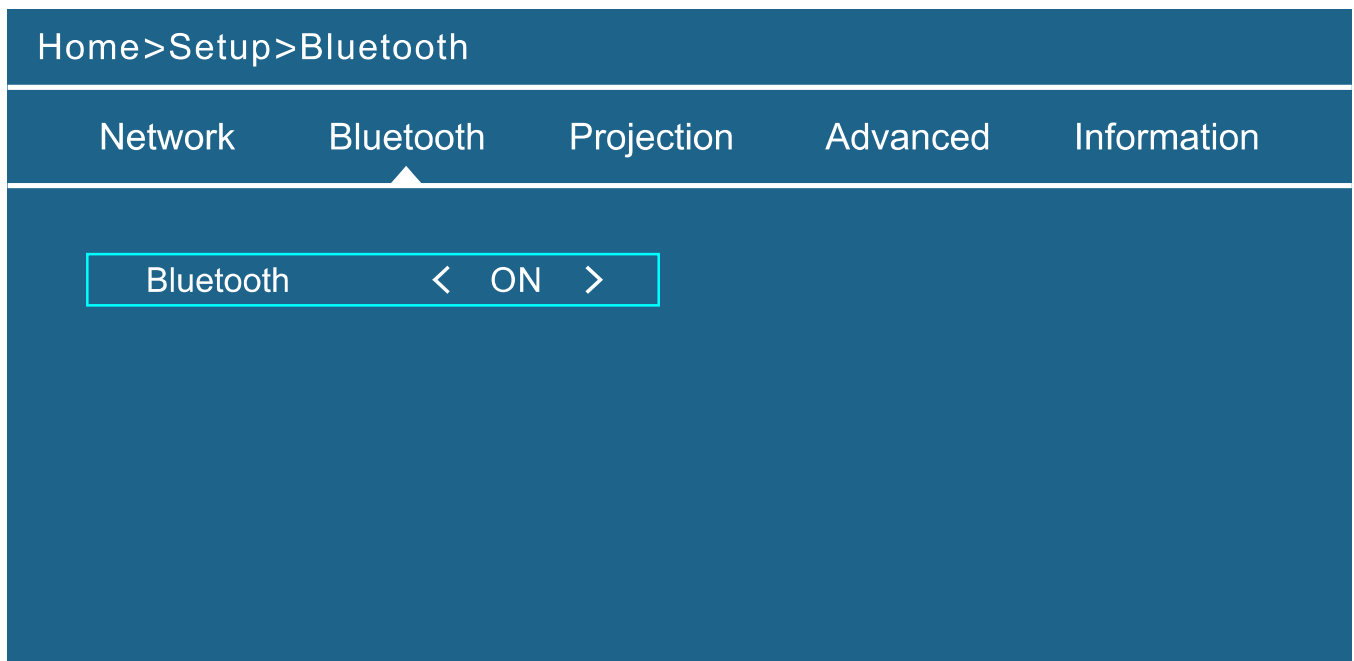

# WIFI Connection and IOS Cast

For IOS device, considering there are two different operating environments :

- 1) Under an WI-FI environment
- 2) Under without WI-FI environment.

Here please kindly check your wireless environment first and then connect your device with correct way per below introduction.

## A: IOS device under without WI-FI environment ( Recommend )

Step1: Open your projector and iphone.

Step2: open your iphone's wifi function and connect with this projector in searched wifi list.

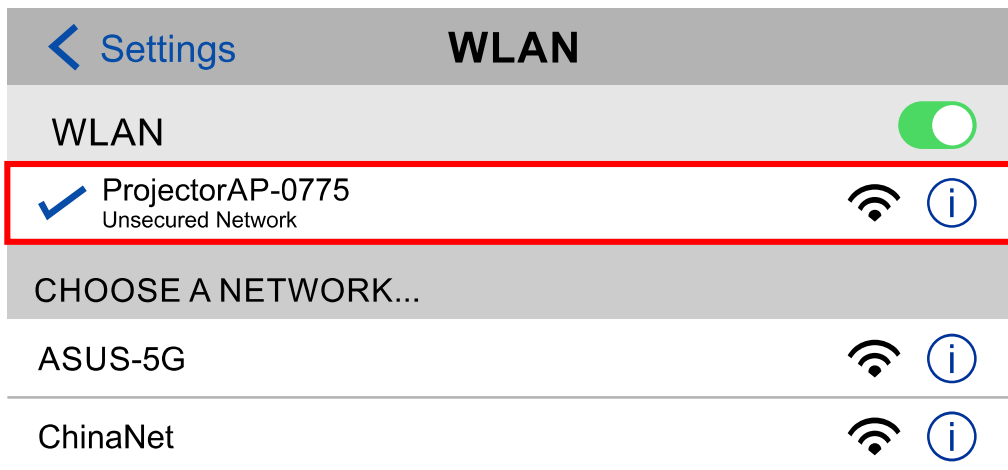

Step3: Access the Home page of projector by remote control and enter "iOS Cast"

Step4: Open the control center of IOS device, choose "Screen Mirroring"

Step5: choose the name of the projector device to match to enjoy the same screen interaction .

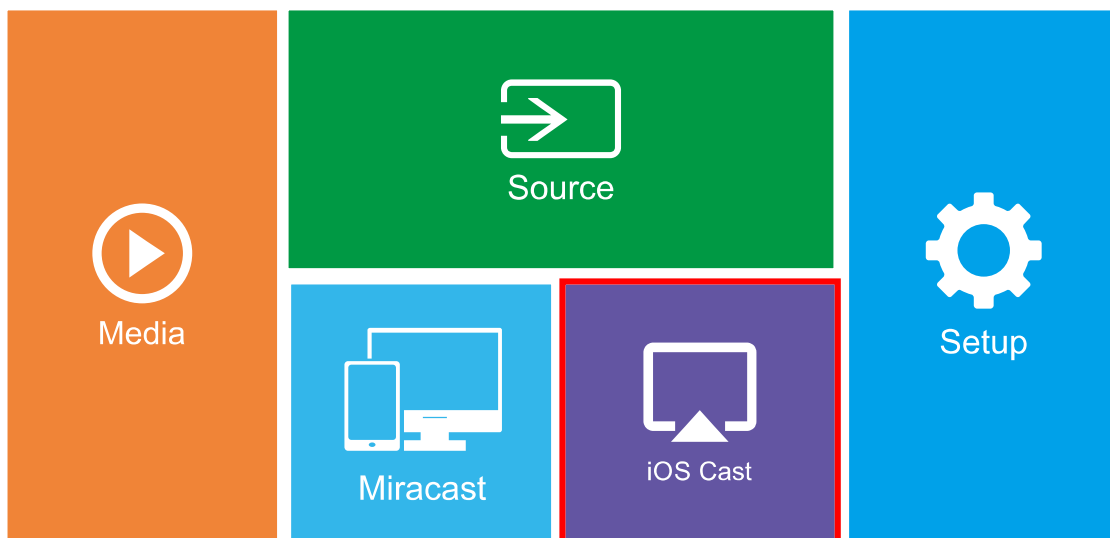

## Mirror your iPhone,iPad or iPod touch

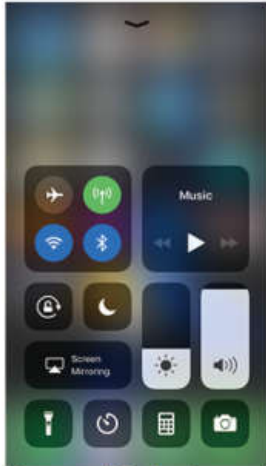

1 .On your iOS device, open Control Center and tap Screen Mirroring.



2. Looking for devices that can be mirrored on.



3. Select ZYCast-xxxx from the list.

### **B: IOS device under WI-FI Environment:**

Step1:Turn on your projector, Choose "Setup" on the right of interface, then find "Network".

Step2: Find "WiFi".

Step3: Choose "Scan". Select your wireless network from list and type in the password.

Step4: Confirm WI-FI connection

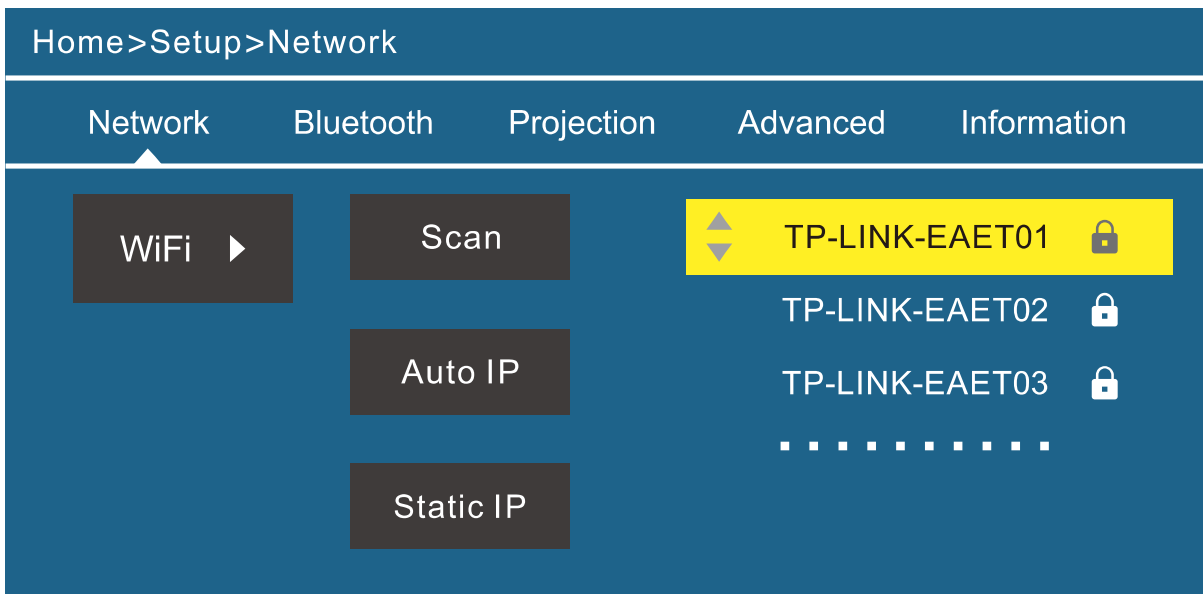

Step 5: Return to the Home page of projector by remote control and enter "iOS Cast"  
(Attention: please make sure that your ios device is connected to the same network as your projector before this step)

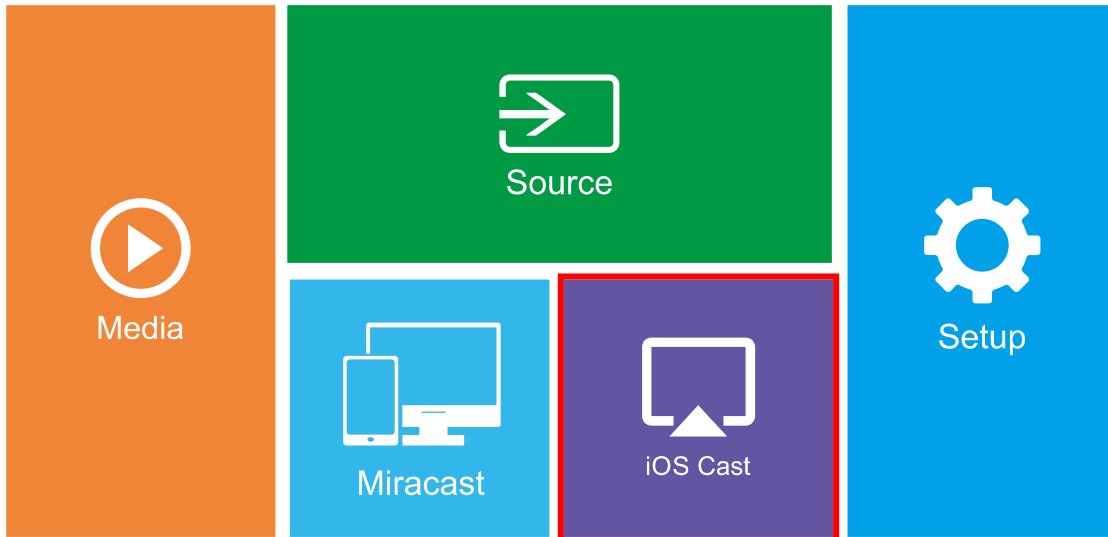

Step6: Open the control center of IOS device, choose “Screen Mirroring”

Step7: Choose the name of the projector device to match to enjoy the same screen interaction.

### Mirror your iPhone,iPad or iPod touch

Make sure that your iOS device is connected to the same network as your Projector

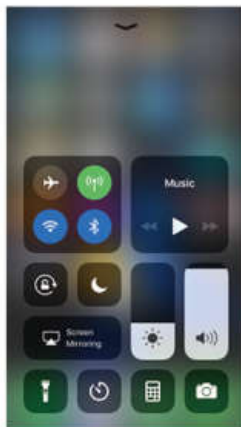

1 .On your iOS device, open Control Center and tap Screen Mirroring.



2. Looking for devices that can be mirrored on.



3. Select ZYCast-xxxx from the list.

# Miracast

Step1: Turn on the projector , select the Miracast of the home page.

Step2: Open the “Wireless Display”function of Android Device.

Step3: Select this projector from searched Android device to connect it.

Step4: Starting to enjoy your Sharing time.

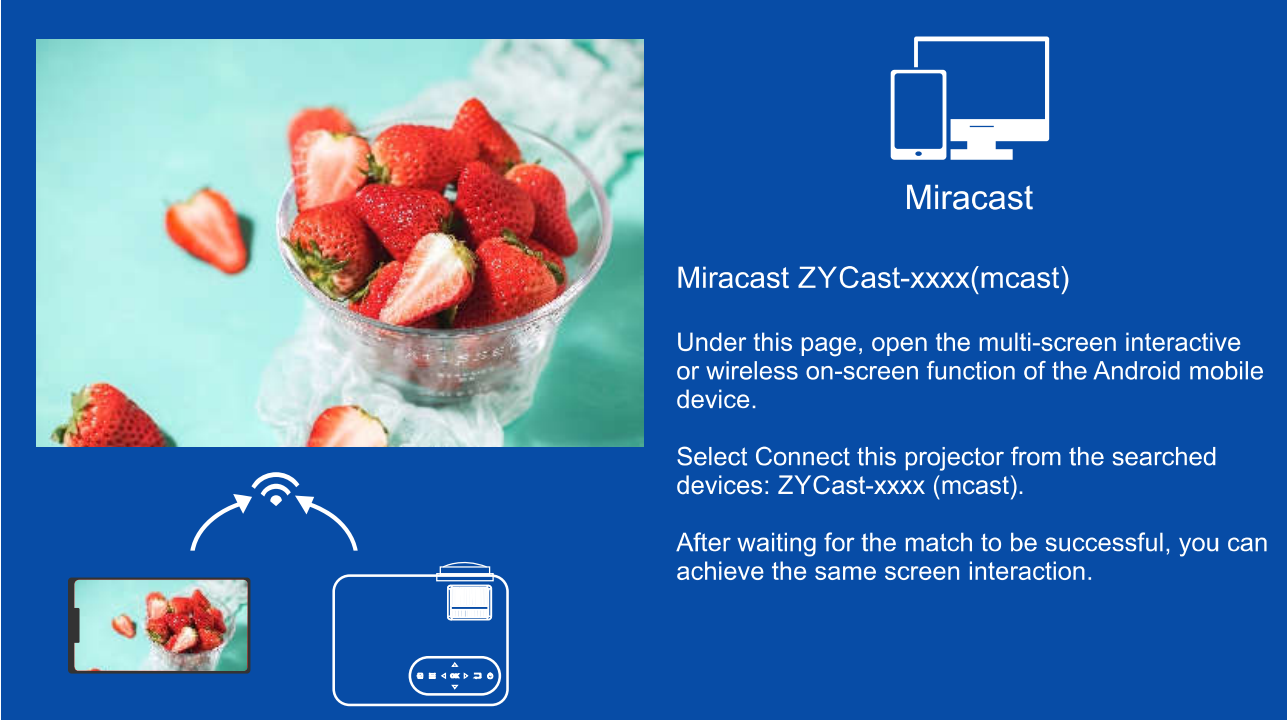

The diagram shows a blue background. On the left, there is a photograph of a glass bowl filled with fresh strawberries on a light blue surface. Below this photo, a white Wi-Fi symbol is connected by curved arrows to a white icon of a projector. To the right of the projector icon is a white icon of a smartphone displaying the same strawberry image. Above the projector icon, the word "Miracast" is written in white. Below the "Miracast" icon, the text "Miracast ZYCast-xxxx(mcast)" is displayed. Further down, there are two paragraphs of white text explaining the process: "Under this page, open the multi-screen interactive or wireless on-screen function of the Android mobile device." and "Select Connect this projector from the searched devices: ZYCast-xxxx (mcast).". The final paragraph states: "After waiting for the match to be successful, you can achieve the same screen interaction."

## Notice:

1. Please open the WIFI function of your Android phone/pad, but do not connect to any Wifi network. Otherwise, it may cause the picture flickers when the WIFI speed in your home is not fast enough.
2. Different android devices have different names for the Wireless display, such as Screen mirroring, Screen sharing, Multi-Screen etc.

## Specifications

Light Source Type	LED
Display Native Resolution	1280 x 720
HDMI Input Supported Video Resolution.	1080p.1080i . 720p, 576i , 480p, and 480i
Power Consumption	Operating 48W ; Stand by 0.8W
Power Input Connect Included Adapter	DC 12V 3.5A
Included Adapter Connect DC input of unit	Input AC100-240V, 50/60Hz Output DC12V ,3.5A
Display Color	7000-8000K
Signal Port	Video/ VGA/ HDMI
USB Port	Support USB device up to 32GB Support format MPEG1. MPEG2 .MPEG4. MP3. JPEG
SD Card	Support SD card up to 32GB Support format MPEG1. MPEG2 .MPEG4. MP3. JPEG
Weight	0.9KG
Dimension	203x 150x 82 mm

Ideal for dark viewing environments for optimal performance .

## Troubleshooting

Before resorting the maintenance service, please kindly check by yourself with the following chart.

<p>No Image is Projected or a "No Signal" message is displayed</p>	<ol style="list-style-type: none"> <li>1. Is the power high on? If it is not on, check the projector is plugged into the mains, that the socket is switched on, and then press the power button on the projector.</li> <li>2. Check the lens cover has been removed.</li> <li>3. Check the cables are securely attached and installed as per the User Manual.</li> <li>4. The image source may not be set correctly. Press the Source button on the Control Panel or the Remote, to select the correct setting.</li> <li>5. Check in the Menu section under Video input signal to make sure that has been set correctly.</li> </ol>
<p>The Lamp (Bulb) switches off after a period of time</p>	<ol style="list-style-type: none"> <li>1. Leave the projector to cool for a few moments.</li> <li>2. Once cooled, check if anything is blocking the ventilation vents.</li> <li>3. Turn on the projector</li> </ol> <p>If the issue persists please contact your support provider for further assistance.</p>
<p>The Image is wider at the top/bottom of the screen</p>	<p>This is called keystone and is due to the projection angle not being perpendicular to the screen. To correct use the projectors inbuilt keystone function to adjust the image.</p>
<p>Spots on the screen</p>	<p>Using a vacuum cleaner to dean the lens. If cleaning doesn't resolve things, please contact your support provider for further assistance.</p>
<p>The image brightness has faded</p>	<p>This could possible be caused by the ambient light in the room. If not ,the chances are that you need to replace the lamp. (bulb).</p>
<p>Bluetooth not work</p>	<p>Please note the Bluetooth function is not support to connect with smart phone or pad etc. If the Bluetooth speaker or earphone is not able to connect, please contact our customer service, we will help solving soon.</p>

## Warranty

Should you experience any problems not covered by the FAQ, please don't hesitate to email us at:

United States customer service: [US-projector@fangor.cn](mailto:US-projector@fangor.cn)

Europe customer service: [eu-projector@fangor.cn](mailto:eu-projector@fangor.cn)

Japan customer service: [JP-projector@fangor.cn](mailto:JP-projector@fangor.cn)

We will offer solutions to your issues or a direct replacement/refund without delays