

## TEST REPORT

**Product** : Unified communications Speakerphone  
**Trade mark** : VHD  
**Model/Type reference** : VHD-M300, M300  
**Serial Number** : N/A  
**Report Number** : EED32M00308702  
**FCC ID** : 2ATFO-M300  
**Date of Issue** : Nov. 26, 2020  
**Test Standards** : 47 CFR Part 15 Subpart C  
**Test result** : PASS

Prepared for:

**ValueHD Corporation**

**3/F, No.2, Honghui Industrial Park, Xin'an Street,  
Bao'an District, Shenzhen, China**

Prepared by:

**Centre Testing International Group Co., Ltd.  
Hongwei Industrial Zone, Bao'an 70 District,  
Shenzhen, Guangdong, China**

**TEL: +86-755-3368 3668**

**FAX: +86-755-3368 3385**

Compiled by:

*Sunlight Sun*

Sunlight Sun

Reviewed by:

*Tom chen*

Tom chen

Approved by:

*Aaron Ma*

Aaron Ma

Date:

Nov. 26, 2020



Check No.:4762161569

## 2 Version

Version No.	Date	Description
00	Nov. 26, 2020	Original

### 3 Test Summary

Test Item	Test Requirement	Test method	Result
Antenna Requirement	47 CFR Part 15 Subpart C Section 15.203/15.247 (c)	ANSI C63.10-2013	PASS
AC Power Line Conducted Emission	47 CFR Part 15 Subpart C Section 15.207	ANSI C63.10-2013	PASS
Conducted Peak Output Power	47 CFR Part 15 Subpart C Section 15.247 (b)(3)	ANSI C63.10-2013	PASS
6dB Occupied Bandwidth	47 CFR Part 15 Subpart C Section 15.247 (a)(2)	ANSI C63.10-2013	PASS
Power Spectral Density	47 CFR Part 15 Subpart C Section 15.247 (e)	ANSI C63.10-2013	PASS
Band-edge for RF Conducted Emissions	47 CFR Part 15 Subpart C Section 15.247(d)	ANSI C63.10-2013	PASS
RF Conducted Spurious Emissions	47 CFR Part 15 Subpart C Section 15.247(d)	ANSI C63.10-2013	PASS
Radiated Spurious Emissions	47 CFR Part 15 Subpart C Section 15.205/15.209	ANSI C63.10-2013	PASS
Restricted bands around fundamental frequency (Radiated Emission)	47 CFR Part 15 Subpart C Section 15.205/15.209	ANSI C63.10-2013	PASS

**Remark:**

Test according to ANSI C63.4-2014 & ANSI C63.10-2013.

Company Name and Address shown on Report, the sample(s) and sample Information was/ were provided by the applicant who should be responsible for the authenticity which CTI hasn't verified.

Model No.:VHD-M300, M300

Only the model VHD-M300 was tested, since the electrical circuit design, layout, components used and internal wiring were identical for the above models, with difference being sales area, customer base and model name.

## 4 Content

<b>1 COVER PAGE</b> .....	<b>1</b>
<b>2 VERSION</b> .....	<b>2</b>
<b>3 TEST SUMMARY</b> .....	<b>3</b>
<b>4 CONTENT</b> .....	<b>4</b>
<b>5 TEST REQUIREMENT</b> .....	<b>5</b>
5.1 TEST SETUP.....	5
5.1.1 For Conducted test setup.....	5
5.1.2 For Radiated Emissions test setup.....	5
5.1.3 For Conducted Emissions test setup.....	6
5.2 TEST ENVIRONMENT.....	6
5.3 TEST CONDITION.....	6
<b>6 GENERAL INFORMATION</b> .....	<b>7</b>
6.1 CLIENT INFORMATION.....	7
6.2 GENERAL DESCRIPTION OF EUT.....	7
6.3 PRODUCT SPECIFICATION SUBJECTIVE TO THIS STANDARD.....	7
6.4 DESCRIPTION OF SUPPORT UNITS.....	9
6.5 TEST LOCATION.....	9
6.6 DEVIATION FROM STANDARDS.....	9
6.7 ABNORMALITIES FROM STANDARD CONDITIONS.....	9
6.8 OTHER INFORMATION REQUESTED BY THE CUSTOMER.....	9
6.9 MEASUREMENT UNCERTAINTY (95% CONFIDENCE LEVELS, $k=2$ ).....	10
<b>7 EQUIPMENT LIST</b> .....	<b>11</b>
<b>8 RADIO TECHNICAL REQUIREMENTS SPECIFICATION</b> .....	<b>14</b>
Duty Cycle.....	15
Appendix A): 6dB Occupied Bandwidth.....	17
Appendix B): Conducted Peak Output Power.....	21
Appendix C): Band-edge for RF Conducted Emissions.....	24
Appendix D): RF Conducted Spurious Emissions.....	26
Appendix E): Power Spectral Density.....	30
Appendix F): Antenna Requirement.....	33
Appendix G): AC Power Line Conducted Emission.....	34
Appendix H): Restricted bands around fundamental frequency (Radiated).....	37
Appendix I) Radiated Spurious Emissions.....	46
<b>PHOTOGRAPHS OF TEST SETUP</b> .....	<b>50</b>
<b>PHOTOGRAPHS OF EUT CONSTRUCTIONAL DETAILS</b> .....	<b>53</b>

## 5 Test Requirement

### 5.1 Test setup

#### 5.1.1 For Conducted test setup

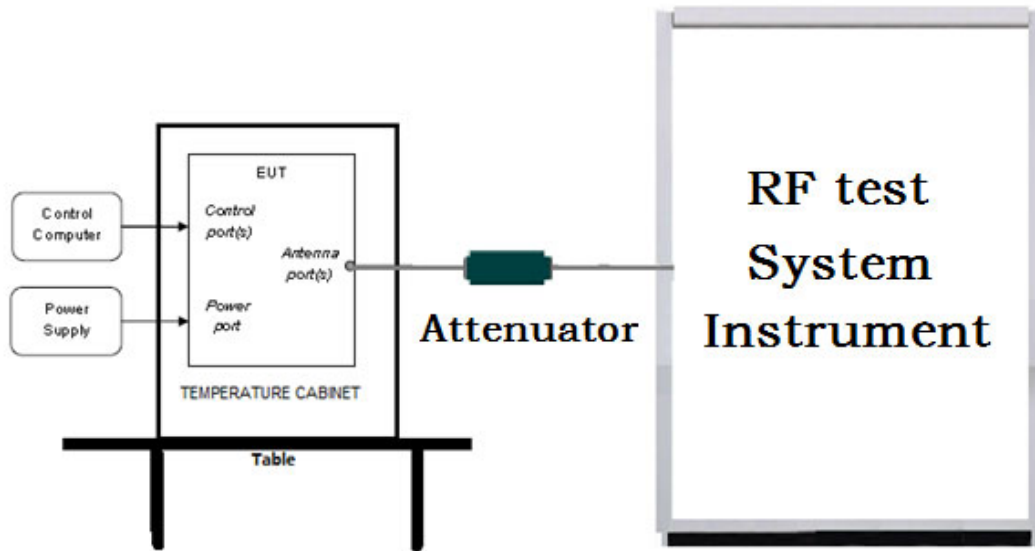

#### 5.1.2 For Radiated Emissions test setup

Radiated Emissions setup:

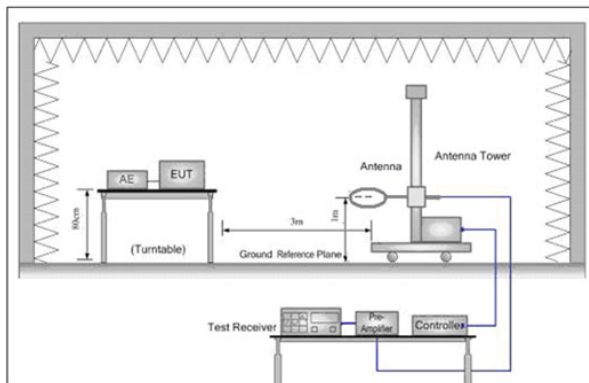

Figure 1. Below 30MHz

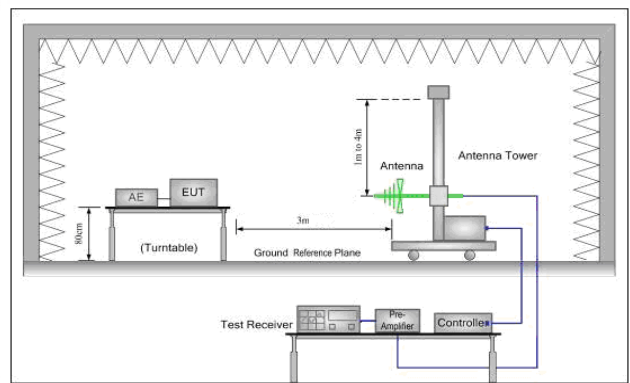

Figure 2. 30MHz to 1GHz

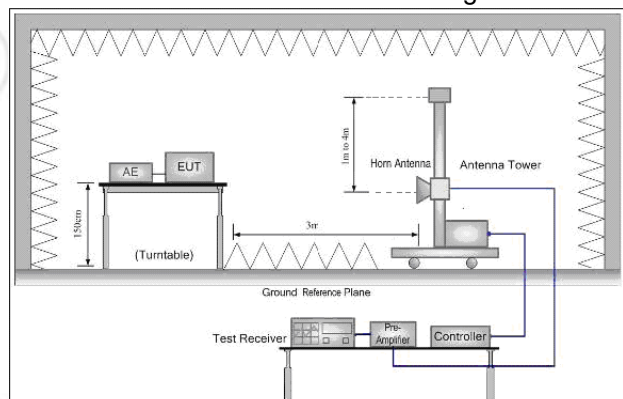
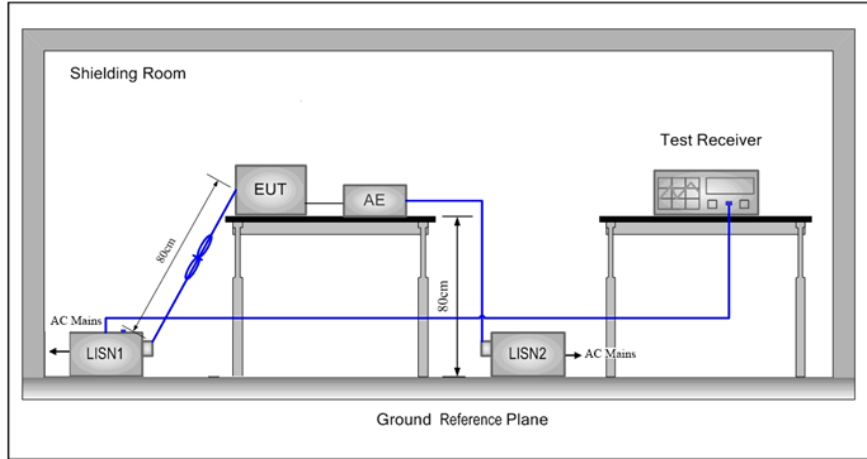

Figure 3. Above 1GHz

**5.1.3 For Conducted Emissions test setup  
Conducted Emissions setup**



**5.2 Test Environment**

<b>Operating Environment:</b>	
Temperature:	24 °C
Humidity:	55 % RH
Atmospheric Pressure:	1010mbar

**5.3 Test Condition**

Test channel:

Test Mode	Tx/Rx	RF Channel		
		Low(L)	Middle(M)	High(H)
GFSK	2402MHz ~2480 MHz	Channel 0	Channel 19	Channel 39
		2402MHz	2440MHz	2480MHz
Transmitting mode:	Keep the EUT in transmitting mode with all kind of modulation and all kind of data rate.			

## 6 General Information

### 6.1 Client Information

Applicant:	ValueHD Corporation
Address of Applicant:	3/F,No.2, Honghui Industrial Park, Xin'an Street, Bao'an District, Shenzhen, China
Manufacturer:	ValueHD Corporation
Address of Manufacturer:	3/F,No.2, Honghui Industrial Park, Xin'an Street, Bao'an District, Shenzhen, China
Factory:	ValueHD Corporation
Address of Factory:	3/F,No.2, Honghui Industrial Park, Xin'an Street, Bao'an District, Shenzhen, China

### 6.2 General Description of EUT

Product Name:	Unified communications Speakerphone	
Model No.(EUT):	VHD-M300, M300	
Test Model No.:	VHD-M300	
Trade mark:	VHD	
EUT Supports Radios application:	2402MHz to 2480MHz	
Power Supply:	DC 5V	
	Battery	Model: SUN-INTE-308 Capacity: 6500mAh 23.4Wh Nominal Voltage: 3.6V Limited Charge Voltage: 4.2V
Sample Received Date:	Sep. 27, 2020	
Sample tested Date:	Sep. 27, 2020 to Oct. 17, 2020	

### 6.3 Product Specification subjective to this standard

Operation Frequency:	2402MHz~2480MHz
Bluetooth Version:	BLE
Modulation Technique:	DSSS
Modulation Type:	GFSK
Number of Channel:	40
Test Power Grade:	Default
Test Software of EUT:	FCC.exe
Antenna Type and Gain:	Type: Internal antenna Gain: 2.93dBi
Test Voltage:	DC 5V

Operation Frequency each of channel							
Channel	Frequency	Channel	Frequency	Channel	Frequency	Channel	Frequency
0	2402MHz	10	2422MHz	20	2442MHz	30	2462MHz
1	2404MHz	11	2424MHz	21	2444MHz	31	2464MHz
2	2406MHz	12	2426MHz	22	2446MHz	32	2466MHz
3	2408MHz	13	2428MHz	23	2448MHz	33	2468MHz
4	2410MHz	14	2430MHz	24	2450MHz	34	2470MHz
5	2412MHz	15	2432MHz	25	2452MHz	35	2472MHz
6	2414MHz	16	2434MHz	26	2454MHz	36	2474MHz
7	2416MHz	17	2436MHz	27	2456MHz	37	2476MHz
8	2418MHz	18	2438MHz	28	2458MHz	38	2478MHz
9	2420MHz	19	2440MHz	29	2460MHz	39	2480MHz



#### 6.4 Description of Support Units

The EUT has been tested with associated equipment below.

Associated equipment name		Manufacture	model	S/N serial number	Supplied by	Certification
AE1	Power Supply Unit	OPPO	Ak993JH	J51642000007	CTI	FCC

#### 6.5 Test Location

All tests were performed at:

Centre Testing International Group Co., Ltd

Building C, Hongwei Industrial Park Block 70, Bao'an District, Shenzhen, China

Telephone: +86 (0) 755 33683668 Fax: +86 (0) 755 33683385

No tests were sub-contracted.

FCC Designation No.: CN1164

#### 6.6 Deviation from Standards

None.

#### 6.7 Abnormalities from Standard Conditions

None.

#### 6.8 Other Information Requested by the Customer

None.

**6.9 Measurement Uncertainty (95% confidence levels, k=2)**

No.	Item	Measurement Uncertainty
1	Radio Frequency	$7.9 \times 10^{-8}$
2	RF power, conducted	0.46dB (30MHz-1GHz)
		0.55dB (1GHz-18GHz)
3	Radiated Spurious emission test	4.3dB (30MHz-1GHz)
		4.5dB (1GHz-12.75GHz)
4	Conduction emission	3.5dB (9kHz to 150kHz)
		3.1dB (150kHz to 30MHz)
5	Temperature test	0.64°C
6	Humidity test	3.8%
7	DC power voltages	0.026%

## 7 Equipment List

RF test system					
Equipment	Manufacturer	Mode No.	Serial Number	Cal. Date (mm-dd-yyyy)	Cal. Due date (mm-dd-yyyy)
Spectrum Analyzer	Keysight	N9010A	MY54510339	02-17-2020	02-16-2021
Signal Generator	Keysight	N5182B	MY53051549	02-17-2020	02-16-2021
Temperature/ Humidity Indicator	biaozhi	HM10	1804186	06-29-2020	06-28-2021
High-pass filter	Sinoscite	FL3CX03WG18NM 12-0398-002	---	---	---
High-pass filter	MICRO-TRONICS	SPA-F-63029-4	---	---	---
DC Power	Keysight	E3642A	MY56376072	02-17-2020	02-16-2021
PC-1	Lenovo	R4960d	---	---	---
BT&WI-FI Automatic control	R&S	OSP120	101374	02-17-2020	02-16-2021
RF control unit	JS Tonscend	JS0806-2	158060006	02-17-2020	02-16-2021
BT&WI-FI Automatic test software	JS Tonscend	JS1120-3	---	---	---

Conducted disturbance Test					
Equipment	Manufacturer	Model No.	Serial Number	Cal. date (mm-dd-yyyy)	Cal. Due date (mm-dd-yyyy)
Receiver	R&S	ESCI	100435	04-28-2020	04-27-2021
Temperature/ Humidity Indicator	Defu	TH128	/	---	---
LISN	R&S	ENV216	100098	03-05-2020	03-04-2021
Barometer	changchun	DYM3	1188	---	---

3M full-anechoic Chamber					
Equipment	Manufacturer	Model No.	Serial Number	Cal. date (mm-dd-yyyy)	Cal. Due date (mm-dd-yyyy)
RSE Automatic test software	JS Tonscend	JS36-RSE	10166	---	---
Receiver	Keysight	N9038A	MY57290136	03-05-2020	03-04-2021
Spectrum Analyzer	Keysight	N9020B	MY57111112	03-05-2020	03-04-2021
Spectrum Analyzer	Keysight	N9030B	MY57140871	03-05-2020	03-04-2021
TRILOG Broadband Antenna	Schwarzbeck	VULB 9163	9163-1148	04-25-2018	04-24-2021
Horn Antenna	Schwarzbeck	BBHA 9170	9170-832	04-25-2018	04-24-2021
Horn Antenna	ETS-LINDGREN	3117	00057407	07-10-2018	07-09-2021
Preamplifier	EMCI	EMC184055SE	980597	05-20-2020	05-19-2021
Preamplifier	EMCI	EMC001330	980563	04-22-2020	04-21-2021
Preamplifier	JS Tonscend	980380	EMC051845 SE	01-09-2020	01-08-2021
Temperature/ Humidity Indicator	biaozhi	GM1360	EE1186631	04-27-2020	04-26-2021
Fully Anechoic Chamber	TDK	FAC-3	---	01-17-2018	01-16-2021
Filter bank	JS Tonscend	JS0806-F	188060094	04-10-2018	04-09-2021
Cable line	Times	SFT205-NMSM-2.50M	394812-0001	---	---
Cable line	Times	SFT205-NMSM-2.50M	394812-0002	---	---
Cable line	Times	SFT205-NMSM-2.50M	394812-0003	---	---
Cable line	Times	SFT205-NMSM-2.50M	393495-0001	---	---
Cable line	Times	EMC104-NMNM-1000	SN160710	---	---
Cable line	Times	SFT205-NMSM-3.00M	394813-0001	---	---
Cable line	Times	SFT205-NMNM-1.50M	381964-0001	---	---
Cable line	Times	SFT205-NMSM-7.00M	394815-0001	---	---
Cable line	Times	HF160-KMKM-3.00M	393493-0001	---	---

3M Semi/full-anechoic Chamber					
Equipment	Manufacturer	Model No.	Serial Number	Cal. date (mm-dd-yyyy)	Cal. Due date (mm-dd-yyyy)
3M Chamber & Accessory Equipment	TDK	SAC-3	---	05-24-2019	05-23-2022
TRILOG Broadband Antenna	Schwarzbeck	VULB9163	9163-618	05-16-2020	05-15-2021
Loop Antenna	Schwarzbeck	FMZB 1519B	1519B-076	04-25-2018	04-24-2021
Receiver	R&S	ESCI7	100938-003	10-21-2019	10-20-2020
Multi device Controller	maturo	NCD/070/10711 112	---	---	---
Temperature/ Humidity Indicator	Shanghai qixiang	HM10	1804298	06-29-2020	06-28-2021
Cable line	Fulai(7M)	SF106	5219/6A	---	---
Cable line	Fulai(6M)	SF106	5220/6A	---	---
Cable line	Fulai(3M)	SF106	5216/6A	---	---
Cable line	Fulai(3M)	SF106	5217/6A	---	---

## 8 Radio Technical Requirements Specification

### Reference documents for testing:

No.	Identity	Document Title
1	FCC Part15C	Subpart C-Intentional Radiators
2	ANSI C63.10-2013	American National Standard for Testing Unlicensed Wireless Devices

### Test Results List:

Test Requirement	Test method	Test item	Verdict	Note
Part15C Section 15.247 (a)(2)	ANSI C63.10	6dB Occupied Bandwidth	PASS	Appendix A)
Part15C Section 15.247 (b)(3)	ANSI C63.10	Conducted Peak Output Power	PASS	Appendix B)
Part15C Section 15.247(d)	ANSI C63.10	Band-edge for RF Conducted Emissions	PASS	Appendix C)
Part15C Section 15.247(d)	ANSI C63.10	RF Conducted Spurious Emissions	PASS	Appendix D)
Part15C Section 15.247 (e)	ANSI C63.10	Power Spectral Density	PASS	Appendix E)
Part15C Section 15.203/15.247 (c)	ANSI C63.10	Antenna Requirement	PASS	Appendix F)
Part15C Section 15.207	ANSI C63.10	AC Power Line Conducted Emission	PASS	Appendix G)
Part15C Section 15.205/15.209	ANSI C63.10	Restricted bands around fundamental frequency (Radiated Emission)	PASS	Appendix H)
Part15C Section 15.205/15.209	ANSI C63.10	Radiated Spurious Emissions	PASS	Appendix I)

**Duty Cycle Result Table**

Mode	Channel	Duty Cycle [%]	Limit	Verdict
BLE	LCH	94.41	---	PASS
BLE	MCH	94.79	---	PASS
BLE	HCH	94.9	---	PASS

**Test Graph**

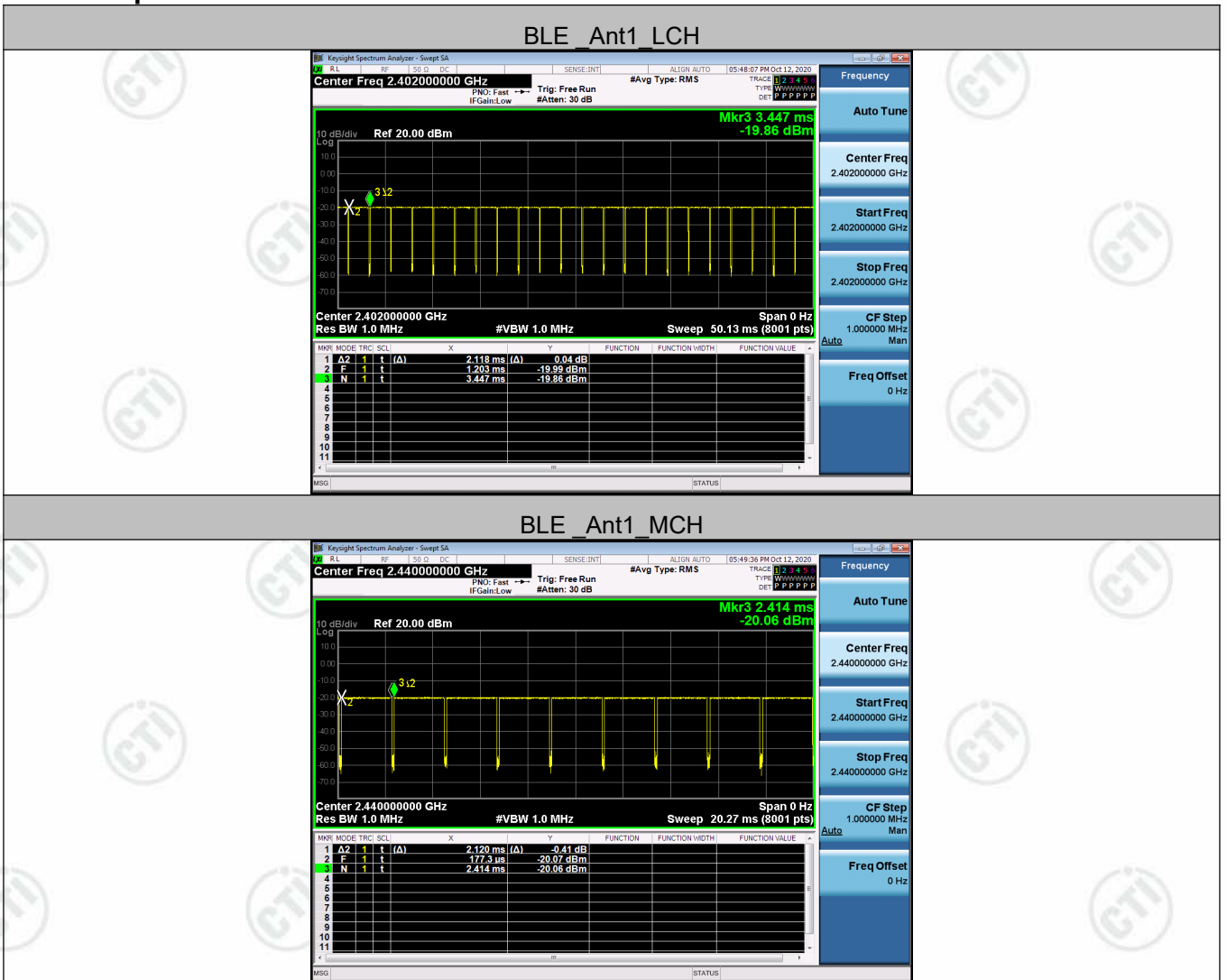

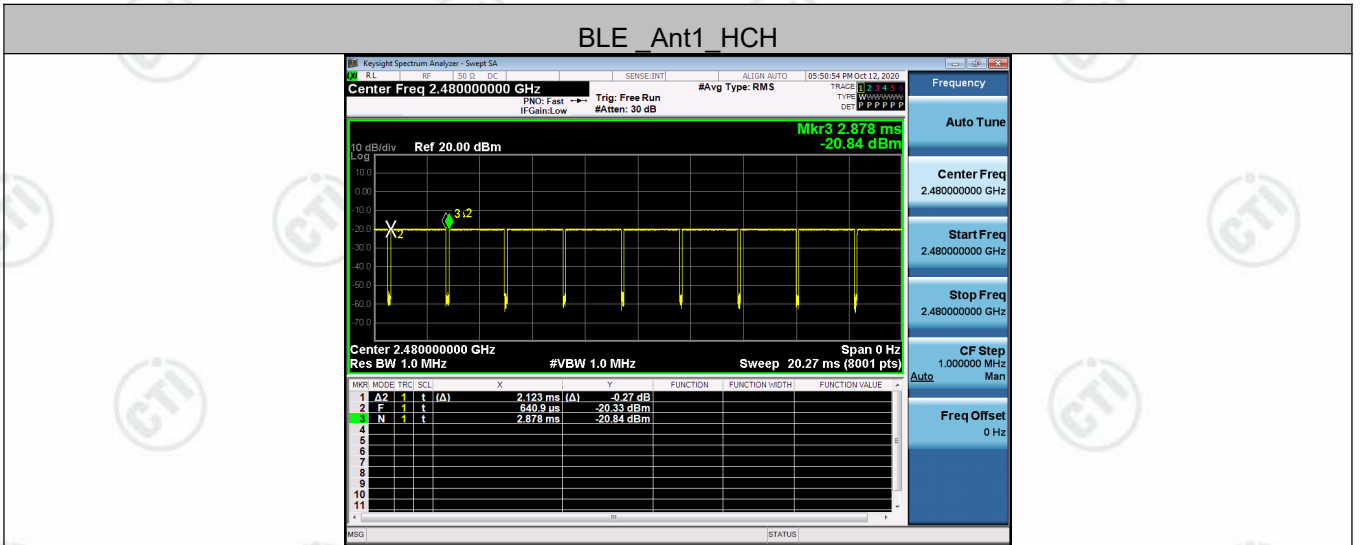



**Appendix A): 6dB Occupied Bandwidth**

**Test Limit**

According to §15.247(a)(2) and RSS-247 section 5.2(a)

**6 dB Bandwidth :**

Limit	Shall be at least 500kHz
-------	--------------------------

**Occupied Bandwidth(99%)** : For reporting purposes only.

**Test Procedure**

Test method Refer as KDB 558074 D01 v04, section 8.1 and ANSI 63.10:2013 clause 6.9.2 & 6.9.3.

1. The EUT RF output connected to the spectrum analyzer by RF cable.
2. Setting maximum power transmit of EUT
3. SA set RBW = 100kHz, VBW = 300kHz and Detector = Peak, to measurement 6 dB Bandwidth and 99% Bandwidth.
4. Measure and record the result of 6 dB Bandwidth and 99% Bandwidth. in the test report.

**Test Setup**

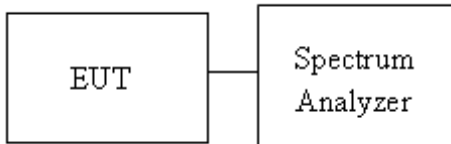

**Test Result**

Mode	Channel	6dB Bandwidth [MHz]	99% OBW[MHz]	Verdict
BLE	LCH	0.6959	1.0229	PASS
BLE	MCH	0.7064	1.0231	PASS
BLE	HCH	0.7088	1.0247	PASS

**Test Graphs**

**6 dB Bandwidth**

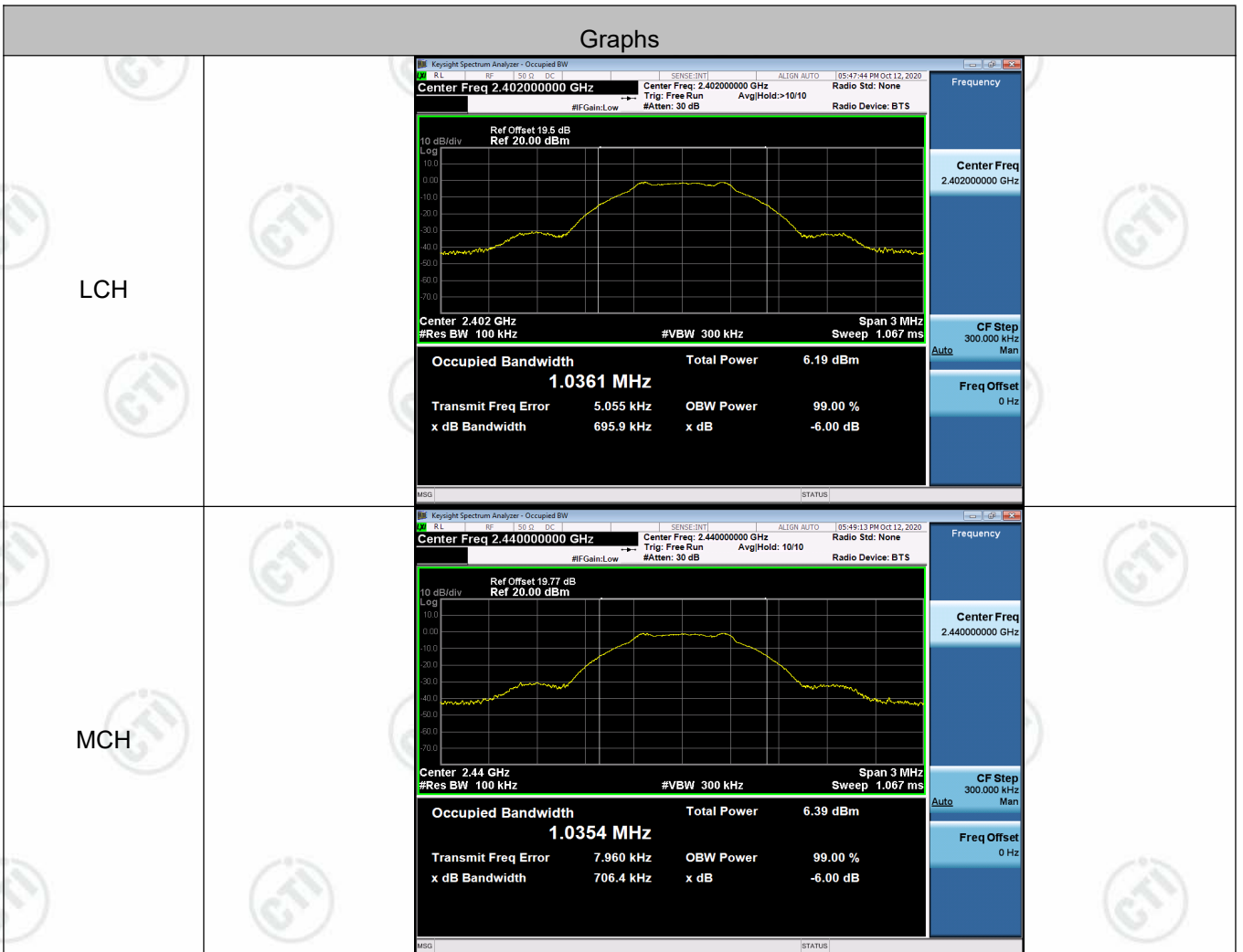

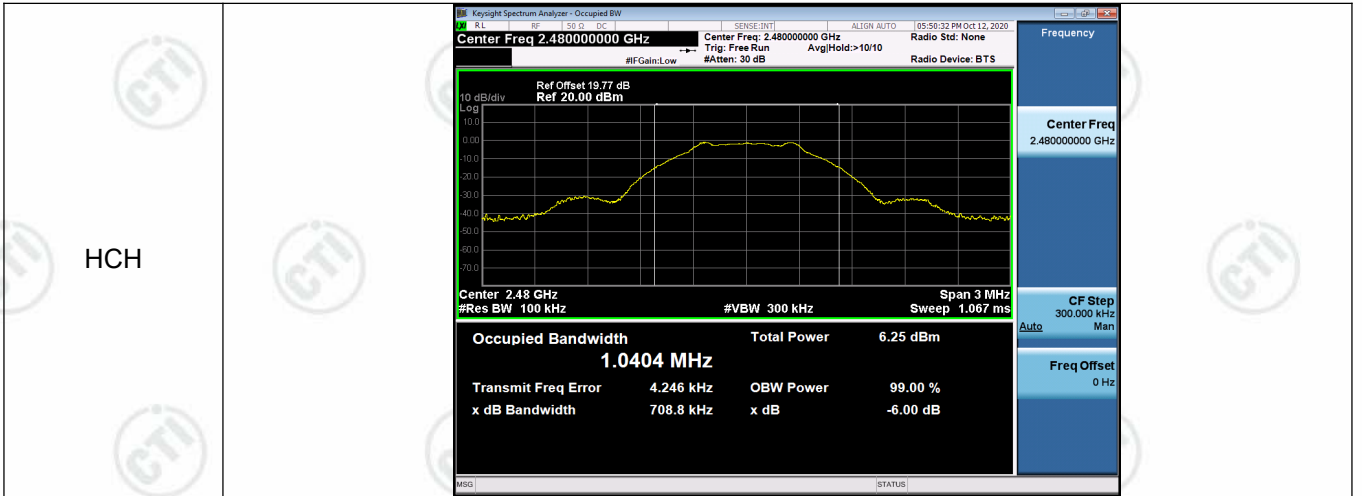

**Occupied Bandwidth(99%)**

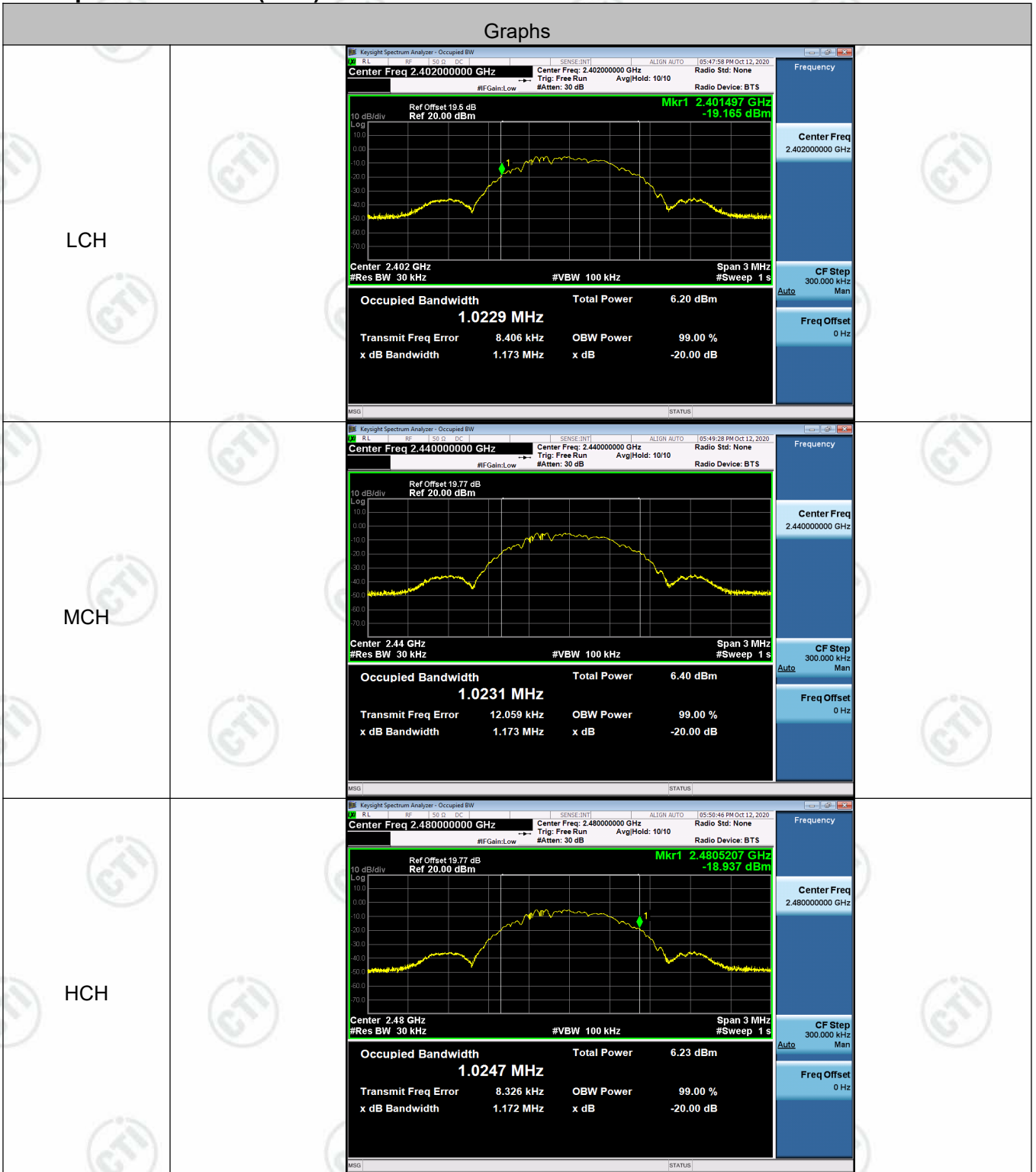

**Appendix B): Conducted Peak Output Power**

**Test Limit**

According to §15.247(b) and RSS-247 section 5.4(d)

**Peak output power**

For systems using digital modulation in the 2400-2483.5 MHz, and 5725-5850 MHz bands: 1 Watt(30 dBm), base on the use of antennas with directional gain not exceed 6 dBi If transmitting antennas of directional gain greater than 6dBi are used the peak output power the conducted output power from the intentional radiator shall be reduced by the amount in dB that the directional gain of the antenna exceeds 6 dBi. In case of point-to-point operation, the limit has to be reduced by 1dB for every 3 dB that the directional gain of the antenna exceeds 6 dBi.

Limit	<input checked="" type="checkbox"/> Antenna not exceed 6 dBi : 30dBm <input type="checkbox"/> Antenna with DG greater than 6 dBi [ Limit = 30 – (DG – 6) ] <input type="checkbox"/> Point-to-point operation
-------	---

**Test Procedure**

Test method Refer as KDB 558074 D01 v04, section 9.1.2.

1. The EUT RF output connected to spectrum analyzer by RF cable.
2. Setting maximum power transmit of EUT.
3. Spectrum analyzer settings are as follows:
  - a) Set the RBW ≥ DTS bandwidth.
  - b) Set VBW ≥ [3×RBW].
  - c) Set span ≥ [3×RBW].
  - d) Sweep time = auto couple.
  - e) Detector = peak.
  - f) Trace mode = max hold.
  - g) Allow trace to fully stabilize.
  - h) Use peak marker function to determine the peak amplitude level
4. Measure and record the result in the test report.

**Test Setup**

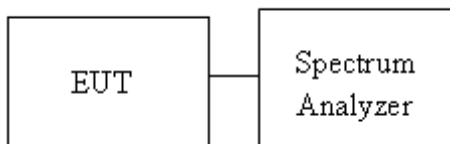

**Test Result**

Mode	Channel	Conduct Peak Power[dBm]	Verdict
BLE	LCH	-0.146	PASS
BLE	MCH	0.054	PASS
BLE	HCH	-0.063	PASS

**Test Graphs**

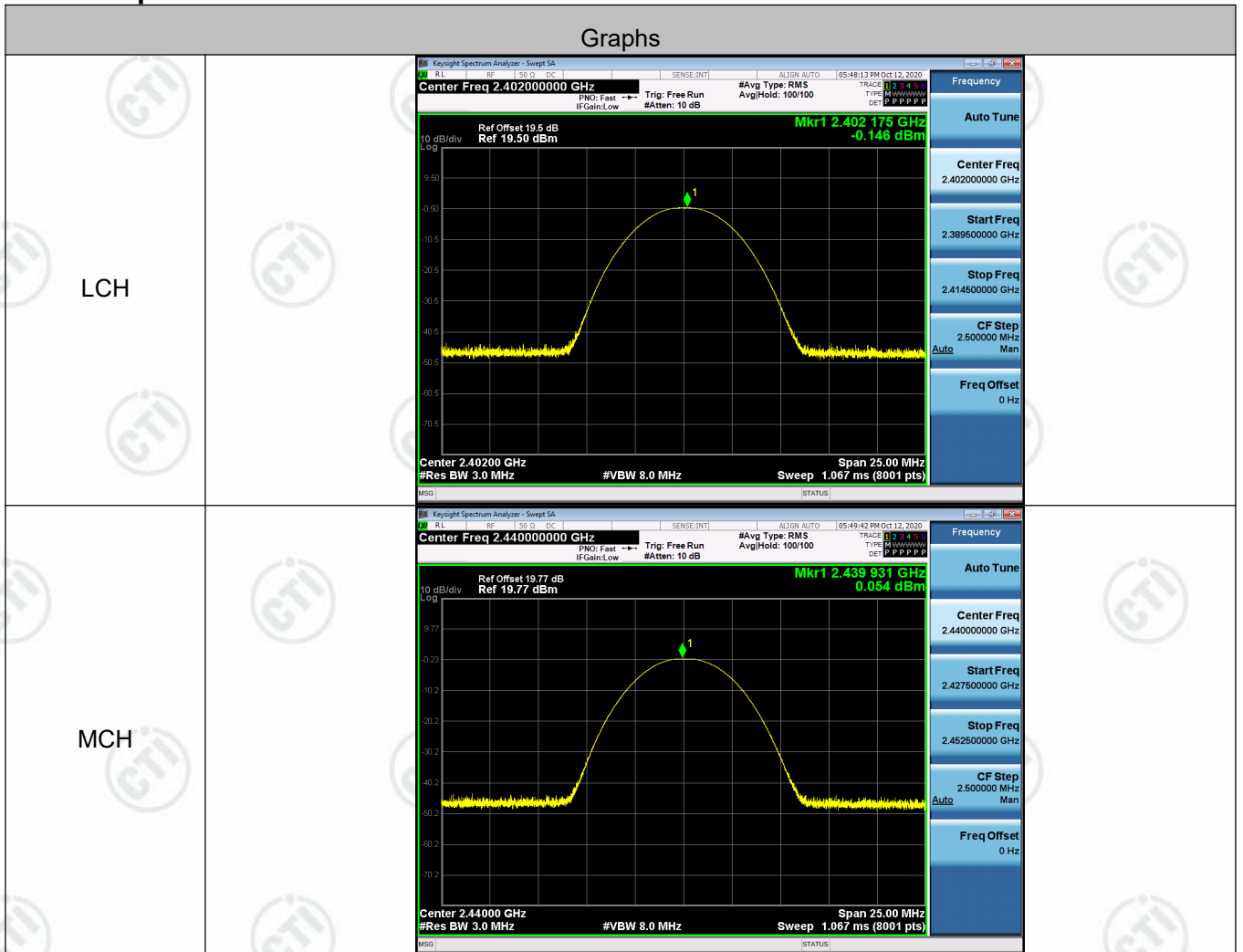

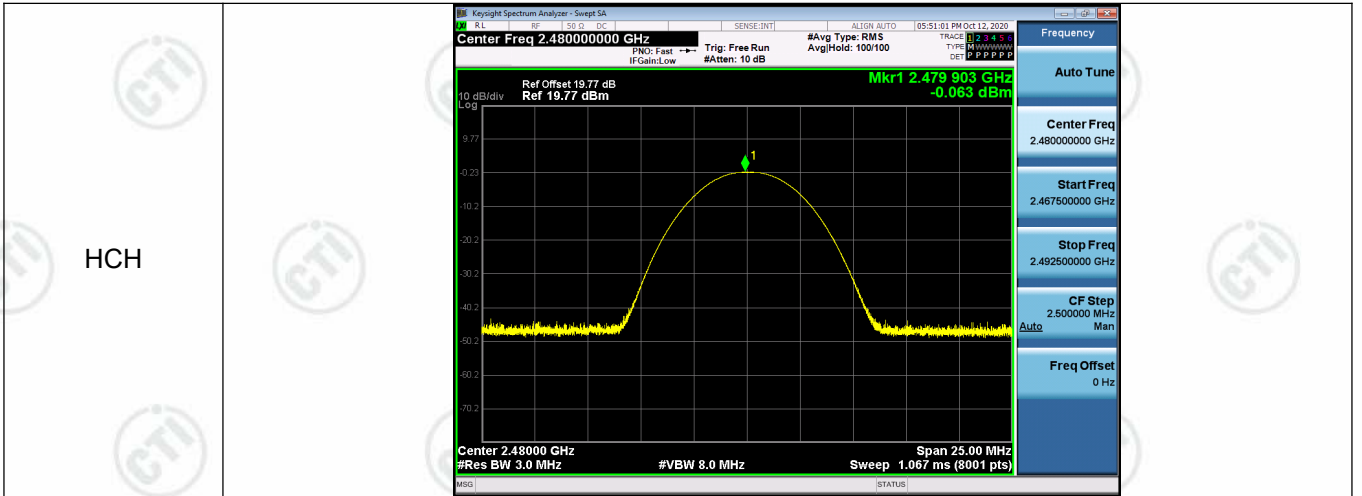

## Appendix C): Band-edge for RF Conducted Emissions

### Test Limit

According to §15.247(d) and RSS-247 section 5.5

In any 100 kHz bandwidth outside the authorized frequency band,

Non-restricted bands shall be attenuated at least 20 dB/30 dB relative to the maximum PSD level in 100 kHz by RF conducted or a radiated measurement which fall in the restricted bands, as defined in §15.205(a), must also comply with the radiated emission limits specified in §15.209(a).

### Test Procedure

Test method Refer as KDB 558074 D01 v04, Section 11.

1. EUT RF output port connected to the SA by RF cable, and the path loss was compensated to result.
2. SA setting, RBW=100kHz, VBW=300kHz, Detector=Peak, Trace mode = max hold, SWT = Auto.
3. In any 100 kHz bandwidth outside the authorized frequency band, shall be attenuated at least 20 dB relative to the maximum in-band peak PSD level in 100 kHz when conducted power procedure is used. If the transmitter complies with the conducted power limits based on the use of RMS averaging over a time interval, the attenuation required under this paragraph shall be 30 dB instead of 20 dB.

### Test Setup

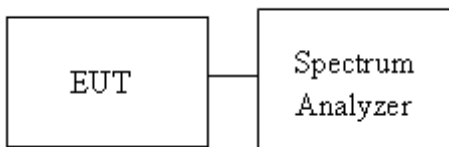



**Result Table**

Mode	Channel	Carrier Power[dBm]	Max.Spurious Level [dBm]	Limit [dBm]	Verdict
BLE	LCH	-0.926	-59.234	-20.93	PASS
BLE	HCH	-0.830	-58.924	-20.83	PASS

**Test Graphs**

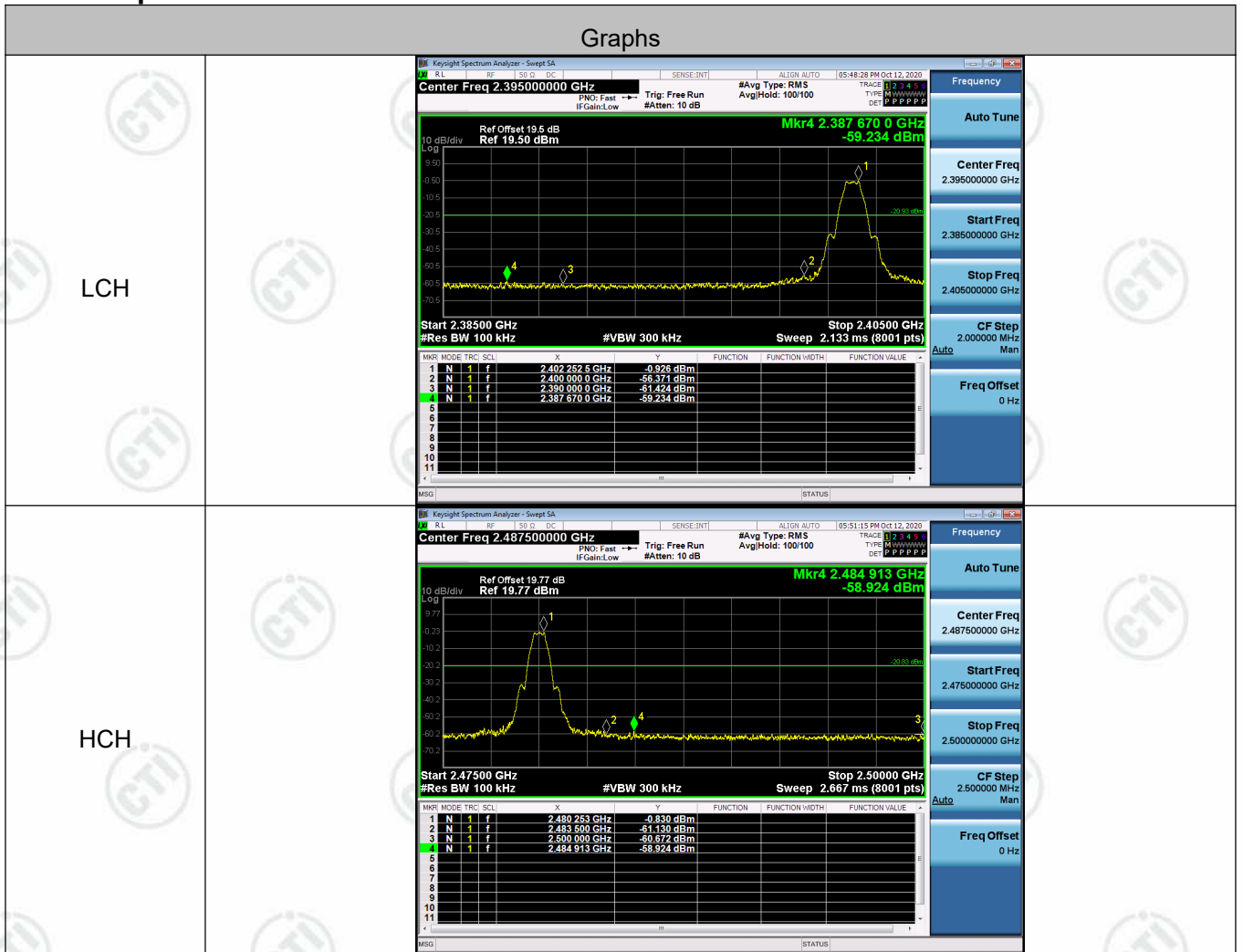

## **Appendix D): RF Conducted Spurious Emissions**

### **Test Limit**

According to §15.247(d) and RSS-247 section 5.5

In any 100 kHz bandwidth outside the authorized frequency band,

Non-restricted bands shall be attenuated at least 20 dB/30 dB relative to the maximum PSD level in 100 kHz by RF conducted or a radiated measurement which fall in the restricted bands, as defined in §15.205(a), must also comply with the radiated emission limits specified in §15.209(a).

### **Test Procedure**

Test method Refer as KDB 558074 D01 v04, Section 11.

1. EUT RF output port connected to the SA by RF cable, and the path loss was compensated to result.
2. SA setting, RBW=100kHz, VBW=300kHz, Detector=Peak, Trace mode = max hold, SWT = Auto.
3. In any 100 kHz bandwidth outside the authorized frequency band, shall be attenuated at least 20 dB relative to the maximum in-band peak PSD level in 100 kHz when conducted power procedure is used. If the transmitter complies with the conducted power limits based on the use of RMS averaging over a time interval, the attenuation required under this paragraph shall be 30 dB instead of 20 dB.

### **Test Setup**

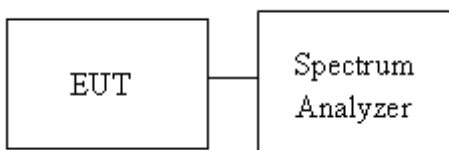

**Result Table**

Mode	Channel	Pref [dBm]	Puw[dBm]	Verdict
BLE	LCH	-1.048	<Limit	PASS
BLE	MCH	-0.858	<Limit	PASS
BLE	HCH	-1.121	<Limit	PASS

**Test Graphs**

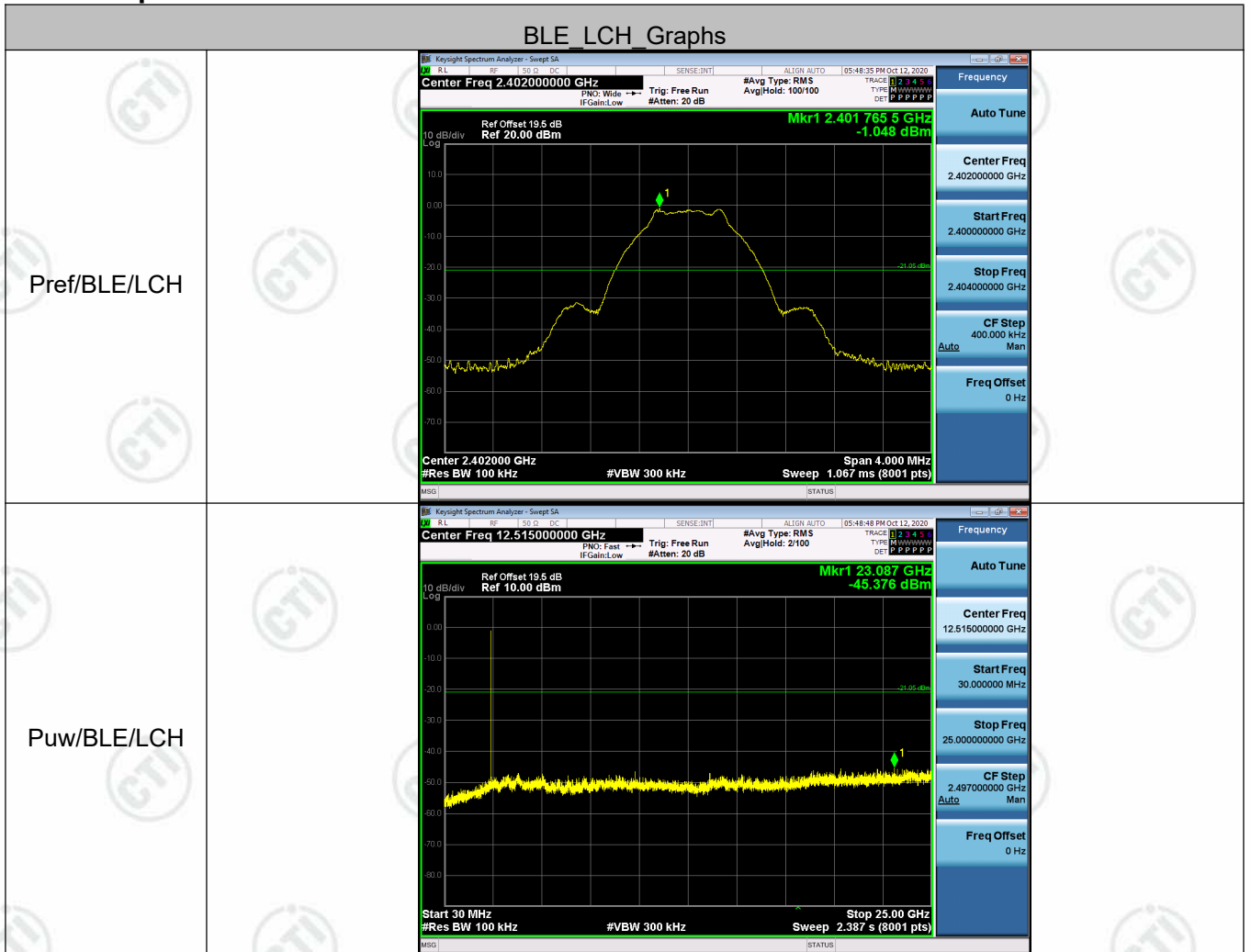

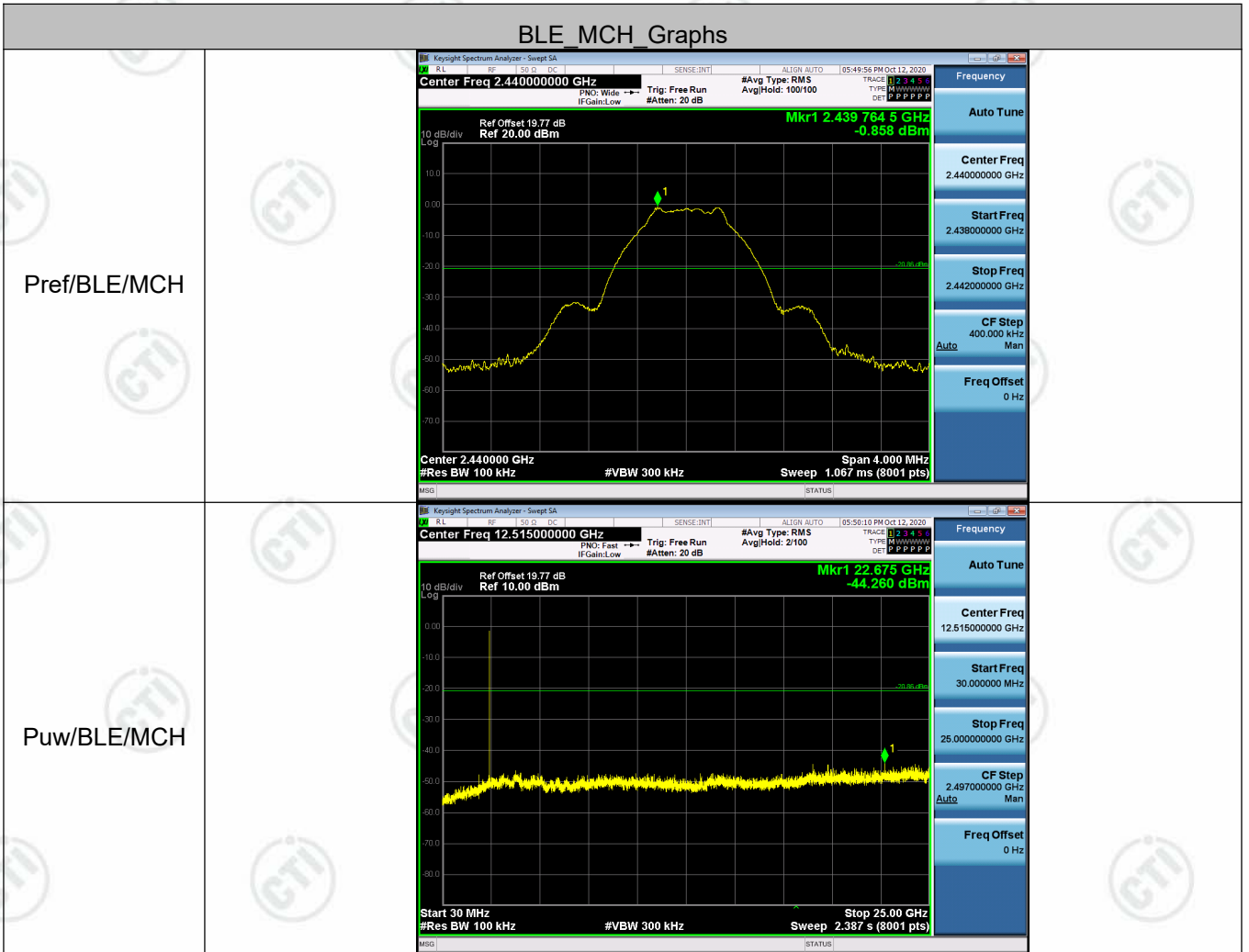

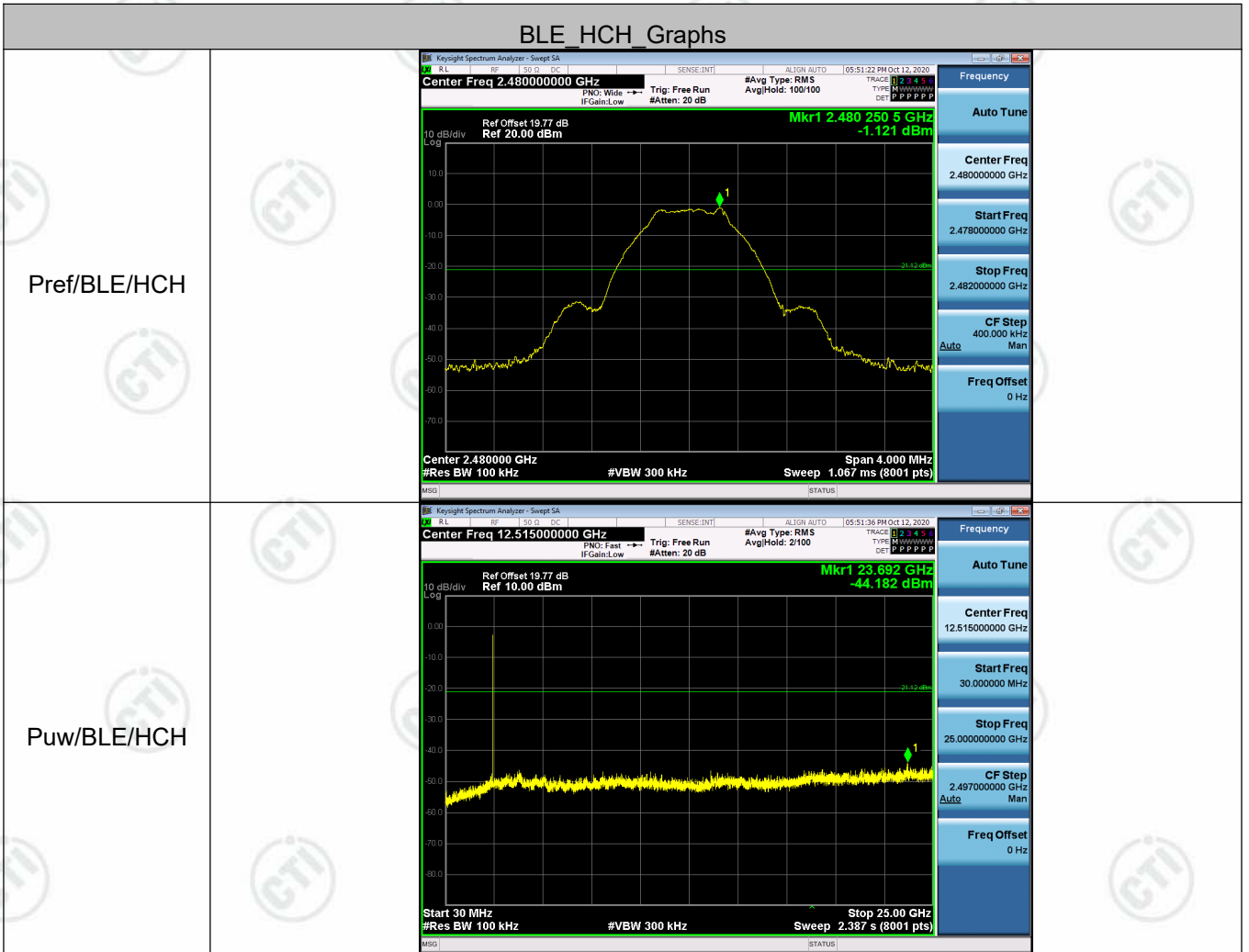

## Appendix E): Power Spectral Density

### Test Limit

According to §15.247(e) and RSS-247 section 5.2(b)

For digitally modulated systems, the power spectral density conducted from the intentional radiator to the antenna shall not be greater than 8 dBm in any 3 kHz band during any time interval of continuous transmission.

Limit	<input checked="" type="checkbox"/> Antenna not exceed 6 dBi : 8dBm <input type="checkbox"/> Antenna with DG greater than 6 dBi [ Limit = 8 – (DG – 6) ] <input type="checkbox"/> Point-to-point operation :
-------	---

### Test Procedure

Test method Refer as KDB 558074 D01 v04, Section 10.2

1. The EUT RF output connected to the spectrum analyzer by RF cable.
2. Setting maximum power transmit of EUT
3. SA set RBW = 3kHz, VBW = 30kHz, Span = 1.5 times DTS Bandwidth (6 dB BW), Detector = Peak, Sweep Time = Auto and Trace = Max hold.
4. The path loss and Duty Factor were compensated to the results for each measurement by SA.
5. Mark the maximum level.

Measure and record the result of power spectral density. in the test report.

### Test Setup

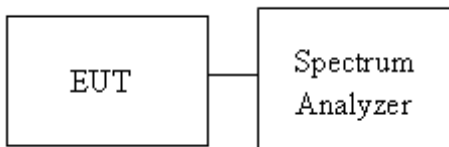

**Result Table**

Mode	Channel	PSD [dBm]	Verdict
BLE	LCH	-15.782	PASS
BLE	MCH	-15.553	PASS
BLE	HCH	-15.314	PASS

**Test Graphs**

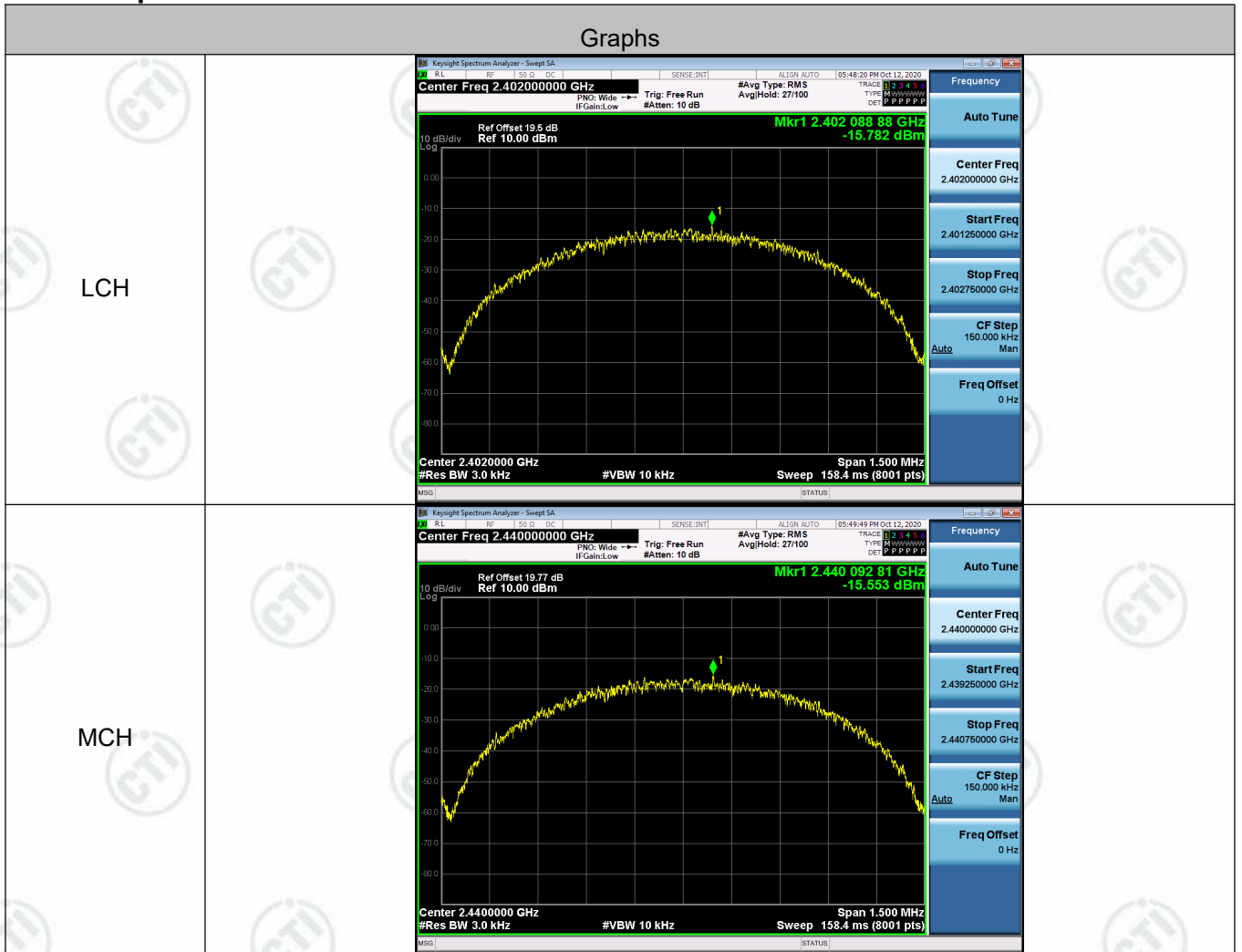

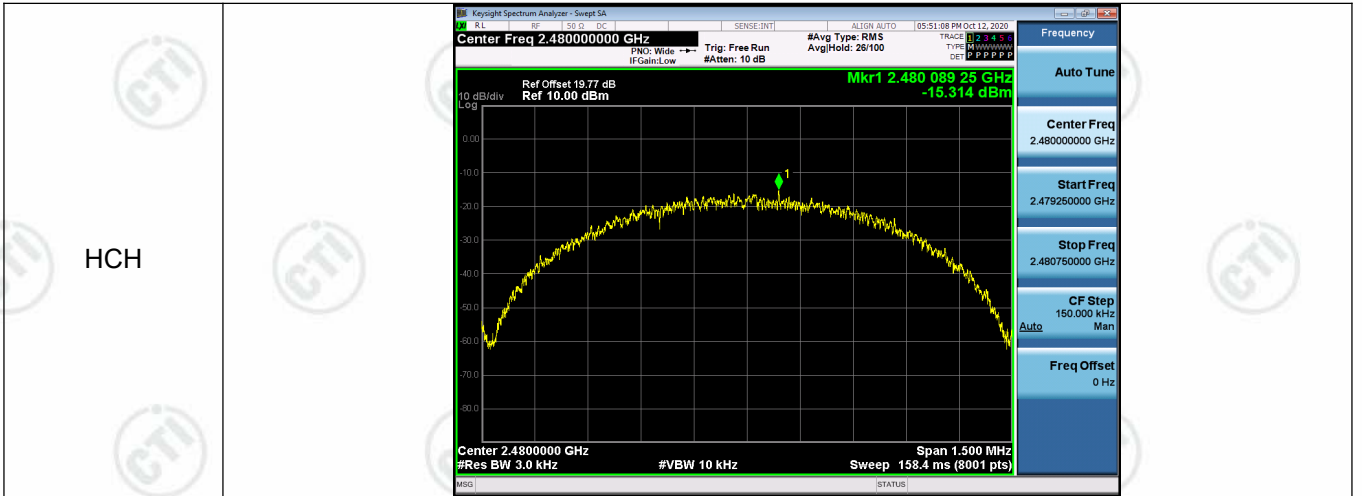



## Appendix F): Antenna Requirement

### 15.203 requirement:

An intentional radiator shall be designed to ensure that no antenna other than that furnished by the responsible party shall be used with the device. The use of a permanently attached antenna or of an antenna that uses a unique coupling to the intentional radiator, the manufacturer may design the unit so that a broken antenna can be replaced by the user, but the use of a standard antenna jack or electrical connector is prohibited.

### 15.247(b) (4) requirement:

The conducted output power limit specified in paragraph (b) of this section is based on the use of antennas with directional gains that do not exceed 6 dBi. Except as shown in paragraph (c) of this section, if transmitting antennas of directional gain greater than 6 dBi are used, the conducted output power from the intentional radiator shall be reduced below the stated values in paragraphs (b)(1), (b)(2), and (b)(3) of this section, as appropriate, by the amount in dB that the directional gain of the antenna exceeds 6 dBi.

### EUT Antenna:

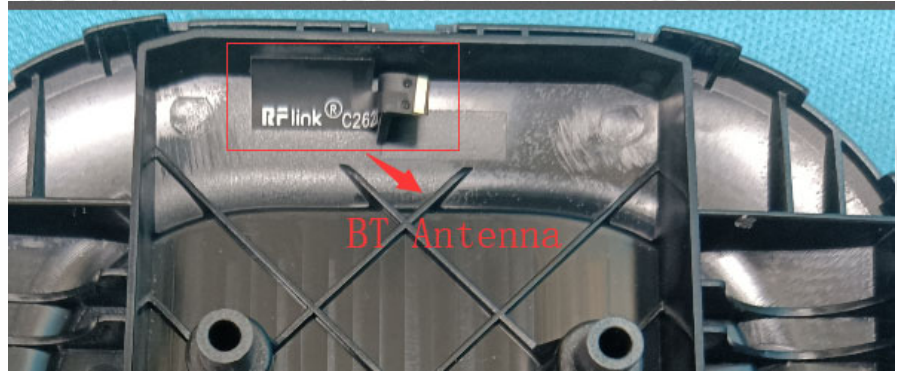

The antenna is Internal antenna and no consideration of replacement. The best case gain of the antenna is 2.93dBi.

## Appendix G): AC Power Line Conducted Emission

<p>Test Procedure:</p>	<p>Test frequency range :150KHz-30MHz</p> <ol style="list-style-type: none"> <li>1)The mains terminal disturbance voltage test was conducted in a shielded room.</li> <li>2) The EUT was connected to AC power source through a LISN 1 (Line Impedance Stabilization Network) which provides a 50Ω/50μH + 5Ω linear impedance. The power cables of all other units of the EUT were connected to a second LISN 2, which was bonded to the ground reference plane in the same way as the LISN 1 for the unit being measured. A multiple socket outlet strip was used to connect multiple power cables to a single LISN provided the rating of the LISN was not exceeded.</li> <li>3)The tabletop EUT was placed upon a non-metallic table 0.8m above the ground reference plane. And for floor-standing arrangement, the EUT was placed on the horizontal ground reference plane,</li> <li>4) The test was performed with a vertical ground reference plane. The rear of the EUT shall be 0.4 m from the vertical ground reference plane. The vertical ground reference plane was bonded to the horizontal ground reference plane. The LISN 1 was placed 0.8 m from the boundary of the unit under test and bonded to a ground reference plane for LISNs mounted on top of the ground reference plane. This distance was between the closest points of the LISN 1 and the EUT. All other units of the EUT and associated equipment was at least 0.8 m from the LISN 2.</li> <li>5) In order to find the maximum emission, the relative positions of equipment and all of the interface cables must be changed according to ANSI C63.10 on conducted measurement.</li> </ol>														
<p>Limit:</p>	<table border="1" data-bbox="494 1182 1364 1406"> <thead> <tr> <th rowspan="2">Frequency range (MHz)</th> <th colspan="2">Limit (dBμV)</th> </tr> <tr> <th>Quasi-peak</th> <th>Average</th> </tr> </thead> <tbody> <tr> <td>0.15-0.5</td> <td>66 to 56*</td> <td>56 to 46*</td> </tr> <tr> <td>0.5-5</td> <td>56</td> <td>46</td> </tr> <tr> <td>5-30</td> <td>60</td> <td>50</td> </tr> </tbody> </table> <p>* The limit decreases linearly with the logarithm of the frequency in the range 0.15 MHz to 0.50 MHz. NOTE : The lower limit is applicable at the transition frequency</p>	Frequency range (MHz)	Limit (dBμV)		Quasi-peak	Average	0.15-0.5	66 to 56*	56 to 46*	0.5-5	56	46	5-30	60	50
Frequency range (MHz)	Limit (dBμV)														
	Quasi-peak	Average													
0.15-0.5	66 to 56*	56 to 46*													
0.5-5	56	46													
5-30	60	50													

### Measurement Data

An initial pre-scan was performed on the live and neutral lines with peak detector.

Quasi-Peak and Average measurement were performed at the frequencies with maximized peak emission were detected.

Live line:

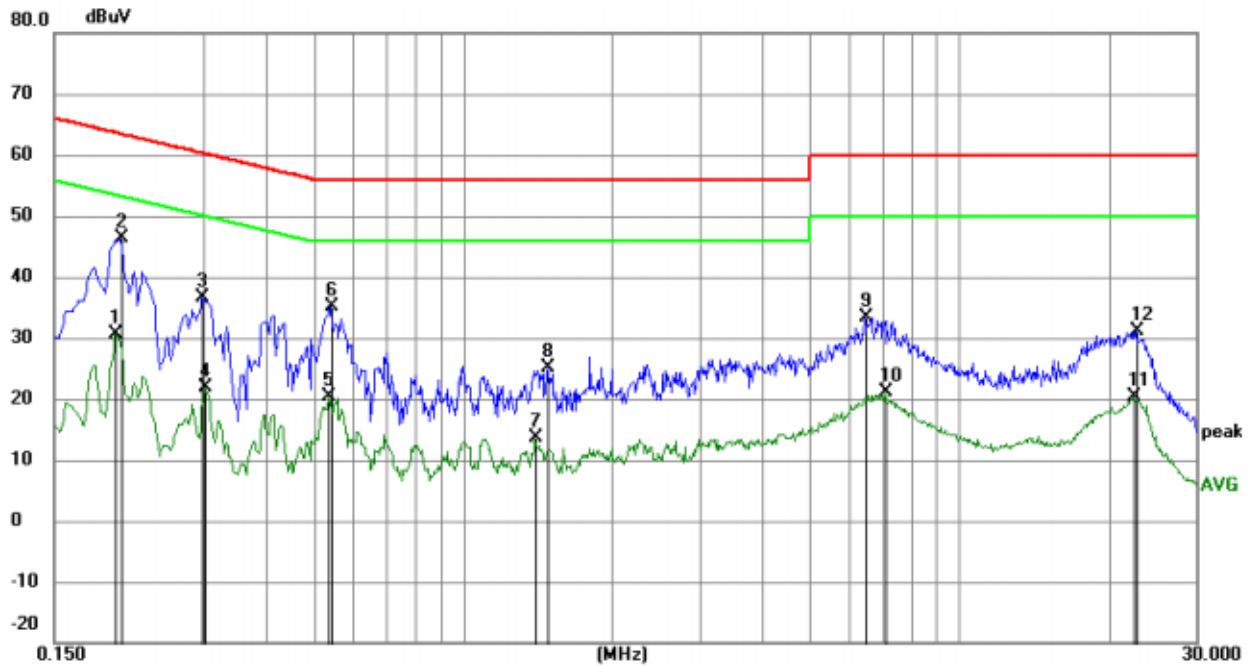

No.	Mk.	Freq. MHz	Reading Level dBuV	Correct Factor dB	Measure- ment dBuV	Limit dBuV	Margin dB	Detector	Comment
1		0.1995	20.72	9.87	30.59	53.63	-23.04	AVG	
2	*	0.2040	36.44	9.88	46.32	63.45	-17.13	QP	
3		0.2985	26.51	10.07	36.58	60.28	-23.70	QP	
4		0.3030	11.76	10.07	21.83	50.16	-28.33	AVG	
5		0.5370	10.41	9.99	20.40	46.00	-25.60	AVG	
6		0.5415	25.13	10.00	35.13	56.00	-20.87	QP	
7		1.4010	3.79	9.81	13.60	46.00	-32.40	AVG	
8		1.4865	15.21	9.81	25.02	56.00	-30.98	QP	
9		6.4860	23.68	9.79	33.47	60.00	-26.53	QP	
10		7.1070	11.35	9.79	21.14	50.00	-28.86	AVG	
11		22.5105	10.31	9.99	20.30	50.00	-29.70	AVG	
12		22.6950	21.12	9.99	31.11	60.00	-28.89	QP	

Neutral line:

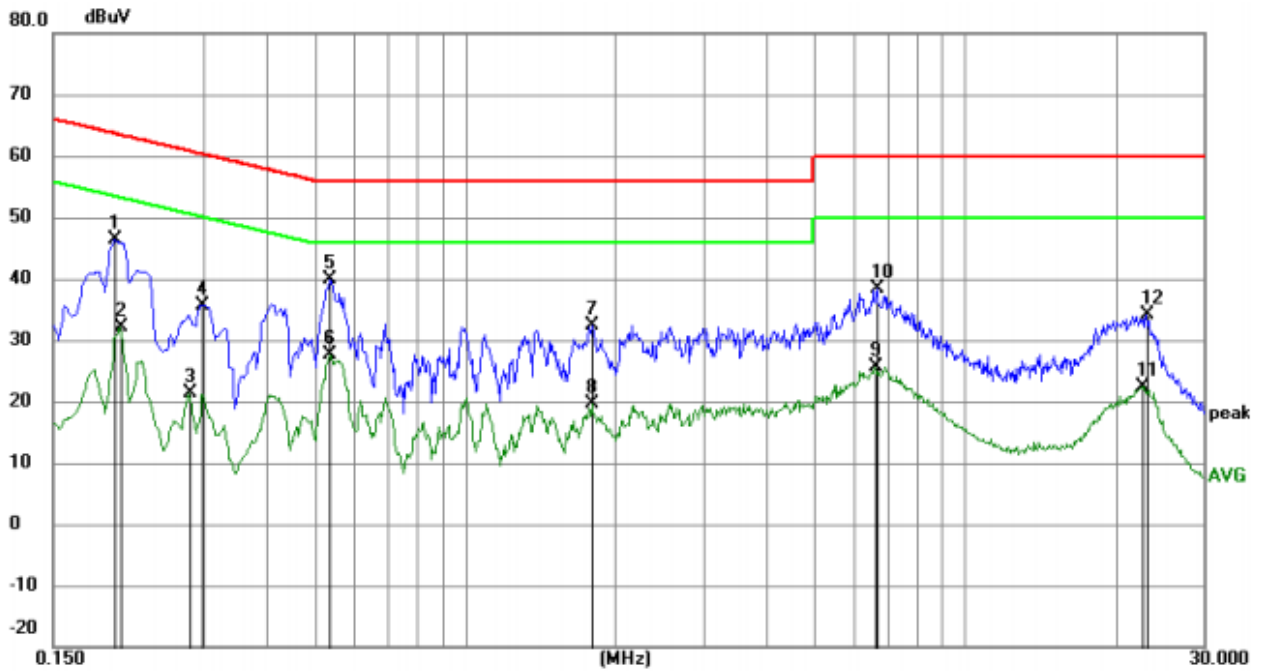

No.	Mk.	Freq. MHz	Reading Level dBuV	Correct Factor dB	Measure- ment dBuV	Limit dBuV	Margin dB	Detector	Comment
1		0.1995	36.51	9.87	46.38	63.63	-17.25	QP	
2		0.2040	22.15	9.88	32.03	53.45	-21.42	AVG	
3		0.2805	11.29	10.03	21.32	50.80	-29.48	AVG	
4		0.2985	25.58	10.07	35.65	60.28	-24.63	QP	
5	*	0.5370	29.91	9.99	39.90	56.00	-16.10	QP	
6		0.5370	17.75	9.99	27.74	46.00	-18.26	AVG	
7		1.7970	22.67	9.80	32.47	56.00	-23.53	QP	
8		1.7970	9.89	9.80	19.69	46.00	-26.31	AVG	
9		6.6120	15.96	9.79	25.75	50.00	-24.25	AVG	
10		6.6885	28.54	9.79	38.33	60.00	-21.67	QP	
11		22.5780	12.42	9.99	22.41	50.00	-27.59	AVG	
12		23.0550	24.14	9.99	34.13	60.00	-25.87	QP	

Notes:

1. The following Quasi-Peak and Average measurements were performed on the EUT:
2. Final Test Level = Receiver Reading + LISN Factor + Cable Loss.

## Appendix H): Restricted bands around fundamental frequency (Radiated)

Receiver Setup:	Frequency	Detector	RBW	VBW	Remark
	30MHz-1GHz	Quasi-peak	120kHz	300kHz	Quasi-peak
	Above 1GHz	Peak	1MHz	3MHz	Peak
		Peak	1MHz	10Hz	Average
Test Procedure:	<p><b>Below 1GHz test procedure as below:</b></p> <p>Test method Refer as KDB 558074 D01 v04, Section 12.1</p> <ol style="list-style-type: none"> <li>The EUT was placed on the top of a rotating table 0.8 meters above the ground at a 3 meter semi-anechoic chamber. The table was rotated 360 degrees to determine the position of the highest radiation.</li> <li>The EUT was set 3 meters away from the interference-receiving antenna, which was mounted on the top of a variable-height antenna tower.</li> <li>The antenna height is varied from one meter to four meters above the ground to determine the maximum value of the field strength. Both horizontal and vertical polarizations of the antenna are set to make the measurement.</li> <li>For each suspected emission, the EUT was arranged to its worst case and then the antenna was tuned to heights from 1 meter to 4 meters and the rotatable was turned from 0 degrees to 360 degrees to find the maximum reading.</li> <li>The test-receiver system was set to Peak Detect Function and Specified Bandwidth with Maximum Hold Mode.</li> <li>Place a marker at the end of the restricted band closest to the transmit frequency to show compliance. Also measure any emissions in the restricted bands. Save the spectrum analyzer plot. Repeat for each power and modulation for lowest and highest channel</li> </ol> <p><b>Above 1GHz test procedure as below:</b></p> <ol style="list-style-type: none"> <li>Different between above is the test site, change from Semi- Anechoic Chamber to fully Anechoic Chamber change form table 0.8 meter to 1.5 meter( Above 18GHz the distance is 1 meter and table is 1.5 meter).</li> <li>. Test the EUT in the lowest channel , the Highest channel</li> <li>The radiation measurements are performed in X, Y, Z axis positioning for Transmitting mode, and found the X axis positioning which it is worse case.</li> <li>Repeat above procedures until all frequencies measured was complete.</li> </ol>				
Limit:	Frequency	Limit (dB $\mu$ V/m @3m)	Remark		
	30MHz-88MHz	40.0	Quasi-peak Value		
	88MHz-216MHz	43.5	Quasi-peak Value		
	216MHz-960MHz	46.0	Quasi-peak Value		
	960MHz-1GHz	54.0	Quasi-peak Value		
	Above 1GHz	54.0	Average Value		
		74.0	Peak Value		

**Test plot as follows:**

Mode:	BLE GFSK Transmitting	Channel:	2402
Remark:	PK		

**Test Graph**

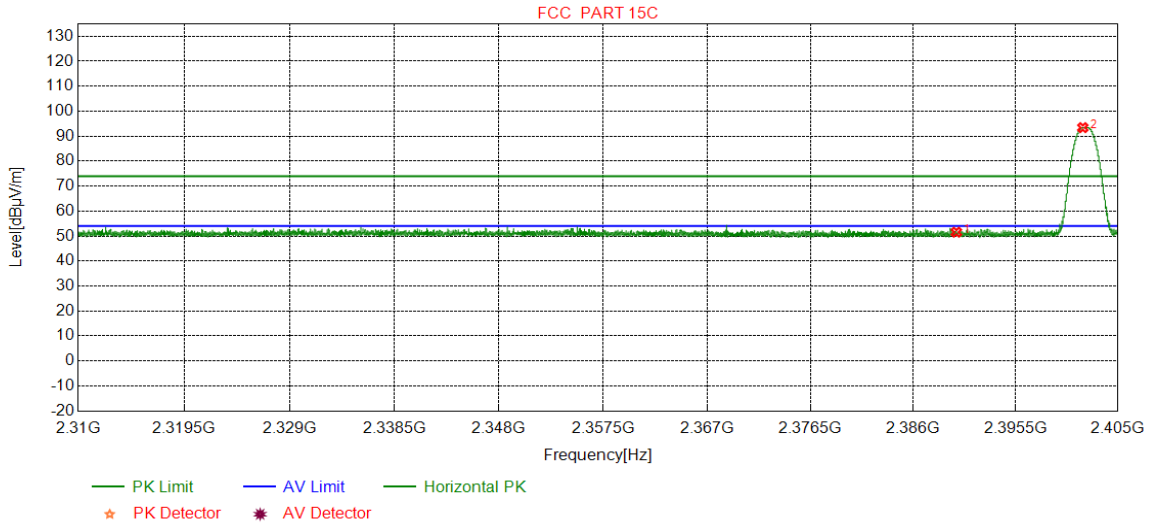

NO	Freq. [MHz]	Ant Factor [dB]	Cable loss [dB]	Pream gain [dB]	Reading [dBµV]	Level [dBµV/m]	Limit [dBµV/m]	Margin [dB]	Result	Polarity
1	2390.0000	32.25	13.37	-43.12	49.06	51.56	74.00	22.44	Pass	Horizontal
2	2401.7445	32.26	13.31	-43.12	90.97	93.42	74.00	-19.42	Pass	Horizontal

Mode:	BLE GFSK Transmitting	Channel:	2402
Remark:	PK		

**Test Graph**

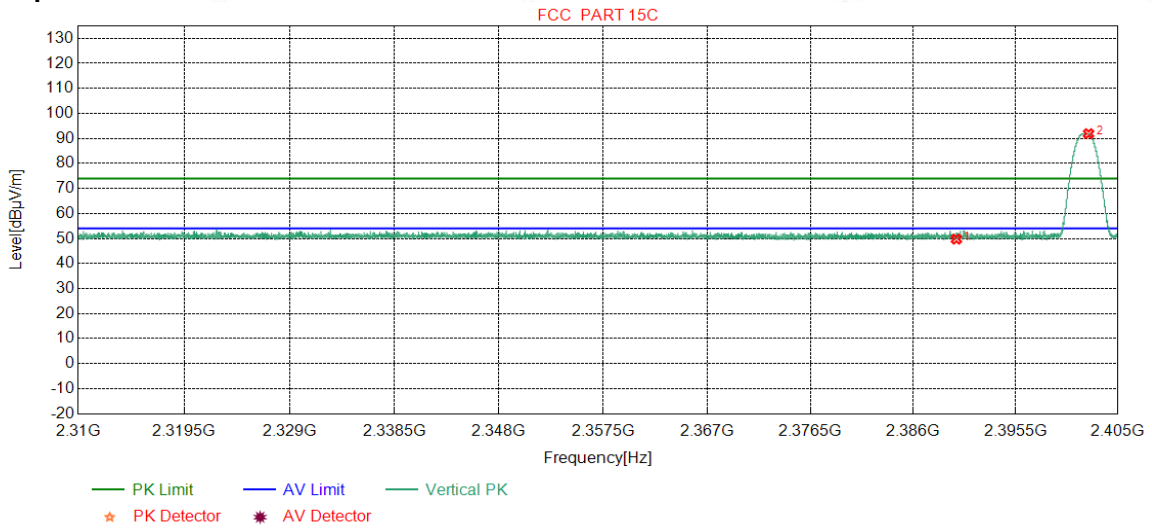

NO	Freq. [MHz]	Ant Factor [dB]	Cable loss [dB]	Pream gain [dB]	Reading [dBµV]	Level [dBµV/m]	Limit [dBµV/m]	Margin [dB]	Result	Polarity
1	2390.0000	32.25	13.37	-43.12	47.24	49.74	74.00	24.26	Pass	Vertical
2	2402.2828	32.26	13.31	-43.12	89.45	91.90	74.00	-17.90	Pass	Vertical

Mode:	BLE GFSK Transmitting	Channel:	2402
Remark:	AV		

**Test Graph**

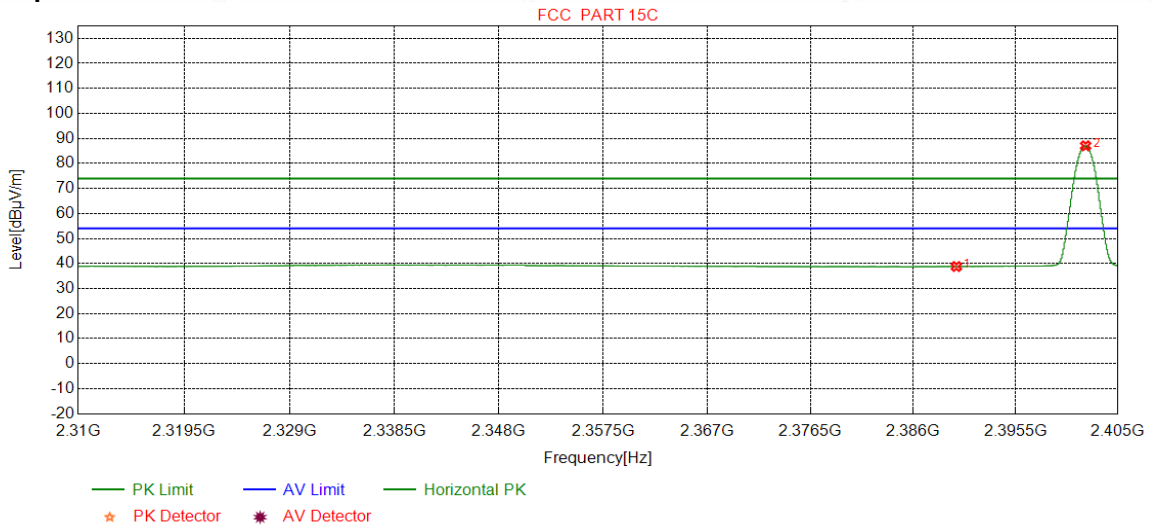

NO	Freq. [MHz]	Ant Factor [dB]	Cable loss [dB]	Pream gain [dB]	Reading [dBµV]	Level [dBµV/m]	Limit [dBµV/m]	Margin [dB]	Result	Polarity
1	2390.0000	32.25	13.37	-43.12	36.30	38.80	54.00	15.20	Pass	Horizontal
2	2402.0041	32.26	13.31	-43.12	84.61	87.06	54.00	-33.06	Pass	Horizontal



Mode:	BLE GFSK Transmitting	Channel:	2402
Remark:	AV		

**Test Graph**

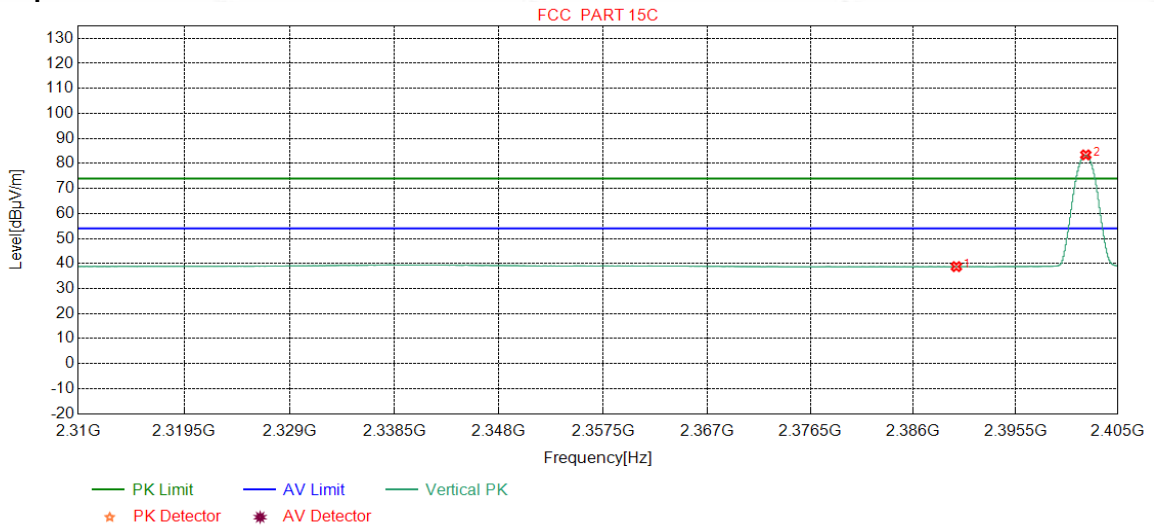

NO	Freq. [MHz]	Ant Factor [dB]	Cable loss [dB]	Pream gain [dB]	Reading [dBµV]	Level [dBµV/m]	Limit [dBµV/m]	Margin [dB]	Result	Polarity
1	2390.0000	32.25	13.37	-43.12	36.26	38.76	54.00	15.24	Pass	Vertical
2	2402.0231	32.26	13.31	-43.12	80.98	83.43	54.00	-29.43	Pass	Vertical

Mode:	BLE GFSK Transmitting	Channel:	2480
Remark:	PK		

**Test Graph**

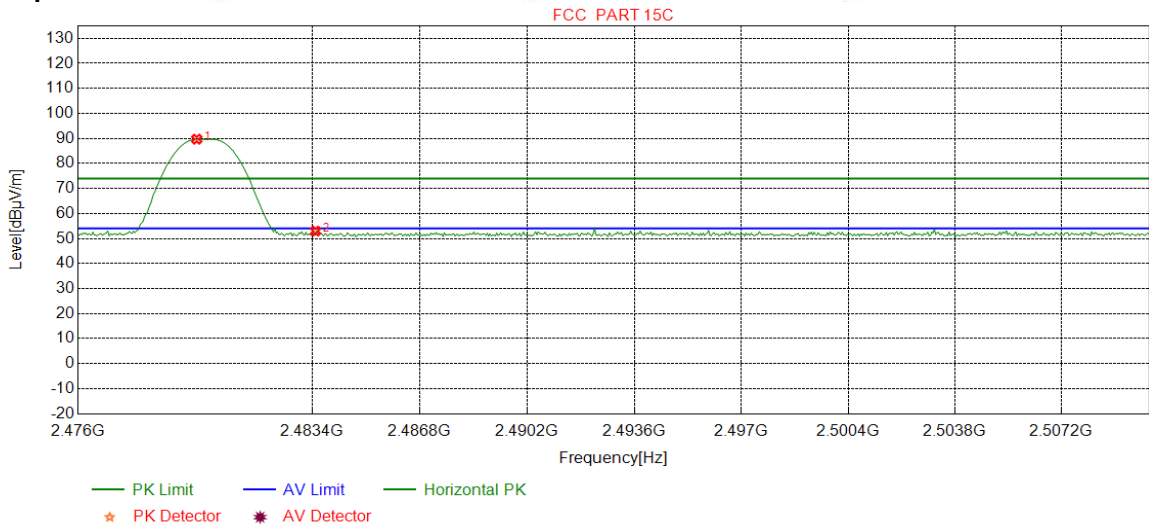

NO	Freq. [MHz]	Ant Factor [dB]	Cable loss [dB]	Pream gain [dB]	Reading [dBµV]	Level [dBµV/m]	Limit [dBµV/m]	Margin [dB]	Result	Polarity
1	2479.7447	32.37	13.39	-43.10	87.04	89.70	74.00	-15.70	Pass	Horizontal
2	2483.5000	32.38	13.38	-43.11	50.30	52.95	74.00	21.05	Pass	Horizontal

Mode:	BLE GFSK Transmitting	Channel:	2480
Remark:	PK		

**Test Graph**

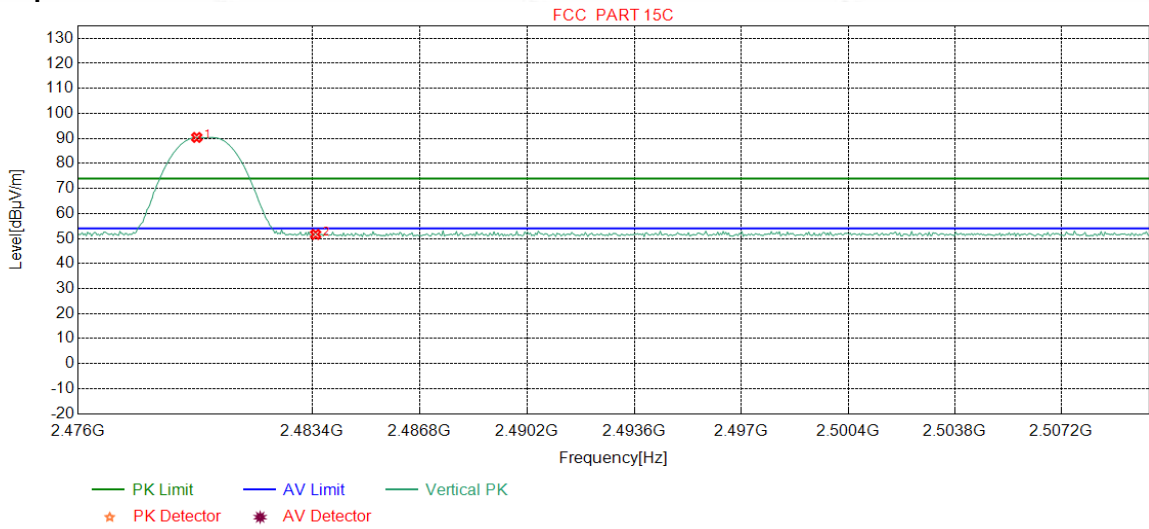

NO	Freq. [MHz]	Ant Factor [dB]	Cable loss [dB]	Pream gain [dB]	Reading [dBµV]	Level [dBµV/m]	Limit [dBµV/m]	Margin [dB]	Result	Polarity
1	2479.7447	32.37	13.39	-43.10	87.74	90.40	74.00	-16.40	Pass	Vertical
2	2483.5000	32.38	13.38	-43.11	48.96	51.61	74.00	22.39	Pass	Vertical

Mode:	BLE GFSK Transmitting	Channel:	2480
Remark:	AV		

**Test Graph**

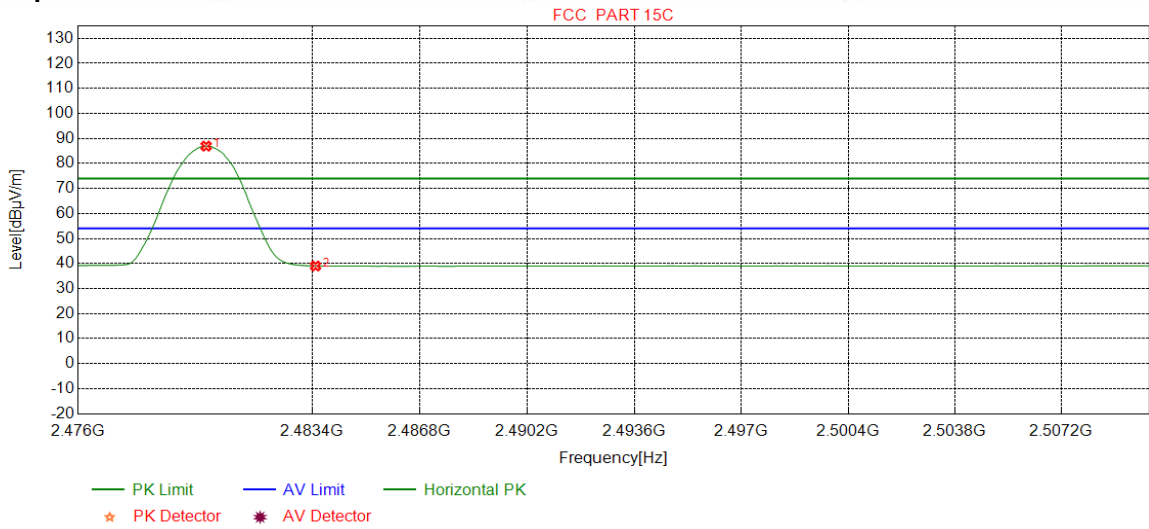

NO	Freq. [MHz]	Ant Factor [dB]	Cable loss [dB]	Pream gain [dB]	Reading [dBµV]	Level [dBµV/m]	Limit [dBµV/m]	Margin [dB]	Result	Polarity
1	2480.0426	32.37	13.39	-43.10	84.26	86.92	54.00	-32.92	Pass	Horizontal
2	2483.5000	32.38	13.38	-43.11	36.36	39.01	54.00	14.99	Pass	Horizontal

Mode:	BLE GFSK Transmitting	Channel:	2480
Remark:	AV		

**Test Graph**

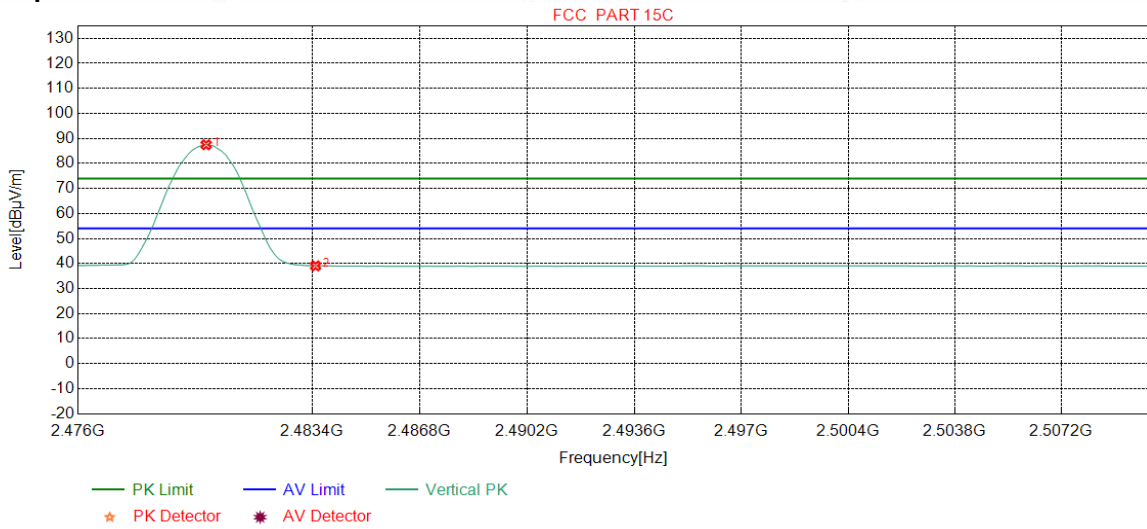

NO	Freq. [MHz]	Ant Factor [dB]	Cable loss [dB]	Pream gain [dB]	Reading [dBµV]	Level [dBµV/m]	Limit [dBµV/m]	Margin [dB]	Result	Polarity
1	2480.0426	32.37	13.39	-43.10	84.80	87.46	54.00	-33.46	Pass	Vertical
2	2483.5000	32.38	13.38	-43.11	36.42	39.07	54.00	14.93	Pass	Vertical

**Note:**

1) The field strength is calculated by adding the Antenna Factor, Cable Factor & Preamplifier. The basic equation with a sample calculation is as follows:

Final Test Level = Receiver Reading - Correct Factor

Correct Factor = Preamplifier Factor - Antenna Factor - Cable Factor

### Appendix I) Radiated Spurious Emissions

Receiver Setup:	Frequency	Detector	RBW	VBW	Remark
	0.009MHz-0.090MHz	Peak	10kHz	30kHz	Peak
	0.009MHz-0.090MHz	Average	10kHz	30kHz	Average
	0.090MHz-0.110MHz	Quasi-peak	10kHz	30kHz	Quasi-peak
	0.110MHz-0.490MHz	Peak	10kHz	30kHz	Peak
	0.110MHz-0.490MHz	Average	10kHz	30kHz	Average
	0.490MHz -30MHz	Quasi-peak	10kHz	30kHz	Quasi-peak
	30MHz-1GHz	Quasi-peak	120kHz	300kHz	Quasi-peak
	Above 1GHz	Peak	1MHz	3MHz	Peak
Peak		1MHz	10Hz	Average	

**Test Procedure:**

**Below 1GHz test procedure as below:**  
 Test method Refer as KDB 558074 D01 v04, Section 12.1

- The EUT was placed on the top of a rotating table 0.8 meters above the ground at a 3 meter semi-anechoic chamber. The table was rotated 360 degrees to determine the position of the highest radiation.
- The EUT was set 3 meters away from the interference-receiving antenna, which was mounted on the top of a variable-height antenna tower.
- The antenna height is varied from one meter to four meters above the ground to determine the maximum value of the field strength. Both horizontal and vertical polarizations of the antenna are set to make the measurement.
- For each suspected emission, the EUT was arranged to its worst case and then the antenna was tuned to heights from 1 meter to 4 meters (for the test frequency of below 30MHz, the antenna was tuned to heights 1 meter) and the rotatable was turned from 0 degrees to 360 degrees to find the maximum reading.
- The test-receiver system was set to Peak Detect Function and Specified Bandwidth with Maximum Hold Mode.
- If the emission level of the EUT in peak mode was 10dB lower than the limit specified, then testing could be stopped and the peak values of the EUT would be reported. Otherwise the emissions that did not have 10dB margin would be re-tested one by one using peak, quasi-peak or average method as specified and then reported in a data sheet.

**Above 1GHz test procedure as below:**

- Different between above is the test site, change from Semi- Anechoic Chamber to fully Anechoic Chamber and change form table 0.8 meter to 1.5 meter( Above 18GHz the distance is 1 meter and table is 1.5 meter).
- Test the EUT in the lowest channel ,the middle channel ,the Highest channel
- The radiation measurements are performed in X, Y, Z axis positioning for Transmitting mode, and found the X axis positioning which it is worse case.
- Repeat above procedures until all frequencies measured was complete.

Limit:	Frequency	Field strength (microvolt/meter)	Limit (dB $\mu$ V/m)	Remark	Measurement distance (m)
	0.009MHz-0.490MHz	2400/F(kHz)	-	-	300
	0.490MHz-1.705MHz	24000/F(kHz)	-	-	30
	1.705MHz-30MHz	30	-	-	30
	30MHz-88MHz	100	40.0	Quasi-peak	3
	88MHz-216MHz	150	43.5	Quasi-peak	3
	216MHz-960MHz	200	46.0	Quasi-peak	3
	960MHz-1GHz	500	54.0	Quasi-peak	3
	Above 1GHz	500	54.0	Average	3

Note: 15.35(b), Unless otherwise specified, the limit on peak radio frequency emissions is 20dB above the maximum permitted average emission limit applicable to the equipment under test. This peak limit applies to the total peak emission level radiated by the device.

### Radiated Spurious Emissions test Data:

#### Radiated Emission below 1GHz

Mode:			BLE GFSK Transmitting					Channel:		2440	
NO	Freq. [MHz]	Ant Factor [dB]	Cable loss [dB]	Pream gain [dB]	Reading [dB $\mu$ V]	Level [dB $\mu$ V/m]	Limit [dB $\mu$ V/m]	Margin [dB]	Result	Polarity	Remark
1	36.5967	11.21	0.67	-31.38	36.35	16.85	40.00	23.15	Pass	H	PK
2	111.7792	10.60	1.25	-32.07	41.66	21.44	43.50	22.06	Pass	H	PK
3	237.1157	11.87	1.83	-31.91	39.40	21.19	46.00	24.81	Pass	H	PK
4	433.2693	15.93	2.46	-31.84	38.59	25.14	46.00	20.86	Pass	H	PK
5	649.9890	19.40	3.10	-32.07	39.32	29.75	46.00	16.25	Pass	H	PK
6	909.9750	22.16	3.60	-31.48	34.72	29.00	46.00	17.00	Pass	H	PK
7	36.7907	11.27	0.68	-31.38	38.49	19.06	40.00	20.94	Pass	V	PK
8	140.0090	7.20	1.39	-31.99	44.80	21.40	43.50	22.10	Pass	V	PK
9	208.8859	11.13	1.71	-31.94	43.41	24.31	43.50	19.19	Pass	V	PK
10	433.2693	15.93	2.46	-31.84	38.71	25.26	46.00	20.74	Pass	V	PK
11	519.9960	17.40	2.73	-31.93	37.11	25.31	46.00	20.69	Pass	V	PK
12	909.9750	22.16	3.60	-31.48	36.54	30.82	46.00	15.18	Pass	V	PK

**Transmitter Emission above 1GHz**

Mode:			BLE GFSK Transmitting					Channel:		2402	
NO	Freq. [MHz]	Ant Factor [dB]	Cable loss [dB]	Pream gain [dB]	Reading [dBμV]	Level [dBμV/m]	Limit [dBμV/m]	Margin [dB]	Result	Polarity	Remark
1	1359.4359	28.26	2.84	-42.73	56.06	44.43	74.00	29.57	Pass	H	PK
2	3302.0201	33.32	4.58	-43.10	49.60	44.40	74.00	29.60	Pass	H	PK
3	4804.0000	34.50	4.55	-42.80	46.86	43.11	74.00	30.89	Pass	H	PK
4	7206.0000	36.31	5.81	-42.16	46.74	46.70	74.00	27.30	Pass	H	PK
5	9608.0000	37.64	6.63	-42.10	46.52	48.69	74.00	25.31	Pass	H	PK
6	12010.0000	39.31	7.60	-41.90	47.67	52.68	74.00	21.32	Pass	H	PK
7	1991.0991	31.64	3.46	-43.18	58.48	50.40	74.00	23.60	Pass	V	PK
8	3199.0133	33.28	4.65	-43.10	52.79	47.62	74.00	26.38	Pass	V	PK
9	4804.0000	34.50	4.55	-42.80	48.04	44.29	74.00	29.71	Pass	V	PK
10	7206.0000	36.31	5.81	-42.16	47.05	47.01	74.00	26.99	Pass	V	PK
11	9608.0000	37.64	6.63	-42.10	47.36	49.53	74.00	24.47	Pass	V	PK
12	12010.0000	39.31	7.60	-41.90	45.97	50.98	74.00	23.02	Pass	V	PK

Mode:			BLE GFSK Transmitting					Channel:		2440	
NO	Freq. [MHz]	Ant Factor [dB]	Cable loss [dB]	Pream gain [dB]	Reading [dBμV]	Level [dBμV/m]	Limit [dBμV/m]	Margin [dB]	Result	Polarity	Remark
1	1354.8355	28.25	2.83	-42.72	54.89	43.25	74.00	30.75	Pass	H	PK
2	3080.0053	33.23	4.76	-43.09	49.87	44.77	74.00	29.23	Pass	H	PK
3	4880.0000	34.50	4.80	-42.80	48.42	44.92	74.00	29.08	Pass	H	PK
4	7320.0000	36.42	5.85	-42.14	47.89	48.02	74.00	25.98	Pass	H	PK
5	9760.0000	37.70	6.73	-42.10	46.99	49.32	74.00	24.68	Pass	H	PK
6	12200.0000	39.42	7.67	-41.90	45.94	51.13	74.00	22.87	Pass	H	PK
7	1990.8991	31.64	3.46	-43.18	58.84	50.76	74.00	23.24	Pass	V	PK
8	3195.0130	33.28	4.64	-43.10	50.32	45.14	74.00	28.86	Pass	V	PK
9	4880.0000	34.50	4.80	-42.80	47.91	44.41	74.00	29.59	Pass	V	PK
10	7320.0000	36.42	5.85	-42.14	47.06	47.19	74.00	26.81	Pass	V	PK
11	9760.0000	37.70	6.73	-42.10	46.84	49.17	74.00	24.83	Pass	V	PK
12	12200.0000	39.42	7.67	-41.90	46.18	51.37	74.00	22.63	Pass	V	PK



Mode:			BLE GFSK Transmitting					Channel:		2480	
NO	Freq. [MHz]	Ant Factor [dB]	Cable loss [dB]	Pream gain [dB]	Reading [dBμV]	Level [dBμV/m]	Limit [dBμV/m]	Margin [dB]	Result	Polarity	Remark
1	1991.0991	31.64	3.46	-43.18	54.26	46.18	74.00	27.82	Pass	H	PK
2	3783.0522	33.63	4.36	-43.04	51.07	46.02	74.00	27.98	Pass	H	PK
3	4960.0000	34.50	4.82	-42.80	47.85	44.37	74.00	29.63	Pass	H	PK
4	7440.0000	36.54	5.85	-42.11	45.68	45.96	74.00	28.04	Pass	H	PK
5	9920.0000	37.77	6.79	-42.10	46.05	48.51	74.00	25.49	Pass	H	PK
6	12400.0000	39.54	7.86	-41.90	46.89	52.39	74.00	21.61	Pass	H	PK
7	1993.2993	31.66	3.46	-43.18	58.80	50.74	74.00	23.26	Pass	V	PK
8	3317.0211	33.33	4.56	-43.10	50.19	44.98	74.00	29.02	Pass	V	PK
9	4960.0000	34.50	4.82	-42.80	48.13	44.65	74.00	29.35	Pass	V	PK
10	7440.0000	36.54	5.85	-42.11	46.66	46.94	74.00	27.06	Pass	V	PK
11	9920.0000	37.77	6.79	-42.10	46.92	49.38	74.00	24.62	Pass	V	PK
12	12400.0000	39.54	7.86	-41.90	47.37	52.87	74.00	21.13	Pass	V	PK

**Note:**

1) The field strength is calculated by adding the Antenna Factor, Cable Factor & Preamplifier. The basic equation with a sample calculation is as follows:

Final Test Level = Receiver Reading - Correct Factor

Correct Factor = Preamplifier Factor - Antenna Factor - Cable Factor

2) Scan from 9kHz to 25GHz, the disturbance above 13GHz and below 30MHz was very low, and the above harmonics were the highest point could be found when testing, so only the above harmonics had been displayed. The amplitude of spurious emissions from the radiator which are attenuated more than 20dB below the limit need not be reported.