

4K UHD ALL-IN-ONE USB Camera User Manual

1 Appearance and Interface

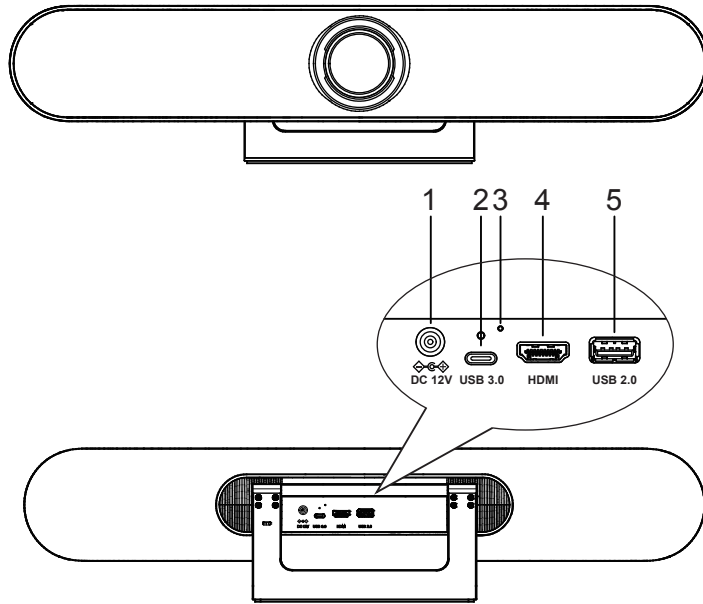

Item	Name	Item	Name
1	DC 12V Interface	4	HDMI Interface
2	USB 3.0 Interface	5	USB 2.0 Interface
3	Reset Button	-	-

2 Packing List

Name	Quantity
Camera	1
Power Adapter	1
Power Cable	1
Remote Control	1
USB Cable	1
Wall Bracket (with screw)	1
User Manual	1

3 Product Features

Applicable Scene

It is specially designed for small and medium-sized meeting rooms, especially for the Huddle Room with 4 to 6 people, to help enterprises re-tap the potential of using the small and micro meeting space inside. On one hand, it can hold meetings more efficiently, on the other hand, it can also save the rental cost.

Product Value

It is convenient for small and medium-sized enterprises to conduct daily business negotiation and team cooperation in different places flexibly, so as to create a relaxed, free and smooth conversation environment, make decisions quickly and improve efficiency.

All-in-one Design

The three-in-one design of 4K ultra HD camera, beamforming microphone and full-frequency loudspeaker reduces wiring and make video communication easy.

Bluetooth 5.0

Using Bluetooth 5.0 technology. Compared with the previous generation technology, the transmission rate is increased by 2 times, and the transmission distance is increased by 4 times. It can better transmit the high-quality audio between the mobile phone and tablet devices to achieve the wireless Bluetooth streaming.

4K UHD

Using 1/2.5 inch, 8.51M pixel high quality UHD CMOS sensor, 4K (3840x2160)@30fps ultra high resolution clear image, and downward compatible with 1080P, 720P and other resolutions. It can meet the needs of users for different video experiences, and can provide clearer, real, smooth and accurate communication.

Wide Field View

121° wide field of view (110° horizontal field of view), 5 times zoom, optical lens customized for the conference scene, built-in electric head (horizontal and pitch ±15° motion range), no need to worry about the camera position, participants can easily enter the scene clearly.

Beamforming Microphone

Beam Forming (BF) microphone is built in, with a pickup distance of 6 meters. Low-distortion transverse beamforming algorithm can direct the microphone directly to the speaker, with better sound, clearer communication, fuller and more authentic.

Audio 3A Algorithm

Built-in audio 3A algorithm (AEC/AGC/ANS), full duplex dialogue, can meet the communication needs of different room structures, whether sitting at a conference table, sitting against the wall or standing, can have comfortable experience for calling.

Full Frequency Speaker

Full frequency Hi-Fi loudspeaker, professional acoustics design, reduce noise interference, provide outstanding sound effect.

Plug and Play Type

Through plug and play USB interface connect with the computer or business display screen, very easy to use. Less wiring, convenient video communication, reduce the user's learning cost.

Speaker Phone

It can be used as Bluetooth microphone and speaker while connected to mobile phone or other devices via Bluetooth connection, and the call can be connected to the audio and video conference.

Intelligent Analysis

Built-in intelligent analysis algorithm, listening to the speaker position, automatic framing of participants, automatic tracking of speakers, switching the speaker screen, to ensure that the speaker is always clearly in the picture.

Rich Interfaces

Support HDMI and USB 3.0 audio video output simultaneously.

Easy Installation

Flexible installation options such as countertops, walls, and TV/display screens are available for quick installation and deployment in a crowded meeting room.

4 Product Specifications

Camera	
Video System	4K@30fps, 1080P@60fps, 1080P@30fps, 720P@60fps, 720P@30fps, etc
Sensor	1/2.5 inch, CMOS, 8.51M pixel
Lens	121°(DFOV), 110°(HFOV), 5x Digital Zoom, Pan/Tilt ±15°
PTZ	MPT + EPTZ
Digital Noise Reduction	2D & 3D Digital Noise Reduction
Video S/N	≥55dB
Backlight Compensation	Support
Audio	
Full Frequency Speaker	96 dB SPL in the case of 0.5 meter
Microphone Array	Beamforming microphone, pick up distance up to 6 meters
Extended MIC	Supported (Optional)
USB Features	
Connection Type	USB 3.0, downward compatible with USB 2.0
Video Compression	H.264 / MJPEG / YUY2 / NV12
USB Audio	32K sampling rate, support UAC 1.0

USB Communication Protocol	UVC 1.1~1.5
UVC PTZ Control	Support
Input/Output Interface	
HD Output	1 x HDMI, Version 1.4b
USB Interface	1 x USB 3.0, Type C
	1 x USB 2.0, Type A
Power Jack	DC 12V, 2A (Max)
Generic Specification	
Control Method	2.4G Remote Controller
Installation Method	Desktop, Wall, TV and others
Operating Temperature	0°C ~ 40°C
Storage Temperature	-40°C ~ 60°C
Dimension	600mm x 135mm x 117mm (holder included)
Net Weight	2.5Kg

Note Product specifications and parameter information are subject to change without notice.

5 Safety Precautions

Careful Transportation

Transportation, custody and installation process to prevent heavy pressure, violent vibration, immersion damage to the product.

Careful Installation

This product should be placed on the smooth desktop. The shell of the product is an organic material and is strictly prohibited from contact with any liquid, gas or solid material that may cause corrosion to the shell.

Do not Unauthorized Disassemble

This product has no parts which can be repaired by the user. The damage caused by the user's own disassembly is not covered by warranty.



Electromagnetic fields at specific frequencies may affect image of machine.

6 Remote Control

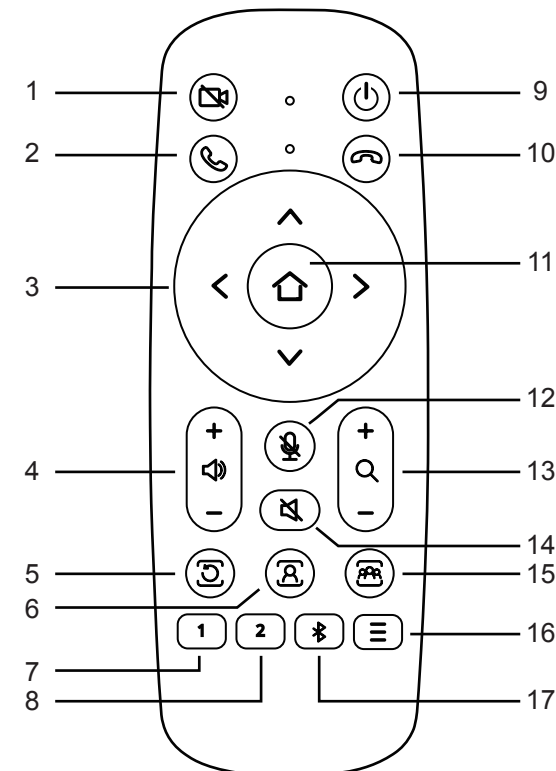

No.	Name	Function Description
1	Camera Close Key	Press to turn off the camera, press again to resume
2	Call Key	Answer the call
3	Camera Direction Keys	Press to move the camera to up, down, left and right direction to adjust the image display; press the [OK] key to return the camera to the middle position
4	Volume +/- Keys	Press to increase or decrease the volume
5	Exit Tracking Key	Press to exit the tracking mode
6	Speaker Tracking Key	Press to perform voice tracking of the speaker
7	Preset 1 Key	Long press to set preset 1; short press to call preset 1
8	Preset 2 Key	Long press to set preset 2; short press to call preset 2
9	Standby Key	Long press to switch the camera to standby mode; short press to resume
10	Hang Up Key	Hang up the call
11	OK Key	Confirm selection
12	Mute Key	Turn on/off the microphone
13	Zoom Keys	Zoom in the lens [+]; Zoom out the lens [-]
14	Speaker Mute Key	Turn on/off the speaker
15	Participants Tracking Key	Press to track the participants automatically
16	Menu Key	Press to enter or exit the OSD menu
17	Bluetooth Key	Enable/Disable the Bluetooth function

7 Product Dimension

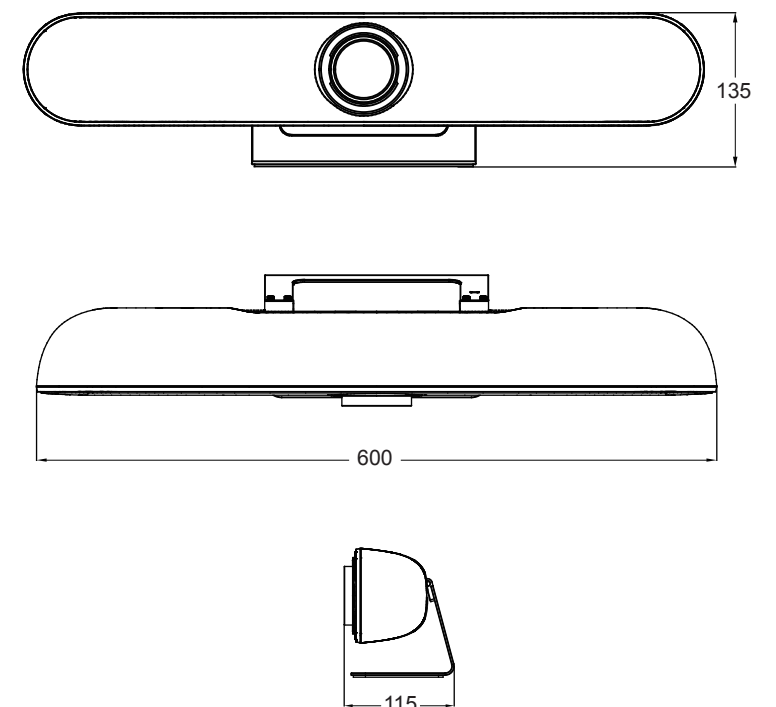

8 Installation and Connection

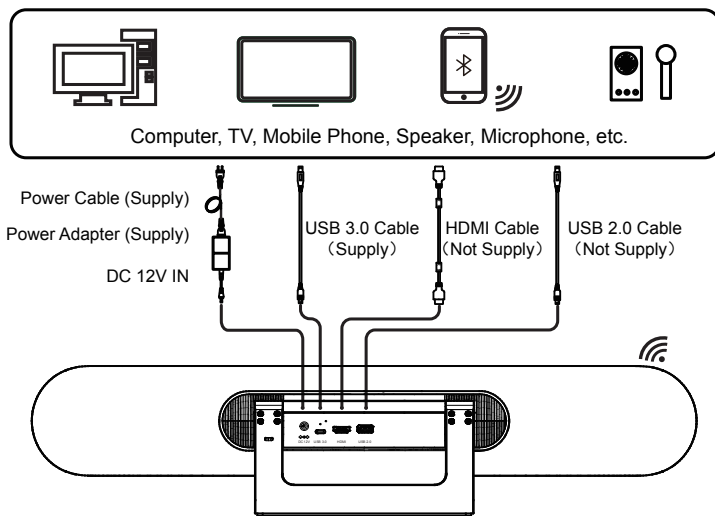
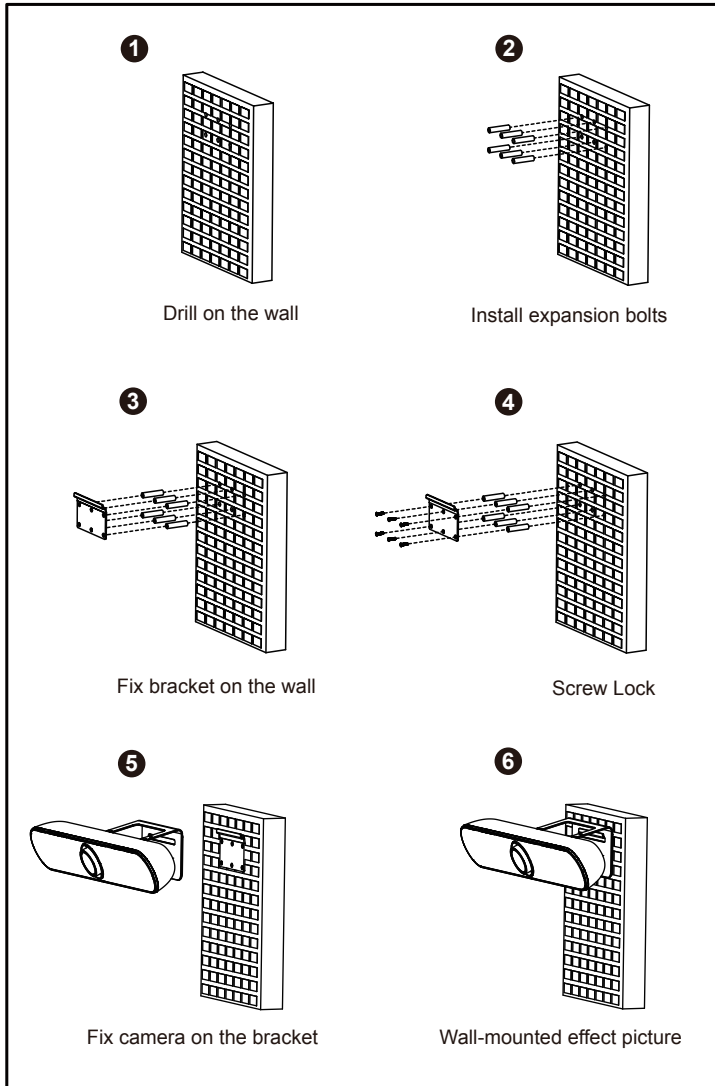

9 Remote Control Pairing

Note: The remote control has been paired with the whole machine when it leaves the factory, and it can be used normally without special operations. Unless there is an abnormal remote control, the whole remote control is confused, the remote control is missing, etc., and the remote control needs to be re-matched, the following steps are used to re-pair.

Step 1 Connect the camera to the power supply and wait for the camera initialization to complete, and the camera can output pictures normally.

Step 2 Clear the paired status of the remote control:

Press and hold the Menu + OK button at the same time until the remote control indicator light with steady red, release the buttons to clear the paired status of remote control.

Step 3 Trigger the camera to enter the remote control pairing mode:

Use the card pin to poke the reset button of the camera, the camera's LED light will switch to a blue marquee effect when it enters the pairing mode normally. (Note: There is only 15s operation time while entering the pairing mode. After the timeout, the pairing mode will be automatically exited and the LED is not a blue marquee effect. Press the reset button again to reenter the remote control pairing mode.)

Step 4 Start pairing: Press and hold the Menu button until the indicator on the complete. When the normal pairing is successful paired, the camera's remote control light with red, and then wait for the matching to LED light is blue with a flashing effect. Now, your camera can be operated through the remote control normally. If the pairing fails, please repeat steps 2, 3 and 4 until the matching is successful.

10 GUI Settings

10.1 MENU

Press **[MENU]** key under normal image, the screen will display as below:

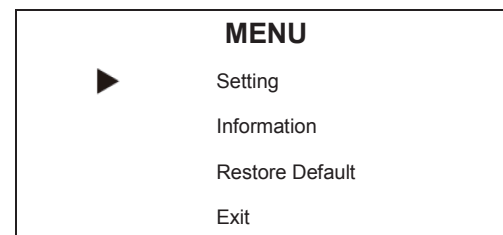

10.2 Setting

Move the cursor to "Setting" in the main menu, and press **[OK]** to enter the setting page as below:

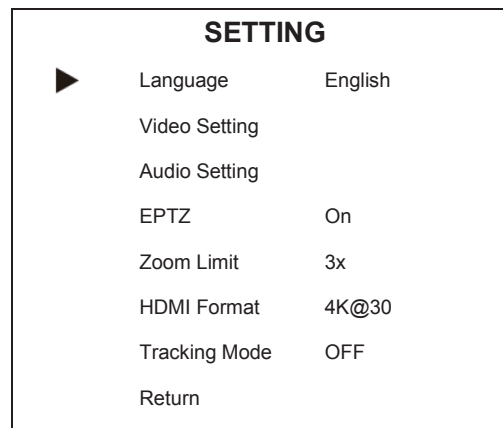

Language: Optional items: English, Chinese & Francais.
 Video Setting: Setting 2D NR, 3D NR, WD R Enable, Flip-H, Osd Mirroring.
 Audio Setting: Setting 3A Enable, Mic Equalizer.
 EPTZ: Optional items: On, Off.
 Zoom Limit: Optional items: 1.5x, 2x, 3x, 4x, 5x.
 HDMI Format: Optional items: 1080P@60, 1080P@50, 1080P@30, 4K@30.
 Tracking Mode: Optional items: Off, Participants, Speaker.
 Tracking Effect: Optional items: Smooth, Instaneous (Effective only in Participants or Speaker of Tracking Mode).
 Tracking Speed: Optional items: Slow, Normal, Fast (Effective only in Participants or Speaker of Tracking Mode).

10.3 Information

Move the cursor to "Information" in the main menu, and press **[OK]** to enter the information page as below:

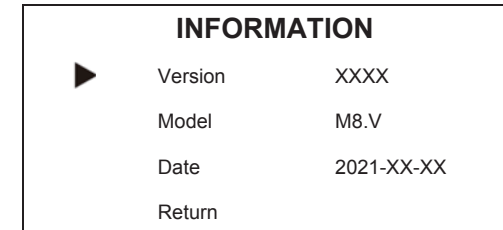

Note: The above information is for reference only, please refer to the real product for the actual specification.

10.4 Restore Default

Move the cursor to "Restore Default" in the main menu, and press **[OK]** to enter the restore default page as below:

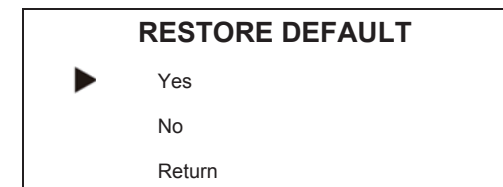

Yes / No: Confirm or cancel restore factory settings.



GUI menu and parameter information are subject to change without notice.

11 Maintenance & Troubleshooting

Camera Maintenance

- If camera is not use in long-term, please disconnect power switch after use.
- Use soft cloth or cotton paper to remove dust from the camera housing.
- When cleaning the camera lens, please use dry soft cloth to wipe, if dirt is serious, use neutral cleaner gently. Do not use strong or corrosive detergent, lest the lens scratch, affect the image effect.

Avoid Using

- The camera should avoid shooting particularly bright objects, such as sunlight, lights, etc.
- The camera should not work under unstable lighting conditions, otherwise the image will flash.
- Do not use around facilities that can transmit high-power radio waves, such as television station or radio-transmitting station.

Troubleshooting

The video image displayed by the camera lens has jitter.

- 1) Check whether the camera installed position be stabled.
- 2) Check whether have vibrating machinery or object near the camera.

12 FCC & IC Statement

NOTE: This equipment has been tested and found to comply with the limits for a Class B digital device, pursuant to part 15 of the FCC Rules. These limits are designed to provide reasonable protection against harmful interference in a residential installation. This equipment generates uses and can radiate radio frequency energy and, if not installed and used in accordance with the instructions, may cause harmful interference to radio communications. However, there is no guarantee that interference will not occur in a particular installation. If this equipment does cause harmful interference to radio or television reception, which can be determined by turning the equipment off and on, the user is encouraged to try to correct the interference by one or more of the following measures:

- Reorient or relocate the receiving antenna.
- Increase the separation between the equipment and receiver.
- Connect the equipment into an outlet on a circuit different from that to which the receiver is connected.
- Consult the dealer or an experienced radio/TV technician for help

Changes or modifications not expressly approved by the party responsible for compliance could void the user's authority to operate the equipment.

This device complies with Part 15 of the FCC Rules. Operation is subject to the following two conditions:

- (1) this device may not cause harmful interference, and (2) this device must accept any interference received, including interference that may cause undesired operation.

This device contains licence-exempt transmitter(s)/receiver(s) that comply with Innovation, Science and Economic Development Canada's licence-exempt RSS(s). Operation is subject to the following two conditions:

- (1) This device may not cause interference.
- (2) This device must accept any interference, including interference that may cause undesired operation of the device.

L'émetteur/récepteur exempt de licence contenu dans le présent appareil est conforme aux CNR d'Innovation, Sciences et Développement économique Canada applicables aux appareils radio exempts de licence. L'exploitation est autorisée aux deux conditions suivantes :

- (1) L' appareil ne doit pas produire de brouillage;
- (2) L' appareil doit accepter tout brouillage radioélectrique subi, même si le brouillage est susceptible d' en compromettre le fonctionnement.