



TESTING LABORATORY
CERTIFICATE#4323.01



FCC PART 15.247

TEST REPORT

For

Hangzhou Sciener Intelligent Control Technology Co., Ltd

Room 902, Bldg. A, Wenyixi Road 1001#, Yuhang District, Hangzhou City, Zhejiang, China

FCC ID: 2ATF2-K2

Report Type: Original Report	Product Type: Access Control
Test Engineer:	Lee.Li
Report Number:	RSHD191223001-00A
Report Date:	2020-02-20
Reviewed By:	Oscar Ye EMC Manager
Prepared By:	Bay Area Compliance Laboratories Corp. (Kunshan) No.248 Chenghu Road,Kunshan,Jiangsu province,China Tel: +86-0512-86175000 Fax: +86-0512-88934268 www.baclcorp.com.cn

Note: This test report is prepared for the customer shown above and for the device described herein. It may not be duplicated or used in part without prior written consent from Bay Area Compliance Laboratories Corp. This report is valid only with a valid digital signature. The digital signature may be available only under the Adobe software above version 7.0.

TABLE OF CONTENTS

GENERAL INFORMATION	4
PRODUCT DESCRIPTION FOR EQUIPMENT UNDER TEST (EUT)	4
OBJECTIVE	4
RELATED SUBMITTAL(S)/GRANT(S).....	4
TEST METHODOLOGY	5
MEASUREMENT UNCERTAINTY	5
TEST FACILITY	5
SYSTEM TEST CONFIGURATION	6
DESCRIPTION OF TEST CONFIGURATION	6
EQUIPMENT MODIFICATIONS	6
EUT EXERCISE SOFTWARE	6
SUPPORT EQUIPMENT LIST AND DETAILS	8
EXTERNAL I/O CABLE.....	8
BLOCK DIAGRAM OF TEST SETUP	8
SUMMARY OF TEST RESULTS	10
TEST EQUIPMENT LIST	11
FCC §1.1310& §2.1091 - MAXIMUM PERMISSIBLE EXPOSURE (MPE)	12
APPLICABLE STANDARD	12
CALCULATED FORMULARY:.....	12
CALCULATED DATA:.....	12
FCC §15.203 - ANTENNA REQUIREMENT	13
APPLICABLE STANDARD	13
ANTENNA CONNECTOR CONSTRUCTION	13
FCC §15.207 (a) - AC LINE CONDUCTED EMISSIONS	14
APPLICABLE STANDARD	14
EUT SETUP	14
EMI TEST RECEIVER SETUP.....	14
TEST PROCEDURE.....	14
CORRECTED FACTOR & OVER LIMIT CALCULATION.....	15
TEST RESULTS SUMMARY	15
TEST DATA	16
FCC §15.209, §15.205 & §15.247(d) - SPURIOUS EMISSIONS	18
APPLICABLE STANDARD	18
EUT SETUP	18
EMI TEST RECEIVER SETUP.....	19
TEST PROCEDURE.....	19
CORRECTED AMPLITUDE & MARGIN CALCULATION	19
TEST RESULTS SUMMARY	19
TEST DATA	20
FCC §15.247(a) (2) - 6 dB EMISSION BANDWIDTH	28
APPLICABLE STANDARD	28
TEST PROCEDURE.....	28
TEST DATA	28
FCC §15.247(b) (3) - MAXIMUM CONDUCTED OUTPUT POWER	31
APPLICABLE STANDARD	31
TEST PROCEDURE.....	31

TEST DATA 32

FCC §15.247(d) - BAND EDGE 34

 APPLICABLE STANDARD 34

 TEST PROCEDURE..... 34

 TEST DATA 35

FCC §15.247(e) - POWER SPECTRAL DENSITY..... 37

 APPLICABLE STANDARD 37

 TEST PROCEDURE..... 37

 TEST DATA 37

GENERAL INFORMATION

Product Description for Equipment under Test (EUT)

Applicant	Hangzhou Sciener Intelligent Control Technology Co., Ltd
Tested Model	K2F
Series Model	K2
Model difference	See declaration letter
Product Type	Access Control
Power Supply	DC12V
Operating Frequency	2402~2480MHz
Channel Number	40
Channel Separation	2MHz
Modulation Type	GFSK
Antenna Type	PCB Antenna
Maximum Antenna Gain	0dBi

**All measurement and test data in this report was gathered from production sample serial number: 20191223001. (Assigned by the BACL. The EUT supplied by the applicant was received on 2019-12-23).*

Objective

This report is prepared on behalf of *Hangzhou Sciener Intelligent Control Technology Co., Ltd.* in accordance with Part 2-Subpart J, Part 15-Subparts A and C of the Federal Communication Commissions' rules.

The tests were performed in order to determine compliance with FCC Part 15, Subpart C, and section 15.203, 15.205, 15.207, 15.209 and 15.247 rules.

Related Submittal(s)/Grant(s)

FCC Part 15.225 DXX submissions with FCC ID: 2ATF2-K2

Test Methodology

All measurements contained in this report were conducted with ANSI C63.10-2013, American National Standard of Procedures for Compliance Testing of Unlicensed Wireless Devices and FCC KDB 558074 D01 15.247 Meas Guidance v05r02.

All emissions measurement was performed at Bay Area Compliance Laboratories Corp. (Kunshan). The radiated testing was performed at an antenna-to-EUT distance of 3 meters.

Measurement Uncertainty

Item		Uncertainty
AC Power Lines Conducted Emissions		3.19 dB
RF conducted test with spectrum		0.9dB
RF Output Power with Power meter		0.5dB
Radiated emission	30MHz~1GHz	6.11dB
	1GHz~6GHz	4.45dB
	6GHz~18GHz	5.23dB
	18GHz~40GHz	5.65dB
Occupied Bandwidth		0.5kHz
Temperature		1.0°C
Humidity		6%

Otherwise required by the applicant or Product Regulations, Decision Rule in this report did not consider the uncertainty.

Test Facility

The test site used by Bay Area Compliance Laboratories Corp. (Kunshan) to collect test data is located on the No.248 Chenghu Road, Kunshan, Jiangsu province, China.

Bay Area Compliance Laboratories Corp. (Kunshan) Lab is accredited to ISO/IEC 17025 by A2LA (Lab code: 4323.01) and the FCC designation No. CN1185 under the FCC KDB 974614 D01 and CAB identifier CN0004 under the ISED requirement. The facility also complies with the radiated and AC line conducted test site criteria set forth in ANSI C63.4-2014.

SYSTEM TEST CONFIGURATION

Description of Test Configuration

Channel List for BLE mode:

Channel	Frequency (MHz)	Channel	Frequency (MHz)
0	2402	20	2442
1	2404
...
...
18	2438	38	2478
19	2440	39	2480

EUT was tested with channel 0, 19 and 39.

Equipment Modifications

No modification was made to the EUT tested.

EUT Exercise Software

RF test tool: EUT was tested under engineering mode.

Power Setting: Default

Duty Cycle:

Middle Channel

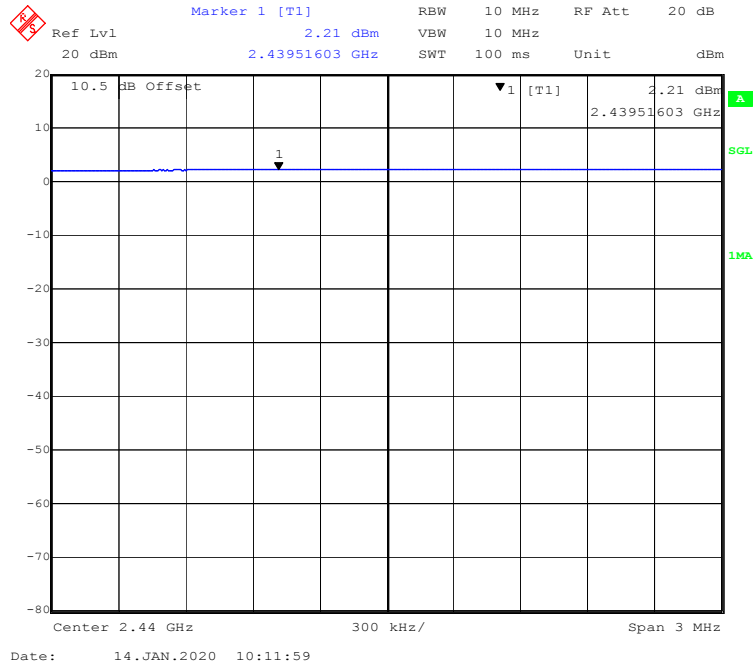

Mode	Duty Cycle (%)	T(ms)	1/T(kHz)	10log(1/x)
BLE	100	/	/	0

Note: “x” means the Duty Cycle.

Support Equipment List and Details

Manufacturer	Description	Model	Serial Number
ShenZhen SOY Technology Co.,Ltd	SWITCHING ADAPTER	SUN-1200100EU	/

External I/O Cable

Cable Description	Length (m)	From Port	To
Power Cable	1.0	EUT	Adapter

Block Diagram of Test Setup

For Conducted Emissions:

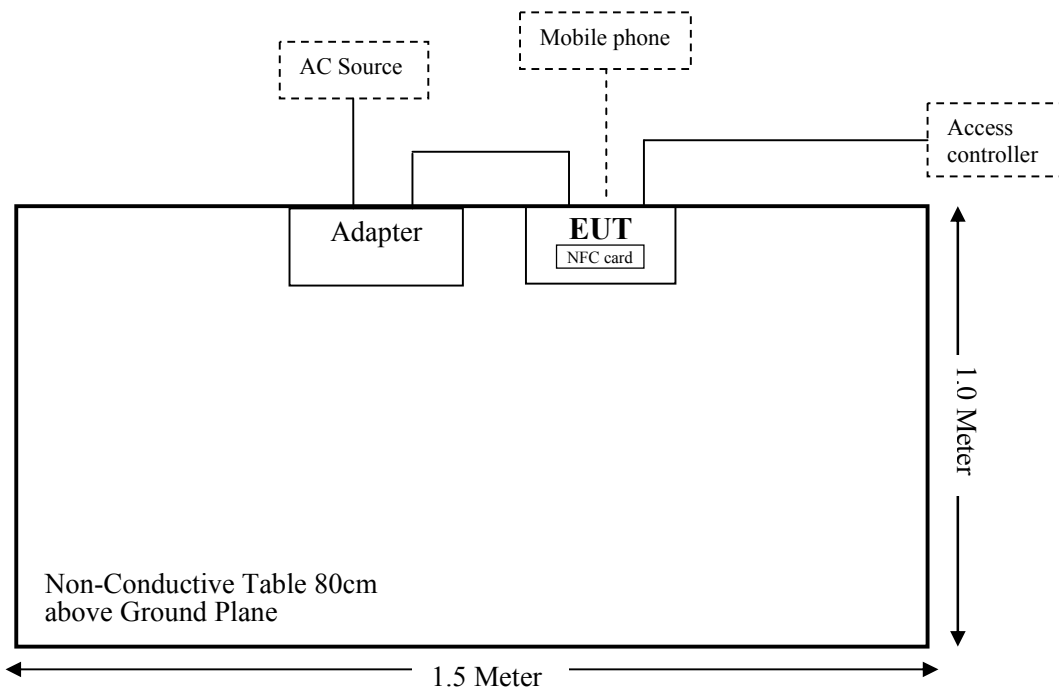

For Radiated Emissions(Below 1GHz):

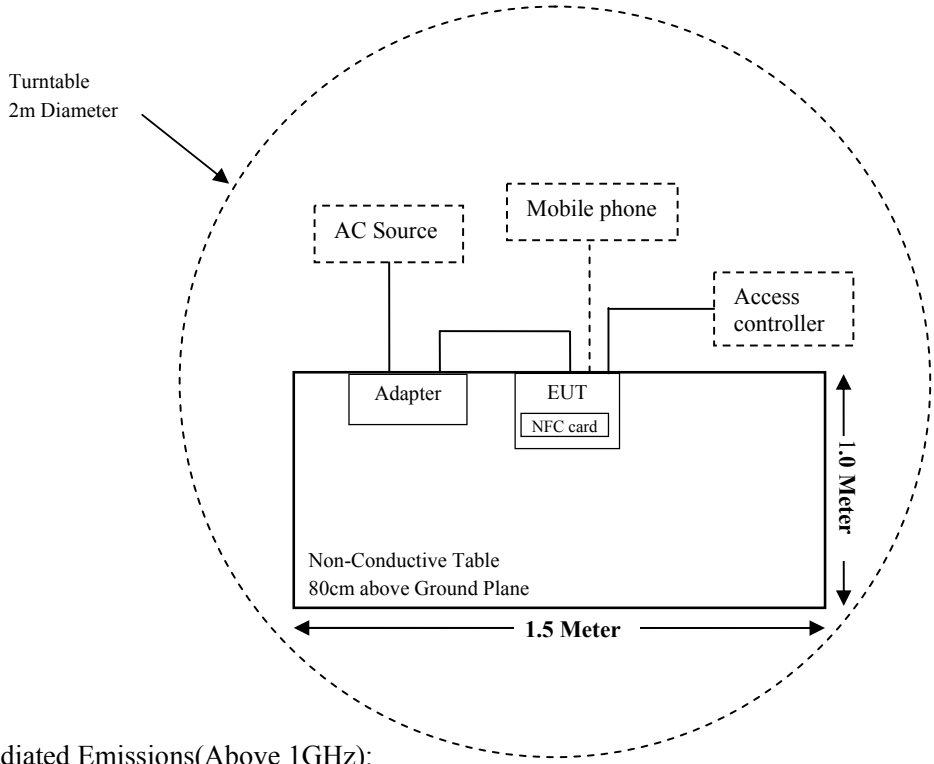

For Radiated Emissions(Above 1GHz):

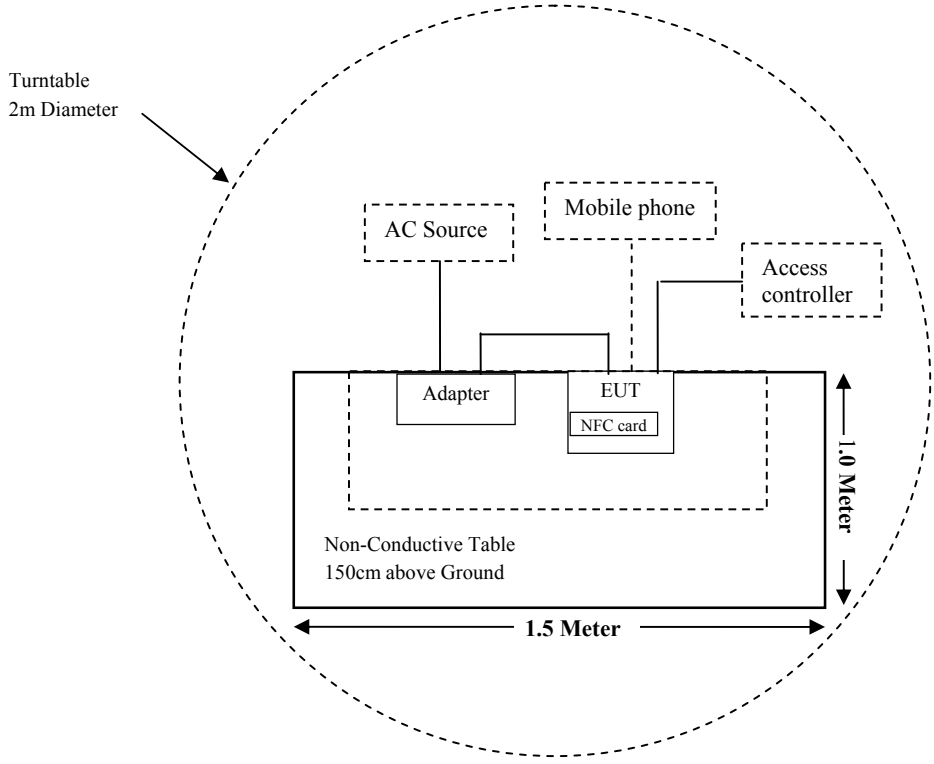

SUMMARY OF TEST RESULTS

FCC Rules	Description of Test	Result
§15.247 (i), §1.1310 & §2.1091	MAXIMUM PERMISSIBLE EXPOSURE	Compliant
§15.203	Antenna Requirement	Compliant
§15.207 (a)	AC Line Conducted Emissions	Compliant
§15.247(d)	Spurious Emissions at Antenna Port	Compliant
§15.205, §15.209, §15.247(d)	Spurious Emissions	Compliant
§15.247 (a)(2)	6 dB Emission Bandwidth	Compliant
§15.247(b)(3)	Maximum Conducted Output Power	Compliant
§15.247(d)	Band Edge	Compliant
§15.247(e)	Power Spectral Density	Compliant

TEST EQUIPMENT LIST

Manufacturer	Description	Model	Serial Number	Calibration Date	Calibration Due Date
Radiated Emission Test (Chamber 1#)					
Rohde & Schwarz	EMI Test Receiver	ESCI	100195	2019-11-30	2020-11-29
Sunol Sciences	Bilog antenna	JB3	A090413-1	2019-12-26	2022-12-25
Sonoma Instrument	Pre-amplifier	310N	171205	2019-08-14	2020-08-13
Rohde & Schwarz	Auto test Software	EMC32	100361	/	/
MICRO-COAX	Coaxial Cable	Cable-8	008	2019-08-15	2020-08-14
MICRO-COAX	Coaxial Cable	Cable-9	009	2019-08-15	2020-08-14
MICRO-COAX	Coaxial Cable	Cable-10	010	2019-08-15	2020-08-14
Radiated Emission Test (Chamber 2#)					
Rohde & Schwarz	EMI Test Receiver	ESU40	100207	2019-05-30	2020-05-29
ETS-LINDGREN	Horn Antenna	3115	6229	2017-07-15	2020-07-14
ETS-LINDGREN	Horn Antenna	3116	00084159	2019-12-12	2022-12-12
A.H.Systems, inc	Preamplifier	2641-1	491	2019-02-20	2020-02-19
SELECTOR	Amplifier	EM18G40G	060726	2019-03-22	2020-03-21
MICRO-TRONICS	Band Reject Filter	BRM50702	G024	2019-08-05	2020-08-04
Narda	Attenuator	10dB	010	2019-08-15	2020-08-14
Rohde & Schwarz	Auto test Software	EMC32	100361	/	/
MICRO-COAX	Coaxial Cable	Cable-6	006	2019-08-15	2020-08-14
MICRO-COAX	Coaxial Cable	Cable-11	011	2019-08-15	2020-08-14
MICRO-COAX	Coaxial Cable	Cable-12	012	2019-08-15	2020-08-14
MICRO-COAX	Coaxial Cable	Cable-13	013	2019-08-15	2020-08-14
RF Conducted Test					
Rohde & Schwarz	Signal Analyzer	FSIQ26	836131/009	2019-11-30	2020-11-29
Narda	Attenuator	10dB	010	2019-08-15	2020-08-14
Hangzhou Sciener Intelligent Control Technology Co., Ltd	RF Cable	Hangzhou Sciener Intelligent Control Technology Co., Ltd C01	C01	Each Time	N/A
Conducted Emission Test					
Rohde & Schwarz	EMI Test Receiver	ESR	1316.3003K03-101746-zn	2019-07-11	2020-07-10
Audix	Test Software	e3	V9	--	--
Rohde & Schwarz	LISN	ENV216	3560655016	2019-11-30	2020-11-29
Rohde & Schwarz	Pulse limiter	ESH3-Z2	0357.8810.54	2019-08-10	2020-08-09
MICRO-COAX	Coaxial Cable	Cable-15	015	2019-08-15	2020-08-14

* **Statement of Traceability:** Bay Area Compliance Laboratories Corp. (Kunshan) attests that all calibrations have been performed in accordance to requirements that traceable to National Primary Standards and International System of Units (SI).

FCC §1.1310& §2.1091 - MAXIMUM PERMISSIBLE EXPOSURE (MPE)

Applicable Standard

According to subpart 15.247(i) and subpart §1.1310, systems operating under the provisions of this section shall be operated in a manner that ensures that the public is not exposed to radio frequency energy level in excess of the Commission’s guidelines.

Limits for Maximum Permissible Exposure (MPE) (§1.1310, §2.1091)

(B) Limits for General Population/Uncontrolled Exposure				
Frequency Range (MHz)	Electric Field Strength (V/m)	Magnetic Field Strength (A/m)	Power Density (mW/cm²)	Averaging Time (minutes)
0.3-1.34	614	1.63	*(100)	30
1.34-30	824/f	2.19/f	*(180/f ²)	30
30-300	27.5	0.073	0.2	30
300-1500	/	/	f/1500	30
1500-100,000	/	/	1.0	30

f = frequency in MHz; * = Plane-wave equivalent power density;

According to §1.1310 and §2.1091 RF exposure is calculated.

Calculated Formulary:

Predication of MPE limit at a given distance

$S = PG/4\pi R^2$ = power density (in appropriate units, e.g. mW/cm²);

P = power input to the antenna (in appropriate units, e.g., mW);

G = power gain of the antenna in the direction of interest relative to an isotropic radiator, the power gain factor, is normally numeric gain;

R = distance to the center of radiation of the antenna (appropriate units, e.g., cm);

Calculated Data:

Mode	Frequency Range (MHz)	Antenna Gain		Tune-up Conducted Power		Evaluation Distance (cm)	Power Density (mW/cm²)	MPE Limit (mW/cm²)
		(dBi)	(numeric)	(dBm)	(mW)			
BLE	2402~2480	0.00	1.00	2.5	1.78	20	0.0004	1.0

Note: For the above Tune-up Conducted power were declared by the manufacturer.

Conclusion: The device meets MPE at distance 20cm.

FCC §15.203 - ANTENNA REQUIREMENT

Applicable Standard

According to § 15.203, an intentional radiator shall be designed to ensure that no antenna other than that furnished by the responsible party shall be used with the device. The use of a permanently attached antenna or of an antenna that uses a unique coupling to the intentional radiator shall be considered sufficient to comply with the provisions of this section. The manufacturer may design the unit so that a broken antenna can be replaced by the user, but the user of a standard antenna jack or electrical connector is prohibited. The structure and application of the EUT were analyzed to determine compliance with section §15.203 of the rules. §15.203 state that the subject device must meet the following criteria:

- a. Antenna must be permanently attached to the unit.
- b. Antenna must use a unique type of connector to attach to the EUT.

Unit must be professionally installed, and installer shall be responsible for verifying that the correct antenna is employed with the unit.

And according to FCC 47 CFR section 15.247 (b), if the transmitting antennas of directional gain greater than 6dBi are used, the power shall be reduced by the amount in dB that the directional gain of the antenna exceeds 6 dBi.

Antenna Connector Construction

The EUT has a PCB antenna for BLE which was permanently attached and the antenna gain is 0 dBi; fulfill the requirement of this section. Please refer to the EUT photos.

Result: Pass.

FCC §15.207 (a) - AC LINE CONDUCTED EMISSIONS

Applicable Standard

FCC§15.207

EUT Setup

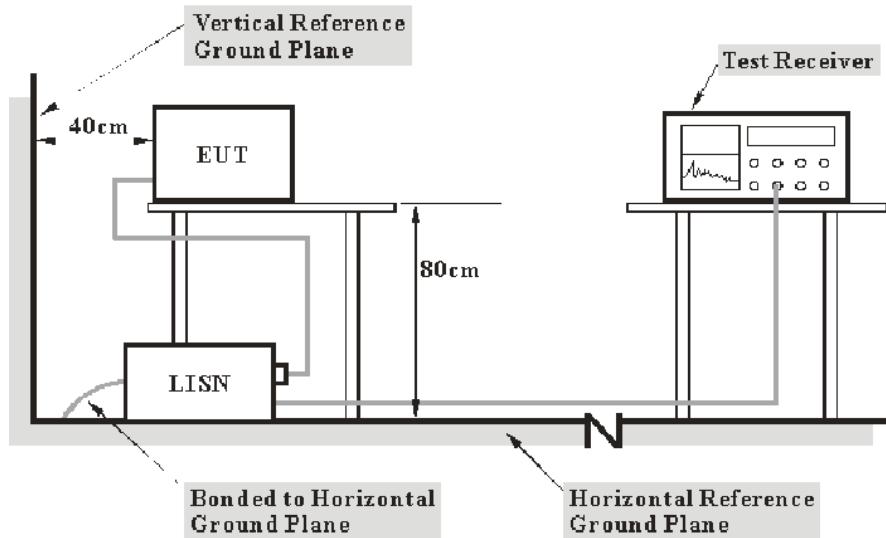

- Note: 1. Support units were connected to second LISN.
 2. Both of LISNs (AMN) 80 cm from EUT and at the least 80 cm from other units and other metal planes support units.

The setup of EUT is according with per ANSI C63.10-2013 measurement procedure. The specification used was with the FCC Part 15.207 limits.

EMI Test Receiver Setup

The EMI test receiver was set to investigate the spectrum from 150 kHz to 30 MHz.

During the conducted emission test, the EMI test receiver was set with the following configurations:

Frequency Range	IF B/W
150 kHz - 30 MHz	9 kHz

Test Procedure

During the conducted emission test, the Adapter was connected to the outlet of the LISN.

Maximizing procedure was performed on the six (6) highest emissions of the EUT.

All data was recorded in the Quasi-peak and average detection mode.

Corrected Factor & Over Limit Calculation

The Corrected Factor is calculated by adding LISN VDF (Voltage Division Factor), Cable Loss and Transient Limiter Attenuation. The basic equation is as follows:

$$\text{Factor (dB)} = \text{LISN VDF (dB)} + \text{Cable Loss (dB)} + \text{Transient Limiter Attenuation (dB)}$$

The “**Over Limit**” column of the following data tables indicates the degree of compliance with the applicable limit. For example, an over Limit of 7dB means the emission is 7 dB above the limit. The equation for over Limit calculation is as follows:

$$\text{Over Limit (dB)} = \text{Read level (dB}\mu\text{V)} + \text{Factor (dB)} - \text{Limit (dB}\mu\text{V)}$$

Test Results Summary

According to the recorded data in following table, the EUT complied with the FCC Part 15.207.

Test Data

Environmental Conditions

Temperature:	25.2°C
Relative Humidity:	49 %
ATM Pressure:	101.2 kPa

The testing was performed by Lee.Li on 2020-01-08.

EUT operation mode: Transmitting

AC 120V/60 Hz, Line

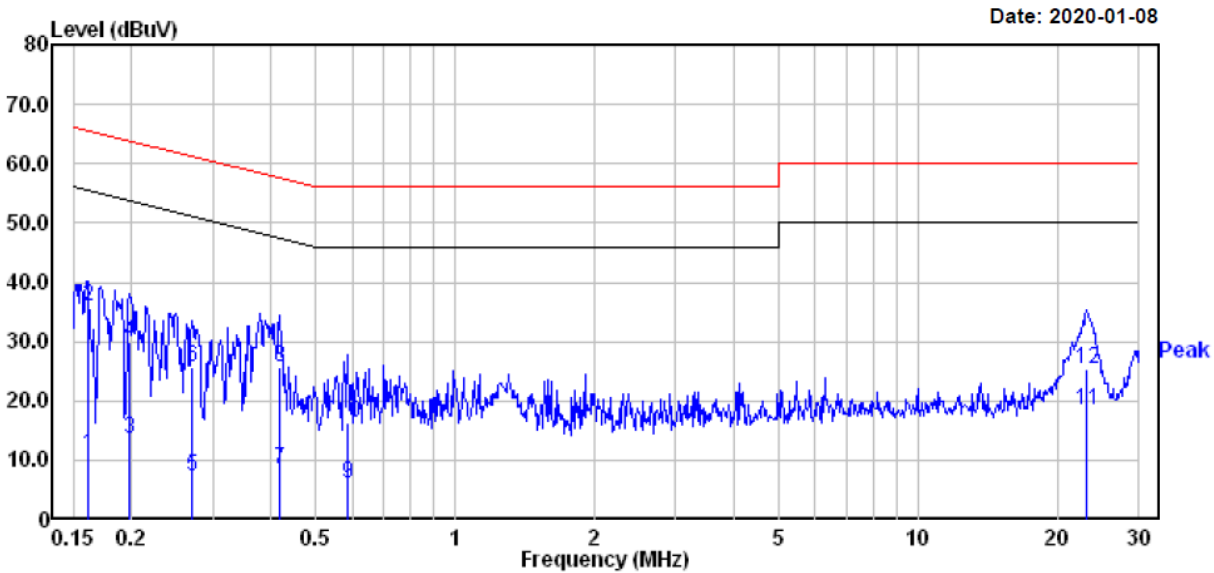

	Freq	Read Level	Factor	Level	Limit Line	Over Limit	Remark
	MHz	dBuV	dB	dBuV	dBuV	dB	
1	0.161	-9.10	19.83	10.73	55.43	-44.70	Average
2	0.161	16.20	19.83	36.03	65.43	-29.40	QP
3	0.199	-6.10	19.82	13.72	53.67	-39.95	Average
4	0.199	10.00	19.82	29.82	63.67	-33.85	QP
5	0.270	-12.70	19.82	7.12	51.12	-44.00	Average
6	0.270	5.90	19.82	25.72	61.12	-35.40	QP
7	0.419	-11.20	19.74	8.54	47.46	-38.92	Average
8	0.419	6.00	19.74	25.74	57.46	-31.72	QP
9	0.585	-13.70	19.75	6.05	46.00	-39.95	Average
10	0.585	-3.40	19.75	16.35	56.00	-39.65	QP
11	23.140	-1.41	19.79	18.38	50.00	-31.62	Average
12	23.140	5.49	19.79	25.28	60.00	-34.72	QP

AC 120V/60 Hz, Neutral

Date: 2020-01-08

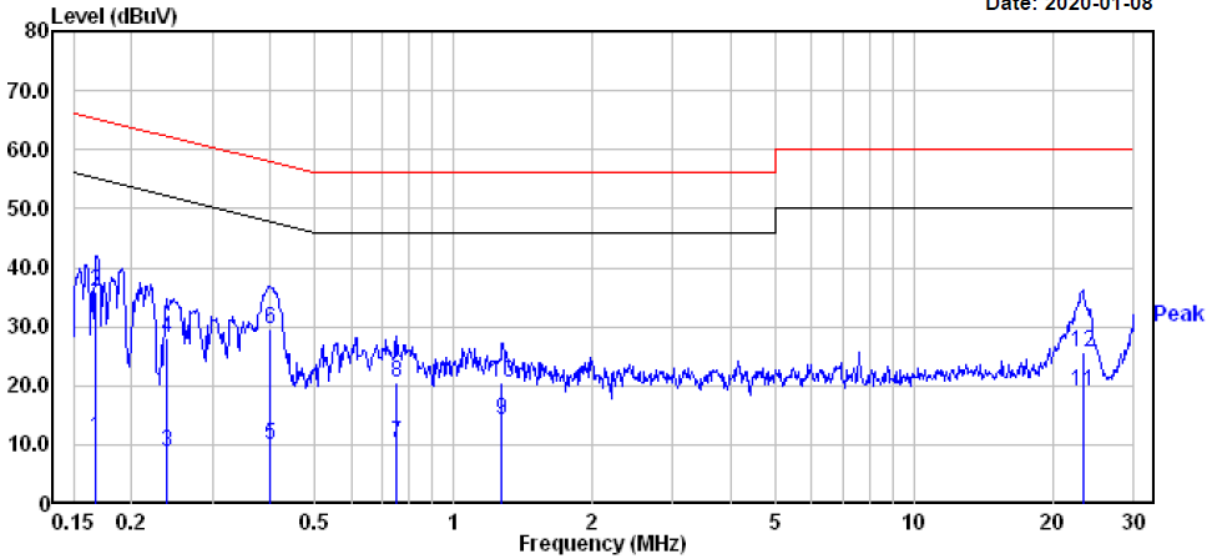

	Freq	Read Level	Factor	Level	Limit Line	Over Limit	Remark
	MHz	dBuV	dB	dBuV	dBuV	dB	
1	0.168	-8.70	19.83	11.13	55.08	-43.95	Average
2	0.168	16.00	19.83	35.83	65.08	-29.25	QP
3	0.238	-11.10	19.82	8.72	52.17	-43.45	Average
4	0.238	8.30	19.82	28.12	62.17	-34.05	QP
5	0.400	-9.70	19.74	10.04	47.86	-37.82	Average
6	0.400	9.90	19.74	29.64	57.86	-28.22	QP
7	0.755	-9.50	19.72	10.22	46.00	-35.78	Average
8	0.755	0.90	19.72	20.62	56.00	-35.38	QP
9	1.276	-5.50	19.82	14.32	46.00	-31.68	Average
10	1.276	0.60	19.82	20.42	56.00	-35.58	QP
11	23.263	-0.70	19.78	19.08	50.00	-30.92	Average
12	23.263	5.80	19.78	25.58	60.00	-34.42	QP

Note:

- 1) Factor (dB) = LISN VDF (dB) + Cable Loss (dB) + Transient Limiter Attenuation (dB)
- 2) Over Limit (dB) = Read level (dBμV) + Factor (dB) - Limit (dBμV)

FCC §15.209, §15.205 & §15.247(d) - SPURIOUS EMISSIONS

Applicable Standard

FCC §15.247 (d); §15.209; §15.205;

EUT Setup

Below 1 GHz:

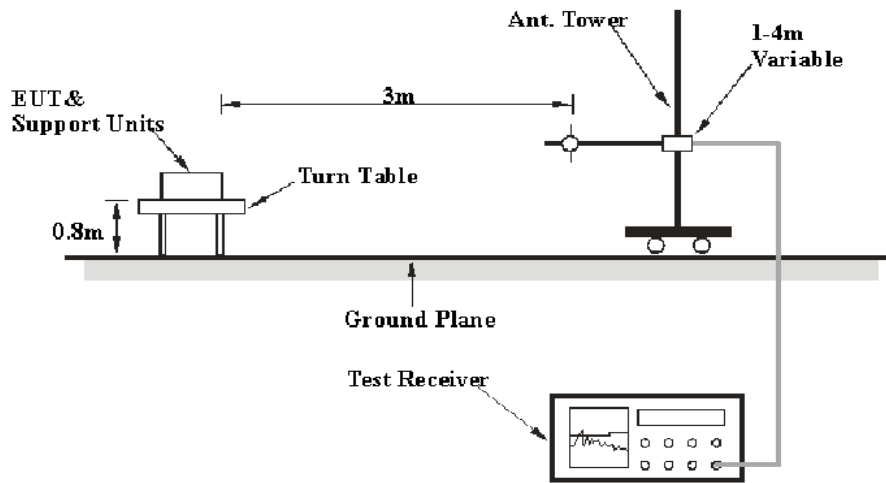

Above 1GHz:

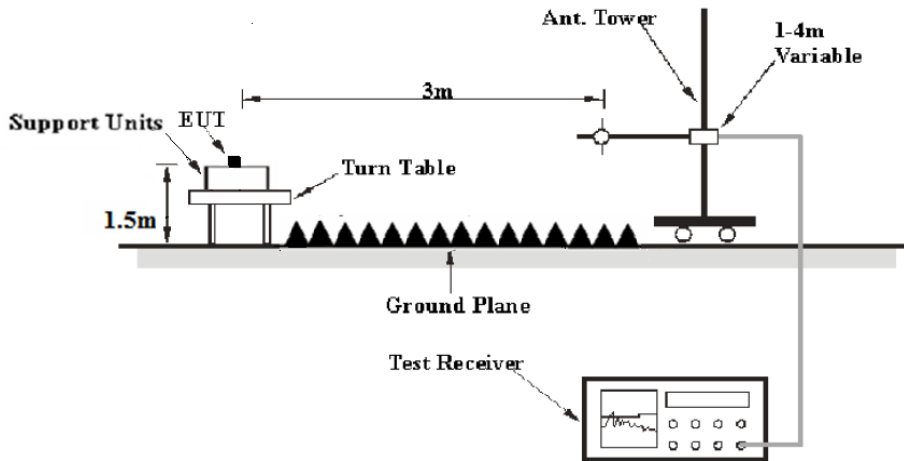

The radiated emission tests were performed in the 3 meters test site, using the setup accordance with the ANSI C63.10-2013. The specification used was the FCC 15.209, and FCC 15.247 limits.

EMI Test Receiver Setup

The system was investigated from 30 MHz to 25 GHz.

During the radiated emission test, the EMI test receiver Setup was set with the following configurations:

Frequency Range	RBW	Video B/W	IF B/W	Detector
30 MHz - 1000 MHz	120 kHz	300 kHz	120 kHz	QP
Above 1GHz	1MHz	3 MHz	/	PK
	1MHz	3 MHz	/	Ave

Test Procedure

Maximizing procedure was performed on the highest emissions to ensure that the EUT complied with all installation combinations.

Data was recorded in Quasi-peak detection mode for frequency range of 30 MHz - 1 GHz, peak and Average detection modes for frequencies above 1 GHz.

Corrected Amplitude & Margin Calculation

The Corrected Amplitude is calculated by adding the Antenna Factor and Cable Loss, and subtracting the Amplifier Gain from the Meter Reading. The basic equation is as follows:

Corrected Amplitude (dB μ V /m) = Meter Reading (dB μ V) + Antenna Factor (dB/m) + Cable Loss (dB) - Amplifier Gain (dB)

The “**Margin**” column of the following data tables indicates the degree of compliance with the applicable limit. For example, a margin of 7dB means the emission is 7dB below the limit. The equation for margin calculation is as follows:

Margin (dB) = Limit (dB μ V/m) - Corrected Amplitude (dB μ V /m)

Test Results Summary

According to the recorded data in following table, the EUT complied with the FCC Title 47, Part 15, Subpart C, section 15.205, 15.209 and 15.247.

Test Data

Environmental Conditions

Temperature:	21.1-22.1 °C
Relative Humidity:	49-50%
ATM Pressure:	101.1-101.2 kPa

The testing was performed by Lee.Li from 2020-01-10 to 2020-01-18.

EUT operation mode: Transmitting

Spurious Emission Test:

30MHz ~ 1GHz:

(Pre-scan with low, middle and high channels of operation in the X,Y and Z axes of orientation, the worst case middle channel of operation in X-axis of orientation was recorded)

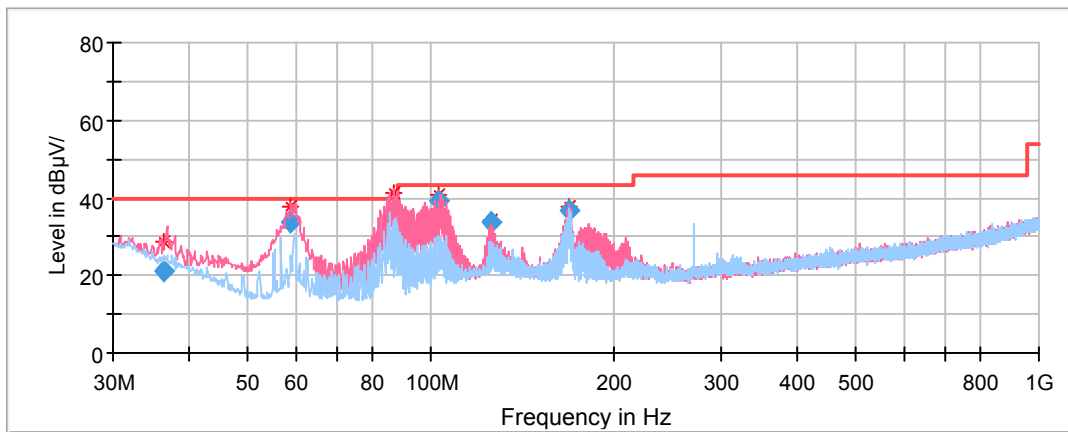

Frequency (MHz)	Corrected Amplitude	Rx Antenna		Turntable Degree	Corrected Factor (dB/m)	Limit (dBµV/m)	Margin (dB)
	QuasiPeak (dBµV/m)	Height (cm)	Polar (H/V)				
36.263800	20.95	100.0	V	181.0	-8.2	40.00	19.05
58.877550	33.81	100.0	V	176.0	-17.9	40.00	6.19
86.777700	36.95	100.0	V	238.0	-17.6	40.00	3.05
102.730300	39.13	100.0	V	253.0	-14.4	43.50	4.37
125.682750	33.87	100.0	V	201.0	-11.4	43.50	9.63
168.423650	36.52	100.0	V	331.0	-13.1	43.50	6.98

1GHz-18GHz

(Pre-scan in the X,Y and Z axes of orientation, the worst case Y-axis of orientation was recorded.)

Note:

1. This test was performed with the 2.4 - 2.5GHz notch filter.
2. Corrected Factor (dB/m) = Antenna factor (RX) (dB/m) + Cable Loss (dB) - Amplifier Factor (dB)
 Corrected Amplitude (dBµV/m) = Corrected Factor (dB/m) + Reading (dBµV)
 Margin (dB) = Limit (dBµV/m) - Corrected Amplitude (dBµV /m)

Low Channel: 2402MHz

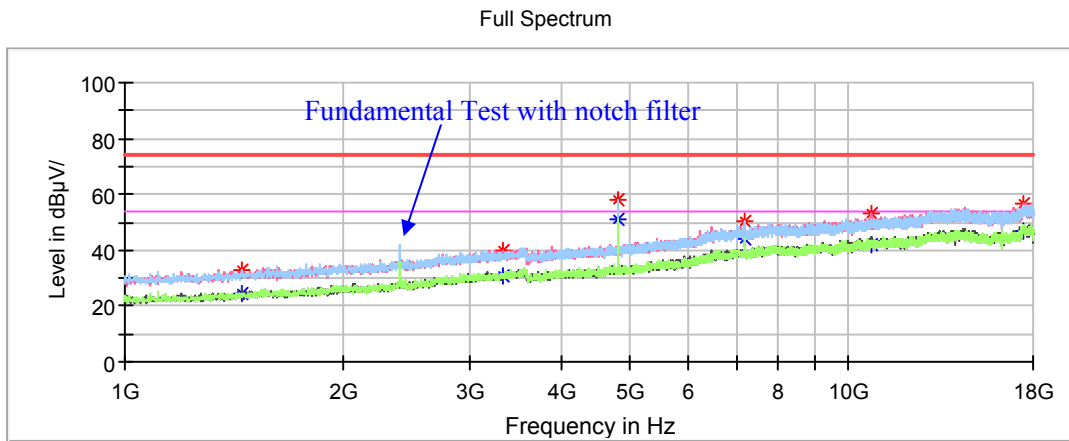

Frequency (MHz)	Corrected Amplitude		Rx Antenna		Turntable Degree	Corrected Factor (dB/m)	Limit (dBµV/m)	Margin (dB)
	MaxPeak (dBµV/m)	Average (dBµV/m)	Height (cm)	Polar (H/V)				
1452.200000	---	24.35	100.0	H	90.0	-10.2	54.00	29.65
1452.200000	33.19	---	100.0	H	90.0	-10.2	74.00	40.81
3325.600000	---	31.00	200.0	V	184.0	-3.8	54.00	23.00
3325.600000	39.83	---	200.0	V	184.0	-3.8	74.00	34.17
4804.000000	58.00	---	100.0	H	122.0	-0.6	74.00	16.00
4804.000000	---	50.20	100.0	H	122.0	-0.6	54.00	3.80
7206.000000	---	44.13	200.0	H	340.0	5.7	54.00	9.87
7206.000000	50.27	---	200.0	H	340.0	5.7	74.00	23.73
10744.400000	---	41.81	100.0	V	302.0	9.4	54.00	12.19
10744.400000	52.85	---	100.0	V	302.0	9.4	74.00	21.15
17425.400000	---	47.00	200.0	V	302.0	13.9	54.00	7.00
17425.400000	56.55	---	200.0	V	302.0	13.9	74.00	17.45

Middle Channel: 2440MHz

Full Spectrum

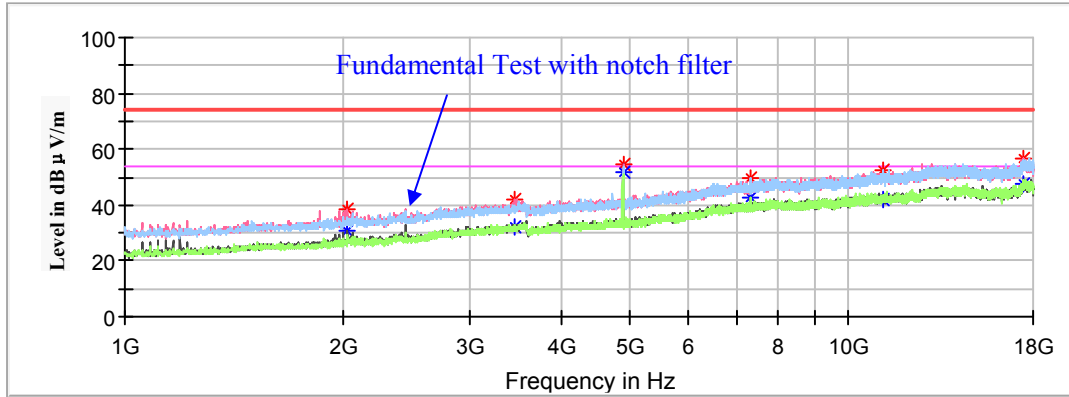

Frequency (MHz)	Corrected Amplitude		Rx Antenna		Turntable Degree	Corrected Factor (dB/m)	Limit (dBμV/m)	Margin (dB)
	MaxPeak (dBμV/m)	Average (dBμV/m)	Height (cm)	Polar (H/V)				
2033.600000	---	30.97	200.0	V	275.0	-8.2	54.00	23.03
2033.600000	38.57	---	200.0	V	275.0	-8.2	74.00	35.43
3451.400000	---	32.11	200.0	V	9.0	-3.6	54.00	21.89
3451.400000	42.21	---	200.0	V	9.0	-3.6	74.00	31.79
4880.000000	---	51.99	200.0	V	64.0	-0.4	54.00	3.01
4880.000000	54.72	---	200.0	V	64.0	-0.4	74.00	19.28
7320.000000	---	42.80	200.0	V	347.0	5.8	54.00	11.20
7320.000000	49.80	---	200.0	V	347.0	5.8	74.00	24.20
11171.100000	---	41.84	200.0	H	201.0	9.8	54.00	12.16
11171.100000	52.64	---	200.0	H	201.0	9.8	74.00	21.36
17491.700000	---	47.54	100.0	V	0.0	14.2	54.00	6.46
17491.700000	56.31	---	100.0	V	0.0	14.2	74.00	17.69

High Channel: 2480MHz

Full Spectrum

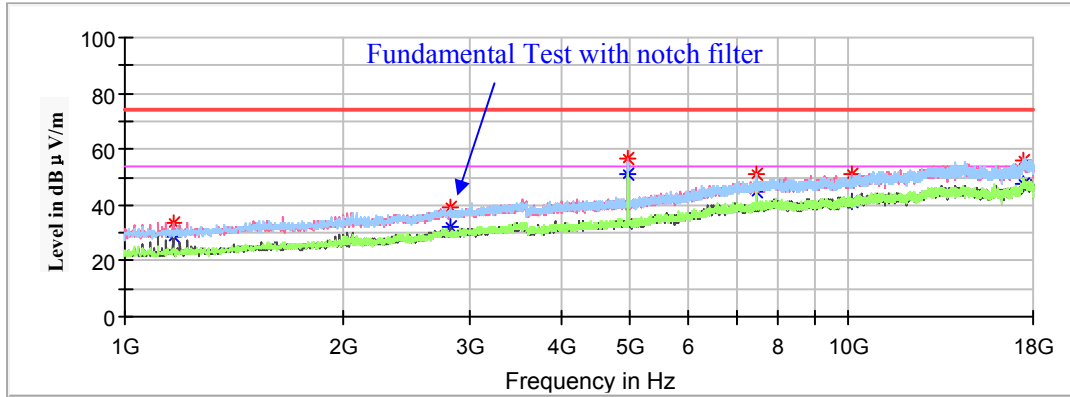

Frequency (MHz)	Corrected Amplitude		Rx Antenna		Turntable Degree	Corrected Factor (dB/m)	Limit (dBμV/m)	Margin (dB)
	MaxPeak (dBμV/m)	Average (dBμV/m)	Height (cm)	Polar (H/V)				
1164.900000	---	28.33	200.0	V	178.0	-11.8	54.00	25.67
1164.900000	33.76	---	100.0	V	173.0	-11.8	74.00	40.24
2812.200000	---	32.28	100.0	V	85.0	-5.3	54.00	21.72
2812.200000	39.05	---	100.0	V	85.0	-5.3	74.00	34.95
4960.000000	---	50.24	200.0	V	310.0	-0.3	54.00	3.76
4960.000000	56.81	---	200.0	V	310.0	-0.3	74.00	17.19
7440.000000	---	45.08	200.0	H	70.0	6.0	54.00	8.92
7440.000000	50.83	---	100.0	V	70.0	6.0	74.00	23.17
10134.100000	---	41.35	200.0	V	251.0	8.4	54.00	12.65
10134.100000	51.36	---	200.0	V	251.0	8.4	74.00	22.64
17483.200000	---	47.43	100.0	V	340.0	14.2	54.00	6.57
17483.200000	55.73	---	100.0	V	340.0	14.2	74.00	18.27

18GHz - 25GHz

(Pre-scan with low, middle and high channels of operation in the X,Y and Z axes of orientation, the worst case **middle** channel of operation in X-axis of orientation was recorded)

Horizontal

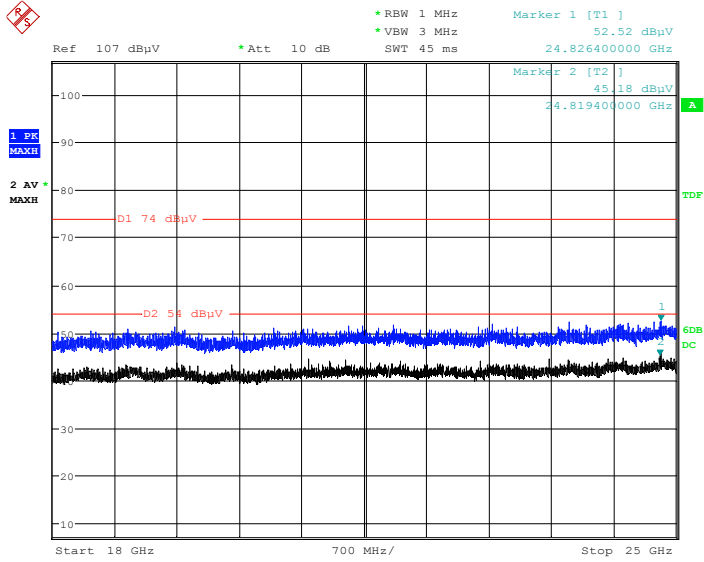

Date: 10.JAN.2020 09:56:10

Vertical

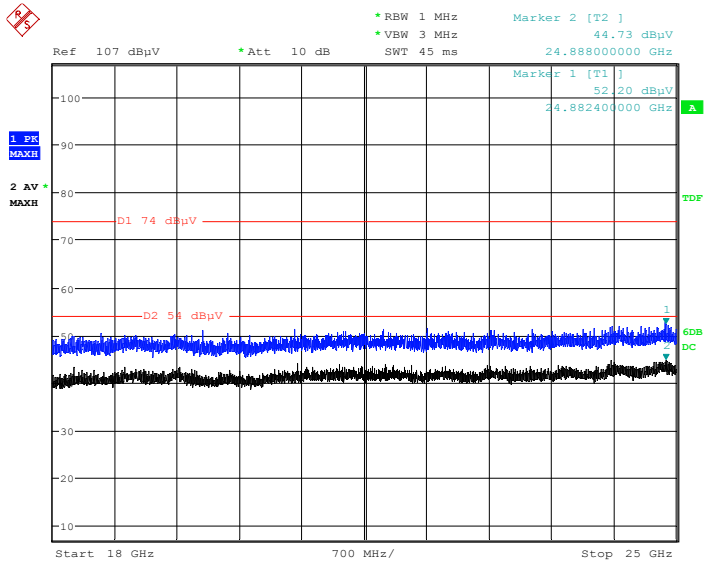

Date: 10.JAN.2020 09:24:54

Restricted Bands Emissions Test:

(Pre-scan in the X, Y and Z axes of orientation, the worst case Y-axis of orientation was recorded.)

Note:

- 1. Corrected Factor (dB/m) = Antenna factor (RX) (dB/m) + Cable Loss (dB) - Amplifier Factor (dB)
- Corrected Amplitude (dBµV/m) = Corrected Factor (dB/m) + Reading (dBµV)
- Margin (dB) = Limit (dBµV/m) - Corrected Amplitude (dBµV/m)

Frequency (MHz)	Corrected Amplitude		Rx Antenna		Turntable Degree	Corrected Factor (dB/m)	Limit (dBµV/m)	Margin (dB)
	MaxPeak (dBµV/m)	Average (dBµV/m)	Height (cm)	Polar (H/V)				
Low Channel: 2402MHz								
2390.00	---	44.96	200.0	V	0.0	2.8	54.00	9.04
2390.00	51.65	---	200.0	V	0.0	2.8	74.00	22.35
High Channel: 2480MHz								
2483.50	55.98	---	200.0	V	358.0	3.1	74.00	18.02
2483.50	---	50.47	200.0	V	358.0	3.1	54.00	3.53

Conducted Spurious Emissions at Antenna Port:

Low Channel

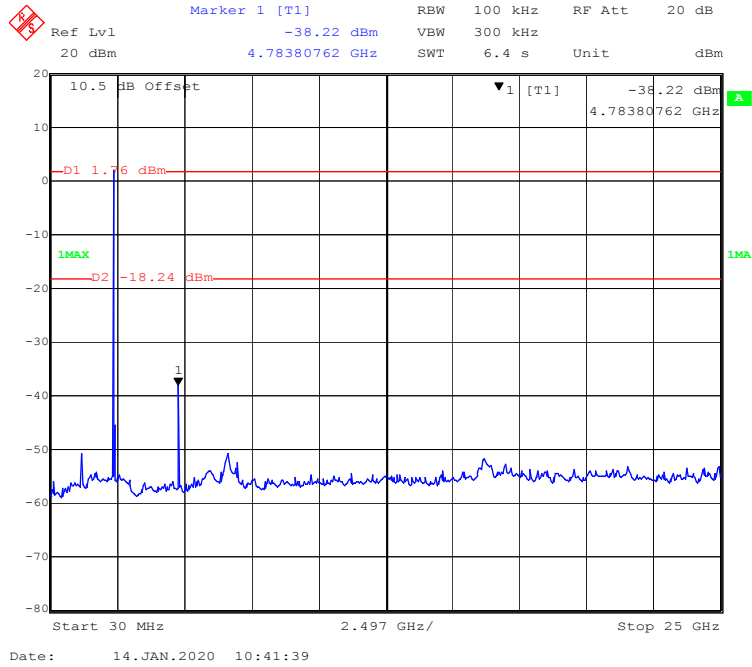

Middle Channel

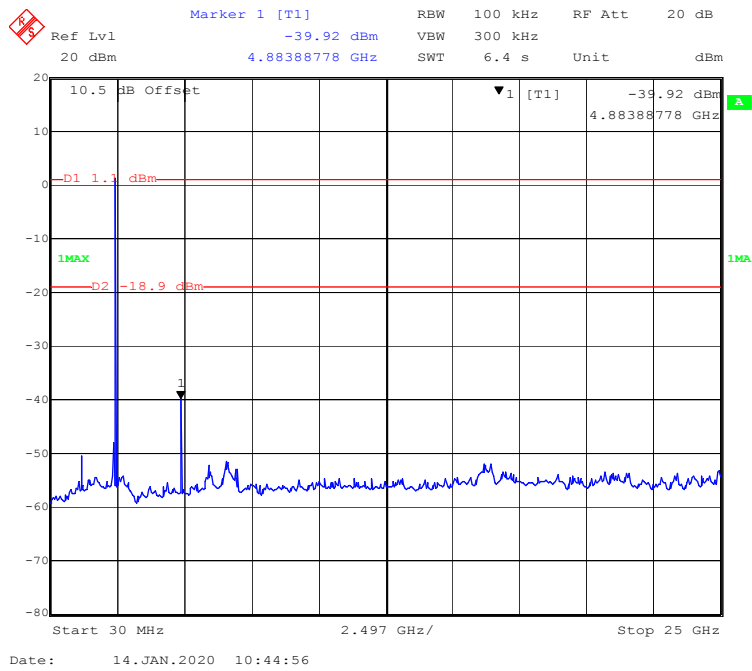

High Channel

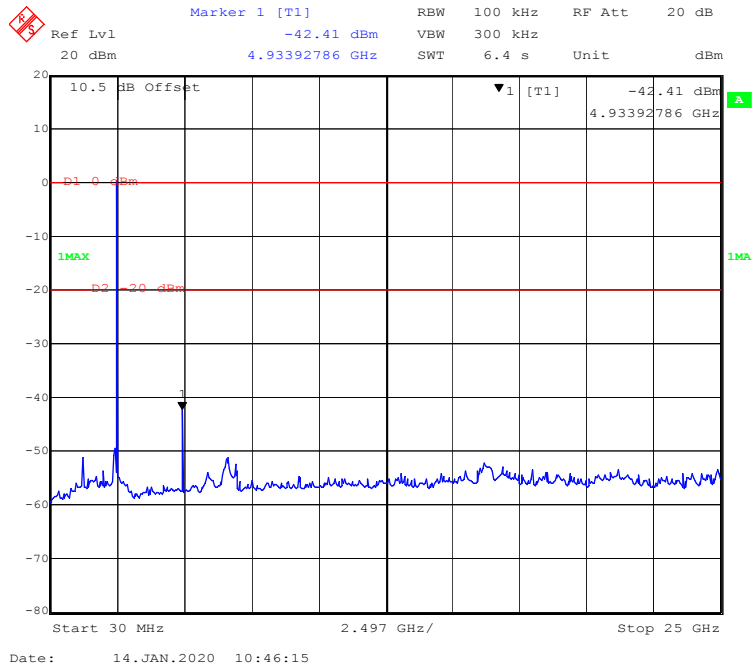

FCC §15.247(a) (2) - 6 dB EMISSION BANDWIDTH

Applicable Standard

Systems using digital modulation techniques may operate in the 902–928 MHz, 2400–2483.5 MHz, and 5725–5850 MHz bands. The minimum 6 dB bandwidth shall be at least 500 kHz.

Test Procedure

According to ANSI C63.10-2013 sub-clause 11.8.1

1. Set RBW = 100 kHz.
2. Set the video bandwidth (VBW) $\geq 3 \times$ RBW.
3. Detector = Peak.
4. Trace mode = max hold.
5. Sweep = auto couple.
6. Allow the trace to stabilize.
7. Measure the maximum width of the emission that is constrained by the frequencies associated with the two outermost amplitude points (upper and lower frequencies) that are attenuated by 6 dB relative to the maximum level measured in the fundamental emission.

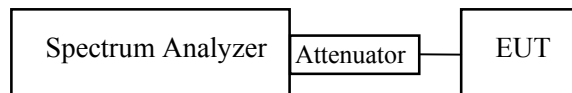

Test Data

Environmental Conditions

Temperature:	22.3°C
Relative Humidity:	51 %
ATM Pressure:	101.2 kPa

The testing was performed by Lee.Li on 2020-01-14

Test Result: Pass.

EUT operation mode: Transmitting in middle

Channel	Frequency (MHz)	6 dB Emission Bandwidth (MHz)	Limit (MHz)
Low	2402	0.751	≥ 0.5
Middle	2440	0.758	≥ 0.5
High	2480	0.756	≥ 0.5

Low Channel

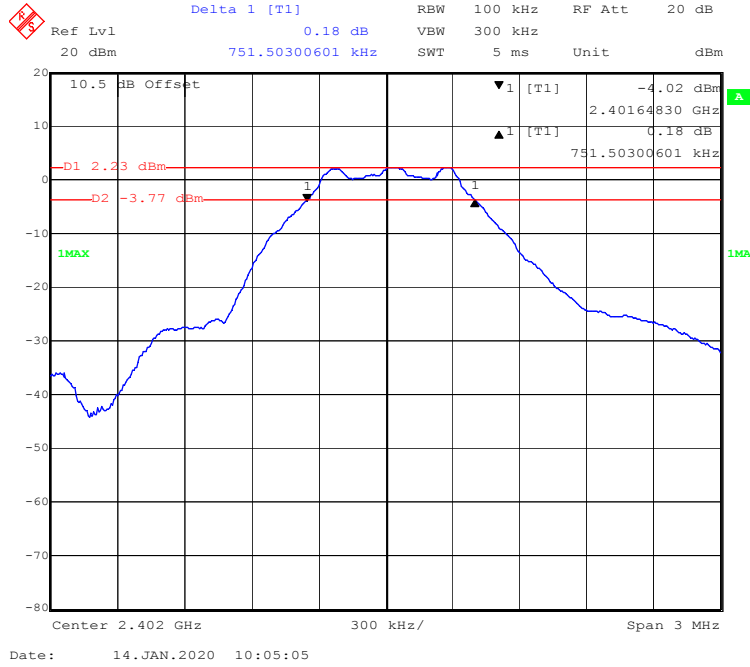

Middle Channel

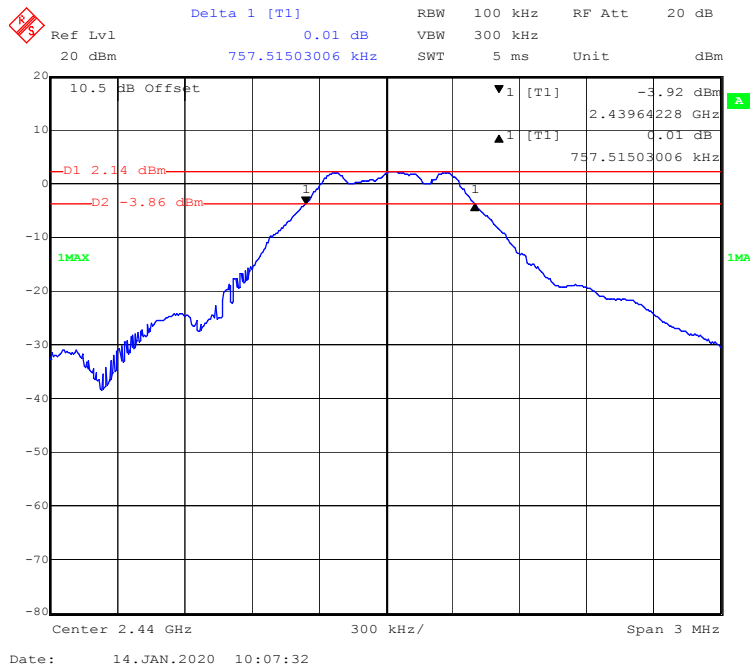

High Channel

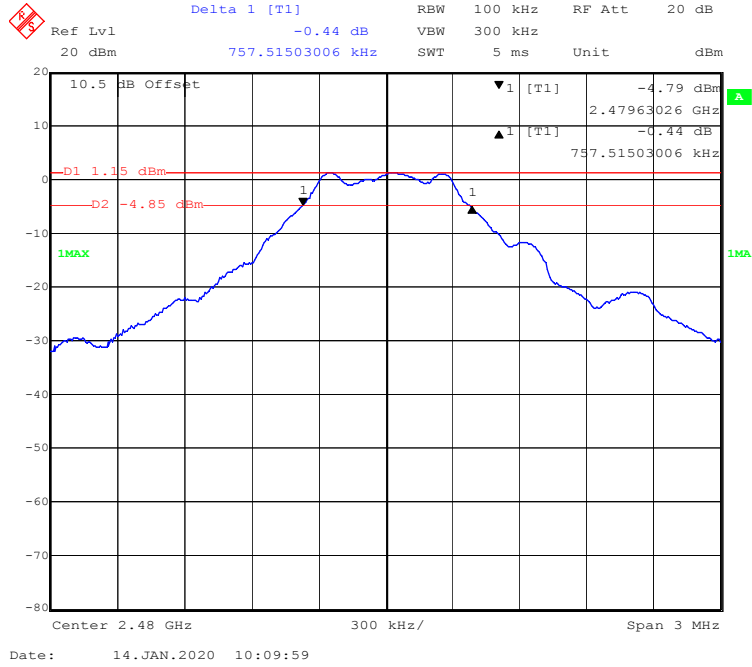

FCC §15.247(b) (3) - MAXIMUM CONDUCTED OUTPUT POWER

Applicable Standard

According to FCC §15.247(b) (3), for systems using digital modulation in the 902-928 MHz, 2400-2483.5 MHz, and 5725-5850 MHz bands: 1 Watt. As an alternative to a peak power measurement, compliance with the one Watt limit can be based on a measurement of the maximum conducted output power. Maximum Conducted Output Power is defined as the total transmit power delivered to all antennas and antenna elements averaged across all symbols in the signaling alphabet when the transmitter is operating at its maximum power control level. Power must be summed across all antennas and antenna elements. The average must not include any time intervals during which the transmitter is off or is transmitting at a reduced power level. If multiple modes of operation are possible (e.g., alternative modulation methods), the maximum conducted output power is the highest total transmit power occurring in any mode.

Test Procedure

According to ANSI C63.10-2013 sub-clause 11.9.1.1

1. Set the RBW \geq DTS bandwidth.
2. Set VBW $\geq 3 \times$ RBW.
3. Set span $\geq 3 \times$ RBW
4. Sweep time = auto couple.
5. Detector = peak.
6. Trace mode = max hold.
7. Allow trace to fully stabilize.
8. Use peak marker function to determine the peak amplitude level.



Test Data

Environmental Conditions

Temperature:	24.2°C
Relative Humidity:	51 %
ATM Pressure:	101.2 kPa

The testing was performed by Lee.Li on 2020-01-14.

EUT operation mode: Transmitting

Channel	Frequency (MHz)	Max Conducted Peak Output Power (dBm)	Limit (dBm)	Result
Low	2402	1.89	30	Pass
Middle	2440	2.10	30	Pass
High	2480	0.96	30	Pass

Low Channel

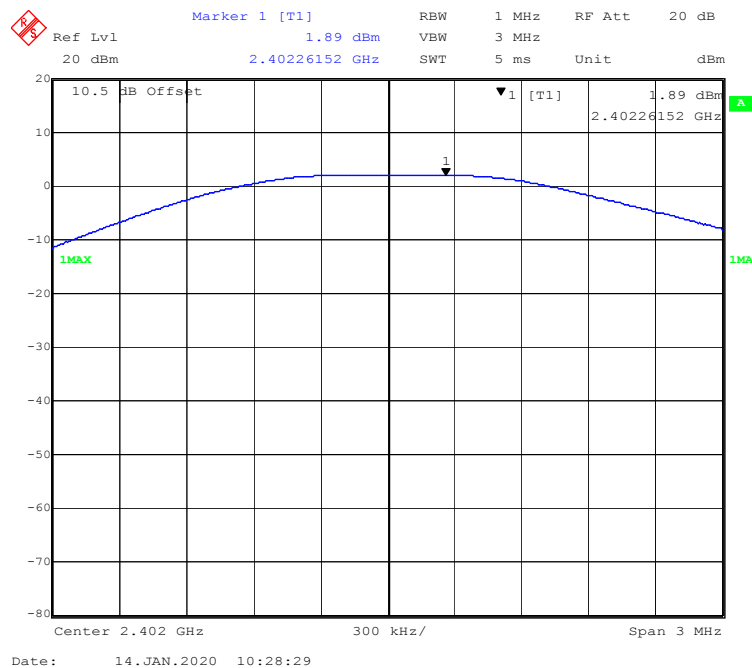

Middle Channel

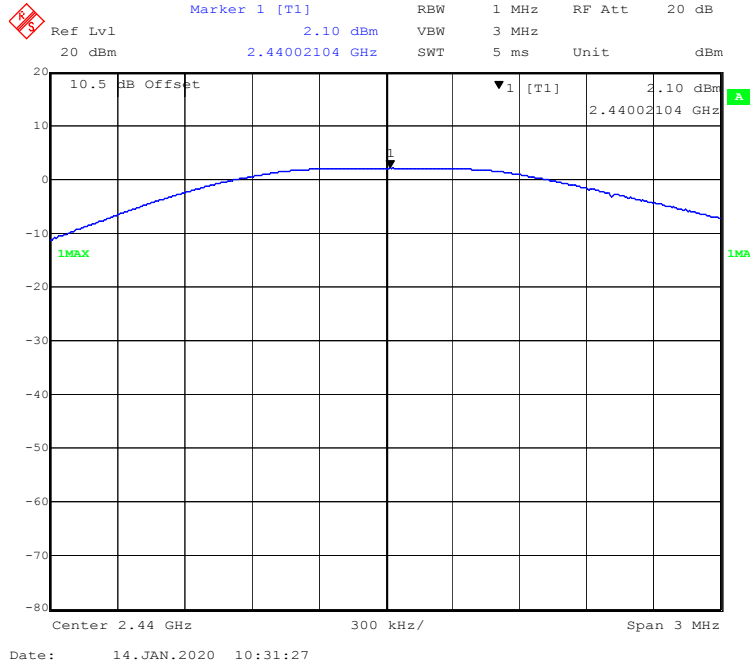

High Channel

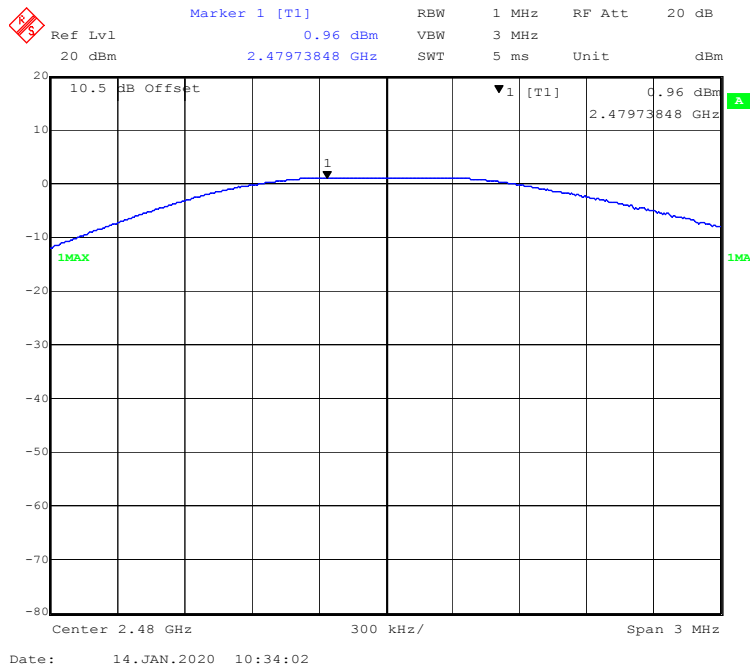

FCC §15.247(d) - BAND EDGE

Applicable Standard

In any 100 kHz bandwidth outside the frequency band in which the spread spectrum or digitally modulated intentional radiator is operating, the radio frequency power that is produced by the intentional radiator shall be at least 20 dB below that in the 100 kHz bandwidth within the band that contains the highest level of the desired power, based on either an RF conducted or a radiated measurement, provided the transmitter demonstrates compliance with the peak conducted power limits. If the transmitter complies with the conducted power limits based on the use of RMS averaging over a time interval, as permitted under paragraph (b)(3) of this section, the attenuation required under this paragraph shall be 30 dB instead of 20 dB. Attenuation below the general limits specified in §15.209(a) is not required. In addition, radiated emissions which fall in the restricted bands, as defined in §15.205(a), must also comply with the radiated emission limits specified in §15.209(a) (see §15.205(c)).

Test Procedure

According to ANSI C63.10-2013 sub-clause 6.10.

1. Check the calibration of the measuring instrument using either an internal calibrator or a known signal from an external generator.
2. Position the EUT without connection to measurement instrument. Turn on the EUT and connect its antenna terminal to measurement instrument via a low loss cable. Then set it to any one measured frequency within its operating range, and make sure the instrument is operated in its linear range.
3. Set RBW to 100 kHz and VBW of spectrum analyzer to 300 kHz with a convenient frequency span including 100 kHz bandwidth from band edge.
4. Measure the middlemost amplitude appearing on spectral display and set it as a reference level. Plot the graph with marking the middlemost point and edge frequency.
5. Repeat above procedures until all measured frequencies were complete.

Test Data

Environmental Conditions

Temperature:	25°C
Relative Humidity:	51 %
ATM Pressure:	101.2 kPa

The testing was performed by Lee.Li on 2020-01-14.

EUT operation mode: Transmitting

Test Result: Pass

Left Side

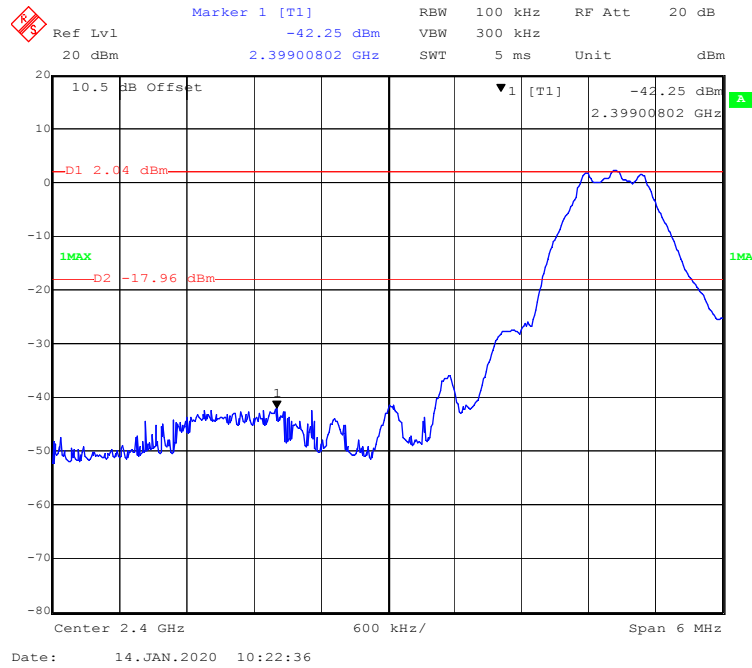

Right Side

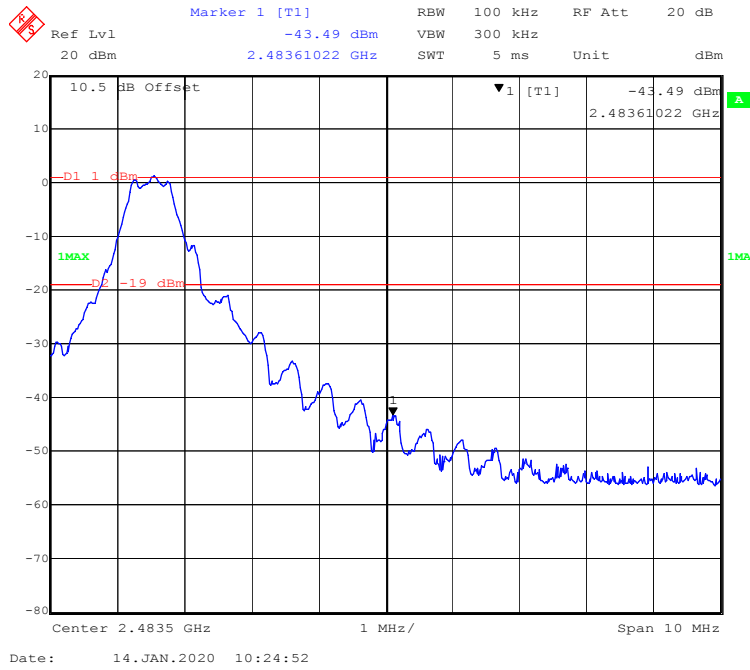

FCC §15.247(e) - POWER SPECTRAL DENSITY

Applicable Standard

For digitally modulated systems, the power spectral density conducted from the intentional radiator to the antenna shall not be greater than 8 dBm in any 3 kHz band during any time interval of continuous transmission. This power spectral density shall be determined in accordance with the provisions of paragraph (b) of this section. The same method of determining the conducted output power shall be used to determine the power spectral density.

Test Procedure

According to ANSI C63.10-2013 sub-clause 11.10.2

The following procedure shall be used if maximum peak conducted output power was used to determine compliance, and it is optional if the maximum conducted (average) output power was used to determine compliance:

1. Set the RBW to: $3\text{kHz} \leq \text{RBW} \leq 100\text{ kHz}$.
2. Set the VBW $\geq 3 \times \text{RBW}$.
3. Set the span to 1.5 times the DTS bandwidth.
4. Detector = peak.
5. Sweep time = auto couple.
6. Trace mode = max hold.
7. Allow trace to fully stabilize.
8. Use the peak marker function to determine the maximum amplitude level within the RBW.
9. If measured value exceeds limit, reduce RBW (no less than 3 kHz) and repeat.

Test Data

Environmental Conditions

Temperature:	25.2°C
Relative Humidity:	51 %
ATM Pressure:	101.2kPa

The testing was performed by Lee.Li on 2020-01-14.

EUT operation mode: Transmitting

Test Result: Pass

Channel	Frequency (MHz)	PSD (dBm/3kHz)	Limit (dBm/3kHz)
Low	2402	-10.53	≤ 8
Middle	2440	-11.48	≤ 8
High	2480	-12.51	≤ 8

Low Channel

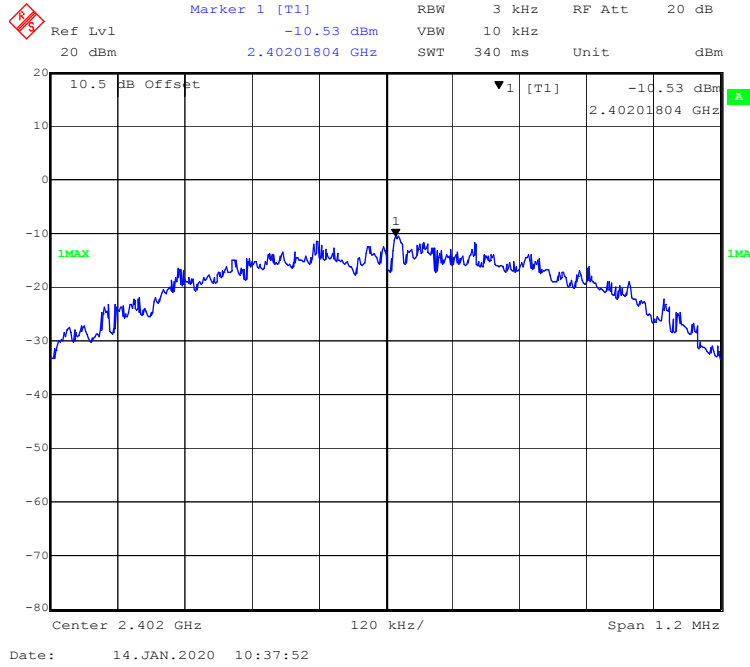

Middle Channel

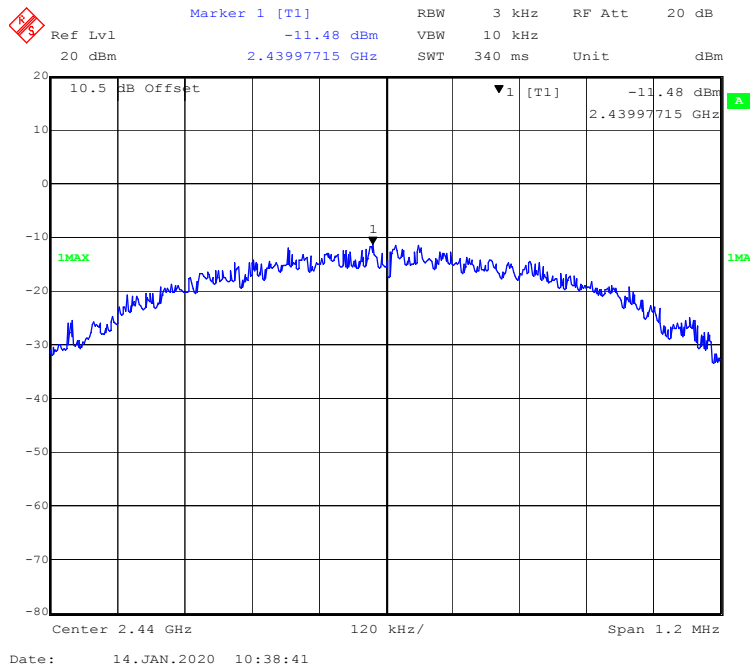

High Channel

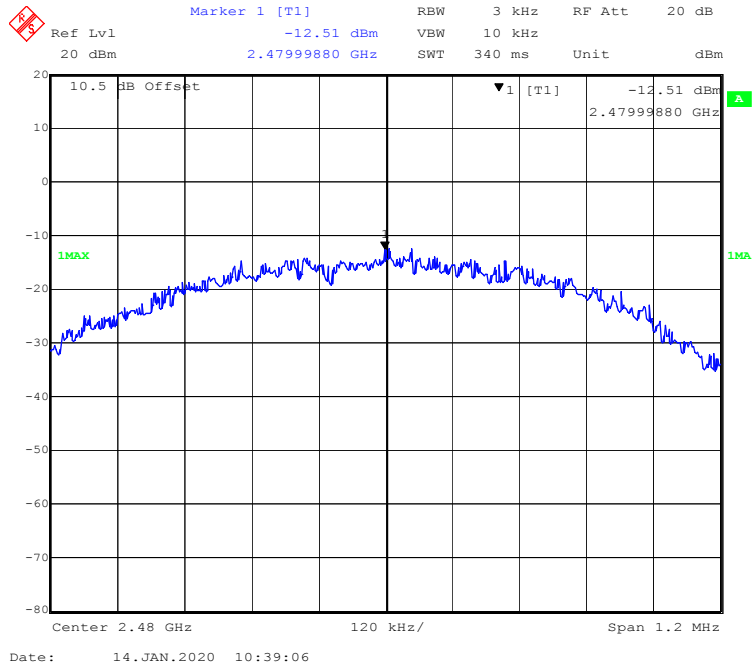

***** END OF REPORT *****