



RF TEST REPORT

Applicant Huawei Device Co., Ltd.
FCC ID 2ATEYWS7100
Product 3000Mbps Wi-Fi 6 Router
Model WS7100
Report No. R2105A0471-R1
Issue Date June 5, 2021

TA Technology (Shanghai) Co., Ltd. tested the above equipment in accordance with the requirements in **FCC CFR47 Part 15C (2020)**. The test results show that the equipment tested is capable of demonstrating compliance with the requirements as documented in this report.

Performed by: Peng Tao

Approved by: Kai Xu

TA Technology (Shanghai) Co., Ltd.

No.145, Jintang Rd, Tangzhen Industry Park, Pudong Shanghai, China

TEL: +86-021-50791141/2/3

FAX: +86-021-50791141/2/3-8000



TABLE OF CONTENT

1. Test Laboratory	4
1.1. Notes of the test report.....	4
1.2. Test facility	4
1.3. Testing Location.....	4
2. General Description of Equipment under Test.....	5
2.1. Applicant and Manufacturer Information.....	5
2.2. General information.....	5
3. Applied Standards	7
4. Test Configuration	8
5. Test Case Results	10
5.1. Maximum output power	10
5.2. 99% Bandwidth and 6dB Bandwidth	15
5.3. Band Edge	27
5.4. Power Spectral Density	32
5.5. Spurious RF Conducted Emissions.....	56
5.6. Unwanted Emission	63
5.7. Conducted Emission	119
6. Main Test Instruments.....	122



Summary of measurement results

Number	Test Case	Clause in FCC rules	Verdict
1	Maximum conducted output power	15.247(b)(3)	PASS
2	99% bandwidth and 6 dB bandwidth	15.247(a)(2)	PASS
3	Power spectral density	15.247(e)	PASS
4	Band Edge	15.247(d)	PASS
5	Spurious RF Conducted Emissions	15.247(d)	PASS
6	Unwanted Emissions	15.247(d),15.205,15.209	PASS
7	Conducted Emissions	15.207	PASS
Date of Testing: August 1, 2020~ August 26, 2020 and June 1, 2021			
Note: All indications of Pass/Fail in this report are opinions expressed by TA Technology (Shanghai) Co., Ltd. based on interpretations and/or observations of test results. Measurement Uncertainties were not taken into account and are published for informational purposes only.			

WS7100 (Report No.: R2105A0471-R1) is a variant model of WS7100 (Report No.: R2007H0212-R1). This report only retests some power and added FCC ID. Other test values duplicated from Original for variant.



1. Test Laboratory

1.1. Notes of the test report

This report shall not be reproduced in full or partial, without the written approval of **TA technology (shanghai) co., Ltd.** The results documented in this report apply only to the tested sample, under the conditions and modes of operation as described herein .Measurement Uncertainties were not taken into account and are published for informational purposes only. This report is written to support regulatory compliance of the applicable standards stated above.

1.2. Test facility

FCC (Designation number: CN1179, Test Firm Registration Number: 446626)

TA Technology (Shanghai) Co., Ltd. has been listed on the US Federal Communications Commission list of test facilities recognized to perform electromagnetic emissions measurements.

A2LA (Certificate Number: 3857.01)

TA Technology (Shanghai) Co., Ltd. has been listed by American Association for Laboratory Accreditation to perform electromagnetic emission measurement.

1.3. Testing Location

Company: TA Technology (Shanghai) Co., Ltd.
Address: No.145, Jintang Rd, Tangzhen Industry Park, Pudong
City: Shanghai
Post code: 201201
Country: P. R. China
Contact: Xu Kai
Telephone: +86-021-50791141/2/3
Fax: +86-021-50791141/2/3-8000
Website: <http://www.ta-shanghai.com>
E-mail: xukai@ta-shanghai.com

2. General Description of Equipment under Test

2.1. Applicant and Manufacturer Information

Applicant	Huawei Device Co., Ltd.
Applicant address	No.2 of Xincheng Road, Songshan Lake Zone, Dongguan, Guangdong 523808, People's Republic of China
Manufacturer	Huawei Device Co., Ltd.
Manufacturer address	No.2 of Xincheng Road, Songshan Lake Zone, Dongguan, Guangdong 523808, People's Republic of China

2.2. General information

EUT Description			
Model	WS7100		
SN	WS71003000000001		
Hardware Version	AM1WS7100M		
Software Version	10.0.5.19		
Power Supply	AC/ DC adapter		
Antenna Type	External Antenna		
Antenna Connector	Weld and IPEX studs (meet with the standard FCC Part 15.203 requirement)		
Antenna Gain	Antenna 1: 5dBi Antenna 2: 5dBi		
Directional Gain	Power Directional Gain:5.00dBi PSD Directional Gain:8.01dBi		
Test Mode	802.11b 802.11g, 802.11n(HT20/HT40);		
Modulation Type	802.11b: DSSS; 802.11g/n(HT20/HT40): OFDM		
Max. Conducted Power	Wi-Fi 2.4G :23.14dBm		
Operating Frequency Range(s)	802.11b/g/n(HT20): 2412 ~ 2462 MHz 802.11n(HT40): 2422 ~ 2452 MHz		
Accessory	Model	Manufacture	No.
Adapter	HW-120100E01	Dongguan Shilong Fuhua Electronic Co., Ltd	1
		Shenzhen Honor Electronic Co., Ltd	2
	HW-120100B01	Dongguan Shilong Fuhua Electronic Co., Ltd	3
		Shenzhen Honor Electronic Co., Ltd	4
	HW-120100U01	Dongguan Shilong Fuhua Electronic Co., Ltd	5
		Shenzhen Honor Electronic Co., Ltd	6



Note:1. The EUT is sent from the applicant to TA and the information of the EUT is declared by the applicant.

2. There is more than one Adapter, each one should be applied throughout the compliance test respectively, and however, only the worst case (Adapter 1) will be recorded in this report.



3. Applied Standards

According to the specifications of the manufacturer, it must comply with the requirements of the following standards:

Test standards:

FCC CFR47 Part 15C (2020) Radio Frequency Devices

ANSI C63.10 (2013)

Reference standard:

KDB 558074 D01 15.247 Meas Guidance v05r02

KDB 662911 D01 Multiple Transmitter Output v02r01

4. Test Configuration

Test Mode

The EUT has been associated with peripherals and configuration operated in a manner tended to maximize its emission characteristics in a typical application.

The radiated emission was measured in the following position: EUT stand-up position (Z axis), lie-down position (X, Y axis). The worst emission was found in lie-down position (X axis) and the loop antenna is vertical, the others are vertical and horizontal. and the worst case was recorded.

In order to find the worst case condition, Pre-tests are needed at the presence of different data rate. Preliminary tests have been done on all the configuration for confirming worst case. Data rate below means worst-case rate of each test item.

Worst-case data rates are shown as following table.

Band	Data Rate		
	Antenna 1	Antenna 2	MIMO
802.11b	1 Mbps	1 Mbps	/
802.11g	6 Mbps	6 Mbps	6 Mbps
802.11n HT20	MCS0	MCS0	MCS8
802.11n HT40	MCS0	MCS0	MCS8

The worst case Antenna mode for each of the following tests for Wi-Fi:

Test Cases	Antenna 1	Antenna 2	MIMO
Maximum conducted output power	O	O	802.11g 802.11n HT20 802.11n HT40
99% bandwidth and 6 dB bandwidth	802.11b	--	802.11g 802.11n HT20 802.11n HT40
Band Edge	802.11b	--	802.11g 802.11n HT20 802.11n HT40
Power Spectral Density	O	O	802.11g 802.11n HT20 802.11n HT40
Spurious RF Conducted Emissions	802.11b	--	802.11g 802.11n HT20 802.11n HT40
Unwanted Emissions	802.11b	--	802.11g 802.11n HT20 802.11n HT40
Conducted Emission	802.11b	--	--
Note: "O": test all bands			

According to RF Output power results in chapter 5.1, MIMO was selected as the worst antenna for 802.11g and 802.11n HT20/ HT40. SISO Antenna 1 was selected as the worst SISO antenna for 802.11b.

5. Test Case Results

5.1. Maximum output power

Ambient condition

Temperature	Relative humidity	Pressure
23°C ~25°C	45%~50%	101.5kPa

Methods of Measurement

During the process of the testing, The EUT was connected to Power meter with a known loss. The EUT is max power transmission with proper modulation.

The conducted Power is measured at each antenna port. The measured results at the various antenna ports are then summed mathematically.

Test Setup

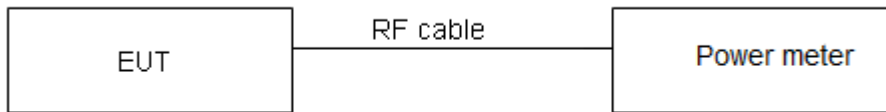

Limits

Rule Part 15.247 (b) (3) specifies that " For systems using digital modulation in the 902–928 MHz, 2400–2483.5 MHz: 1 Watt."

Average Output Power	$\leq 1W$ (30dBm)
----------------------	-------------------

Measurement Uncertainty

The assessed measurement uncertainty to ensure 95% confidence level for the normal distribution is with the coverage factor $k = 2$, $U = 0.44$ dB.

**Test Results**

Band	T _{on} (ms)	T _(on+off) (ms)	Duty cycle	Duty cycle correction Factor(dB)
802.11b	12.36	12.48	0.99	NA
802.11g	2.05	2.17	0.94	0.25
802.11n HT20	1.92	2.02	0.95	0.22
802.11n HT40	0.94	1.04	0.90	0.45

Note: when Duty cycle>0.98, Duty cycle correction Factor not required.

SISO Antenna 1:

Network Standards	Carrier frequency (MHz)	Average Power Measured (dBm)	Average Power with duty factor (dBm)	Limit (dBm)	Conclusion
802.11b	2412	22.69	22.69	30	PASS
	2437	22.80	22.80	30	PASS
	2462	21.74	21.74	30	PASS
802.11g	2412	17.56	17.81	30	PASS
	2417	18.69	18.94	30	PASS
	2422	19.74	19.99	30	PASS
	2427	21.70	21.95	30	PASS
	2437	21.72	21.97	30	PASS
	2452	21.38	21.63	30	PASS
	2457	21.31	21.56	30	PASS
	2462	19.23	19.48	30	PASS
802.11n HT20	2412	17.03	17.25	30	PASS
	2417	18.38	18.60	30	PASS
	2422	19.63	19.85	30	PASS
	2427	21.42	21.64	30	PASS
	2437	21.65	21.87	30	PASS
	2452	21.29	21.51	30	PASS
	2457	20.15	20.37	30	PASS
	2462	19.02	19.24	30	PASS
802.11n HT40	2422	16.18	16.63	30	PASS
	2427	16.32	16.77	30	PASS



	2432	18.12	18.57	30	PASS
	2437	20.16	20.61	30	PASS
	2442	20.15	20.60	30	PASS
	2447	20.51	20.96	30	PASS
	2452	21.23	21.68	30	PASS

Note: Average Power with duty factor = Average Power Measured +Duty cycle correction factor

SISO Antenna 2:

Network Standards	Carrier frequency (MHz)	Average Power Measured (dBm)	Average Power with duty factor (dBm)	Limit (dBm)	Conclusion
802.11b	2412	21.62	21.62	30	PASS
	2437	21.78	21.78	30	PASS
	2462	21.11	21.11	30	PASS
802.11g	2412	17.71	17.96	30	PASS
	2417	18.96	19.21	30	PASS
	2422	19.85	20.10	30	PASS
	2427	21.87	22.12	30	PASS
	2437	21.98	22.23	30	PASS
	2452	21.86	22.11	30	PASS
	2457	21.27	21.52	30	PASS
	2462	19.92	20.17	30	PASS
802.11n HT20	2412	16.95	17.17	30	PASS
	2417	18.40	18.62	30	PASS
	2422	19.48	19.70	30	PASS
	2427	21.69	21.91	30	PASS
	2437	21.72	21.94	30	PASS
	2452	21.58	21.80	30	PASS
	2457	20.63	20.85	30	PASS
	2462	19.64	19.86	30	PASS
802.11n HT40	2422	15.97	16.42	30	PASS
	2427	15.92	16.37	30	PASS
	2432	18.08	18.53	30	PASS
	2437	20.04	20.49	30	PASS



	2442	20.12	20.57	30	PASS
	2447	20.03	20.48	30	PASS
	2452	19.86	20.31	30	PASS

Note: Average Power with duty factor = Average Power Measured +Duty cycle correction factor

MIMO

Network Standards	Carrier frequency (MHz)	MIMO Antenna 1		MIMO Antenna 2		Total Power (dBm)	Limit (dBm)	Conclusion
		Average Power Measured (dBm)	Average Power with duty factor (dBm)	Average Power Measured (dBm)	Average Power with duty factor (dBm)			
802.11g	2412	14.22	14.47	13.28	13.53	17.03	30	PASS
	2417	15.35	15.60	14.82	15.07	18.35	30	PASS
	2422	16.61	16.86	16.41	16.66	19.77	30	PASS
	2427	20.24	20.49	19.08	19.33	22.96	30	PASS
	2437	20.40	20.65	19.30	19.55	23.14	30	PASS
	2452	19.17	19.42	18.88	19.13	22.28	30	PASS
	2457	17.82	18.07	17.32	17.57	20.83	30	PASS
	2462	16.15	16.40	16.02	16.27	19.34	30	PASS
802.11n HT20	2412	13.82	14.04	13.79	14.01	17.04	30	PASS
	2417	15.27	15.49	14.68	14.90	18.22	30	PASS
	2422	16.19	16.41	16.02	16.24	19.34	30	PASS
	2427	19.17	19.39	19.28	19.50	22.46	30	PASS
	2437	19.26	19.48	19.14	19.36	22.43	30	PASS
	2452	18.24	18.46	17.59	17.81	21.16	30	PASS
	2457	16.96	17.18	16.03	16.25	19.75	30	PASS
	2462	15.69	15.91	14.92	15.14	18.55	30	PASS
802.11n HT40	2422	13.98	14.43	13.92	14.37	17.41	30	PASS
	2427	15.42	15.87	14.51	14.96	18.45	30	PASS
	2432	15.48	15.93	15.06	15.51	18.73	30	PASS
	2437	15.62	16.07	14.91	15.36	18.74	30	PASS
	2442	17.09	17.54	16.35	16.80	20.19	30	PASS
	2447	16.52	16.97	15.89	16.34	19.67	30	PASS
	2452	18.18	18.63	17.65	18.10	21.38	30	PASS

Note: 1. Average Power with duty factor = Average Power Measured +Duty cycle correction factor
 2. For Total Power, according to KDB 662911 D01 Multiple Transmitter Output v02r01 1),
 The Total Power = $10\log(10^{(Power\ antenna1\ in\ dBm/10)} + 10^{(Power\ antenna2\ in\ dBm/10)})$
 3. The manufacturer declared the transmitter output signals is CDD mode. And $N_{ss}=1$. According to KDB 662911 D01 Multiple Transmitter Output v02r01 2)f)(i): If all antennas have the same gain, Directional gain = $G_{ANT} + Array\ Gain$,
 For power measurements on IEEE 802.11 devices,



Array Gain = 0 dB (i.e., no array gain) for $N_{\text{ANT}} \leq 4$;

Array Gain = 0 dB (i.e., no array gain) for channel widths ≥ 40 MHz for any N_{ANT} ;

Array Gain = $5 \log(N_{\text{ANT}}/N_{\text{SS}})$ dB or 3 dB, whichever is less, for 20-MHz channel widths with $N_{\text{ANT}} \geq 5$.

So directional gain = $G_{\text{ANT}} + \text{Array Gain} = 5 + 0 = 5 \text{ dBi} < 6 \text{ dBi}$. So the power limit is 30dBm

5.2. 99% Bandwidth and 6dB Bandwidth

Ambient condition

Temperature	Relative humidity	Pressure
23°C ~25°C	45%~50%	101.5kPa

Method of Measurement

The EUT was connected to the spectrum analyzer through an external attenuator (20dB) and a known loss cable. RBW is set to 100 kHz; VBW is set to 300 kHz on spectrum analyzer. Dector=Peak, Trace mode=max hold.

The EUT was connected to the spectrum analyzer through a known loss cable. The resolution bandwidth (RBW) shall be in the range of 1% to 5% of the actual occupied / x dB bandwidth and the video bandwidth (VBW) shall not be smaller than three times the RBW value.

Test Setup

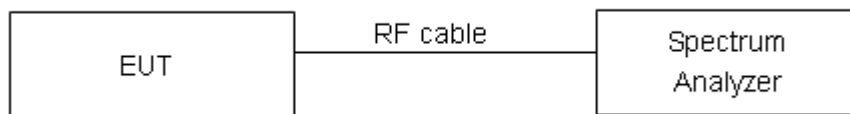

Limits

Rule Part 15.247 (a) (2) specifies that “Systems using digital modulation techniques may operate in the 902–928 MHz, 2400–2483.5 MHz bands. The minimum 6 dB bandwidth shall be at least 500 kHz.”

minimum 6 dB bandwidth	≥ 500 kHz
------------------------	-----------

Measurement Uncertainty

The assessed measurement uncertainty to ensure 95% confidence level for the normal distribution is with the coverage factor $k = 2$, $U = 936$ Hz.

**Test Results:**

Network Standards	Carrier frequency (MHz)	99% bandwidth (MHz)	Minimum 6 dB bandwidth (MHz)	Limit (kHz)	Conclusion
802.11b	2412	12.886	9.062	500	PASS
	2437	12.908	9.088	500	PASS
	2462	12.835	8.591	500	PASS
802.11g	2412	16.712	16.420	500	PASS
	2417	16.674	16.380	500	PASS
	2422	16.784	16.400	500	PASS
	2427	17.189	16.410	500	PASS
	2437	17.188	16.390	500	PASS
	2452	17.126	16.400	500	PASS
	2457	16.820	16.400	500	PASS
	2462	16.813	16.450	500	PASS
802.11n HT20	2412	17.812	17.580	500	PASS
	2417	17.808	17.610	500	PASS
	2422	17.886	17.630	500	PASS
	2427	18.097	17.610	500	PASS
	2437	18.016	17.610	500	PASS
	2452	18.044	17.610	500	PASS
	2457	17.900	17.610	500	PASS
	2462	17.869	17.610	500	PASS
802.11n HT40	2422	36.334	36.080	500	PASS
	2427	36.306	36.340	500	PASS
	2432	36.327	36.360	500	PASS
	2437	36.457	36.420	500	PASS
	2442	36.425	36.370	500	PASS
	2447	36.384	36.380	500	PASS
	2452	36.519	36.390	500	PASS

99%bandwidth

SISO Antenna 1:

802.11b, Carrier frequency (MHz): 2412



802.11b, Carrier frequency (MHz): 2437



802.11b, Carrier frequency (MHz):2462





MIMO Antenna

802.11g, Carrier frequency (MHz): 2412

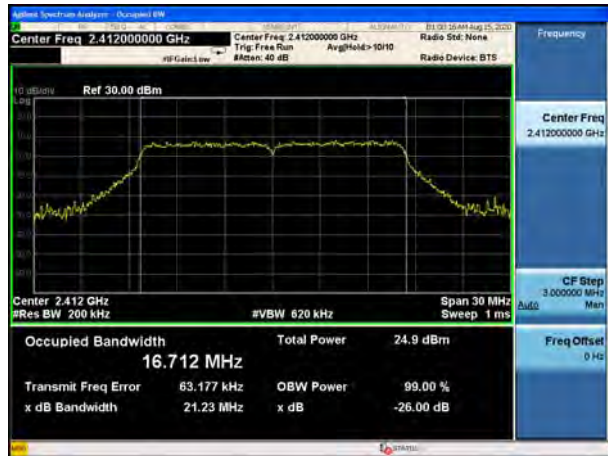

802.11g, Carrier frequency (MHz): 2417

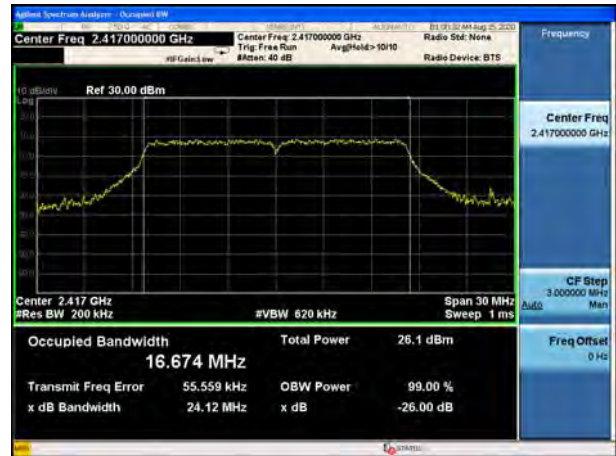

802.11g, Carrier frequency (MHz): 2422



802.11g, Carrier frequency (MHz): 2427



802.11g, Carrier frequency (MHz): 2437



802.11g, Carrier frequency (MHz): 2452





802.11g, Carrier frequency (MHz):2457

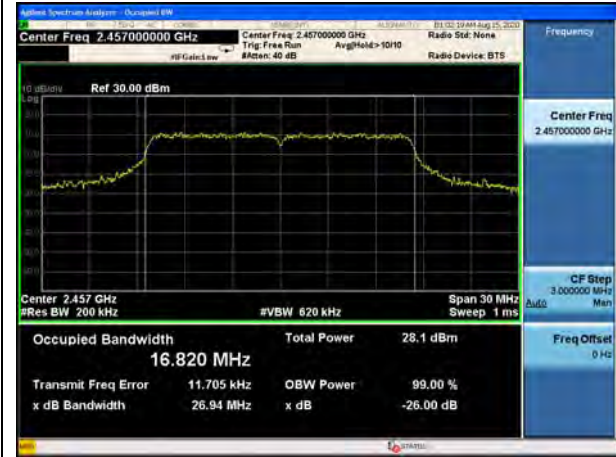

802.11g, Carrier frequency (MHz):2462



802.11n(HT20), Carrier frequency (MHz): 2412

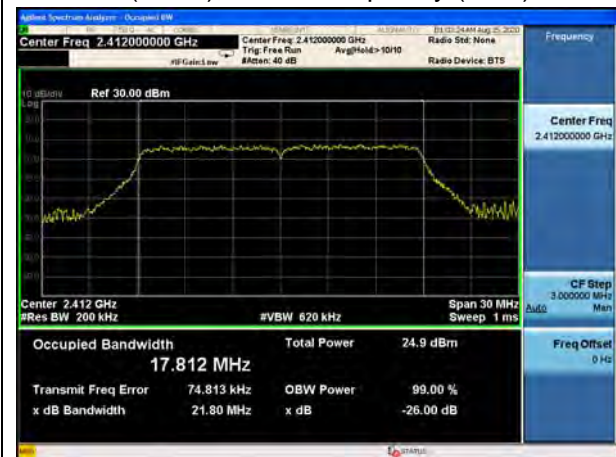

802.11n(HT20), Carrier frequency (MHz): 2417

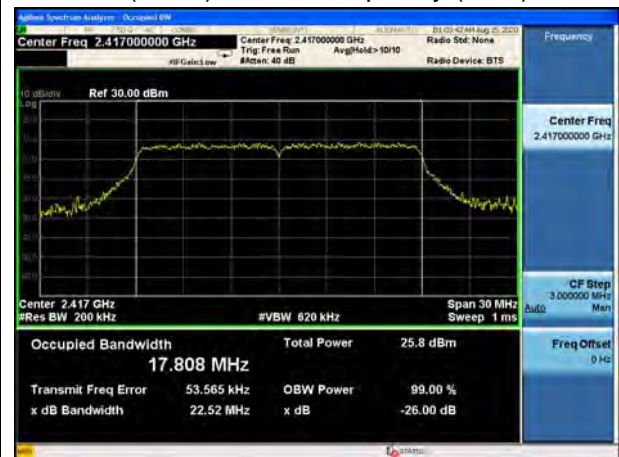

802.11n(HT20), Carrier frequency (MHz): 2422

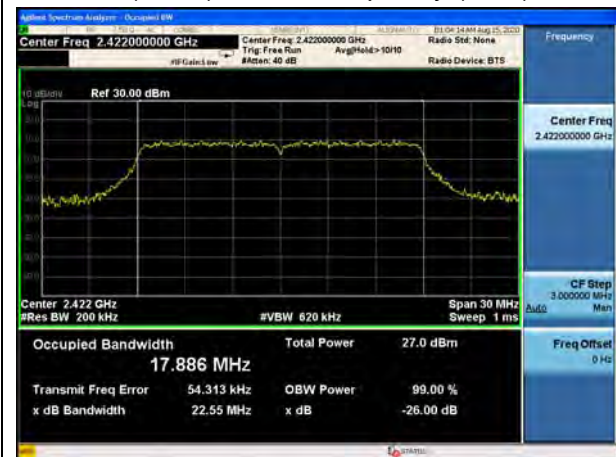

802.11n(HT20), Carrier frequency (MHz): 2427

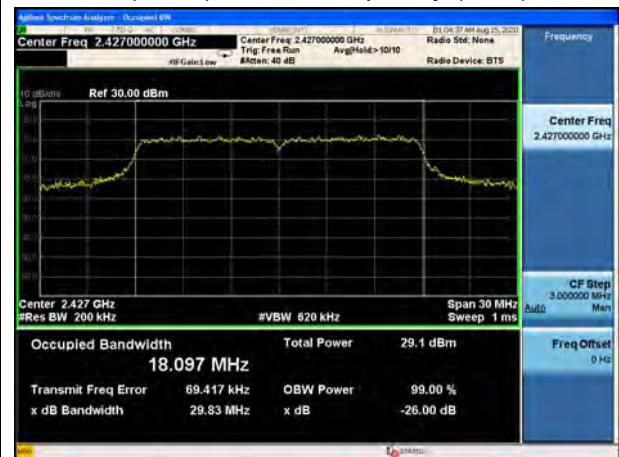



802.11n(HT20), Carrier frequency (MHz):2437



802.11n(HT20), Carrier frequency (MHz):2452



802.11n(HT20), Carrier frequency (MHz):2457



802.11n(HT20), Carrier frequency (MHz):2462

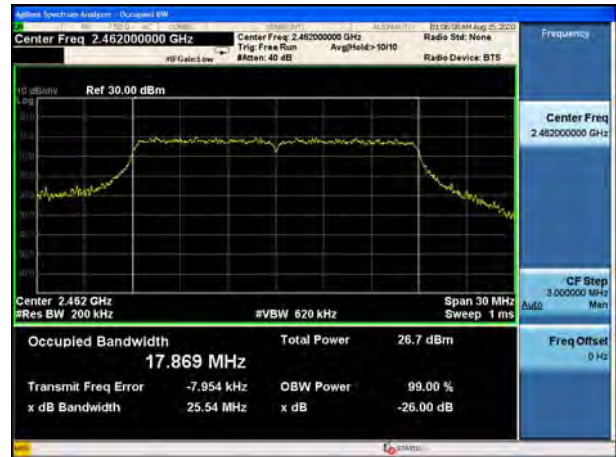

802.11n(HT40), Carrier frequency (MHz): 2422

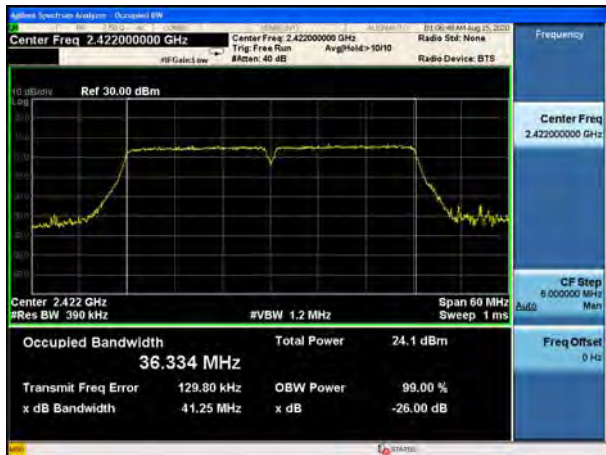

802.11n(HT40), Carrier frequency (MHz): 2427



802.11n(HT40), Carrier frequency (MHz): 2432



802.11n(HT40), Carrier frequency (MHz): 2437



802.11n(HT40), Carrier frequency (MHz):2442



802.11n(HT40), Carrier frequency (MHz):2447



802.11n(HT40), Carrier frequency (MHz):2452





6 dB bandwidth

SISO Antenna 1:

802.11b, Carrier frequency (MHz): 2412

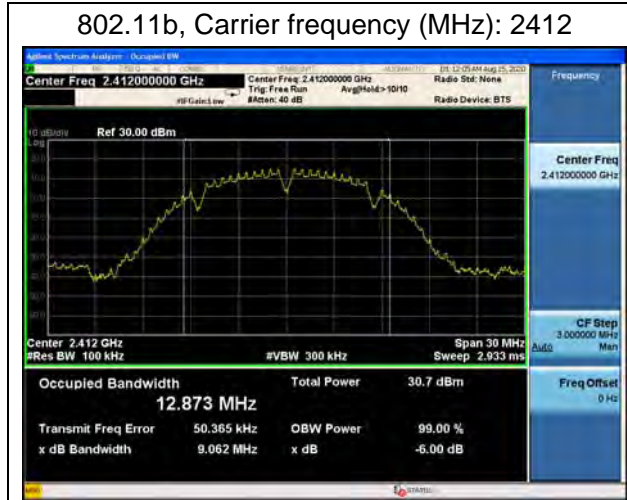

802.11b, Carrier frequency (MHz): 2437

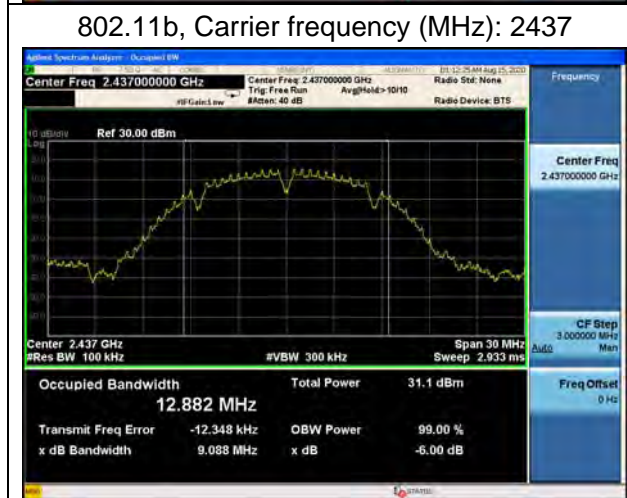

802.11b, Carrier frequency (MHz):2462

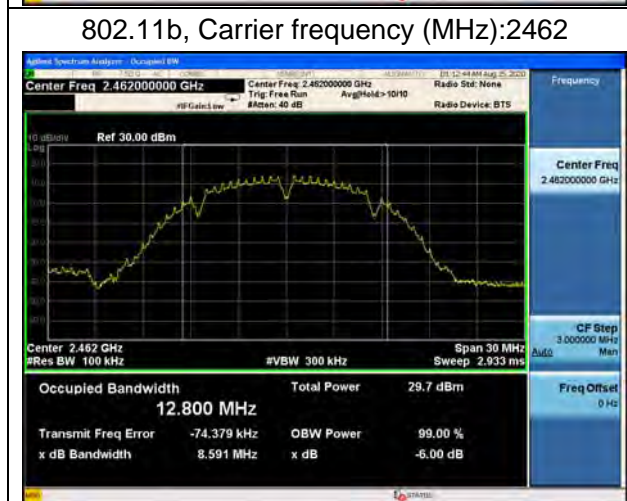



MIMO Antenna

802.11g, Carrier frequency (MHz): 2412



802.11g, Carrier frequency (MHz): 2417

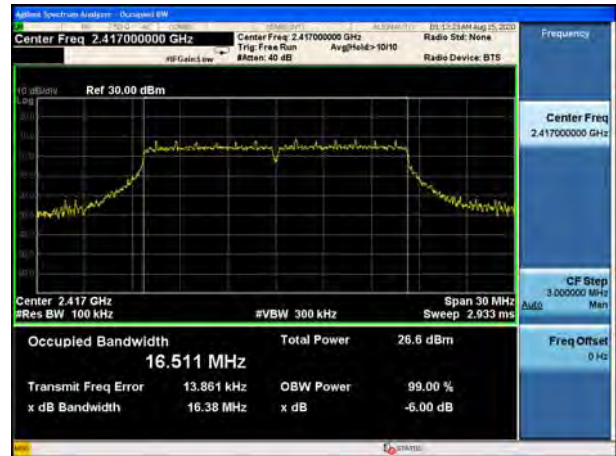

802.11g, Carrier frequency (MHz): 2422



802.11g, Carrier frequency (MHz): 2427



802.11g, Carrier frequency (MHz): 2437



802.11g, Carrier frequency (MHz): 2452





802.11g, Carrier frequency (MHz):2457



802.11g, Carrier frequency (MHz):2462



802.11n(HT20), Carrier frequency (MHz): 2412

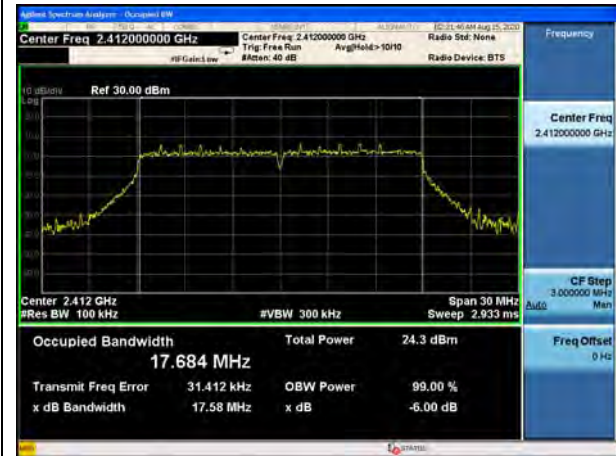

802.11n(HT20), Carrier frequency (MHz): 2417



802.11n(HT20), Carrier frequency (MHz): 2422

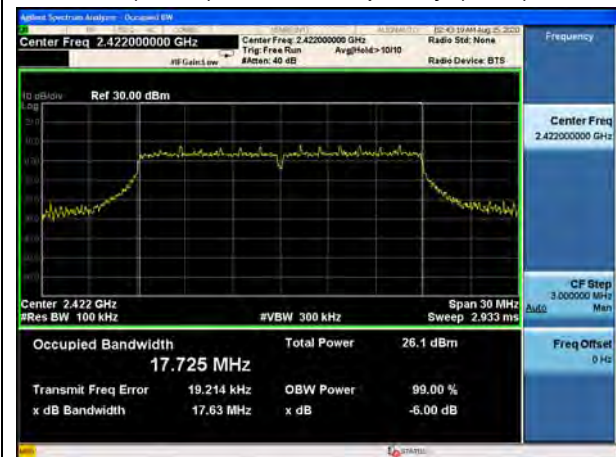

802.11n(HT20), Carrier frequency (MHz): 2427

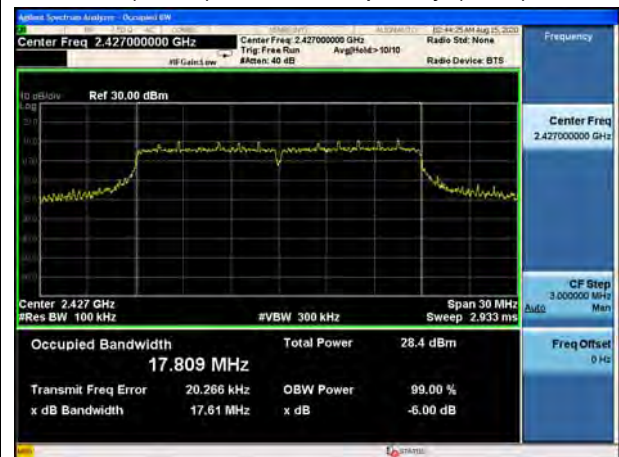



802.11n(HT20), Carrier frequency (MHz):2437



802.11n(HT20), Carrier frequency (MHz):2452

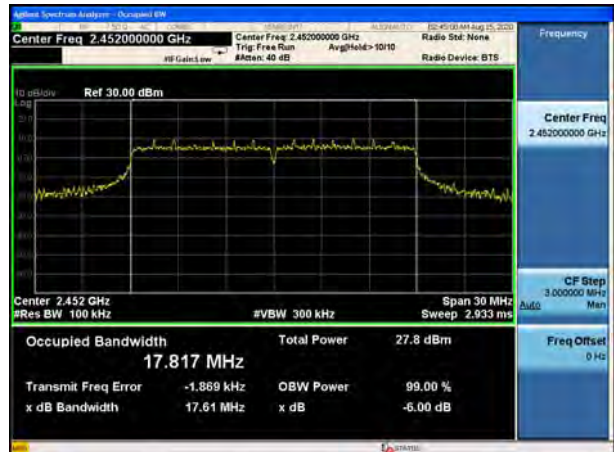

802.11n(HT20), Carrier frequency (MHz):2457

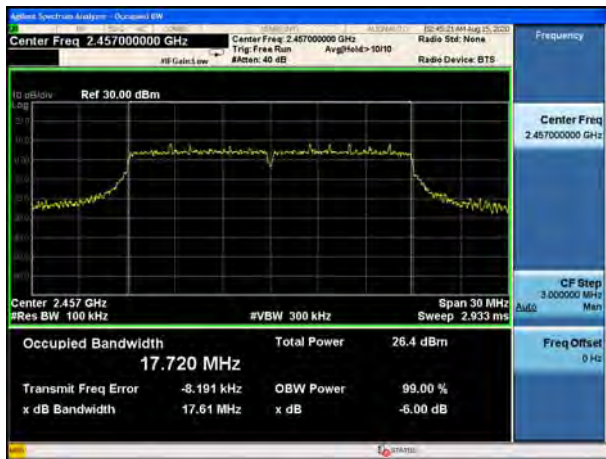

802.11n(HT20), Carrier frequency (MHz):2462



802.11n(HT40), Carrier frequency (MHz): 2422

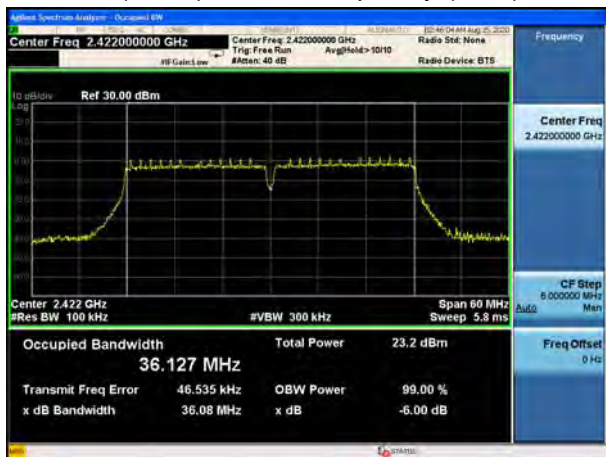

802.11n(HT40), Carrier frequency (MHz): 2427

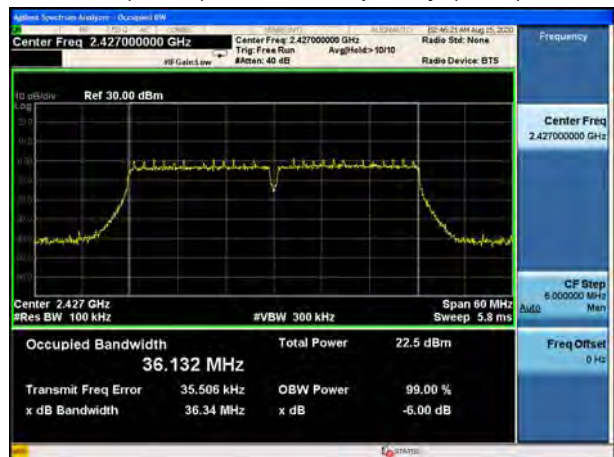



802.11n(HT40), Carrier frequency (MHz): 2432

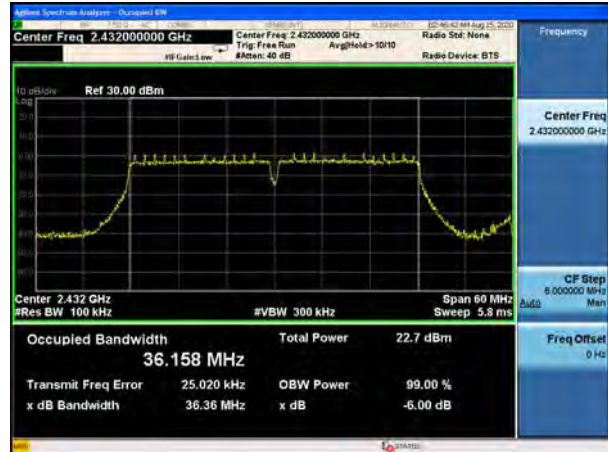

802.11n(HT40), Carrier frequency (MHz): 2437

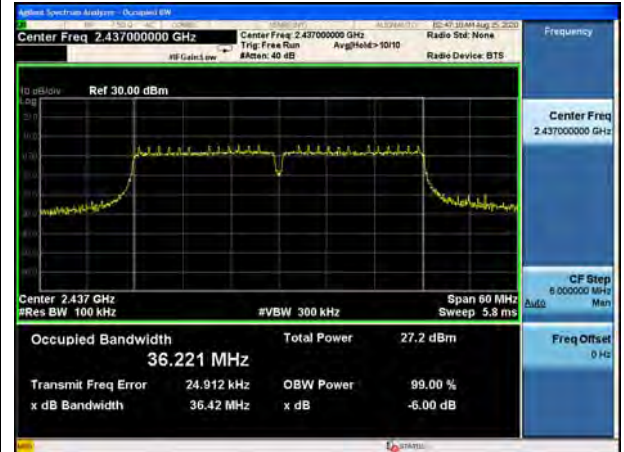

802.11n(HT40), Carrier frequency (MHz):2442

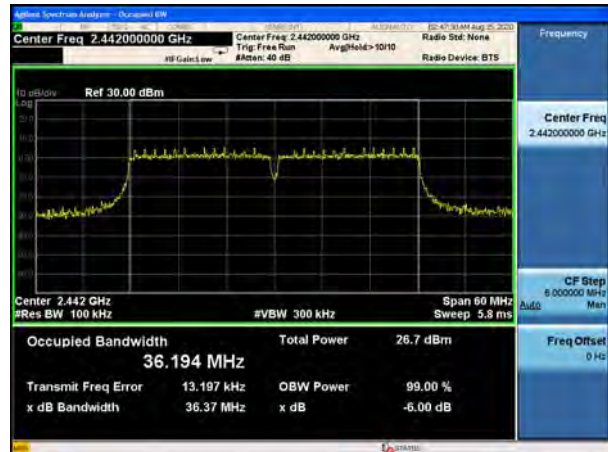

802.11n(HT40), Carrier frequency (MHz):2447

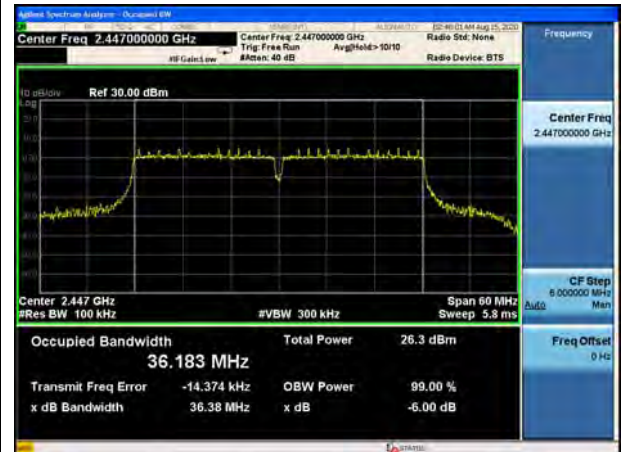

802.11n(HT40), Carrier frequency (MHz):2452

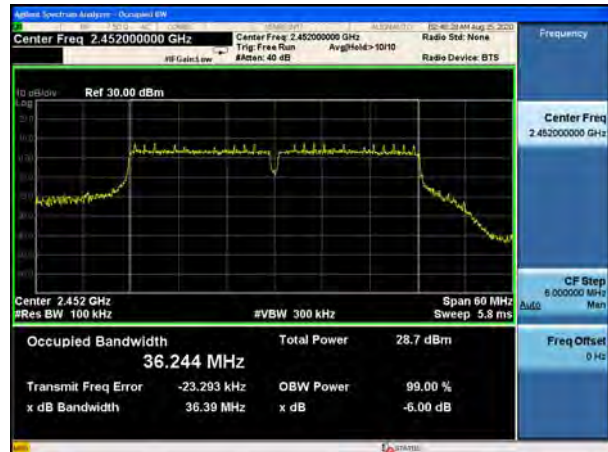

5.3. Band Edge

Ambient condition

Temperature	Relative humidity	Pressure
23°C ~25°C	45%~50%	101.5kPa

Method of Measurement

The EUT was connected to the spectrum analyzer through an external attenuator (20dB) and a known loss cable the band edge of the lowest and highest channels were measured. The peak detector is used and RBW is set to 100 kHz and VBW is set to 300 kHz on spectrum analyzer. Spectrum analyzer plots are included on the following pages.

Test Setup

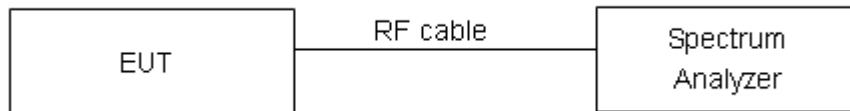

Limits

Rule Part 15.247(d) specifies that “In any 100 kHz bandwidth outside the frequency band in which the spread spectrum or digitally modulated intentional radiator is operating, the radio frequency power that is produced by the intentional radiator shall be at least 20 dB below that in the 100 kHz bandwidth within the band that contains the highest level of the desired power, based on either an RF conducted or a radiated measurement, provided the transmitter demonstrates compliance with the peak conducted power limits.” If the transmitter complies with the conducted power limits based on the use of RMS averaging over a time interval, as permitted under paragraph (b)(3) of this section, the attenuation required under this paragraph shall be 30 dB instead of 20 dB.”

Measurement Uncertainty

The assessed measurement uncertainty to ensure 95% confidence level for the normal distribution is with the coverage factor $k = 1.96$.

Frequency	Uncertainty
2GHz-3GHz	1.407 dB



Test Results: PASS

SISO Antenna 1:

802.11b, Channel No.: 1

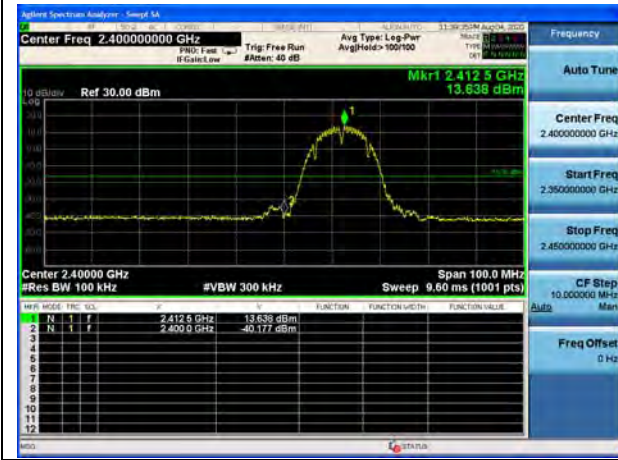

802.11b, Channel No.: 11

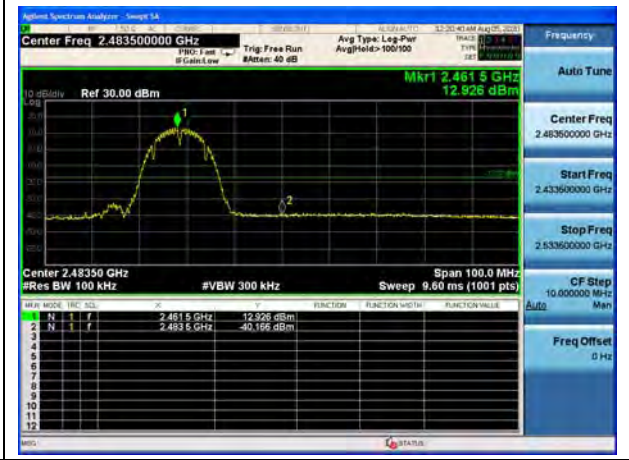

MIMO Antenna

802.11g, Channel No.: 1

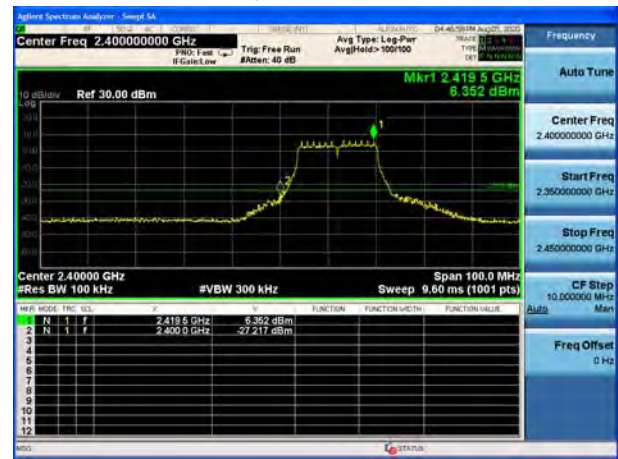

802.11g, Channel No.: 2



802.11g, Channel No.: 3



802.11g, Channel No.: 4





802.11g, Channel No.:9



802.11g, Channel No.:10



802.11g, Channel No.:11

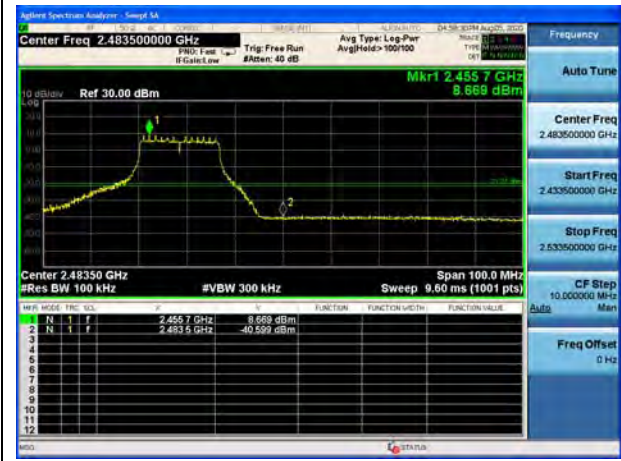

802.11n(HT20), Channel No.: 1

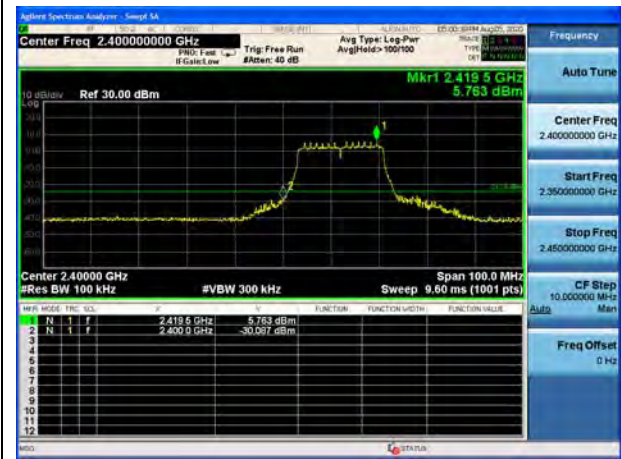

802.11n(HT20), Channel No.: 2

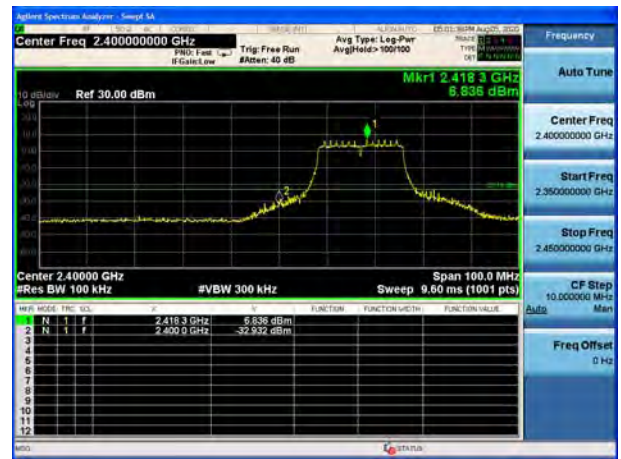



802.11n(HT20), Channel No.: 3



802.11n(HT20), Channel No.: 4



802.11n(HT20), Channel No.:9



802.11n(HT20), Channel No.:10



802.11n(HT20), Channel No.:11

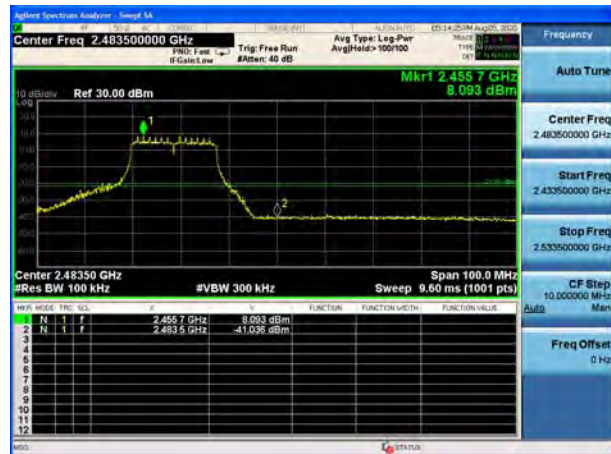



802.11n(HT40), Channel No.: 3

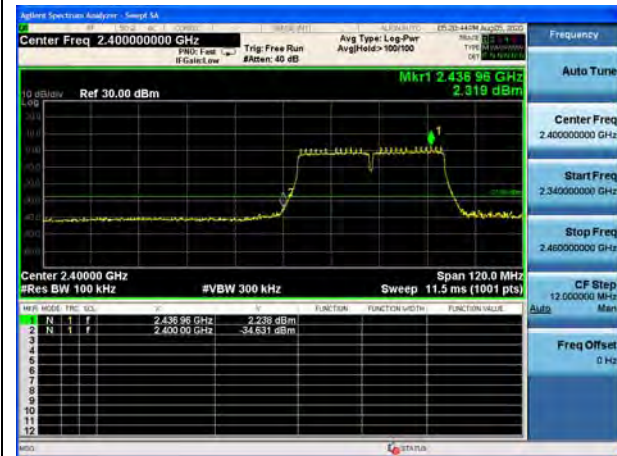

802.11n(HT40), Channel No.: 4



802.11n(HT40), Channel No.:7



802.11n(HT40), Channel No.:8

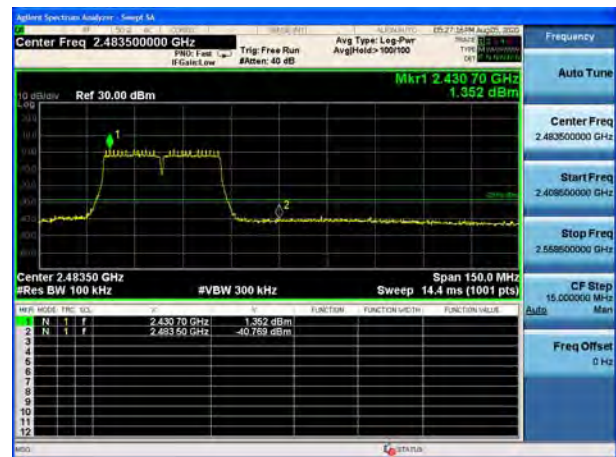

802.11n(HT40), Channel No.:9

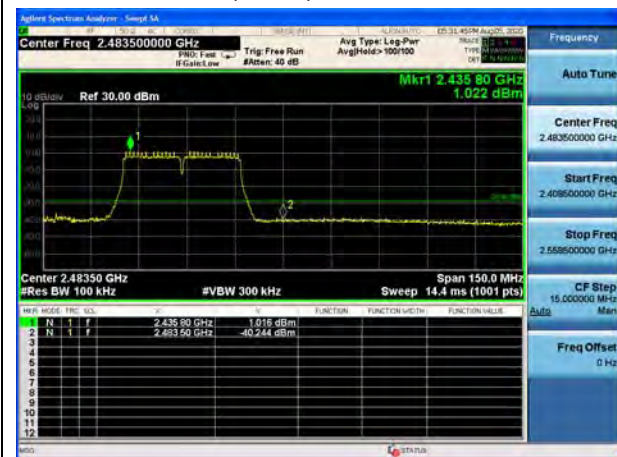

5.4. Power Spectral Density

Ambient condition

Temperature	Relative humidity	Pressure
23°C ~25°C	45%~50%	101.5kPa

Method of Measurement

During the process of the testing, The EUT was connected to Spectrum Analyzer with a known loss. The EUT is max power transmission with proper modulation.

Method AVGPSD-1 was used for this test.

- a) Set instrument center frequency to DTS channel center frequency
- b) Set span to at least 1.5 times the OBW
- c) Set RBW to: $3\text{kHz} \leq \text{RBW} \leq 100\text{kHz}$
- d) Set VBW $\geq [3 \times \text{RBW}]$
- e) Detector=power averaging(rms) or sample detector(when rms not available)
- f) Ensure that the number of measurement points in the sweep $2[2 \times \text{span}/\text{RBWT}]$
- g) Sweep time auto couple
- h) Employ trace averaging(rms) mode over a minimum of 100 traces
- i) Use the peak marker function to determine the maximum amplitude level.
- j) If the measured value exceeds requirement, then reduce RBW (but no less than 3 kHz) and repeat(note that this may require zooming in on the emission of interest and reducing the span to meet the minimum measurement point requirement as the RBW is reduced)

Method AVGPSD-2 was used for this test.

- a) Measure the duty cycle(D)of the transmitter output signal as described in 11.6
- b) Set instrument center frequency to DTS channel center frequency
- c) Set span to at least 1.5 times the OBW
- d) Set RBW to: $3\text{kHz} \leq \text{RBW} \leq 100\text{Kh}$
- e) Set VBW $\geq [3 \times \text{RBW}]$
- f) Detector= power averaging(rms) or sample detector (when rms not available)
- g) Ensure that the number of measurement points in the sweep $2[2 \times \text{span}/\text{RBW}]$
- h) Sweep time =auto couple
- i) Do not use sweep triggering; allow sweep to "free run"
- j) Employ trace averaging(rms) mode over a minimum of 100 traces
- k) Use the peak marker function to determine the maximum amplitude level
- l) Add $[10 \log(1/ D)]$, where D is the duty cycle measured in step a), to the measured PSD to

compute the average PSD during the actual transmission time

m) If measured value exceeds requirement specified by regulatory agency then reduce RBW (but no less than 3 kHz) and repeat (note that this may require zooming in on the emission of interest and reducing the span to meet the minimum measurement point requirement as the RBW is reduced)

The conducted Power is measured at each antenna port. The measured results at the various antenna ports are then summed mathematically.

Test setup

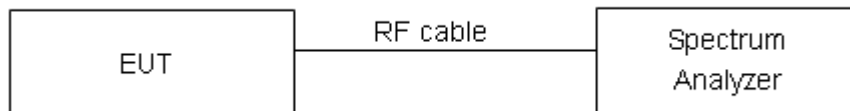

Limits

Rule Part 15.247(e) specifies that "For digitally modulated systems, the power spectral density conducted from the intentional radiator to the antenna shall not be greater than 8 dBm in any 3 kHz band during any time interval of continuous transmission. "

Limits	$\leq 8 \text{ dBm} / 3\text{kHz}$
--------	------------------------------------

Measurement Uncertainty

The assessed measurement uncertainty to ensure 95% confidence level for the normal distribution is with the coverage factor $k = 2$, $U = 0.75\text{dB}$.

**Test Results:****SISO Antenna 1:**

Network Standards	Channel Number	Read Value (dBm / 3kHz)	Power Spectral Density (dBm / 3kHz)	Limit (dBm / 3kHz)	Conclusion
802.11b	1	-8.99	-8.99	8.00	PASS
	6	-8.91	-8.91	8.00	PASS
	11	-10.23	-10.23	8.00	PASS
802.11g	1	-17.71	-17.47	8.00	PASS
	2	-17.54	-17.30	8.00	PASS
	3	-15.46	-15.22	8.00	PASS
	4	-13.63	-13.39	8.00	PASS
	6	-13.42	-13.17	8.00	PASS
	9	-14.56	-14.31	8.00	PASS
	10	-14.88	-14.63	8.00	PASS
	11	-17.05	-16.80	8.00	PASS
802.11n HT20	1	-18.21	-17.99	8.00	PASS
	2	-17.18	-16.96	8.00	PASS
	3	-15.99	-15.77	8.00	PASS
	4	-14.23	-14.01	8.00	PASS
	6	-14.42	-14.20	8.00	PASS
	9	-14.04	-13.82	8.00	PASS
	10	-15.20	-14.98	8.00	PASS
	11	-16.16	-15.94	8.00	PASS
802.11n HT40	3	-21.73	-21.28	8.00	PASS
	4	-19.75	-19.30	8.00	PASS
	5	-19.66	-19.21	8.00	PASS
	6	-18.08	-17.64	8.00	PASS
	7	-17.91	-17.46	8.00	PASS
	8	-18.16	-17.72	8.00	PASS
	9	-16.57	-16.12	8.00	PASS



Note: Power Spectral Density =Read Value+Duty cycle correction factor

SISO Antenna 2:

Network Standards	Channel Number	Read Value (dBm / 3kHz)	Power Spectral Density (dBm / 3kHz)	Limit (dBm / 3kHz)	Conclusion
802.11b	1	-10.76	-10.76	8.00	PASS
	6	-10.38	-10.38	8.00	PASS
	11	-10.07	-10.07	8.00	PASS
802.11g	1	-17.30	-17.06	8.00	PASS
	2	-16.23	-15.98	8.00	PASS
	3	-15.23	-14.98	8.00	PASS
	4	-13.64	-13.39	8.00	PASS
	6	-13.62	-13.37	8.00	PASS
	9	-13.82	-13.58	8.00	PASS
	10	-14.10	-13.85	8.00	PASS
	11	-15.29	-15.04	8.00	PASS
802.11n HT20	1	-18.17	-17.95	8.00	PASS
	2	-16.95	-16.73	8.00	PASS
	3	-16.01	-15.79	8.00	PASS
	4	-13.52	-13.30	8.00	PASS
	6	-13.94	-13.72	8.00	PASS
	9	-13.61	-13.38	8.00	PASS
	10	-14.92	-14.70	8.00	PASS
	11	-15.89	-15.67	8.00	PASS
802.11n HT40	3	-22.23	-21.79	8.00	PASS
	4	-22.32	-21.87	8.00	PASS
	5	-21.20	-20.76	8.00	PASS
	6	-18.56	-18.12	8.00	PASS
	7	-18.67	-18.23	8.00	PASS



	8	-18.51	-18.06	8.00	PASS
	9	-16.74	-16.29	8.00	PASS

Note: Power Spectral Density =Read Value+Duty cycle correction factor

MIMO

Network Standards	Channel Number	Power Spectral Density				Total PSD (dBm / 3kHz)	Limit (dBm / 3kHz)	Conclusion
		Antenna 1		Antenna 2				
		Read Value (dBm / 3kHz)	Power Spectral Density (dBm / 3kHz)	Read Value (dBm / 3kHz)	Power Spectral Density (dBm / 3kHz)			
802.11g	1	-20.58	-20.34	-21.50	-21.25	-17.76	5.99	PASS
	2	-19.81	-19.57	-20.28	-20.03	-16.78	5.99	PASS
	3	-18.58	-18.33	-19.06	-18.81	-15.55	5.99	PASS
	4	-15.05	-14.80	-15.72	-15.47	-12.11	5.99	PASS
	6	-15.08	-14.84	-16.13	-15.88	-12.32	5.99	PASS
	9	-16.18	-15.93	-16.35	-16.10	-13.01	5.99	PASS
	10	-17.67	-17.42	-18.02	-17.77	-14.58	5.99	PASS
802.11n HT20	1	-21.33	-21.11	-21.50	-21.28	-18.19	5.99	PASS
	2	-19.73	-19.51	-20.48	-20.26	-16.85	5.99	PASS
	3	-19.16	-18.94	-19.21	-18.99	-15.95	5.99	PASS
	4	-15.36	-15.13	-15.91	-15.69	-12.39	5.99	PASS
	6	-15.12	-14.90	-15.32	-15.10	-11.99	5.99	PASS
	9	-16.25	-16.03	-16.36	-16.14	-13.07	5.99	PASS
	10	-17.66	-17.44	-17.78	-17.56	-14.49	5.99	PASS
802.11n HT40	3	-24.35	-23.91	-24.92	-24.47	-21.17	5.99	PASS
	4	-24.73	-24.28	-25.29	-24.84	-21.54	5.99	PASS
	5	-24.87	-24.43	-25.40	-24.95	-21.67	5.99	PASS
	6	-21.20	-20.75	-21.28	-20.83	-17.78	5.99	PASS
	7	-21.15	-20.70	-21.22	-20.77	-17.73	5.99	PASS
	8	-21.14	-20.69	-21.21	-20.77	-17.72	5.99	PASS
	9	-19.33	-18.88	-19.37	-18.93	-15.89	5.99	PASS

Note: 1.Power Spectral Density =Read Value+Duty cycle correction factor
 2. For Total PSD, according to KDB 662911 D01 Multiple Transmitter Output v02r01 2)a),the power spectral density= $10\log(10^{(PSD\ antenna1\ in\ dBm/10)}+10^{(PSD\ antenna2\ in\ dBm/10)})$
 3. The manufacturer declared the transmitter output signals is CDD mode. And $N_{ss}=1$. According to KDB 662911 D01 Multiple Transmitter Output v02r01 2)f)(i): If all antennas have the same gain, Directional gain = $G_{ANT} + \text{Array Gain}$, For PSD measurements on all devices, $\text{Array Gain}=10\log(Nant/Nss)\text{dB}$,so directional gain= $G_{ANT}+\text{Array}$



Gain=5+10log(2/1)=8.01 >6dBi. So the power limit is 8+6-MAX(6, directional gain)dBm=5.99 dBm



SISO Antenna 1:

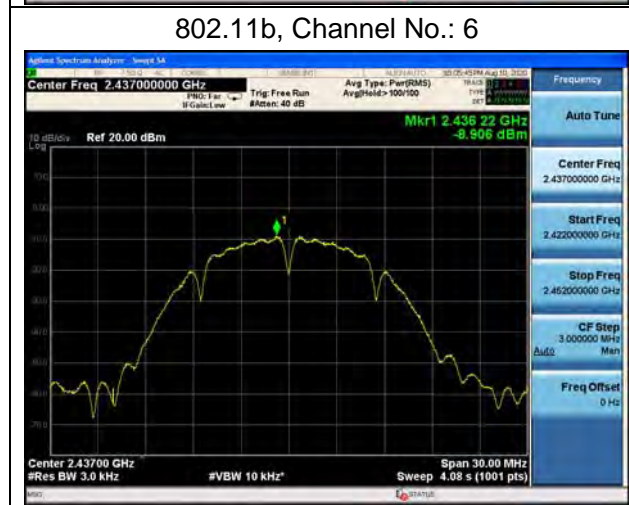



802.11g, Channel No.: 1



802.11g, Channel No.: 2



802.11g, Channel No.: 3



802.11g, Channel No.: 4



802.11g, Channel No.: 6

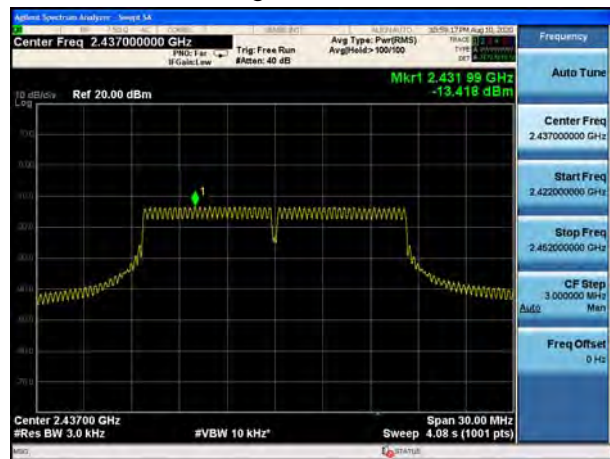

802.11g, Channel No.: 9

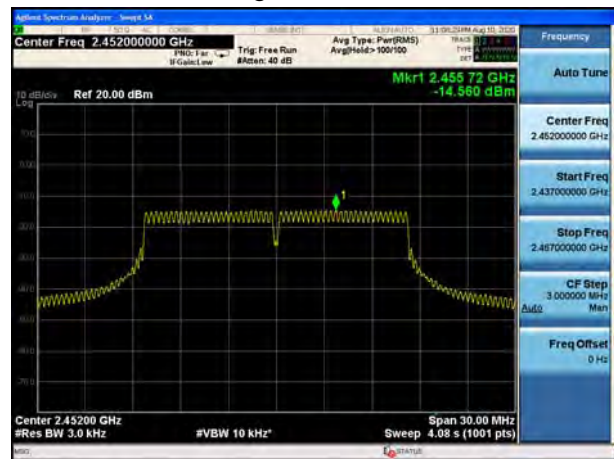



802.11g, Channel No.:10

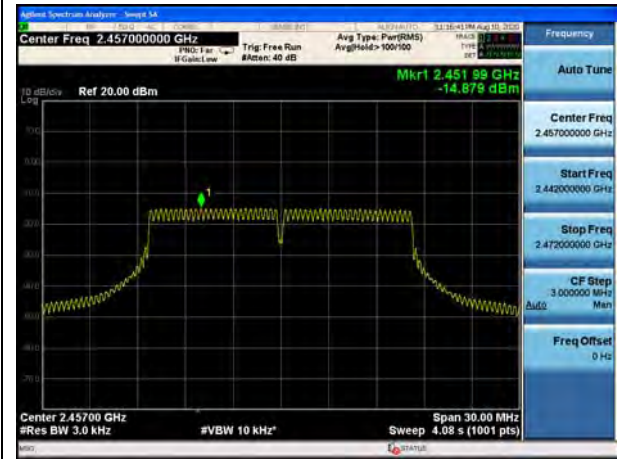

802.11g, Channel No.:11

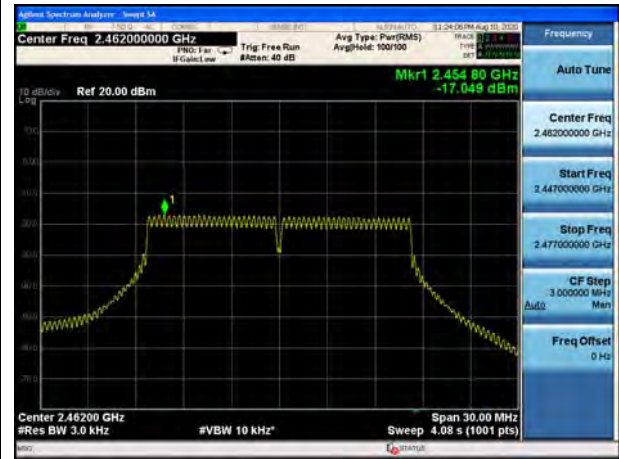

802.11n(HT20), Channel No.: 1

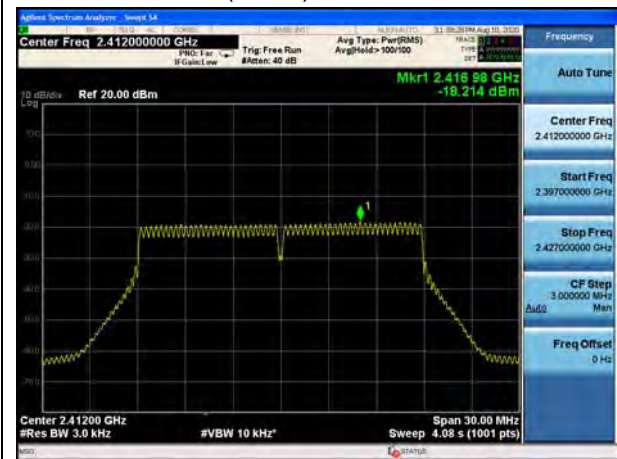

802.11n(HT20), Channel No.: 2

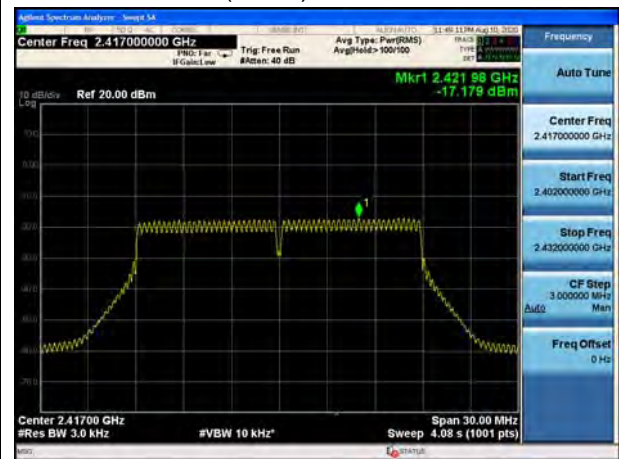

802.11n(HT20), Channel No.: 3

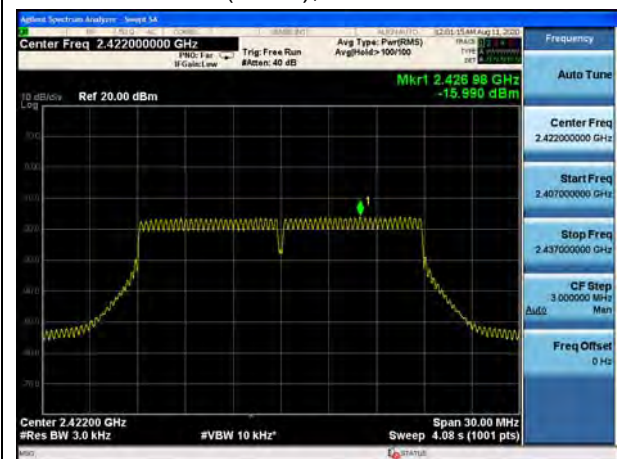

802.11n(HT20), Channel No.: 4

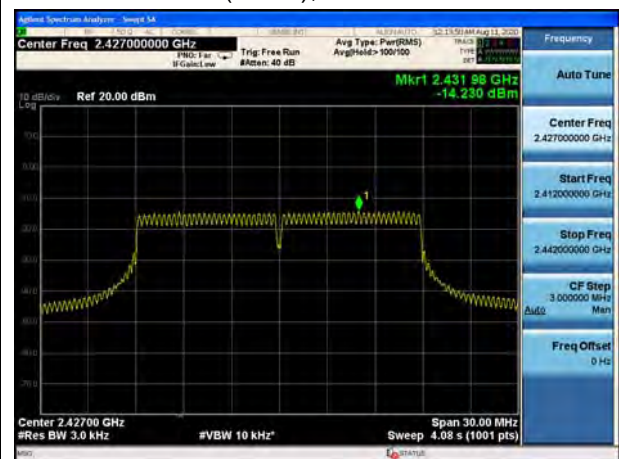

802.11n(HT20), Channel No.:6



802.11n(HT20), Channel No.:9

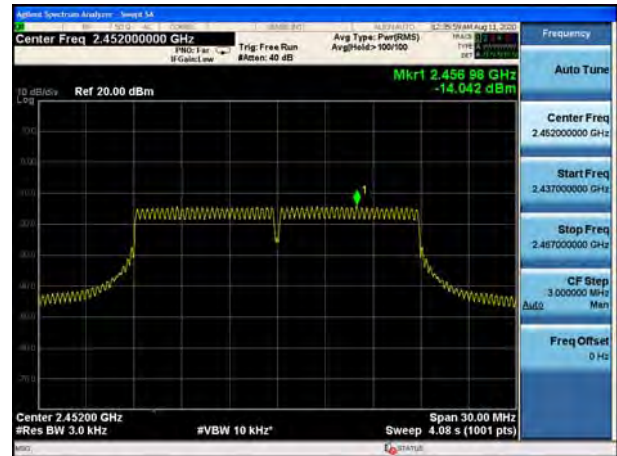

802.11n(HT20), Channel No.:10

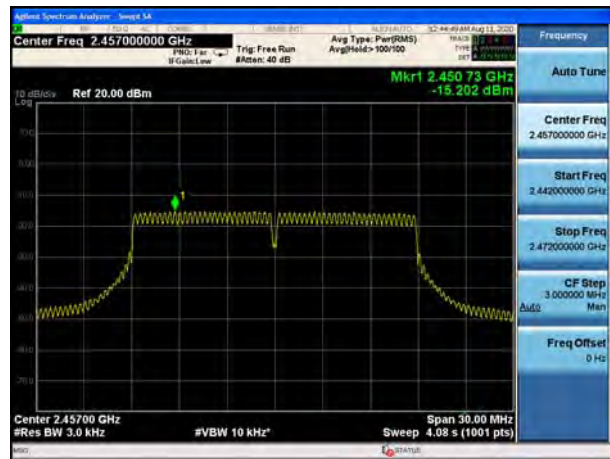

802.11n(HT20), Channel No.:11

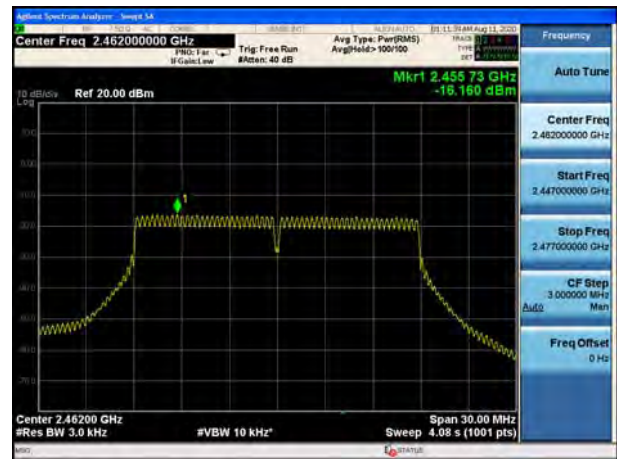

802.11n(HT40), Channel No.: 3



802.11n(HT40), Channel No.: 4

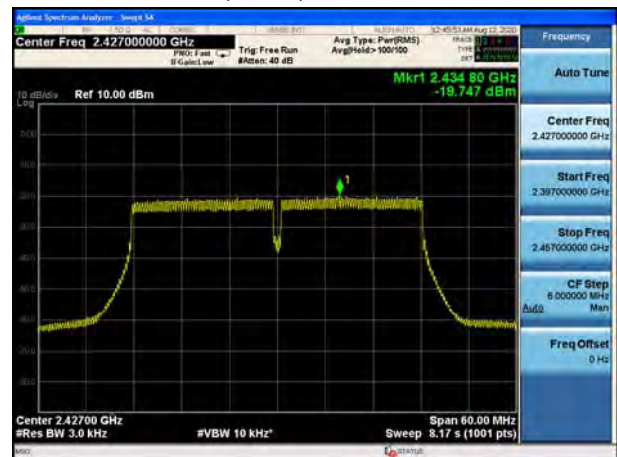



802.11n(HT40), Channel No.: 5

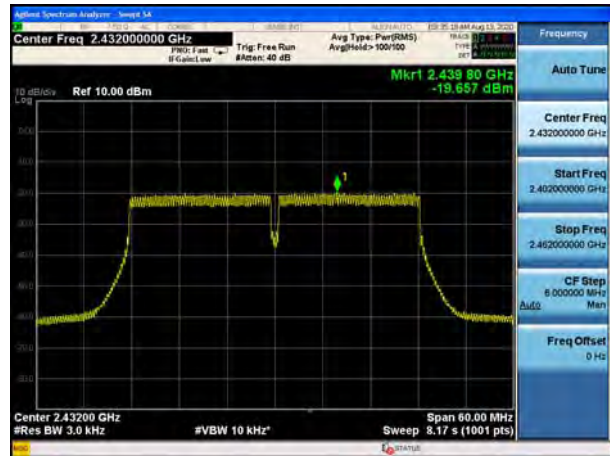

802.11n(HT40), Channel No.: 6

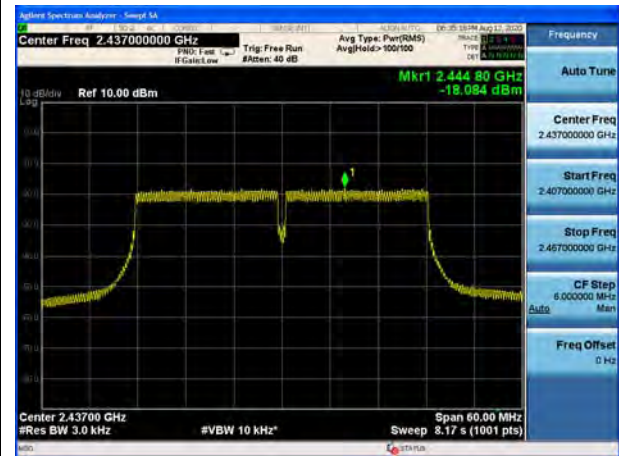

802.11n(HT40), Channel No.:7

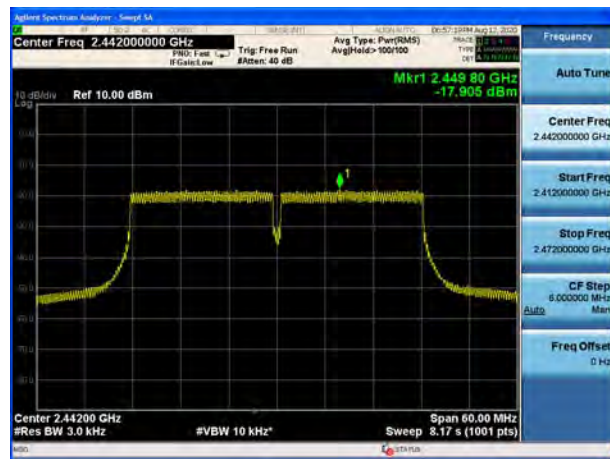

802.11n(HT40), Channel No.:8



802.11n(HT40), Channel No.:9



SISO Antenna 2:

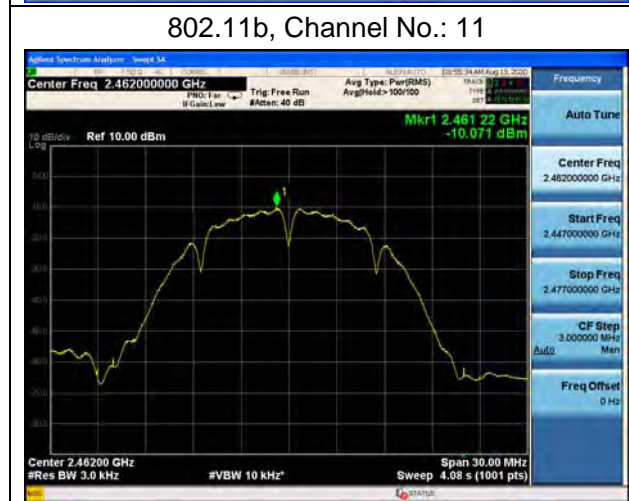



802.11g, Channel No.: 1



802.11g, Channel No.: 2

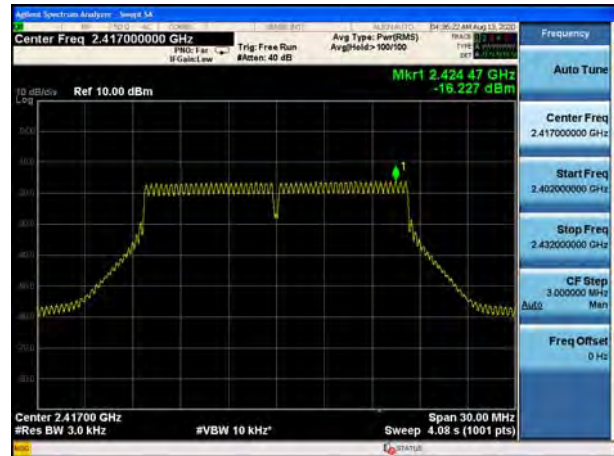

802.11g, Channel No.: 3



802.11g, Channel No.: 4

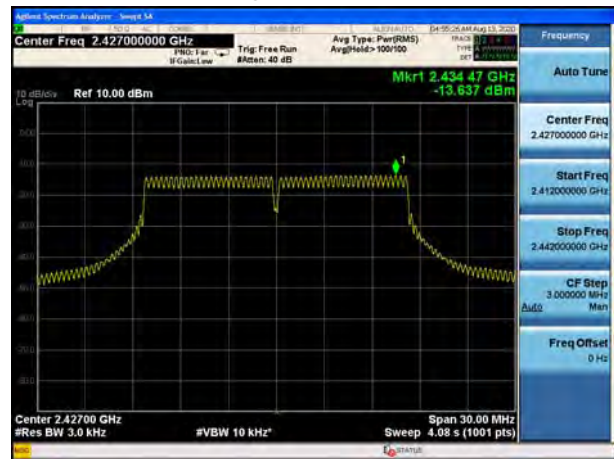

802.11g, Channel No.: 6



802.11g, Channel No.: 9

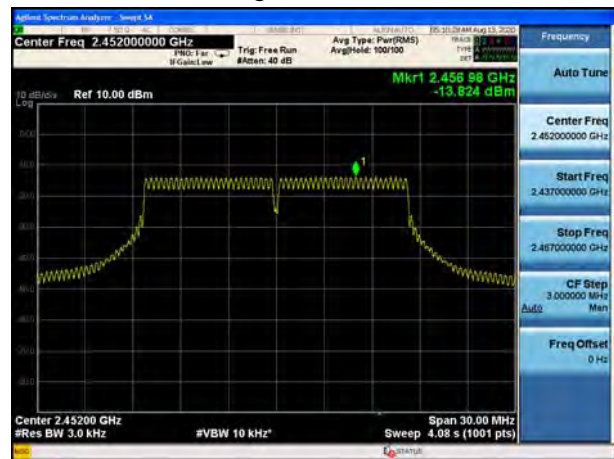



802.11g, Channel No.:10



802.11g, Channel No.:11

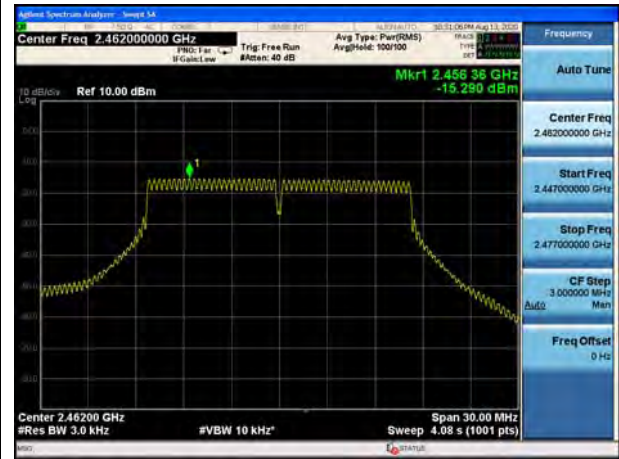

802.11n(HT20), Channel No.: 1

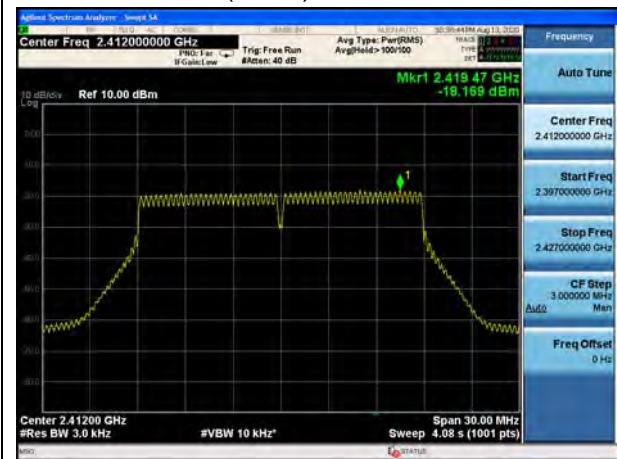

802.11n(HT20), Channel No.: 2

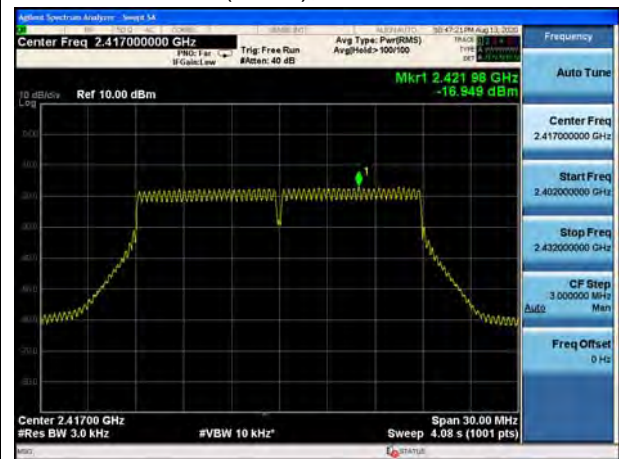

802.11n(HT20), Channel No.: 3

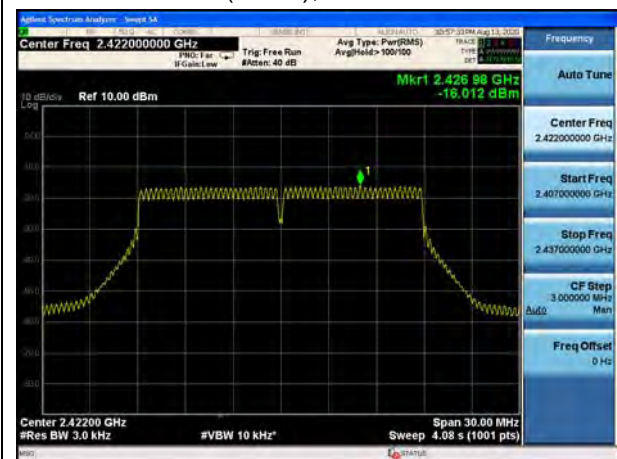

802.11n(HT20), Channel No.: 4

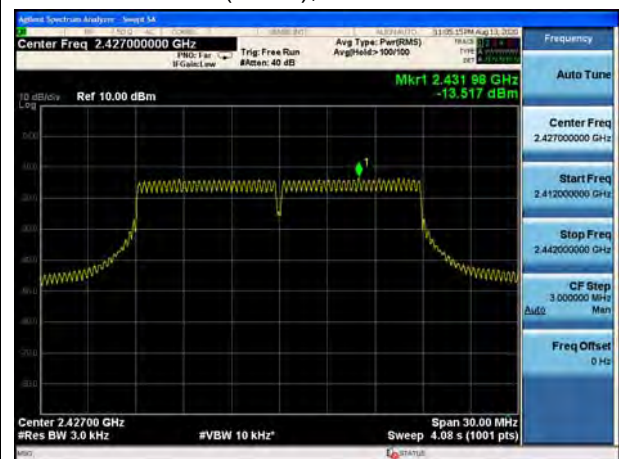



802.11n(HT20), Channel No.:6



802.11n(HT20), Channel No.:9

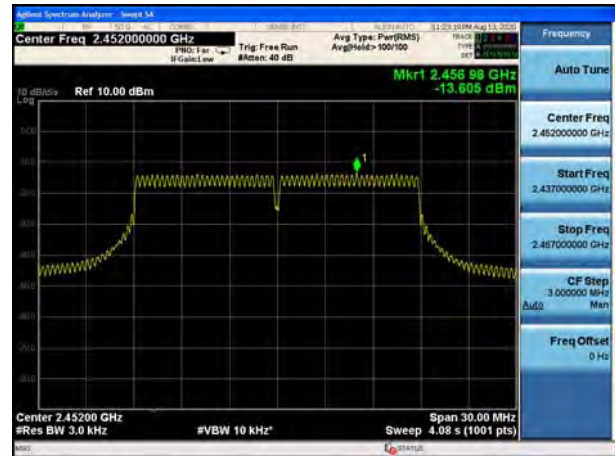

802.11n(HT20), Channel No.:10

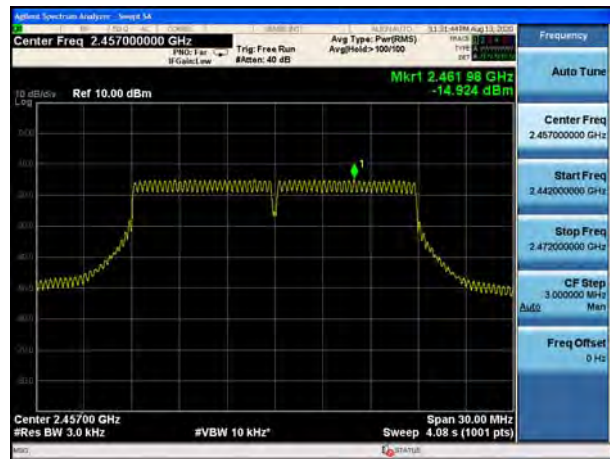

802.11n(HT20), Channel No.:11

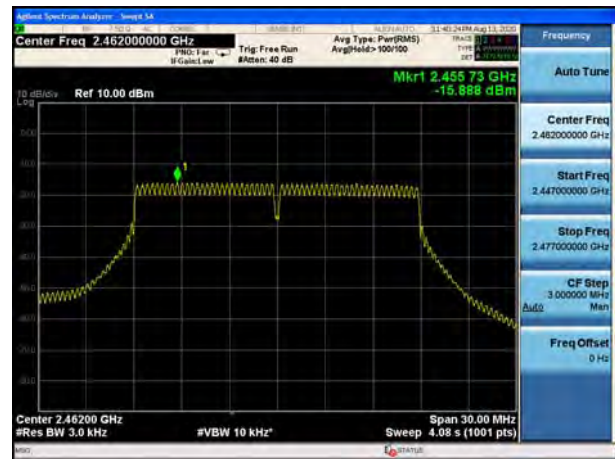

802.11n(HT40), Channel No.: 3



802.11n(HT40), Channel No.: 4

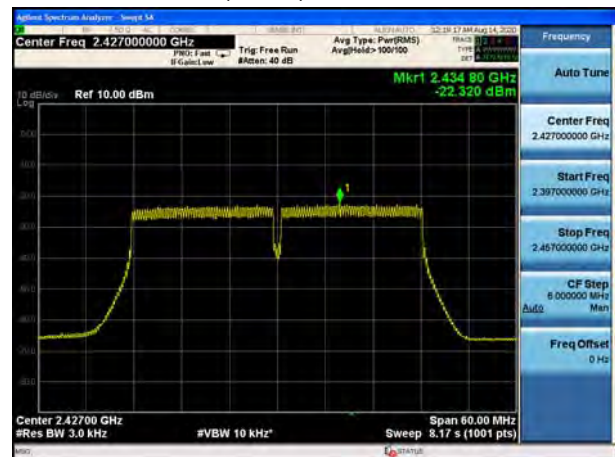



802.11n(HT40), Channel No.: 5



802.11n(HT40), Channel No.: 6

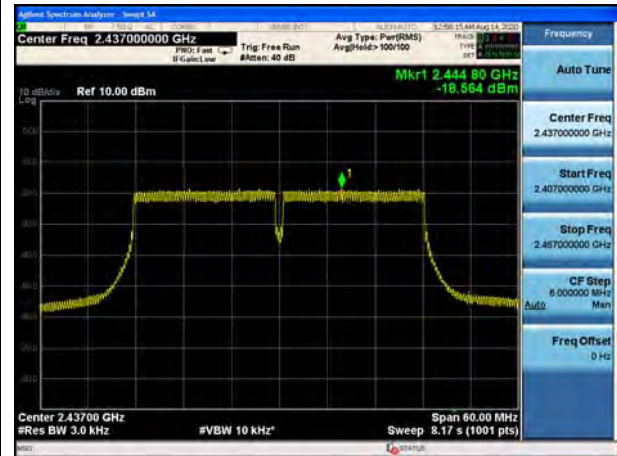

802.11n(HT40), Channel No.:7

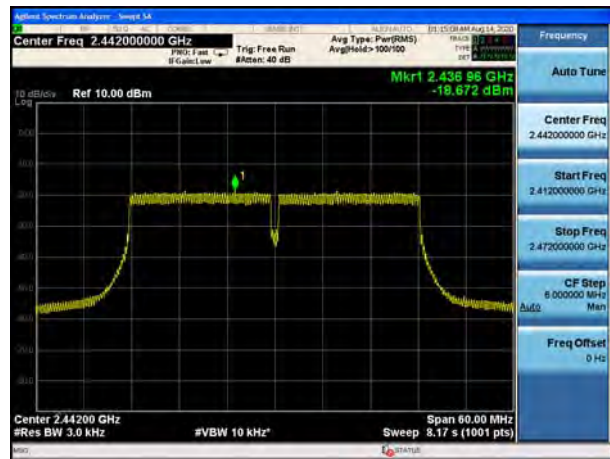

802.11n(HT40), Channel No.:8

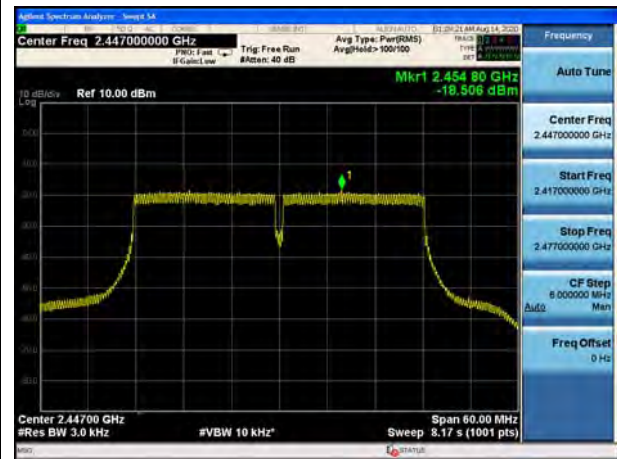

802.11n(HT40), Channel No.:9





MIMO Antenna 1:

802.11g, Channel No.: 1



802.11g, Channel No.: 2

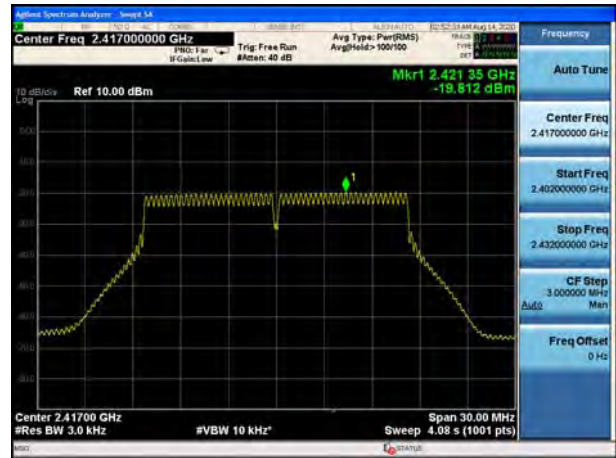

802.11g, Channel No.: 3



802.11g, Channel No.: 4

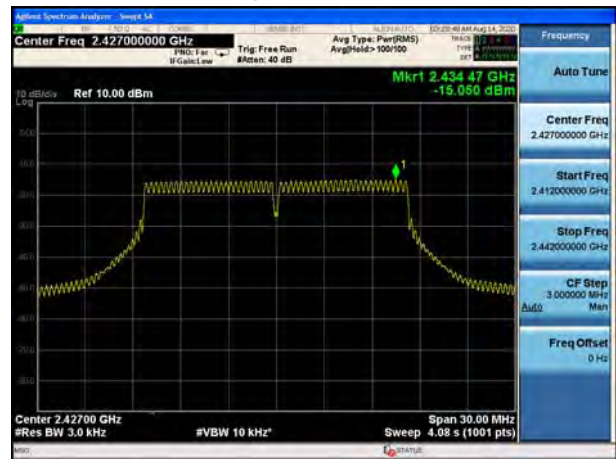

802.11g, Channel No.:6

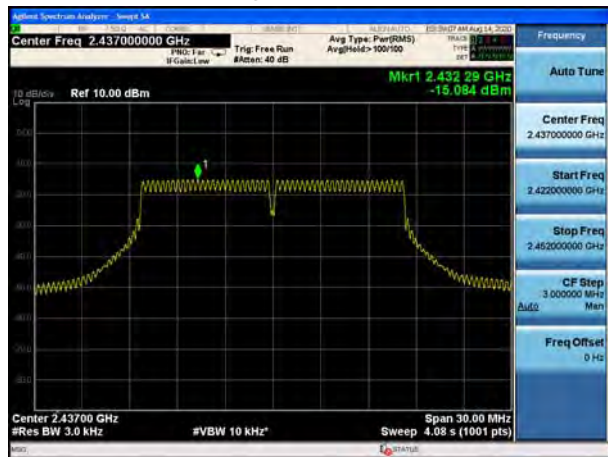

802.11g, Channel No.:9

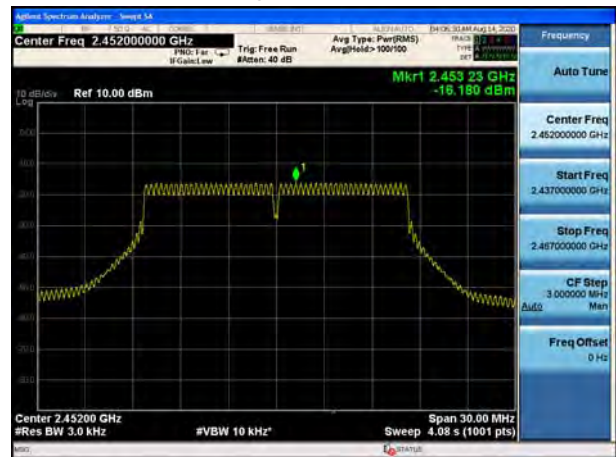



802.11g, Channel No.:10

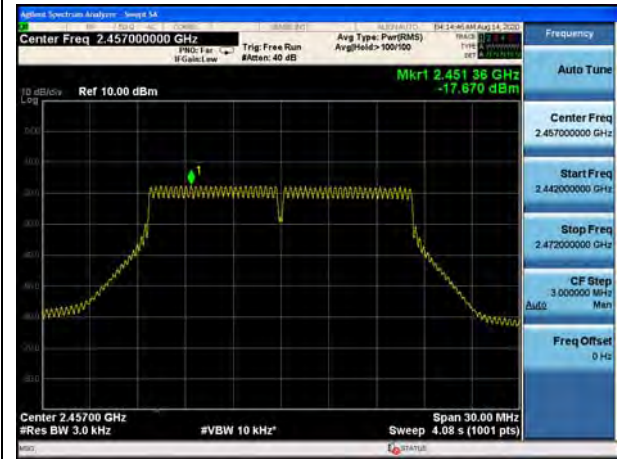

802.11g, Channel No.:11



802.11n(HT20), Channel No.: 1



802.11n(HT20), Channel No.: 2



802.11n(HT20), Channel No.: 3

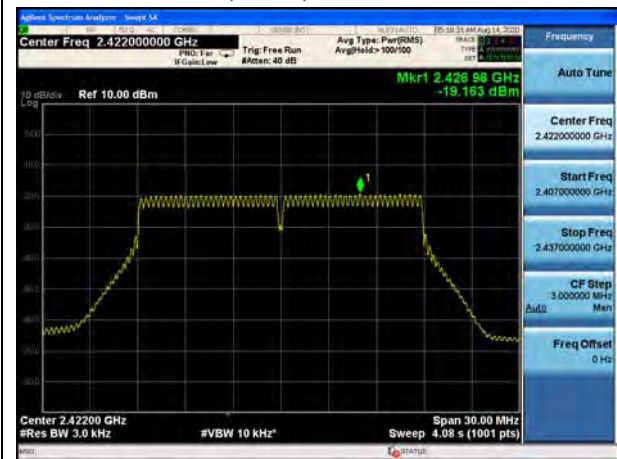

802.11n(HT20), Channel No.: 4

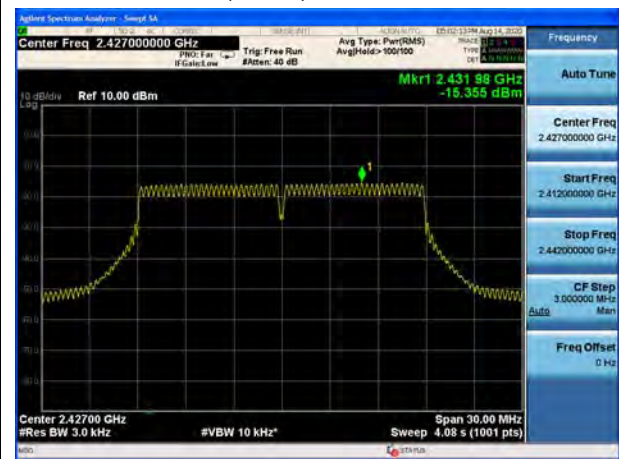



802.11n(HT20), Channel No.:6

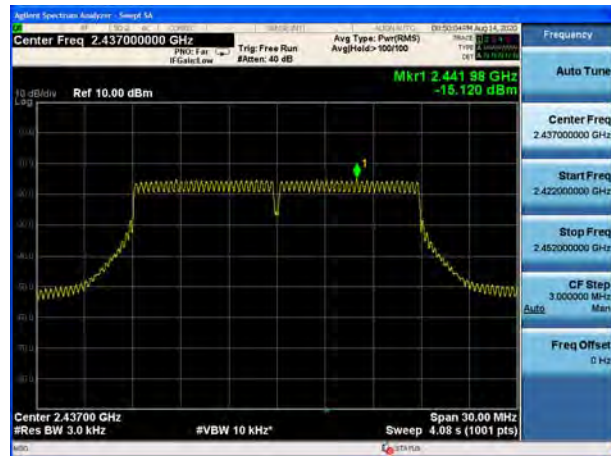

802.11n(HT20), Channel No.:9



802.11n(HT20), Channel No.:10

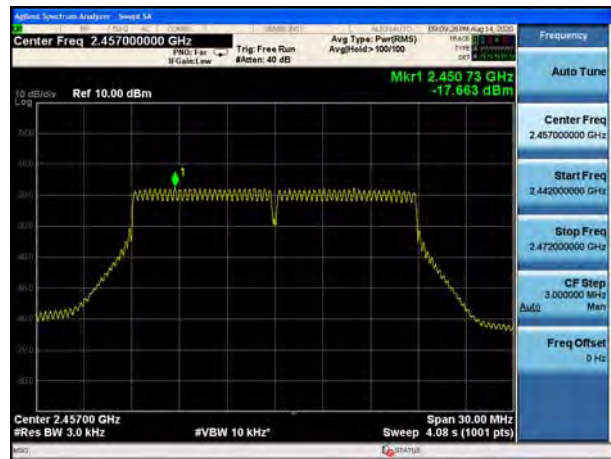

802.11n(HT20), Channel No.:11



802.11n(HT40), Channel No.: 3

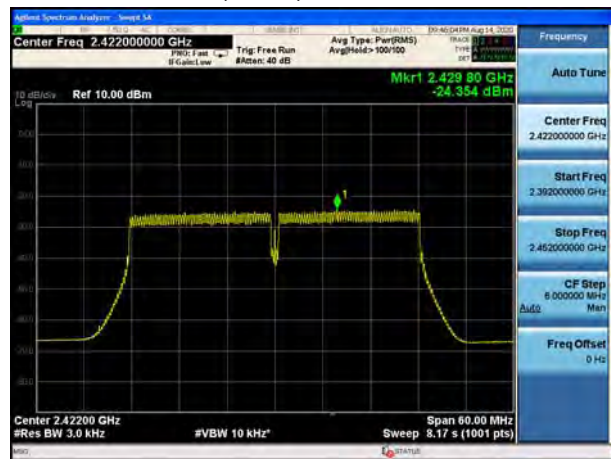

802.11n(HT40), Channel No.: 4

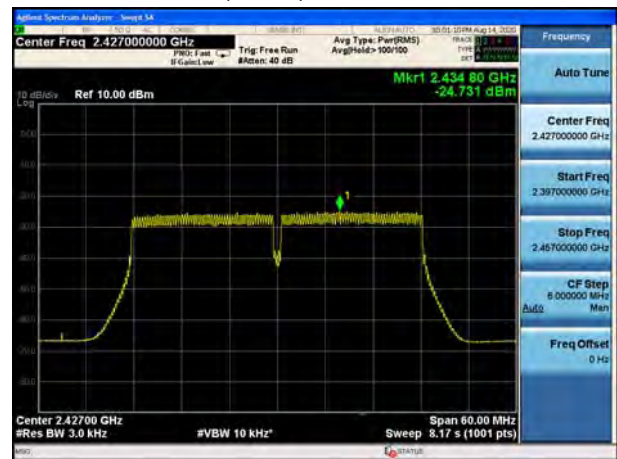



802.11n(HT40), Channel No.: 5

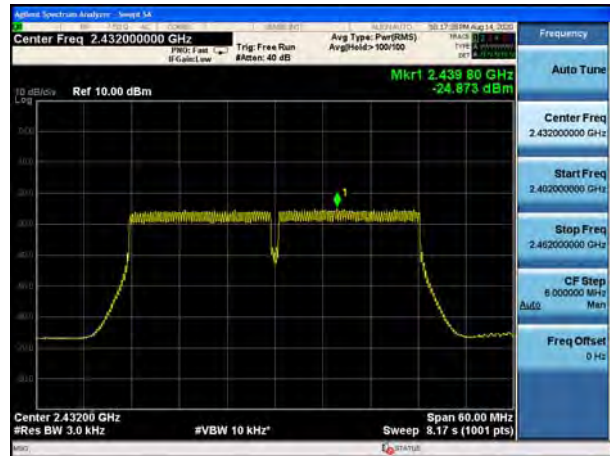

802.11n(HT40), Channel No.: 6

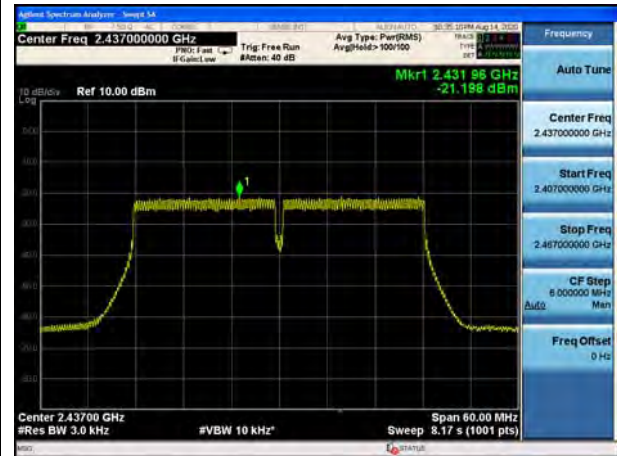

802.11n(HT40), Channel No.:7

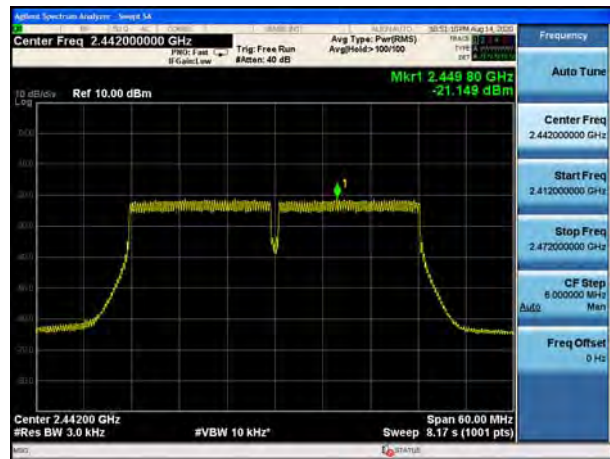

802.11n(HT40), Channel No.:8



802.11n(HT40), Channel No.:9

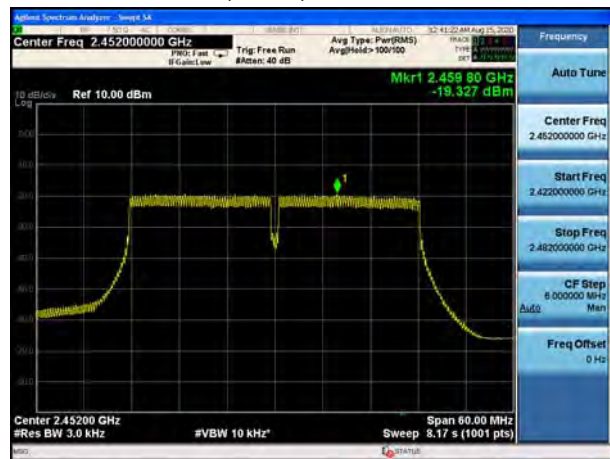



MIMO Antenna 2:

802.11g, Channel No.: 1



802.11g,



Channel No.: 2

802.11g, Channel No.: 3

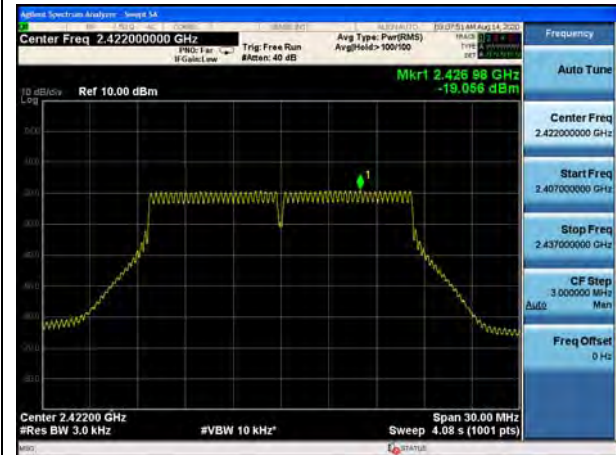

802.11g, Channel No.: 4



802.11g, Channel No.:6

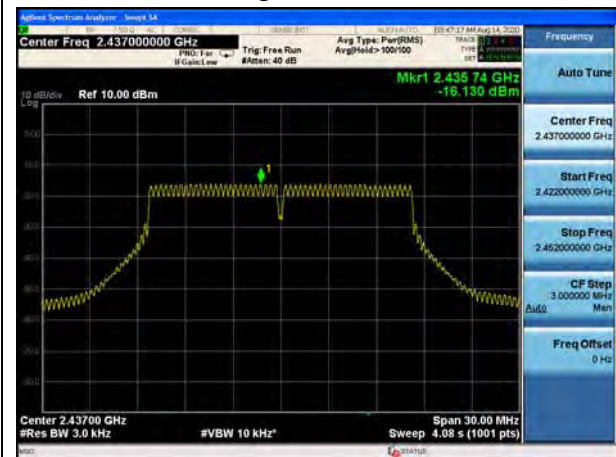

802.11g, Channel No.:9

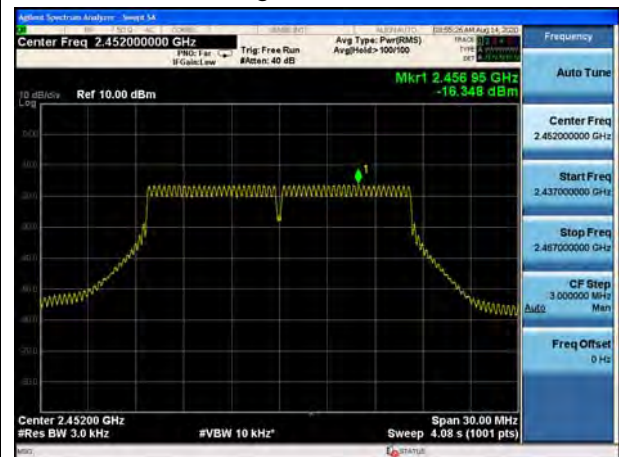



802.11g, Channel No.:10

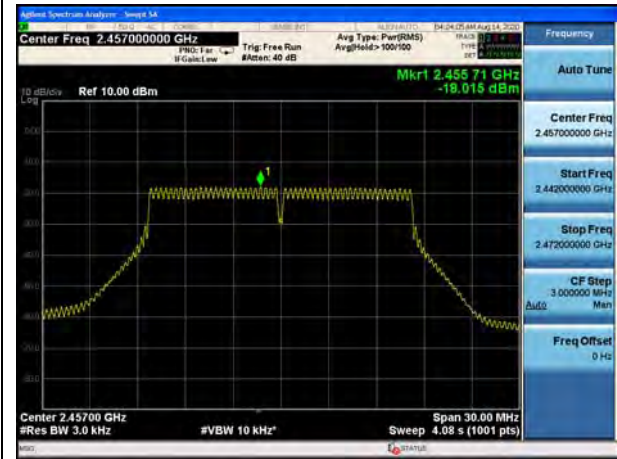

802.11g, Channel No.:11



802.11n(HT20), Channel No.: 1



802.11n(HT20), Channel No.: 2



802.11n(HT20), Channel No.: 3



802.11n(HT20), Channel No.: 4

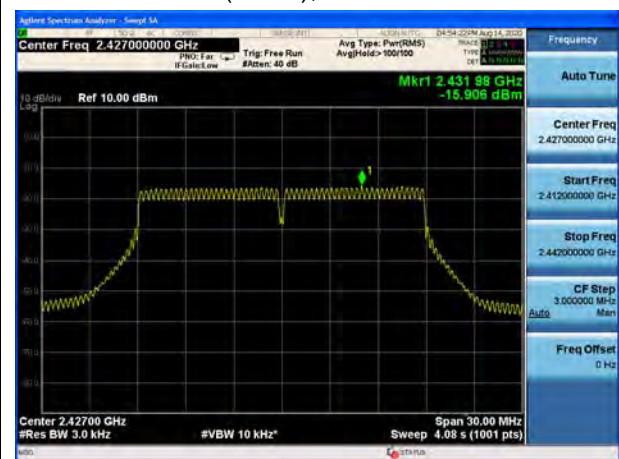



802.11n(HT20), Channel No.:6

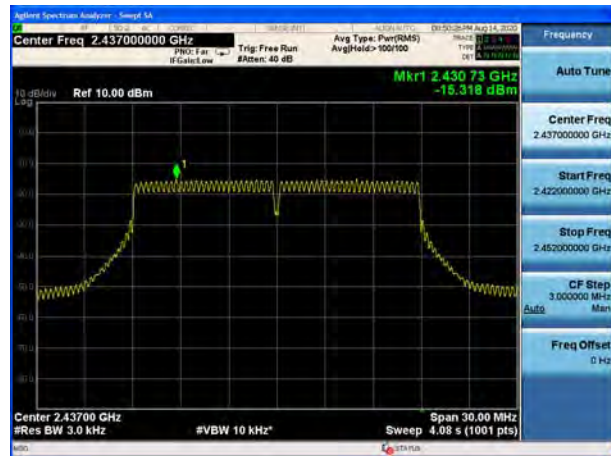

802.11n(HT20), Channel No.:9



802.11n(HT20), Channel No.:10

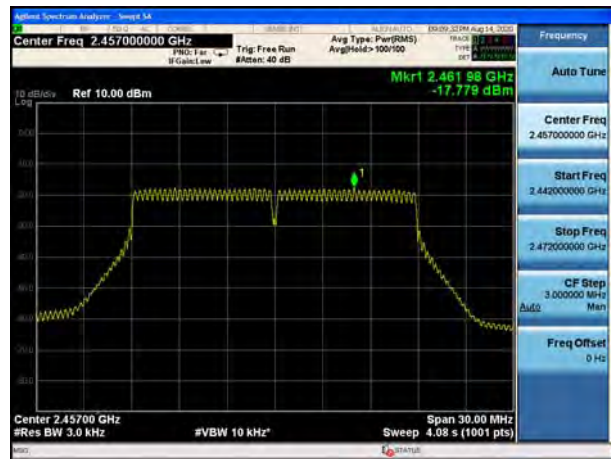

802.11n(HT20), Channel No.:11



802.11n(HT40), Channel No.: 3



802.11n(HT40), Channel No.: 4





802.11n(HT40), Channel No.: 5



802.11n(HT40), Channel No.: 6

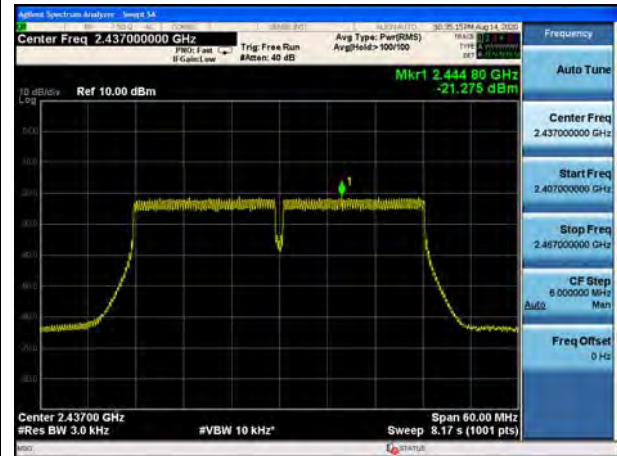

802.11n(HT40), Channel No.:7

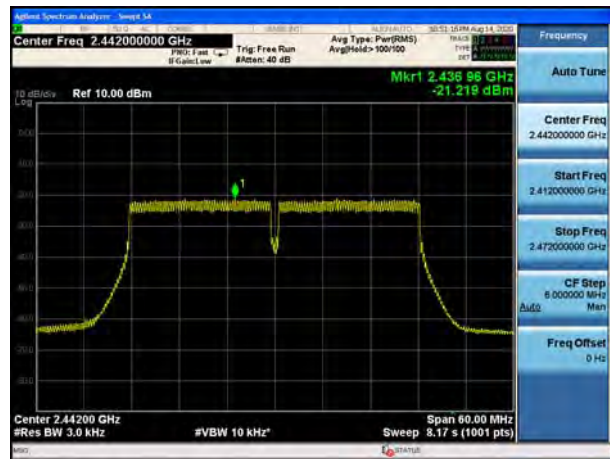

802.11n(HT40), Channel No.:8



802.11n(HT40), Channel No.:9

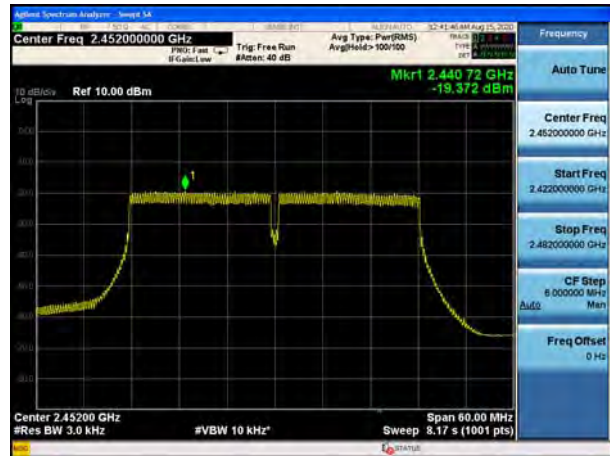

5.5. Spurious RF Conducted Emissions

Ambient condition

Temperature	Relative humidity	Pressure
23°C ~25°C	45%~50%	101.5kPa

Method of Measurement

The EUT was connected to the spectrum analyzer with a known loss. The spectrum analyzer scans from 30MHz to the 10th harmonic of the carrier. The peak detector is used. Set RBW to 100 kHz and VBW to 300 kHz, Sweep is set to ATUO.

The test is in transmitting mode.

Test setup



Limits

Rule Part 15.247(d) pacifies that “In any 100 kHz bandwidth outside the frequency band in which the spread spectrum or digitally modulated intentional radiator is operating, the radio frequency power that is produced by the intentional radiator shall be at least 20 dB below that in the 100 kHz bandwidth within the band that contains the highest level of the desired power, based on either an RF conducted or a radiated measurement, provided the transmitter demonstrates compliance with the peak conducted power limits. If the transmitter complies with the conducted power limits based on the use of RMS averaging over a time interval, as permitted under paragraph (b)(3) of this section, the attenuation required under this paragraph shall be 30 dB instead of 20 dB. ”

SISO Antenna 1 and MIMO Antenna

Network Standards	Carrier frequency (MHz)	Reference value (dBm)	Limit
802.11b	2412	14.85	-15.15
	2437	15.20	-14.80
	2462	13.51	-16.49
802.11g	2412	6.89	-23.11
	2417	8.77	-21.23
	2422	9.88	-20.12
	2427	11.11	-18.89
	2437	11.76	-18.24
	2452	10.65	-19.35
	2457	10.99	-19.01
	2462	8.92	-21.08



802.11n HT20	2412	7.19	-22.81
	2417	7.71	-22.29
	2422	9.33	-20.67
	2427	11.26	-18.74
	2437	11.08	-18.92
	2452	10.79	-19.21
	2457	9.67	-20.33
	2462	8.70	-21.30
802.11n HT40	2422	2.32	-27.68
	2427	2.48	-27.52
	2432	3.33	-26.67
	2437	2.46	-27.54
	2442	2.16	-27.84
	2447	2.29	-27.71
	2452	0.85	-29.15

Measurement Uncertainty

The assessed measurement uncertainty to ensure 95% confidence level for the normal distribution is with the coverage factor $k = 1.96$.

Frequency	Uncertainty
100kHz-2GHz	0.684 dB
2GHz-26GHz	1.407 dB



Test Results: SISO Antenna 1

802.11b, Channel No.: 1

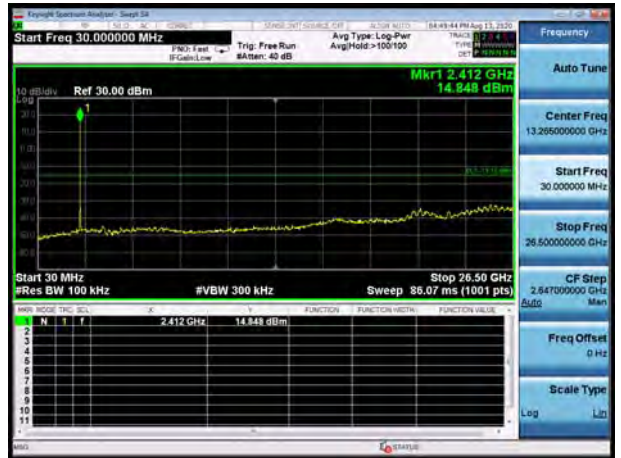

802.11b, Channel No.: 6

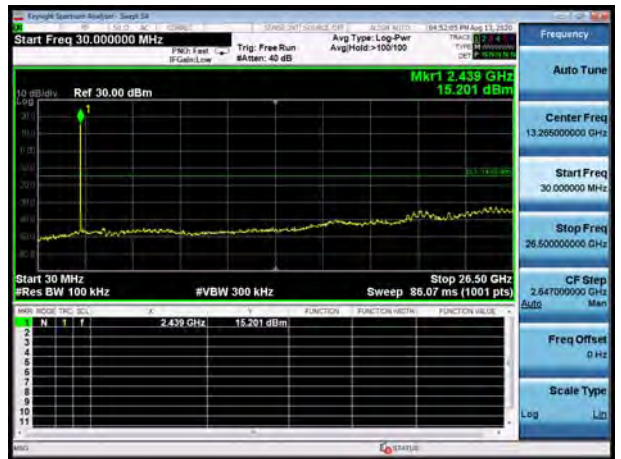

802.11b, Channel No.: 11

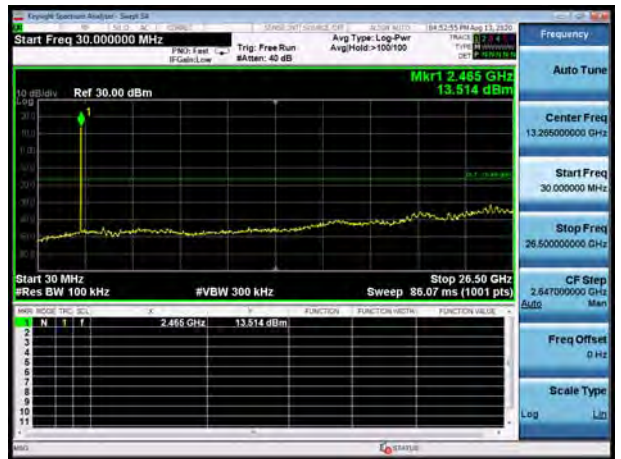



MIMO Antenna

802.11g, Channel No.: 1

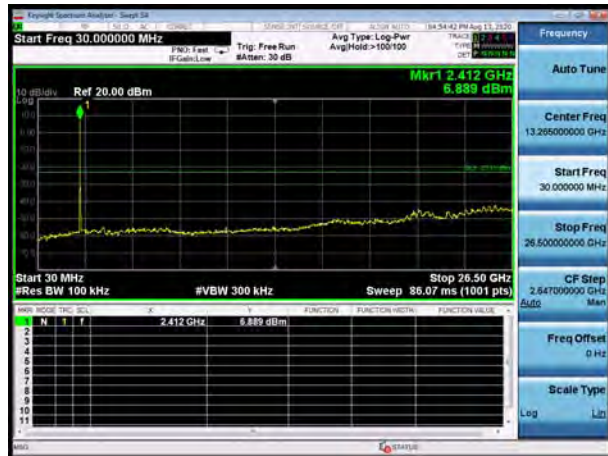

802.11g, Channel No.: 2

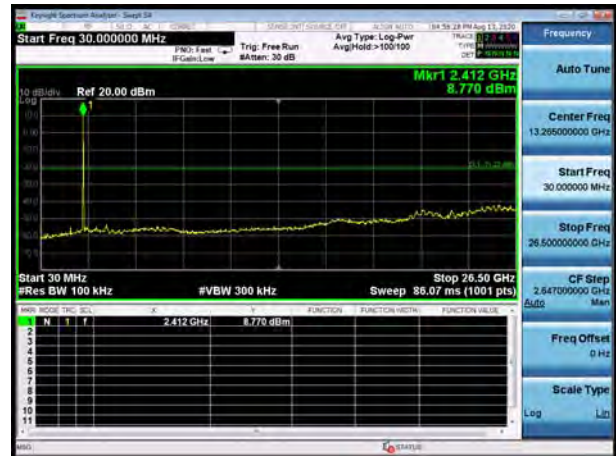

802.11g, Channel No.: 3



802.11g, Channel No.: 4



802.11g, Channel No.: 6

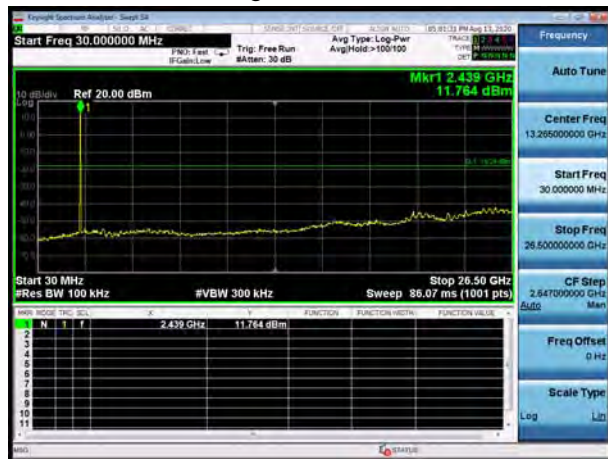

802.11g, Channel No.: 9

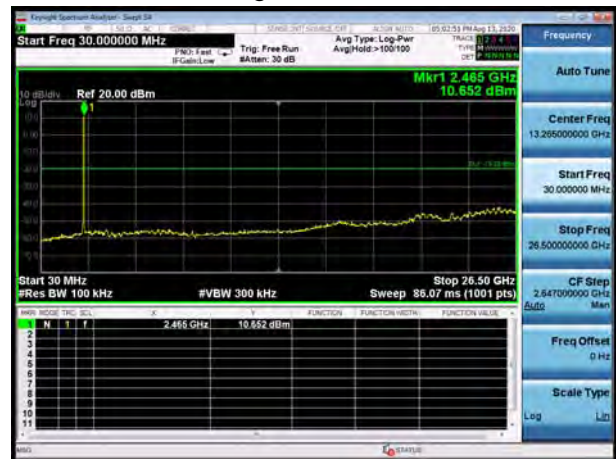



802.11g, Channel No.:10

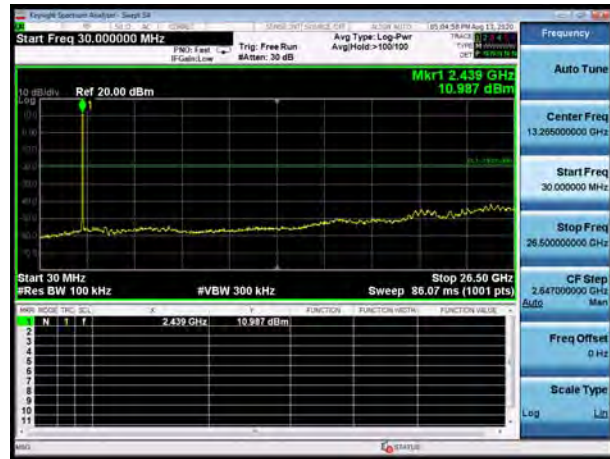

802.11g, Channel No.:11

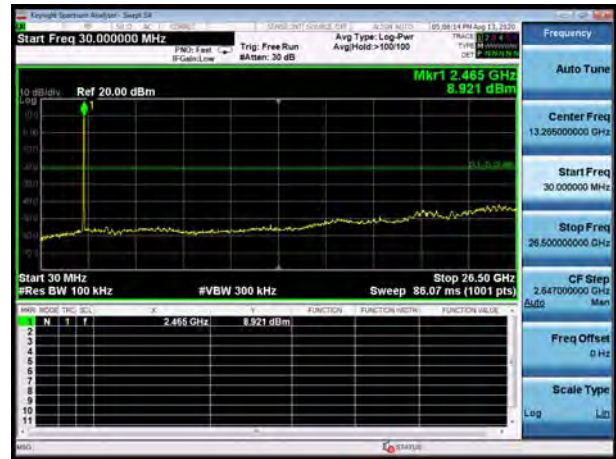

802.11n(HT20), Channel No.: 1

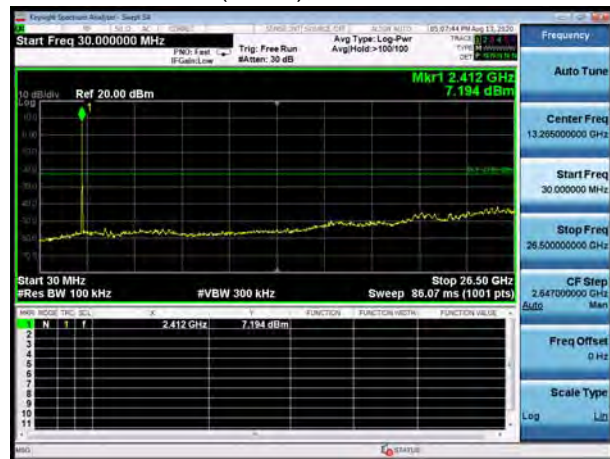

802.11n(HT20), Channel No.: 2

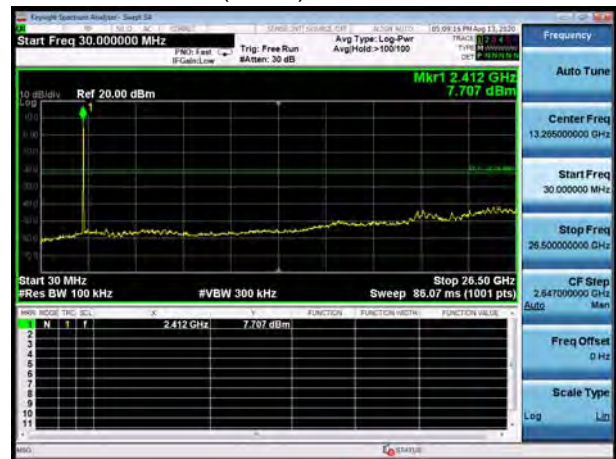

802.11n(HT20), Channel No.: 3

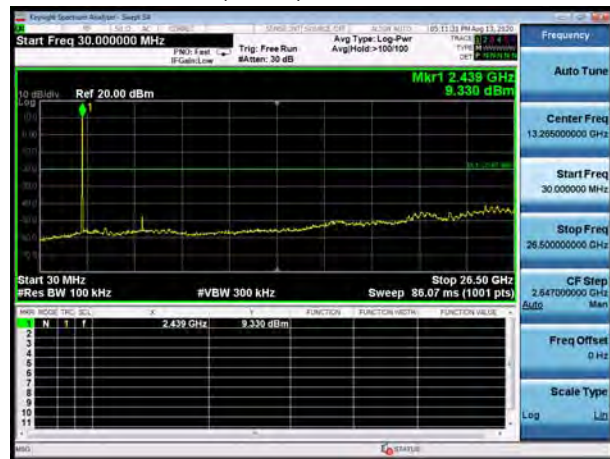

802.11n(HT20), Channel No.: 4

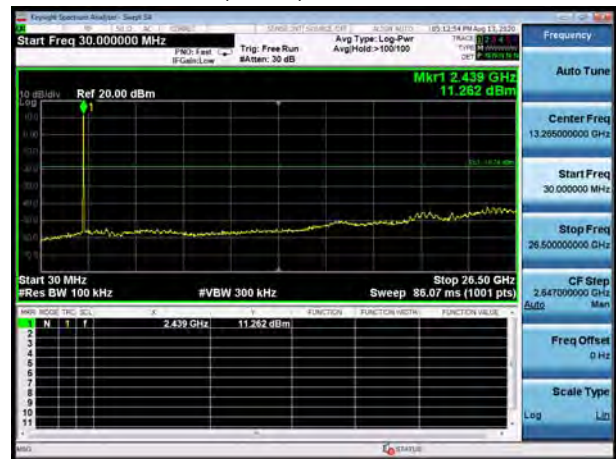



802.11n(HT20), Channel No.:6

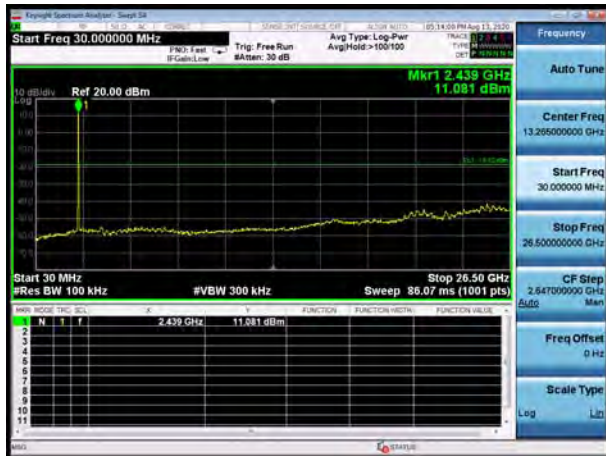

802.11n(HT20), Channel No.:9

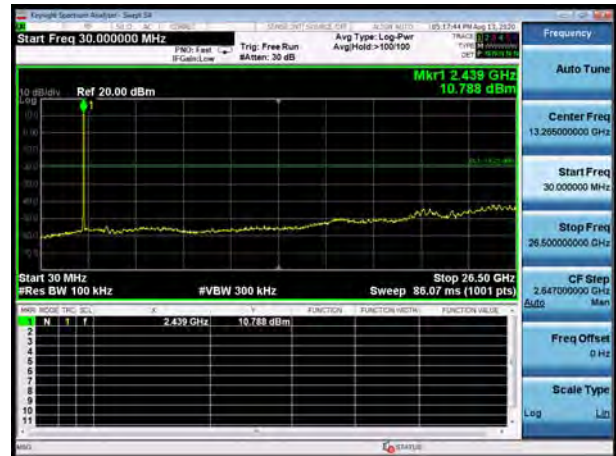

802.11n(HT20), Channel No.:10

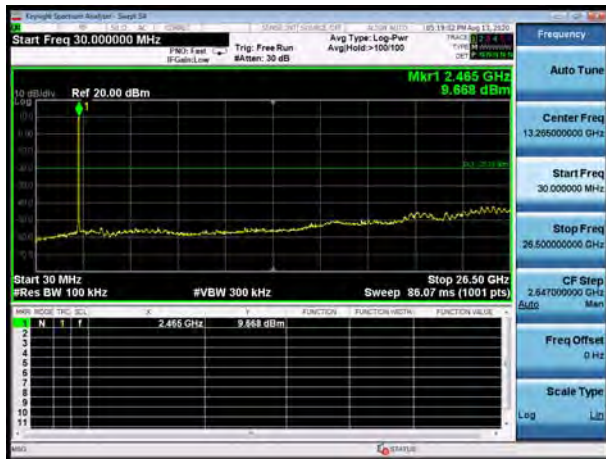

802.11n(HT20), Channel No.:11

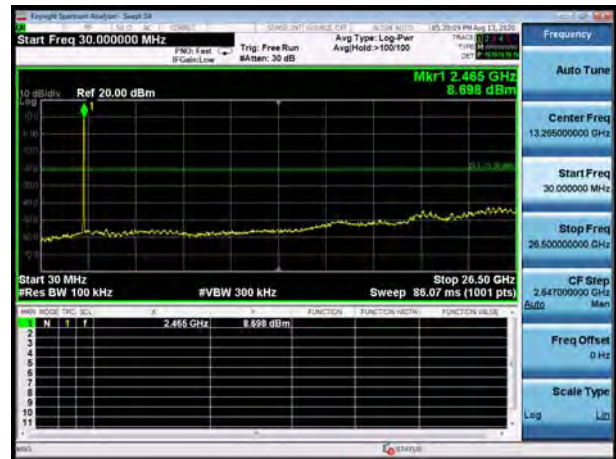

802.11n(HT40), Channel No.: 3

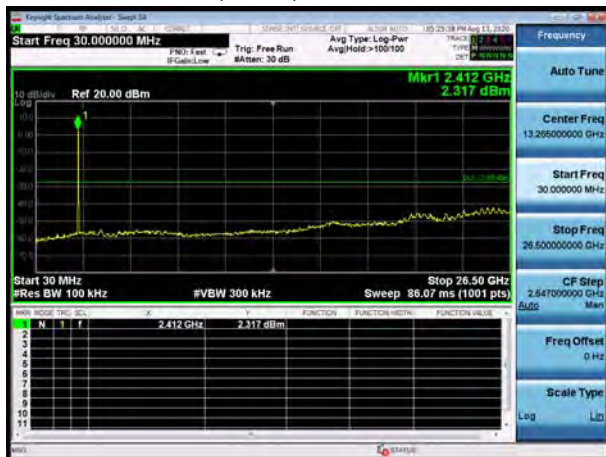

802.11n(HT40), Channel No.: 4

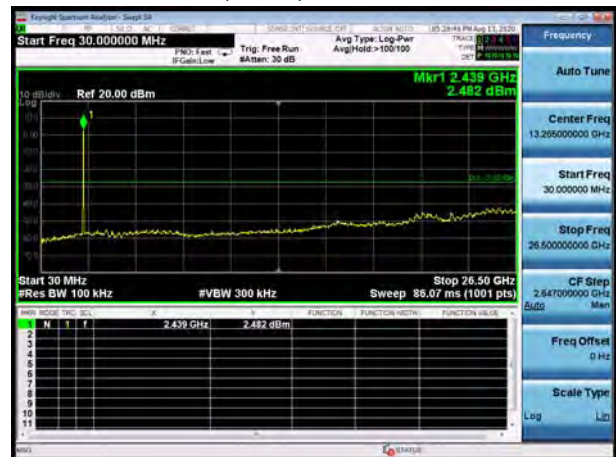



802.11n(HT40), Channel No.: 5

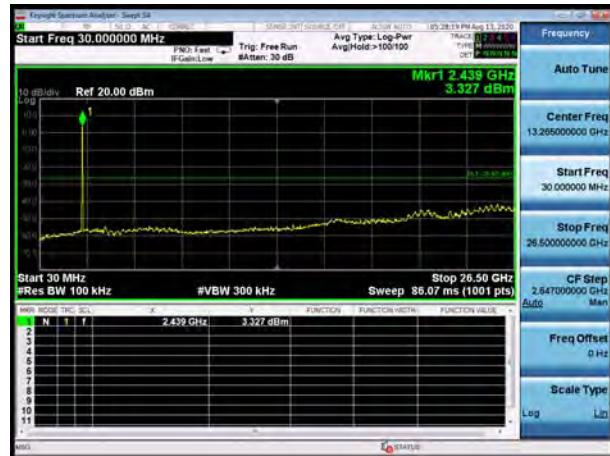

802.11n(HT40), Channel No.: 6

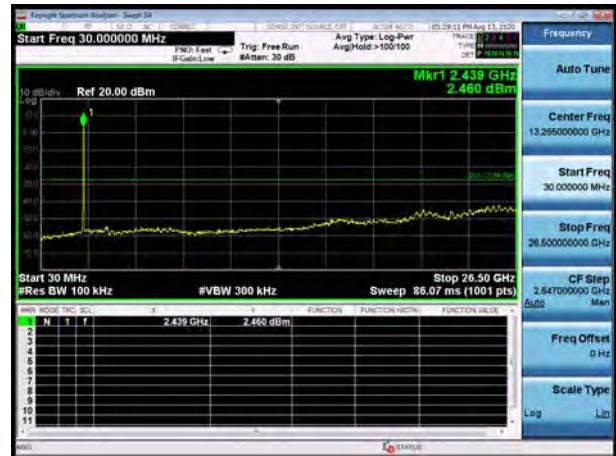

802.11n(HT40), Channel No.:7



802.11n(HT40), Channel No.:8

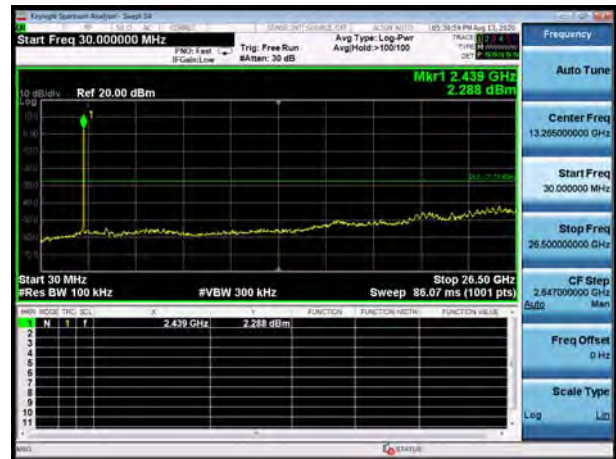

802.11n(HT40), Channel No.:9

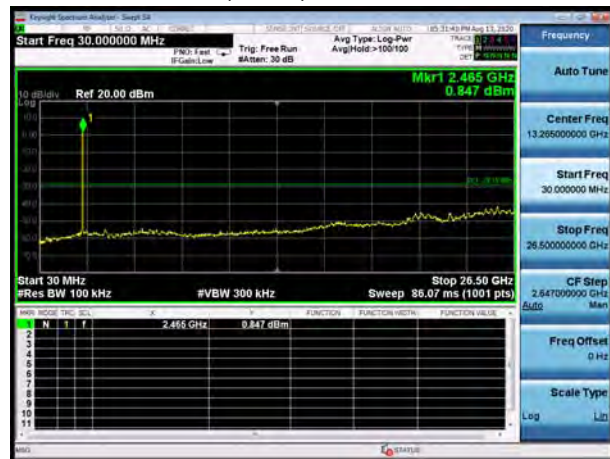

5.6. Unwanted Emission

Ambient condition

Temperature	Relative humidity	Pressure
23°C ~25°C	45%~50%	102.5kPa

Method of Measurement

The test set-up was made in accordance to the general provisions of ANSI C63.10-2013. The Equipment Under Test (EUT) was set up on a non-conductive table in the semi-anechoic chamber. The test was performed at the distance of 3 m between the EUT and the receiving antenna.

The turntable shall be rotated from 0 to 360 degrees for detecting the maximum of radiated spurious signal level. The measurements shall be repeated with orthogonal polarization of the test antenna. The data of cable loss and antenna factor has been calibrated in full testing frequency range before the testing. Sweep the Restricted Band and the emissions less than 20 dB below the permissible value are reported.

The radiated emissions measurements were made in a typical installation configuration. Sweep the whole frequency band through the range from 9 kHz to the 10th harmonic of the carrier, and the emissions less than 20 dB below the permissible value are reported.

This method refer to ANSI C63.10-2013.

The procedure for peak unwanted emissions measurements above 1000 MHz is as follows:

Set the spectrum analyzer in the following:

9kHz~150 kHz

RBW=200Hz, VBW=1kHz/ Sweep=AUTO

150 kHz~30MHz

RBW=9KHz, VBW=30KHz,/ Sweep=AUTO

Below 1GHz

RBW=100kHz / VBW=300kHz / Sweep=AUTO

a) Peak emission levels are measured by setting the instrument as follows:

Above 1GHz

PEAK: RBW=1MHz VBW=3MHz/ Sweep=AUTO

b) Average emission levels are measured by setting the instrument as follows:

Above 1GHz

AVERAGE: RBW=1MHz / VBW=3MHz / Sweep=AUTO

c) Detector: The measurements employing a CISPR quasi-peak detector except for the frequency bands 9-90 kHz, 110-490 kHz and above 1000 MHz. Radiated emission limits in these three bands are based on measurements employing an average detector.

d) Averaging type = power (i.e., rms) (As an alternative, the detector and averaging type may be set for linear voltage averaging. Some instruments require linear display mode to use linear voltage



averaging. Log or dB averaging shall not be used.)

e) Sweep time = auto.

f) Perform a trace average of at least 100 traces if the transmission is continuous. If the transmission is not continuous, then the number of traces shall be increased by a factor of $1 / D$, where D is the duty cycle. For example, with 50% duty cycle, at least 200 traces shall be averaged. (If a specific emission is demonstrated to be continuous—i.e., 100% duty cycle—then rather than turning ON and OFF with the transmit cycle, at least 100 traces shall be averaged.)

g) If tests are performed with the EUT transmitting at a duty cycle less than 98%, then a correction factor shall be added to the measurement results prior to comparing with the emission limit, to compute the emission level that would have been measured had the test been performed at 100% duty cycle. The correction factor is computed as follows:

1) If power averaging (rms) mode was used in the preceding step e), then the correction factor is $[10 \log (1 / D)]$, where D is the duty cycle. For example, if the transmit duty cycle was 50%, then 3 dB shall be added to the measured emission levels.

2) If linear voltage averaging mode was used in the preceding step e), then the correction factor is $[20 \log (1 / D)]$, where D is the duty cycle. For example, if the transmit duty cycle was 50%, then 6 dB shall be added to the measured emission levels.

3) If a specific emission is demonstrated to be continuous (100% duty cycle) rather than turning ON and OFF with the transmit cycle, then no duty cycle correction is required for that emission.

The test is in transmitting mode.

Test setup

9KHz ~ 30MHz

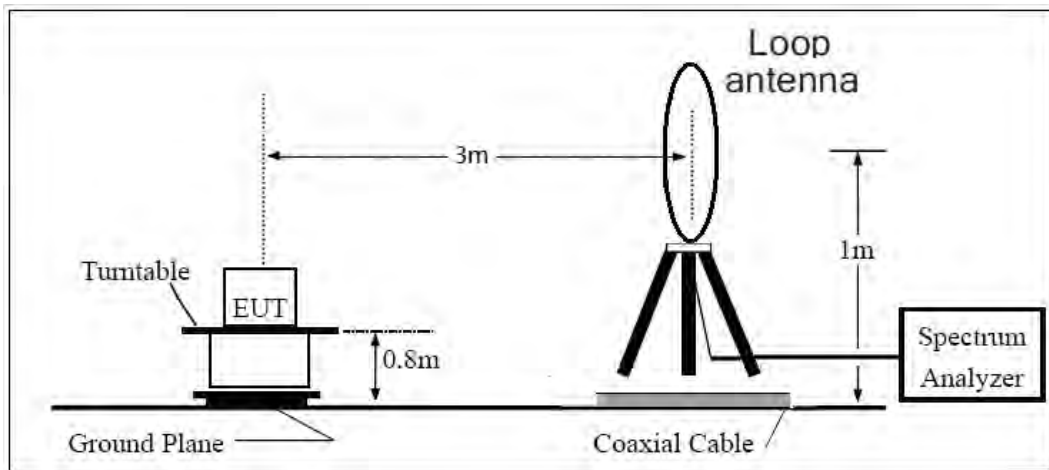

30MHz ~ 1GHz

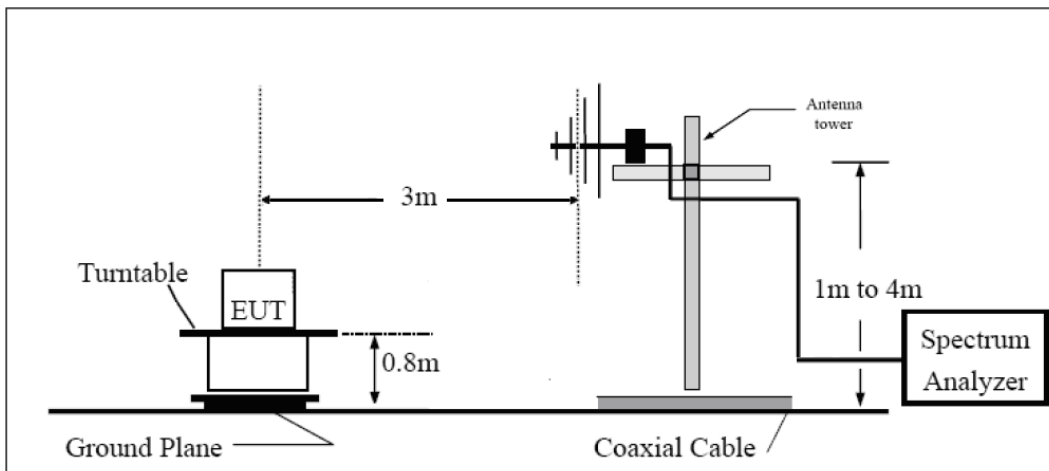

Above 1GHz

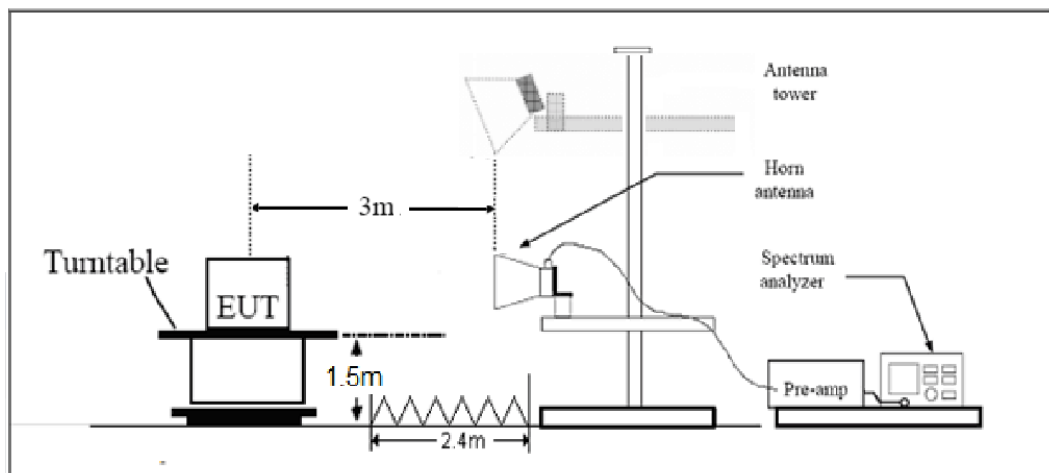

Note: Area side:2.4mX3.6m

**Limits**

Rule Part 15.247(d) specifies that "In addition, radiated emissions which fall in the restricted bands, as defined in § 15.205(a), must also comply with the radiated emission limits specified in § 15.209(a) (see § 15.205(c))."

Limit in restricted band

Frequency of emission (MHz)	Field strength(uV/m)	Field strength(dBuV/m)
0.009–0.490	2400/F(kHz)	/
0.490–1.705	24000/F(kHz)	/
1.705–30.0	30	/
30-88	100	40
88-216	150	43.5
216-960	200	46
Above960	500	54

§15.35(b)

There is also a limit on the radio frequency emissions, as measured using instrumentation with a peak detector function, corresponding to 20 dB above the maximum permitted average limit.

Peak Limit=74 dBuV/m

Average Limit=54 dBuV/m

Spurious Radiated Emissions are permitted in any of the frequency bands listed below:

MHz	MHz	MHz	GHz
0.090 - 0.110	16.42 - 16.423	399.9 - 410	4.5 - 5.15
¹ 0.495 - 0.505	16.69475 - 16.69525	608 - 614	5.35 - 5.46
2.1735 - 2.1905	16.80425 - 16.80475	960 - 1240	7.25 - 7.75
4.125 - 4.128	25.5 - 25.67	1300 - 1427	8.025 - 8.5
4.17725 - 4.17775	37.5 - 38.25	1435 - 1626.5	9.0 - 9.2
4.20725 - 4.20775	73 - 74.6	1645.5 - 1646.5	9.3 - 9.5
6.215 - 6.218	74.8 - 75.2	1660 - 1710	10.6 - 12.7
6.26775 - 6.26825	108 - 121.94	1718.8 - 1722.2	13.25 - 13.4
6.31175 - 6.31225	123 - 138	2200 - 2300	14.47 - 14.5
8.291 - 8.294	149.9 - 150.05	2310 - 2390	15.35 - 16.2
8.362 - 8.366	156.52475 - 156.52525	2483.5 - 2500	17.7 - 21.4
8.37625 - 8.38675	156.7 - 156.9	2690 - 2900	22.01 - 23.12
8.41425 - 8.41475	162.0125 - 167.17	3260 - 3267	23.6 - 24.0
12.29 - 12.293	167.72 - 173.2	3332 - 3339	31.2 - 31.8
12.51975 - 12.52025	240 - 285	3345.8 - 3358	36.43 - 36.5
12.57675 - 12.57725	322 - 335.4	3600 - 4400	(²)
13.36 - 13.41			

**Measurement Uncertainty**

The assessed measurement uncertainty to ensure 95% confidence level for the normal distribution is with the coverage factor $k = 1.96$.

Frequency	Uncertainty
9KHz-30MHz	3.55 dB
30MHz-200MHz	4.17 dB
200MHz-1GHz	4.84 dB
1-18GHz	4.35 dB
18-26.5GHz	5.90 dB
26.5GHz~40GHz	5.92 dB



Test Results:

SISO Antenna 1

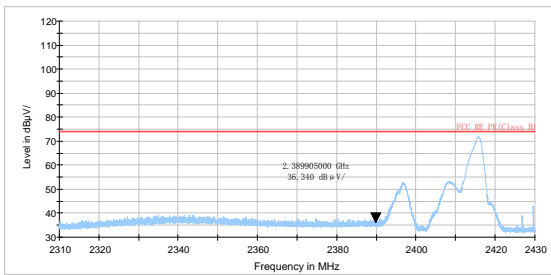

802.11b-Channel 1 Peak

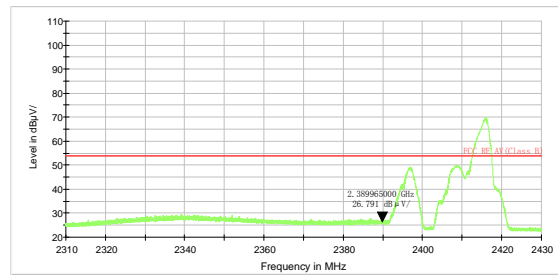

802.11b-Channel 1 Average

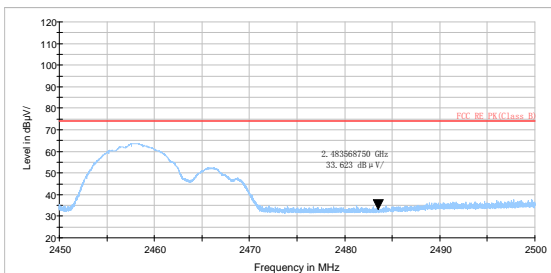

802.11b-Channel 11 Peak

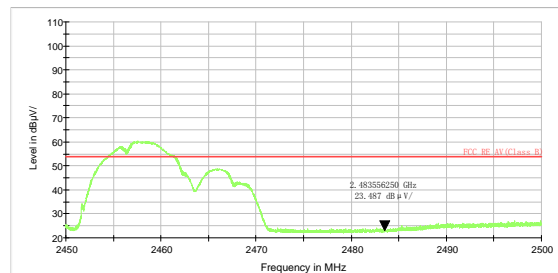

802.11b-Channel 11 Average

MIMO Antenna

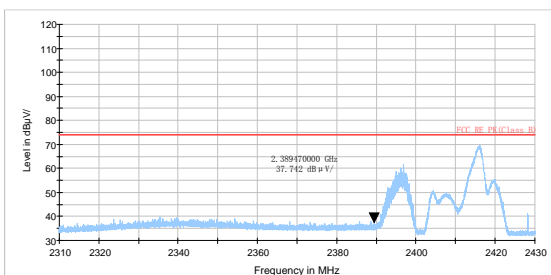

802.11g-Channel 1 Peak

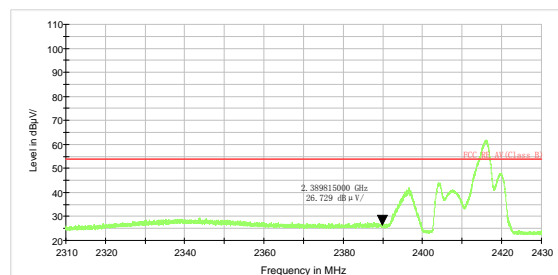

802.11g-Channel 1 Average

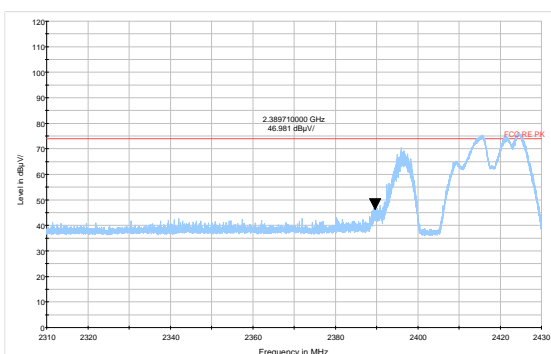

802.11g-Channel 2 Peak

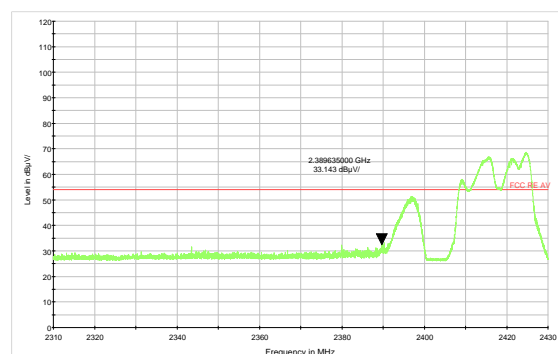

802.11g-Channel 2 Average

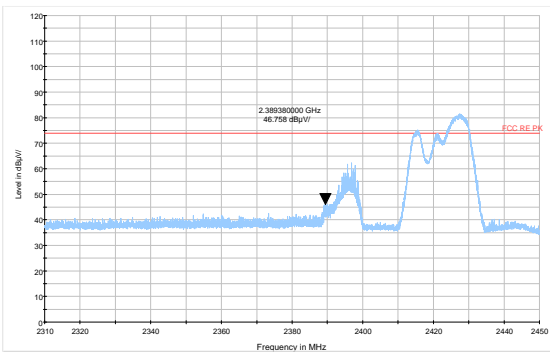

802.11g-Channel 3 Peak

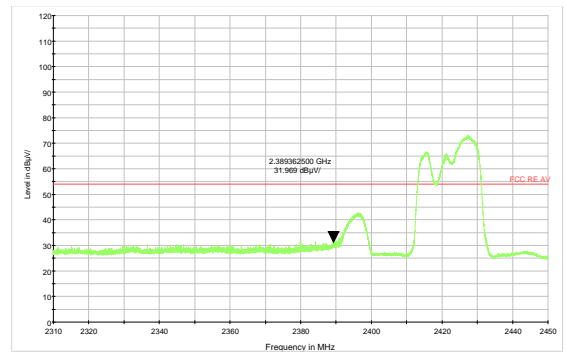

802.11g-Channel 3 Average

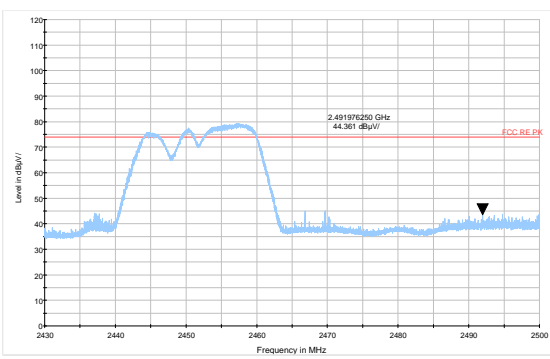

802.11g-Channel 9 Peak

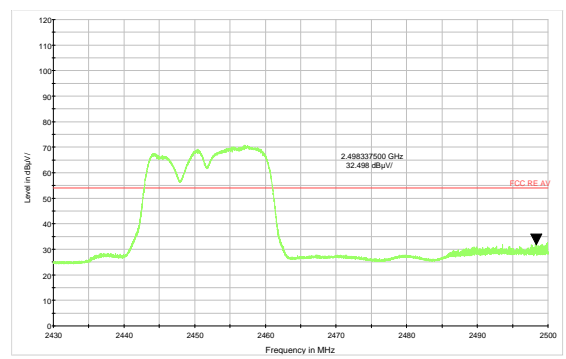

802.11g-Channel 9 Average

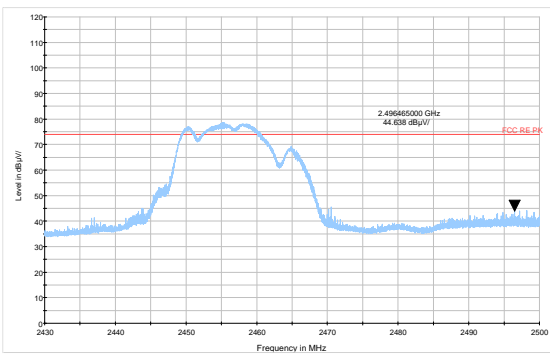

802.11g-Channel 10 Peak

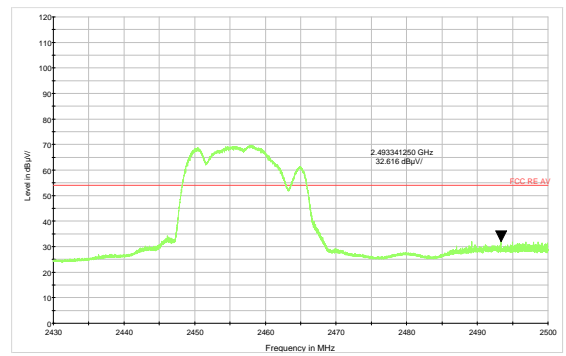

802.11g-Channel 10 Average

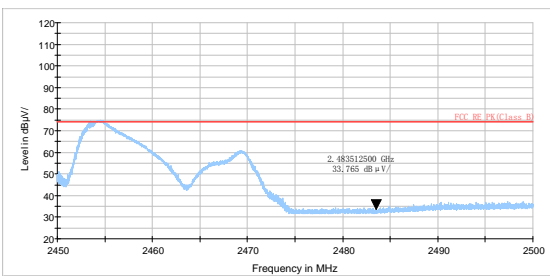

802.11g-Channel 11 Peak

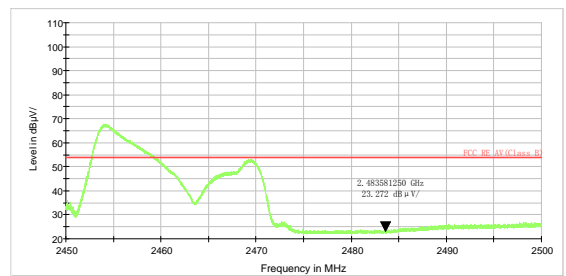

802.11g-Channel 11 Average

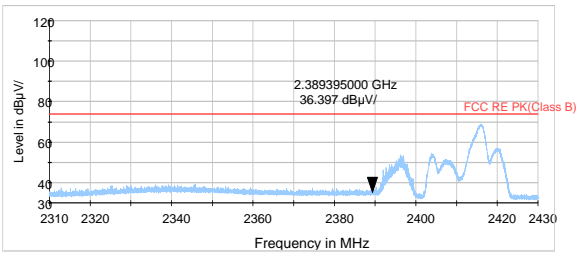

802.11n HT20 -Channel 1 Peak

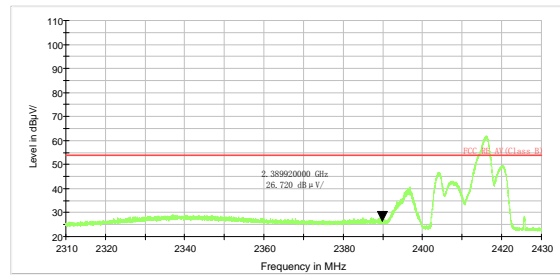

802.11n HT20 -Channel 1 Average

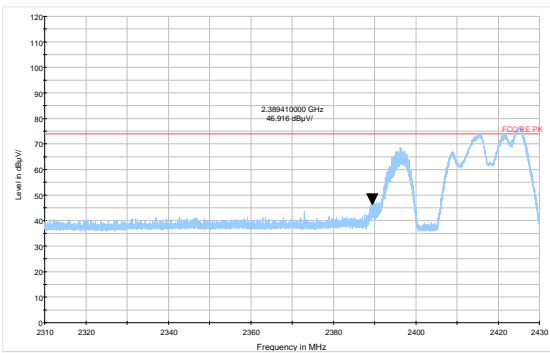

802.11n HT20 -Channel 2 Peak

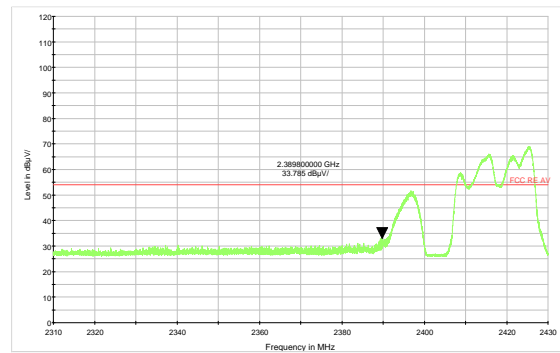

802.11n HT20 -Channel 2 Average

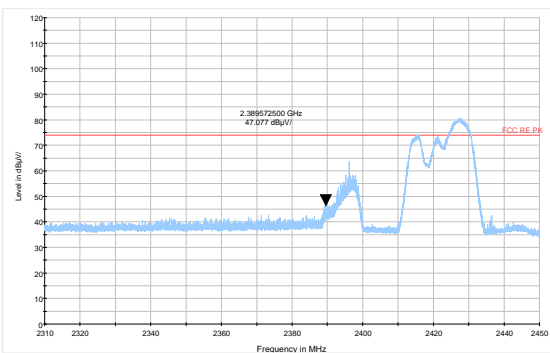

802.11n HT20 -Channel 3 Peak

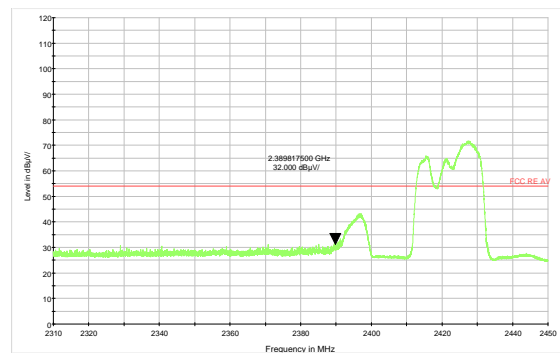

802.11n HT20 -Channel 3 Average

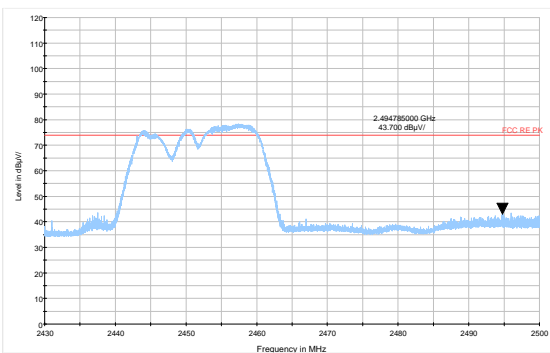

802.11n HT20 -Channel 9 Peak

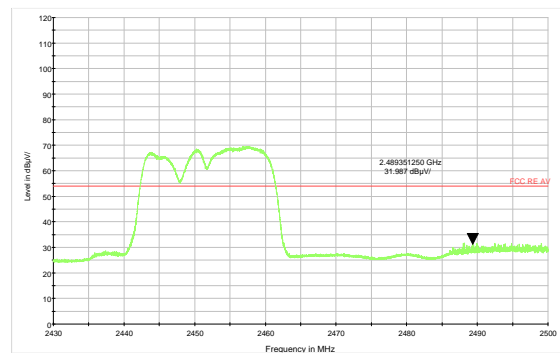

802.11n HT20 -Channel 9 Average

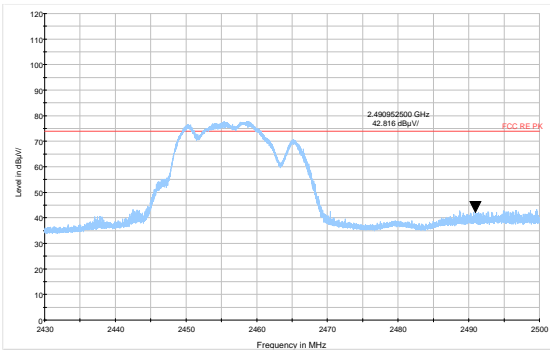

802.11n HT20 -Channel 10 Peak

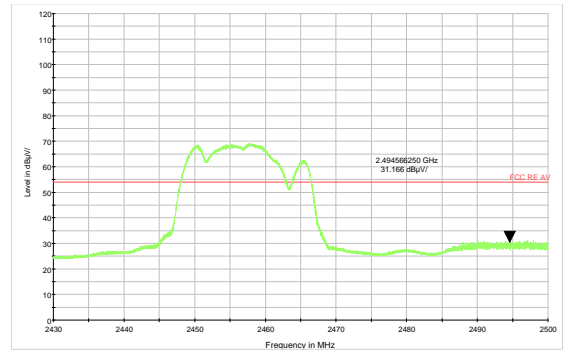

802.11n HT20 -Channel 10 Average

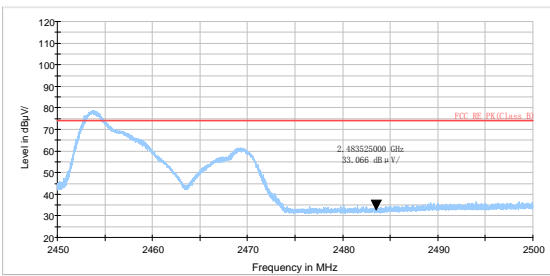

802.11n HT20 -Channel 11 Peak

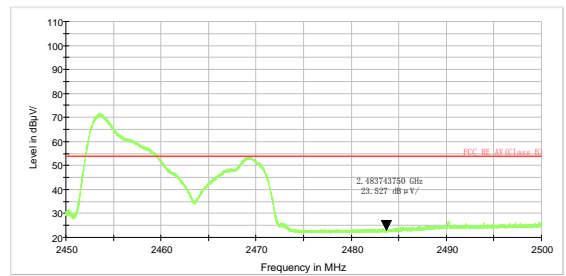

802.11n HT20 -Channel 11 Average

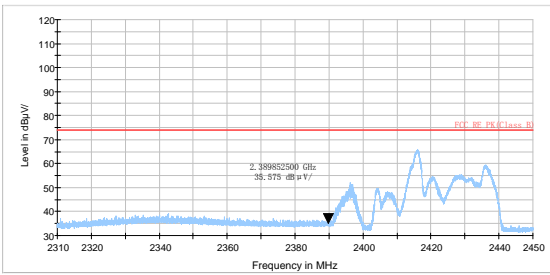

802.11n HT40 -Channel 3 Peak

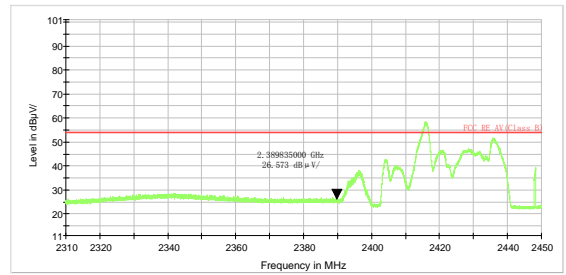

802.11n HT40 -Channel 3 Average

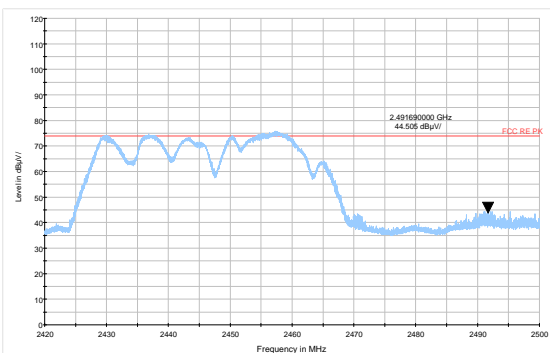

802.11n HT40 -Channel 8 Peak

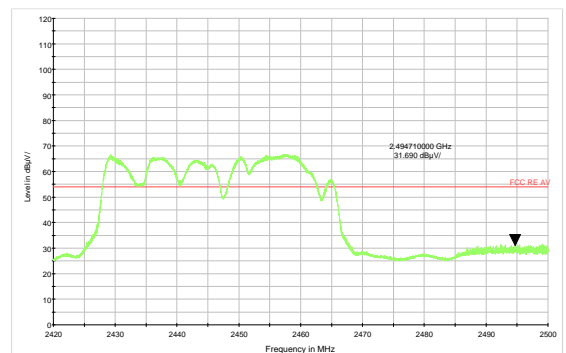

802.11n HT40 -Channel 8 Average

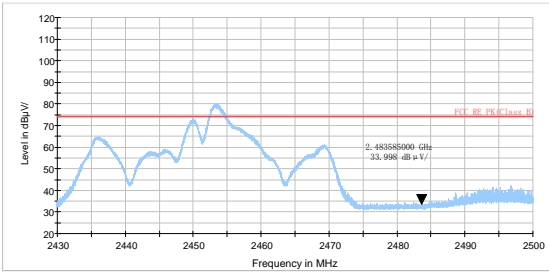

802.11n HT40 -Channel 9 Peak

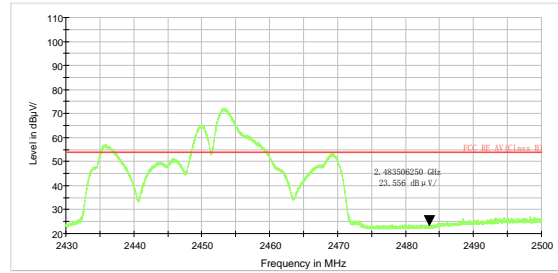

802.11n HT40 -Channel 9 Average



Result of RE

Test result

Sweep the whole frequency band through the range from 9kHz to the 10th harmonic of the carrier, the Emissions in the frequency band 9kHz-30MHz and 18GHz-26.5GHz are more than 20dB below the limit are not reported.

The following graphs display the maximum values of horizontal and vertical by software. For above 1GHz, Blue trace uses the peak detection, Green trace uses the average detection.

After the pretest, MIMO was selected as the worst antenna for 802.11g and 802.11n HT20/HT40. SISO Antenna 1 was selected as the worst SISO antenna for 802.11b.

During the test, the Radiates Emission from 30MHz to 1GHz was performed in all modes with all channels, 802.11g, Channel 6 are selected as the worst condition. The test data of the worst-case condition was recorded in this report.

Continuous TX mode:

FCC RE 9K-90KHz AV

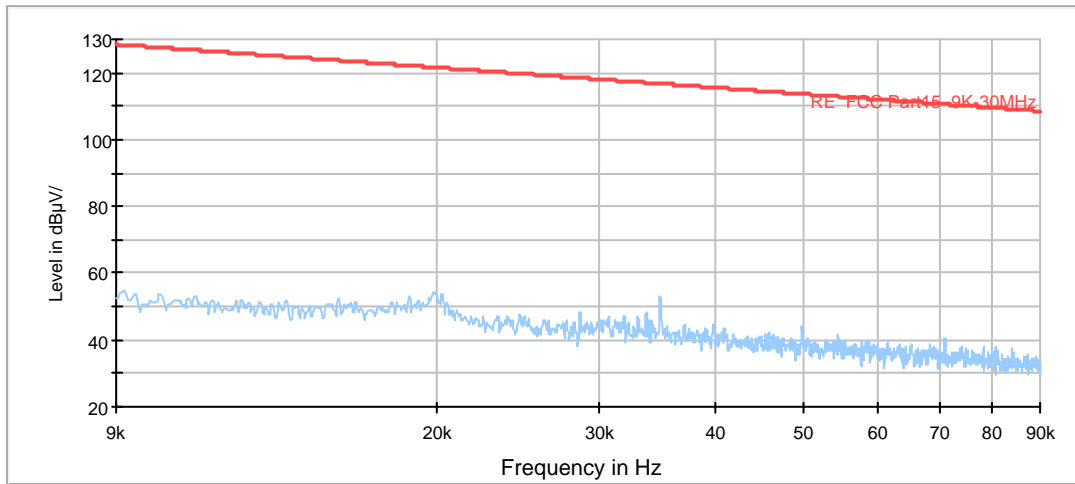

Radiates Emission from 9KHz to 90KHz

FCC RE 90K-110KHz QP

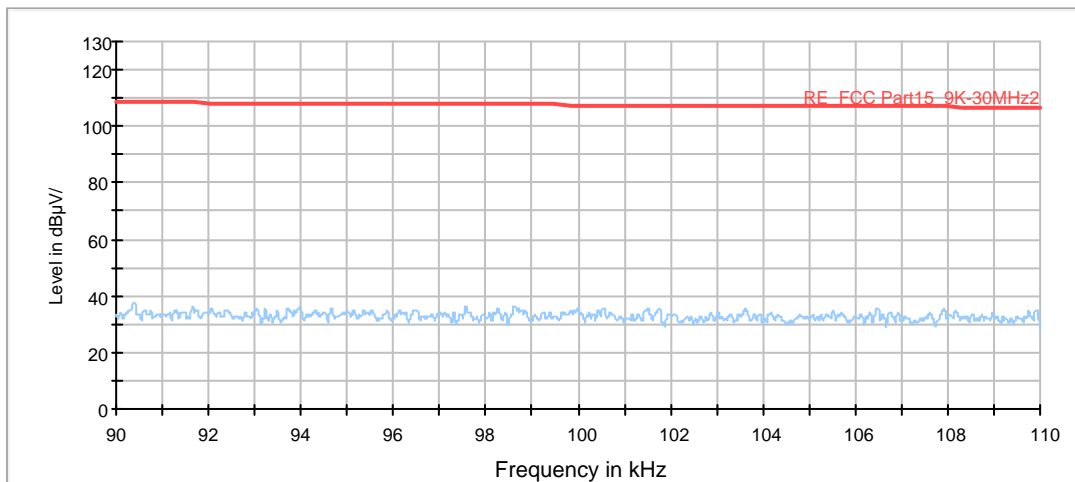

Radiates Emission from 90KHz to 110KHz

FCC RE 110K-490KHz AV

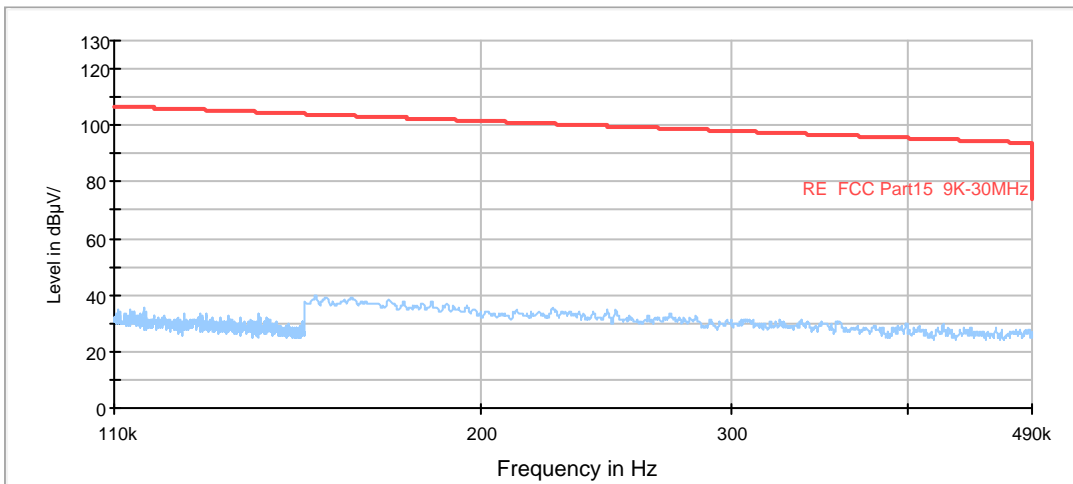

Radiates Emission from 110KHz to 490KHz

FCC RE 490K-30MHz QP

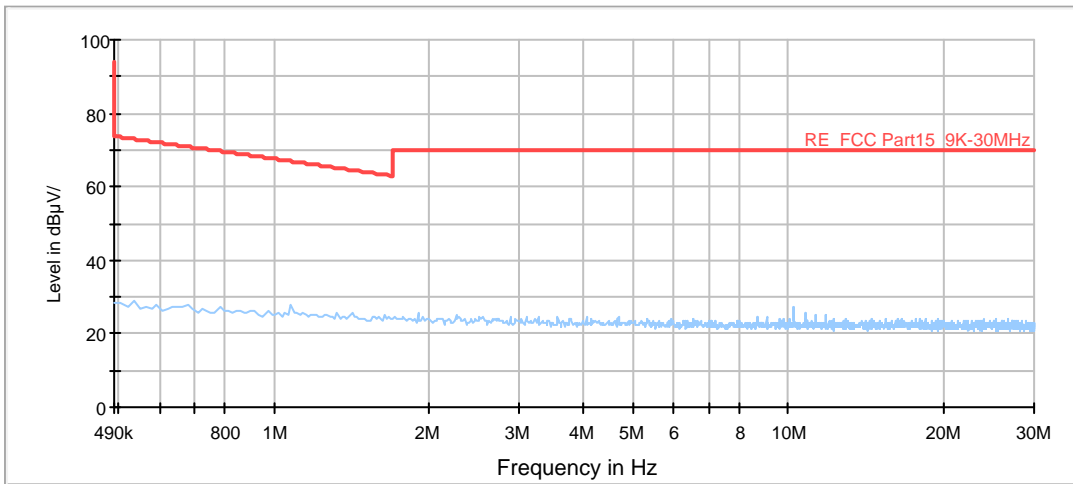

Radiates Emission from 490KHz to 30MHz

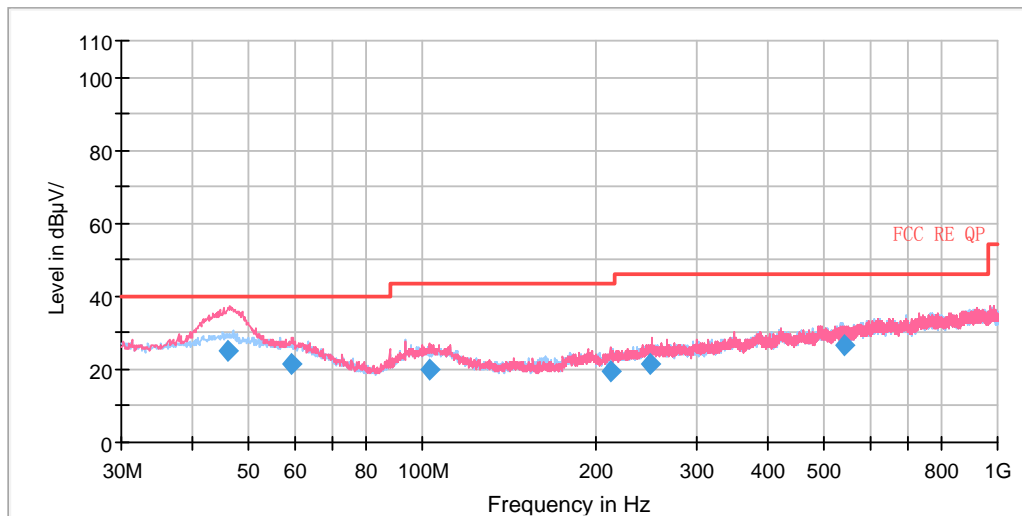

Radiates Emission from 30MHz to 1GHz

Frequency (MHz)	Quasi-Peak (dBuV/m)	Height (cm)	Polarization	Azimuth (deg)	Correct Factor (dB)	Margin (dB)	Limit (dBuV/m)
45.939150	25.02	100.0	V	294.0	-0.2	14.98	40.00
59.459650	21.36	123.0	V	265.0	-2.5	18.64	40.00
102.682150	19.97	110.0	V	76.0	-4.6	23.53	43.50
212.009600	19.26	210.0	V	209.0	-6.3	24.24	43.50
249.666050	21.46	175.0	V	105.0	-4.0	24.54	46.00
539.731050	26.63	109.0	H	2.0	1.4	19.37	46.00

Remark: 1. Correction Factor = Antenna factor+ Insertion loss(cable loss+amplifier gain)

2. Margin = Limit – Quasi-Peak

802.11b CH1

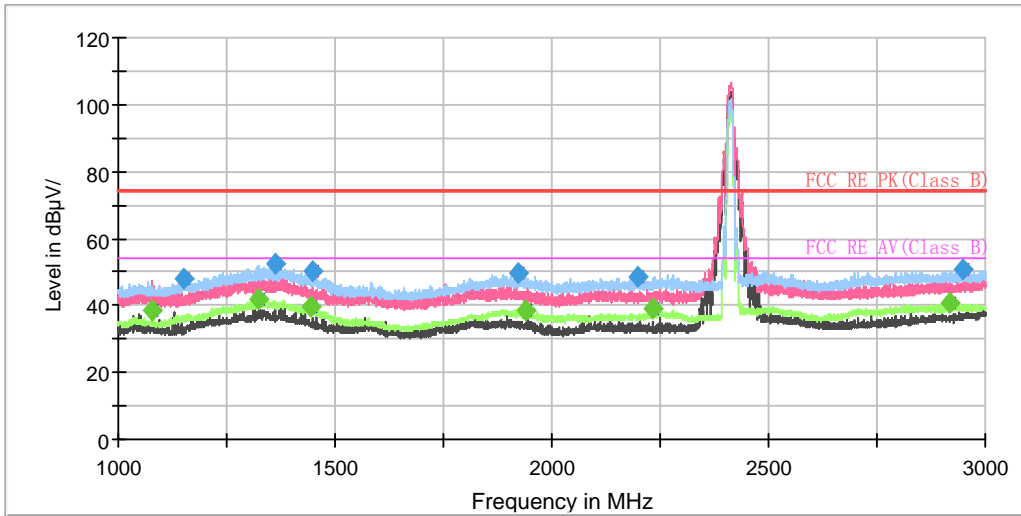

Note: The signal beyond the limit is carrier.
Radiates Emission from 1GHz to 3GHz

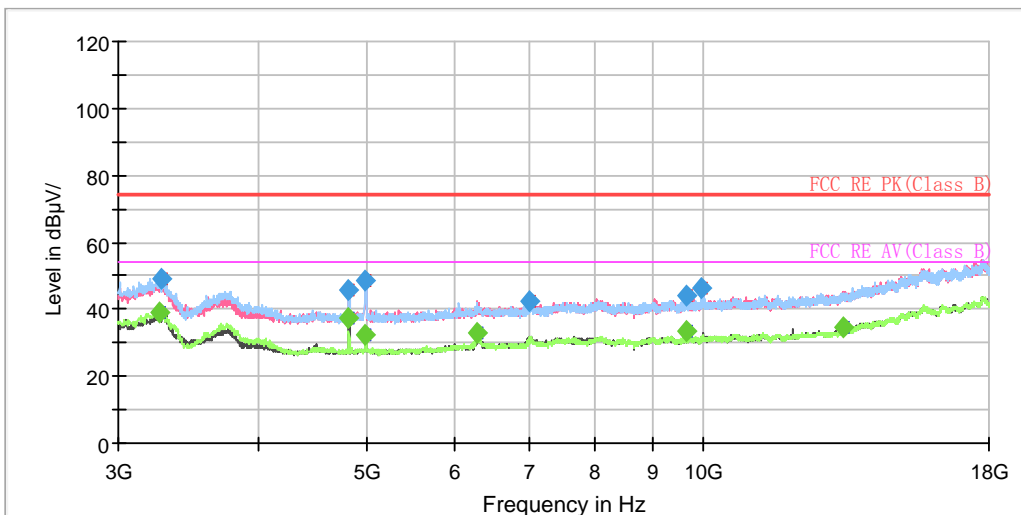

Radiates Emission from 3GHz to 18GHz



Frequency (MHz)	MaxPeak (dB μ V/m)	Average (dB μ V/m)	Limit (dB μ V/m)	Margin (dB)	Height (cm)	Pol	Azimuth (deg)	Corr. (dB)
1077.500000	---	38.54	54.00	15.46	200.0	V	152.0	-8.5
1149.750000	48.00	---	74.00	26.00	100.0	H	182.0	-8.1
1323.250000	---	41.63	54.00	12.37	200.0	H	62.0	-7.1
1361.750000	52.74	---	74.00	21.26	200.0	H	69.0	-6.9
1445.500000	---	39.44	54.00	14.56	200.0	H	62.0	-6.5
1447.000000	50.10	---	74.00	23.90	200.0	H	62.0	-6.5
1920.500000	49.80	---	74.00	24.20	100.0	H	351.0	-3.9
1940.000000	---	38.56	54.00	15.44	100.0	H	348.0	-3.8
2197.000000	48.64	---	74.00	25.37	100.0	H	288.0	-2.7
2233.500000	---	38.96	54.00	15.04	200.0	H	285.0	-2.6
2916.500000	---	40.49	54.00	13.51	100.0	H	288.0	0.6
2947.000000	50.97	---	74.00	23.03	100.0	H	288.0	0.9

Remark: 1. Correction Factor = Antenna factor+ Insertion loss (cable loss + amplifier gain)

802.11b CH6

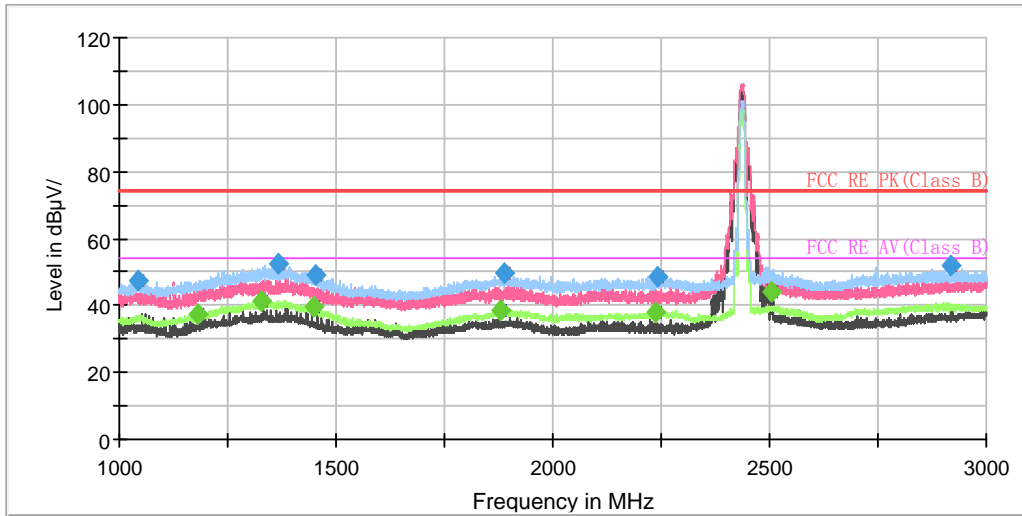

Note: The signal beyond the limit is carrier.
Radiates Emission from 1GHz to 3GHz

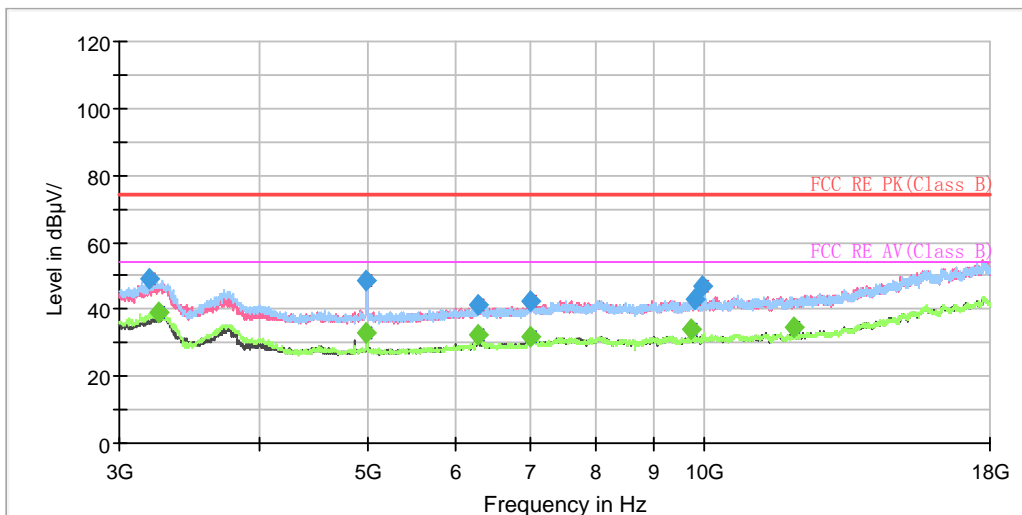

Radiates Emission from 3GHz to 18GHz



Frequency (MHz)	MaxPeak (dB μ V/m)	Average (dB μ V/m)	Limit (dB μ V/m)	Margin (dB)	Height (cm)	Pol	Azimuth (deg)	Corr. (dB)
1042.750000	47.57	---	74.00	26.43	200.0	H	305.0	-8.6
1179.750000	---	37.51	54.00	16.49	100.0	H	185.0	-7.9
1326.500000	---	41.56	54.00	12.44	200.0	H	62.0	-7.1
1367.750000	52.32	---	74.00	21.68	200.0	H	69.0	-6.9
1449.750000	---	39.59	54.00	14.41	200.0	H	62.0	-6.4
1451.250000	49.25	---	74.00	24.75	200.0	H	62.0	-6.4
1878.500000	---	38.56	54.00	15.44	100.0	H	347.0	-4.1
1889.250000	49.42	---	74.00	24.58	100.0	H	343.0	-4.0
2236.750000	---	38.21	54.00	15.79	200.0	H	284.0	-2.5
2243.250000	48.48	---	74.00	25.52	100.0	H	291.0	-2.5
2502.250000	---	43.91	54.00	10.09	200.0	V	151.0	-1.4
2918.750000	51.66	---	74.00	22.34	100.0	H	291.0	0.6

Remark: 1. Correction Factor = Antenna factor+ Insertion loss (cable loss + amplifier gain)

802.11b CH11

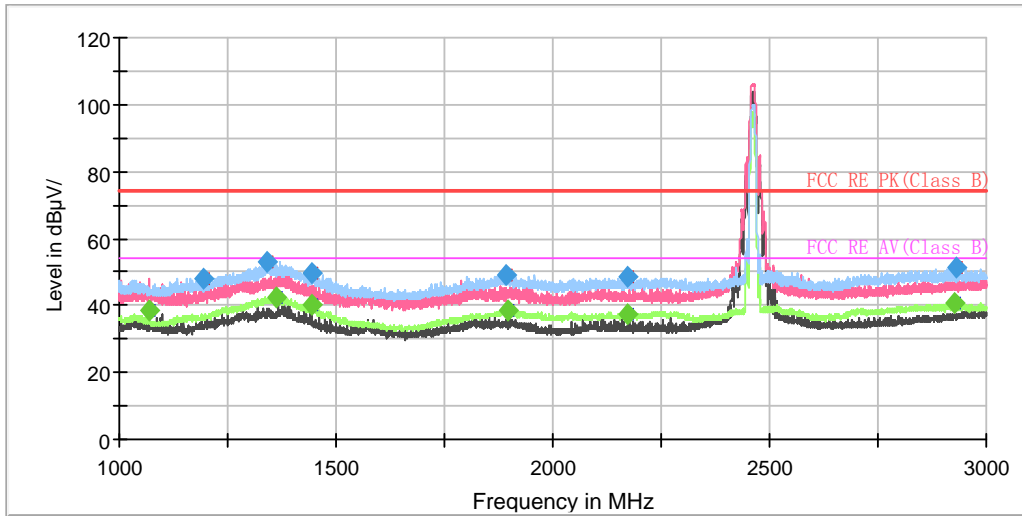

Note: The signal beyond the limit is carrier.
Radiates Emission from 1GHz to 3GHz

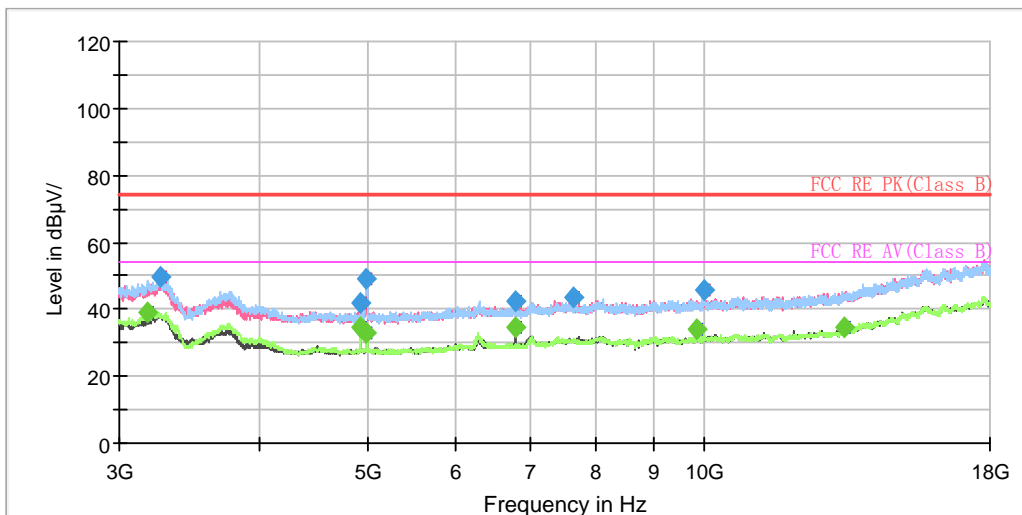

Radiates Emission from 3GHz to 18GHz



Frequency (MHz)	MaxPeak (dB μ V/m)	Average (dB μ V/m)	Limit (dB μ V/m)	Margin (dB)	Height (cm)	Pol	Azimuth (deg)	Corr. (dB)
1070.000000	---	38.25	54.00	15.75	200.0	V	148.0	-8.5
1193.750000	48.00	---	74.00	26.00	200.0	H	61.0	-7.8
1341.500000	53.27	---	74.00	20.73	200.0	H	61.0	-7.0
1360.000000	---	42.62	54.00	11.38	200.0	H	69.0	-6.9
1442.250000	---	39.98	54.00	14.02	200.0	H	61.0	-6.5
1443.500000	49.63	---	74.00	24.37	200.0	H	61.0	-6.5
1893.750000	49.39	---	74.00	24.61	100.0	H	343.0	-4.0
1896.500000	---	38.57	54.00	15.43	100.0	H	4.0	-3.9
2171.250000	---	37.51	54.00	16.49	100.0	H	289.0	-2.7
2171.250000	48.50	---	74.00	25.50	100.0	H	289.0	-2.7
2924.750000	---	40.70	54.00	13.30	100.0	H	289.0	0.7
2929.000000	51.32	---	74.00	22.68	100.0	H	289.0	0.7

Remark: 1. Correction Factor = Antenna factor+ Insertion loss (cable loss + amplifier gain)

802.11g CH1

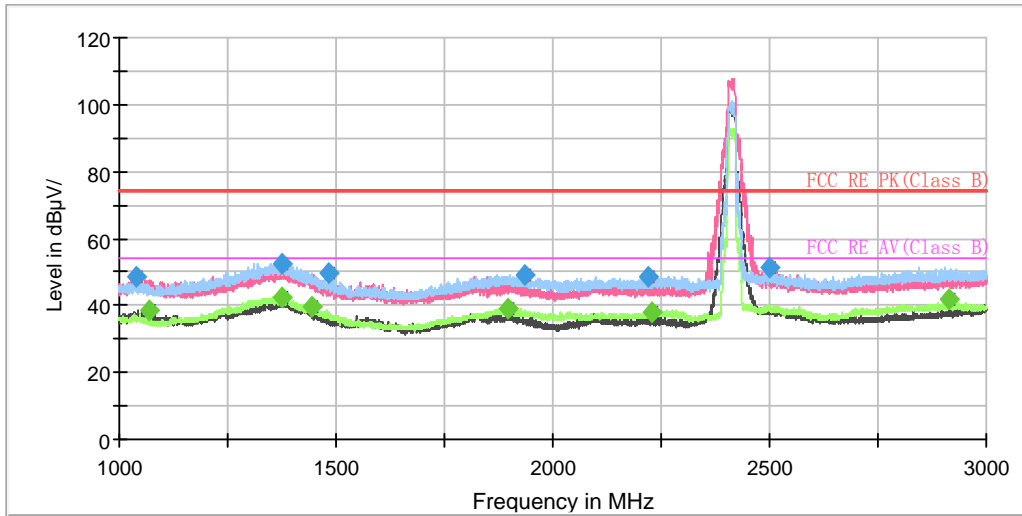

Note: The signal beyond the limit is carrier.
Radiates Emission from 1GHz to 3GHz

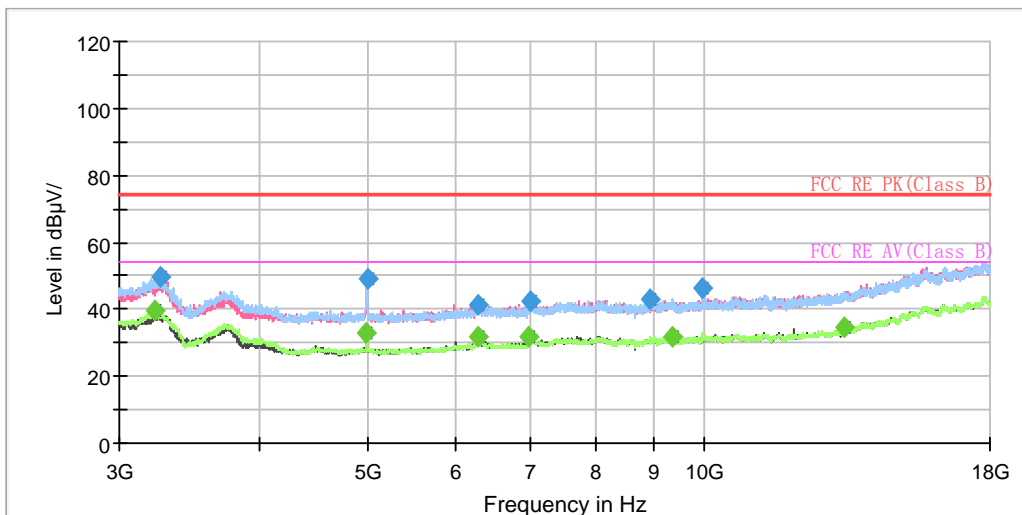

Radiates Emission from 3GHz to 18GHz



Frequency (MHz)	MaxPeak (dB μ V/m)	Average (dB μ V/m)	Limit (dB μ V/m)	Margin (dB)	Height (cm)	Pol	Azimuth (deg)	Corr. (dB)
1039.750000	48.38	---	74.00	25.62	200.0	V	125.0	-8.6
1068.750000	---	38.42	54.00	15.58	200.0	V	149.0	-8.5
1373.250000	---	42.57	54.00	11.43	200.0	H	72.0	-6.9
1374.250000	52.67	---	74.00	21.33	200.0	H	72.0	-6.9
1442.750000	---	39.69	54.00	14.31	200.0	H	65.0	-6.5
1483.250000	49.77	---	74.00	24.24	200.0	H	72.0	-6.2
1895.750000	---	39.08	54.00	14.92	100.0	H	344.0	-3.9
1933.500000	49.34	---	74.00	24.66	100.0	H	344.0	-3.8
2220.250000	48.71	---	74.00	25.29	100.0	H	302.0	-2.6
2229.250000	---	38.06	54.00	15.94	100.0	H	302.0	-2.6
2498.500000	51.37	---	74.00	22.63	200.0	H	171.0	-1.5
2912.500000	---	41.66	54.00	12.34	100.0	H	280.0	0.6

Remark: 1. Correction Factor = Antenna factor+ Insertion loss (cable loss + amplifier gain)

802.11g CH2

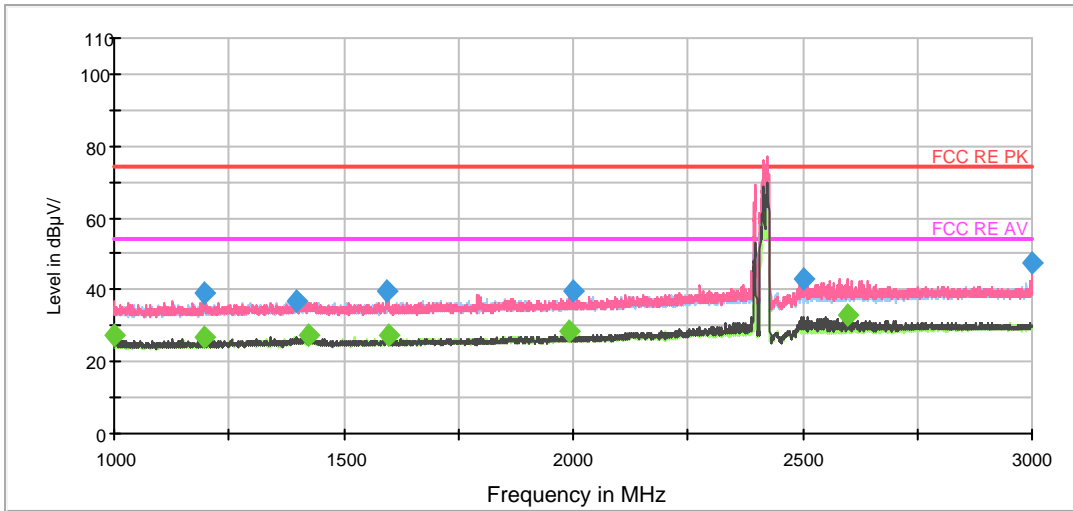

Note: The signal beyond the limit is carrier.
Radiates Emission from 1GHz to 3GHz

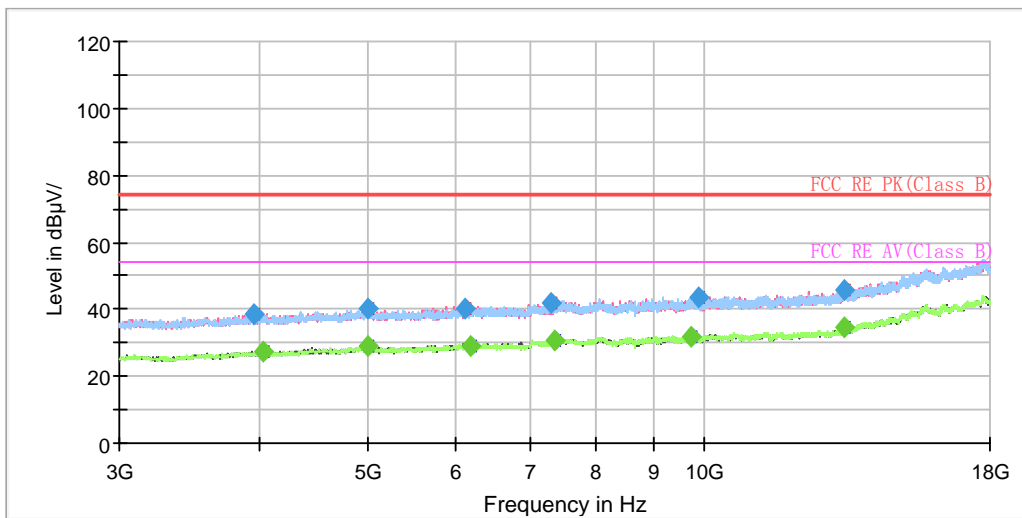

Radiates Emission from 3GHz to 18GHz



Frequency (MHz)	Peak (dBuV/m)	Height (cm)	Polarization	Azimuth (deg)	Correct Factor (dB)	Margin (dB)	Limit (dBuV/m)
1198.500000	39.1	200.0	V	180.0	-11.2	34.9	74.0
1397.750000	36.8	100.0	V	180.0	-10.7	37.2	74.0
1593.750000	39.6	200.0	V	146.0	-10.1	34.4	74.0
1999.750000	39.6	200.0	V	128.0	-8.9	34.4	74.0
2503.500000	43.0	200.0	V	198.0	-6.4	31.0	74.0
2999.750000	47.4	100.0	V	12.0	-5.2	26.6	74.0

Remark: 1. Correction Factor = Antenna factor+ Insertion loss (cable loss + amplifier gain)

Frequency (MHz)	Average (dBuV/m)	Height (cm)	Polarization	Azimuth (deg)	Correct Factor (dB)	Margin (dB)	Limit (dBuV/m)
1000.000000	27.1	200.0	H	115.0	-12.0	26.9	54.0
1197.000000	26.6	100.0	V	42.0	-11.2	27.4	54.0
1424.500000	27.1	100.0	V	147.0	-10.6	26.9	54.0
1599.500000	27.6	100.0	V	67.0	-10.0	26.4	54.0
1991.250000	28.2	100.0	V	232.0	-8.9	25.8	54.0
2599.250000	33.0	200.0	V	198.0	-6.2	21.0	54.0

Remark: 1. Correction Factor = Antenna factor+ Insertion loss (cable loss + amplifier gain)

802.11g CH3

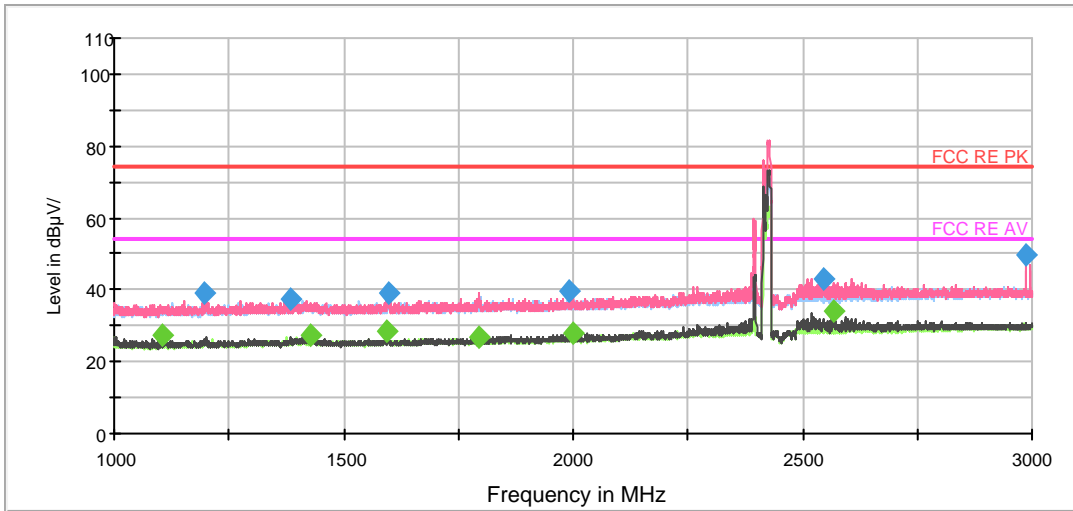

Note: The signal beyond the limit is carrier.
Radiates Emission from 1GHz to 3GHz

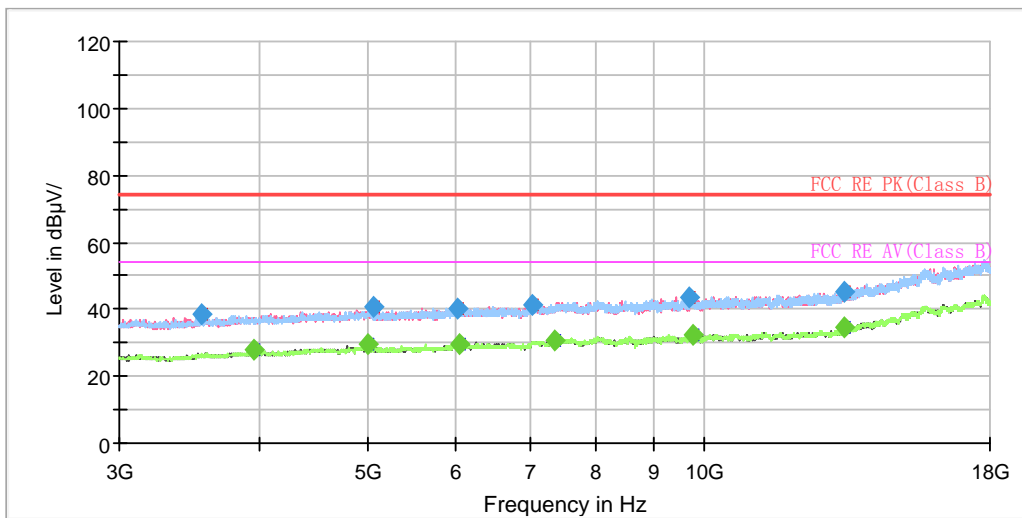

Radiates Emission from 3GHz to 18GHz



Frequency (MHz)	Peak (dBuV/m)	Height (cm)	Polarization	Azimuth (deg)	Correct Factor (dB)	Margin (dB)	Limit (dBuV/m)
1198.000000	39.0	200.0	V	92.0	-11.2	35.0	74.0
1385.250000	37.4	200.0	V	181.0	-10.7	36.6	74.0
1597.750000	39.3	200.0	V	163.0	-10.0	34.7	74.0
1992.500000	39.7	200.0	V	163.0	-8.9	34.3	74.0
2547.250000	43.2	200.0	V	198.0	-6.3	30.8	74.0
2988.750000	49.7	100.0	V	24.0	-5.3	24.3	74.0

Remark: 1. Correction Factor = Antenna factor+ Insertion loss (cable loss + amplifier gain)

Frequency (MHz)	Average (dBuV/m)	Height (cm)	Polarization	Azimuth (deg)	Correct Factor (dB)	Margin (dB)	Limit (dBuV/m)
1105.750000	27.2	100.0	V	112.0	-11.4	26.8	54.0
1429.750000	27.1	200.0	H	130.0	-10.6	26.9	54.0
1593.500000	28.5	200.0	V	146.0	-10.1	25.5	54.0
1794.500000	26.7	200.0	V	128.0	-9.4	27.3	54.0
1998.000000	27.8	200.0	V	128.0	-8.9	26.2	54.0
2568.750000	33.8	200.0	V	181.0	-6.3	20.2	54.0

Remark: 1. Correction Factor = Antenna factor+ Insertion loss (cable loss + amplifier gain)



802.11g CH6

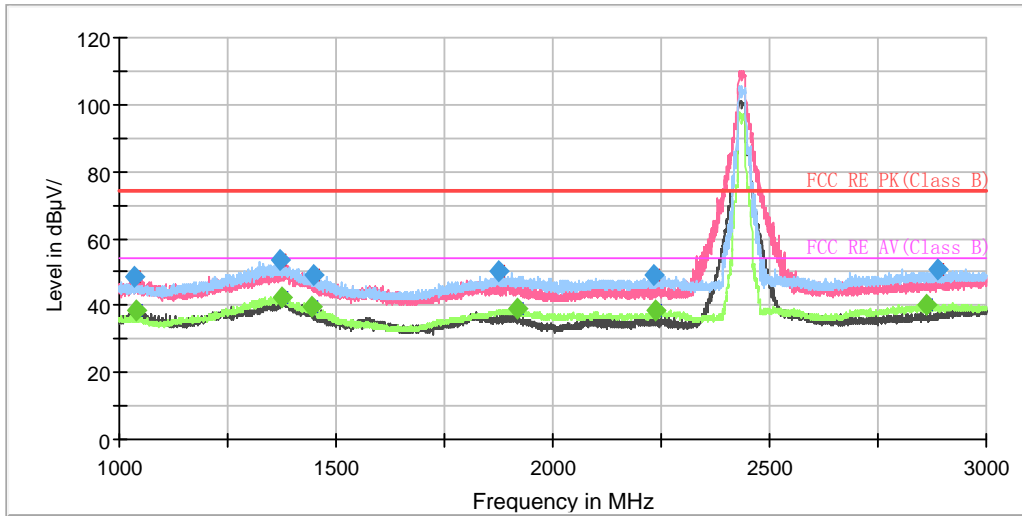

Note: The signal beyond the limit is carrier.
Radiates Emission from 1GHz to 3GHz

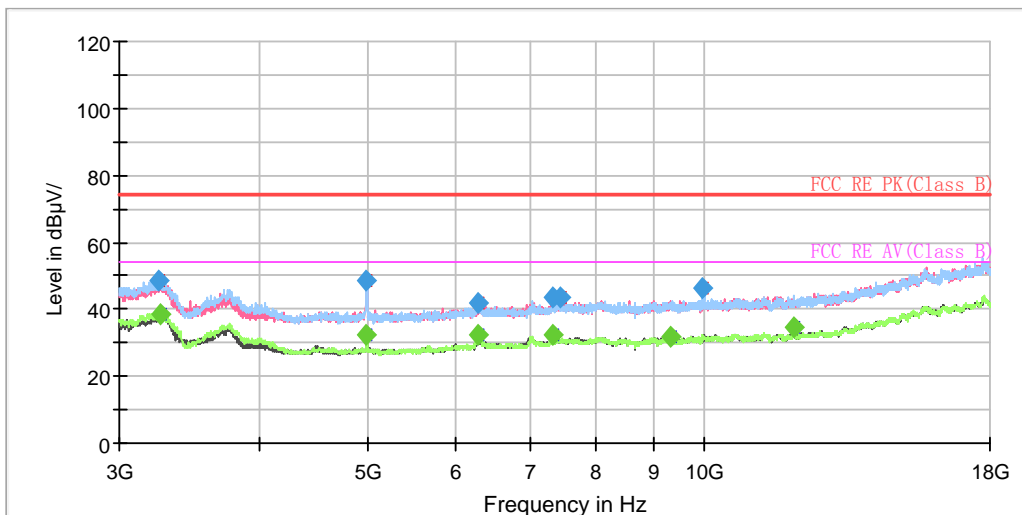

Radiates Emission from 3GHz to 18GHz



Frequency (MHz)	MaxPeak (dB μ V/m)	Average (dB μ V/m)	Limit (dB μ V/m)	Margin (dB)	Height (cm)	Pol	Azimuth (deg)	Corr. (dB)
1032.500000	48.41	---	74.00	25.59	200.0	V	131.0	-8.7
1040.750000	---	38.66	54.00	15.34	200.0	V	131.0	-8.6
1371.750000	53.74	---	74.00	20.26	200.0	H	65.0	-6.9
1373.750000	---	42.45	54.00	11.55	200.0	H	71.0	-6.9
1445.500000	---	39.40	54.00	14.60	200.0	H	59.0	-6.5
1450.250000	48.89	---	74.00	25.11	200.0	H	65.0	-6.4
1874.500000	50.01	---	74.00	23.99	100.0	H	346.0	-4.1
1916.750000	---	39.13	54.00	14.87	100.0	H	346.0	-3.9
2231.500000	49.04	---	74.00	24.96	200.0	H	287.0	-2.6
2235.250000	---	38.51	54.00	15.49	100.0	H	291.0	-2.6
2863.000000	---	40.43	54.00	13.57	100.0	H	291.0	0.5
2887.250000	50.92	---	74.00	23.08	100.0	H	291.0	0.5

Remark: 1. Correction Factor = Antenna factor+ Insertion loss (cable loss + amplifier gain)

802.11g CH9

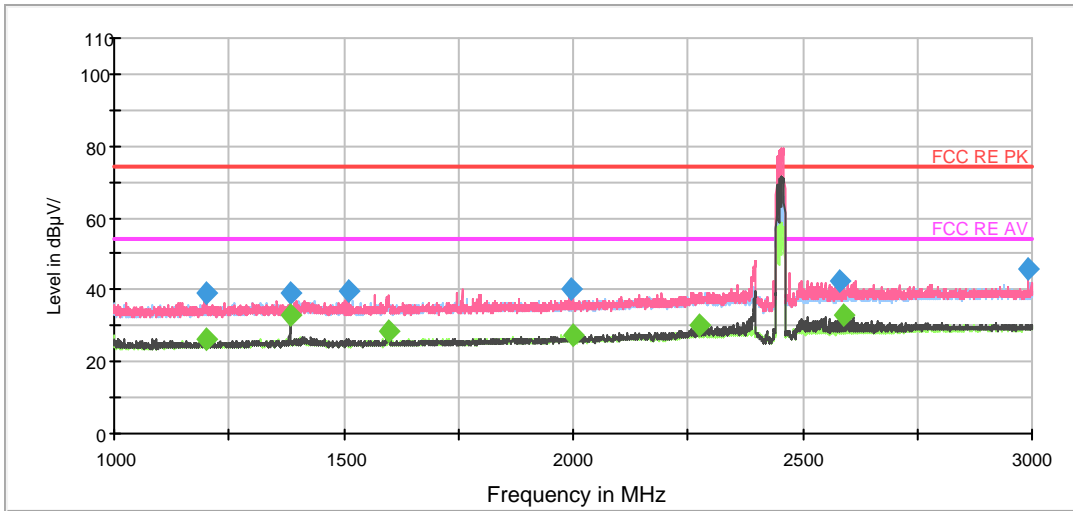

Note: The signal beyond the limit is carrier.
Radiates Emission from 1GHz to 3GHz

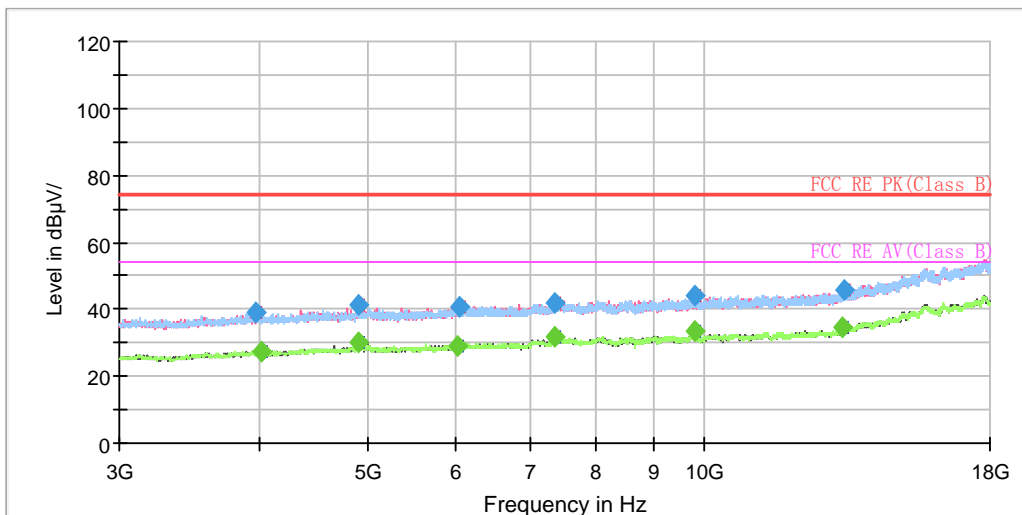

Radiates Emission from 3GHz to 18GHz



Frequency (MHz)	Peak (dBuV/m)	Height (cm)	Polarization	Azimuth (deg)	Correct Factor (dB)	Margin (dB)	Limit (dBuV/m)
1199.750000	39.3	100.0	V	32.0	-11.2	34.7	74.0
1382.750000	39.3	200.0	V	165.0	-10.7	34.7	74.0
1509.000000	39.5	200.0	V	182.0	-10.4	34.5	74.0
1996.750000	40.2	200.0	V	182.0	-8.9	33.8	74.0
2579.250000	42.5	200.0	V	182.0	-6.2	31.5	74.0
2990.500000	45.5	200.0	V	347.0	-5.2	28.5	74.0

Remark: 1. Correction Factor = Antenna factor+ Insertion loss (cable loss + amplifier gain)

Frequency (MHz)	Average (dBuV/m)	Height (cm)	Polarization	Azimuth (deg)	Correct Factor (dB)	Margin (dB)	Limit (dBuV/m)
1199.750000	26.3	100.0	V	32.0	-11.2	27.7	54.0
1382.750000	33.0	200.0	V	165.0	-10.7	21.0	54.0
1598.750000	28.2	200.0	V	147.0	-10.0	25.8	54.0
1999.500000	27.3	100.0	V	14.0	-8.9	26.7	54.0
2274.000000	30.1	100.0	V	79.0	-7.3	23.9	54.0
2589.750000	33.2	200.0	V	182.0	-6.2	20.8	54.0

Remark: 1. Correction Factor = Antenna factor+ Insertion loss (cable loss + amplifier gain)

802.11g CH10

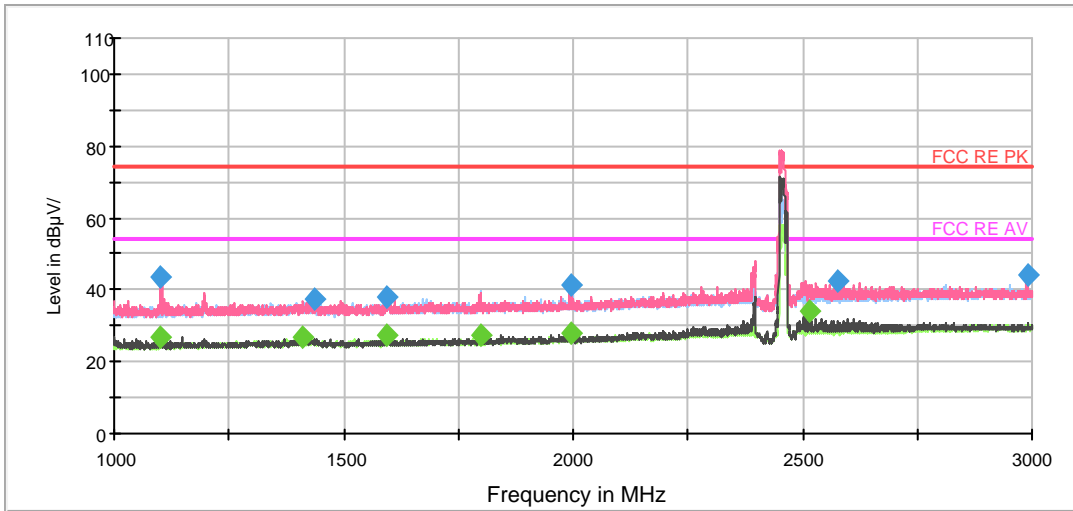

Note: The signal beyond the limit is carrier.
Radiates Emission from 1GHz to 3GHz

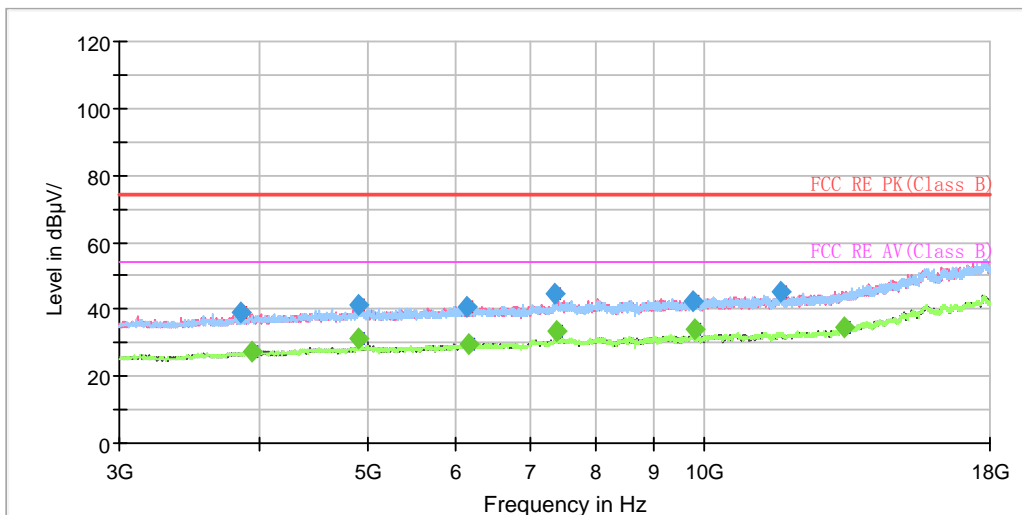

Radiates Emission from 3GHz to 18GHz



Frequency (MHz)	Peak (dBuV/m)	Height (cm)	Polarization	Azimuth (deg)	Correct Factor (dB)	Margin (dB)	Limit (dBuV/m)
1099.500000	43.7	100.0	V	95.0	-11.4	30.3	74.0
1437.250000	37.4	200.0	H	66.0	-10.6	36.6	74.0
1593.750000	38.1	100.0	V	358.0	-10.1	35.9	74.0
1996.000000	41.4	100.0	V	128.0	-8.9	32.6	74.0
2578.250000	42.4	200.0	V	182.0	-6.2	31.6	74.0
2990.500000	43.9	100.0	V	4.0	-5.2	30.1	74.0

Remark: 1. Correction Factor = Antenna factor+ Insertion loss (cable loss + amplifier gain)

Frequency (MHz)	Average (dBuV/m)	Height (cm)	Polarization	Azimuth (deg)	Correct Factor (dB)	Margin (dB)	Limit (dBuV/m)
1099.500000	27.0	100.0	V	95.0	-11.4	27.0	54.0
1412.500000	27.0	200.0	V	281.0	-10.7	27.0	54.0
1594.250000	27.1	200.0	V	0.0	-10.1	26.9	54.0
1798.500000	27.1	100.0	V	0.0	-9.4	26.9	54.0
1996.000000	28.1	100.0	V	128.0	-8.9	25.9	54.0
2514.750000	34.0	200.0	V	165.0	-6.4	20.0	54.0

Remark: 1. Correction Factor = Antenna factor+ Insertion loss (cable loss + amplifier gain)

802.11g CH11

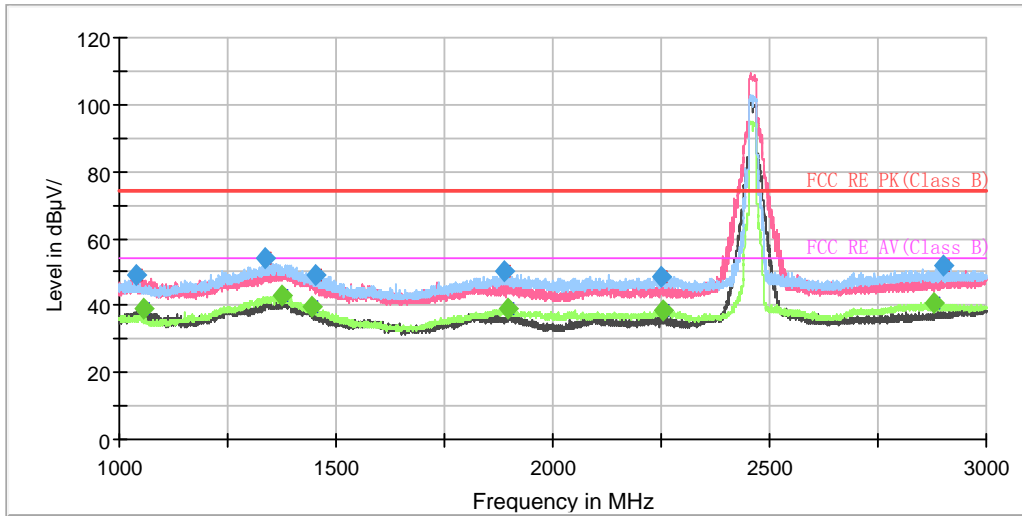

Note: The signal beyond the limit is carrier.
Radiates Emission from 1GHz to 3GHz

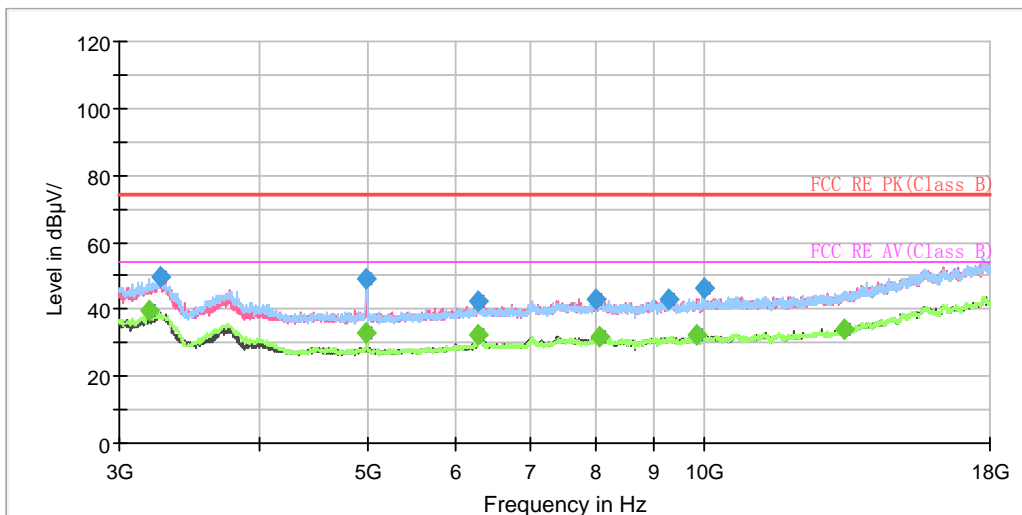

Radiates Emission from 3GHz to 18GHz



Frequency (MHz)	MaxPeak (dB μ V/m)	Average (dB μ V/m)	Limit (dB μ V/m)	Margin (dB)	Height (cm)	Pol	Azimuth (deg)	Corr. (dB)
1040.000000	49.17	---	74.00	24.83	200.0	V	142.0	-8.6
1057.000000	---	38.80	54.00	15.20	200.0	V	142.0	-8.5
1336.250000	54.39	---	74.00	19.61	200.0	H	71.0	-7.0
1375.500000	---	42.92	54.00	11.08	200.0	H	71.0	-6.8
1443.000000	---	39.43	54.00	14.57	200.0	H	71.0	-6.5
1453.250000	48.87	---	74.00	25.13	100.0	H	297.0	-6.4
1889.250000	49.98	---	74.00	24.02	100.0	H	341.0	-4.0
1897.750000	---	39.21	54.00	14.79	100.0	H	348.0	-3.9
2249.500000	48.46	---	74.00	25.54	200.0	H	301.0	-2.4
2253.250000	---	38.52	54.00	15.48	100.0	H	297.0	-2.4
2878.500000	---	40.62	54.00	13.38	100.0	H	283.0	0.5
2902.750000	52.02	---	74.00	21.98	100.0	H	283.0	0.5

Remark: 1. Correction Factor = Antenna factor+ Insertion loss (cable loss + amplifier gain)

802.11n (HT20) CH1

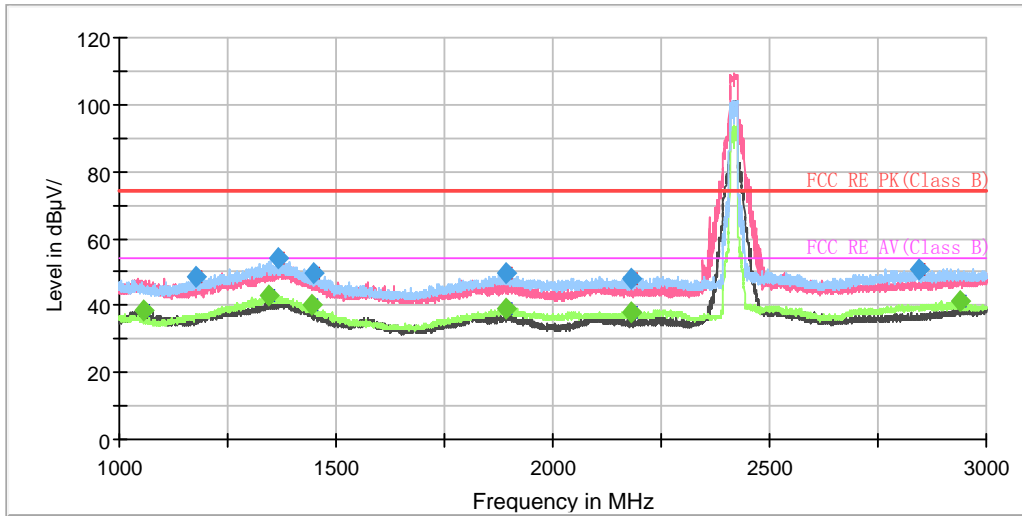

Note: The signal beyond the limit is carrier.
Radiates Emission from 1GHz to 3GHz

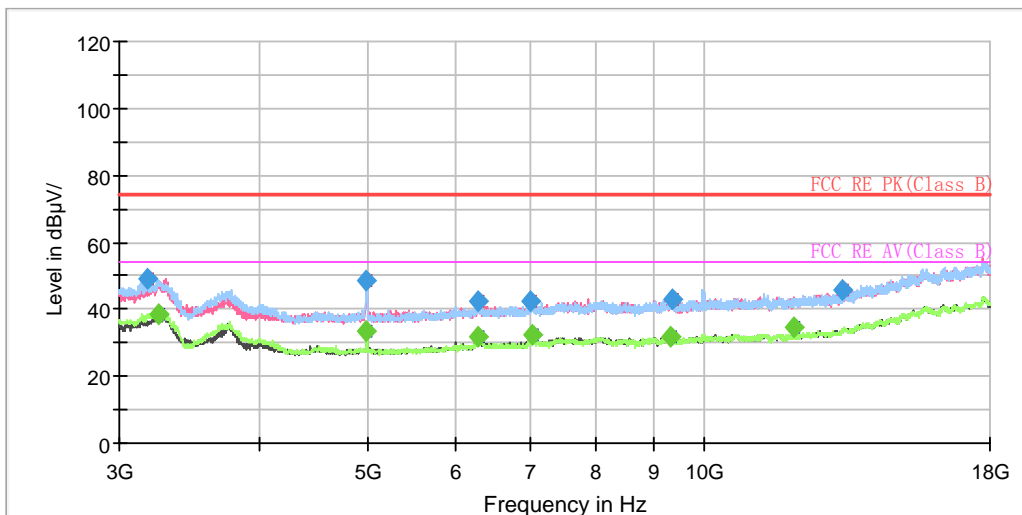

Radiates Emission from 3GHz to 18GHz



Frequency (MHz)	MaxPeak (dB μ V/m)	Average (dB μ V/m)	Limit (dB μ V/m)	Margin (dB)	Height (cm)	Pol	Azimuth (deg)	Corr. (dB)
1054.250000	---	38.75	54.00	15.25	200.0	V	145.0	-8.5
1177.000000	48.35	---	74.00	25.65	100.0	H	180.0	-7.9
1346.000000	---	42.82	54.00	11.18	200.0	H	71.0	-7.0
1365.750000	53.88	---	74.00	20.12	200.0	H	71.0	-6.9
1444.250000	---	39.99	54.00	14.01	200.0	H	64.0	-6.5
1447.000000	49.55	---	74.00	24.45	200.0	H	64.0	-6.5
1891.000000	49.52	---	74.00	24.48	100.0	H	346.0	-4.0
1891.750000	---	39.06	54.00	14.94	100.0	H	338.0	-4.0
2179.500000	---	38.16	54.00	15.84	100.0	H	303.0	-2.7
2179.500000	48.18	---	74.00	25.82	100.0	H	303.0	-2.7
2843.500000	51.04	---	74.00	22.96	200.0	H	344.0	0.3
2940.500000	---	41.07	54.00	12.93	100.0	H	281.0	0.8

Remark: 1. Correction Factor = Antenna factor+ Insertion loss (cable loss + amplifier gain)

802.11n (HT20) CH2

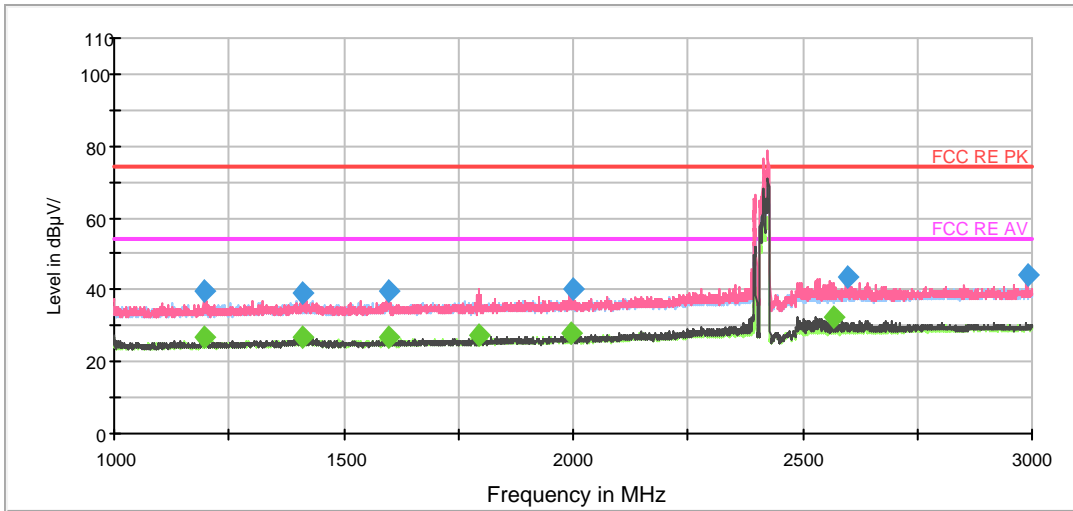

Note: The signal beyond the limit is carrier.
Radiates Emission from 1GHz to 3GHz

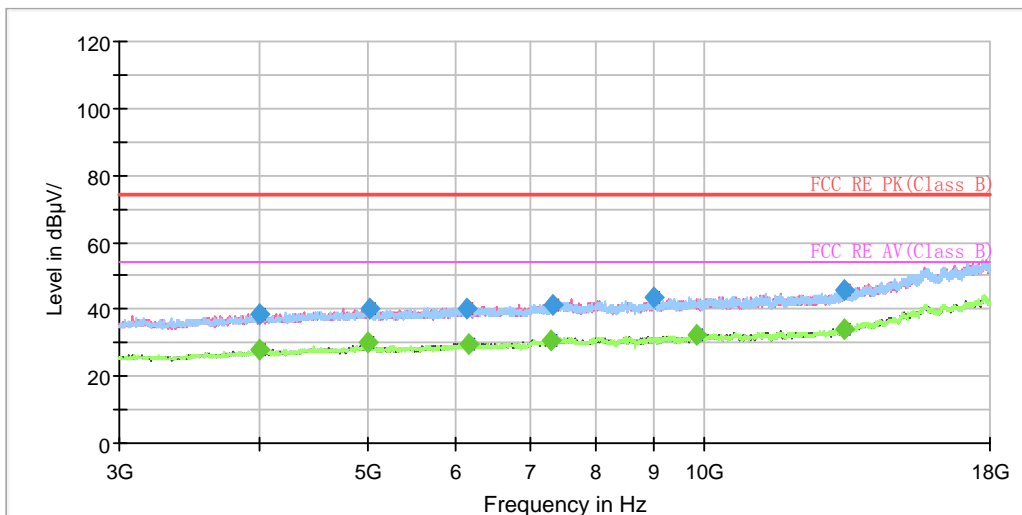

Radiates Emission from 3GHz to 18GHz



Frequency (MHz)	Peak (dBuV/m)	Height (cm)	Polarization	Azimuth (deg)	Correct Factor (dB)	Margin (dB)	Limit (dBuV/m)
1195.500000	39.4	200.0	V	169.0	-11.2	34.6	74.0
1412.500000	39.1	200.0	V	186.0	-10.7	34.9	74.0
1596.750000	39.8	200.0	V	133.0	-10.0	34.2	74.0
2000.000000	40.3	200.0	V	115.0	-8.9	33.7	74.0
2596.250000	43.5	200.0	V	186.0	-6.2	30.5	74.0
2992.250000	44.0	200.0	V	353.0	-5.2	30.0	74.0

Remark: 1. Correction Factor = Antenna factor+ Insertion loss (cable loss + amplifier gain)

Frequency (MHz)	Average (dBuV/m)	Height (cm)	Polarization	Azimuth (deg)	Correct Factor (dB)	Margin (dB)	Limit (dBuV/m)
1198.250000	26.6	200.0	V	115.0	-11.2	27.4	54.0
1412.500000	26.6	200.0	V	186.0	-10.7	27.4	54.0
1599.750000	26.9	200.0	V	133.0	-10.0	27.1	54.0
1794.000000	27.5	100.0	V	3.0	-9.4	26.5	54.0
1993.500000	27.9	100.0	V	278.0	-8.9	26.1	54.0
2567.500000	32.3	200.0	V	186.0	-6.3	21.7	54.0

Remark: 1. Correction Factor = Antenna factor+ Insertion loss (cable loss + amplifier gain)

802.11n (HT20) CH3

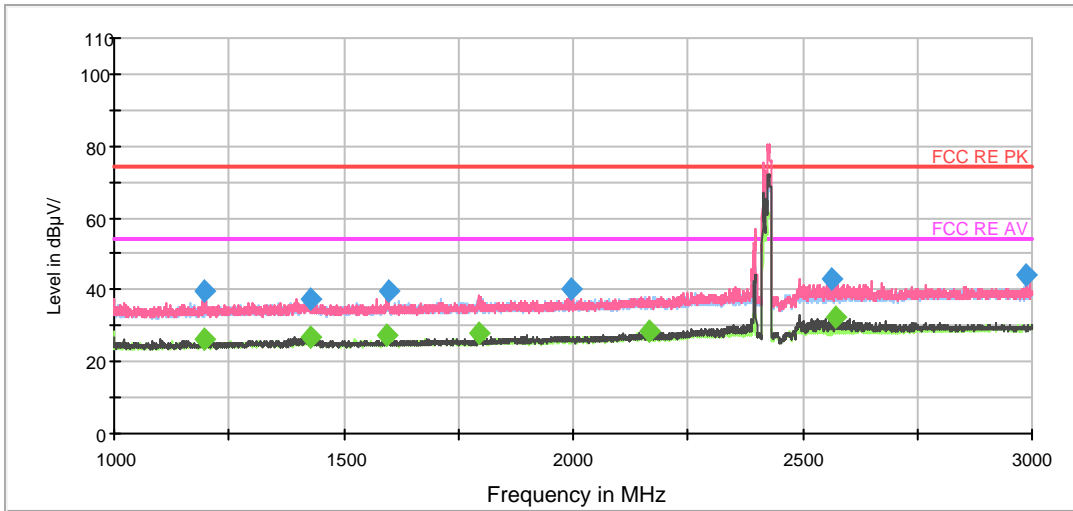

Note: The signal beyond the limit is carrier.
Radiates Emission from 1GHz to 3GHz

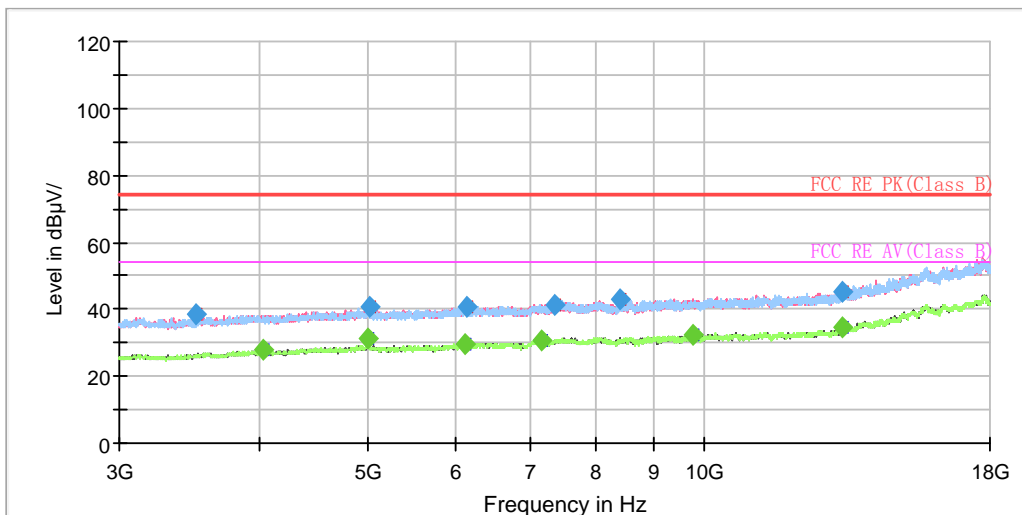

Radiates Emission from 3GHz to 18GHz



Frequency (MHz)	Peak (dBuV/m)	Height (cm)	Polarization	Azimuth (deg)	Correct Factor (dB)	Margin (dB)	Limit (dBuV/m)
1194.750000	39.6	200.0	V	185.0	-11.2	34.4	74.0
1426.500000	37.5	200.0	H	3.0	-10.6	36.5	74.0
1598.250000	39.4	200.0	V	167.0	-10.0	34.6	74.0
1997.750000	40.0	200.0	V	114.0	-8.9	34.0	74.0
2561.250000	42.8	200.0	V	185.0	-6.3	31.2	74.0
2989.000000	44.2	200.0	V	358.0	-5.3	29.8	74.0

Remark: 1. Correction Factor = Antenna factor+ Insertion loss (cable loss + amplifier gain)

Frequency (MHz)	Average (dBuV/m)	Height (cm)	Polarization	Azimuth (deg)	Correct Factor (dB)	Margin (dB)	Limit (dBuV/m)
1197.750000	26.3	200.0	V	235.0	-11.2	27.7	54.0
1426.750000	26.7	100.0	V	195.0	-10.6	27.3	54.0
1594.500000	27.2	200.0	V	359.0	-10.1	26.8	54.0
1792.750000	27.8	200.0	V	77.0	-9.4	26.2	54.0
2167.000000	28.7	200.0	V	132.0	-7.9	25.3	54.0
2574.000000	32.2	100.0	V	195.0	-6.2	21.8	54.0

Remark: 1. Correction Factor = Antenna factor+ Insertion loss (cable loss + amplifier gain)



802.11n (HT20) CH6

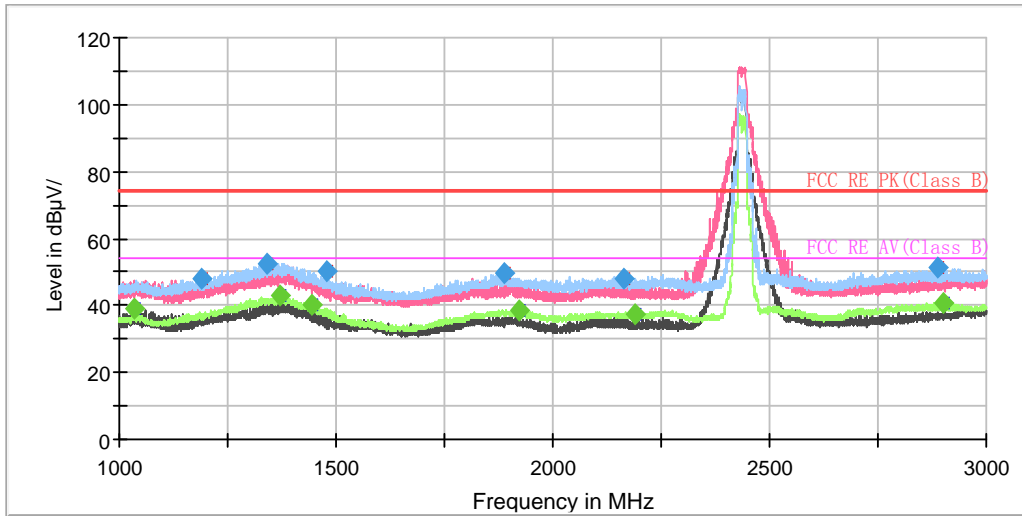

Note: The signal beyond the limit is carrier.
Radiates Emission from 1GHz to 3GHz

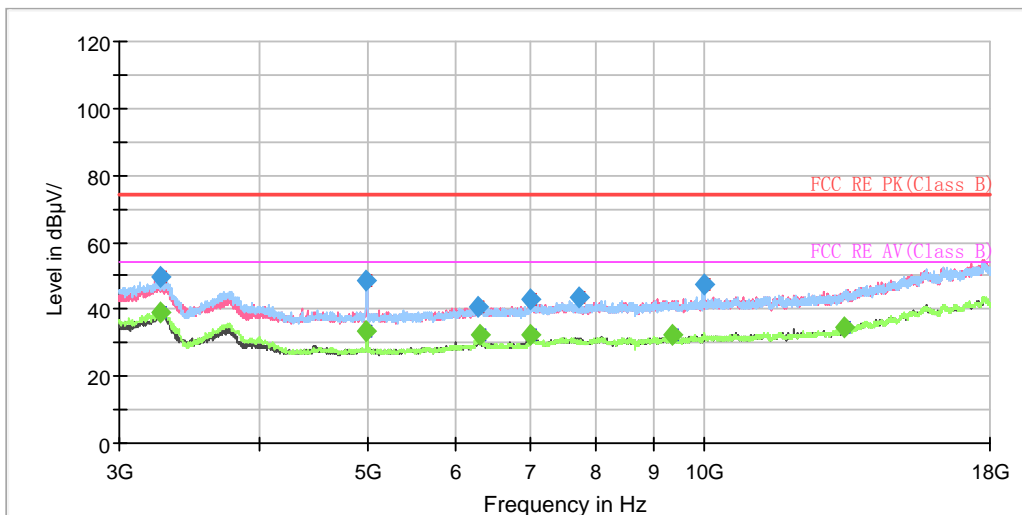

Radiates Emission from 3GHz to 18GHz



Frequency (MHz)	MaxPeak (dB μ V/m)	Average (dB μ V/m)	Limit (dB μ V/m)	Margin (dB)	Height (cm)	Pol	Azimuth (deg)	Corr. (dB)
1035.250000	---	39.35	54.00	14.65	200.0	V	133.0	-8.6
1189.500000	47.83	---	74.00	26.17	200.0	H	62.0	-7.8
1339.250000	52.62	---	74.00	21.38	200.0	V	133.0	-7.0
1370.750000	---	43.10	54.00	10.90	200.0	H	70.0	-6.9
1443.250000	---	40.01	54.00	13.99	200.0	H	62.0	-6.5
1476.500000	50.34	---	74.00	23.66	200.0	H	70.0	-6.3
1887.750000	49.60	---	74.00	24.40	200.0	H	353.0	-4.0
1924.500000	---	38.75	54.00	15.25	100.0	H	346.0	-3.9
2162.750000	48.15	---	74.00	25.85	100.0	H	283.0	-2.7
2189.000000	---	37.34	54.00	16.66	100.0	H	283.0	-2.7
2890.000000	51.24	---	74.00	22.76	100.0	H	283.0	0.5
2899.000000	---	40.64	54.00	13.36	100.0	H	283.0	0.5

Remark: 1. Correction Factor = Antenna factor+ Insertion loss (cable loss + amplifier gain)

802.11n (HT20) CH9

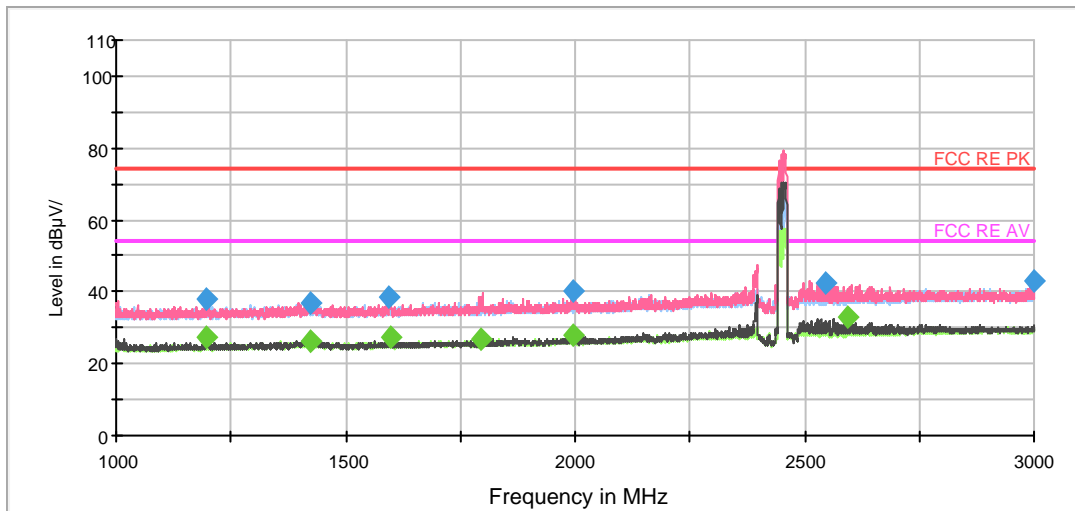

Note: The signal beyond the limit is carrier.
Radiates Emission from 1GHz to 3GHz

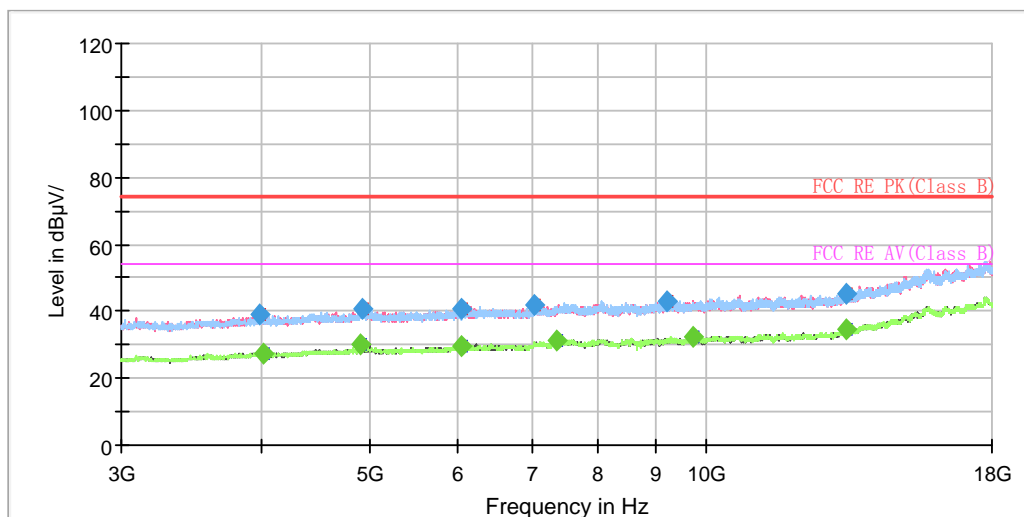

Radiates Emission from 3GHz to 18GHz



Frequency (MHz)	Peak (dBuV/m)	Height (cm)	Polarization	Azimuth (deg)	Correct Factor (dB)	Margin (dB)	Limit (dBuV/m)
1194.500000	38.1	100.0	V	0.0	-11.2	35.9	74.0
1425.750000	36.8	100.0	V	17.0	-10.6	37.2	74.0
1595.750000	38.3	200.0	V	128.0	-10.0	35.7	74.0
1996.750000	40.0	200.0	V	128.0	-8.9	34.0	74.0
2544.750000	42.6	200.0	V	181.0	-6.3	31.4	74.0
2999.000000	43.0	100.0	V	357.0	-5.2	31.0	74.0

Remark: 1. Correction Factor = Antenna factor+ Insertion loss (cable loss + amplifier gain)

Frequency (MHz)	Average (dBuV/m)	Height (cm)	Polarization	Azimuth (deg)	Correct Factor (dB)	Margin (dB)	Limit (dBuV/m)
1195.500000	27.2	200.0	V	92.0	-11.2	26.8	54.0
1425.000000	26.3	100.0	V	159.0	-10.6	27.7	54.0
1597.000000	27.4	200.0	V	3.0	-10.0	26.6	54.0
1795.000000	27.0	200.0	H	51.0	-9.4	27.0	54.0
1994.000000	27.8	200.0	V	128.0	-8.9	26.2	54.0
2592.750000	33.0	200.0	V	181.0	-6.2	21.0	54.0

Remark: 1. Correction Factor = Antenna factor+ Insertion loss (cable loss + amplifier gain)

802.11n (HT20) CH10

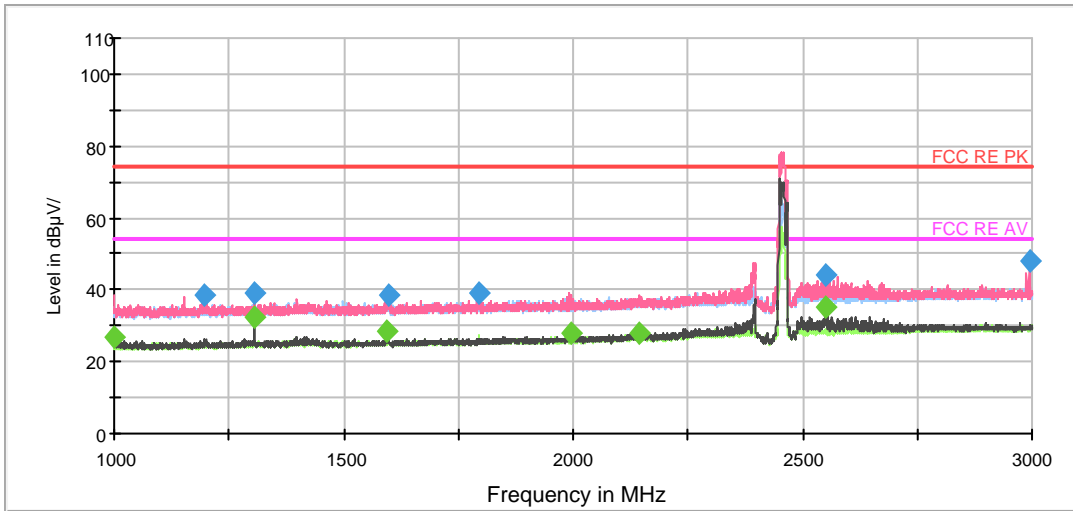

Note: The signal beyond the limit is carrier.
Radiates Emission from 1GHz to 3GHz

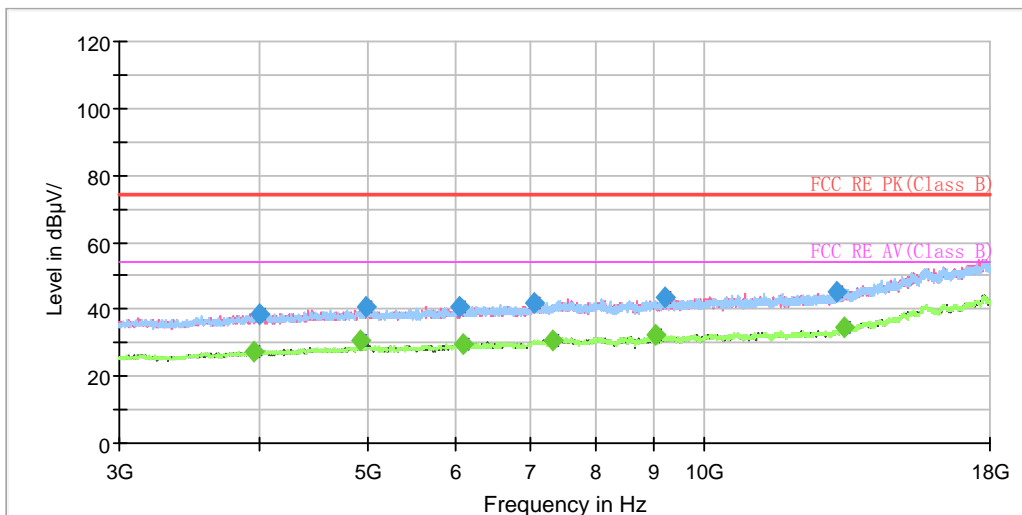

Radiates Emission from 3GHz to 18GHz



Frequency (MHz)	Peak (dBuV/m)	Height (cm)	Polarization	Azimuth (deg)	Correct Factor (dB)	Margin (dB)	Limit (dBuV/m)
1196.000000	38.7	200.0	V	95.0	-11.2	35.3	74.0
1305.750000	39.0	100.0	V	177.0	-11.0	35.0	74.0
1597.500000	38.7	200.0	V	131.0	-10.0	35.3	74.0
1796.500000	39.2	200.0	H	78.0	-9.4	34.8	74.0
2552.000000	44.0	200.0	V	184.0	-6.3	30.0	74.0
2993.500000	47.8	100.0	V	41.0	-5.2	26.2	74.0

Remark: 1. Correction Factor = Antenna factor+ Insertion loss (cable loss + amplifier gain)

Frequency (MHz)	Average (dBuV/m)	Height (cm)	Polarization	Azimuth (deg)	Correct Factor (dB)	Margin (dB)	Limit (dBuV/m)
1000.000000	26.8	200.0	V	149.0	-12.0	27.2	54.0
1305.250000	32.4	100.0	V	177.0	-11.0	21.6	54.0
1593.750000	28.2	200.0	V	149.0	-10.1	25.8	54.0
1996.000000	27.7	200.0	V	113.0	-8.9	26.3	54.0
2146.250000	27.9	200.0	V	165.0	-8.1	26.1	54.0
2552.250000	35.2	200.0	V	184.0	-6.3	18.8	54.0

Remark: 1. Correction Factor = Antenna factor+ Insertion loss (cable loss + amplifier gain)

802.11n (HT20) CH11

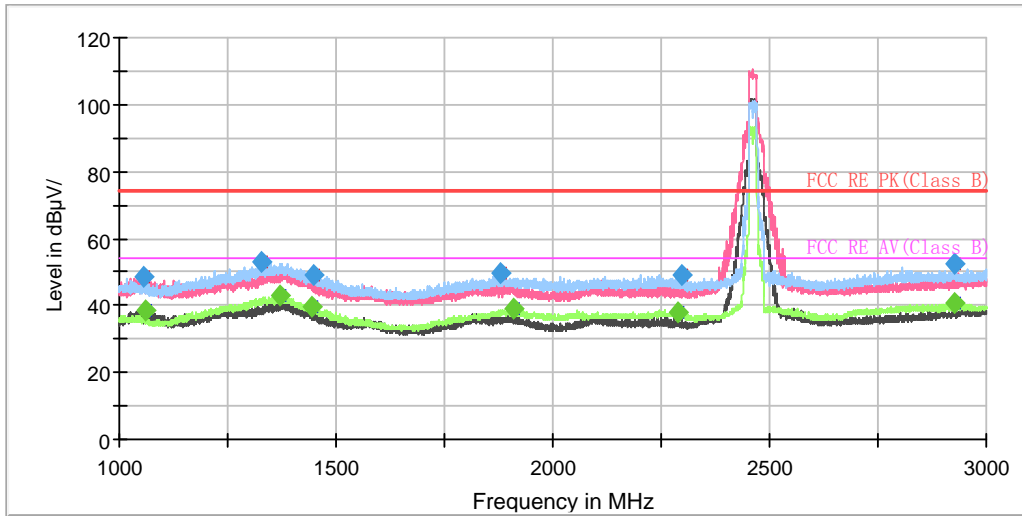

Note: The signal beyond the limit is carrier.
Radiates Emission from 1GHz to 3GHz

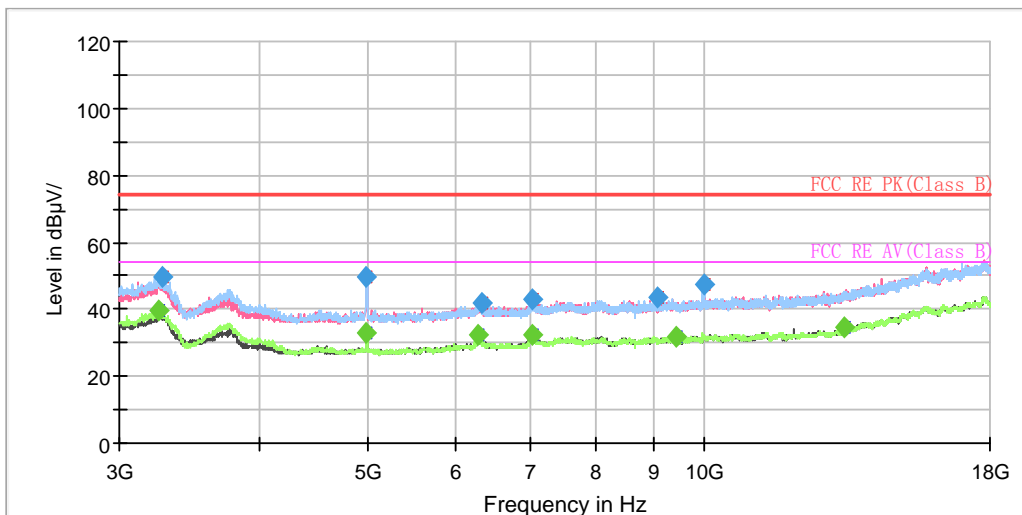

Radiates Emission from 3GHz to 18GHz



Frequency (MHz)	MaxPeak (dB μ V/m)	Average (dB μ V/m)	Limit (dB μ V/m)	Margin (dB)	Height (cm)	Pol	Azimuth (deg)	Corr. (dB)
1056.750000	48.83	---	74.00	25.17	200.0	V	128.0	-8.5
1060.500000	---	38.62	54.00	15.38	200.0	V	144.0	-8.5
1328.500000	52.87	---	74.00	21.13	200.0	H	63.0	-7.1
1371.750000	---	42.96	54.00	11.04	200.0	H	63.0	-6.9
1443.250000	---	39.66	54.00	14.34	200.0	H	63.0	-6.5
1447.500000	49.26	---	74.00	24.74	200.0	H	63.0	-6.5
1877.500000	49.72	---	74.00	24.28	100.0	H	344.0	-4.1
1910.000000	---	38.96	54.00	15.04	100.0	H	0.0	-3.9
2287.750000	---	37.77	54.00	16.23	100.0	H	294.0	-2.2
2296.750000	49.10	---	74.00	24.90	100.0	H	286.0	-2.2
2926.500000	52.20	---	74.00	21.80	100.0	H	279.0	0.7
2928.500000	---	40.67	54.00	13.33	100.0	H	279.0	0.7

Remark: 1. Correction Factor = Antenna factor+ Insertion loss (cable loss + amplifier gain)

802.11n (HT40) CH3

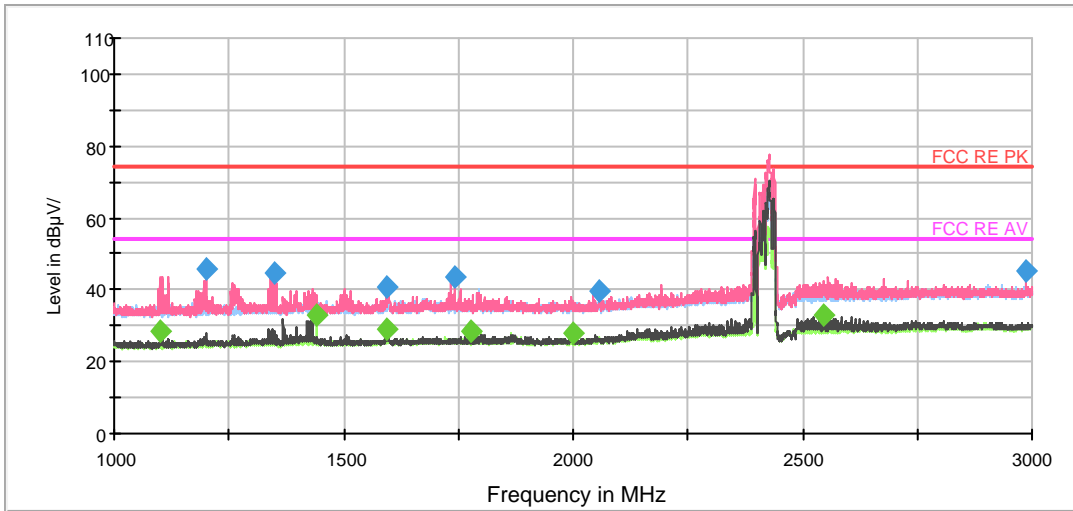

Note: The signal beyond the limit is carrier.
Radiates Emission from 1GHz to 3GHz

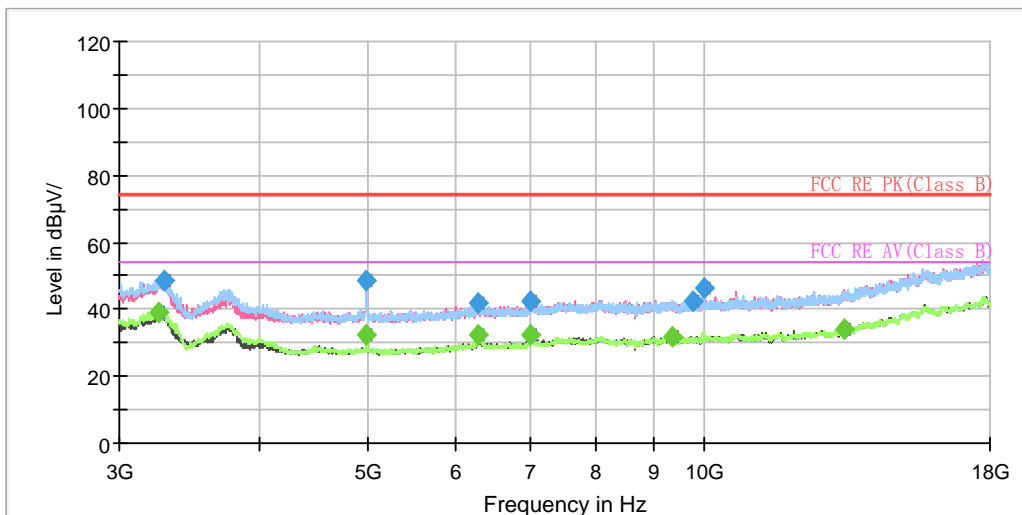

Radiates Emission from 3GHz to 18GHz



Frequency (MHz)	Peak (dBuV/m)	Height (cm)	Polarization	Azimuth (deg)	Correct Factor (dB)	Margin (dB)	Limit (dBuV/m)
1199.750000	45.7	100.0	V	206.0	-11.2	28.3	74.0
1349.000000	44.5	100.0	V	206.0	-10.9	29.5	74.0
1594.250000	40.5	200.0	V	192.0	-10.1	33.5	74.0
1741.750000	43.3	100.0	V	195.0	-9.5	30.7	74.0
2055.500000	39.9	100.0	V	165.0	-8.6	34.1	74.0
2988.250000	45.0	200.0	V	253.0	-5.3	29.0	74.0

Remark: 1. Correction Factor = Antenna factor+ Insertion loss (cable loss + amplifier gain)

Frequency (MHz)	Average (dBuV/m)	Height (cm)	Polarization	Azimuth (deg)	Correct Factor (dB)	Margin (dB)	Limit (dBuV/m)
1102.500000	28.5	100.0	V	259.0	-11.4	25.5	54.0
1439.750000	33.1	200.0	H	8.0	-10.6	20.9	54.0
1594.250000	28.9	200.0	V	192.0	-10.1	25.1	54.0
1775.500000	28.3	200.0	V	233.0	-9.4	25.7	54.0
1999.750000	28.0	100.0	H	323.0	-8.9	26.0	54.0
2547.500000	32.8	200.0	V	212.0	-6.3	21.2	54.0

Remark: 1. Correction Factor = Antenna factor+ Insertion loss (cable loss + amplifier gain)

802.11n (HT40) CH6

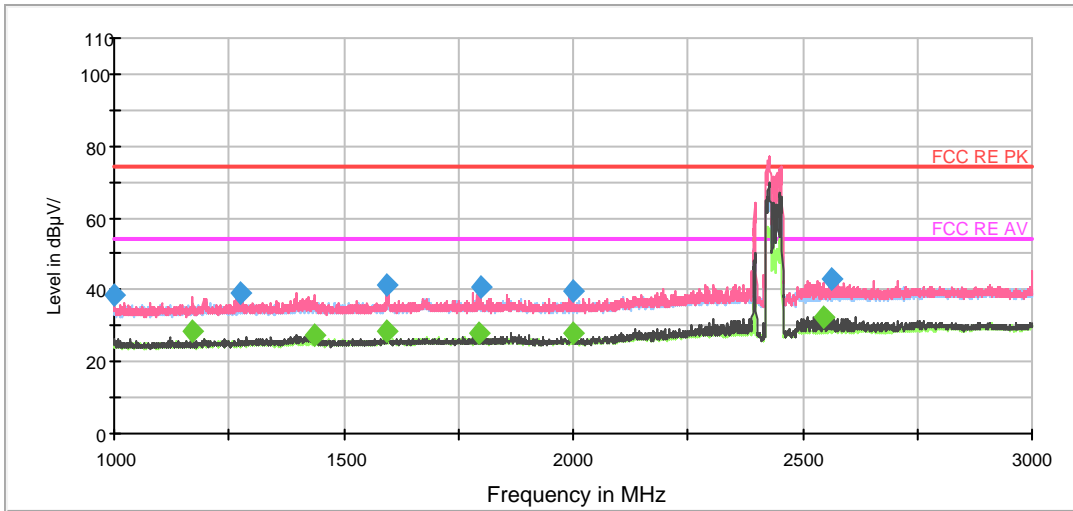

Note: The signal beyond the limit is carrier.
Radiates Emission from 1GHz to 3GHz

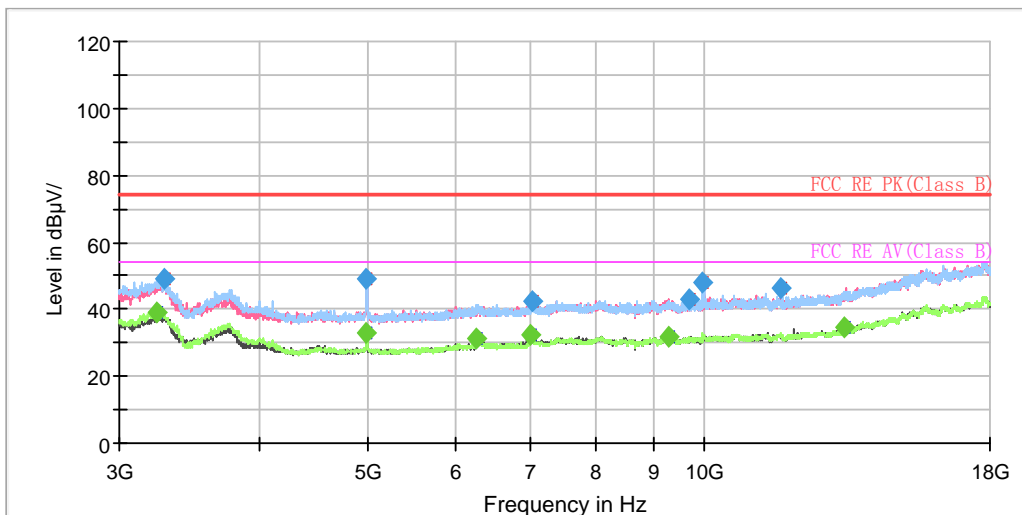

Radiates Emission from 3GHz to 18GHz



Frequency (MHz)	Peak (dBuV/m)	Height (cm)	Polarization	Azimuth (deg)	Correct Factor (dB)	Margin (dB)	Limit (dBuV/m)
1000.000000	38.7	200.0	V	193.0	-12.0	35.3	74.0
1274.750000	39.2	100.0	V	11.0	-11.1	34.8	74.0
1595.000000	41.3	200.0	V	172.0	-10.0	32.7	74.0
1798.500000	40.8	200.0	H	281.0	-9.4	33.2	74.0
1999.000000	39.4	200.0	V	274.0	-8.9	34.6	74.0
2564.000000	43.1	200.0	V	204.0	-6.3	30.9	74.0

Remark: 1. Correction Factor = Antenna factor+ Insertion loss (cable loss + amplifier gain)

Frequency (MHz)	Average (dBuV/m)	Height (cm)	Polarization	Azimuth (deg)	Correct Factor (dB)	Margin (dB)	Limit (dBuV/m)
1170.000000	28.4	100.0	V	11.0	-11.3	25.6	54.0
1435.000000	27.5	100.0	V	196.0	-10.6	26.5	54.0
1595.750000	28.3	200.0	V	172.0	-10.0	25.7	54.0
1794.750000	27.8	100.0	H	241.0	-9.4	26.2	54.0
2000.000000	28.1	100.0	H	181.0	-8.9	25.9	54.0
2547.000000	32.6	200.0	V	214.0	-6.3	21.4	54.0

Remark: 1. Correction Factor = Antenna factor+ Insertion loss (cable loss + amplifier gain)

802.11n (HT40) CH8

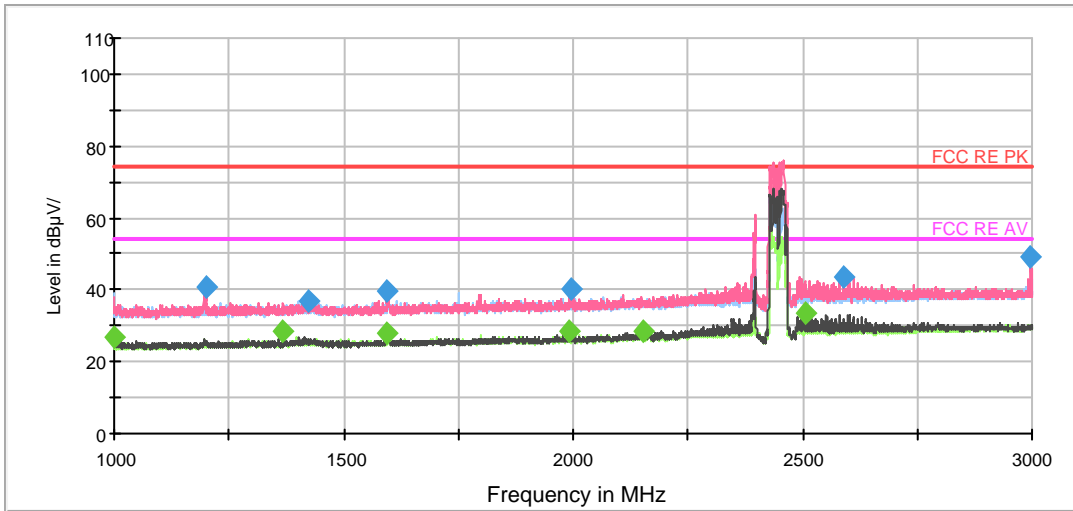

Note: The signal beyond the limit is carrier.
Radiates Emission from 1GHz to 3GHz

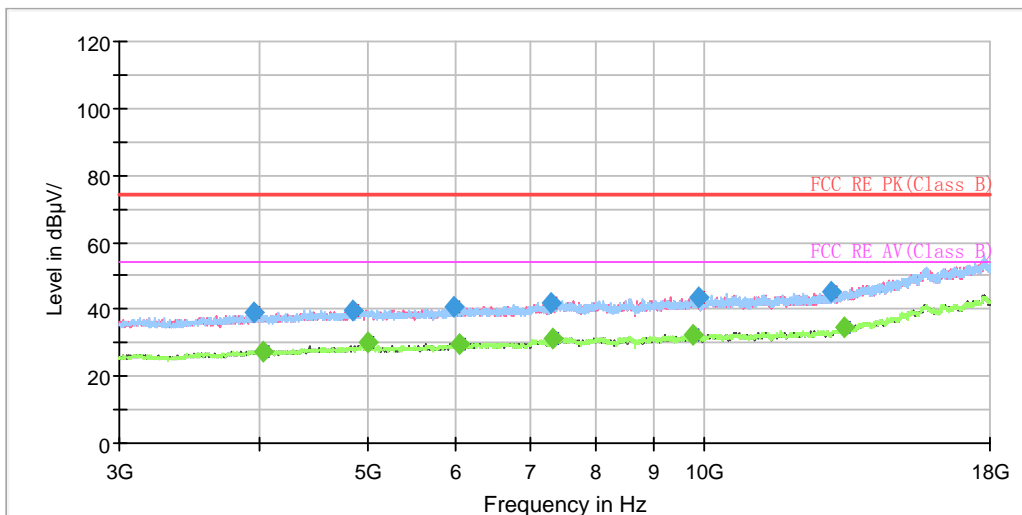

Radiates Emission from 3GHz to 18GHz



Frequency (MHz)	Peak (dBuV/m)	Height (cm)	Polarization	Azimuth (deg)	Correct Factor (dB)	Margin (dB)	Limit (dBuV/m)
1199.250000	40.5	200.0	V	109.0	-11.2	33.5	74.0
1423.000000	37.0	100.0	V	155.0	-10.6	37.0	74.0
1595.750000	39.8	200.0	V	0.0	-10.0	34.2	74.0
1996.500000	40.1	200.0	V	127.0	-8.9	33.9	74.0
2591.000000	43.6	200.0	V	178.0	-6.2	30.4	74.0
2997.750000	49.2	100.0	V	30.0	-5.2	24.8	74.0

Remark: 1. Correction Factor = Antenna factor+ Insertion loss (cable loss + amplifier gain)

Frequency (MHz)	Average (dBuV/m)	Height (cm)	Polarization	Azimuth (deg)	Correct Factor (dB)	Margin (dB)	Limit (dBuV/m)
1000.000000	26.9	200.0	H	127.0	-12.0	27.1	54.0
1368.750000	28.5	100.0	V	323.0	-10.8	25.5	54.0
1593.750000	28.0	200.0	V	0.0	-10.1	26.0	54.0
1991.750000	28.5	200.0	V	127.0	-8.9	25.5	54.0
2151.750000	28.2	100.0	V	49.0	-8.1	25.8	54.0
2504.500000	33.7	200.0	V	178.0	-6.4	20.3	54.0

Remark: 1. Correction Factor = Antenna factor+ Insertion loss (cable loss + amplifier gain)



802.11n (HT40) CH9

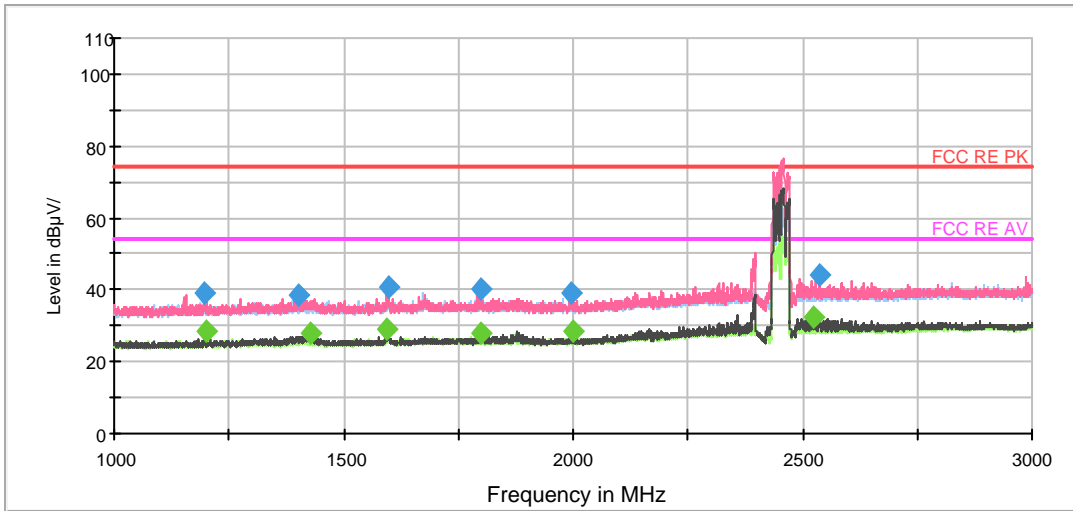

Note: The signal beyond the limit is carrier.
Radiates Emission from 1GHz to 3GHz

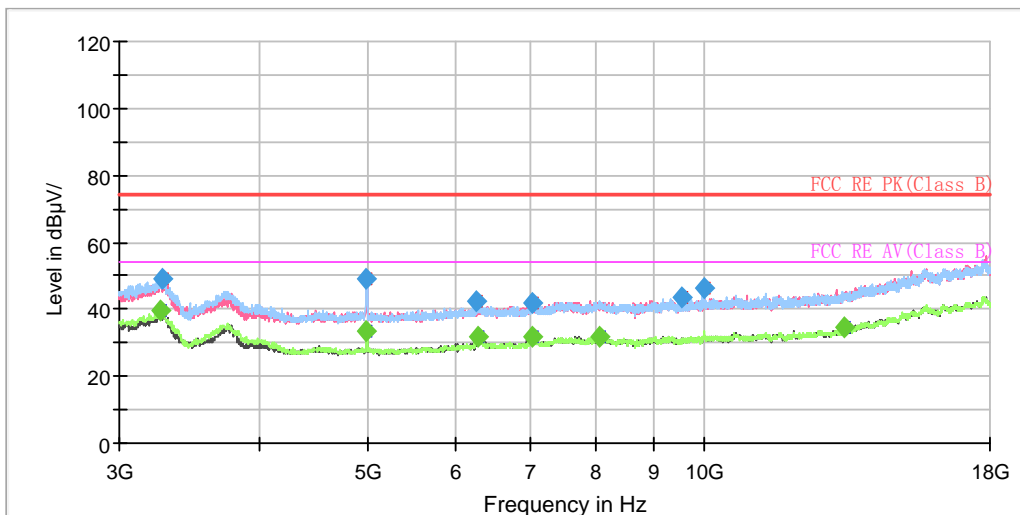

Radiates Emission from 3GHz to 18GHz



Frequency (MHz)	Peak (dBuV/m)	Height (cm)	Polarization	Azimuth (deg)	Correct Factor (dB)	Margin (dB)	Limit (dBuV/m)
1197.000000	39.1	100.0	V	185.0	-11.2	34.9	74.0
1400.000000	38.4	200.0	V	192.0	-10.7	35.6	74.0
1597.750000	40.7	200.0	V	192.0	-10.0	33.3	74.0
1798.250000	40.2	200.0	H	248.0	-9.4	33.8	74.0
1996.250000	39.3	200.0	V	192.0	-8.9	34.7	74.0
2537.750000	44.3	200.0	V	203.0	-6.3	29.7	74.0

Remark: 1. Correction Factor = Antenna factor+ Insertion loss (cable loss + amplifier gain)

Frequency (MHz)	Average (dBuV/m)	Height (cm)	Polarization	Azimuth (deg)	Correct Factor (dB)	Margin (dB)	Limit (dBuV/m)
1199.500000	28.6	200.0	V	192.0	-11.2	25.4	54.0
1429.500000	27.8	100.0	V	206.0	-10.6	26.2	54.0
1594.250000	29.1	200.0	V	192.0	-10.1	24.9	54.0
1799.250000	28.1	100.0	V	238.0	-9.4	25.9	54.0
2000.000000	28.5	100.0	H	69.0	-8.9	25.5	54.0
2525.500000	32.6	200.0	V	213.0	-6.4	21.4	54.0

Remark: 1. Correction Factor = Antenna factor+ Insertion loss (cable loss + amplifier gain)



During the test, the Radiates Emission from 18GHz to 26.5GHz was performed in all modes with all channels, 802.11b CH6 are selected as the worst condition. The test data of the worst-case condition was recorded in this report.

RE 18-26.5GHz PK+AV

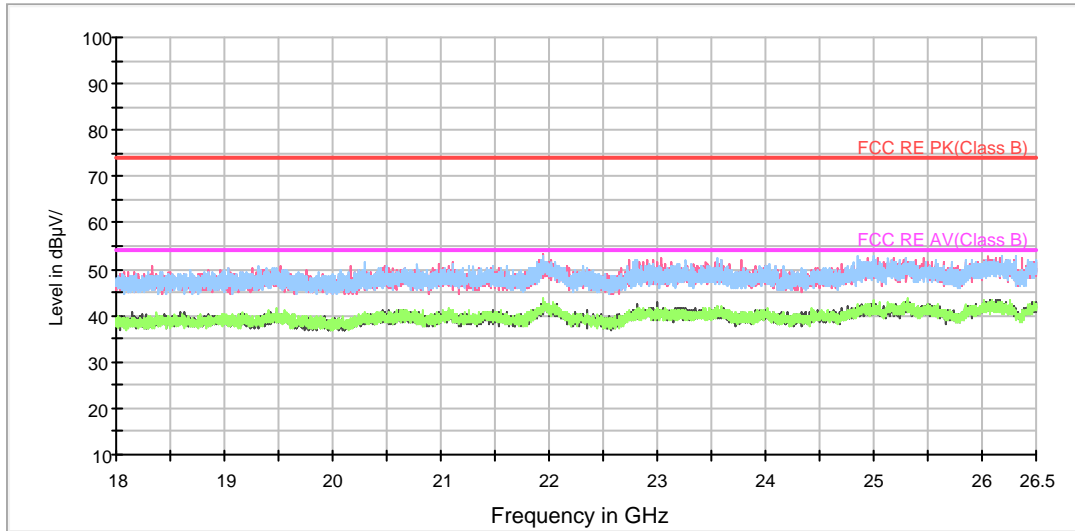

Radiates Emission from 18GHz to 26.5GHz

5.7. Conducted Emission

Ambient condition

Temperature	Relative humidity	Pressure
23°C ~25°C	45%~50%	101.5kPa

Methods of Measurement

The EUT is placed on a non-metallic table of 80cm height above the horizontal metal reference ground plane. During the test, the EUT was operating in its typical mode. The test method is according to ANSI C63.10-2013. Connect the AC power line of the EUT to the L.I.S.N. Use EMI receiver to detect the average and Quasi-peak value. RBW is set to 9 kHz, VBW is set to 30kHz. The measurement result should include both L line and N line.

The test is in transmitting mode.

Test Setup

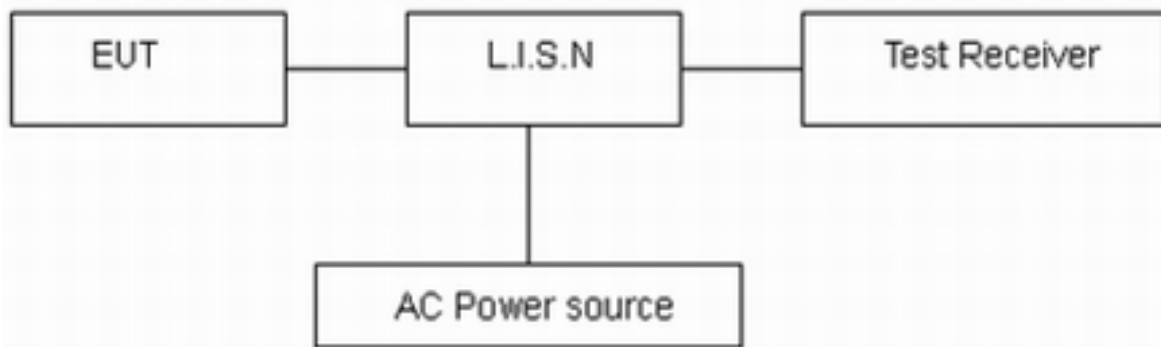

Note: AC Power source is used to change the voltage 110V/60Hz.

Limits

Frequency (MHz)	Conducted Limits(dBμV)	
	Quasi-peak	Average
0.15 - 0.5	66 to 56 *	56 to 46 *
0.5 - 5	56	46
5 - 30	60	50

*: Decreases with the logarithm of the frequency.

Measurement Uncertainty

The assessed measurement uncertainty to ensure 95% confidence level for the normal distribution is with the coverage factor $k = 1.96$, $U = 2.69$ dB.

Test Results:

Following plots, Blue trace uses the peak detection and Green trace uses the average detection. During the test, the Conducted Emission was performed in all modes (WIFI 2.4G) with all channels, 802.11b CH6 are selected as the worst condition. The test data of the worst-case condition was recorded in this report.

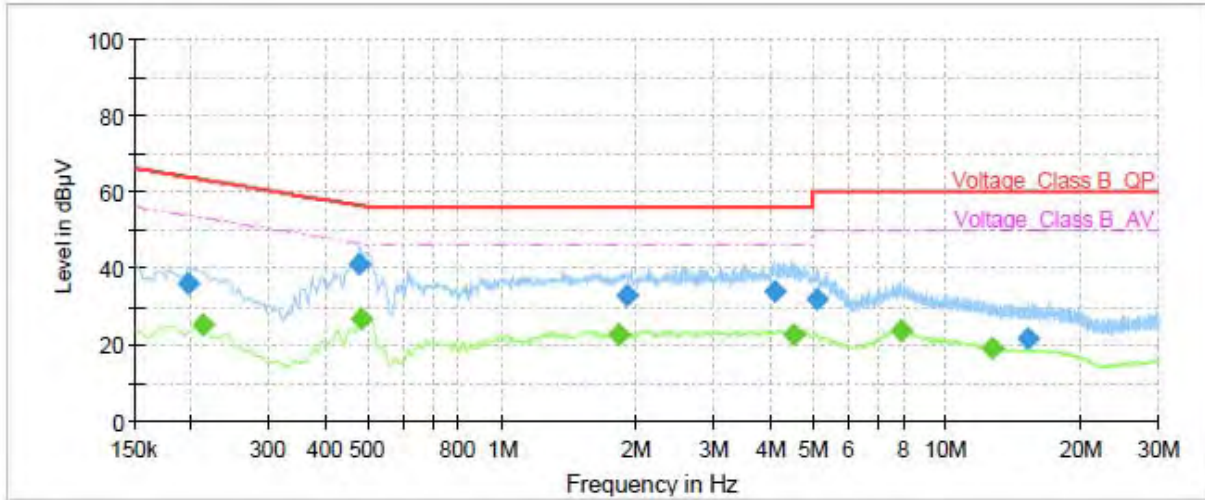

Frequency (MHz)	QuasiPeak (dBµV)	Average (dBµV)	Limit (dBµV)	Margin (dB)	Meas. Time (ms)	Bandwidth (kHz)	Line	Filter	Corr. (dB)
0.20	35.75	---	63.73	27.98	1000.0	9.000	L1	ON	19
0.21	---	24.87	53.09	28.22	1000.0	9.000	L1	ON	19
0.48	40.91	---	56.37	15.46	1000.0	9.000	L1	ON	19
0.48	---	26.63	46.33	19.70	1000.0	9.000	L1	ON	19
1.83	---	22.67	46.00	23.33	1000.0	9.000	L1	ON	19
1.91	32.78	---	56.00	23.22	1000.0	9.000	L1	ON	19
4.12	33.77	---	56.00	22.23	1000.0	9.000	L1	ON	19
4.52	---	22.80	46.00	23.20	1000.0	9.000	L1	ON	19
5.14	31.71	---	60.00	28.29	1000.0	9.000	L1	ON	19
7.90	---	23.40	50.00	26.60	1000.0	9.000	L1	ON	19
12.60	---	18.88	50.00	31.12	1000.0	9.000	L1	ON	19
15.23	21.45	---	60.00	38.55	1000.0	9.000	L1	ON	19

Remark: Correct factor=cable loss + LISN factor

L line Conducted Emission from 150 KHz to 30 MHz

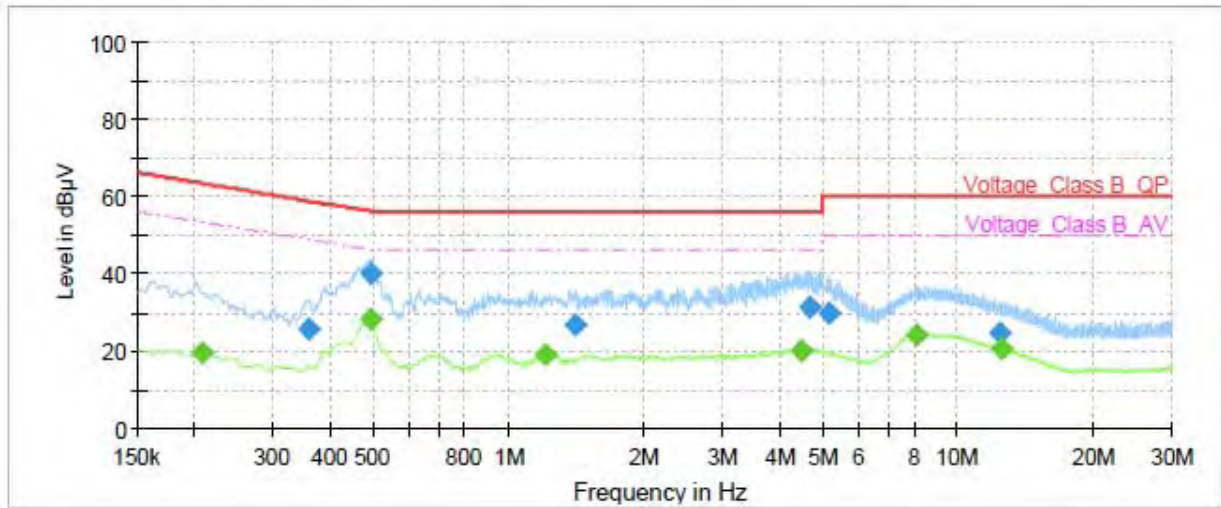

Frequency (MHz)	QuasiPeak (dBµV)	Average (dBµV)	Limit (dBµV)	Margin (dB)	Meas. Time (ms)	Bandwidth (kHz)	Line	Filter	Corr. (dB)
0.21	---	19.34	53.27	33.93	1000.0	9.000	N	ON	19
0.36	25.52	---	58.75	33.23	1000.0	9.000	N	ON	19
0.49	---	28.11	46.13	18.02	1000.0	9.000	N	ON	19
0.49	39.98	---	56.13	16.15	1000.0	9.000	N	ON	19
1.21	---	18.99	46.00	27.01	1000.0	9.000	N	ON	19
1.40	26.65	---	56.00	29.35	1000.0	9.000	N	ON	19
4.48	---	20.15	46.00	25.85	1000.0	9.000	N	ON	19
4.66	31.06	---	56.00	24.94	1000.0	9.000	N	ON	19
5.15	29.77	---	60.00	30.23	1000.0	9.000	N	ON	19
8.10	---	24.24	50.00	25.76	1000.0	9.000	N	ON	19
12.41	24.62	---	60.00	35.38	1000.0	9.000	N	ON	19
12.53	---	20.42	50.00	29.58	1000.0	9.000	N	ON	19

Remark: Correct factor=cable loss + LISN factor

N line Conducted Emission from 150 KHz to 30 MHz



6. Main Test Instruments

Date of Testing: August 1, 2020~ August 26, 2020

Name	Manufacturer	Type	Serial Number	Calibration Date	Expiration Date
Spectrum Analyzer	R&S	FSV30	100815	2019-12-15	2020-12-14
EMI Test Receiver	R&S	ESCI	100948	2020-05-18	2021-05-17
Loop Antenna	SCHWARZBECK	FMZB1519	1519-047	2017-09-26	2020-09-25
TRILOG Broadband Antenna	Schwarzbeck	VULB 9163	9163-201	2017-11-18	2020-11-17
Horn Antenna	R&S	HF907	102723	2018-08-11	2021-08-10
Horn Antenna	ETS-Lindgren	3160-09	00102643	2018-06-20	2021-06-19
EMI Test Receiver	R&S	ESR	101667	2020-05-18	2021-05-17
LISN	R&S	ENV216	101171	2018-12-15	2021-12-14
Spectrum Analyzer	Agilent	N9010A	MY47191109	2020-05-18	2021-05-17
Power Meter	R&S	NRP2	104306	2020-05-18	2021-05-17
Power Sensor	R&S	NRP-Z21	104799	2020-05-18	2021-05-17
20dB Attenuator	Star River Highlight	UCL-TS2S-20	18013001	2019-12-15	2020-12-14
RF Cable	Agilent	SMA 15cm	0001	2020-06-12	2020-12-11
Software	R&S	EMC32	9.26.0	/	/

Date of Testing: June 1, 2021

Name	Manufacturer	Type	Serial Number	Calibration Date	Expiration Date
Spectrum Analyzer	R&S	FSV30	100815	2020-12-13	2021-12-12
EMI Test Receiver	R&S	ESCI	100948	2021-05-15	2022-05-14
Loop Antenna	SCHWARZBECK	FMZB1519	1519-047	2020-04-02	2023-04-01
TRILOG Broadband Antenna	SCHWARZBECK	VULB 9163	391	2019-12-16	2021-12-15
Horn Antenna	R&S	HF907	102723	2018-08-11	2021-08-10
Horn Antenna	ETS-Lindgren	3160-09	00102643	2018-06-20	2021-06-19
EMI Test Receiver	R&S	ESR	101667	2021-05-16	2022-05-15
LISN	R&S	ENV216	101171	2018-12-15	2021-12-14
Spectrum Analyzer	Agilent	N9010A	MY47191109	2021-05-15	2022-05-14
Power Meter	R&S	NRP2	104306	2021-05-15	2022-05-14
Power Sensor	R&S	NRP-Z21	104799	2021-05-15	2022-05-14



20dB Attenuator	Star River Highlight	UCL-TS2S-20	18013001	2020-12-13	2021-12-12
RF Cable	Agilent	SMA 15cm	0001	2020-12-10	2021-06-09
Software	R&S	EMC32	9.26.0	/	/

*****END OF REPORT *****