



RF TEST REPORT

Applicant Huawei Device Co., Ltd.
FCC ID 2ATEYJLN
Product Smart phone
Model JLN-LX3
Report No. R2112A1178-R8
Issue Date January 29, 2022

TA Technology (Shanghai) Co., Ltd. tested the above equipment in accordance with the requirements in **FCC CFR47 Part 15E (2020)**. The test results show that the equipment tested is capable of demonstrating compliance with the requirements as documented in this report.

Prepared by: Peng Tao

Approved by: Kai Xu

TA Technology (Shanghai) Co., Ltd.

No.145, Jintang Rd, Tangzhen Industry Park, Pudong Shanghai, China

TEL: +86-021-50791141/2/3

FAX: +86-021-50791141/2/3-8000



TABLE OF CONTENT

1. Test Laboratory	4
1.1. Notes of the test report.....	4
1.2. Test facility	4
1.3. Testing Location.....	4
2. General Description of Equipment under Test.....	5
2.3. Applicant and Manufacturer Information.....	5
2.4. General information.....	5
3. Applied Standards	8
4. DFS Technical Requirements and Radar Test Waveforms	9
4.3. DFS Overview	9
4.4. DFS Detection Thresholds	10
4.5. RADAR TEST WAVEFORMS	11
4.6. Test set-ups	14
5. Test Case Results	16
5.3. DFS Detection Thresholds	16
5.4. Channel Move Time, Channel Closing Transmission Time and Non-Occupancy Period ...	18
6. Main Test Instruments.....	24
ANNEX A: The EUT Appearance	25
ANNEX B: Test Setup Photos	26



Summary of measurement results

Number	Test Case	Clause in FCC rules	Verdict
1	DFS Detection Threshold	15.407/KDB 905462 5.2	Pass
2	U-NII Detection Bandwidth	15.407/KDB 905462 7.8.1	NA
3	Channel Availability Check Time	15.407/KDB 905462 7.8.2	NA
4	Channel Move Time	15.407/KDB 905462 7.8.3	Pass
5	Channel Closing Transmission Time	15.407/KDB 905462 7.8.3	Pass
6	Non-Occupancy Period(NOP)	15.407/KDB 905462 7.8.3	Pass
7	Statistical Performance Check	15.407/KDB 905462 7.8.4	NA

Date of Testing: January 5, 2022 ~ January 20, 2022

Date of Sample Received: December 24, 2021

Note: PASS: The EUT complies with the essential requirements in the standard.

FAIL: The EUT does not comply with the essential requirements in the standard.

All indications of Pass/Fail in this report are opinions expressed by TA Technology (Shanghai) Co., Ltd. based on interpretations and/or observations of test results. Measurement Uncertainties were not taken into account and are published for informational purposes only.



1. Test Laboratory

1.1. Notes of the test report

This report shall not be reproduced in full or partial, without the written approval of **TA technology (shanghai) co., Ltd.** The results documented in this report apply only to the tested sample, under the conditions and modes of operation as described herein. Measurement Uncertainties were not taken into account and are published for informational purposes only. This report is written to support regulatory compliance of the applicable standards stated above.

1.2. Test facility

FCC (Designation number: CN1179, Test Firm Registration Number: 446626)

TA Technology (Shanghai) Co., Ltd. has been listed on the US Federal Communications Commission list of test facilities recognized to perform measurements.

A2LA (Certificate Number: 3857.01)

TA Technology (Shanghai) Co., Ltd. has been listed by American Association for Laboratory Accreditation to perform measurement.

1.3. Testing Location

Company: TA Technology (Shanghai) Co., Ltd.
Address: No.145, Jintang Rd, Tangzhen Industry Park, Pudong
City: Shanghai
Post code: 201201
Country: P. R. China
Contact: Xu Kai
Telephone: +86-021-50791141/2/3
Fax: +86-021-50791141/2/3-8000
Website: <http://www.ta-shanghai.com>
E-mail: xukai@ta-shanghai.com

2. General Description of Equipment under Test

2.1. Applicant and Manufacturer Information

Applicant	Huawei Device Co., Ltd.
Applicant address	No.2 of Xincheng Road, Songshan Lake Zone, Dongguan, Guangdong 523808, People's Republic of China
Manufacturer	Huawei Device Co., Ltd.
Manufacturer address	No.2 of Xincheng Road, Songshan Lake Zone, Dongguan, Guangdong 523808, People's Republic of China

2.2. General information

EUT Description			
Model	JLN-LX3		
SN	HWQYD21C07500087		
Hardware Version	HL1JLNM		
Software Version	12.0.1.100(C900E100R1P3)		
Power Supply	Battery / AC adapter		
Antenna Type	Internal Antenna		
Operating Frequency Range(s)	U-NII-2A: 5250MHz-5350MHz U-NII-2C: 5470MHz-5725MHz		
Modulation Type	802.11a (HT20): OFDM 802.11n (HT20/HT40): OFDM 802.11ac (VHT20/VHT40/VHT80): OFDM		
Operating Mode	<input type="checkbox"/> Master <input type="checkbox"/> Client with radar detection <input checked="" type="checkbox"/> Client without radar detection		
EUT Accessory			
Accessory	Model	Manufacture	No.
Adapter	HW-110600U00	Huawei Technologies Co., Ltd. (Manufacturer: Astec Electronics (Luoding) Co. Limited)	1
		Huawei Technologies Co., Ltd. (Manufacturer: ASAP TECHNOLOGY (Jiangxi) CO., LTD)	2
	HW-110600U02	Huawei Technologies Co., Ltd. (Manufacturer: Astec Electronics (Luoding) Co. Limited)	3
		Huawei Technologies Co., Ltd. (Manufacturer: ASAP TECHNOLOGY (Jiangxi) CO., LTD)	4
	HW-110600E02	Huawei Technologies Co., Ltd. (Manufacturer: Astec Electronics (Luoding) Co. Limited)	5
		Huawei Technologies Co., Ltd. (Manufacturer: ASAP TECHNOLOGY (Jiangxi) CO., LTD)	6
	HW-110600B02	Huawei Technologies Co., Ltd. (Manufacturer: Astec Electronics (Luoding) Co. Limited)	7
		Huawei Technologies Co., Ltd.	8



		(Manufacturer: ASAP TECHNOLOGY (Jiangxi) CO., LTD)	
	HW-110600A02	Huawei Technologies Co., Ltd. (Manufacturer: Astec Electronics (Luoding) Co. Limited)	9
		Huawei Technologies Co., Ltd. (Manufacturer: ASAP TECHNOLOGY (Jiangxi) CO., LTD)	10
	HW-110600B00	Huawei Technologies Co., Ltd. (Manufacturer: Astec Electronics (Luoding) Co. Limited)	11
		Huawei Technologies Co., Ltd. (Manufacturer: ASAP TECHNOLOGY (Jiangxi) CO., LTD)	12
	HW-110600E00	Huawei Technologies Co., Ltd. (Manufacturer: Astec Electronics (Luoding) Co. Limited)	13
		Huawei Technologies Co., Ltd. (Manufacturer: ASAP TECHNOLOGY (Jiangxi) CO., LTD)	14
	HW-110600A00	Huawei Technologies Co., Ltd. (Manufacturer: Astec Electronics (Luoding) Co. Limited)	15
		Huawei Technologies Co., Ltd. (Manufacturer: ASAP TECHNOLOGY (Jiangxi) CO., LTD)	16
Battery	HB426493EFW	SCUD (FUJIAN) Electronics Co., Ltd.	1
		Sunwoda Electronic Co.,LTD.	2
Earphone	1311-3291-600 1-TC-351	Boluo County Quancheng Electronic Co., Ltd.	1
USB Cable	L99UC139-CS- H	Luxshare Precision industry Co.,Ltd	1
	213-01011-0	MING JI ELECTRONICS CO., LTD.	2
Earphone, USB Type-C to 3.5mm Adapter Assembly	6001-7001-TC- 348	Boluo County Quancheng Electronic Co., Ltd.	1
	USB042020090 AW7	Jiangxi Lianchuang Hongsheng Electronic Co.,Ltd.	2
	642344	FOSTER ELECTRIC CO. (HONG KONG) LTD	3
<p>Note: 1. The EUT is sent from the applicant to TA and the information of the EUT is declared by the applicant.</p> <p>2. There are more than one Adapter, Battery and USB Cable, each one should be applied throughout the compliance test respectively, however, only the worst case (Adapter 2, Battery 1 and USB Cable 1) will be recorded in this report.</p>			

**Wireless Technology and Frequency Range**

Wireless Technology		Bandwidth	Channel	Frequency
Wi-Fi	U-NII-2A	20 MHz	52	5260MHz
			56	5280MHz
			60	5300MHz
			64	5320MHz
		40 MHz	54	5270MHz
			62	5310MHz
			58	5290MHz
	U-NII-2C	20 MHz	100	5500MHz
			104	5520MHz
			108	5540MHz
			112	5560MHz
			116	5580MHz
			120	5600MHz
			124	5620MHz
			128	5640MHz
			132	5660MHz
			136	5680MHz
			140	5700MHz
			144	5720MHz
			40 MHz	102
		110		5550MHz
		118		5590MHz
		126		5630MHz
		134		5670MHz
		142		5710MHz
		80 MHz		106
			122	5610MHz
138	5690MHz			
Does this device support TPC Function? <input checked="" type="checkbox"/> Yes <input type="checkbox"/> No				
Does this device support TDWR Band? <input checked="" type="checkbox"/> Yes <input type="checkbox"/> No				



3. Applied Standards

According to the specifications of the manufacturer, it must comply with the requirements of the following standards:

Test standards:

FCC CFR47 Part 15E (2020) Unlicensed National Information Infrastructure Devices

Reference standard:

FCC KDB 905462 D02 UNII DFS Compliance Procedures New Rules v02

FCC KDB 905462 D03 Client Without DFS New Rules v01r02

4. DFS Technical Requirements and Radar Test Waveforms

4.1. DFS Overview

Table 1 Applicability of DFS Requirements Prior to Use of a Channel

Requirement	Operational Mode		
	Master	Client Without Radar Detection	Client With Radar Detection
Non-Occupancy Period	Yes	Not required	Yes
DFS Detection Threshold	Yes	Not required	Yes
Channel Availability Check Time	Yes	Not required	Not required
U-NII Detection Bandwidth	Yes	Not required	Yes

Table 2 Applicability of DFS requirements during normal operation

Requirement	Operational Mode	
	Master Device or Client with Radar Detection	Client Without Radar Detection
DFS Detection Threshold	Yes	Not required
Channel Closing Transmission Time	Yes	Yes
Channel Move Time	Yes	Yes
U-NII Detection Bandwidth	Yes	Not required
Additional requirements for devices with multiple bandwidth modes	Master Device or Client with Radar Detection	Client Without Radar Detection
U-NII Detection Bandwidth	All BW modes must be tested	Not required
Statistical Performance Check	All BW modes must be tested	Not required
Channel Closing Transmission Time	Test using widest BW mode available	Test using the widest BW mode available for the link
Channel Move Time	Test using widest BW mode available	Test using the widest BW mode available for the link
All other tests	Any single BW mode	Not required
<p>Note: Frequencies selected for statistical performance check should include several frequencies within the radar detection bandwidth and frequencies near the edge of the radar detection bandwidth. For 802.11 devices it is suggested to select frequencies in each of the bonded 20 MHz channels and the channel center frequency.</p>		

4.2. DFS Detection Thresholds

Table 3 DFS Detection Thresholds for Master Devices and Client Devices with Radar Detection

Maximum Transmit Power	Value (See Notes 1, 2, and 3)
EIRP ≥ 200 milliwatt	-64 dBm
EIRP < 200 milliwatt and power spectral density < 10 dBm/MHz	-62 dBm
EIRP < 200 milliwatt that do not meet the power spectral density requirement	-64 dBm

Note 1: This is the level at the input of the receiver assuming a 0 dBi receive antenna.

Note 2: Throughout these test procedures an additional 1 dB has been added to the amplitude of the test transmission waveforms to account for variations in measurement equipment. This will ensure that the test signal is at or above the detection threshold level to trigger a DFS response.

Note 3: EIRP is based on the highest antenna gain. For MIMO devices refer to KDB Publication 662911 D01.

Table 4 DFS Response Requirement Values

Parameter	Value
Non-occupancy period	Minimum 30 minutes
Channel Availability Check Time	60 seconds
Channel Move Time	10 seconds See Note 1.
Channel Closing Transmission Time	200 milliseconds + an aggregate of 60 milliseconds over remaining 10 second period. See Notes 1 and 2.
U-NII Detection Bandwidth	Minimum 100% of the U-NII 99% transmission power bandwidth. See Note 3.

Note 1: Channel Move Time and the Channel Closing Transmission Time should be performed with Radar Type 0. The measurement timing begins at the end of the Radar Type 0 burst.

Note 2: The Channel Closing Transmission Time is comprised of 200 milliseconds starting at the beginning of the Channel Move Time plus any additional intermittent control signals required to facilitate a Channel move (an aggregate of 60 milliseconds) during the remainder of the 10 second period. The aggregate duration of control signals will not count quiet periods in between transmissions.

Note 3: During the U-NII Detection Bandwidth detection test, radar type 0 should be used. For each frequency step the minimum percentage of detection is 90 percent. Measurements are performed with no data traffic

4.3. RADAR TEST WAVEFORMS

Table 5 Short Pulse Radar Test Waveforms

Radar Type	Pulse Width (μsec)	PRI (μsec)	Number of Pulses	Minimum Percentage of Successful Detection	Minimum Number of Trials
0	1	1428	18	See Note 1	See Note 1
1	1	Test A: 15 unique PRI values randomly selected from the list of 23 PRI values in Table 5a	Roundup	60%	30
		Test B: 15 unique PRI values randomly selected within the range of 518-3066 μsec, with a minimum increment of 1 μsec, excluding PRI values selected in Test A			
2	1-5	150-230	23-29	60%	30
3	6-10	200-500	16-18	60%	30
4	11-20	200-500	12-16	60%	30
Aggregate (Radar Types 1-4)				80%	120
<p>Note 1: Short Pulse Radar Type 0 should be used for the detection bandwidth test, channel move time, and channel closing time tests.</p>					



Table 5a Pulse Repetition Intervals Values for Test A

Pulse Repetition Frequency Number	Pulse Repetition Frequency (Pulses Per Second)	Pulse Repetition Interval (Microseconds)
1	1930.5	518
2	1858.7	538
3	1792.1	558
4	1730.1	578
5	1672.2	598
6	1618.1	618
7	1567.4	638
8	1519.8	658
9	1474.9	678
10	1432.7	698
11	1392.8	718
12	1355	738
13	1319.3	758
14	1285.3	778
15	1253.1	798
16	1222.5	818
17	1193.3	838
18	1165.6	858
19	1139	878
20	1113.6	898
21	1089.3	918
22	1066.1	938
23	326.2	3066

The aggregate is the average of the percentage of successful detections of Short Pulse Radar Types 1-4. For example, the following table indicates how to compute the aggregate of percentage of successful detections.

Radar Type	Number of Trials	Number of Successful Detections	Minimum Percentage of Successful Detection
1	35	29	82.9%
2	30	18	60%
3	30	27	90%
4	50	44	88%
Aggregate $(82.9\% + 60\% + 90\% + 88\%)/4 = 80.2\%$			

Table 6 Long Pulse Radar Test Waveform

Radar Type	Pulse Width (μsec)	Chirp Width (MHz)	PRI (μsec)	Number of Pulses per Burst	Number of Bursts	Minimum Percentage of Successful Detection	Minimum Number of Trials
5	50-100	5-20	1000-2000	1-3	8-20	80%	30

The parameters for this waveform are randomly chosen. Thirty unique waveforms are required for the Long Pulse Radar Type waveforms. If more than 30 waveforms are used for the Long Pulse Radar Type waveforms, then each additional waveform must also be unique and not repeated from the previous waveforms.

Table 7 Frequency Hopping Radar Test Waveform

Radar Type	Pulse Width (μsec)	PRI (μsec)	Pulses per Hop	Hopping Rate (kHz)	Hopping Sequence Length (msec)	Minimum Percentage of Successful Detection	Minimum Number of Trials
6	1	333	9	0.333	300	70%	30

For the Frequency Hopping Radar Type, the same Burst parameters are used for each waveform. The hopping sequence is different for each waveform and a 100-length segment is selected from the hopping sequence defined by the following algorithm: The first frequency in a hopping sequence is selected randomly from the group of 475 integer frequencies from 5250 – 5724 MHz. Next, the frequency that was just chosen is removed from the group and a frequency is randomly selected from the remaining 474 frequencies in the group. This process continues until all 475 frequencies are chosen for the set. For selection of a random frequency, the frequencies remaining within the group are always treated as equally likely.

4.4. Test set-ups

We test the data stream using MPEG-X files.

Channel loading is based on IP.

Setup for Master with injection at the Master

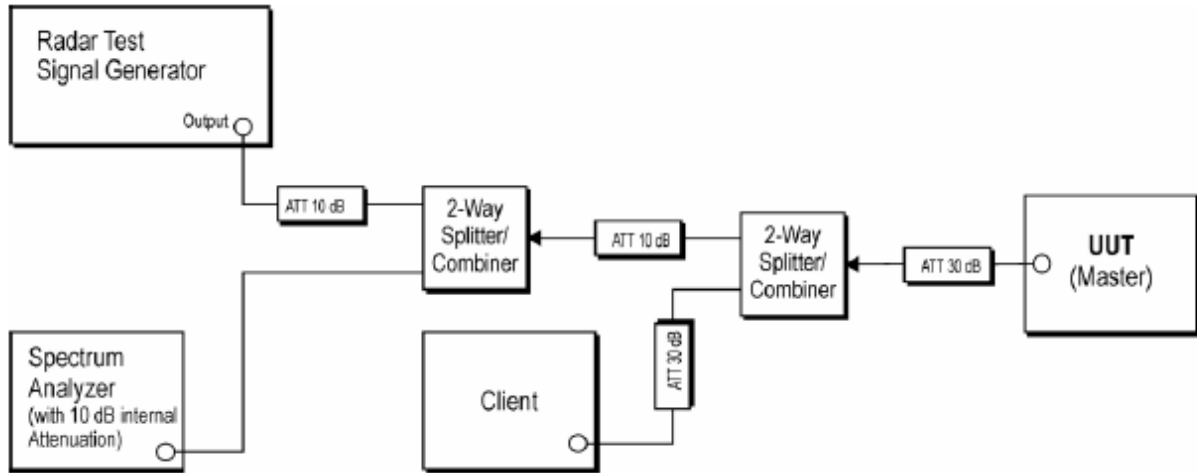

Figure 2: Example Conducted Setup where UUT is a Master and Radar Test Waveforms are injected into the Master

Setup for Client with injection at the Master

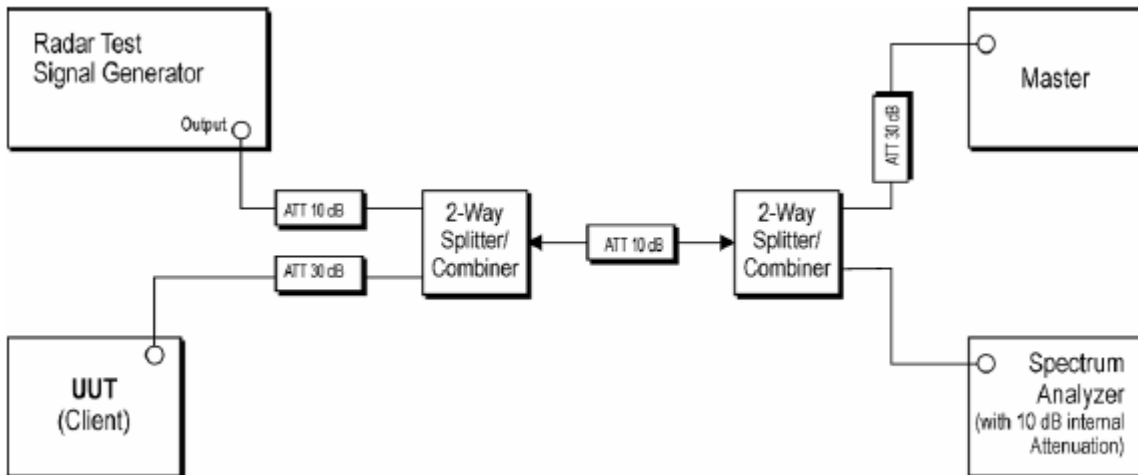

Figure 3: Example Conducted Setup where UUT is a Client and Radar Test Waveforms are injected into the Master

Setup for Client with injection at the Client

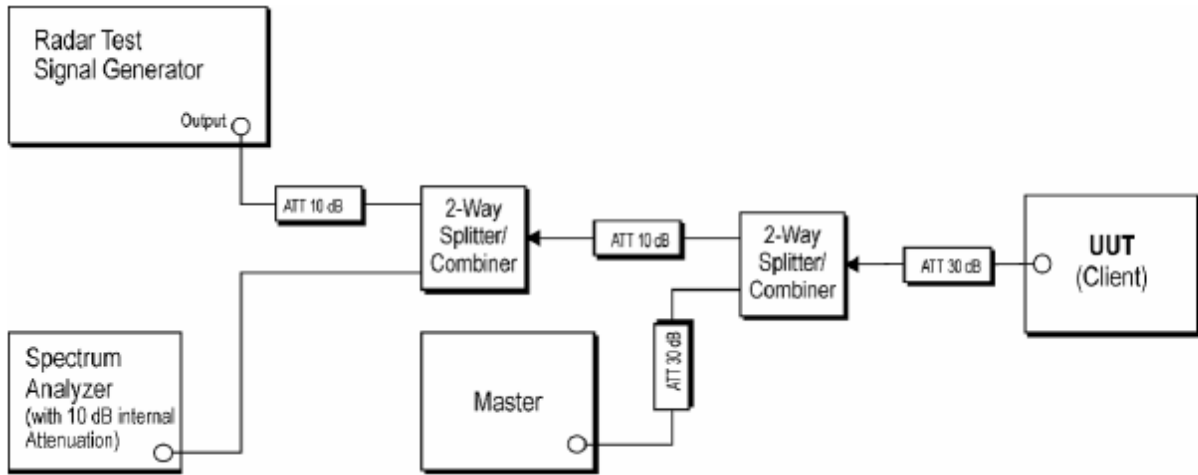

Figure 4: Example Conducted Setup where UUT is a Client and Radar Test Waveforms are injected into the Client

5. Test Case Results

5.1. DFS Detection Thresholds

Ambient condition

Temperature	Relative humidity	Pressure
23°C ~25°C	45%~50%	101.5kPa

Methods of Measurement

Client with injection at the Master.

For a detection threshold level of -64dBm, the required signal strength at EUT antenna location is -64dBm, the tested level is lower than required level hence it provides margin to the limit.

Frequency of Calibration	
Bandwidth	Central Frequency
20MHz	5300MHz
	5500MHz
40MHz	5270MHz
	5550MHz
80MHz	5290MHz
	5610MHz



Calibration Result

Radar 0

Central Frequency: 5270 MHz

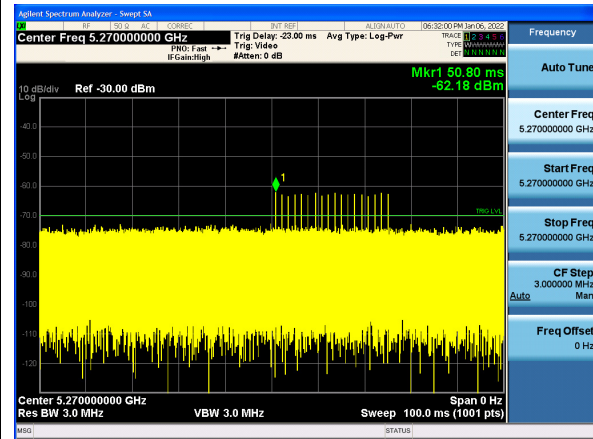

Central Frequency: 5290 MHz

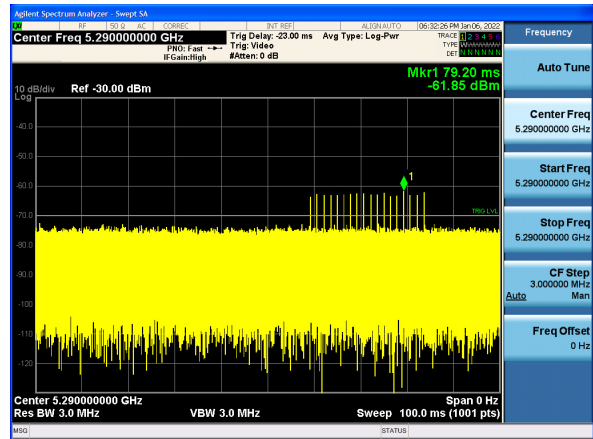

Central Frequency: 5300 MHz

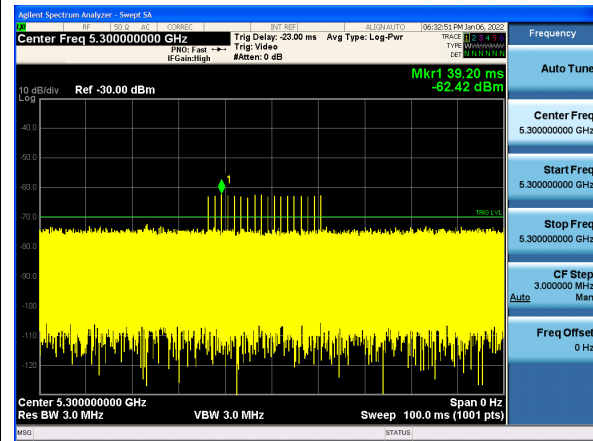

Central Frequency: 5500 MHz

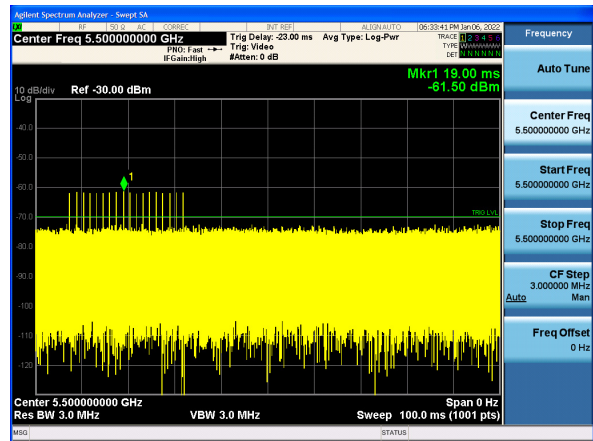

Central Frequency: 5550 MHz

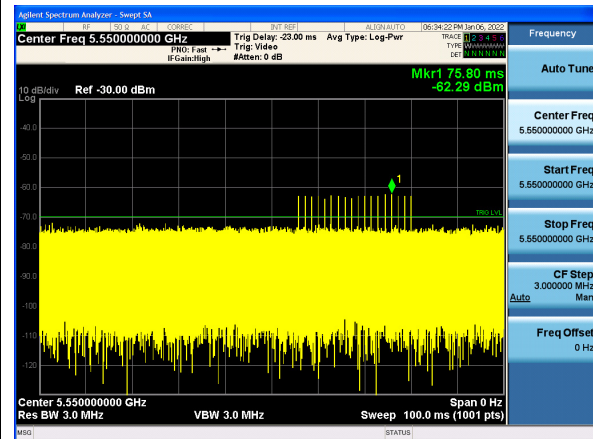

Central Frequency: 5610 MHz

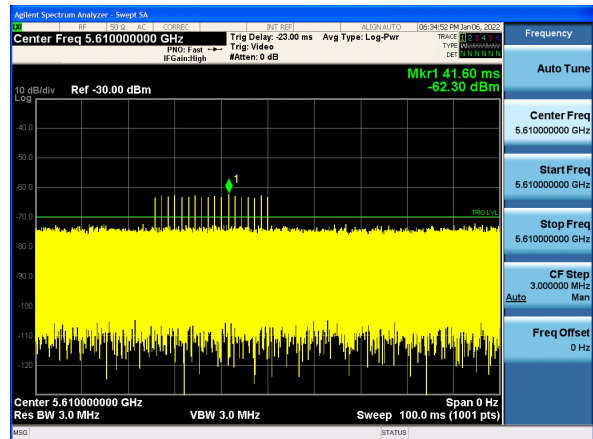

5.2. Channel Move Time, Channel Closing Transmission Time and Non-Occupancy Period

Ambient condition

Temperature	Relative humidity	Pressure
23°C ~25°C	45%~50%	101.5kPa

Methods of Measurement

These tests define how the following DFS parameters are verified during In-Service Monitoring;

- Channel Closing Transmission Time
- Channel Move Time
- Non-Occupancy Period

The steps below define the procedure to determine the above mentioned parameters when a radar Burst with a level equal to the DFS Detection Threshold + 1dB is generated on the Operating Channel of the U-NII device (In- Service Monitoring).

1. One frequency will be chosen from the Operating Channels of the EUT within the 5250-5350 MHz or 5470-5725 MHz bands. For 802.11 devices, the test frequency must contain control signals. This can be verified by disabling channel loading and monitoring the spectrum analyzer. If no control signals are detected, another frequency must be selected within the emission bandwidth where control signals are detected.
2. In case the EUT is a U-NII device operating as a Client Device (with or without DFS), a U-NII device operating as a Master Device will be used to allow the EUT (Client device) to Associate with the Master Device. In case the EUT is a Master Device, a U-NII device operating as a Client Device will be used and it is assumed that the Client will Associate with the EUT (Master). In both cases for conducted tests, the Radar Waveform generator will be connected to the Master Device. For radiated tests, the emissions of the Radar Waveform generator will be directed towards the Master Device. If the Master Device has antenna gain, the main beam of the antenna will be directed toward the radar emitter. Vertical polarization is used for testing.
3. Stream the channel loading test file from the Master Device to the Client Device on the test Channel for the entire period of the test.
4. At time T_0 the Radar Waveform generator sends a Burst of pulses for one of the Radar Type 0 in Table 5 at levels defined in Table 3, on the Operating Channel. An additional 1 dB is added to the radar test signal to ensure it is at or above the DFS Detection Threshold, accounting for equipment variations/errors.
5. Observe the transmissions of the EUT at the end of the radar Burst on the Operating Channel for duration greater than 10 seconds. Measure and record the transmissions from the EUT during the observation time (Channel Move Time). Measure and record the Channel Move Time and Channel Closing Transmission Time if radar detection occurs. Figure 17 illustrates Channel Closing

Transmission Time.

6. When operating as a Master Device, monitor the EUT for more than 30 minutes following instant T_2 to verify that the EUT does not resume any transmissions on this Channel. Perform this test once and record the measurement result.

7. In case the EUT is a U-NII device operating as a Client Device with In-Service Monitoring, perform steps 1 to 6.

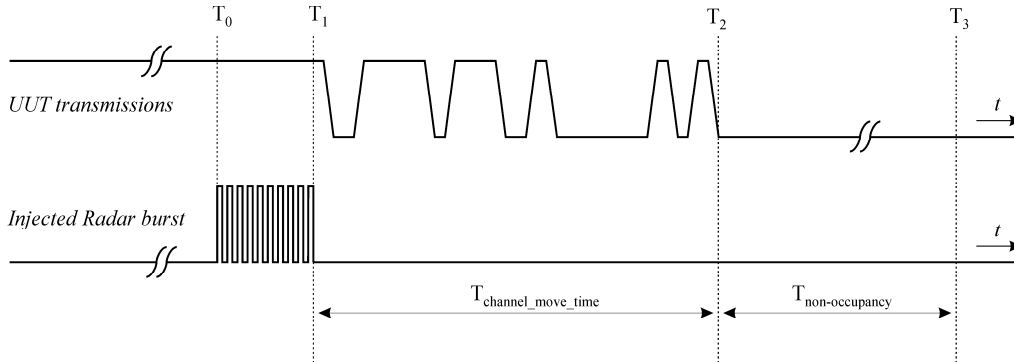

Figure 17: Example of Channel Closing Transmission Time & Channel Closing Time

Limits

Channel Move Time	$\leq 10s$
Channel Closing Transmission Time	$\leq 200ms + 60ms$ (over remaining 10s period)
Non-Occupancy Period	$\geq 30min$

Note 1: Channel Move Time and the Channel Closing Transmission Time should be performed with Radar Type 0. The measurement timing begins at the end of the Radar Type 0 burst.

Note 2: The Channel Closing Transmission Time is comprised of 200 milliseconds starting at the beginning of the Channel Move Time plus any additional intermittent control signals required to facilitate a Channel move (an aggregate of 60 milliseconds) during the remainder of the 10 second period. The aggregate duration of control signals will not count quiet periods in between transmissions.

Measurement Uncertainty

The assessed measurement uncertainty to ensure 95% confidence level for the normal distribution is with the coverage factor $k = 1.96$, $U = 2.69$ dB.



Test Results:

Timing plot

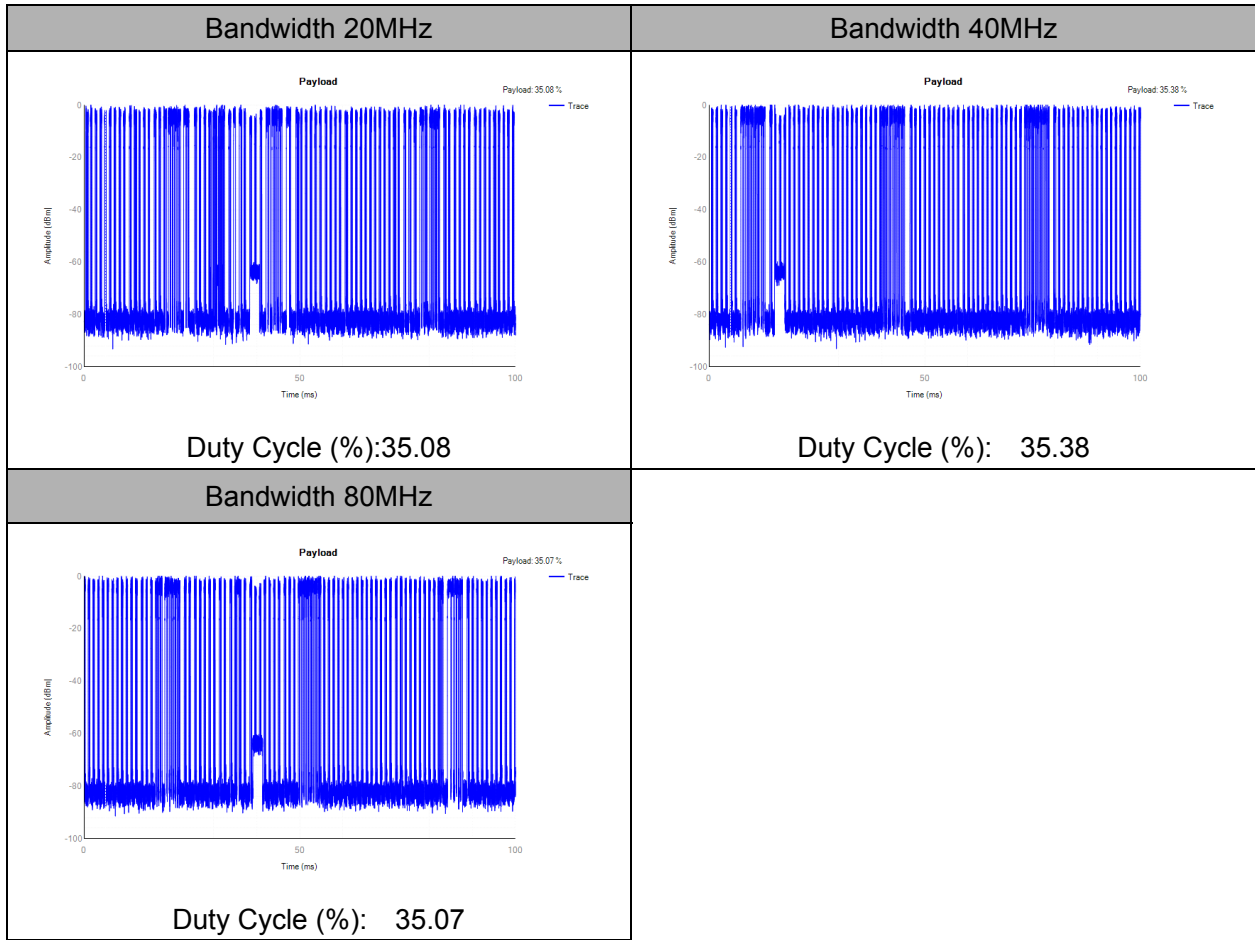



Channel Move Time

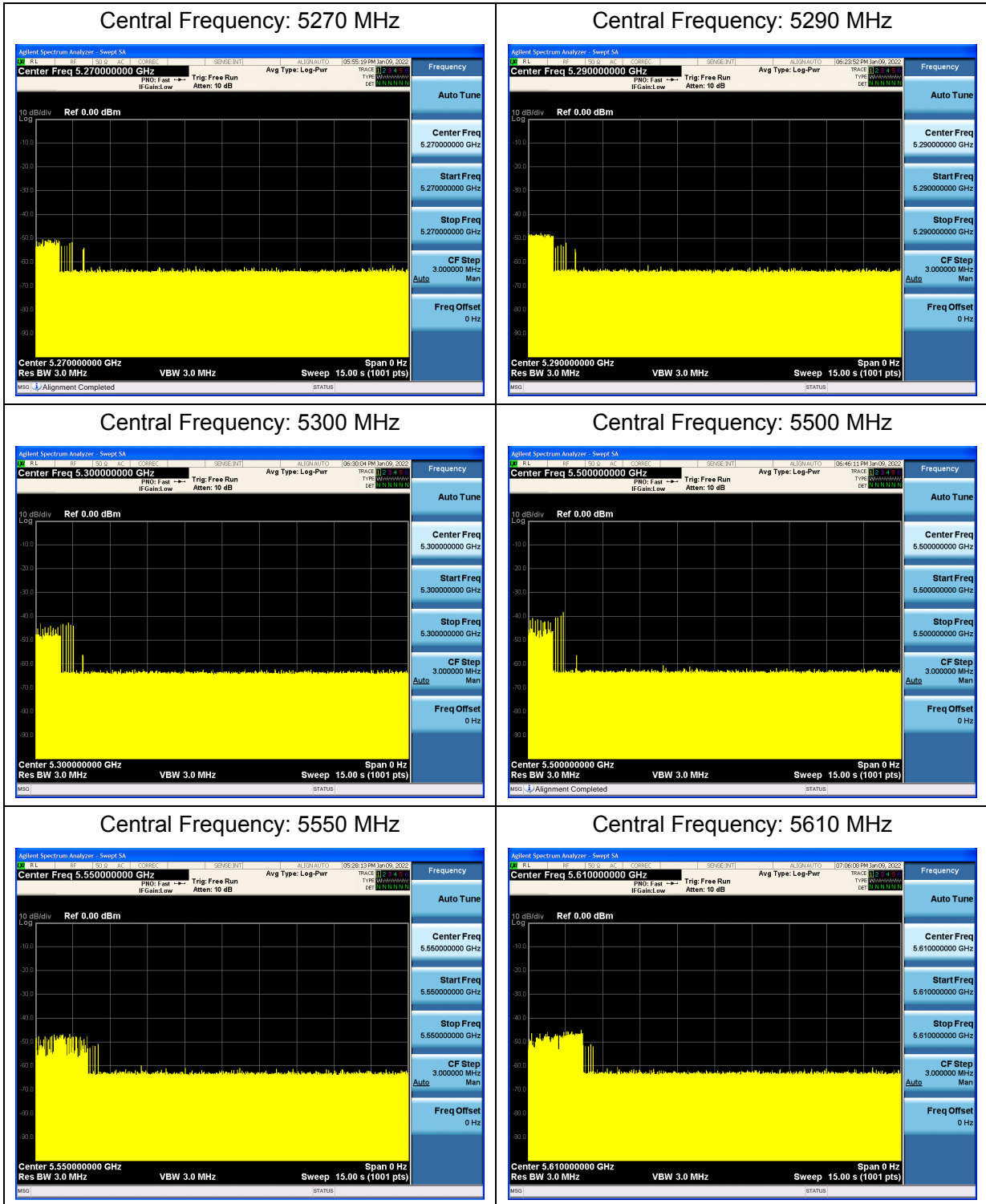



Channel Closing Transmission Time

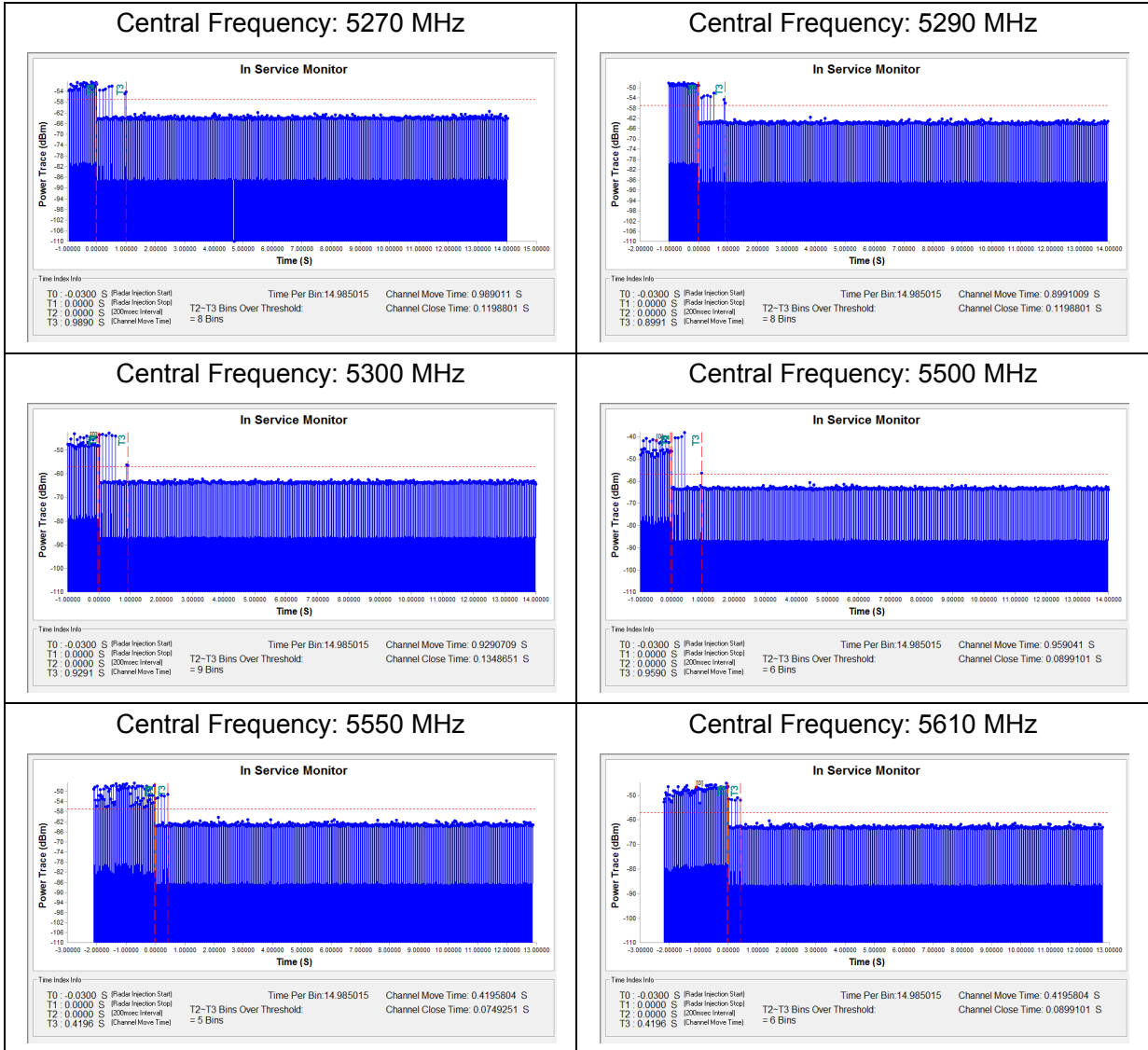



Non-Occupancy Period

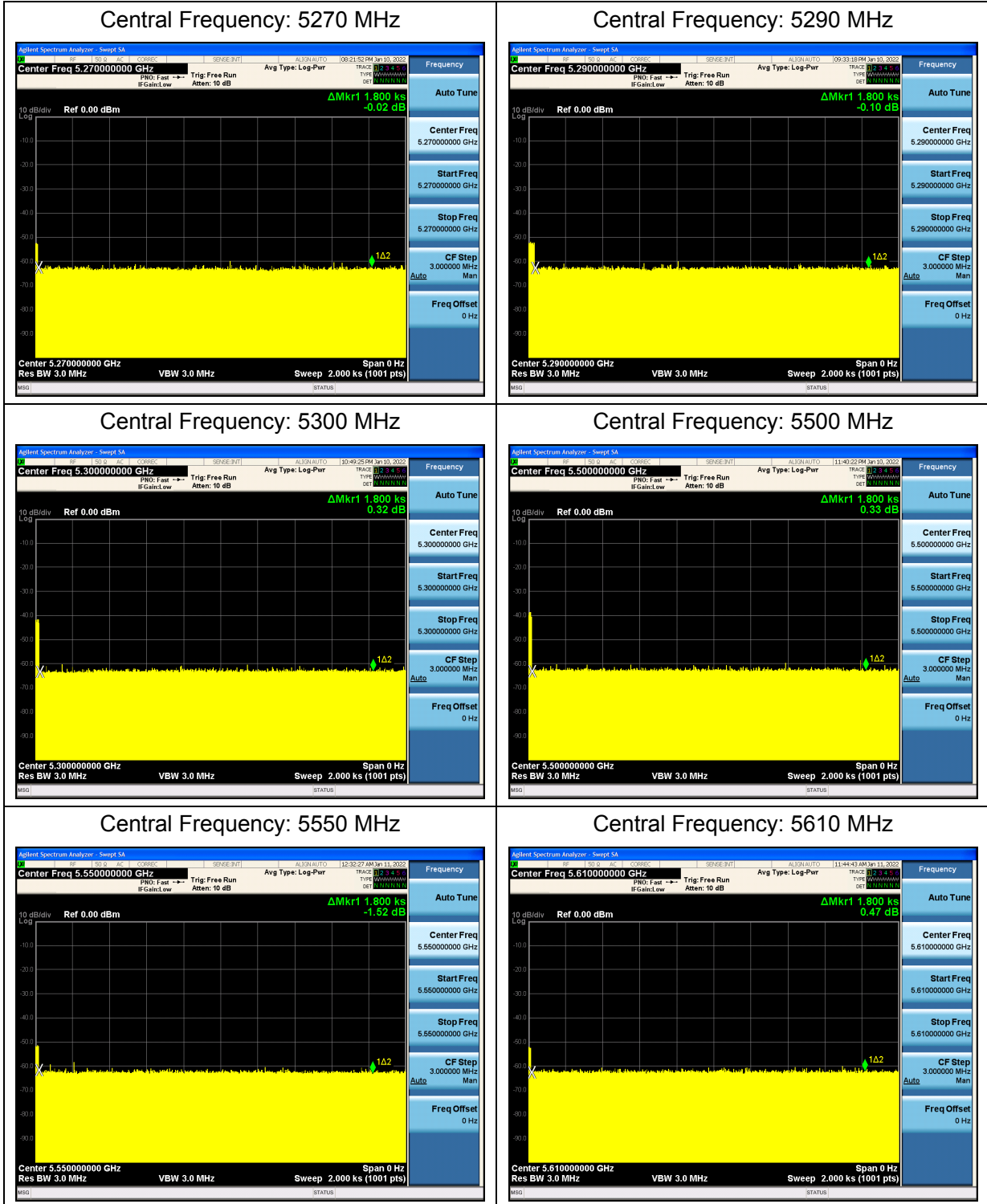



6. Main Test Instruments

Name	Manufacturer	Type	Serial Number	Calibration Date	Expiration Date
Spectrum Analyzer	Agilent	N9020A	MY52330084	2021-05-15	2022-05-14
Signal Generator	Agilent	N5182B	MY51350303	2021-05-15	2022-05-14
Splitter	UCL Microwave	2 way	UCL-PD0512-2S	/	/
RF Cable	Agilent	SMA 15cm	0001	/	/
RF Cable	Agilent	SMA 15cm	0002	/	/
RF Cable	Agilent	SMA 15cm	0003	/	/
RF Cable	Agilent	SMA 15cm	0004	/	/
Software	KEYSIGHT	N7607C	/	/	/
WLAN AP	ASUS	RT-AX82U	LBICI4000943 (FCC ID: MSQ-RTAXJ300)	/	/

*****END OF REPORT *****



ANNEX A: The EUT Appearance

The EUT Appearance are submitted separately.



ANNEX B: Test Setup Photos

The Test Setup Photos are submitted separately.