



**TABLE OF CONTENTS**

<b>1. GENERAL INFORMATION.....</b>	<b>3</b>
1.1 PRODUCT DESCRIPTION FOR EQUIPMENT UNDER TEST (EUT).....	3
1.2 TEST STANDARDS.....	4
1.3 TEST METHODOLOGY.....	4
1.4 TEST FACILITY.....	4
1.5 EUT SETUP AND TEST MODE.....	5
1.6 MEASUREMENT UNCERTAINTY.....	5
1.7 TEST EQUIPMENT LIST AND DETAILS.....	6
<b>2. SUMMARY OF TEST RESULTS.....</b>	<b>7</b>
<b>3. RF EXPOSURE.....</b>	<b>8</b>
3.1 STANDARD APPLICABLE.....	8
3.2 TEST RESULT.....	8
<b>4. ANTENNA REQUIREMENT.....</b>	<b>9</b>
4.1 STANDARD APPLICABLE.....	9
4.2 EVALUATION INFORMATION.....	9
<b>5. POWER SPECTRAL DENSITY.....</b>	<b>10</b>
5.1 STANDARD APPLICABLE.....	10
5.2 TEST PROCEDURE.....	10
5.3 ENVIRONMENTAL CONDITIONS.....	10
5.4 SUMMARY OF TEST RESULTS/PLOTS.....	11
<b>6. 6DB BANDWIDTH.....</b>	<b>24</b>
6.1 STANDARD APPLICABLE.....	24
6.2 TEST PROCEDURE.....	24
6.3 ENVIRONMENTAL CONDITIONS.....	24
6.4 SUMMARY OF TEST RESULTS/PLOTS.....	24
<b>7. RF OUTPUT POWER.....</b>	<b>38</b>
7.1 STANDARD APPLICABLE.....	38
7.2 TEST PROCEDURE.....	38
7.3 ENVIRONMENTAL CONDITIONS.....	38
7.4 SUMMARY OF TEST RESULTS/PLOTS.....	39
<b>8. FIELD STRENGTH OF SPURIOUS EMISSIONS.....</b>	<b>40</b>
8.1 MEASUREMENT UNCERTAINTY.....	40
8.2 STANDARD APPLICABLE.....	40
8.3 TEST PROCEDURE.....	40
8.4 CORRECTED AMPLITUDE & MARGIN CALCULATION.....	42
8.5 ENVIRONMENTAL CONDITIONS.....	42
8.6 SUMMARY OF TEST RESULTS/PLOTS.....	42
<b>9. OUT OF BAND EMISSIONS.....</b>	<b>58</b>
9.1 STANDARD APPLICABLE.....	58
9.2 TEST PROCEDURE.....	58
9.3 ENVIRONMENTAL CONDITIONS.....	59
9.4 SUMMARY OF TEST RESULTS/PLOTS.....	59
<b>10. CONDUCTED EMISSIONS.....</b>	<b>68</b>
10.1 MEASUREMENT UNCERTAINTY.....	68
10.2 TEST PROCEDURE.....	68
10.3 BASIC TEST SETUP BLOCK DIAGRAM.....	68
10.4 ENVIRONMENTAL CONDITIONS.....	69
10.5 TEST RECEIVER SETUP.....	70
10.6 SUMMARY OF TEST RESULTS/PLOTS.....	70
10.7 CONDUCTED EMISSIONS TEST DATA.....	70

## 1. GENERAL INFORMATION

---

### 1.1 Product Description for Equipment Under Test (EUT)

#### Client Information

Applicant: Wanjiaan Interconnected Technology Co.,Ltd.  
 Address of applicant: 2nd Floor,Incubation Building, Science Development Institute of China,High tech South 1st Street,Nanshan District,Shenzhen,518040 China

Manufacturer: Wanjiaan Interconnected Technology Co.,Ltd.  
 Address of manufacturer: 2nd Floor,Incubation Building, Science Development Institute of China,High tech South 1st Street,Nanshan District,Shenzhen,518040 China

General Description of EUT	
Product Name:	NVR WIFI
Trade Name:	RL
Model No.:	RL-SN1042-SHW-E
Adding Model(s):	RL-SN1082-SHW-E,RL-SA1041-SHW-E
Rated Voltage:	DC 12V
<i>Note: The test data is gathered from a production sample provided by the manufacturer. The appearance of others models listed in the report is different from main-test model RL-SN1042-SHW-E, but the circuit and the electronic construction do not change, declared by the manufacturer.</i>	

Technical Characteristics of EUT	
Support Standards:	802.11b, 802.11g, 802.11n
Frequency Range:	2412-2462MHz for 802.11b/g/n(HT20), 2422-2452MHz for 802.11n(HT40)
RF Output Power:	13.77dBm(MIMO)
Type of Modulation:	CCK, OFDM, QPSK, BPSK, 16QAM, 64QAM
Data Rate:	1-11Mbps, 6-54Mbps, up to 300Mbps
Channel Separation:	5MHz
Type of Antenna:	External fixed antenna
Antenna Gain:	Chain 1:0dBi, Chain 2:0dBi

## 1.2 Test Standards

The following report is prepared on behalf of the Wanjiaan Interconnected Technology Co.,Ltd. in accordance with FCC Part 15, Subpart C, and section 15.203, 15.205, 15.207, 15.209 and 15.247 of the Federal Communication Commissions rules.

The objective is to determine compliance with FCC Part 15, Subpart C, and section 15.203, 15.205, 15.207, 15.209 and 15.247 of the Federal Communication Commissions rules.

**Maintenance of compliance** is the responsibility of the manufacturer. Any modification of the product, which result in lowering the emission, should be checked to ensure compliance has been maintained.

## 1.3 Test Methodology

All measurements contained in this report were conducted with ANSI C63.10-2013, American National Standard for Testing Unlicensed Wireless Devices, and ANSI C63.4-2014, American National Standard for Methods of Measurement of Radio-Noise Emissions from Low-Voltage Electrical and Electronic Equipment in the range of 9 kHz to 40 GHz. The measurement guide KDB 558074 D01 V04 for digital transmission systems and KDB 662911 D01 Multiple Transmitter Output v02r01 shall be performed also.

## 1.4 Test Facility

BSL Testing Co.,LTD.

NO. 24, ZH Park, Nantou, Shenzhen, 518000 China

Designation Number : CN1217

Test Firm Registration Number: 866035

Tel: 86- 755-26508703

Fax: 86- 755-26508703

### 1.5 EUT Setup and Test Mode

The EUT was operated in the engineering mode to fix the Tx frequency that was for the purpose of the measurements. All testing shall be performed under maximum output power condition, and to measure its highest possible emissions level, more detailed description as follows:

Test Mode List		
Test Mode	Description	Remark
TM1	802.11b	2412MHz, 2437MHz, 2462MHz
TM2	802.11g	2412MHz, 2437MHz, 2462MHz
TM3	802.11n-HT20	2412MHz, 2437MHz, 2462MHz
TM4	802.11n-HT40	2422MHz, 2437MHz, 2452MHz
Note: All test modes (different data rate and different modulation) are performed, but only the worst case is recorded in this report.		

EUT Cable List and Details			
Cable Description	Length (m)	Shielded/Unshielded	With / Without Ferrite
/	/	/	/

Special Cable List and Details			
Cable Description	Length (m)	Shielded/Unshielded	With / Without Ferrite
/	/	/	/

Auxiliary Equipment List and Details			
Description	Manufacturer	Model	Serial Number
Notebook	Lenovo	Lenovo B490	BSTSZEMC-77
/	/	/	/

### 1.6 Measurement Uncertainty

Measurement uncertainty		
Parameter	Conditions	Uncertainty
RF Output Power	Conducted	$\pm 0.42\text{dB}$
Occupied Bandwidth	Conducted	$\pm 1.5\%$
Power Spectral Density	Conducted	$\pm 1.8\text{dB}$
Conducted Spurious Emission	Conducted	$\pm 2.17\text{dB}$
Conducted Emissions	Conducted	$\pm 2.88\text{dB}$
Transmitter Spurious Emissions	Radiated	$\pm 5.1\text{dB}$

**1.7 Test Equipment List and Details**

<b>Dscription</b>	<b>Manufacturer</b>	<b>Model</b>	<b>Serial No.</b>	<b>Cal Date</b>	<b>Due. Date</b>
Communication Tester	Rohde & Schwarz	CMW500	100358	2018-11-08	2019-11-07
Spectrum Analyzer	R&S	FSP40	100550	2018-10-08	2019-10-07
Test Receiver	R&S	ESCI7	US47140102	2018-10-08	2019-10-07
Signal Generator	HP	83630B	3844A01028	2018-10-08	2019-10-07
Test Receiver	R&S	ESPI-3	100180	2018-10-08	2019-10-07
Amplifier	Agilent	8449B	4035A00116	2018-10-08	2019-10-07
Amplifier	HP	8447E	2945A02770	2018-10-08	2019-10-07
Signal Generator	IFR	2023A	202307/242	2018-10-08	2019-10-07
Broadband Antenna	SCHAFFNER	2774	2774	2018-10-21	2019-10-20
Biconical and log periodic antennas	ELECTRO-METRICS	EM-6917B-1	171	2018-10-21	2019-10-20
Horn Antenna	R&S	HF906	100253	2018-10-21	2019-10-20
Horn Antenna	EM	EM-6961	6462	2018-10-21	2019-10-20
LISN	R&S	ESH3-Z5	100196	2018-10-08	2019-10-07
LISN	COM-POWER	LI-115	02027	2018-10-08	2019-10-07
3m Semi-Anechoic Chamber	Chengyu Electron	9 (L)*6 (W)* 6 (H)	BSL086	2018-10-08	2019-10-07
Horn Antenna	Schwarzbeck	BBHA9170	00814	2018-10-21	2019-10-20
Loop Antenna	Schwarz beck	FMZB 1519B	9773	2018-10-21	2019-10-20
power meter	DARE	RPR3006W	15I00041SNO03	2018-10-21	2019-10-20

## 2. SUMMARY OF TEST RESULTS

---

<b>FCC Rules</b>	<b>Description of Test Item</b>	<b>Result</b>
§ 2.1093	RF Exposure	Compliant
§ 15.203; § 15.247(b)(4)(i)	Antenna Requirement	Compliant
§15.205	Restricted Band of Operation	Compliant
§ 15.207(a)	Conducted Emission	Compliant
§ 15.247(e)	Power Spectral Density	Compliant
§ 15.247(a)(2)	6 dB Bandwidth	Compliant
§ 15.247(b)(3)	RF Output Power	Compliant
§ 15.209(a)	Radiated Emission	Compliant
§ 15.247(d)	Band Edge (Out of Band Emissions)	Compliant

RL: not applicable

### **3. RF Exposure**

---

#### **3.1 Standard Applicable**

According to § 1.1307(b)(1), system operating under the provisions of this section shall be operating in a manner that the public is not exposed to radio frequency energy level in excess limit for maximum permissible exposure.

#### **3.2 Test Result**

This product complied with the requirement of the RF exposure, please see the RF Exposure Report.



## 4. Antenna Requirement

---

### 4.1 Standard Applicable

According to FCC Part 15.203, an intentional radiator shall be designed to ensure that no antenna other than that furnished by the responsible party shall be used with the device. The use of a permanently attached antenna or of an antenna that uses a unique coupling to the intentional radiator shall be considered sufficient to comply with the provisions of this section.

### 4.2 Evaluation Information

This product has two External fixed antenna, they are click on the shell, fulfill the requirement of this section.



## 5. Power Spectral Density

---

### 5.1 Standard Applicable

According to 15.247(a)(1)(iii), For digitally modulated systems, the power spectral density conducted from the intentional radiator to the antenna shall not be greater than 8 dBm in any 3 kHz band during any time interval of continuous transmission.

### 5.2 Test Procedure

According to the KDB 558074 D01 V04, such specifications require that the same method as used to determine the conducted output power shall also be used to determine the power spectral density. The test method of power spectral density as below:

- a) Set instrument center frequency to DTS channel center frequency.
- b) Set span to at least 1.5 times the OBW.
- c) Set RBW to:  $3 \text{ kHz} \leq \text{RBW} \leq 100 \text{ kHz}$ .
- d) Set VBW  $\geq 3 \times \text{RBW}$ .
- e) Detector = PK
- f) Ensure that the number of measurement points in the sweep  $\geq 2 \times \text{span}/\text{RBW}$ .
- g) Sweep time = auto couple.
- h) Employ trace averaging (RMS) mode over a minimum of 100 traces.
- i) Use the peak marker function to determine the maximum amplitude level.
- j) If measured value exceeds limit, reduce RBW (no less than 3 kHz) and repeat (note that this may require zooming in on the emission of interest and reducing the span in order to meet the minimum measurement point requirement as the RBW is reduced).

### 5.3 Environmental Conditions

Temperature:	26° C
Relative Humidity:	54%
ATM Pressure:	1011 mbar

**5.4 Summary of Test Results/Plots**

Test Mode	Test Channel MHz	Power Spectral Density dBm/3kHz			Limit dBm/3kHz
		Chain 1	Chain 2	Total	
802.11b	2412	-12.71	-13.81	/	8
	2437	-12.94	-13.97	/	8
	2462	-13.14	-14.00	/	8
802.11g	2412	-16.28	-18.10	/	8
	2437	-17.54	-18.58	/	8
	2462	-17.70	-18.30	/	8
802.11n HT20	2412	-18.63	-19.18	-15.886	8
	2437	-18.92	-20.43	-16.599	8
	2462	-18.77	-19.88	-16.279	8
802.11n HT40	2422	-20.03	-22.48	-18.074	8
	2437	-20.11	-21.89	-17.899	8
	2452	-22.06	-22.88	-19.440	8

Note:

1. Limit=8dBm/MHz

2. The Total PSD Level =  $10 \cdot \log\{10^{(\text{chain 1 PSD}/10)} + 10^{(\text{chain 2 PSD}/10)}\}$

Please refer to the following test plots:

Chain 1:

802.11b-Low Channel

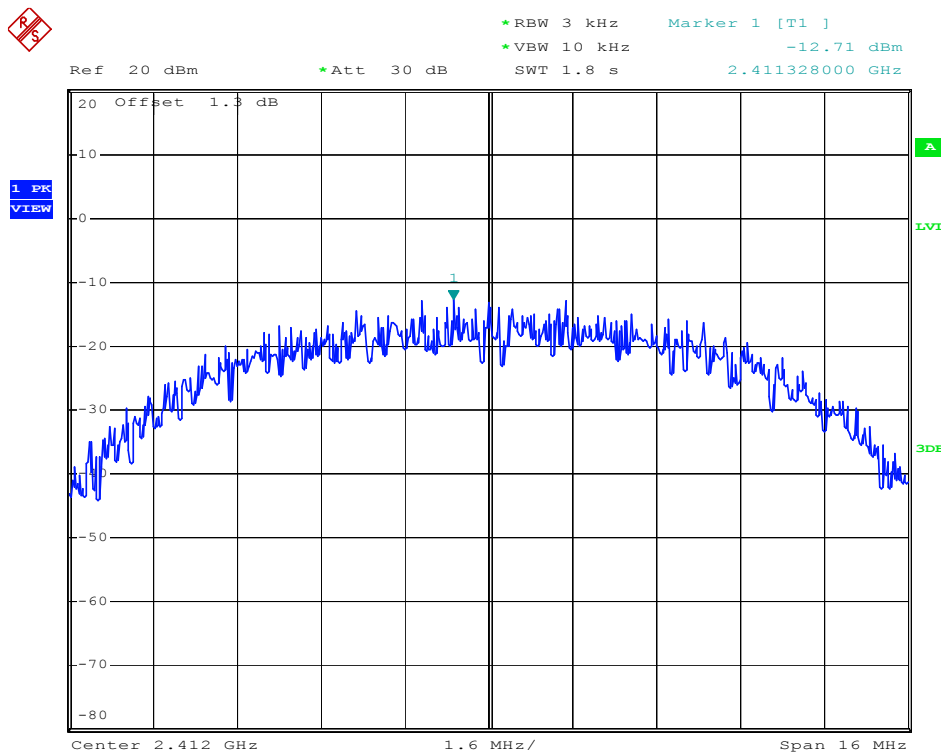

802.11b-Middle Channel

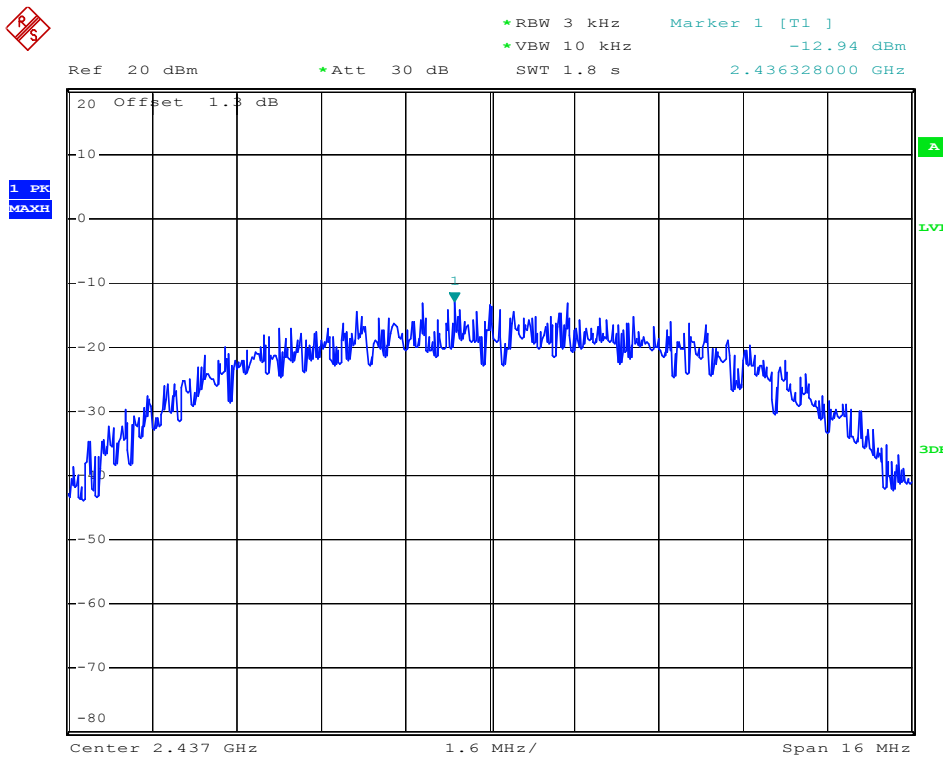

802.11b-High Channel

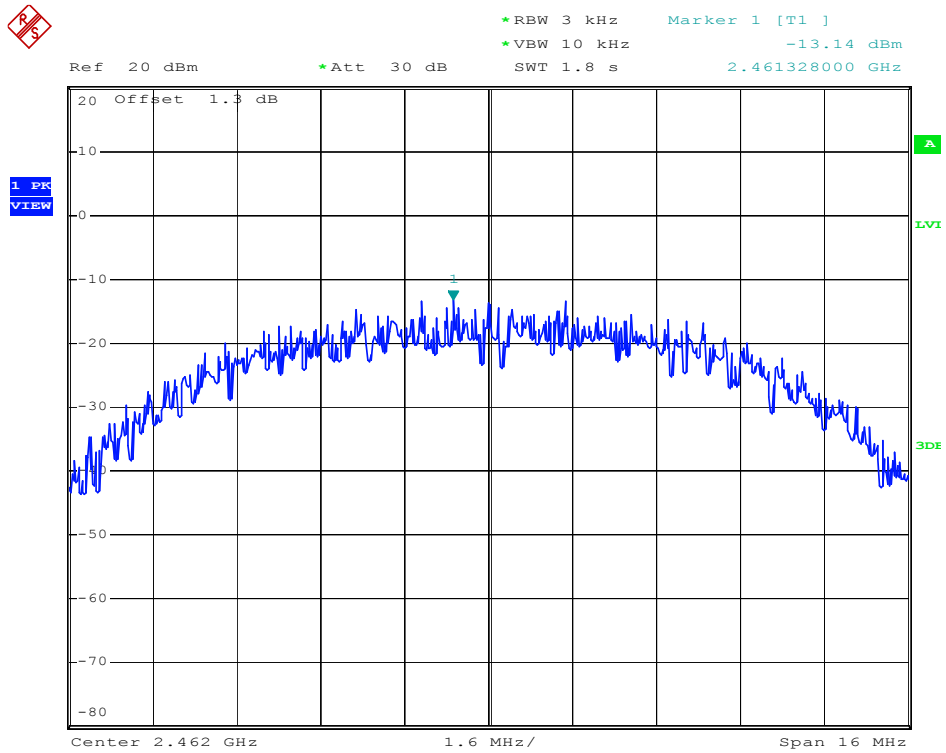

802.11g-Low Channel

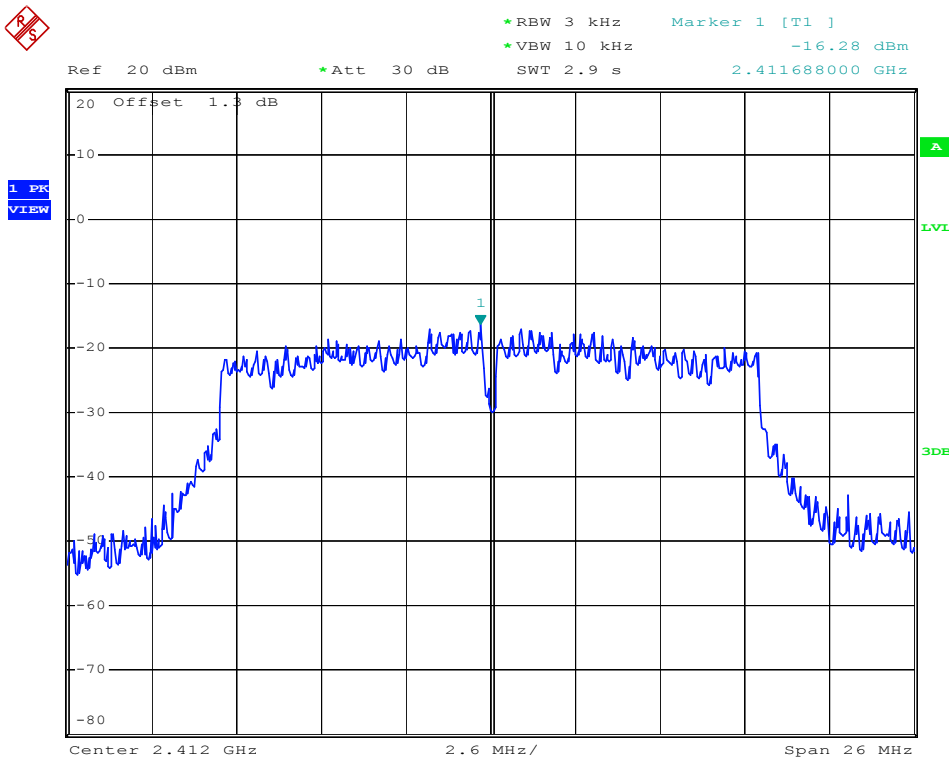

802.11g-Middle Channel

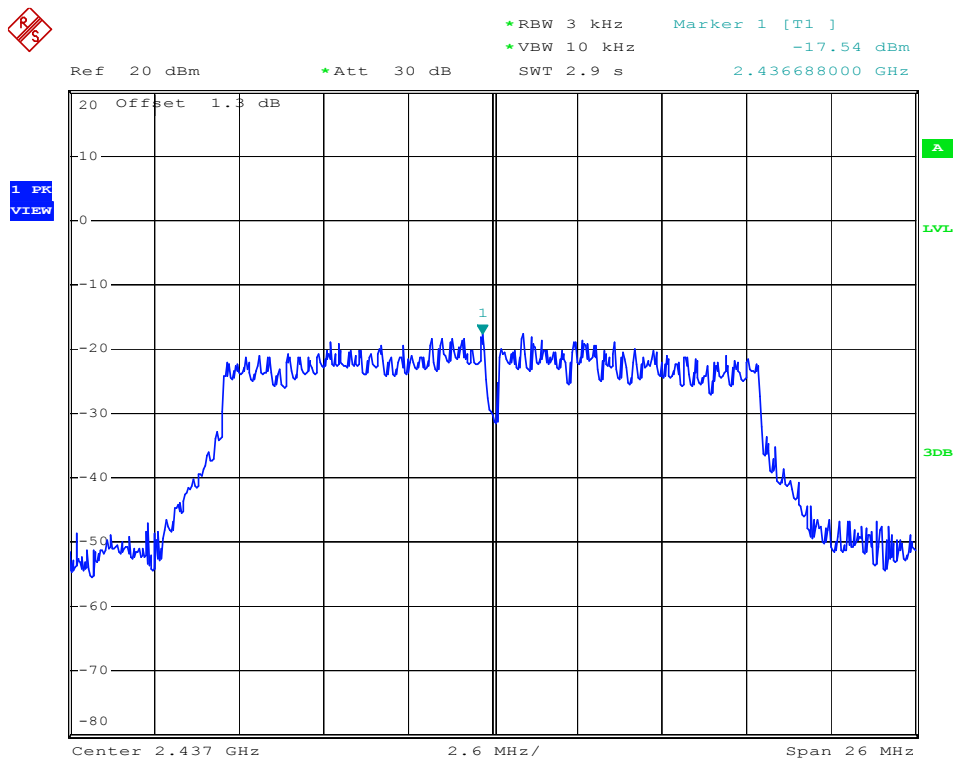

802.11g-High Channel

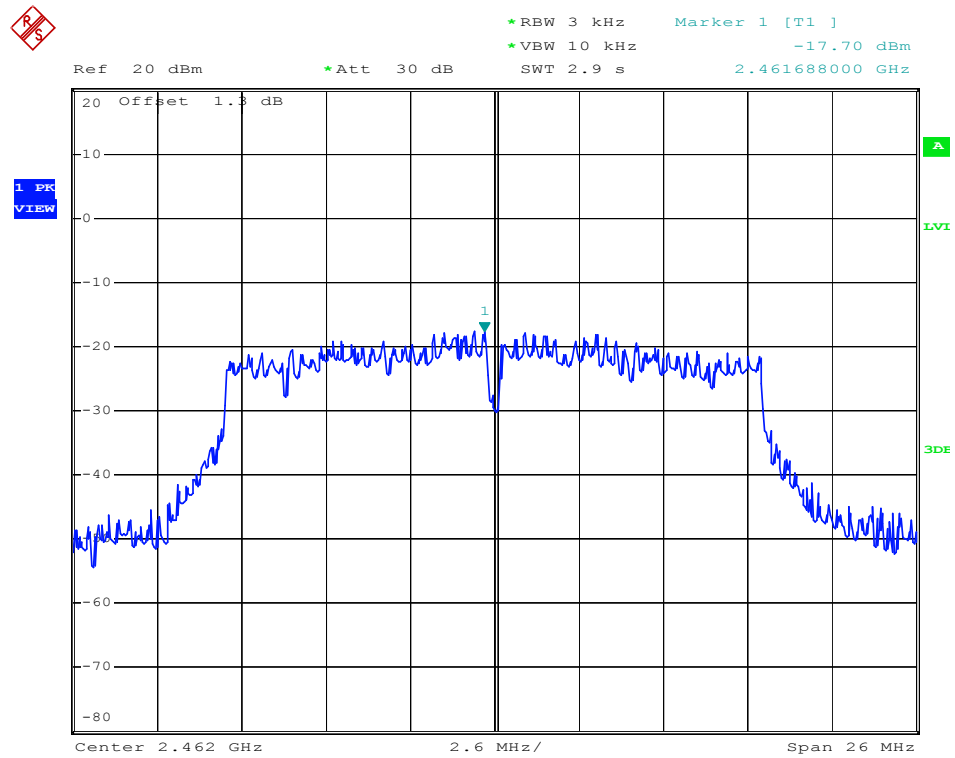

802.11n-HT20-Low Channel

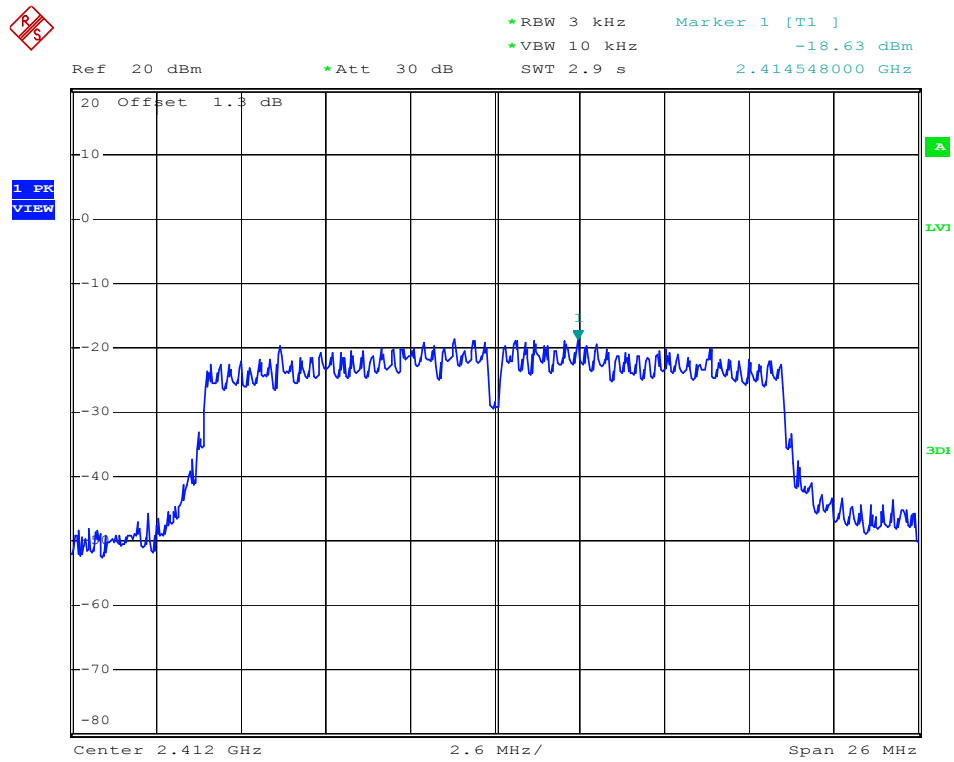

802.11n-HT20-Middle Channel

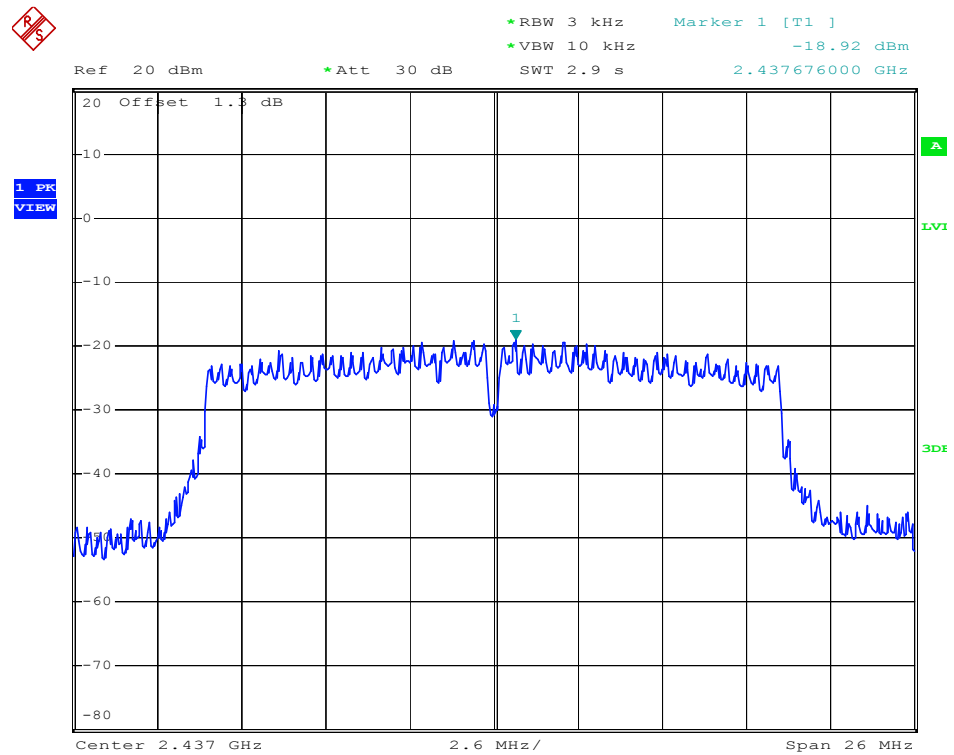

802.11n-HT20-High Channel

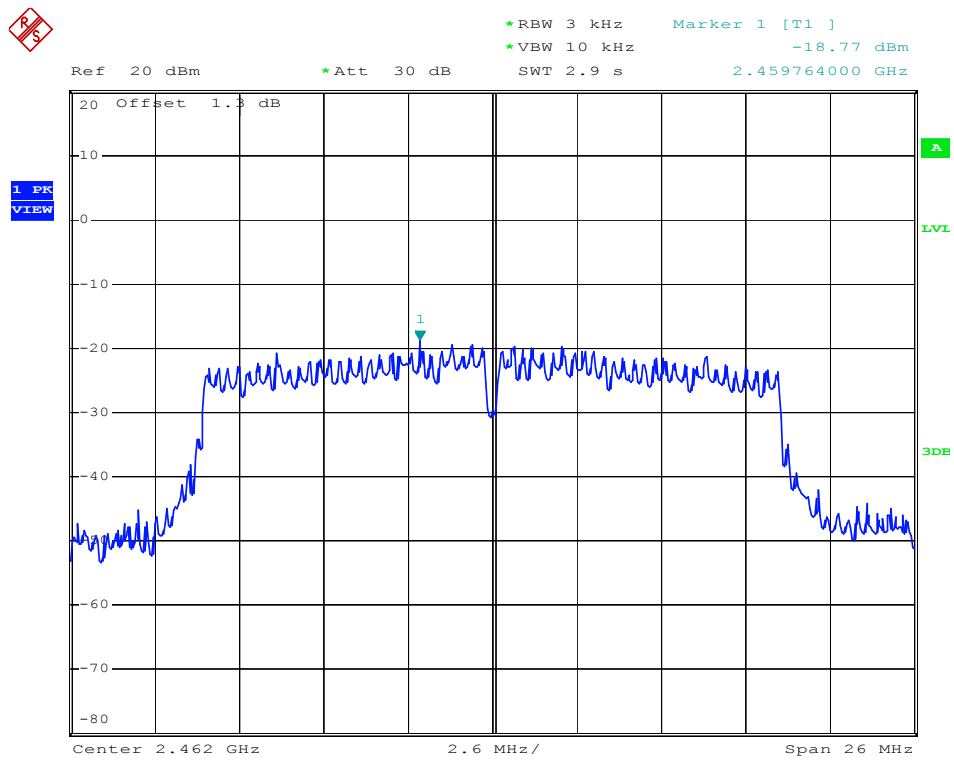

802.11n-HT40-Low Channel

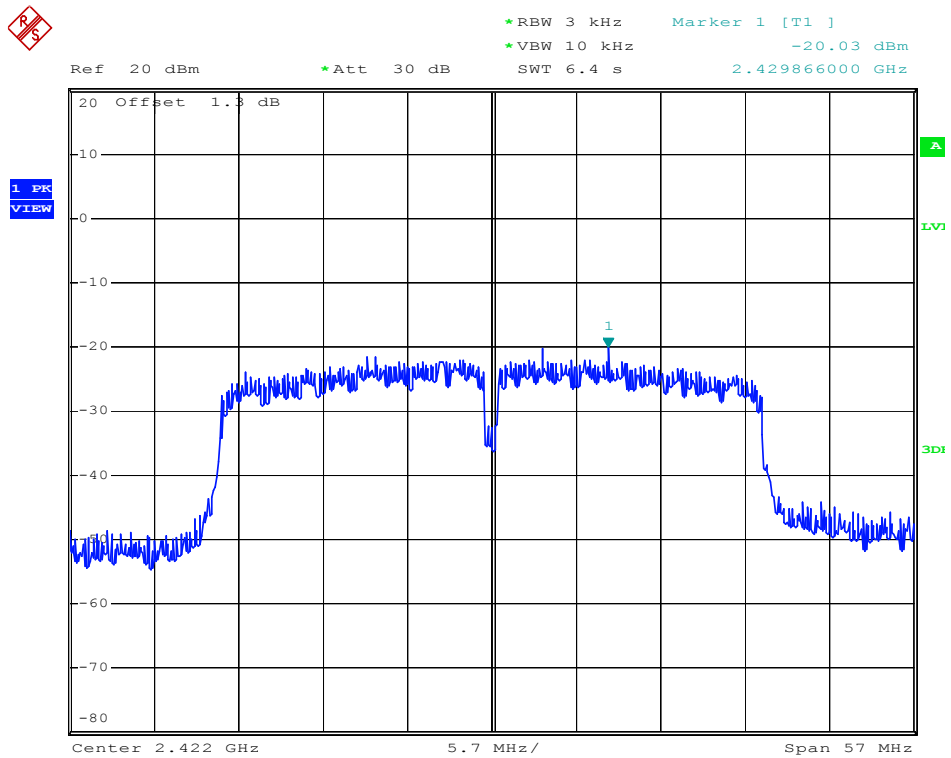



802.11n-HT40-Middle Channel

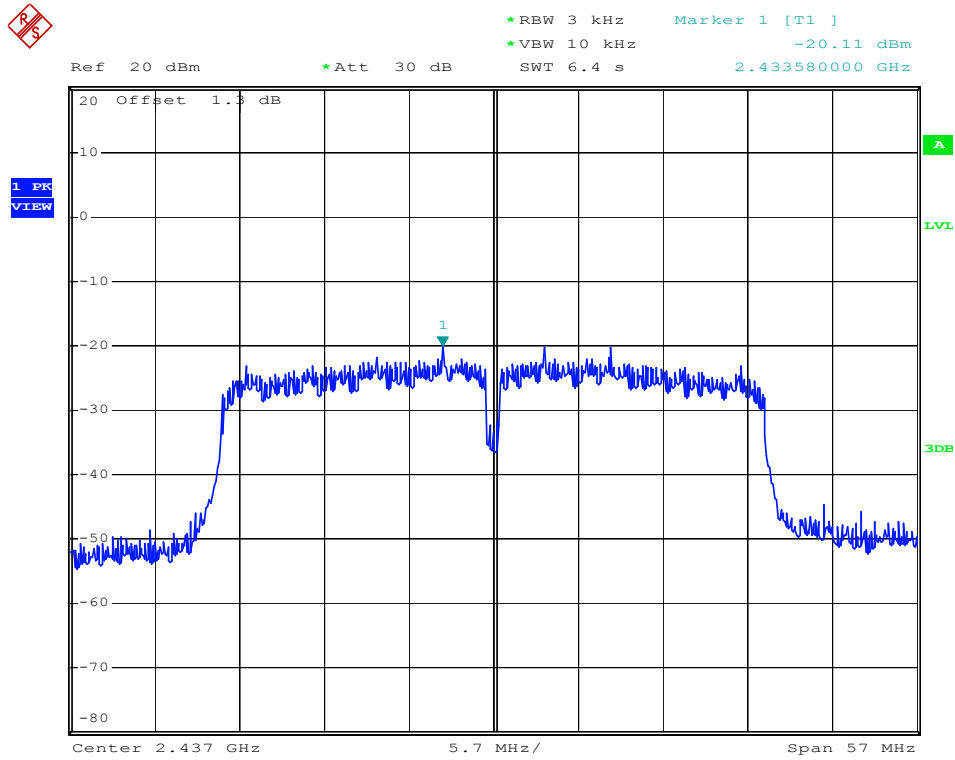

802.11n-HT40-High Channel

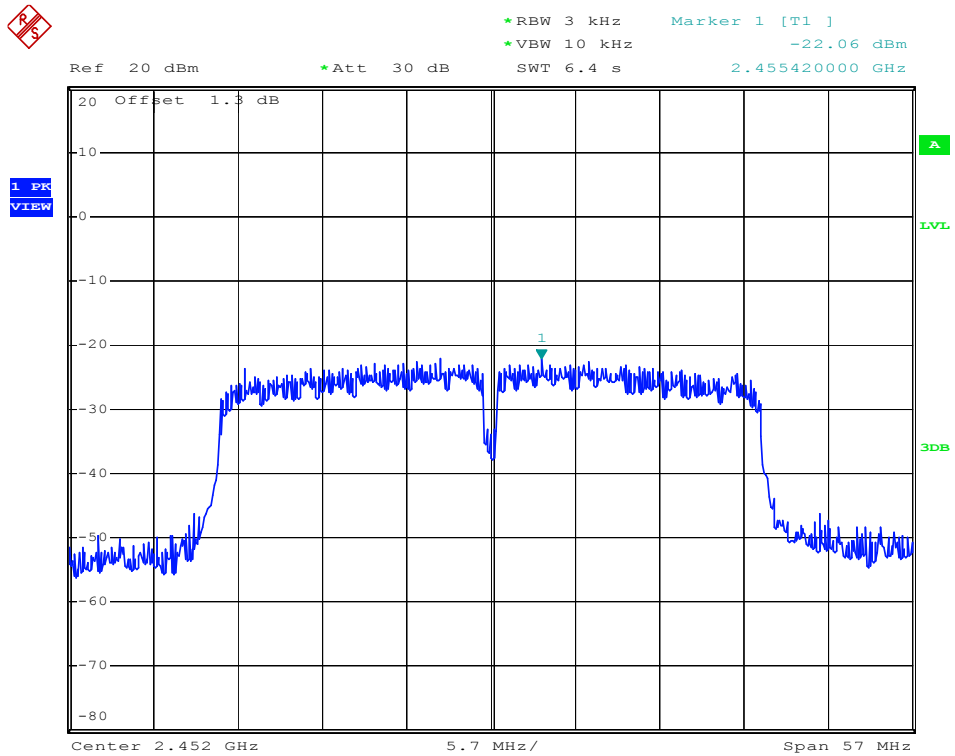

**Chain 2**

802.11b-Low Channel

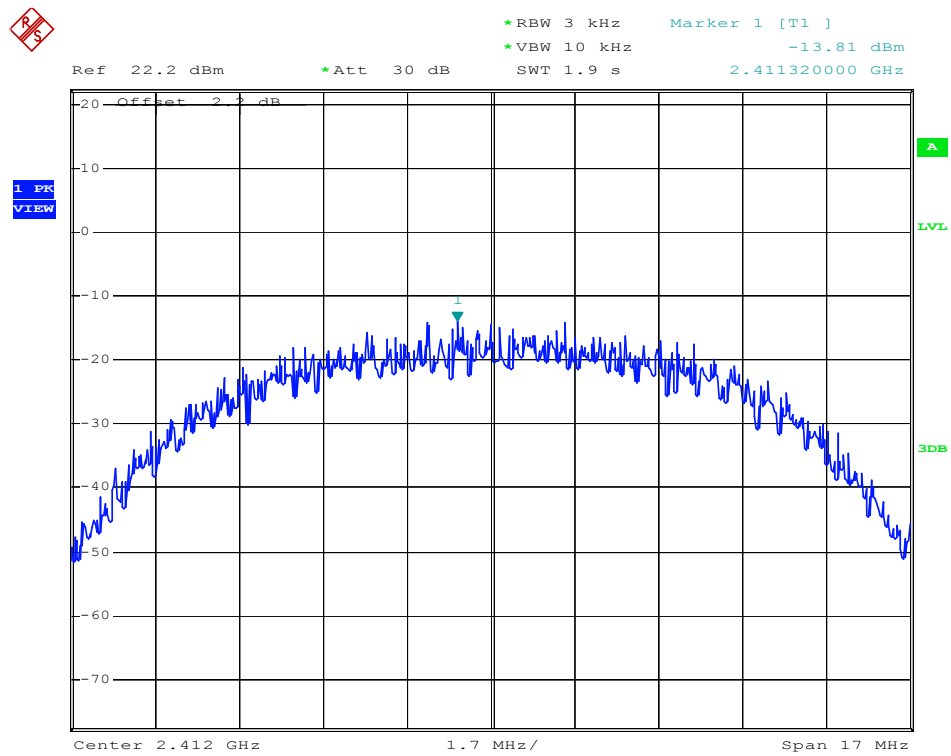

802.11b-Middle Channel

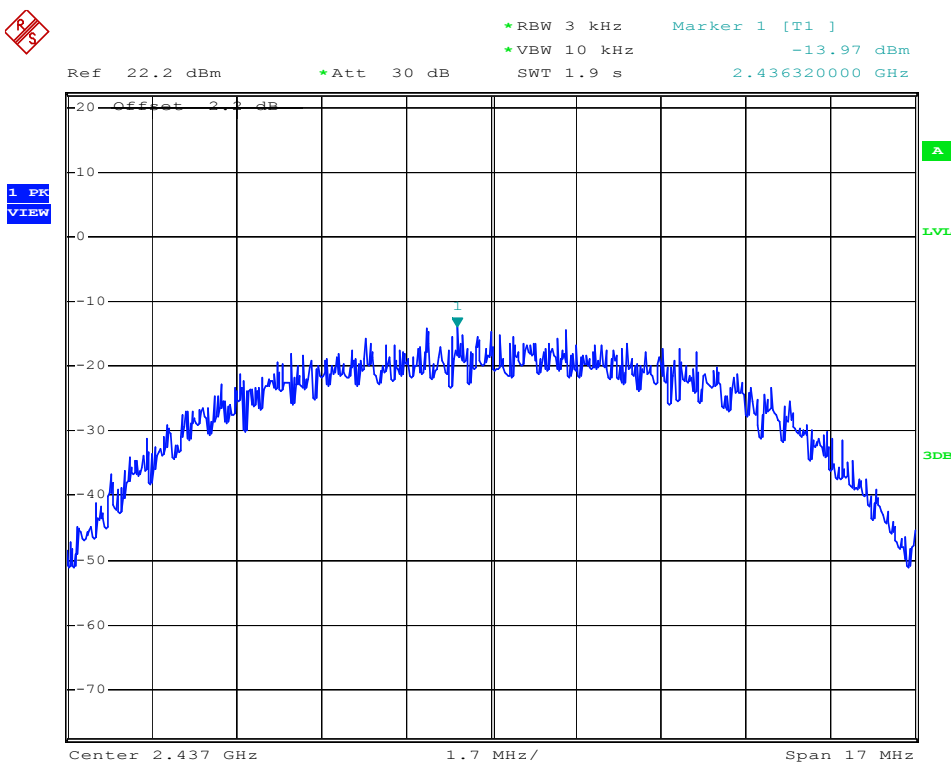

802.11b-High Channel

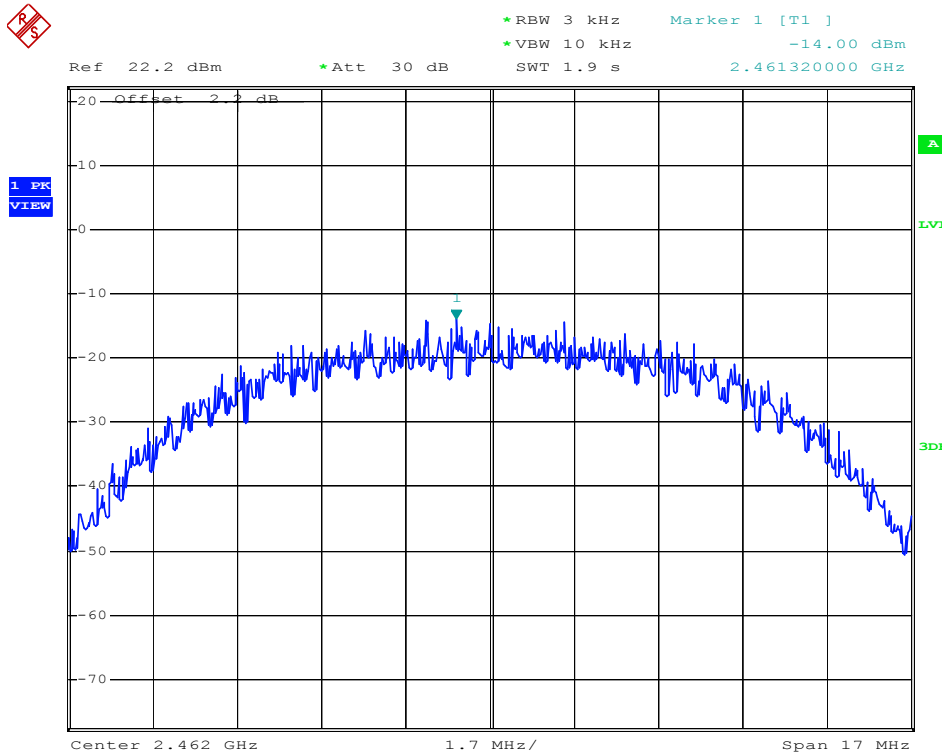

802.11g-Low Channel

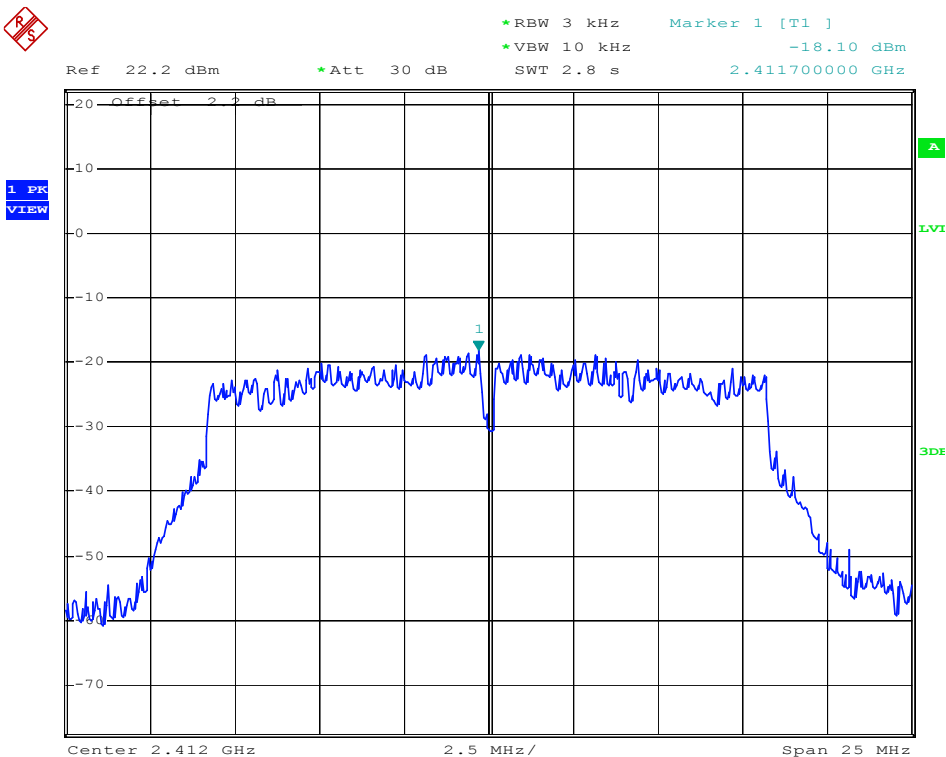

802.11g-Middle Channel

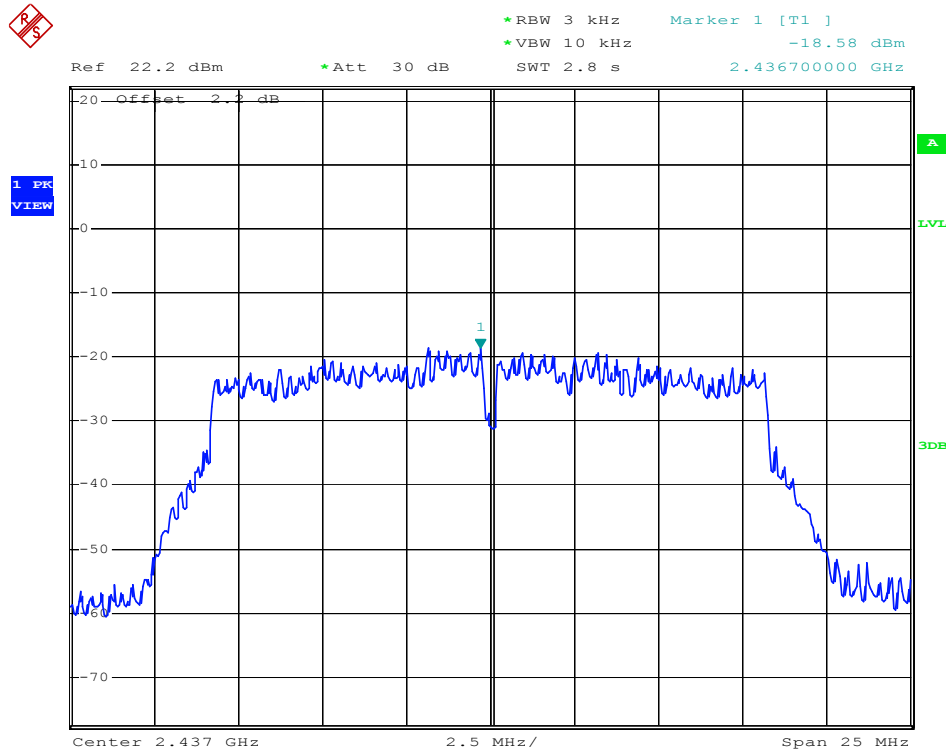

802.11g-High Channel

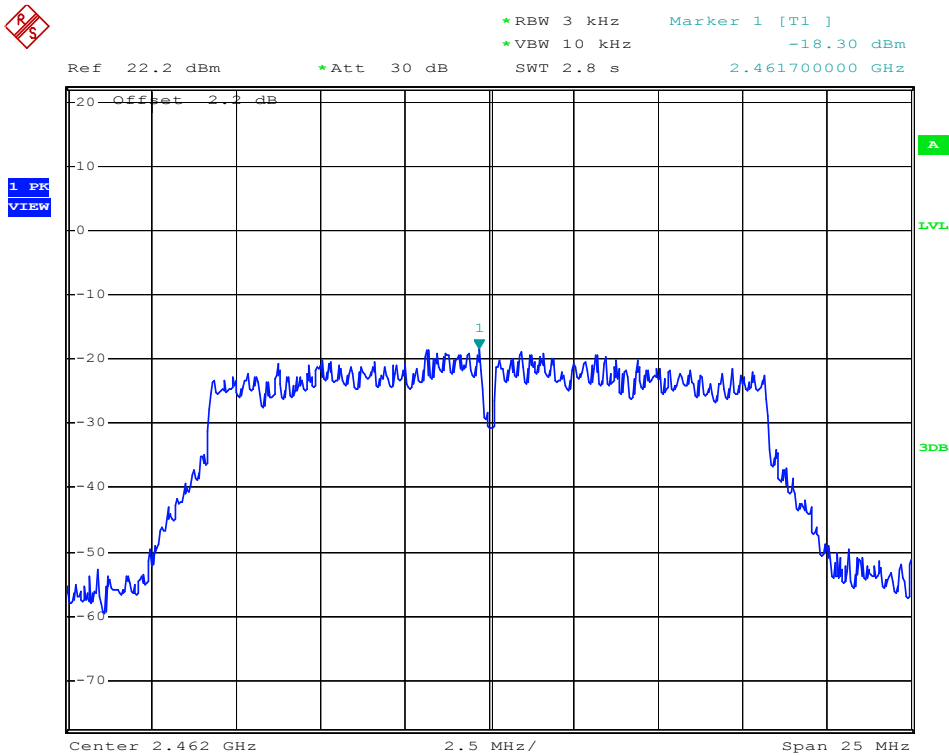

802.11n-HT20-Low Channel

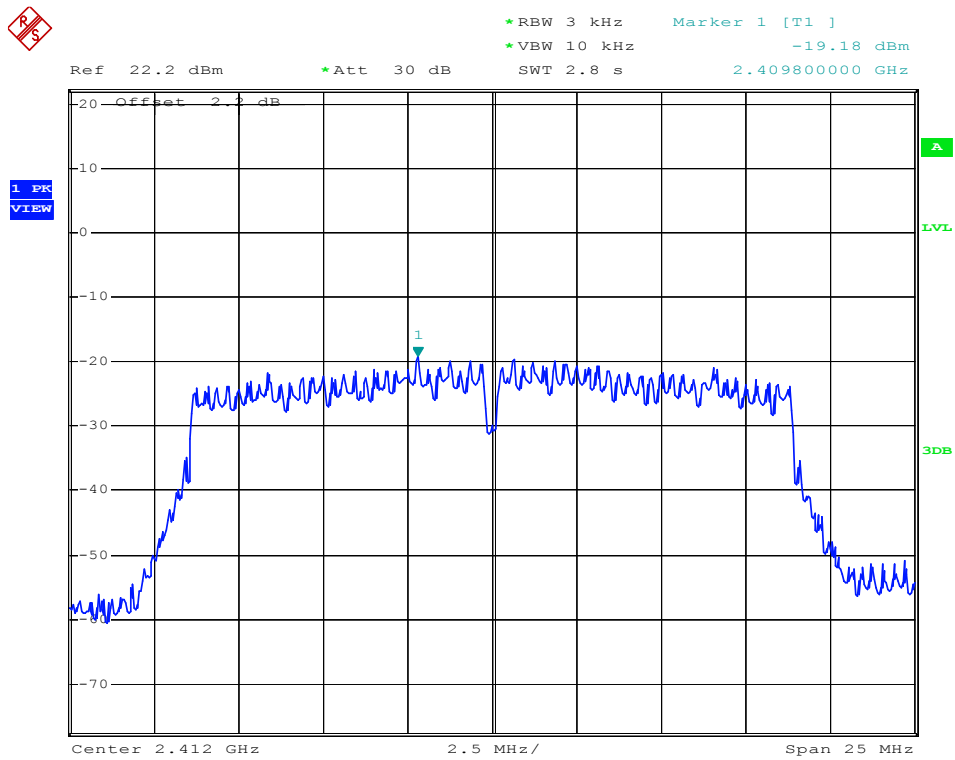

802.11n-HT20-Middle Channel

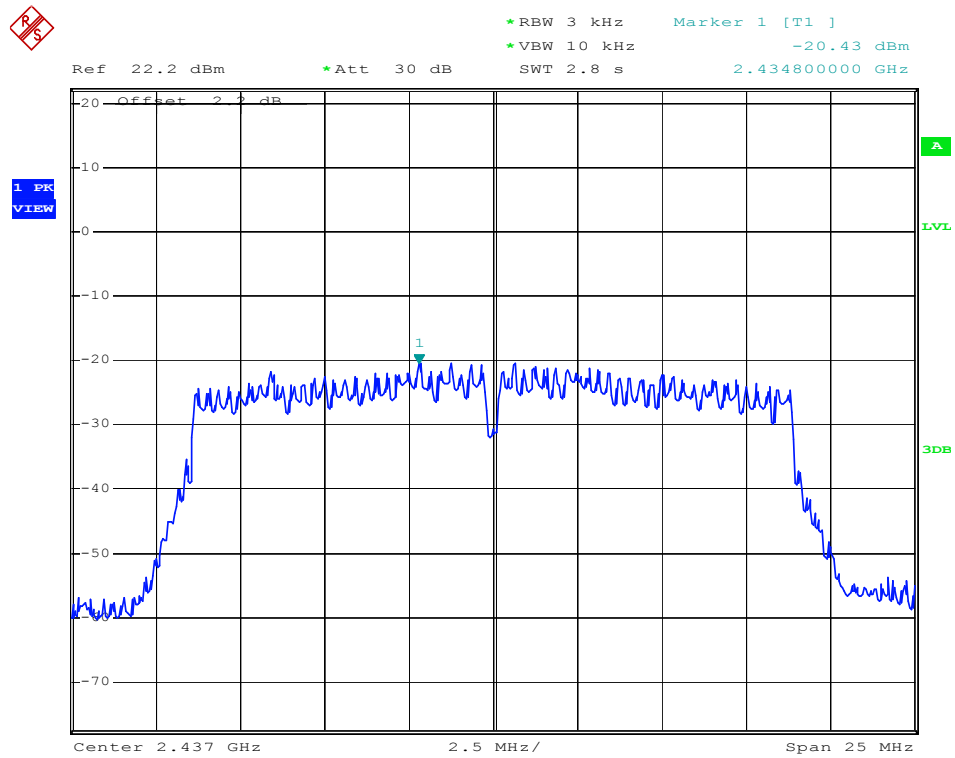

802.11n-HT20-High Channel

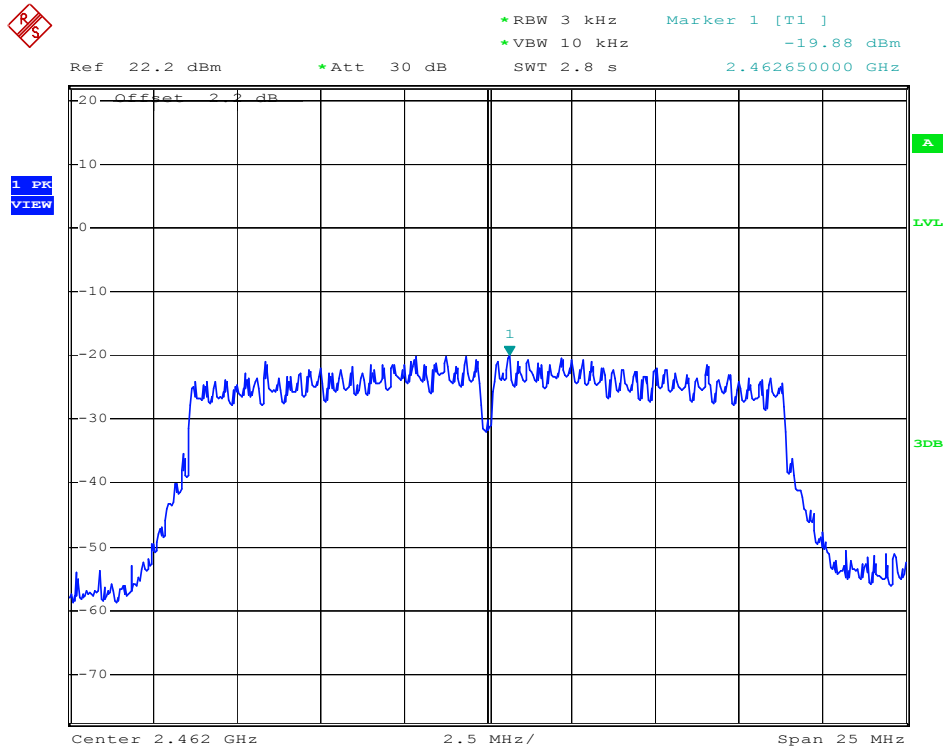

802.11n-HT40-Low Channel

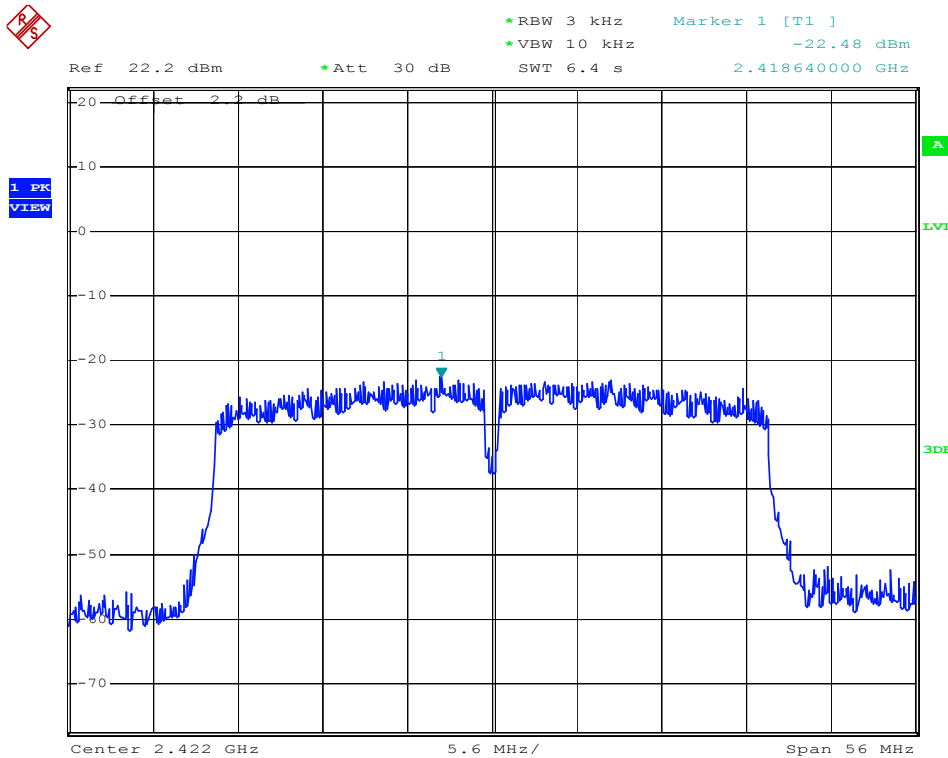

802.11n-HT40-Middle Channel

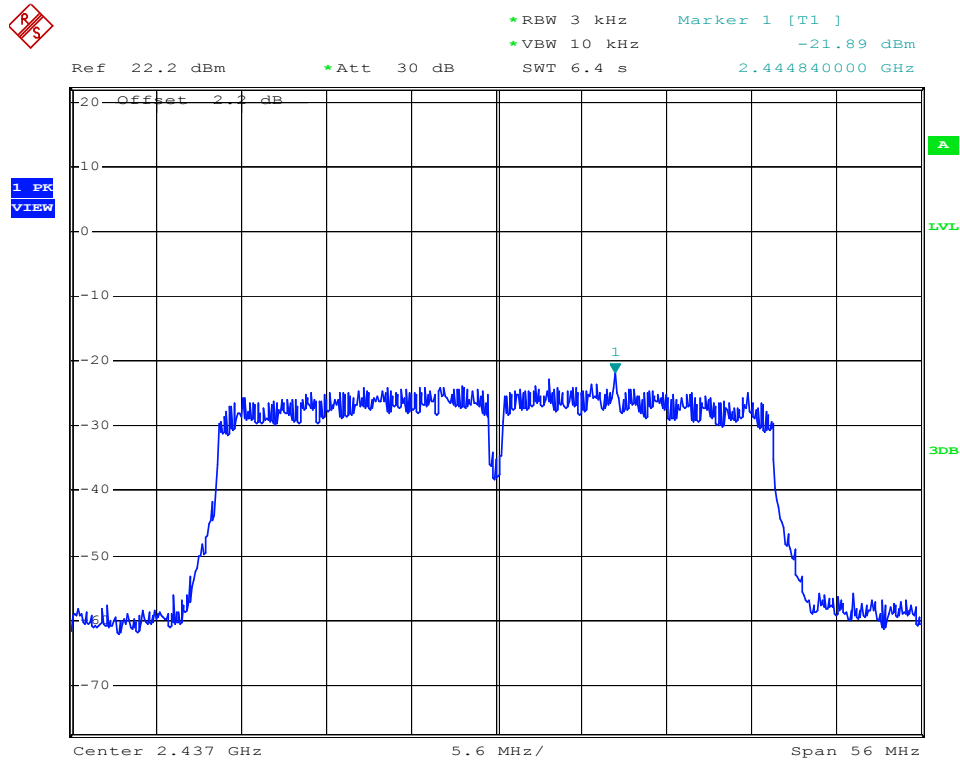

802.11n-HT40-High Channel

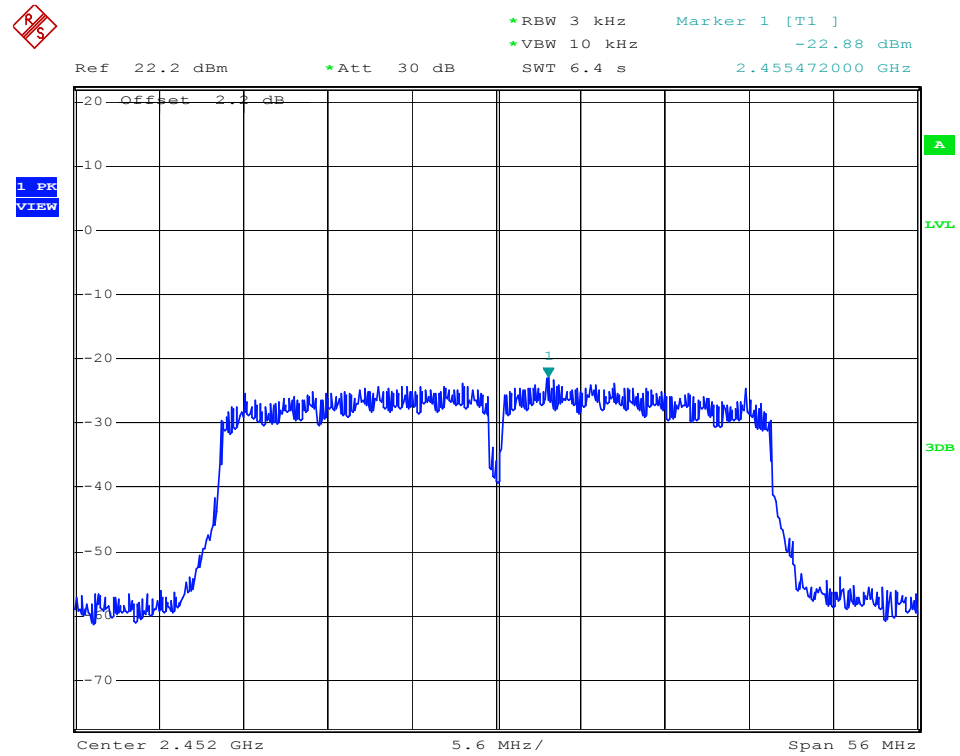

## 6. 6dB Bandwidth

---

### 6.1 Standard Applicable

According to 15.247(a)(2). Systems using digital modulation techniques may operate in the 902–928 MHz, 2400–2483.5 MHz, and 5725–5850 MHz bands. The minimum 6 dB bandwidth shall be at least 500 kHz.

### 6.2 Test Procedure

- a) Set RBW = 100 kHz.
- b) Set the video bandwidth (VBW)  $\geq 3 \times$  RBW.
- c) Detector = Peak.
- d) Trace mode = max hold.
- e) Sweep = auto couple.
- f) Allow the trace to stabilize.
- g) Measure the maximum width of the emission that is constrained by the frequencies associated with the two outermost amplitude points (upper and lower frequencies) that are attenuated by 6 dB relative to the maximum level measured in the fundamental emission.

### 6.3 Environmental Conditions

Temperature:	25° C
Relative Humidity:	53%
ATM Pressure:	1018 mbar

### 6.4 Summary of Test Results/Plots



**Chain 1:**

Test Mode	Test Channel MHz	6 dB Bandwidth MHz	Limit kHz
802.11b	2412	9.480	≥500
	2437	9.480	≥500
	2462	9.240	≥500
802.11g	2412	16.560	≥500
	2437	16.560	≥500
	2462	16.560	≥500
802.11n-HT20	2412	17.640	≥500
	2437	17.700	≥500
	2462	17.700	≥500
802.11n-HT40	2422	36.400	≥500
	2437	36.400	≥500
	2452	36.376	≥500

**Chain 2:**

Test Mode	Test Channel MHz	6 dB Bandwidth MHz	Limit kHz
802.11b	2412	9.240	≥500
	2437	9.520	≥500
	2462	9.480	≥500
802.11g	2412	16.560	≥500
	2437	16.560	≥500
	2462	16.560	≥500
802.11n-HT20	2412	17.760	≥500
	2437	17.700	≥500
	2462	17.700	≥500
802.11n-HT40	2422	36.400	≥500
	2437	36.400	≥500
	2452	36.376	≥500

Please refer to the following test plots:

**Chain 1**

802.11b-Low Channel

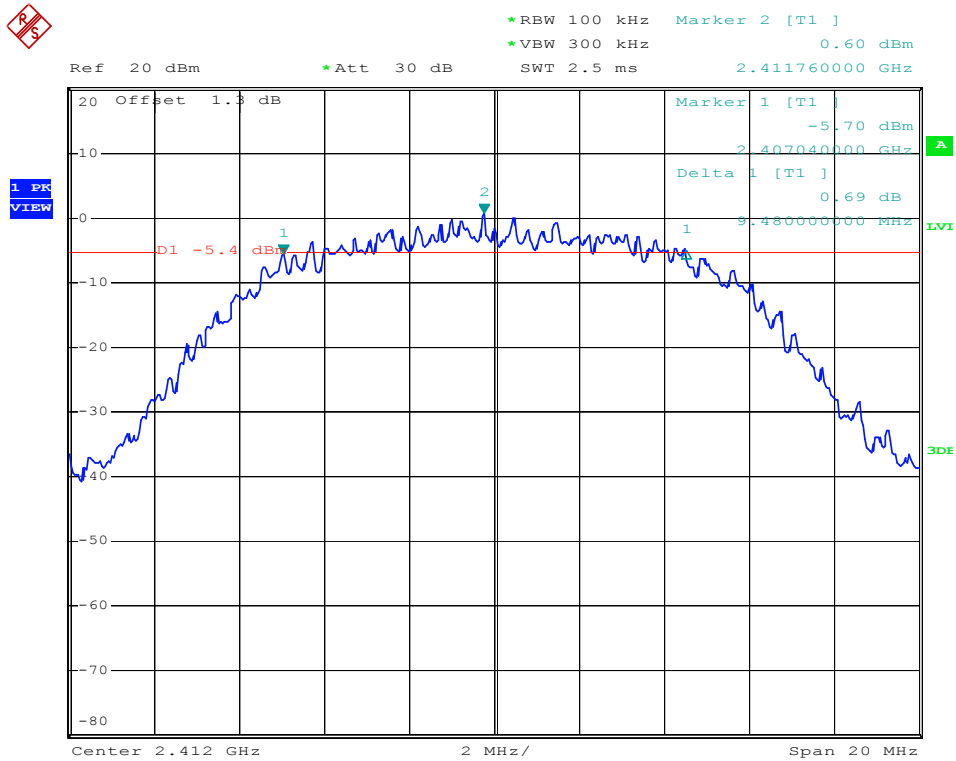

802.11b-Middle Channel

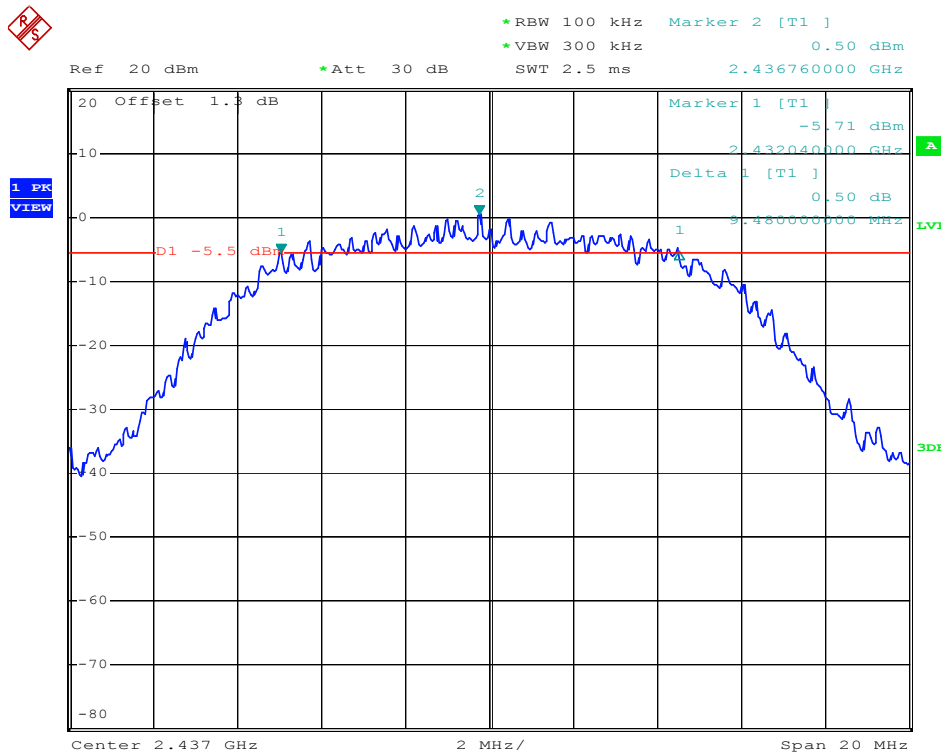

802.11b-High Channel

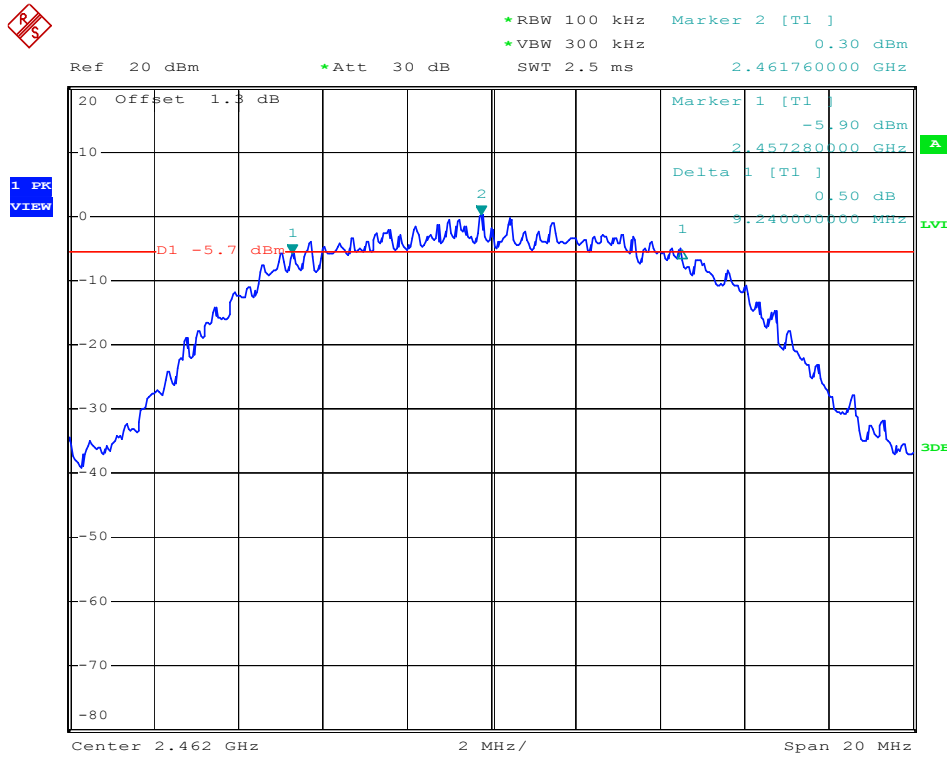

802.11g-Low Channel

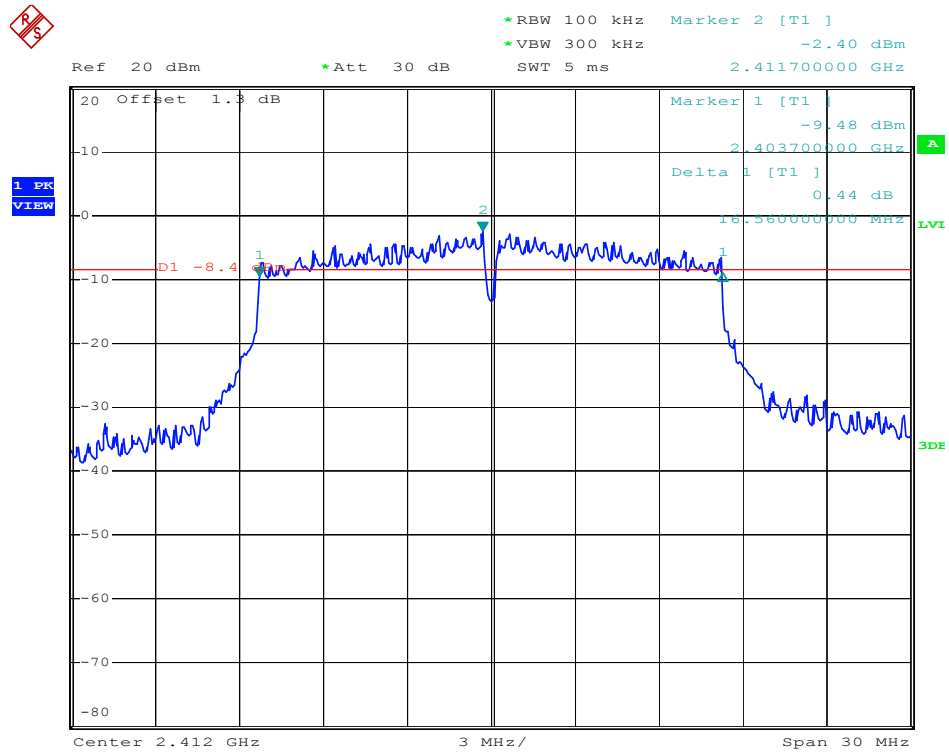

802.11g-Middle Channel

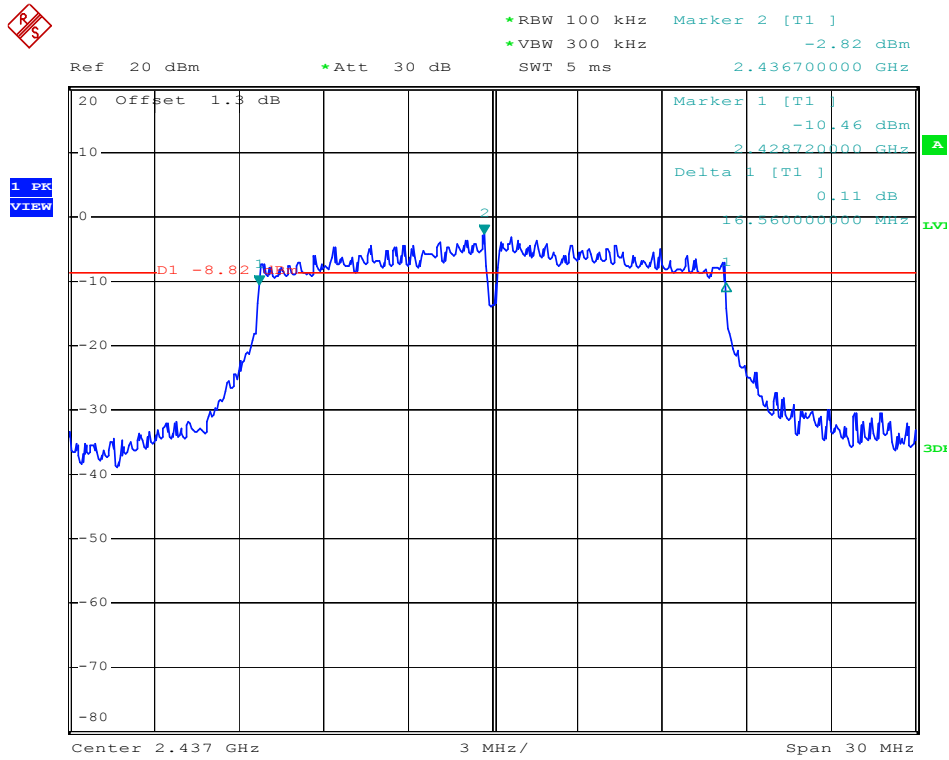

802.11g-High Channel

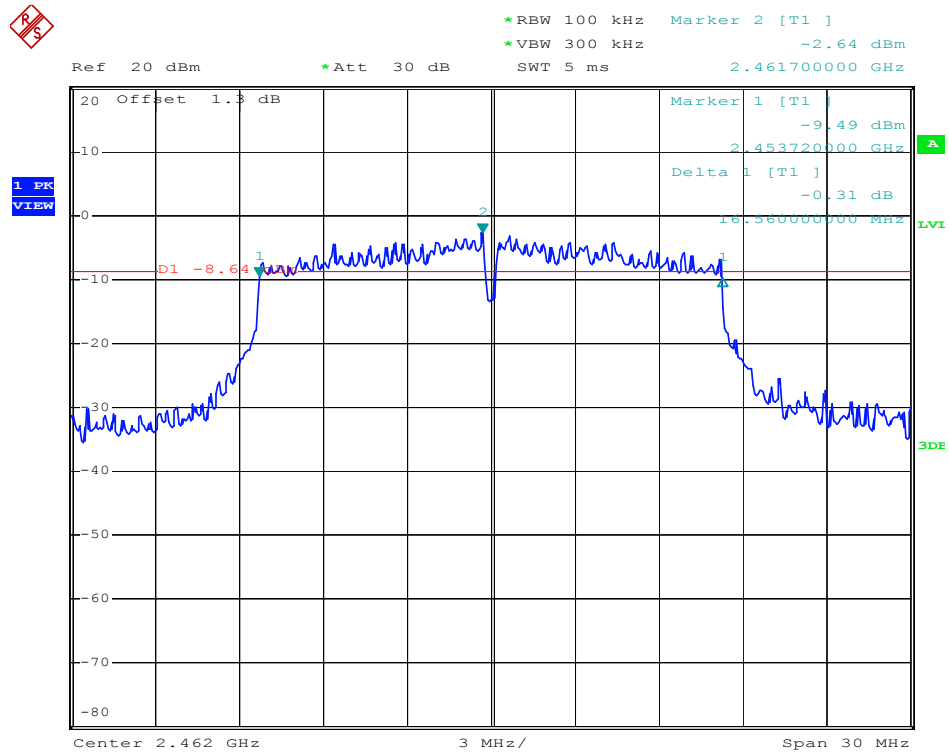

802.11n-HT20-Low Channel

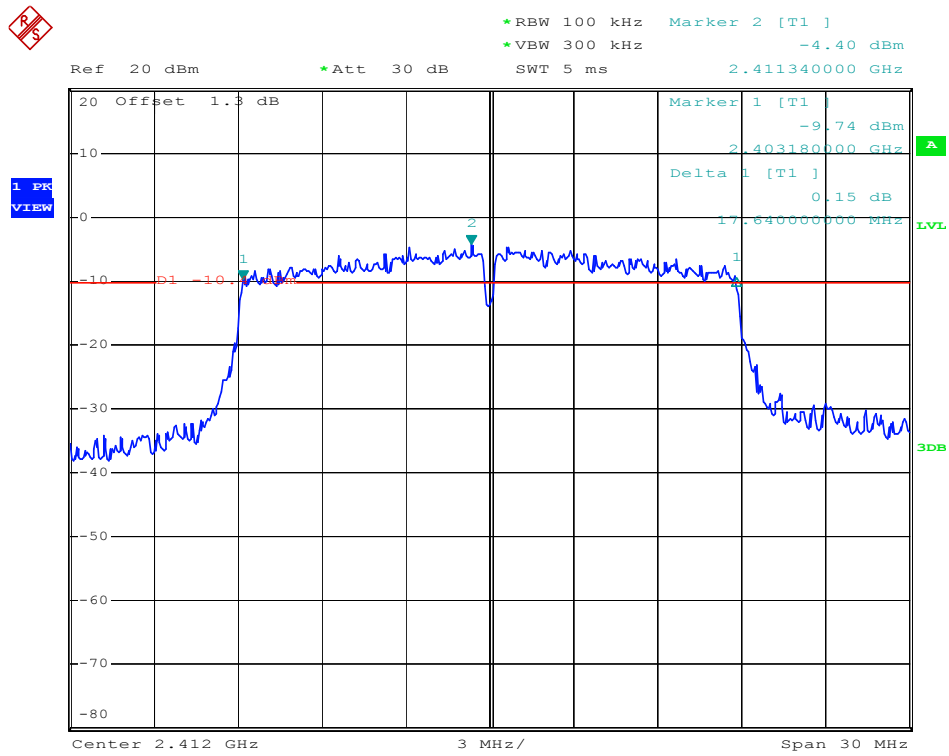

802.11n-HT20-Middle Channel

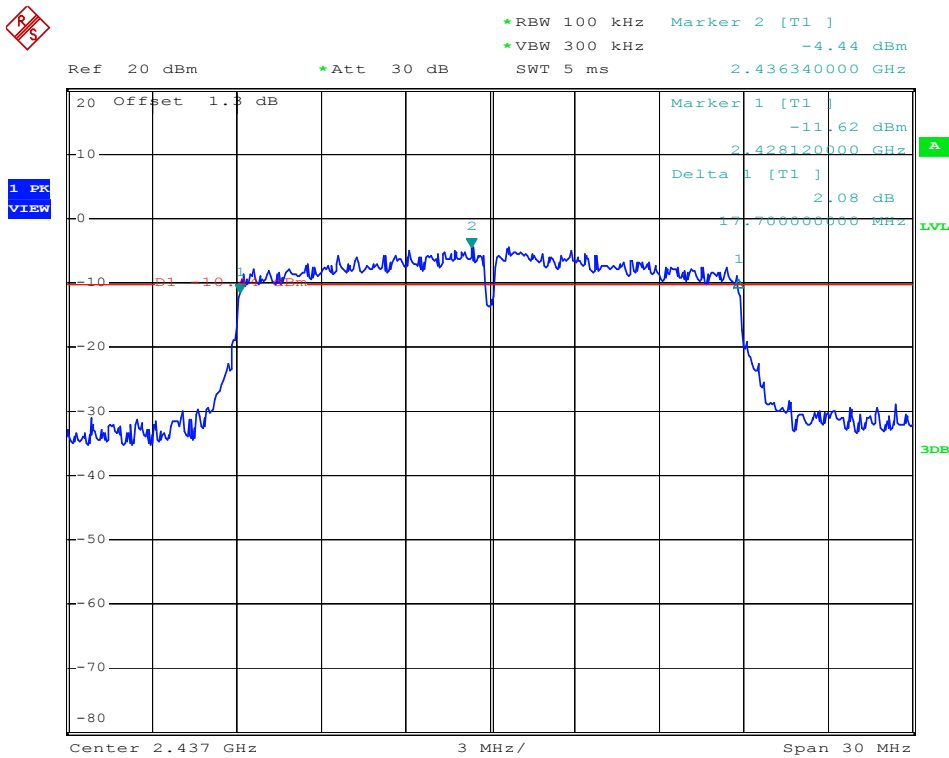

802.11n-HT20-High Channel

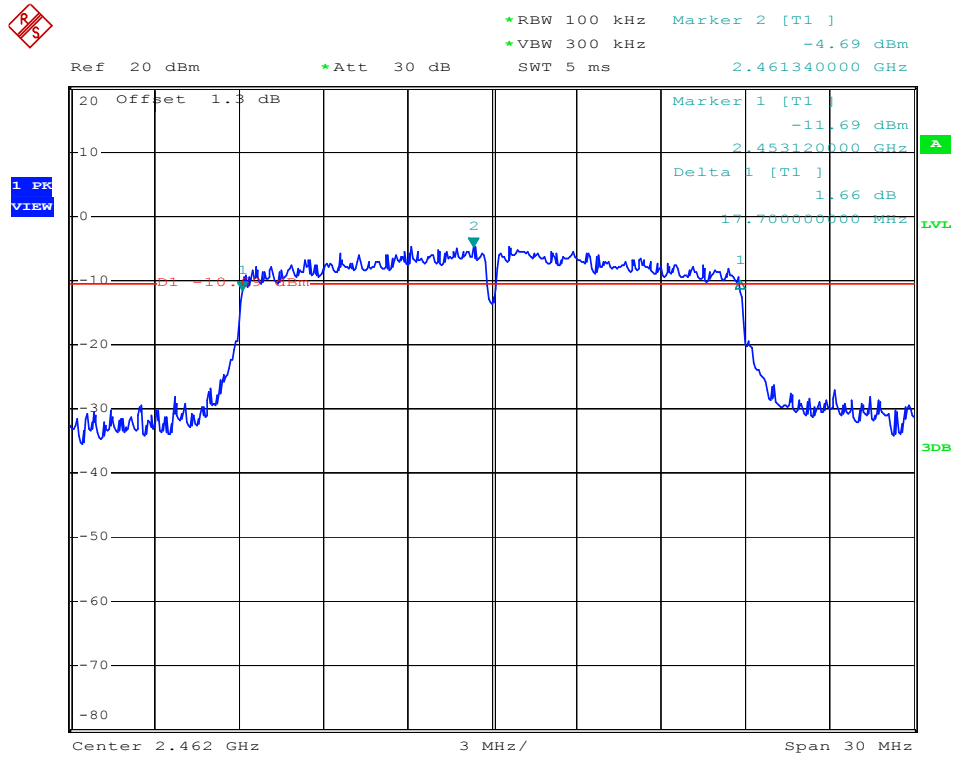

802.11n-HT40-Low Channel

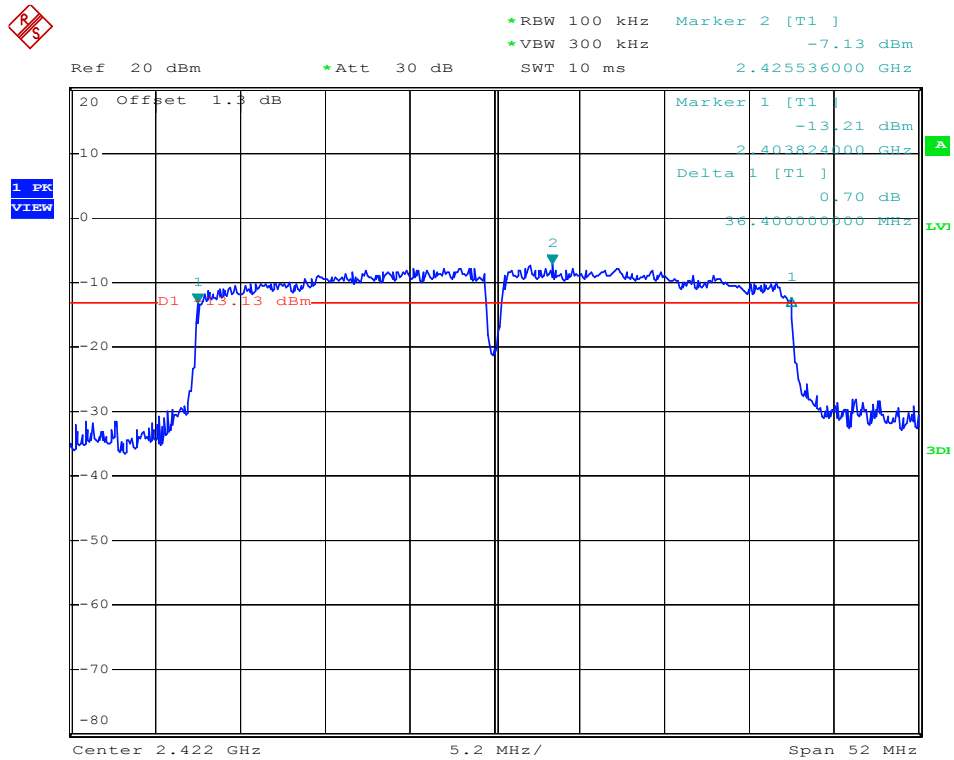

802.11n-HT40-Middle Channel

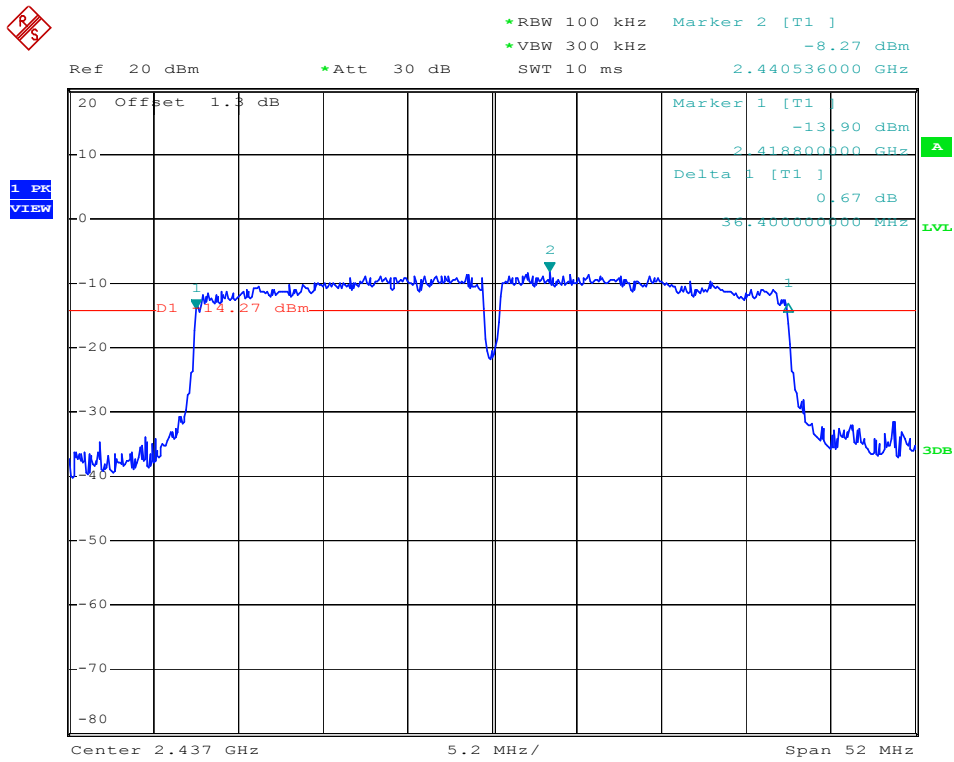

802.11n-HT40-High Channel

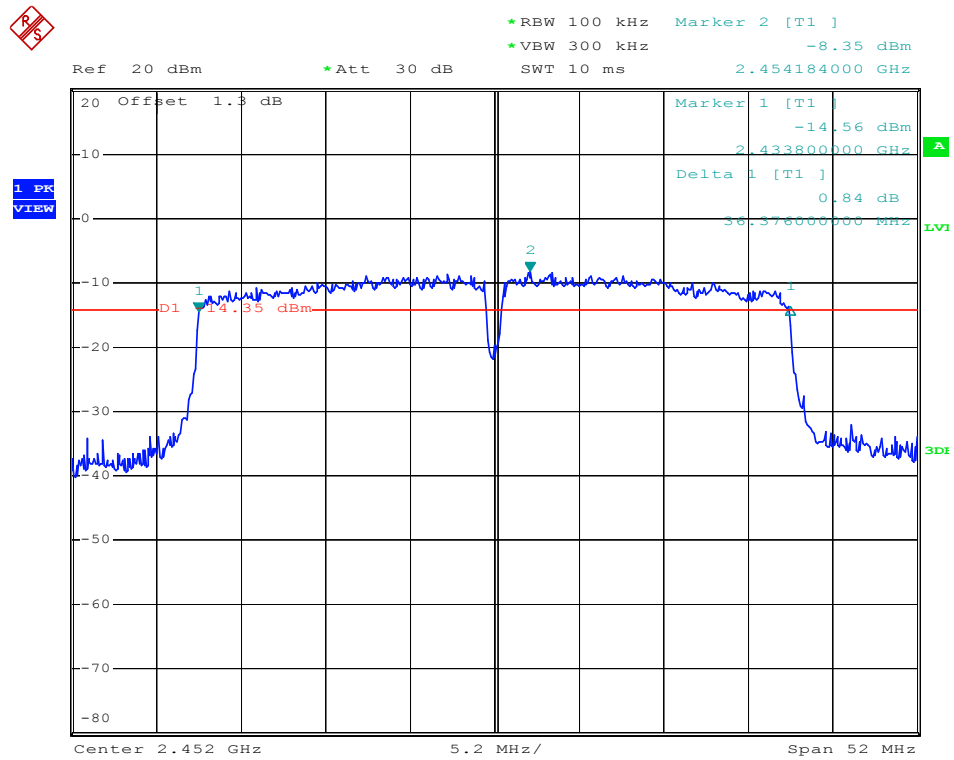

Chain 2

802.11b-Low Channel

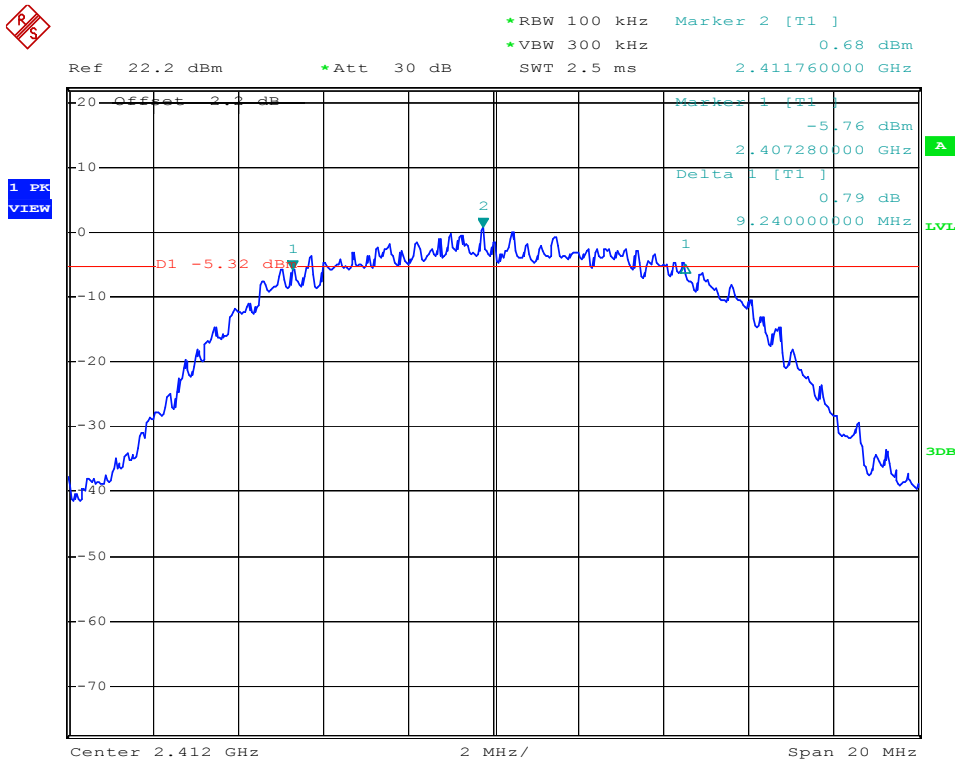

802.11b-Middle Channel

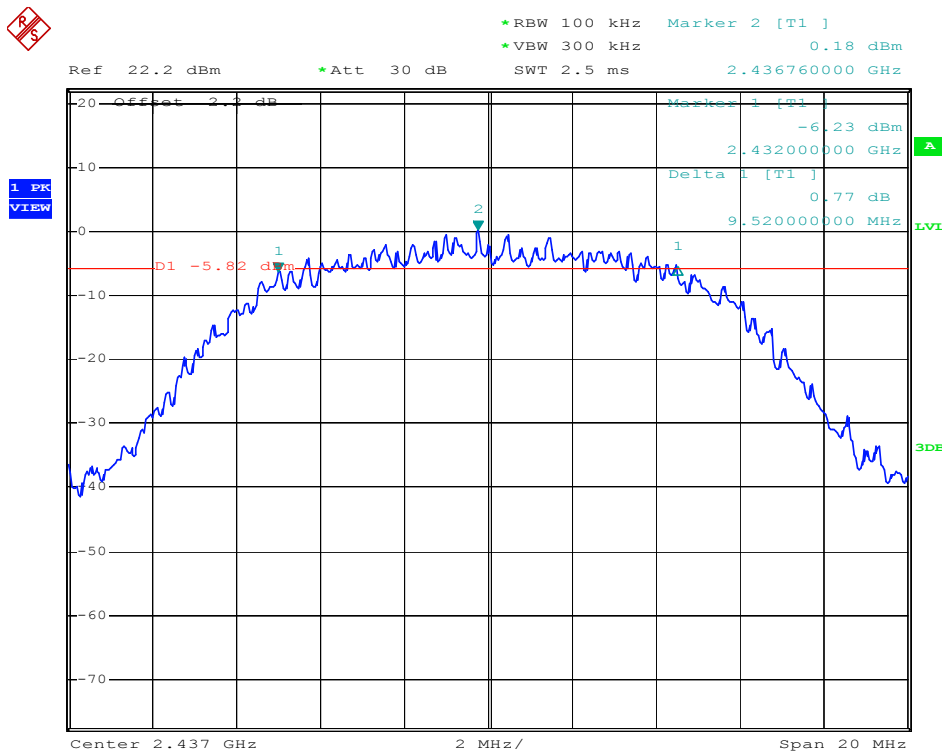



802.11b-High Channel

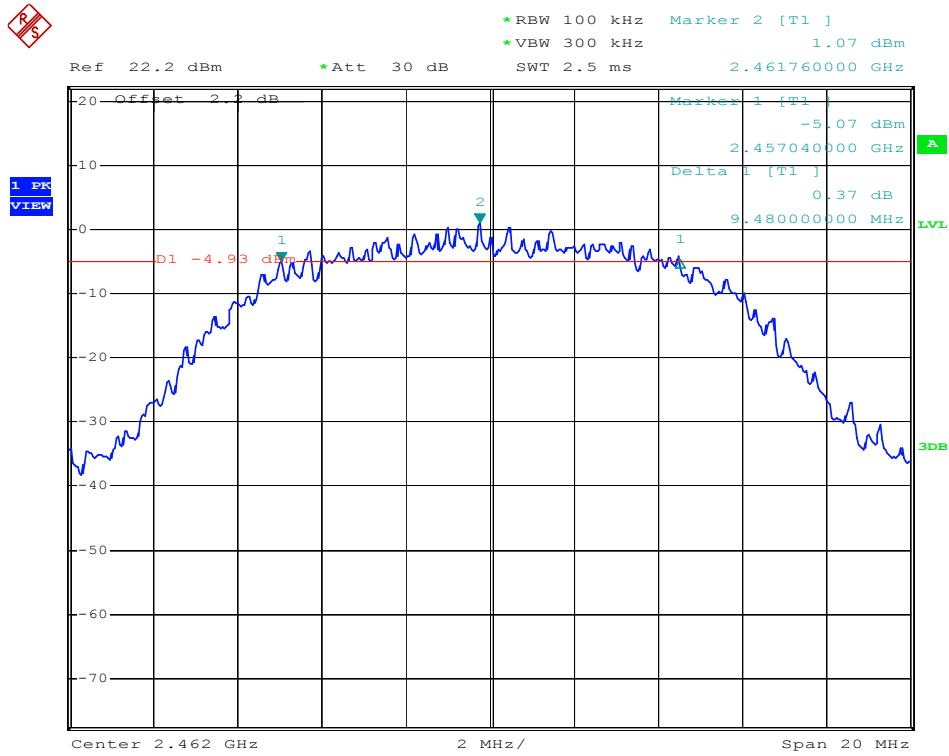

802.11g-Low Channel

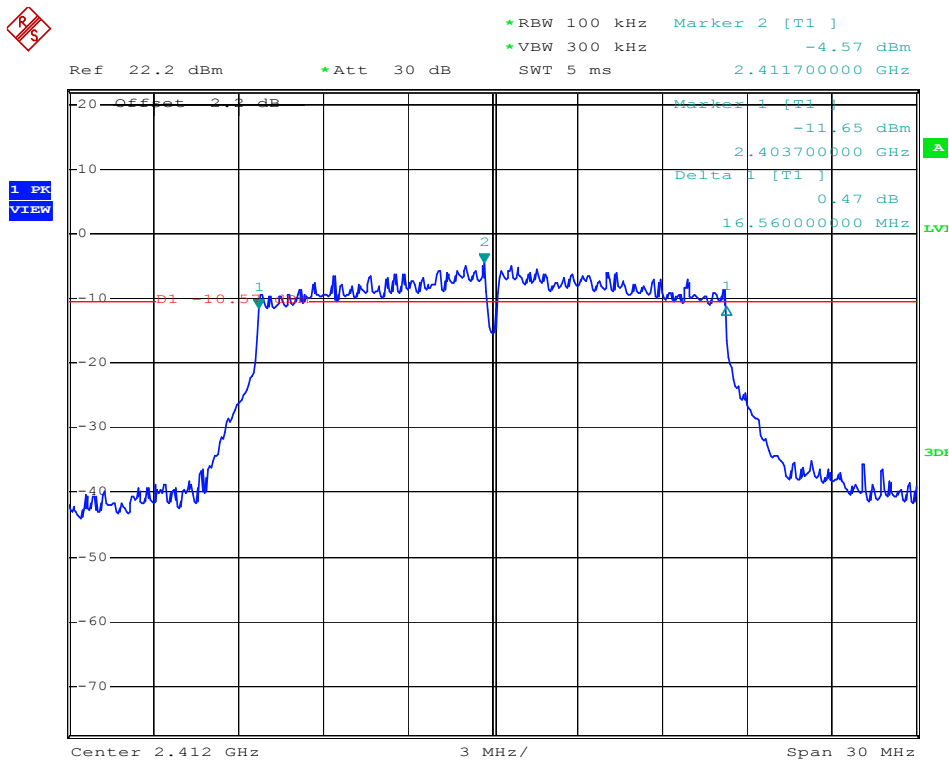

802.11g-Middle Channel

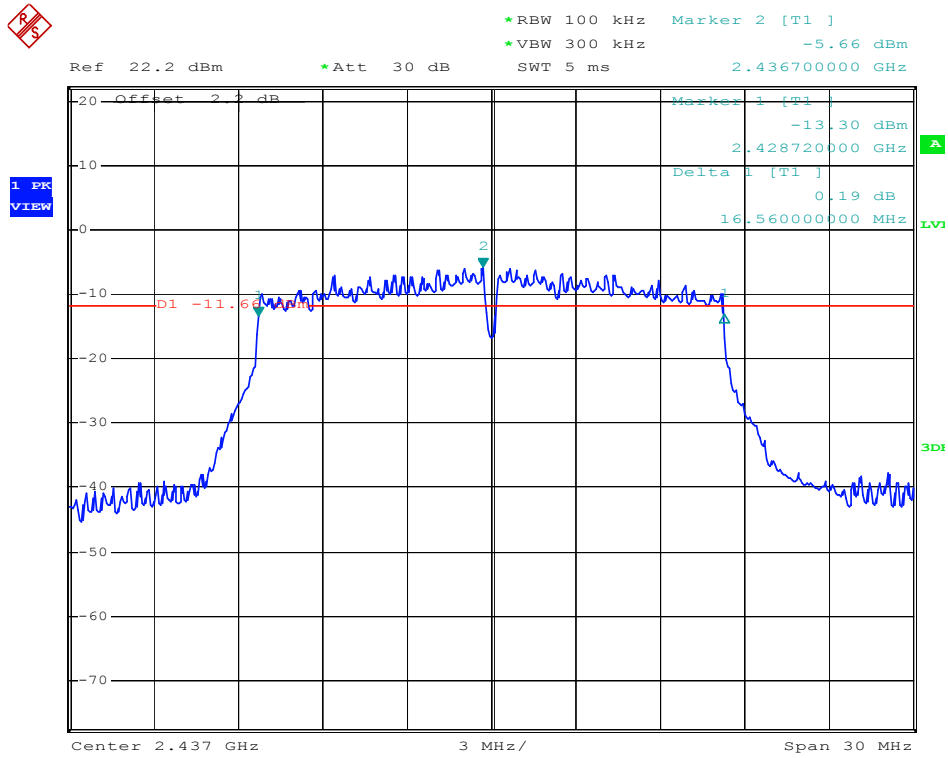

802.11g-High Channel

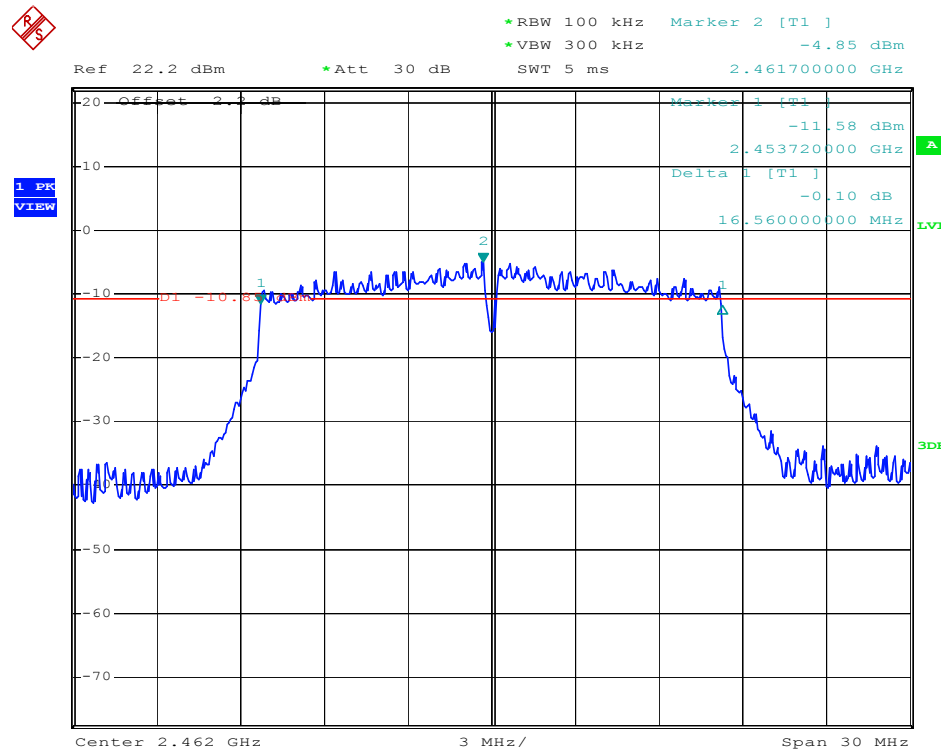

802.11n-HT20-Low Channel

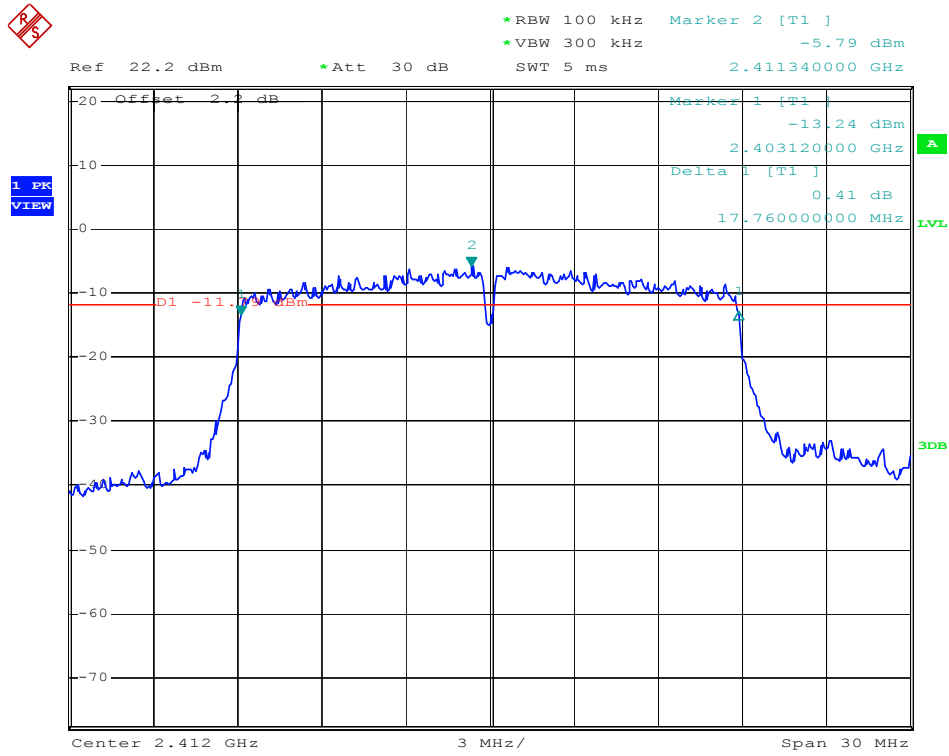

802.11n-HT20-Middle Channel

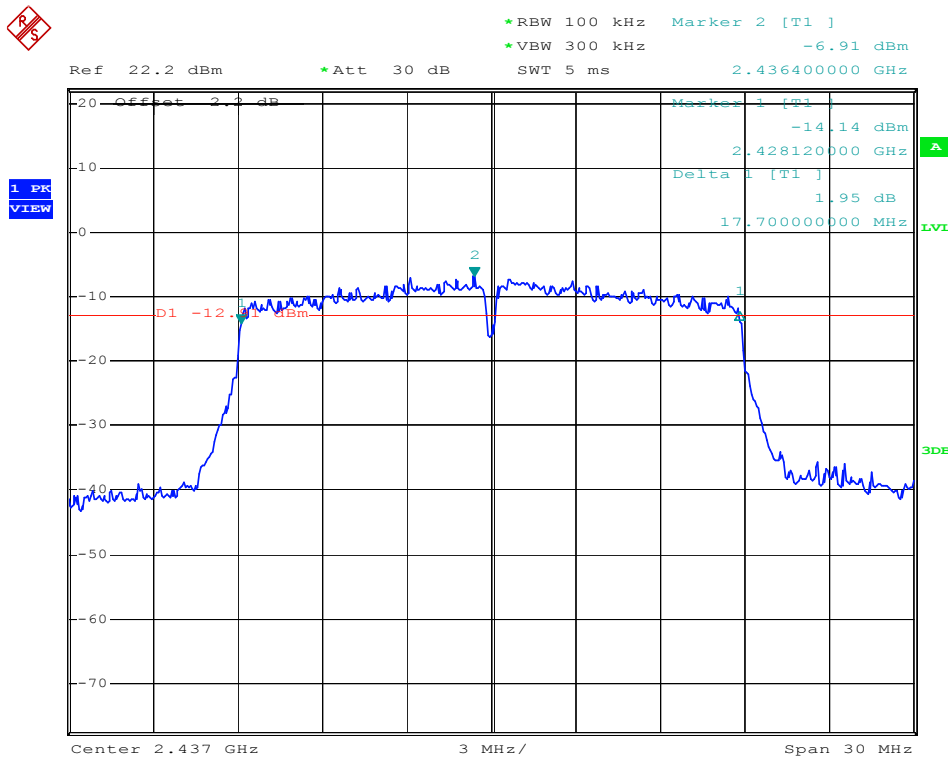

802.11n-HT20-High Channel

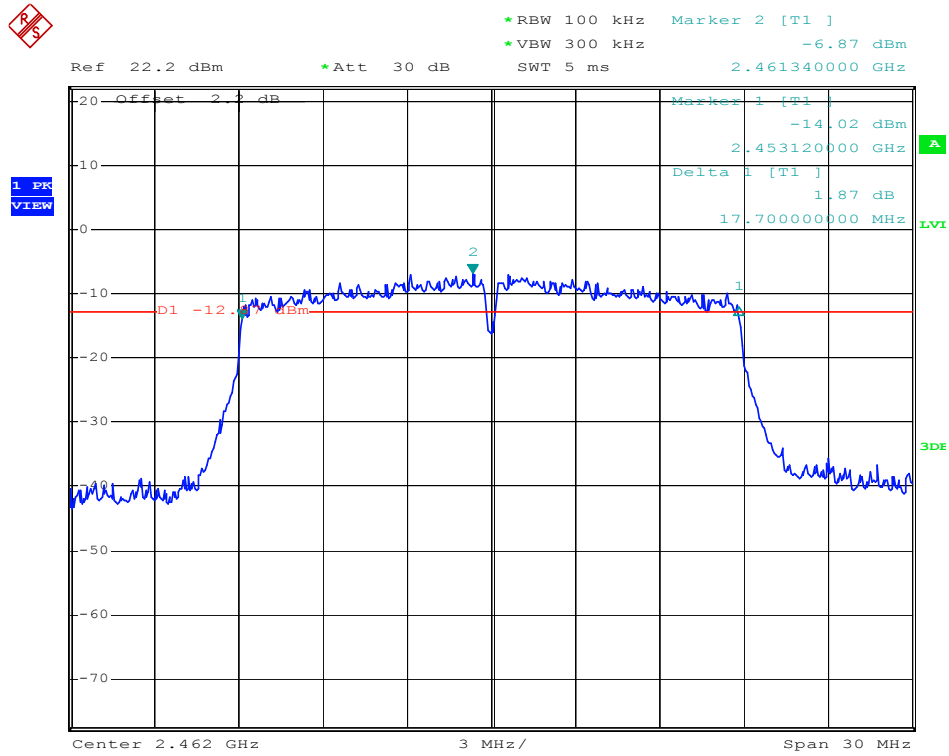

802.11n-HT40-Low Channel

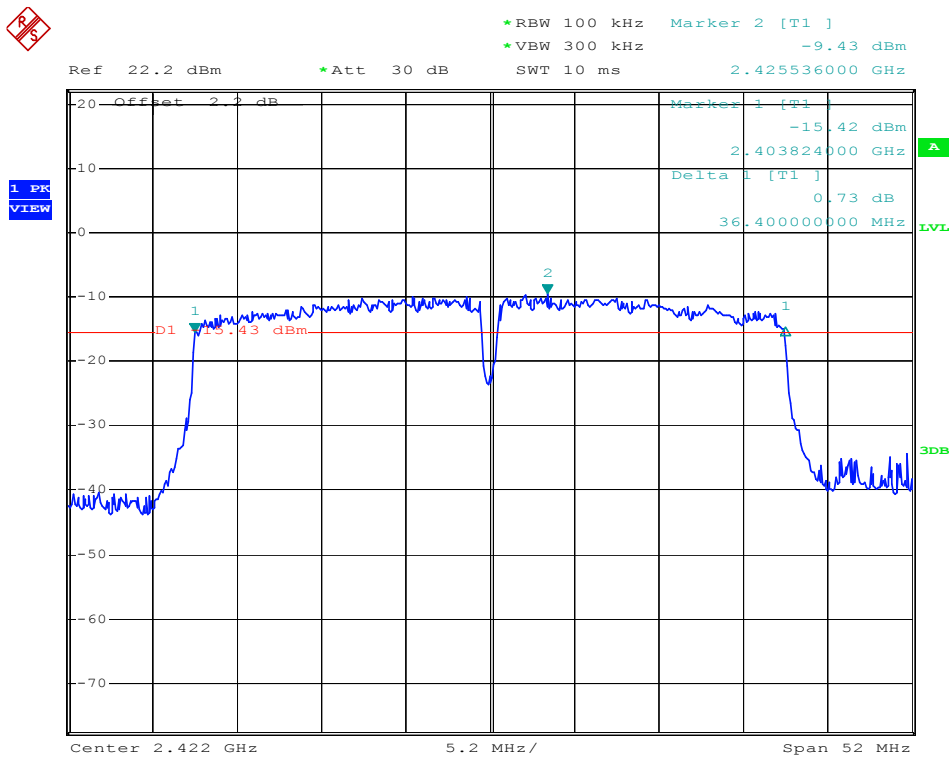

802.11n-HT40-Middle Channel

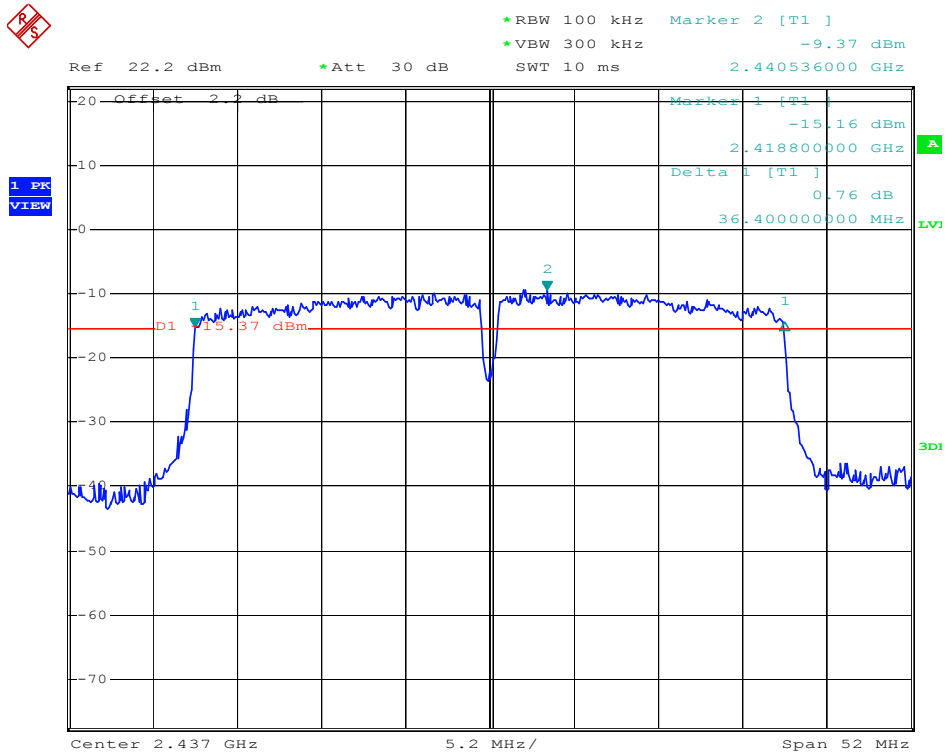

802.11n-HT40-High Channel

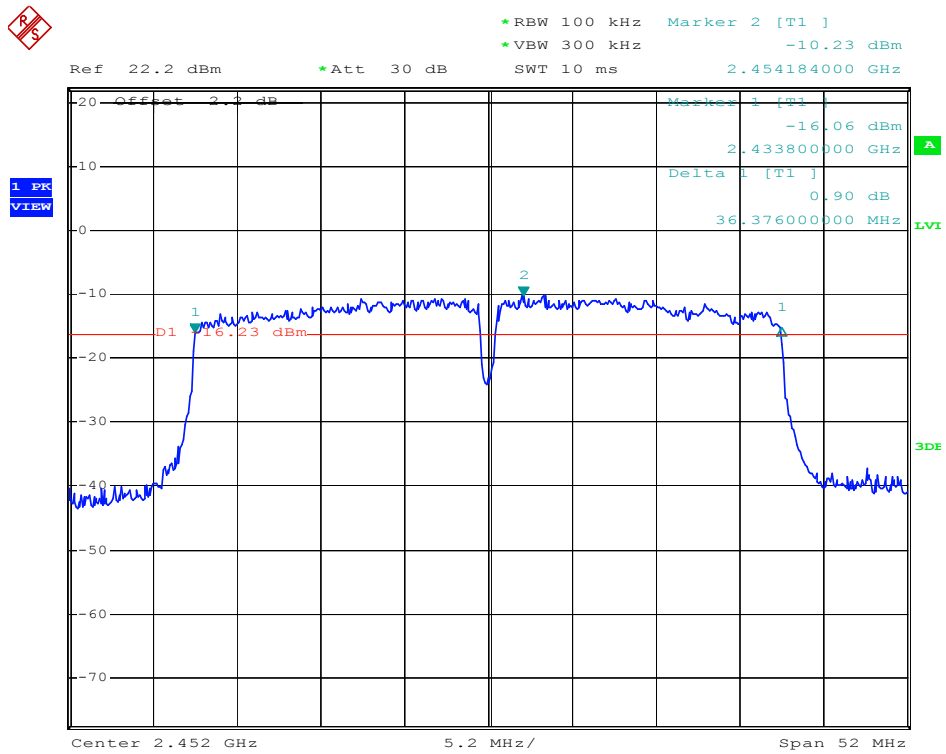

## 7. RF Output Power

---

### 7.1 Standard Applicable

According to 15.247(b)(3). For systems using digital modulation in the 902–928 MHz, 2400–2483.5 MHz, and 5725–5850 MHz bands: 1 Watt.

### 7.2 Test Procedure

The maximum peak conducted output power may be measured using a broadband peak RF power meter. The power meter shall have a video bandwidth that is greater than or equal to the DTS bandwidth and shall use a fast-responding diode detector.

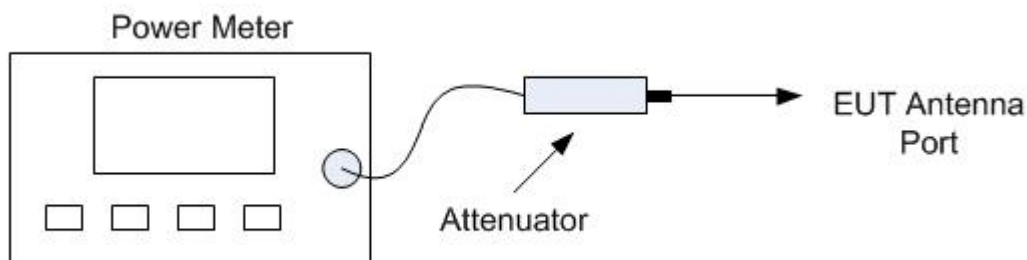

### 7.3 Environmental Conditions

Temperature:	26° C
Relative Humidity:	57%
ATM Pressure:	1011 mbar

**7.4 Summary of Test Results**

Test Mode	Frequency MHz	Chain 1 Power dBm	Chain 2 Power dBm	Total Power dBm	Output Power mW	Limit mW
802.11b_ 11Mbps	2412	13.77	13.46	/	46.0045	1000
	2437	13.52	13.64	/	45.6142	1000
	2462	13.63	13.49	/	45.4046	1000
802.11g_54Mbps	2412	13.11	12.96	/	40.2346	1000
	2437	12.85	12.74	/	38.0715	1000
	2462	12.47	12.28	/	34.5621	1000
802.11n HT20_MCS7	2412	11.45	11.24	14.357	27.2709	1000
	2437	11.68	11.73	14.715	29.6142	1000
	2462	11.33	11.31	14.330	27.1019	1000
802.11n HT40_MCS7	2422	11.28	11.27	14.285	26.8225	1000
	2437	11.35	11.22	14.296	26.8906	1000
	2452	11.12	11.03	14.086	25.6212	1000

Note:

1. Limit=30dBm

2. The Total Power (dBm) =  $10 \cdot \log \{10^{(\text{Chain 1 Power} / 10)} + 10^{(\text{Chain 2 Power} / 10)}\}$ .

## 8. Field Strength of Spurious Emissions

---

### 8.1 Measurement Uncertainty

Based on NIS 81, The Treatment of Uncertainty in EMC Measurements, the best estimate of the uncertainty of a radiation emissions measurement is  $\pm 5.10$  dB.

### 8.2 Standard Applicable

According to §15.247(d), in any 100 kHz bandwidth outside the frequency band in which the spread spectrum or digitally modulated intentional radiator is operating, the radio frequency power that is produced by the intentional radiator shall be at least 20 dB below that in the 100 kHz bandwidth within the band that contains the highest level of the desired power, based on either an RF conducted or a radiated measurement, provided the transmitter demonstrates compliance with the peak conducted power limits. If the transmitter complies with the conducted power limits based on the use of RMS averaging over a time interval, as permitted under paragraph (b)(3) of this section, the attenuation required under this paragraph shall be 30 dB instead of 20 dB. Attenuation below the general limits specified in §15.209(a) is not required. In addition, radiated emissions which fall in the restricted bands, as defined in §15.205(a), must also comply with the radiated emission limits specified in §15.209(a).

The emission limit in this paragraph is based on measurement instrumentation employing an average detector. The provisions in §15.35 for limiting peak emissions apply. Spurious Radiated Emissions measurements starting below or at the lowest crystal frequency.

### 8.3 Test Procedure

The setup of EUT is according with per ANSI C63.10-2013 measurement procedure. The specification used was with the FCC Part 15.205 15.247(a) and FCC Part 15.209 Limit.

The external I/O cables were draped along the test table and formed a bundle 30 to 40 cm long in the middle.

The spacing between the peripherals was 10 cm.

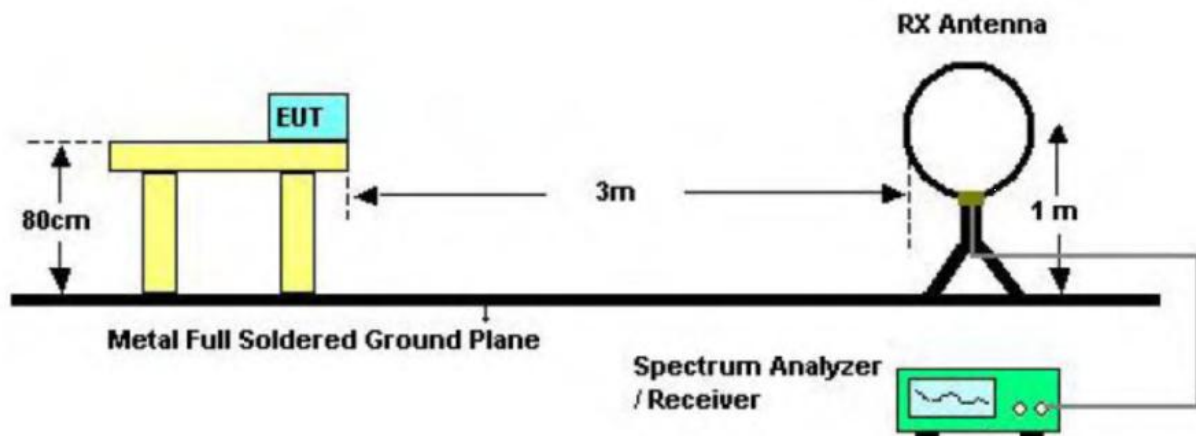



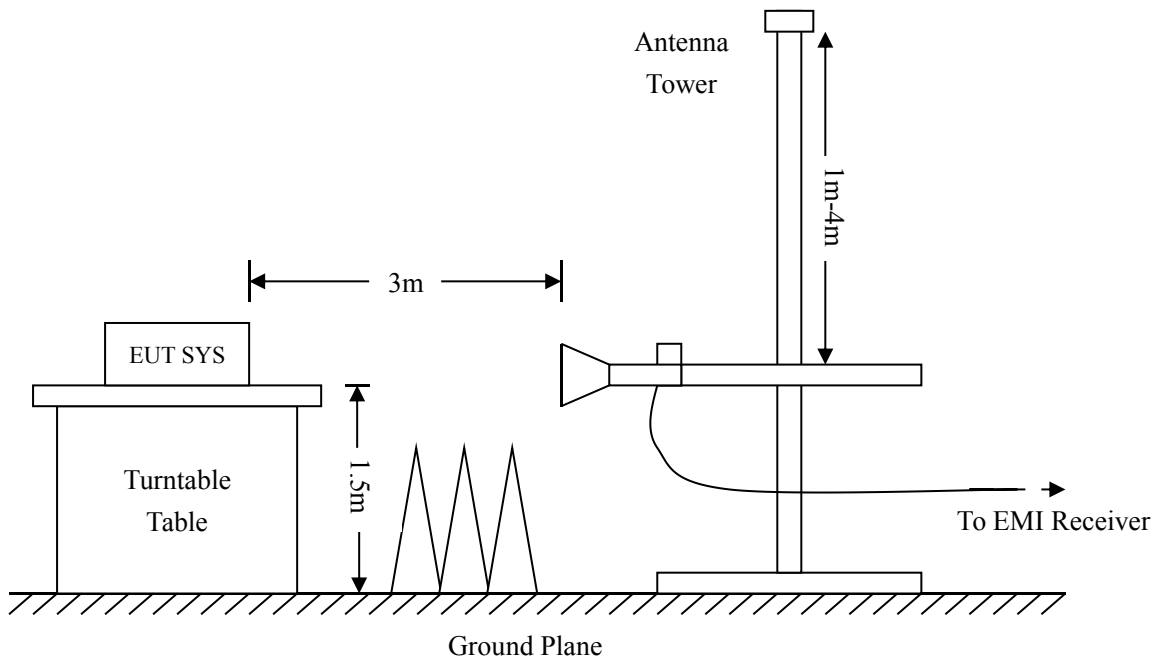
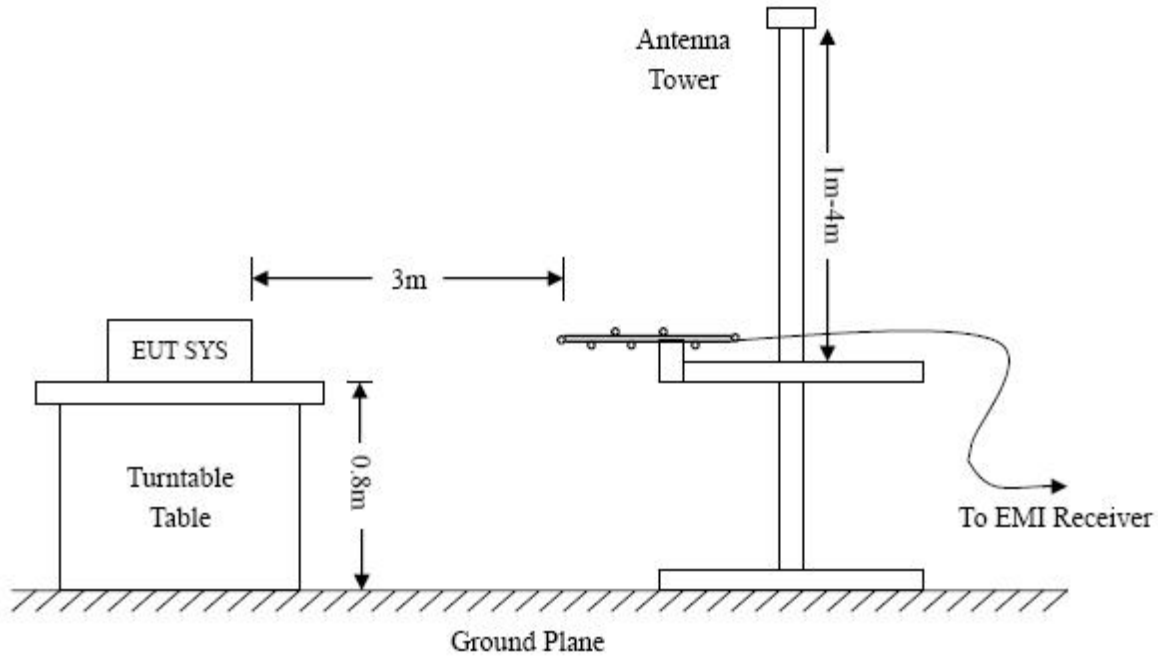

Frequency :9kHz-30MHz  
 RBW=10KHz,  
 VBW =30KHz  
 Sweep time= Auto  
 Trace = max hold  
 Detector function = peak

Frequency :30MHz-1GHz  
 RBW=120KHz,  
 VBW=300KHz  
 Sweep time= Auto  
 Trace = max hold  
 Detector function = peak, QP

Frequency :Above 1GHz  
 RBW=1MHz,  
 VBW=3MHz(Peak), 10Hz(AV)  
 Sweep time= Auto  
 Trace = max hold  
 Detector function = peak, AV

## 8.4 Corrected Amplitude & Margin Calculation

The Corrected Amplitude is calculated by adding the Antenna Factor and the Cable Factor, and subtracting the Amplifier Gain from the Amplitude reading. The basic equation is as follows:

$$\text{Corr. Ampl.} = \text{Indicated Reading} + \text{Ant. Factor} + \text{Cable Loss} - \text{Ampl. Gain}$$

The “**Margin**” column of the following data tables indicates the degree of compliance with the applicable limit. For example, a margin of  $-6\text{dB}\mu\text{V}$  means the emission is  $6\text{dB}\mu\text{V}$  below the maximum limit. The equation for margin calculation is as follows:

$$\text{Margin} = \text{Corr. Ampl.} - \text{FCC Part 15 Limit}$$

## 8.5 Environmental Conditions

Temperature:	25 °C
Relative Humidity:	52%
ATM Pressure:	1012 mbar

## 8.6 Summary of Test Results/Plots

According to the data below, the FCC Part 15.205, 15.209 and 15.247 standards, and had the worst cases:

*Note:*

- 1. Worst-case radiated emission below 1GHz is 802.11b (CH Low) of Chain 1 mode.*
- 2. Worst-case radiated emission above 1GHz is 802.11b (CH Low Middle High) of Chain2 mode.*

Plot of Radiated Emissions Test Data (30MHz to 1GHz): 802.11b (CH Low) of Chain 1

Test Specification: Horizontal

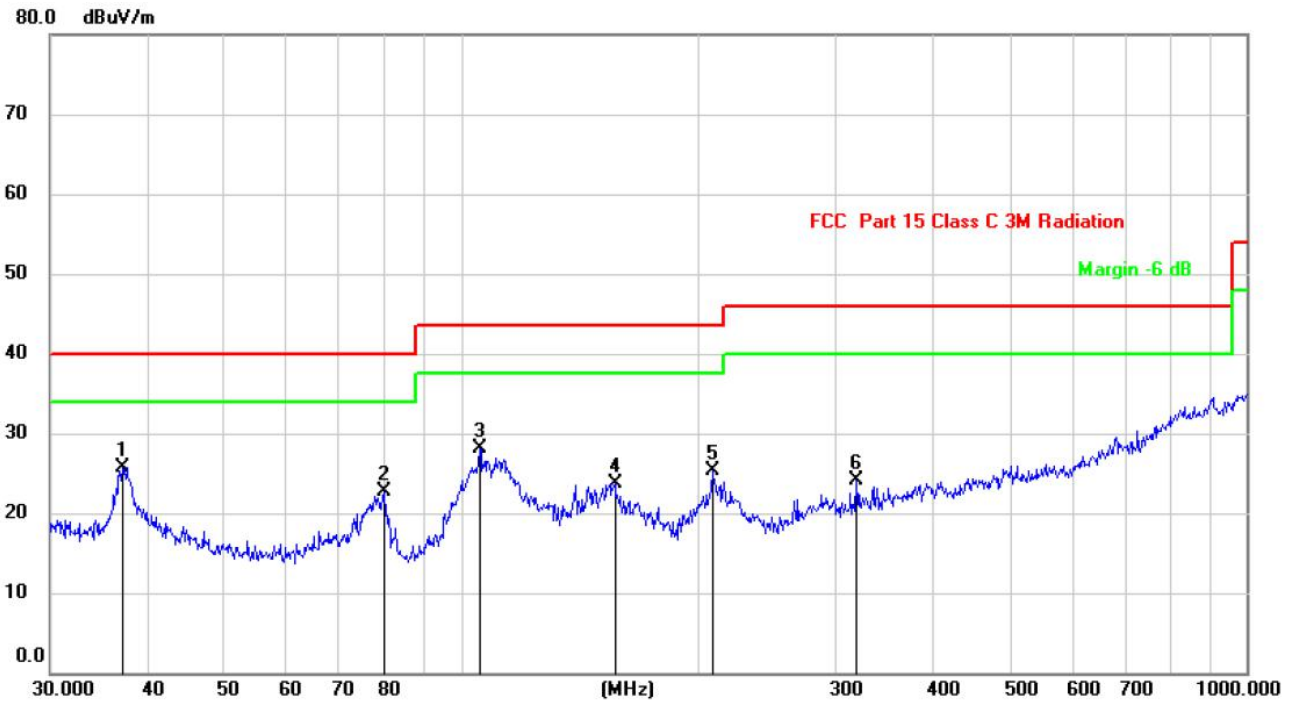

No.	Mk.	Freq. MHz	Reading Level dBuV	Correct Factor dBuV/m	Measure- ment dBuV/m	Limit dBuV/m	Over dB	Detector	Comment
1	*	37.0248	21.13	4.55	25.68	40.00	-14.32	QP	
2		79.8003	21.55	1.07	22.62	40.00	-17.38	QP	
3		105.6415	25.73	2.36	28.09	43.50	-15.41	QP	
4		157.0074	21.25	2.52	23.77	43.50	-19.73	QP	
5		209.3129	21.64	3.61	25.25	43.50	-18.25	QP	
6		318.8170	16.48	7.68	24.16	46.00	-21.84	QP	

Test Specification: Vertical

80.0 dBuV/m



No.	Mk.	Freq. MHz	Reading Level dBuV	Correct Factor dBuV/m	Measure- ment dBuV/m	Limit dBuV/m	Over dB	Detector	Comment
1	*	37.2855	32.16	4.74	36.90	40.00	-3.10	QP	
2		66.4989	30.35	1.24	31.59	40.00	-8.41	QP	
3	!	75.7114	33.27	1.15	34.42	40.00	-5.58	QP	
4		100.9339	32.03	1.87	33.90	43.50	-9.60	QP	
5		157.5588	29.49	2.49	31.98	43.50	-11.52	QP	
6		210.0482	24.63	3.61	28.24	43.50	-15.26	QP	

*Spurious Emissions Above 1GHz**Test Mode: 802.11b of Chain 2:*

Frequency	Rearding Level	Factor	Result	Limit	Margin	Polar	Detector
(MHz)	(dB $\mu$ V)	(dB)	(dBuV/m)	(dBuV/m)	(dB)	H/V	
Low channel-2412MHz							
4824.000	50.46	3.21	53.67	74	-20.33	H	PK
4824.000	38.79	3.21	42.00	54	-12.00	H	AV
7236.000	48.67	4.10	52.77	74	-21.23	H	PK
7236.000	35.22	4.10	39.32	54	-14.68	H	AV
4824.000	49.66	3.58	53.24	74	-20.76	V	PK
4824.000	37.37	3.58	40.95	54	-13.05	V	AV
7236.000	48.29	3.69	51.98	74	-22.02	V	PK
7236.000	36.24	3.69	39.93	54	-14.07	V	AV
Middle channel-2437MHz							
4874.000	50.12	3.10	53.22	74	-20.78	H	PK
4874.000	37.04	3.10	40.14	54	-13.86	H	AV
7311.000	48.25	4.02	52.27	74	-21.73	H	PK
7311.000	34.71	4.02	38.73	54	-15.27	H	AV
4874.000	50.93	3.66	54.59	74	-19.41	V	PK
4874.000	38.39	3.66	42.05	54	-11.95	V	AV
7311.000	50.11	3.52	53.63	74	-20.37	V	PK
7311.000	34.48	3.52	38.00	54	-16.00	V	AV
High channel-2462MHz							
4924.000	48.62	3.68	52.30	74	-21.70	H	PK
4924.000	33.86	3.68	37.54	54	-16.46	H	AV
7386.000	47.18	4.00	51.18	74	-22.82	H	PK
7386.000	34.33	4.00	38.33	54	-15.67	H	AV
4924.000	49.67	3.85	53.52	74	-20.48	V	PK
4924.000	37.21	3.85	41.06	54	-12.94	V	AV
7386.000	48.19	3.18	51.37	74	-22.63	V	PK
7386.000	36.58	3.18	39.76	54	-14.24	V	AV

## Note:

1. Calculation of result is: Result (dBm) = Reading (dBm) + Correction Factor (dB).
2. Correction Factor (dB)=Ant. Factor + Cable Loss – Ampl. Gain.
3. Testing is carried out with frequency rang 9kHz to the tenth harmonics, other than listed in the table above are attenuated more than 20dB below the permissible limits or the field strength is too small to be measured.

The worst data of spurious (Conducted)

Chain 1:

802.11b-Lowest

Lowest

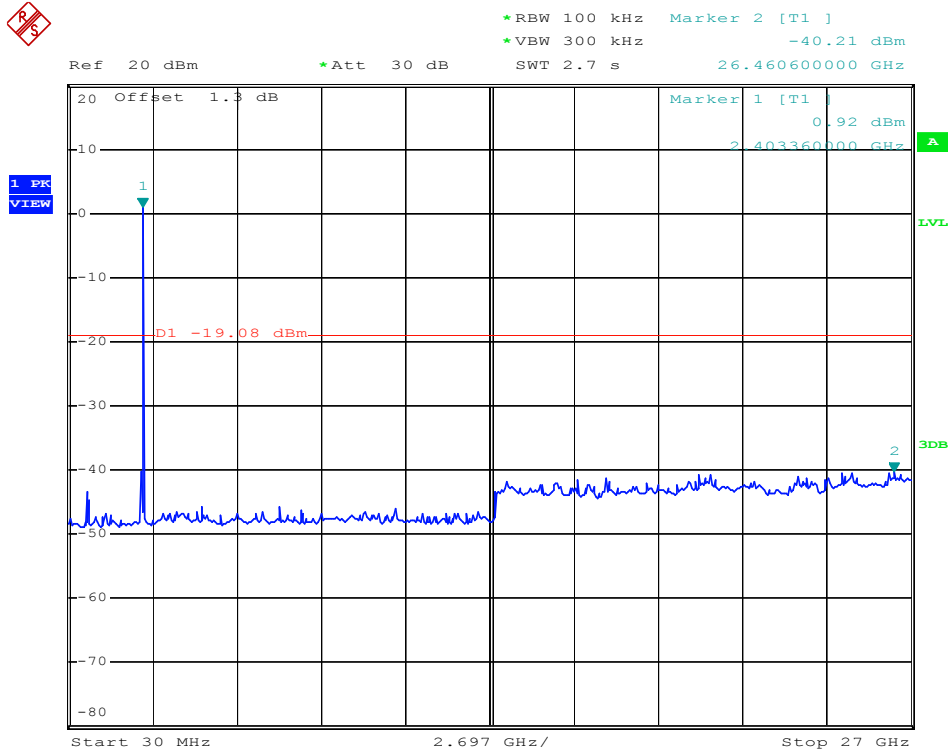

Middle

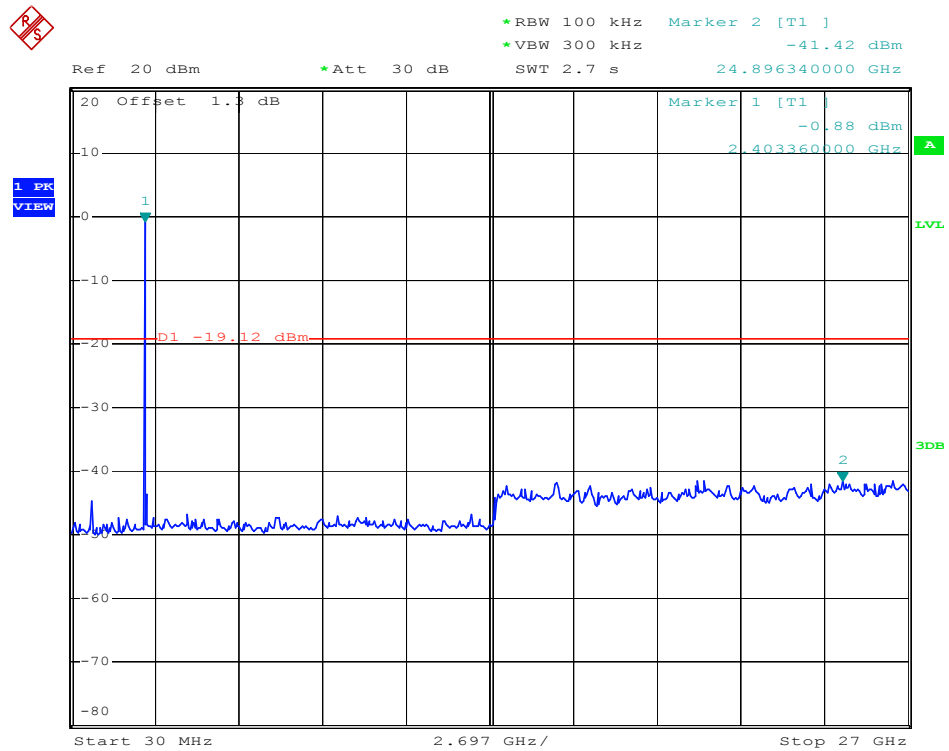

Highest

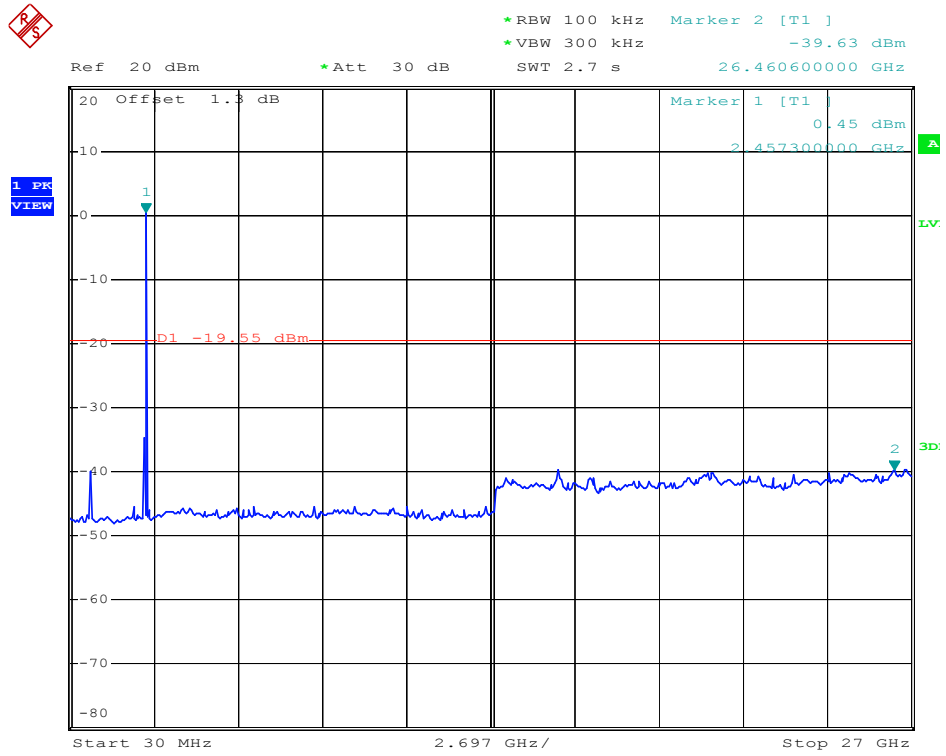

802.11g-Lowest

Lowest

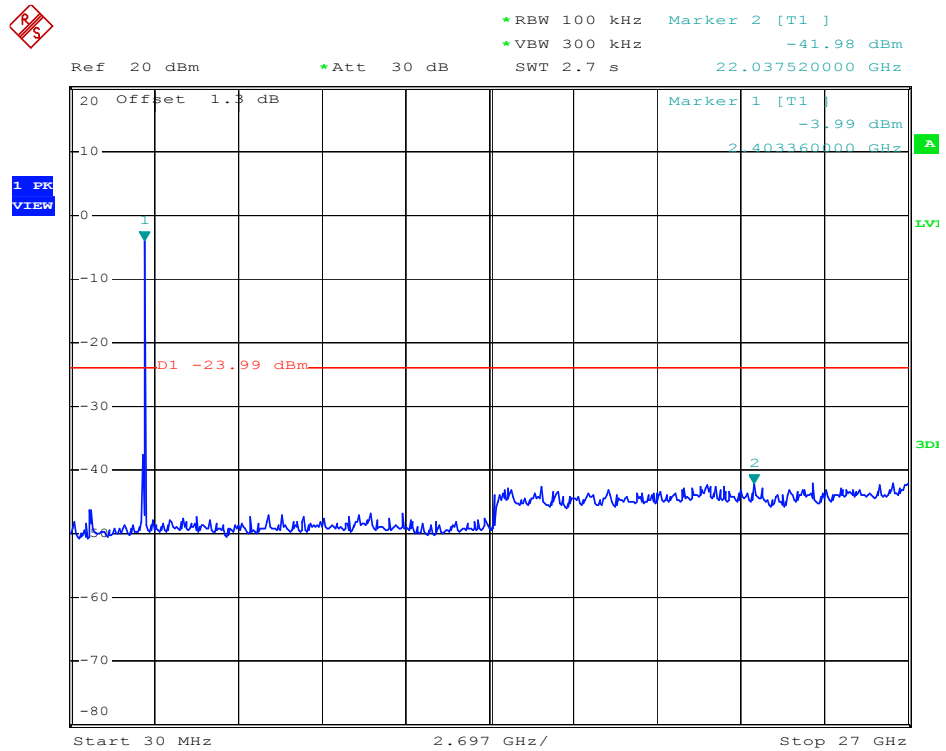

Middle

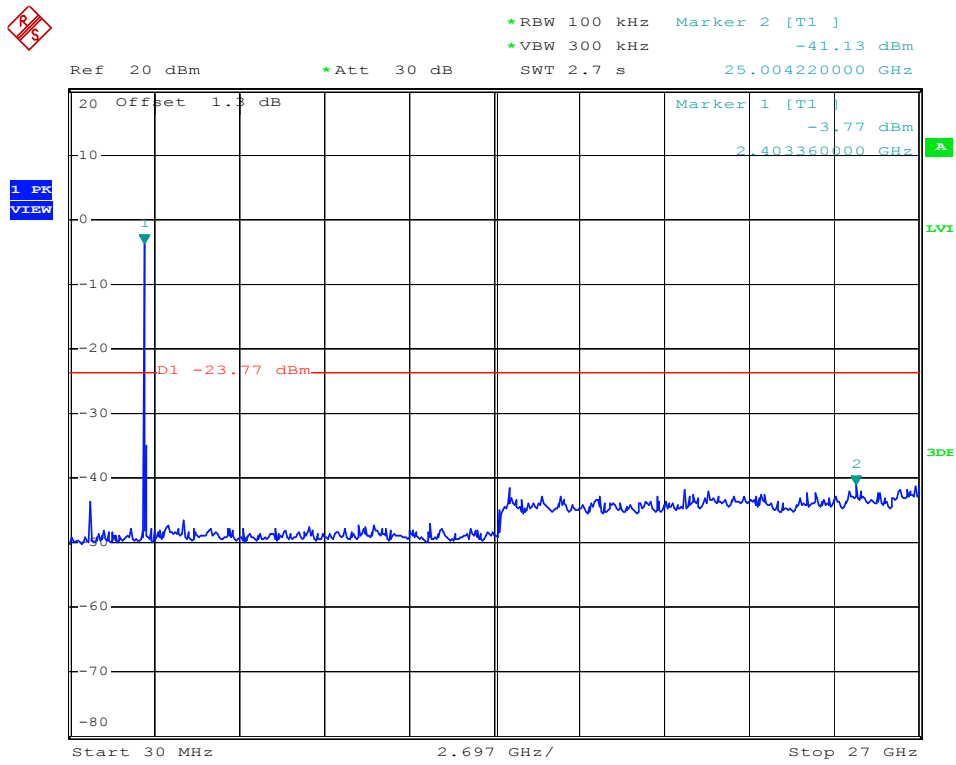

Highest

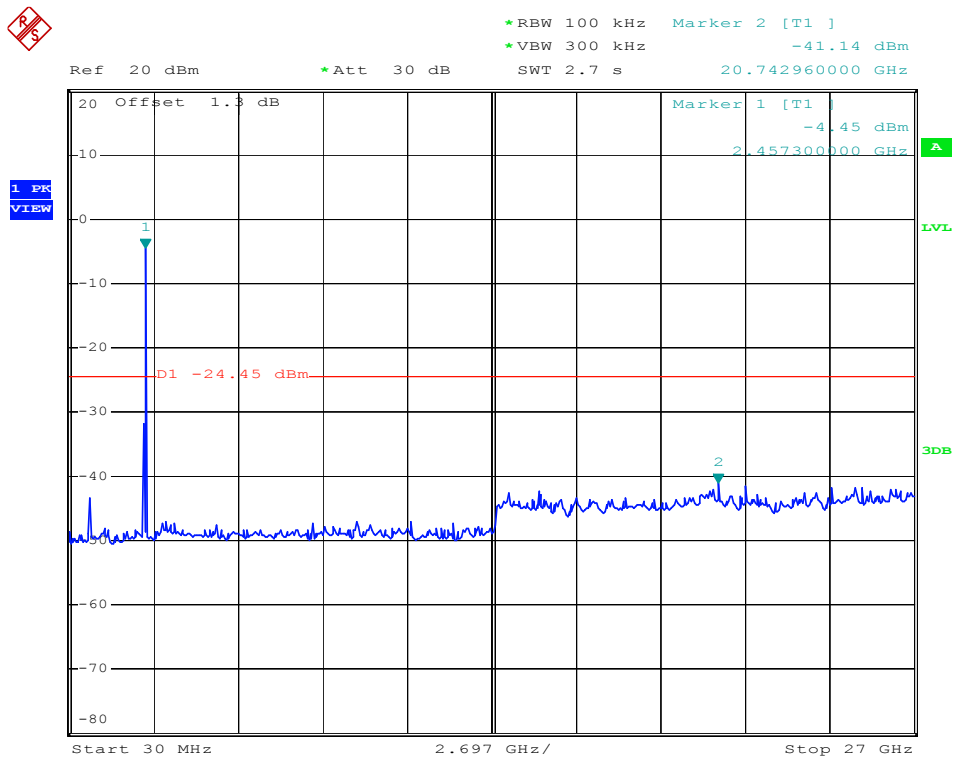



802.11n-HT20-Lowest

Lowest

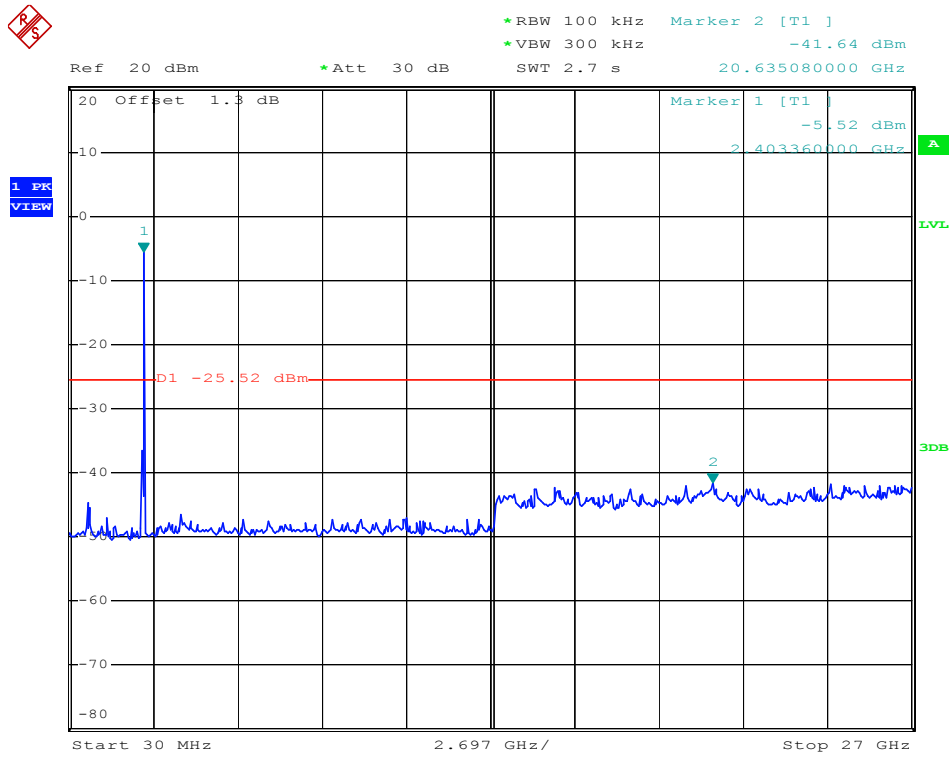

Middle

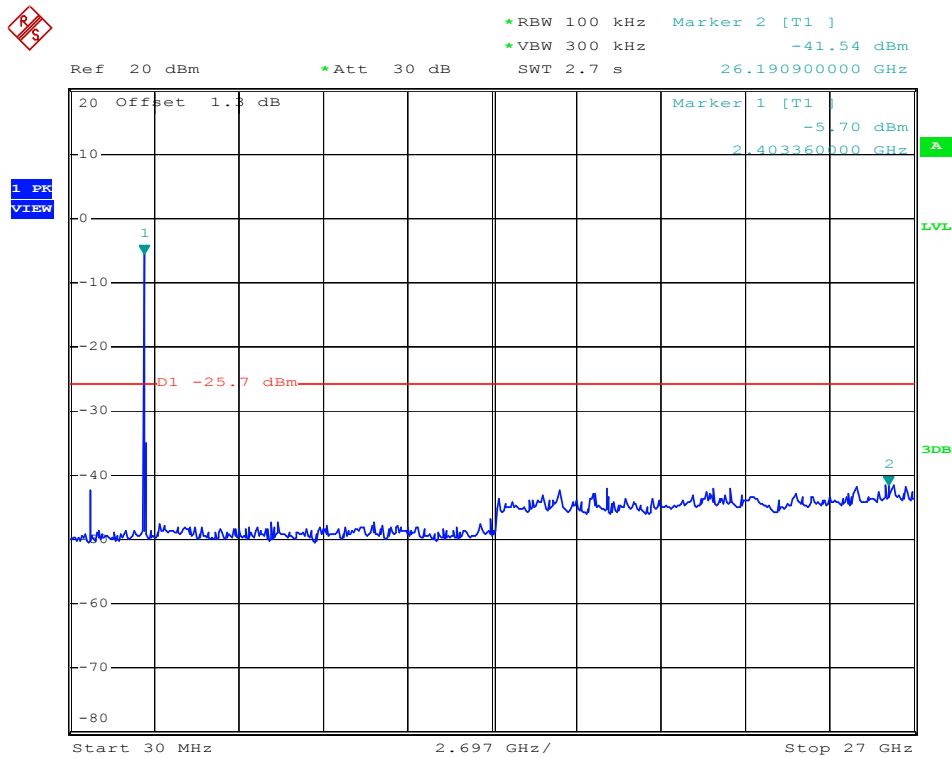

Highest

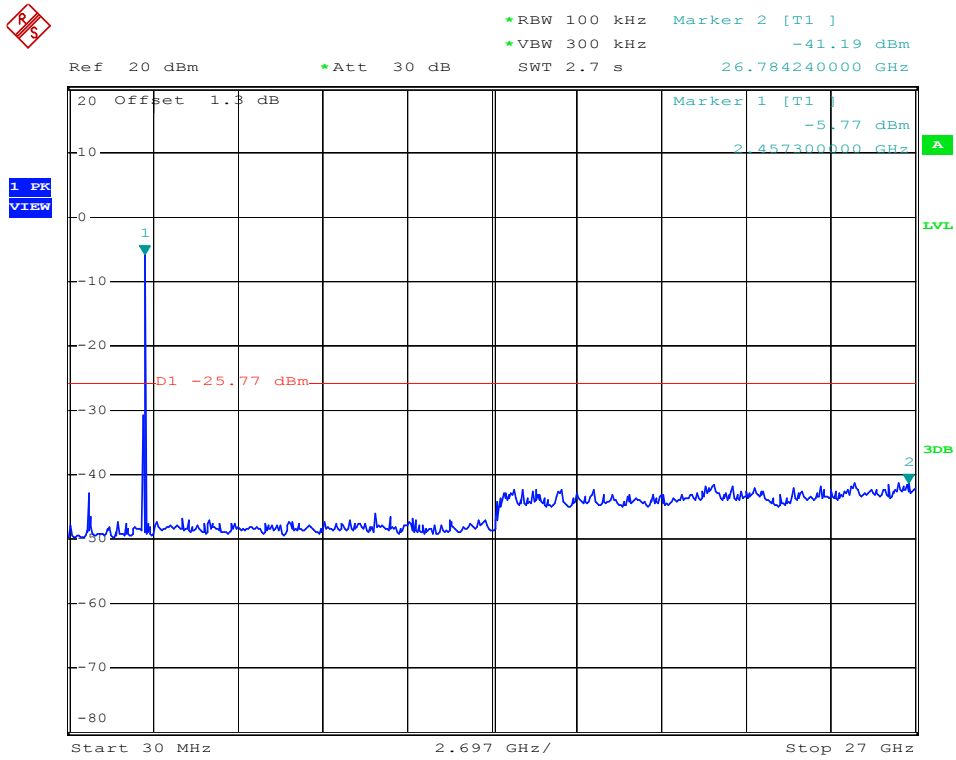

802.11n-HT40-Lowest

Lowest

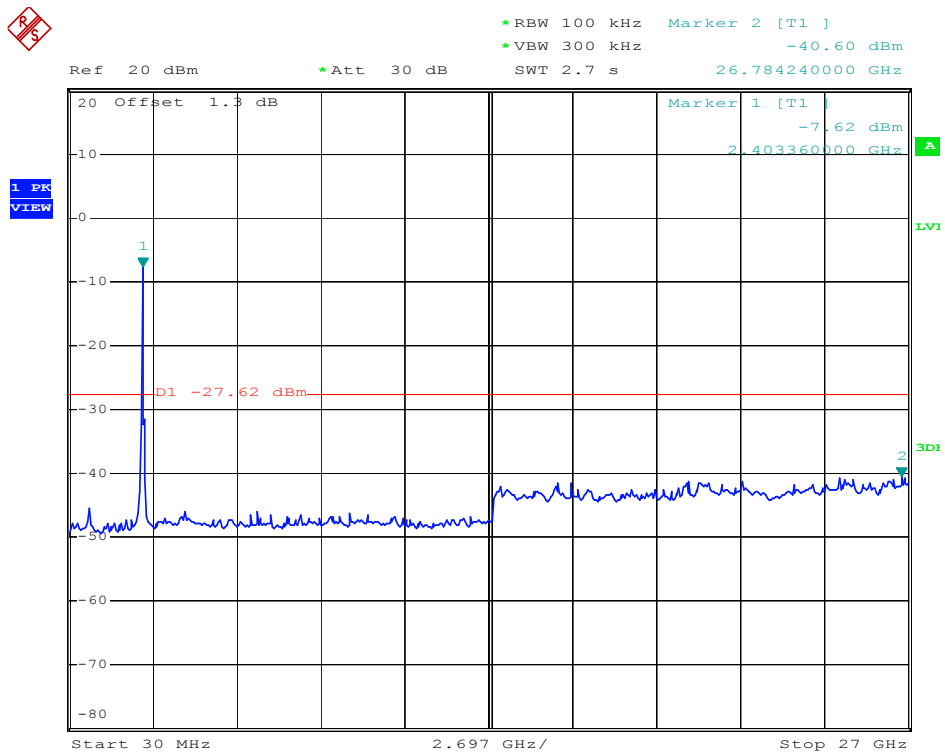

Middle

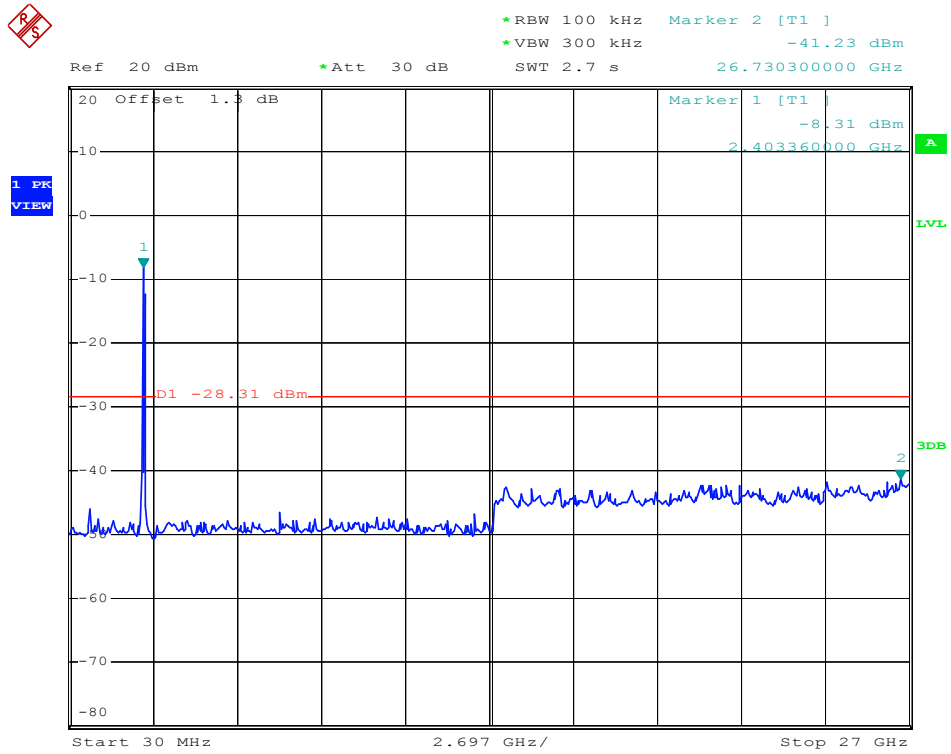

Highest

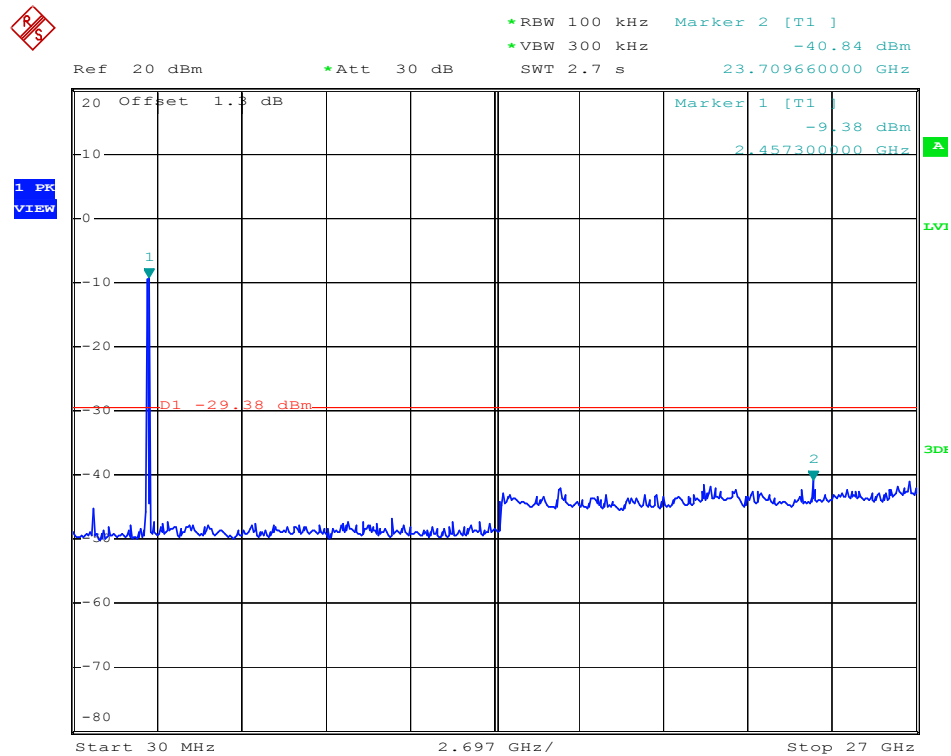

Chain 2:  
802.11b-Lowest  
Lowest

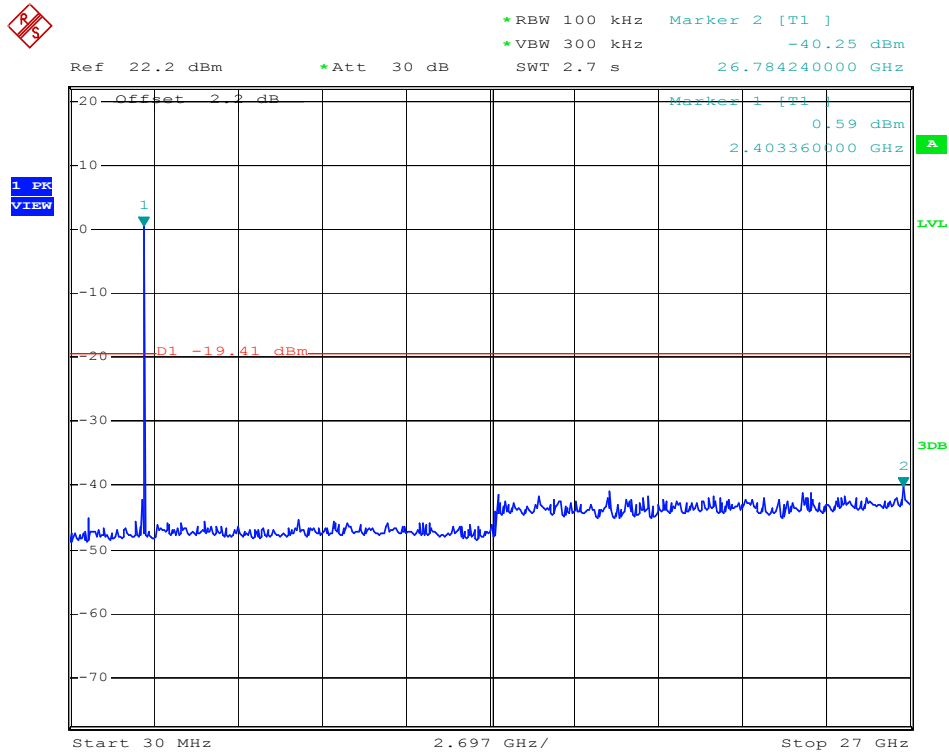

Middle

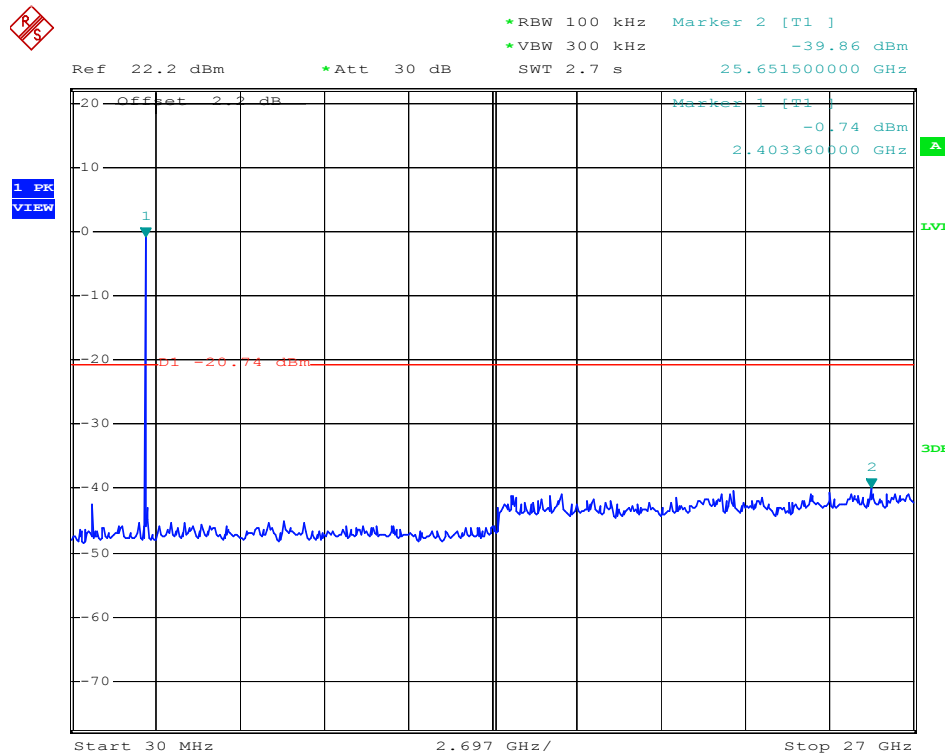

Highest

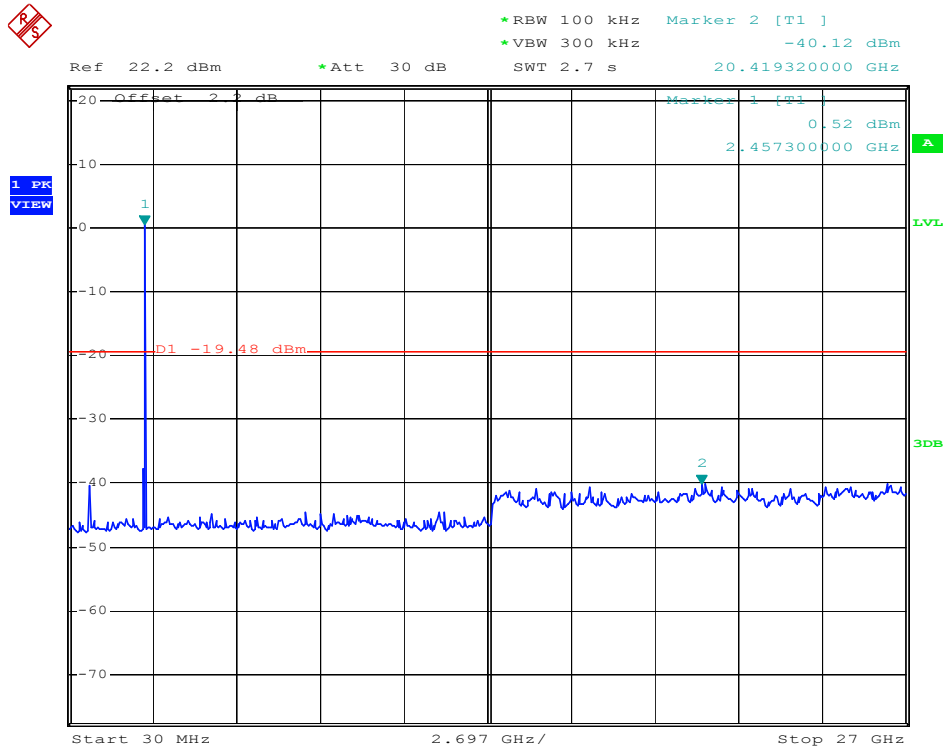

802.11g-Lowest  
Lowest

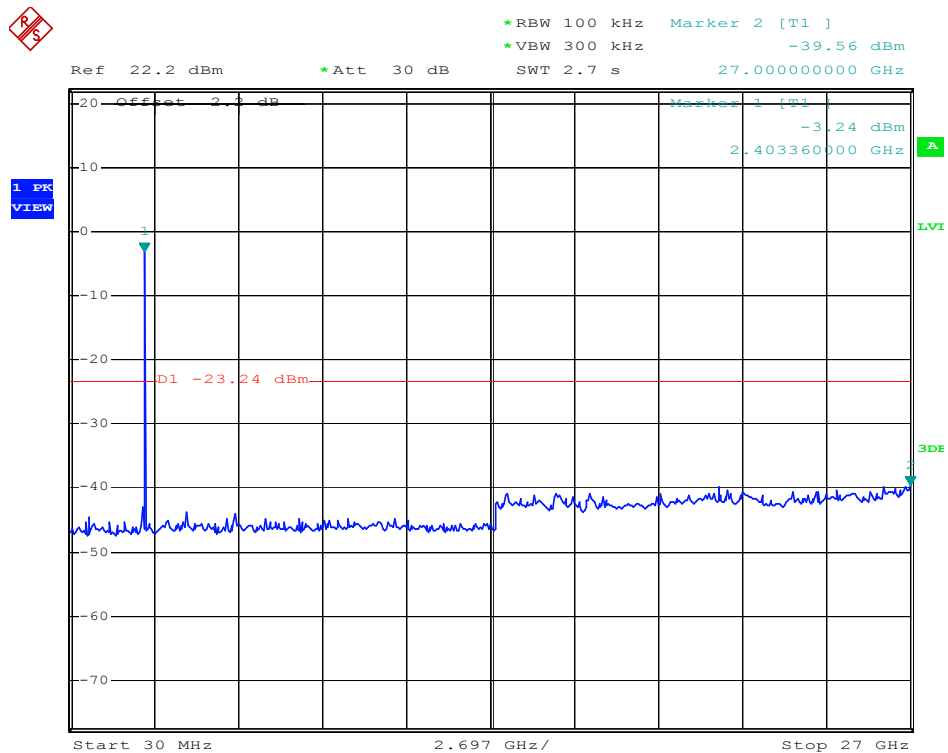

Middle

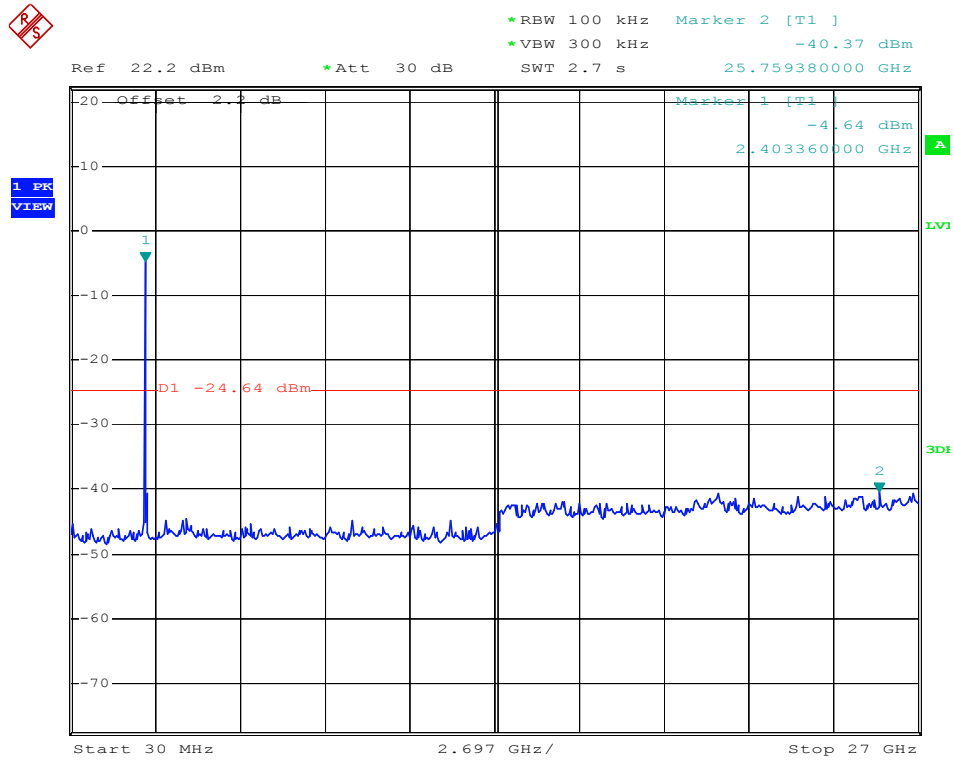

Highest

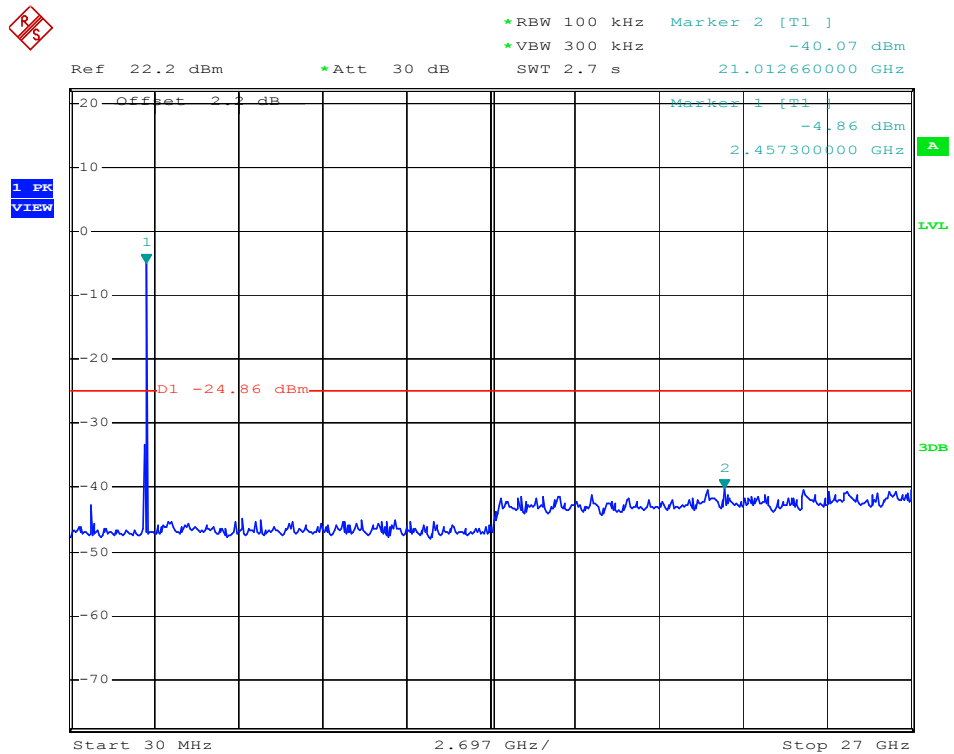

802.11n-HT20-Lowest

Lowest

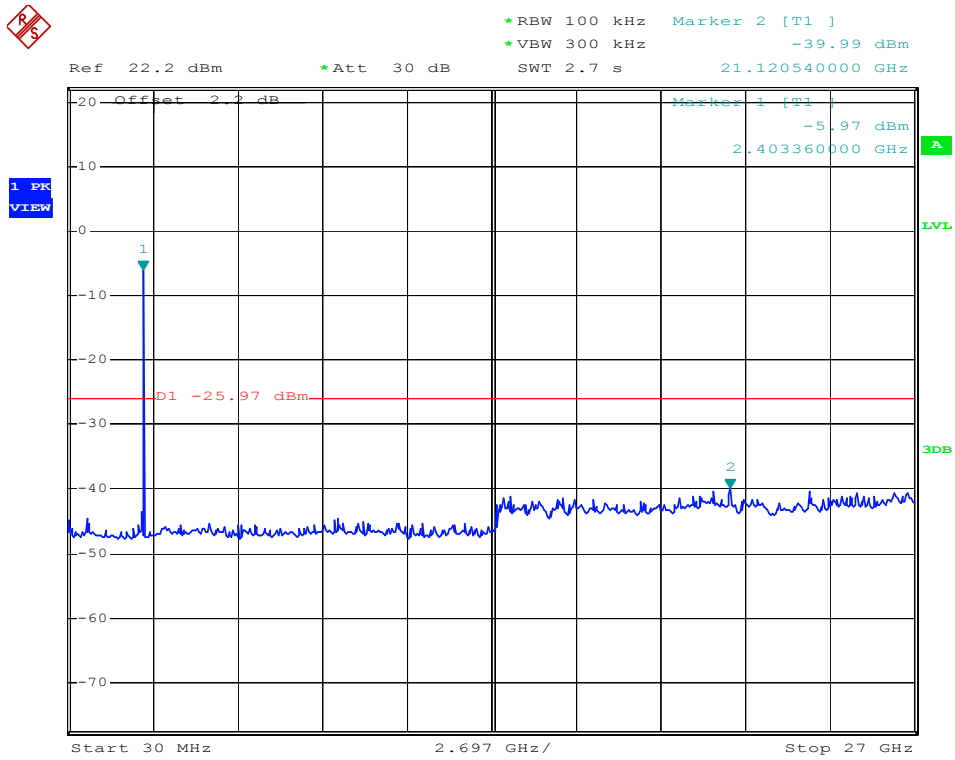

Middle

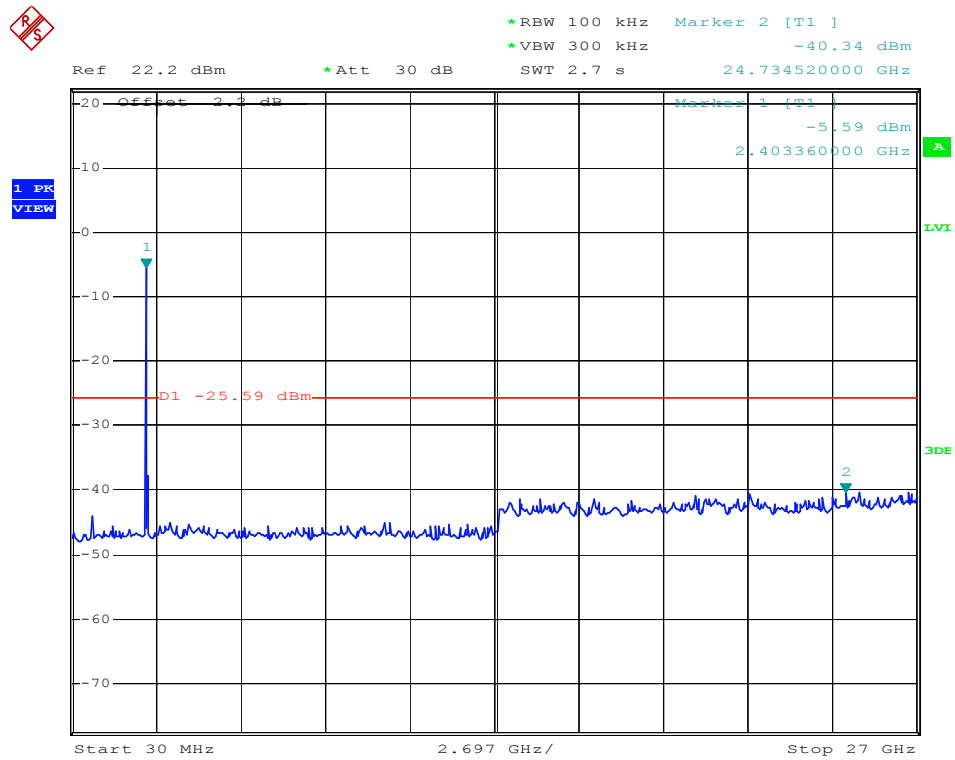

Highest

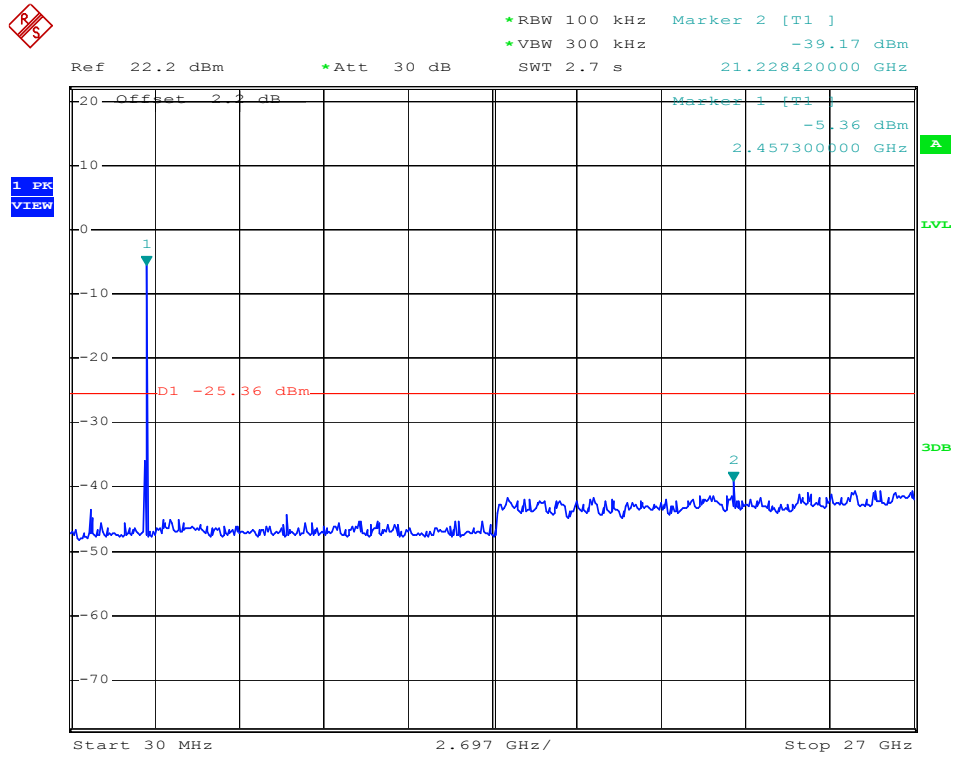

802.11n-HT40-Lowest

Lowest

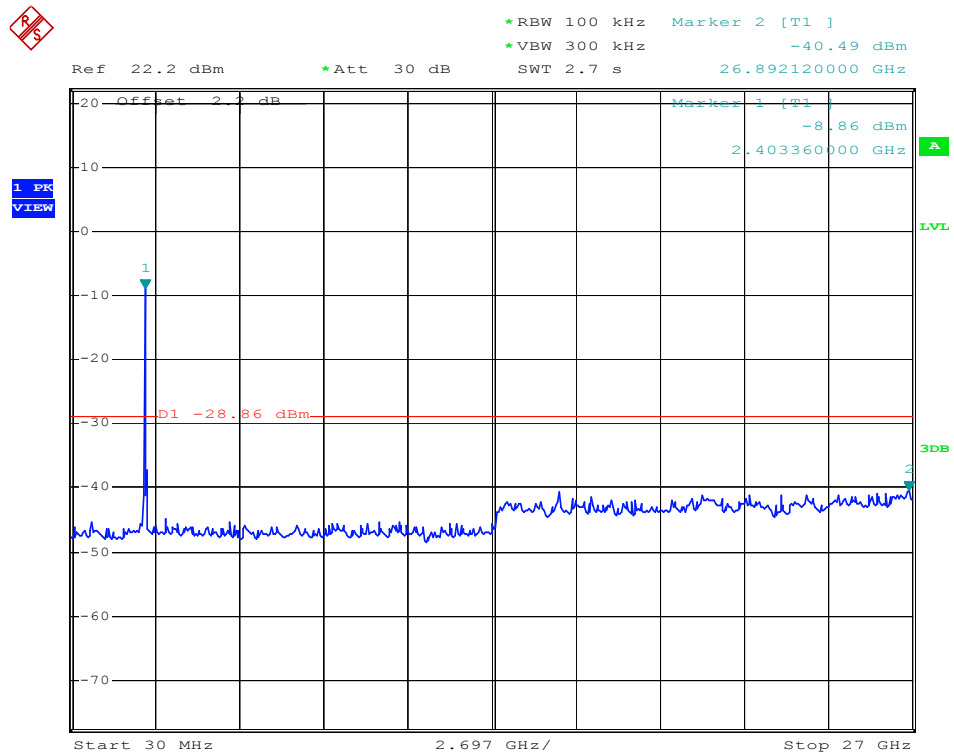



Middle

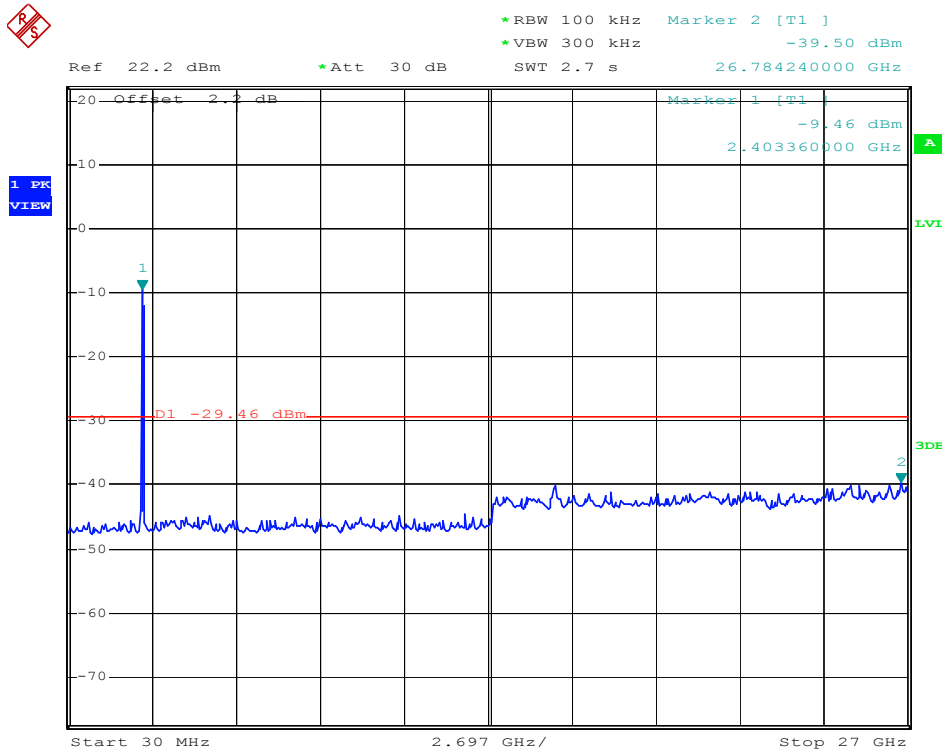

Highest

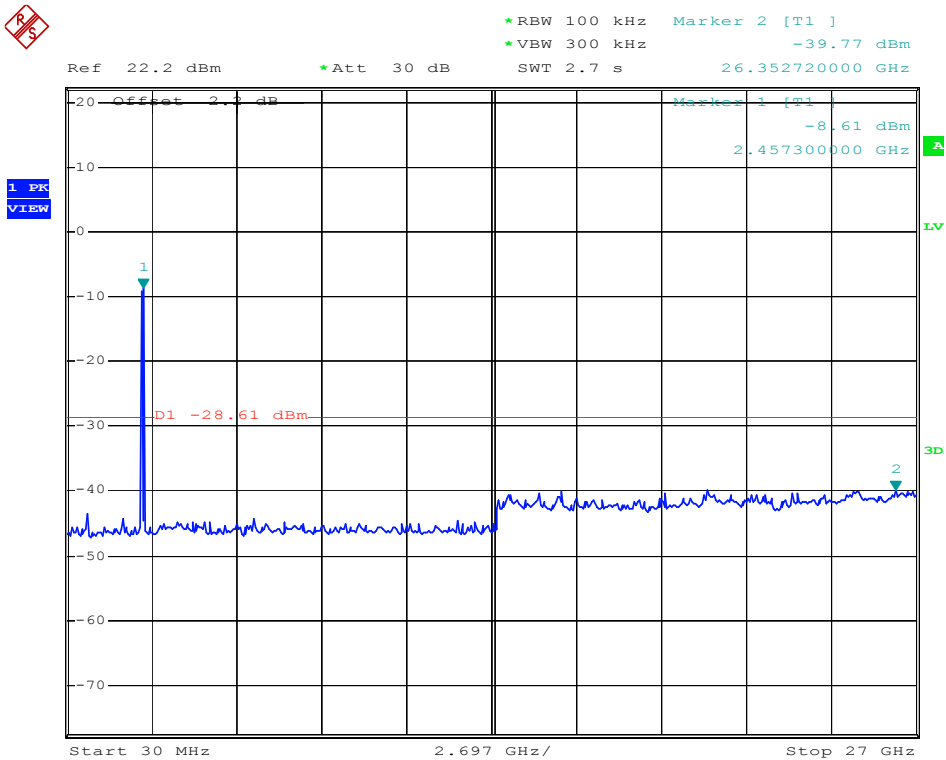

## 9. Out of Band Emissions

---

### 9.1 Standard Applicable

According to §15.247 (d) In any 100 kHz bandwidth outside the frequency band in which the spread spectrum or digitally modulated intentional radiator is operating, the radio frequency power that is produced by the intentional radiator shall be at least 20 dB below that in the 100 kHz bandwidth within the band that contains the highest level of the desired power, based on either an RF conducted or a radiated measurement, provided the transmitter demonstrates compliance with the peak conducted power limits. If the transmitter complies with the conducted power limits based on the use of RMS averaging over a time interval, as permitted under paragraph (b)(3) of this section, the attenuation required under this paragraph shall be 30 dB instead of 20 dB. Attenuation below the general limits specified in §15.209(a) is not required. In addition, radiated emissions which fall in the restricted bands, as defined in §15.205(a), must also comply with the radiated emission limits specified in §15.209(a).

### 9.2 Test Procedure

According to the KDB 558074D01 v04, the band-edge radiated test method as follows:

Set span = wide enough to capture the peak level of the emission operating on the channel closest to the bandedge, as well as any modulation products which fall outside of the authorized band of operation (2310MHz to 2420MHz for low bandedge, 2460MHz to 2500MHz for the high bandedge)

RBW = 1MHz, VBW = 1MHz for peak value measured

RBW = 1MHz, VBW = 10Hz for average value measured

Sweep = auto; Detector function = peak/average; Trace = max hold

All the trace to stabilize, set the marker on the emission at the bandedge, or on the highest modulation product outside of the band, if this level is greater than that at the bandedge. Enable the marker-delta function, then use the marker-to-peak function to move the marker to the peak of the in-band emission. Those emission must comply with the 15.209 limit for fall in the restricted bands listed in section 15.205. Note that the method of measurement KDB publication number: 913591 may be used for the radiated bandedge measurements.

According to the KDB 558074 D01 V04, the conducted spurious emissions test method as follows:

1. Set start frequency to DTS channel edge frequency.
2. Set stop frequency so as to encompass the spectrum to be examined.
3. Set RBW = 100 kHz.
4. Set VBW  $\geq$  300 kHz.
5. Detector = peak.
6. Trace Mode = max hold.
7. Sweep = auto couple.
8. Allow the trace to stabilize (this may take some time, depending on the extent of the span).
9. Use peak marker function to determine maximum amplitude of all unwanted emissions within any 100 kHz bandwidth.

Ensure that the amplitude of all unwanted emissions outside of the authorized frequency band (excluding restricted frequency bands) are attenuated by at least the minimum requirements specified in section 8.1. Report the three highest emissions relative to the limit.

### 9.3 Environmental Conditions

Temperature:	23°C
Relative Humidity:	54%
ATM Pressure:	1011 mbar

### 9.4 Summary of Test Results/Plots

802.11b- Bandedge (Radiated)

Note: we pre-scan all modes, the worst data is 802.11b mode of Chain 1.

Channel	Freq.(MHz)	Reading (dB $\mu$ V)	Factor (dB)	Level(dBuV)	Limit(dBuV)	Margin(dB)	Detector
	2390	52.33	3.54	55.87	74	-18.13	Peak
LOW	2390	39.21	3.54	42.75	54	-11.25	Average
	2483.5	51.57	4.12	55.69	74	-18.31	Peak
HIGH	2483.5	37.45	4.12	41.57	54	-12.43	Average

Note:

Calculation of result is: Result= Reading+ Correction Factor.

Correction Factor =Ant. Factor + Cable Loss – Ampl. Gain.

Bandedge (Conducted)

Chain WIFI 1:  
802.11b-Lowest  
Lowest

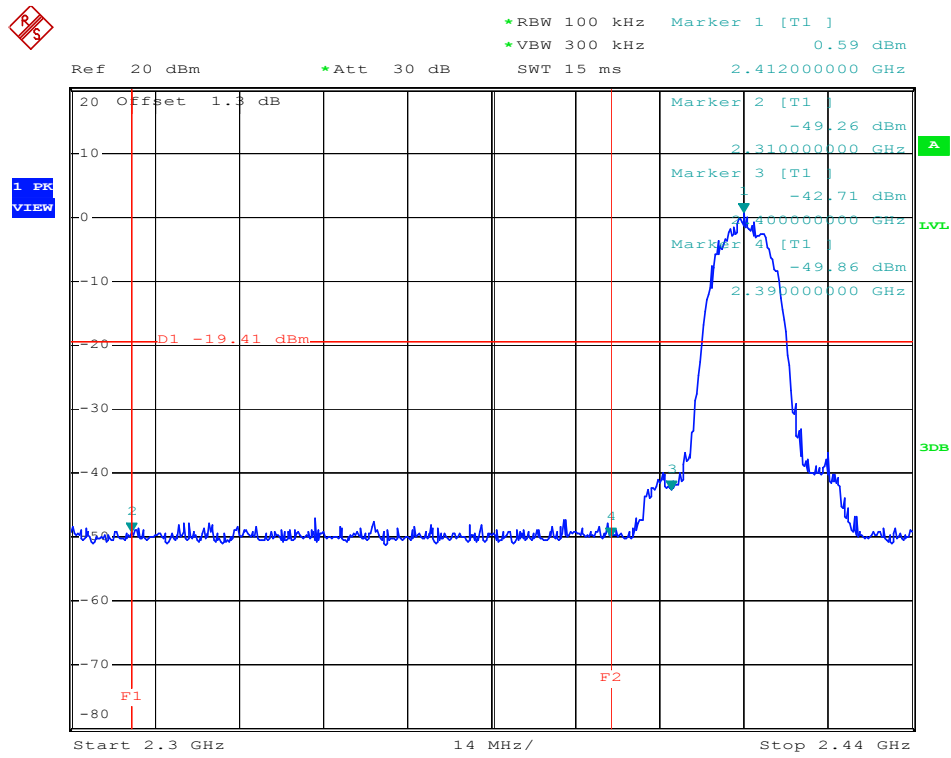

Highest

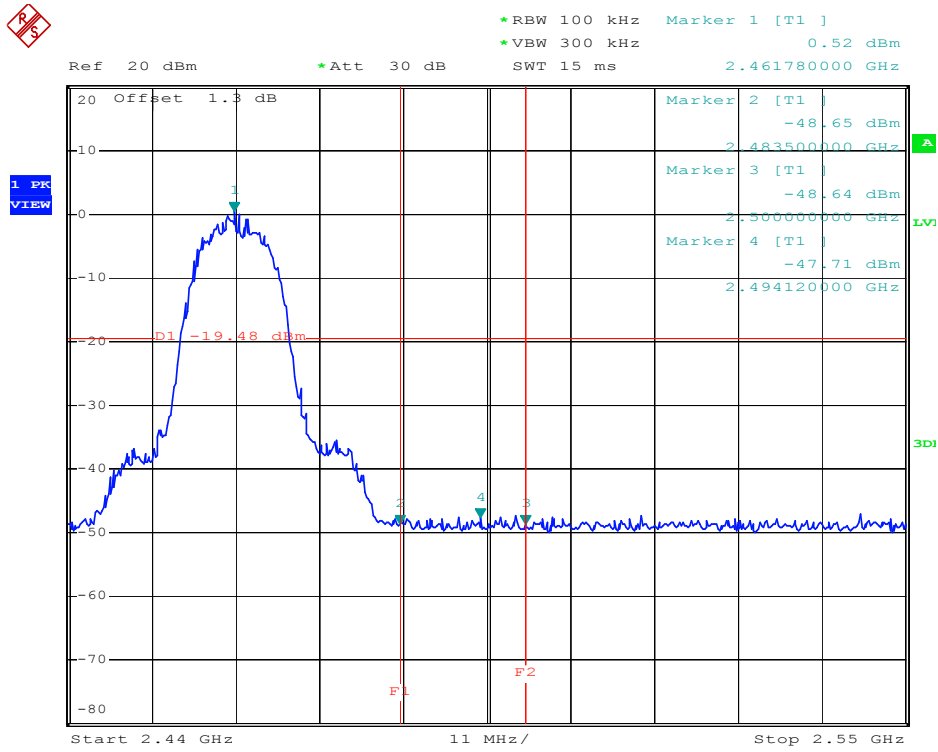

802.11g-Lowest

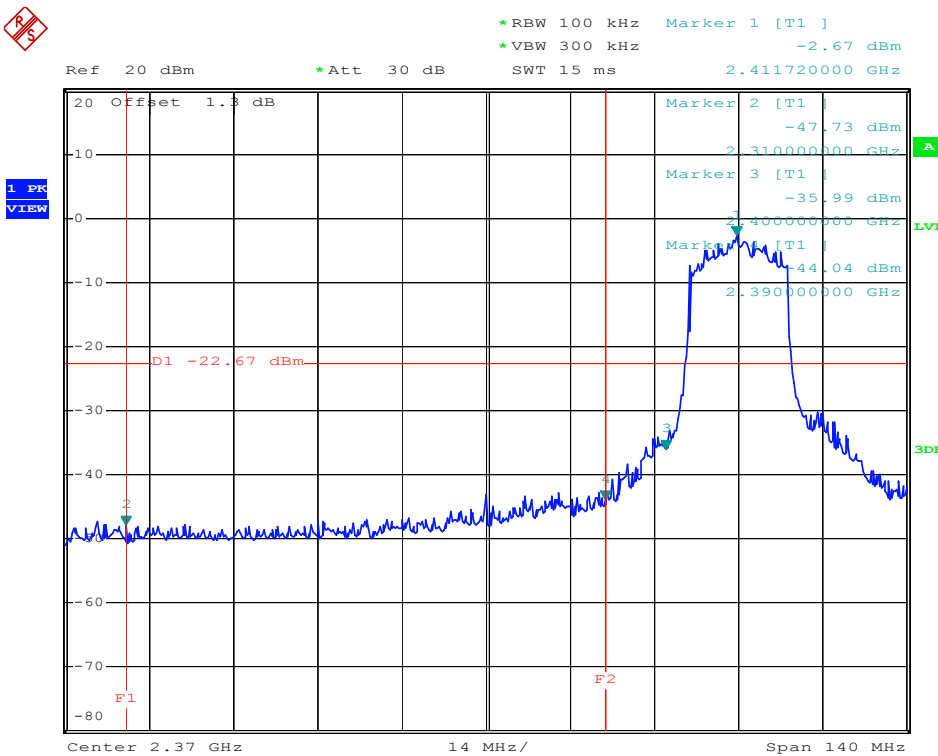

Highest

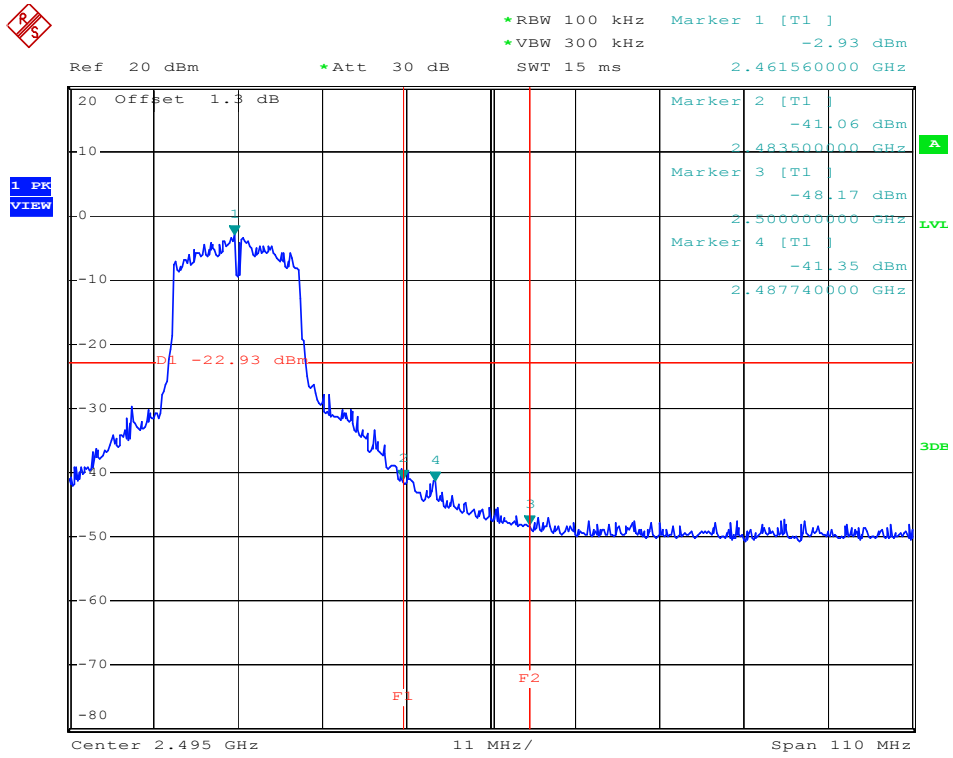

802.11n-HT20-Lowest  
 Lowest

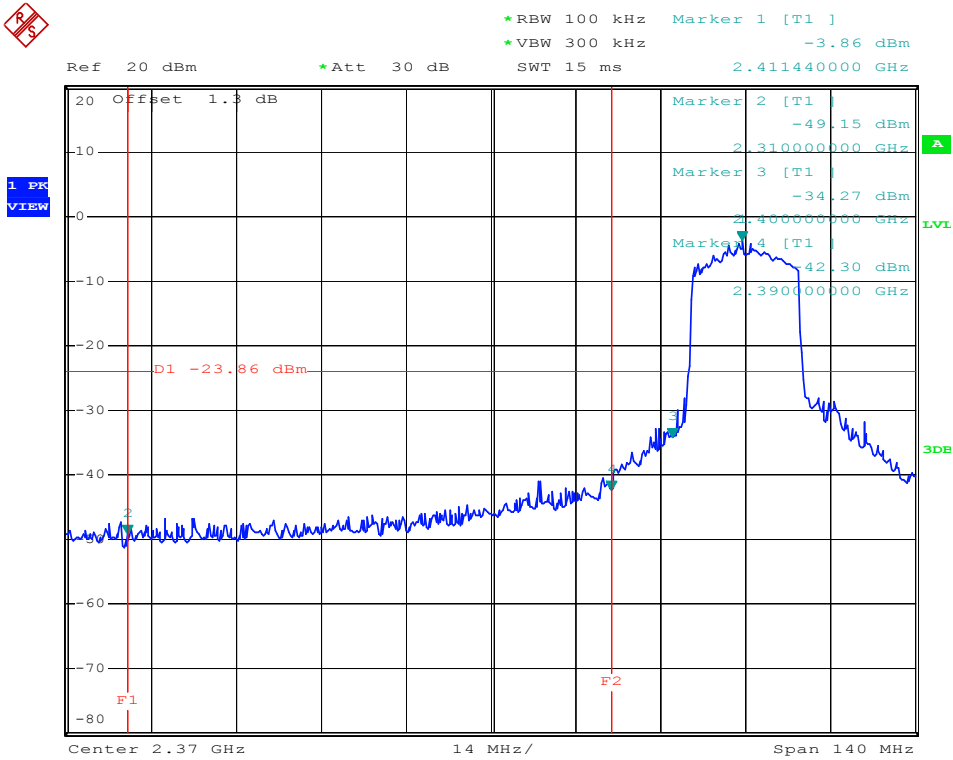

Highest

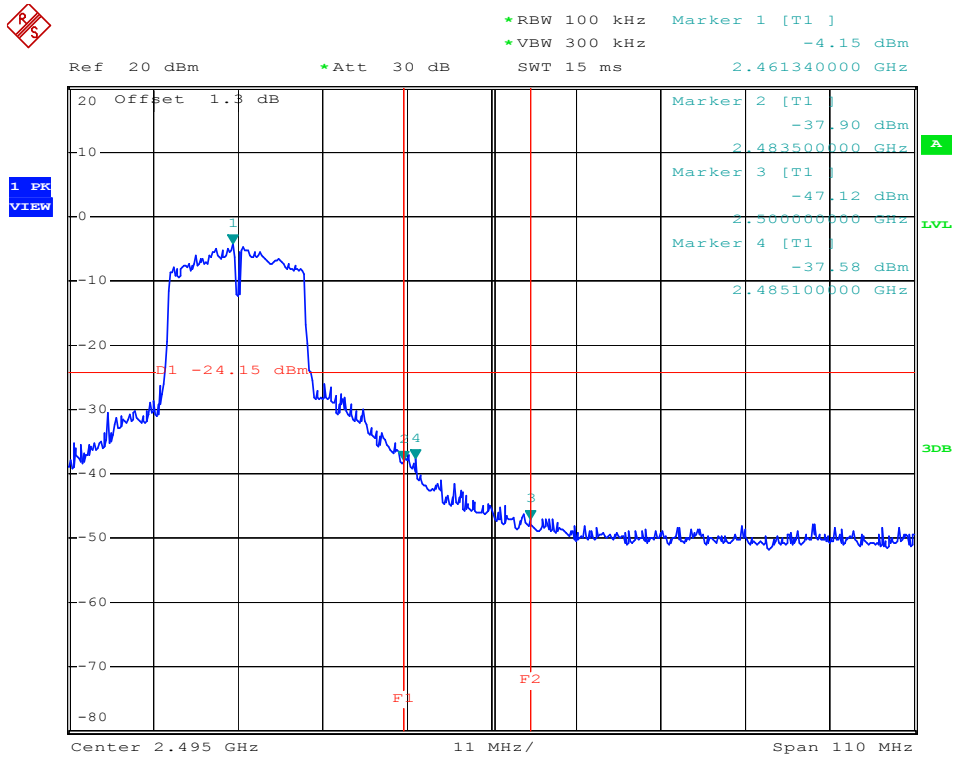

802.11n-HT40-Lowest

Lowest

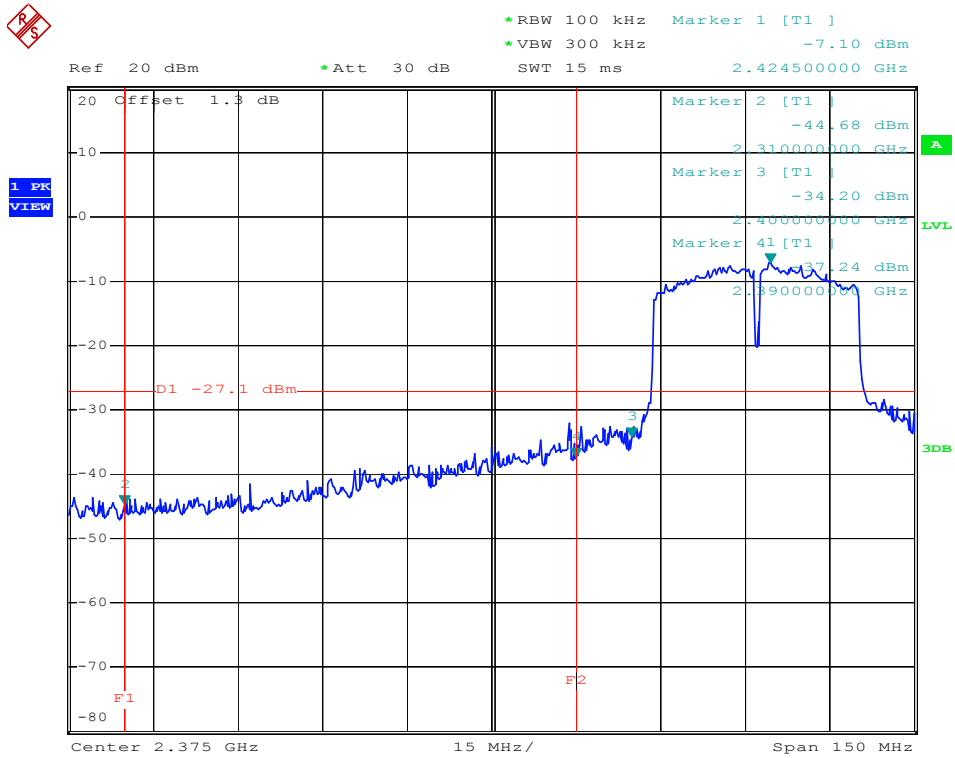

Highest

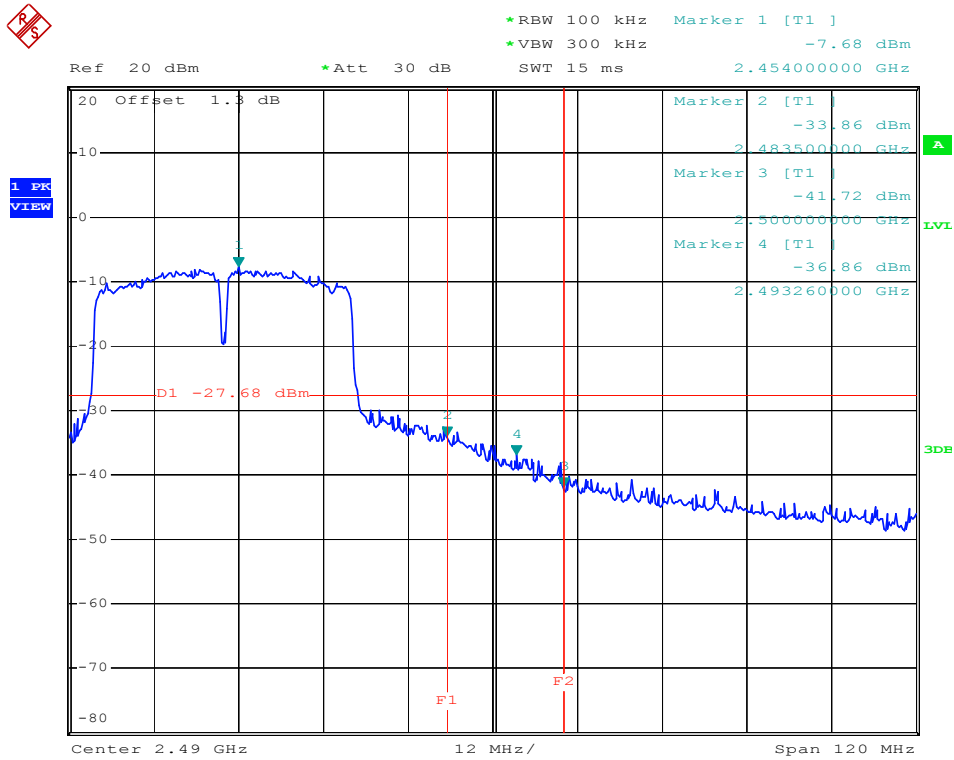

Chain 2:

802.11b-Lowest

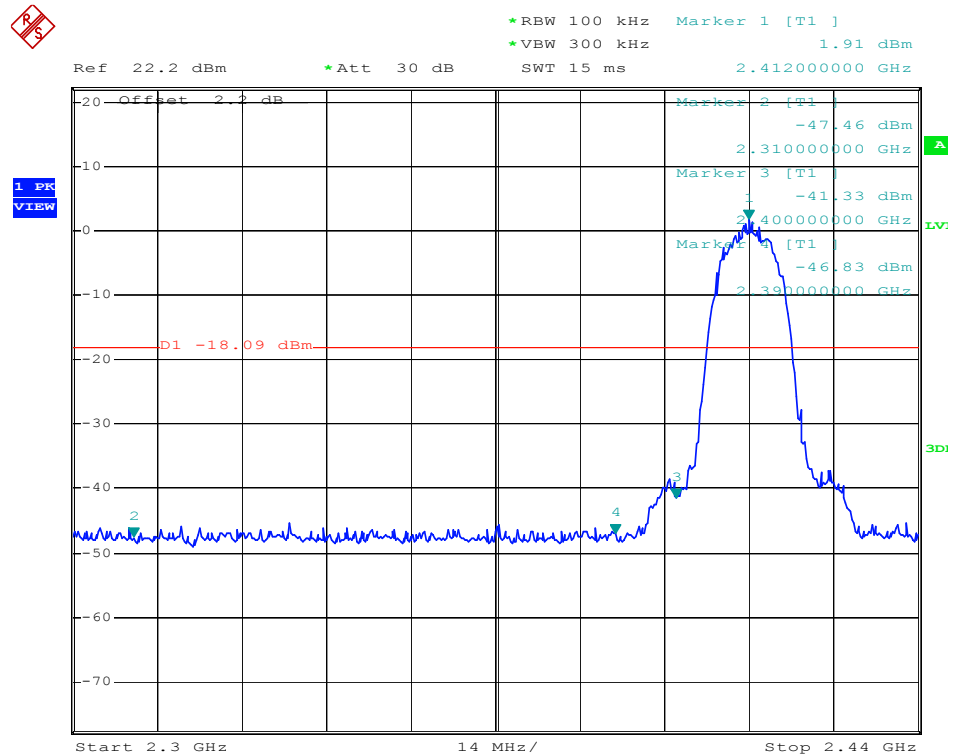



802.11b-Highest

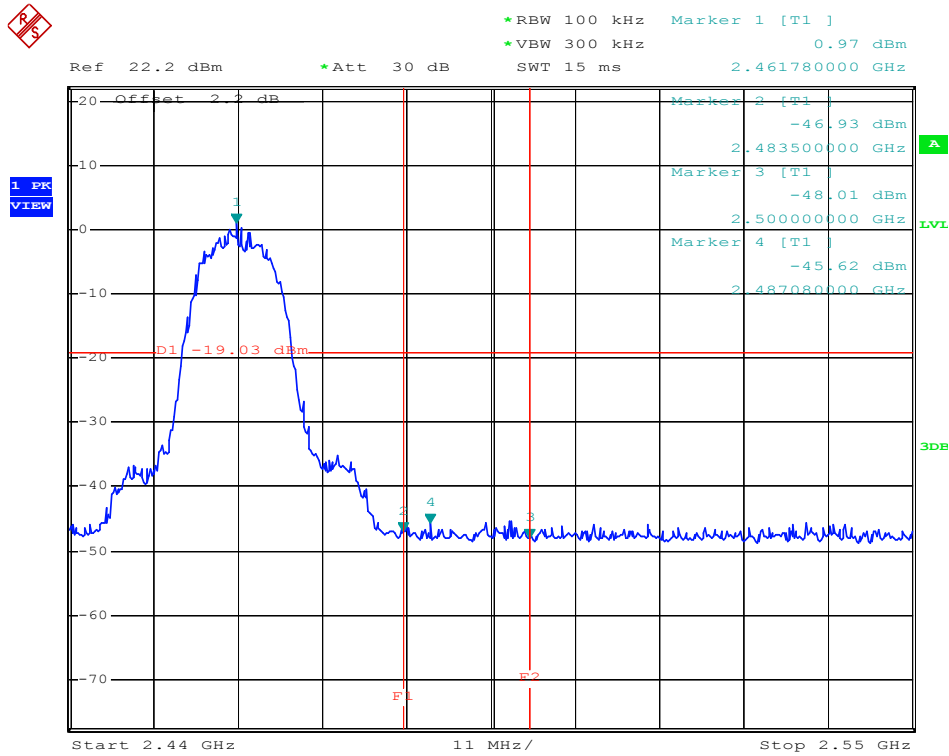

802.11g-Lowest

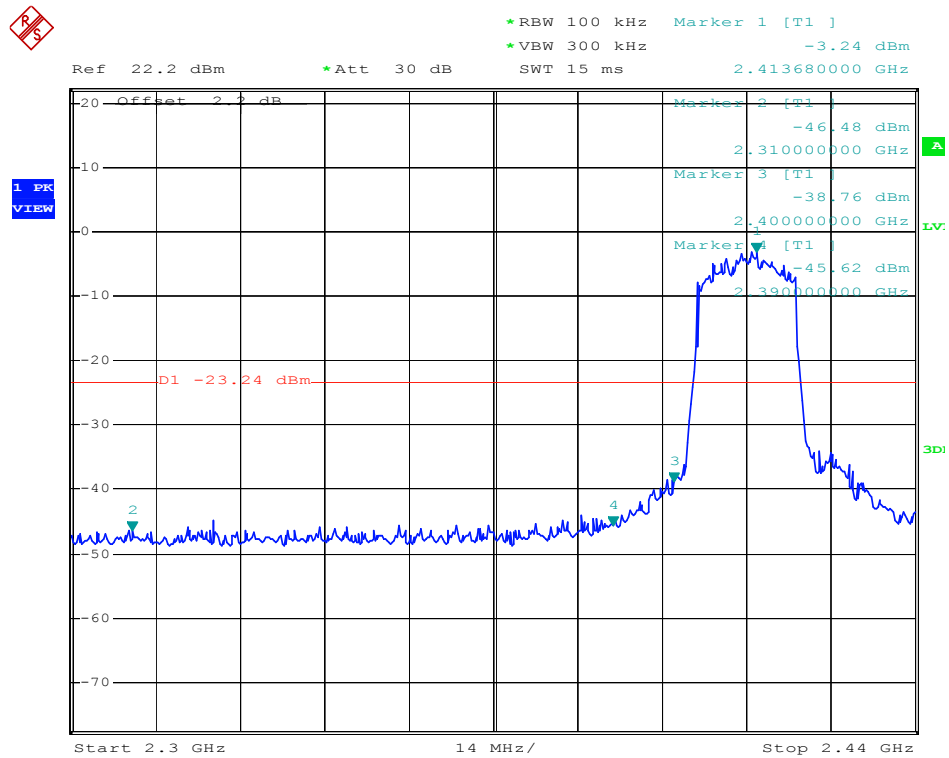

802.11g-Highest

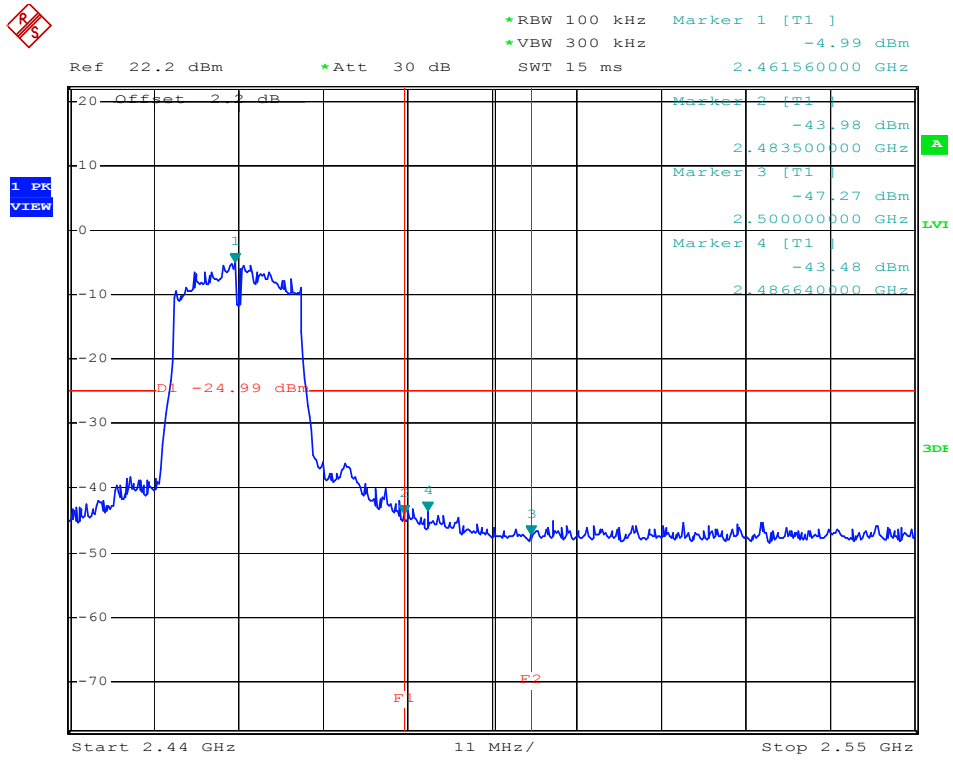

802.11n-HT20-Lowest  
Lowest

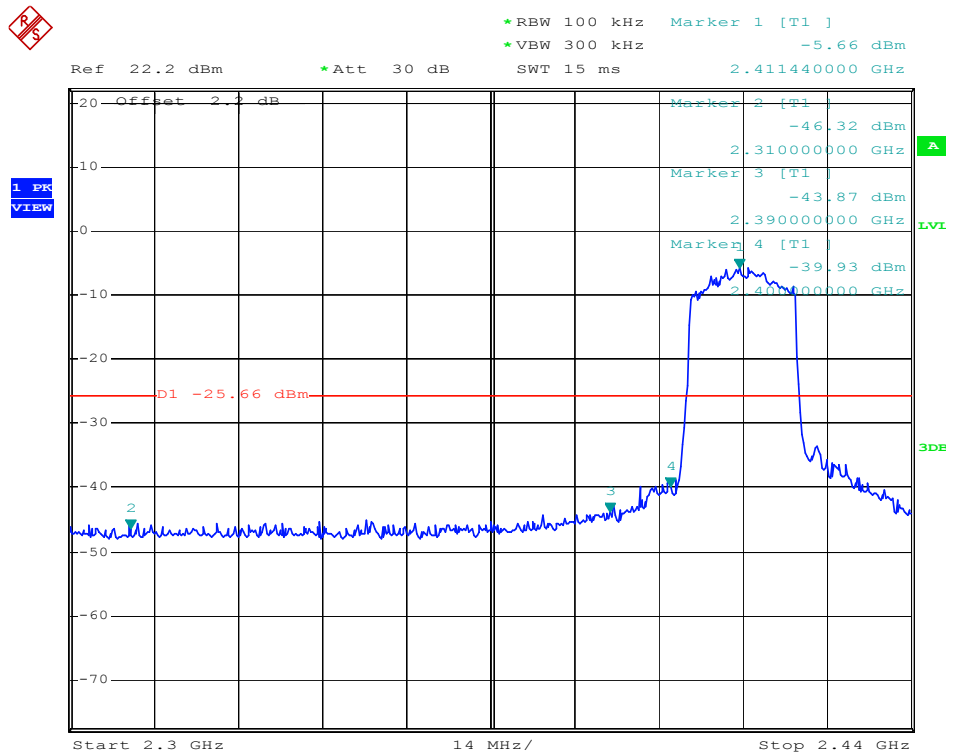

Highest

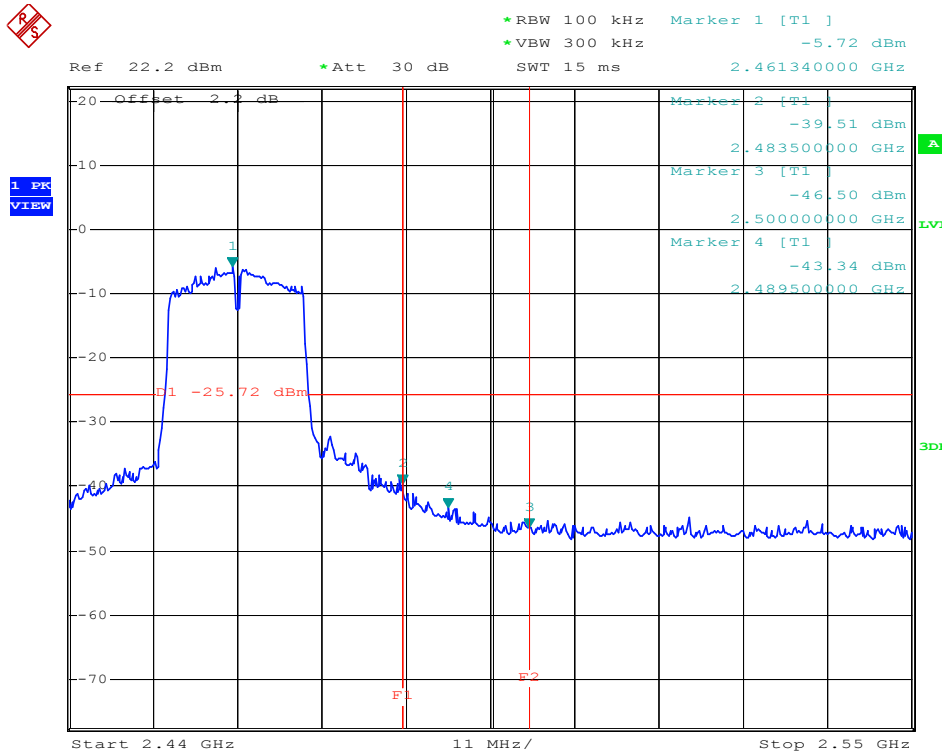

802.11n-HT40-Lowest  
Lowest

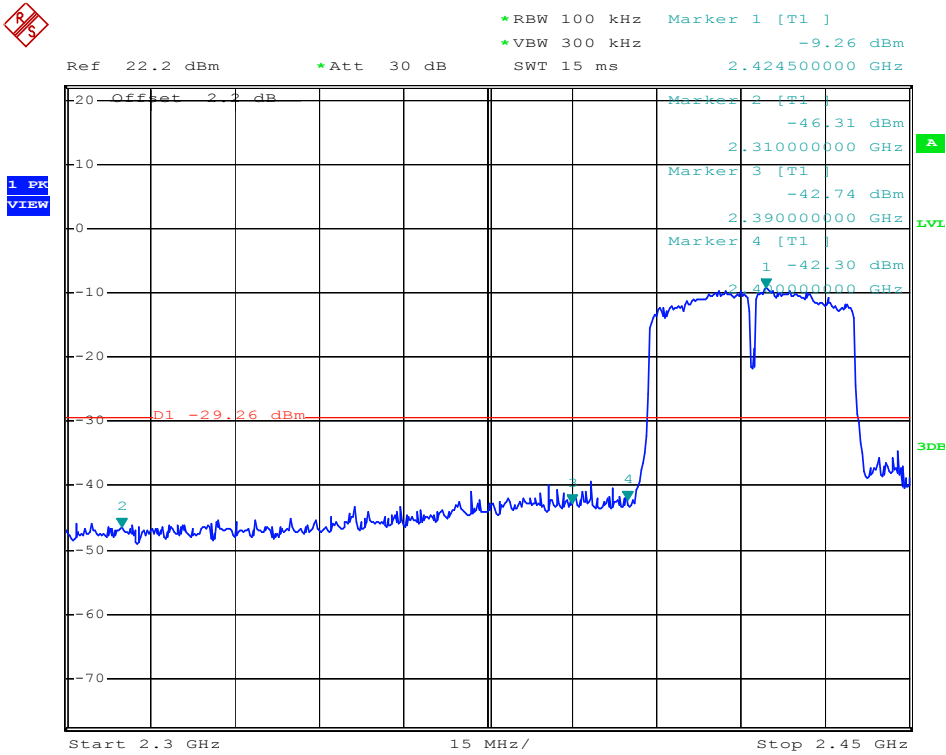

Highest

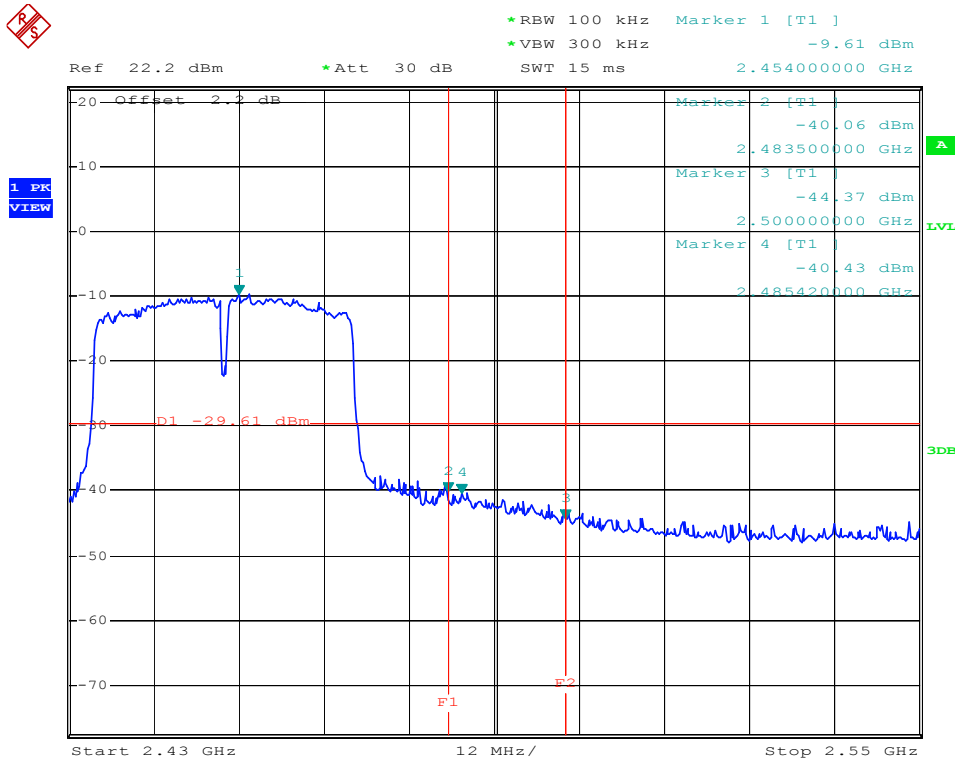

## 10. Conducted Emissions

### 10.1 Measurement Uncertainty

Base on NIS 81, The Treatment of Uncertainty in EMC Measurements, the best estimate of the uncertainty of any conducted emissions measurement is  $\pm 2.88$  dB.

### 10.2 Test Procedure

The setup of EUT is according with per ANSI C63.4-2014 measurement procedure. The specification used was with the FCC Part 15.207 Limit.

The external I/O cables were draped along the test table and formed a bundle 30 to 40 cm long in the middle. The spacing between the peripherals was 10 cm.

### 10.3 Basic Test Setup Block Diagram

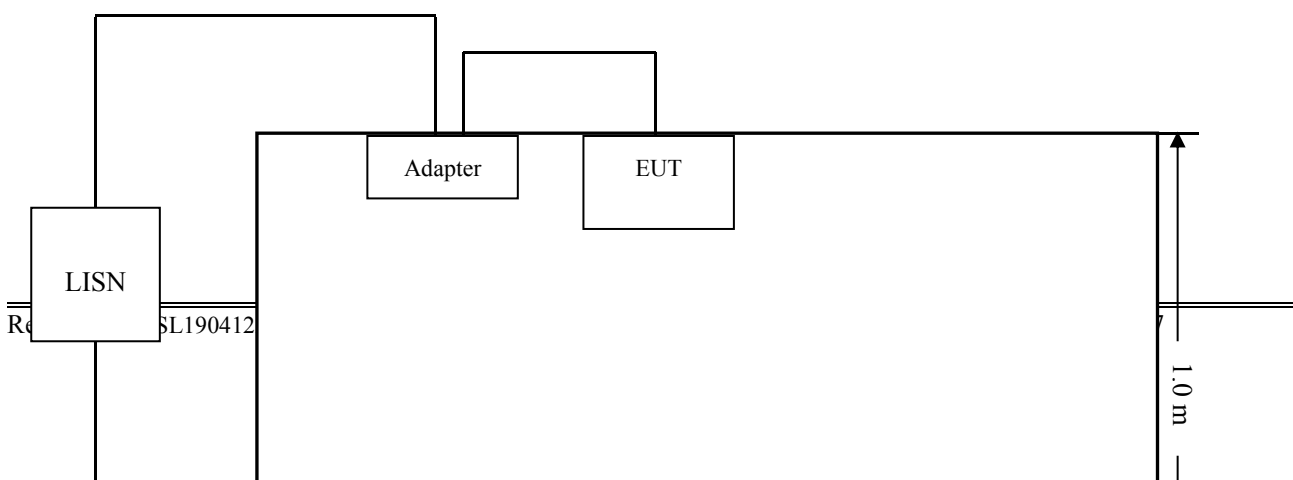

**10.4 Environmental Conditions**

Temperature:	25 °C
Relative Humidity:	52%
ATM Pressure:	1012 mbar

### 10.5 Test Receiver Setup

During the conducted emission test, the test receiver was set with the following configurations:

Start Frequency.....	150 kHz
Stop Frequency.....	30 MHz
Sweep Speed.....	Auto
IF Bandwidth.....	10 kHz
Quasi-Peak Adapter Bandwidth.....	9 kHz
Quasi-Peak Adapter Mode.....	Normal

### 10.6 Summary of Test Results/Plots

According to the data in section 10.7, the EUT complied with the FCC Part 15.207 Conducted margin for this device

Note: we are pre-scan all modes, the worst data is 802.11n HT20(Low) mode of WIFI 1.

### 10.7 Conducted Emissions Test Data

**Plot of Conducted Emissions Test Data**

Test Specification: Neutral

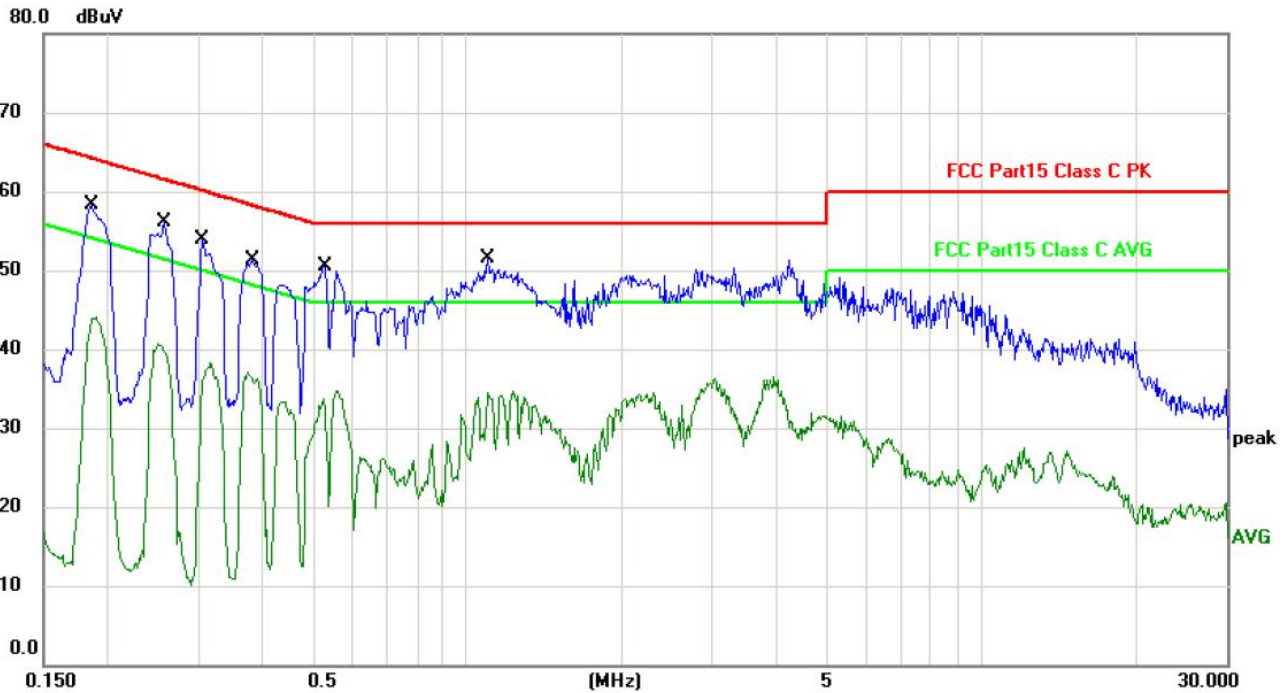

No.	Mk.	Freq. MHz	Reading Level dBuV	Correct Factor dB	Measure- ment dBuV	Limit dBuV	Over dB	Detector	Comment
1		0.1859	57.72	0.60	58.32	64.21	-5.89	QP	
2		0.1859	43.00	0.60	43.60	54.21	-10.61	AVG	
3		0.2580	55.42	0.61	56.03	61.49	-5.46	QP	
4		0.2580	39.82	0.61	40.43	51.49	-11.06	AVG	
5		0.3059	53.29	0.62	53.91	60.08	-6.17	QP	
6		0.3059	37.52	0.62	38.14	50.08	-11.94	AVG	
7		0.3820	50.75	0.64	51.39	58.23	-6.84	QP	
8		0.3820	35.96	0.64	36.60	48.23	-11.63	AVG	
9		0.5299	49.78	0.66	50.44	56.00	-5.56	QP	
10		0.5299	34.07	0.66	34.73	46.00	-11.27	AVG	
11	*	1.0980	50.73	0.68	51.41	56.00	-4.59	QP	
12		1.0980	32.90	0.68	33.58	46.00	-12.42	AVG	

Test Specification: Line

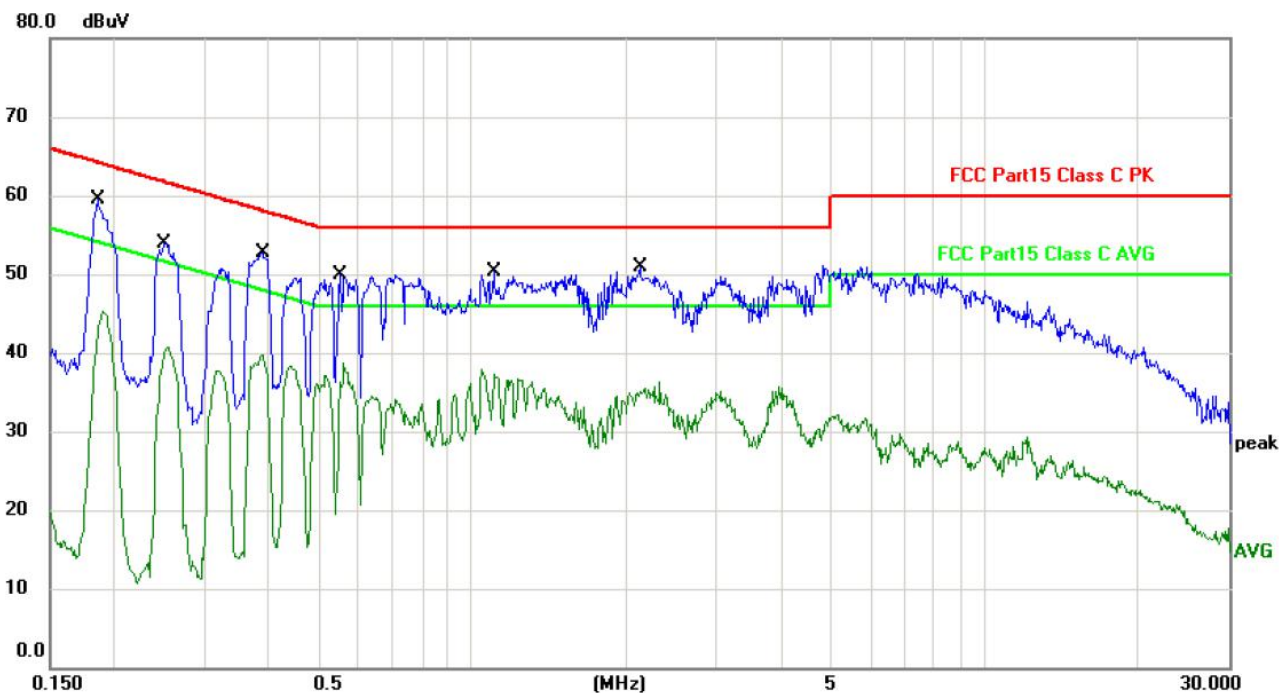

No.	Mk.	Freq. MHz	Reading Level dBuV	Correct Factor dB	Measure- ment dBuV	Limit dBuV	Over dB	Detector	Comment
1	*	0.1859	58.87	0.60	59.47	64.21	-4.74	QP	
2		0.1859	44.73	0.60	45.33	54.21	-8.88	AVG	
3		0.2508	53.33	0.61	53.94	61.73	-7.79	QP	
4		0.2508	39.48	0.61	40.09	51.73	-11.64	AVG	
5		0.3899	52.11	0.64	52.75	58.06	-5.31	QP	
6		0.3899	38.99	0.64	39.63	48.06	-8.43	AVG	
7		0.5540	49.18	0.66	49.84	56.00	-6.16	QP	
8		0.5540	36.99	0.66	37.65	46.00	-8.35	AVG	
9		1.1019	49.56	0.68	50.24	56.00	-5.76	QP	
10		1.1019	36.46	0.68	37.14	46.00	-8.86	AVG	
11		2.1259	50.11	0.77	50.88	56.00	-5.12	QP	
12		2.1259	34.83	0.77	35.60	46.00	-10.40	AVG	

NOTE:

Corret Factor=LISN Factor+Cable loss.

Measurementt=Reading level+Corret Factor.

\*\*\*\*\* END OF REPORT \*\*\*\*\*