

# Test Report

**Report No.:** MTi240425013-06E1

**Date of issue:** 2024-06-18

**Applicant:** ALOGIC Corporation Pty Ltd.

**Product name:** LOC8 Money Clip MagSafe Finder Wallet and Stand

**Model(s):** JKWTCMN, JKWTCBK, JKWTCLG, JKWTCBU,  
JKWTCDB, JKWTCXX (XX : represent colour)

**FCC ID:** 2ATCA-JKWTC

Shenzhen Microtest Co., Ltd.

<http://www.mtitest.cn>

The test report is only used for customer scientific research, teaching, internal quality control and other purposes, and is for internal reference only.



## Instructions

1. This test report shall not be partially reproduced without the written consent of the laboratory.
2. The test results in this test report are only responsible for the samples submitted
3. This test report is invalid without the seal and signature of the laboratory.
4. This test report is invalid if transferred, altered, or tampered with in any form without authorization.
5. Any objection to this test report shall be submitted to the laboratory within 15 days from the date of receipt of the report.

# Table of contents

|          |                                                                 |           |
|----------|-----------------------------------------------------------------|-----------|
| <b>1</b> | <b>General Description .....</b>                                | <b>5</b>  |
| 1.1      | Description of the EUT .....                                    | 5         |
| 1.2      | Description of test modes .....                                 | 5         |
| 1.3      | Environmental Conditions .....                                  | 7         |
| 1.4      | Description of support units .....                              | 7         |
| 1.5      | Measurement uncertainty .....                                   | 7         |
| <b>2</b> | <b>Summary of Test Result .....</b>                             | <b>8</b>  |
| <b>3</b> | <b>Test Facilities and accreditations .....</b>                 | <b>9</b>  |
| 3.1      | Test laboratory .....                                           | 9         |
| <b>4</b> | <b>List of test equipment.....</b>                              | <b>10</b> |
| <b>5</b> | <b>Evaluation Results (Evaluation).....</b>                     | <b>11</b> |
| 5.1      | Antenna requirement .....                                       | 11        |
| <b>6</b> | <b>Radio Spectrum Matter Test Results (RF) .....</b>            | <b>12</b> |
| 6.1      | Conducted Emission at AC power line .....                       | 12        |
| 6.2      | Occupied Bandwidth .....                                        | 15        |
| 6.3      | Maximum Conducted Output Power.....                             | 16        |
| 6.4      | Power Spectral Density .....                                    | 17        |
| 6.5      | RF conducted spurious emissions and band edge measurement ..... | 18        |
| 6.6      | Band edge emissions (Radiated) .....                            | 19        |
| 6.7      | Radiated emissions (below 1GHz) .....                           | 22        |
| 6.8      | Radiated emissions (above 1GHz).....                            | 25        |
|          | <b>Photographs of the test setup .....</b>                      | <b>29</b> |
|          | <b>Photographs of the EUT.....</b>                              | <b>30</b> |
|          | <b>Appendix A: DTS Bandwidth .....</b>                          | <b>32</b> |
|          | <b>Appendix B: Maximum conducted output power.....</b>          | <b>34</b> |
|          | <b>Appendix C: Maximum power spectral density.....</b>          | <b>36</b> |
|          | <b>Appendix D: Band edge measurements .....</b>                 | <b>38</b> |
|          | <b>Appendix E: Conducted Spurious Emission .....</b>            | <b>39</b> |
|          | <b>Appendix F: Duty Cycle .....</b>                             | <b>42</b> |

| <b>Test Result Certification</b> |                                                                    |
|----------------------------------|--------------------------------------------------------------------|
| <b>Applicant:</b>                | ALOGIC Corporation Pty Ltd.                                        |
| Address:                         | Level 40,140 William Street, Melbourne VIC, 3000 Australia         |
| <b>Manufacturer:</b>             | ALOGIC Corporation Pty Ltd.                                        |
| Address:                         | Level 40,140 William Street, Melbourne VIC, 3000 Australia         |
| <b>Product description</b>       |                                                                    |
| Product name:                    | LOC8 Money Clip MagSafe Finder Wallet and Stand                    |
| Trademark:                       | Journey, JR-NY, JRNY                                               |
| Model name:                      | JKWTCMN                                                            |
| Series Model(s):                 | JKWTCBK, JKWTCLG, JKWTCBU, JKWTCDB,JKWTCXX (XX : represent colour) |
| Standards:                       | 47 CFR Part 15.247                                                 |
| Test Method:                     | ANSI C63.10-2013<br>KDB 558074 D01 15.247 Meas Guidance v05r02     |
| <b>Date of Test</b>              |                                                                    |
| Date of test:                    | 2024-05-22 to 2024-06-12                                           |
| Test result:                     | Pass                                                               |

|                      |   |                   |
|----------------------|---|-------------------|
| <b>Test Engineer</b> | : | <i>James Qin</i>  |
|                      |   | (James Qin)       |
| <b>Reviewed By</b>   | : | <i>David. Lee</i> |
|                      |   | (David Lee)       |
| <b>Approved By</b>   | : | <i>Leon Chen</i>  |
|                      |   | (Leon Chen)       |

## 1 General Description

### 1.1 Description of the EUT

|                            |                                                                                  |
|----------------------------|----------------------------------------------------------------------------------|
| Product name:              | LOC8 Money Clip MagSafe Finder Wallet and Stand                                  |
| Model name:                | JKWTCMN                                                                          |
| Series Model(s):           | JKWTCBK, JKWTCLG, JKWTCBU, JKWTCDB,JKWTCXX (XX : represent colour)               |
| Model difference:          | All the models are the same circuit and module, except the model name and color. |
| Electrical rating:         | Input: DC 5V<br>Battery Capacity: DC 3.7V 150mAh                                 |
| Accessories:               | Cable: Type-C charging cable (0.5m)*1                                            |
| Hardware version:          | MF04Pro-V10                                                                      |
| Software version:          | 1.01                                                                             |
| Test sample(s) number:     | MTi240425013-06S1001                                                             |
| <b>RF specification</b>    |                                                                                  |
| Bluetooth version:         | V5.2                                                                             |
| Operating frequency range: | 2402MHz to 2480MHz                                                               |
| Channel number:            | 40                                                                               |
| Modulation type:           | GFSK                                                                             |
| Antenna(s) type:           | PCB                                                                              |
| Antenna(s) gain:           | 0.8dBi                                                                           |

### 1.2 Description of test modes

| No.   | Emission test modes |
|-------|---------------------|
| Mode1 | TX mode (GFSK-2M)   |

#### 1.2.1 Operation channel list

| Channel | Frequency (MHz) | Channel | Frequency (MHz) | Channel | Frequency (MHz) | Channel | Frequency (MHz) |
|---------|-----------------|---------|-----------------|---------|-----------------|---------|-----------------|
| 0       | 2402            | 10      | 2422            | 20      | 2442            | 30      | 2462            |
| 1       | 2404            | 11      | 2424            | 21      | 2444            | 31      | 2464            |
| 2       | 2406            | 12      | 2426            | 22      | 2446            | 32      | 2466            |
| 3       | 2408            | 13      | 2428            | 23      | 2448            | 33      | 2468            |
| 4       | 2410            | 14      | 2430            | 24      | 2450            | 34      | 2470            |
| 5       | 2412            | 15      | 2432            | 25      | 2452            | 35      | 2472            |
| 6       | 2414            | 16      | 2434            | 26      | 2454            | 36      | 2474            |
| 7       | 2416            | 17      | 2436            | 27      | 2456            | 37      | 2476            |
| 8       | 2418            | 18      | 2438            | 28      | 2458            | 38      | 2478            |
| 9       | 2420            | 19      | 2440            | 29      | 2460            | 39      | 2480            |

**Test Channel List****Operation Band: 2400-2483.5 MHz**

| Bandwidth (MHz) | Lowest Channel (LCH) (MHz) | Middle Channel (MCH) (MHz) | Highest Channel (HCH) (MHz) |
|-----------------|----------------------------|----------------------------|-----------------------------|
| 2               | 2402                       | 2440                       | 2480                        |

Note: The test software provided by manufacturer is used to control EUT for working in engineering mode, that enables selectable channel, and capable of continuous transmitting mode.

**Test Software: EMI\_TEST\_V2.1**

For power setting, refer to below table.

| Mode | 2402MHz | 2440MHz | 2480MHz |
|------|---------|---------|---------|
| 2M   | -24.3   | -24.3   | -24.3   |

### 1.3 Environmental Conditions

During the measurement the environmental conditions were within the listed ranges:

|                       |                  |
|-----------------------|------------------|
| Temperature:          | 15°C ~ 35°C      |
| Humidity:             | 20% RH ~ 75% RH  |
| Atmospheric pressure: | 98 kPa ~ 101 kPa |

### 1.4 Description of support units

| Support equipment list |            |            |              |
|------------------------|------------|------------|--------------|
| Description            | Model      | Serial No. | Manufacturer |
| Adapter                | EP-TA200   | /          | SAMSUNG      |
| Support cable list     |            |            |              |
| Description            | Length (m) | From       | To           |
| /                      | /          | /          | /            |

### 1.5 Measurement uncertainty

| Measurement                              | Uncertainty |
|------------------------------------------|-------------|
| Conducted emissions (AMN 150kHz~30MHz)   | ±3.1dB      |
| Occupied channel bandwidth               | ±3 %        |
| RF output power, conducted               | ±1 dB       |
| Power Spectral Density, conducted        | ±1 dB       |
| Unwanted Emissions, conducted            | ±1 dB       |
| Radiated spurious emissions (above 1GHz) | ±5.3dB      |
| Radiated spurious emissions (9kHz~30MHz) | ±4.3dB      |
| Radiated spurious emissions (30MHz~1GHz) | ±4.7dB      |
| Temperature                              | ±1 °C       |
| Humidity                                 | ± 5 %       |

This uncertainty represents an expanded uncertainty expressed at approximately the 95% confidence level using a coverage factor of k=2.

## 2 Summary of Test Result

| No. | Item                                                      | Standard           | Requirement                      | Result |
|-----|-----------------------------------------------------------|--------------------|----------------------------------|--------|
| 1   | Antenna requirement                                       | 47 CFR Part 15.247 | 47 CFR 15.203                    | Pass   |
| 2   | Conducted Emission at AC power line                       | 47 CFR Part 15.247 | 47 CFR 15.207(a)                 | Pass   |
| 3   | Occupied Bandwidth                                        | 47 CFR Part 15.247 | 47 CFR 15.247(a)(2)              | Pass   |
| 4   | Maximum Conducted Output Power                            | 47 CFR Part 15.247 | 47 CFR 15.247(b)(3)              | Pass   |
| 5   | Power Spectral Density                                    | 47 CFR Part 15.247 | 47 CFR 15.247(e)                 | Pass   |
| 6   | RF conducted spurious emissions and band edge measurement | 47 CFR Part 15.247 | 47 CFR 15.247(d), 15.209, 15.205 | Pass   |
| 7   | Band edge emissions (Radiated)                            | 47 CFR Part 15.247 | 47 CFR 15.247(d), 15.209, 15.205 | Pass   |
| 8   | Radiated emissions (below 1GHz)                           | 47 CFR Part 15.247 | 47 CFR 15.247(d), 15.209, 15.205 | Pass   |
| 9   | Radiated emissions (above 1GHz)                           | 47 CFR Part 15.247 | 47 CFR 15.247(d), 15.209, 15.205 | Pass   |



### 3 Test Facilities and accreditations

#### 3.1 Test laboratory

|                        |                                                                                                                                      |
|------------------------|--------------------------------------------------------------------------------------------------------------------------------------|
| Test laboratory:       | Shenzhen Microtest Co., Ltd.                                                                                                         |
| Test site location:    | 101, No.7, Zone 2, Xinxing Industrial Park, Fuhai Avenue, Xinhe Community, Fuhai Street, Bao'an District, Shenzhen, Guangdong, China |
| Telephone:             | (86-755)88850135                                                                                                                     |
| Fax:                   | (86-755)88850136                                                                                                                     |
| CNAS Registration No.: | CNAS L5868                                                                                                                           |
| FCC Registration No.:  | 448573                                                                                                                               |
| IC Registration No.:   | 21760                                                                                                                                |
| CABID:                 | CN0093                                                                                                                               |

#### 4 List of test equipment

| No.                                                                                                                           | Equipment                            | Manufacturer    | Model       | Serial No. | Cal. date  | Cal. Due   |
|-------------------------------------------------------------------------------------------------------------------------------|--------------------------------------|-----------------|-------------|------------|------------|------------|
| Conducted Emission at AC power line                                                                                           |                                      |                 |             |            |            |            |
| 1                                                                                                                             | EMI Test Receiver                    | Rohde&schwarz   | ESCI3       | 101368     | 2024-03-20 | 2025-03-19 |
| 2                                                                                                                             | Artificial mains network             | Schwarzbeck     | NSLK 8127   | 183        | 2024-03-21 | 2025-03-20 |
| 3                                                                                                                             | Artificial Mains Network             | Rohde & Schwarz | ESH2-Z5     | 100263     | 2024-03-20 | 2025-03-19 |
| Occupied Bandwidth<br>Maximum Conducted Output Power<br>Power Spectral Density<br>Emissions in non-restricted frequency bands |                                      |                 |             |            |            |            |
| 1                                                                                                                             | Wideband Radio Communication Tester  | Rohde&schwarz   | CMW500      | 149155     | 2024-03-20 | 2025-03-19 |
| 2                                                                                                                             | ESG Series Analog Signal Generator   | Agilent         | E4421B      | GB40051240 | 2024-03-21 | 2025-03-20 |
| 3                                                                                                                             | PXA Signal Analyzer                  | Agilent         | N9030A      | MY51350296 | 2024-03-21 | 2025-03-20 |
| 4                                                                                                                             | Synthesized Sweeper                  | Agilent         | 83752A      | 3610A01957 | 2024-03-21 | 2025-03-20 |
| 5                                                                                                                             | MXA Signal Analyzer                  | Agilent         | N9020A      | MY50143483 | 2024-03-21 | 2025-03-20 |
| 6                                                                                                                             | RF Control Unit                      | Tonscend        | JS0806-1    | 19D8060152 | 2024-03-21 | 2025-03-20 |
| 7                                                                                                                             | Band Reject Filter Group             | Tonscend        | JS0806-F    | 19D8060160 | 2024-03-21 | 2025-03-20 |
| 8                                                                                                                             | ESG Vector Signal Generator          | Agilent         | N5182A      | MY50143762 | 2024-03-20 | 2025-03-19 |
| 9                                                                                                                             | DC Power Supply                      | Agilent         | E3632A      | MY40027695 | 2024-03-21 | 2025-03-20 |
| Band edge emissions (Radiated)<br>Emissions in frequency bands (above 1GHz)                                                   |                                      |                 |             |            |            |            |
| 1                                                                                                                             | EMI Test Receiver                    | Rohde&schwarz   | ESCI7       | 101166     | 2024-03-20 | 2025-03-19 |
| 2                                                                                                                             | Double Ridged Broadband Horn Antenna | schwarabeck     | BBHA 9120 D | 2278       | 2023-06-17 | 2025-06-16 |
| 3                                                                                                                             | Amplifier                            | Agilent         | 8449B       | 3008A01120 | 2024-03-20 | 2025-03-19 |
| 4                                                                                                                             | MXA signal analyzer                  | Agilent         | N9020A      | MY54440859 | 2024-03-21 | 2025-03-20 |
| 5                                                                                                                             | PXA Signal Analyzer                  | Agilent         | N9030A      | MY51350296 | 2024-03-21 | 2025-03-20 |
| 6                                                                                                                             | Horn antenna                         | Schwarzbeck     | BBHA 9170   | 00987      | 2023-06-17 | 2025-06-16 |
| 7                                                                                                                             | Pre-amplifier                        | Space-Dtronics  | EWLAN1840 G | 210405001  | 2024-03-21 | 2025-03-20 |
| Emissions in frequency bands (below 1GHz)                                                                                     |                                      |                 |             |            |            |            |
| 1                                                                                                                             | EMI Test Receiver                    | Rohde&schwarz   | ESCI7       | 101166     | 2024-03-20 | 2025-03-19 |
| 2                                                                                                                             | TRILOG Broadband Antenna             | schwarabeck     | VULB 9163   | 9163-1338  | 2023-06-11 | 2025-06-10 |
| 3                                                                                                                             | Active Loop Antenna                  | Schwarzbeck     | FMZB 1519 B | 00066      | 2024-03-23 | 2025-03-22 |
| 4                                                                                                                             | Amplifier                            | Hewlett-Packard | 8447F       | 3113A06184 | 2024-03-20 | 2025-03-19 |

## 5 Evaluation Results (Evaluation)

### 5.1 Antenna requirement

|                   |                                                                                                                                                                                                                                                                                                                                                                                     |
|-------------------|-------------------------------------------------------------------------------------------------------------------------------------------------------------------------------------------------------------------------------------------------------------------------------------------------------------------------------------------------------------------------------------|
| Test Requirement: | Refer to 47 CFR Part 15.203, an intentional radiator shall be designed to ensure that no antenna other than that furnished by the responsible party shall be used with the device. The use of a permanently attached antenna or of an antenna that uses a unique coupling to the intentional radiator shall be considered sufficient to comply with the provisions of this section. |
|-------------------|-------------------------------------------------------------------------------------------------------------------------------------------------------------------------------------------------------------------------------------------------------------------------------------------------------------------------------------------------------------------------------------|

#### 5.1.1 Conclusion:

|                                                                                                              |
|--------------------------------------------------------------------------------------------------------------|
| The antenna of the EUT is permanently attached.<br>The EUT complies with the requirement of FCC PART 15.203. |
|--------------------------------------------------------------------------------------------------------------|

## 6 Radio Spectrum Matter Test Results (RF)

### 6.1 Conducted Emission at AC power line

|                                                 |                                                                                                                                                                                                                                                                                                                                                                                                                                                                                 |                              |           |
|-------------------------------------------------|---------------------------------------------------------------------------------------------------------------------------------------------------------------------------------------------------------------------------------------------------------------------------------------------------------------------------------------------------------------------------------------------------------------------------------------------------------------------------------|------------------------------|-----------|
| Test Requirement:                               | Refer to 47 CFR 15.207(a), Except as shown in paragraphs (b) and (c) of this section, for an intentional radiator that is designed to be connected to the public utility (AC) power line, the radio frequency voltage that is conducted back onto the AC power line on any frequency or frequencies, within the band 150 kHz to 30 MHz, shall not exceed the limits in the following table, as measured using a 50 $\mu$ H/50 ohms line impedance stabilization network (LISN). |                              |           |
| Test Limit:                                     | Frequency of emission (MHz)                                                                                                                                                                                                                                                                                                                                                                                                                                                     | Conducted limit (dB $\mu$ V) |           |
|                                                 |                                                                                                                                                                                                                                                                                                                                                                                                                                                                                 | Quasi-peak                   | Average   |
|                                                 | 0.15-0.5                                                                                                                                                                                                                                                                                                                                                                                                                                                                        | 66 to 56*                    | 56 to 46* |
|                                                 | 0.5-5                                                                                                                                                                                                                                                                                                                                                                                                                                                                           | 56                           | 46        |
|                                                 | 5-30                                                                                                                                                                                                                                                                                                                                                                                                                                                                            | 60                           | 50        |
| *Decreases with the logarithm of the frequency. |                                                                                                                                                                                                                                                                                                                                                                                                                                                                                 |                              |           |
| Test Method:                                    | ANSI C63.10-2013 section 6.2                                                                                                                                                                                                                                                                                                                                                                                                                                                    |                              |           |
| Procedure:                                      | Refer to ANSI C63.10-2013 section 6.2, standard test method for ac power-line conducted emissions from unlicensed wireless devices                                                                                                                                                                                                                                                                                                                                              |                              |           |

#### 6.1.1 E.U.T. Operation:

|                        |       |           |      |                       |         |
|------------------------|-------|-----------|------|-----------------------|---------|
| Operating Environment: |       |           |      |                       |         |
| Temperature:           | 25 °C | Humidity: | 58 % | Atmospheric Pressure: | 100 kPa |
| Pre test mode:         | Mode1 |           |      |                       |         |
| Final test mode:       | Mode1 |           |      |                       |         |

#### 6.1.2 Test Setup Diagram:

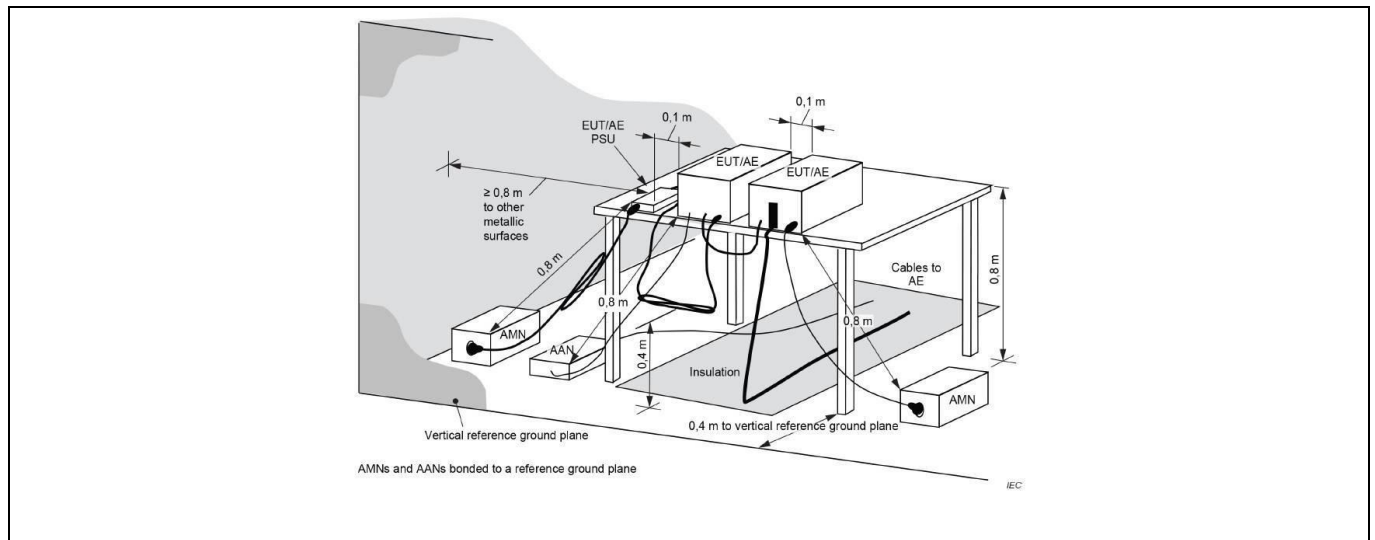

**6.1.3 Test Data:**

Mode1 / Line: Line

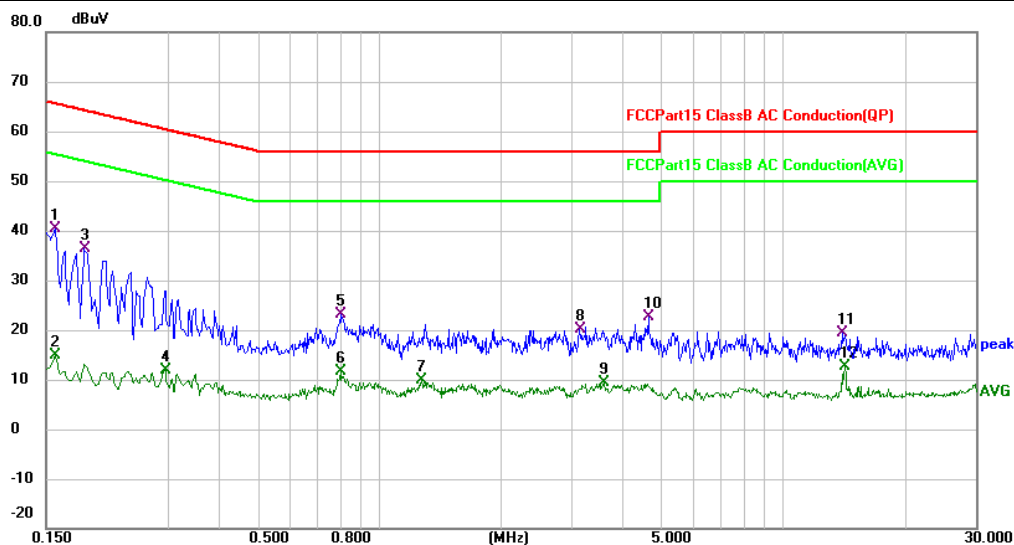

| No. | Mk. | Freq.<br>MHz | Reading<br>Level<br>dBuV | Correct<br>Factor<br>dB | Measure-<br>ment<br>dBuV | Limit<br>dBuV | Over<br>dB | Detector | Comment |
|-----|-----|--------------|--------------------------|-------------------------|--------------------------|---------------|------------|----------|---------|
| 1   | *   | 0.1580       | 30.09                    | 10.38                   | 40.47                    | 65.57         | -25.10     | QP       |         |
| 2   |     | 0.1580       | 4.50                     | 10.38                   | 14.88                    | 55.57         | -40.69     | AVG      |         |
| 3   |     | 0.1860       | 25.62                    | 10.76                   | 36.38                    | 64.21         | -27.83     | QP       |         |
| 4   |     | 0.2940       | 0.92                     | 11.02                   | 11.94                    | 50.41         | -38.47     | AVG      |         |
| 5   |     | 0.8020       | 10.95                    | 12.17                   | 23.12                    | 56.00         | -32.88     | QP       |         |
| 6   |     | 0.8020       | -0.53                    | 12.17                   | 11.64                    | 46.00         | -34.36     | AVG      |         |
| 7   |     | 1.2740       | -3.22                    | 13.16                   | 9.94                     | 46.00         | -36.06     | AVG      |         |
| 8   |     | 3.1420       | 9.57                     | 10.64                   | 20.21                    | 56.00         | -35.79     | QP       |         |
| 9   |     | 3.6180       | -1.37                    | 10.64                   | 9.27                     | 46.00         | -36.73     | AVG      |         |
| 10  |     | 4.6500       | 12.10                    | 10.65                   | 22.75                    | 56.00         | -33.25     | QP       |         |
| 11  |     | 14.0300      | 8.52                     | 10.98                   | 19.50                    | 60.00         | -40.50     | QP       |         |
| 12  |     | 14.2139      | 1.59                     | 10.98                   | 12.57                    | 50.00         | -37.43     | AVG      |         |

Mode1 / Line: Neutral

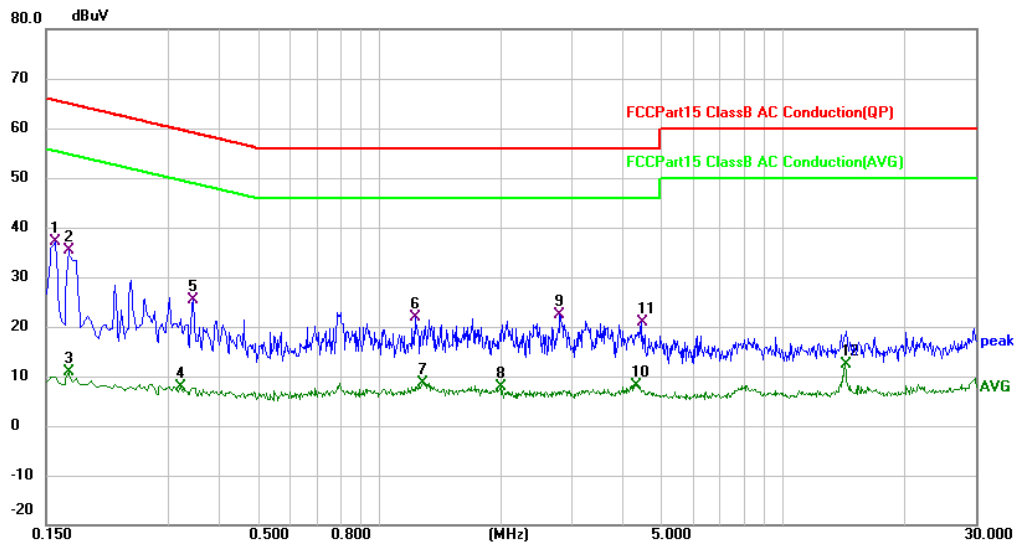

| No. | Mk. | Freq.   | Reading Level | Correct Factor | Measurement | Limit | Over   | Detector | Comment |
|-----|-----|---------|---------------|----------------|-------------|-------|--------|----------|---------|
|     |     | MHz     | dBuV          | dB             | dBuV        | dBuV  | dB     |          |         |
| 1   | *   | 0.1580  | 26.72         | 10.38          | 37.10       | 65.57 | -28.47 | QP       |         |
| 2   |     | 0.1700  | 24.95         | 10.38          | 35.33       | 64.96 | -29.63 | QP       |         |
| 3   |     | 0.1700  | 0.51          | 10.38          | 10.89       | 54.96 | -44.07 | AVG      |         |
| 4   |     | 0.3220  | -3.20         | 11.09          | 7.89        | 49.66 | -41.77 | AVG      |         |
| 5   |     | 0.3460  | 14.30         | 11.15          | 25.45       | 59.06 | -33.61 | QP       |         |
| 6   |     | 1.2260  | 8.75          | 13.08          | 21.83       | 56.00 | -34.17 | QP       |         |
| 7   |     | 1.2780  | -4.49         | 13.18          | 8.69        | 46.00 | -37.31 | AVG      |         |
| 8   |     | 1.9980  | -2.66         | 10.63          | 7.97        | 46.00 | -38.03 | AVG      |         |
| 9   |     | 2.8140  | 11.75         | 10.64          | 22.39       | 56.00 | -33.61 | QP       |         |
| 10  |     | 4.3260  | -2.41         | 10.65          | 8.24        | 46.00 | -37.76 | AVG      |         |
| 11  |     | 4.4980  | 10.18         | 10.65          | 20.83       | 56.00 | -35.17 | QP       |         |
| 12  |     | 14.2140 | 1.45          | 10.98          | 12.43       | 50.00 | -37.57 | AVG      |         |

## 6.2 Occupied Bandwidth

|                   |                                                                                                                                                                                                                                                                                                                                                                                                                                                      |
|-------------------|------------------------------------------------------------------------------------------------------------------------------------------------------------------------------------------------------------------------------------------------------------------------------------------------------------------------------------------------------------------------------------------------------------------------------------------------------|
| Test Requirement: | 47 CFR 15.247(a)(2)                                                                                                                                                                                                                                                                                                                                                                                                                                  |
| Test Limit:       | Refer to 47 CFR 15.247(a)(2), Systems using digital modulation techniques may operate in the 902-928 MHz, and 2400-2483.5 MHz bands. The minimum 6 dB bandwidth shall be at least 500 kHz.                                                                                                                                                                                                                                                           |
| Test Method:      | ANSI C63.10-2013, section 11.8<br>KDB 558074 D01 15.247 Meas Guidance v05r02                                                                                                                                                                                                                                                                                                                                                                         |
| Procedure:        | a) Set RBW = 100 kHz.<br>b) Set the VBW $\geq$ [3 × RBW].<br>c) Detector = peak.<br>d) Trace mode = max hold.<br>e) Sweep = auto couple.<br>f) Allow the trace to stabilize.<br>g) Measure the maximum width of the emission that is constrained by the frequencies associated with the two outermost amplitude points (upper and lower frequencies) that are attenuated by 6 dB relative to the maximum level measured in the fundamental emission. |

### 6.2.1 E.U.T. Operation:

|                        |       |           |      |                       |        |
|------------------------|-------|-----------|------|-----------------------|--------|
| Operating Environment: |       |           |      |                       |        |
| Temperature:           | 25 °C | Humidity: | 56 % | Atmospheric Pressure: | 99 kPa |
| Pre test mode:         | Mode1 |           |      |                       |        |
| Final test mode:       | Mode1 |           |      |                       |        |

### 6.2.2 Test Setup Diagram:

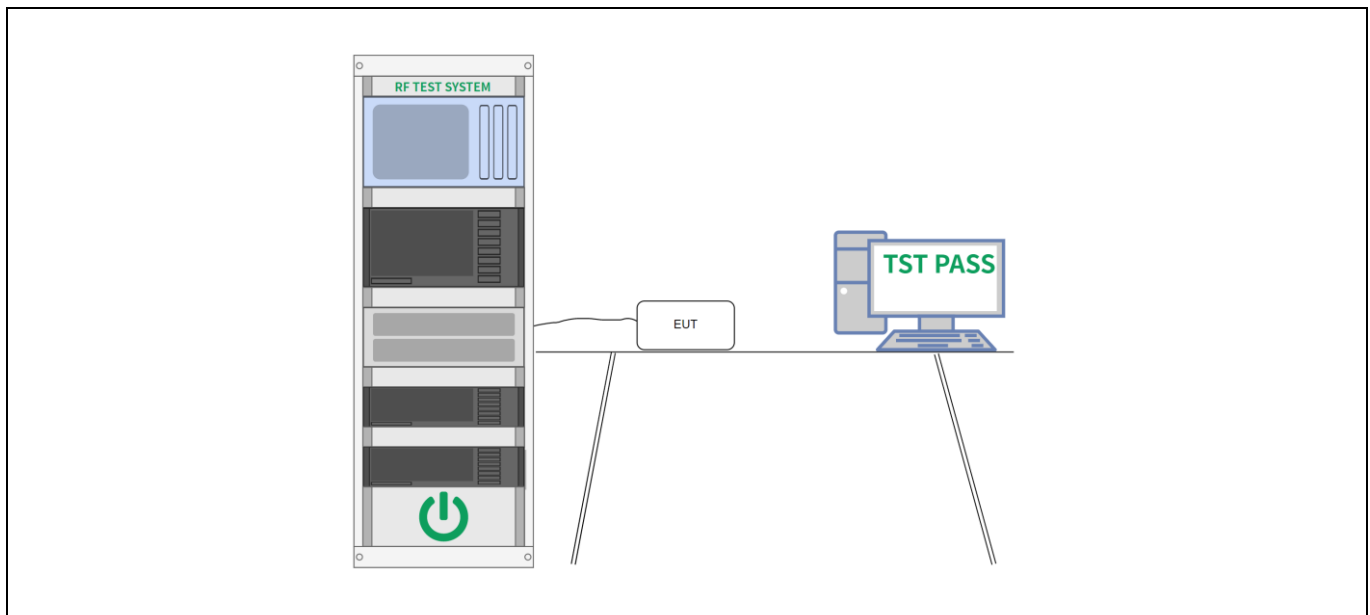

### 6.2.3 Test Data:

Please Refer to Appendix for Details.

### 6.3 Maximum Conducted Output Power

|                   |                                                                                                                                                                                                                                                                                                                                                                                                                                                                                                                                                                                                                                                                                                                                                                                                                                                                                                                                    |
|-------------------|------------------------------------------------------------------------------------------------------------------------------------------------------------------------------------------------------------------------------------------------------------------------------------------------------------------------------------------------------------------------------------------------------------------------------------------------------------------------------------------------------------------------------------------------------------------------------------------------------------------------------------------------------------------------------------------------------------------------------------------------------------------------------------------------------------------------------------------------------------------------------------------------------------------------------------|
| Test Requirement: | 47 CFR 15.247(b)(3)                                                                                                                                                                                                                                                                                                                                                                                                                                                                                                                                                                                                                                                                                                                                                                                                                                                                                                                |
| Test Limit:       | Refer to 47 CFR 15.247(b)(3), For systems using digital modulation in the 902-928 MHz, 2400-2483.5 MHz, and 5725-5850 MHz bands: 1 Watt. As an alternative to a peak power measurement, compliance with the one Watt limit can be based on a measurement of the maximum conducted output power. Maximum Conducted Output Power is defined as the total transmit power delivered to all antennas and antenna elements averaged across all symbols in the signaling alphabet when the transmitter is operating at its maximum power control level. Power must be summed across all antennas and antenna elements. The average must not include any time intervals during which the transmitter is off or is transmitting at a reduced power level. If multiple modes of operation are possible (e.g., alternative modulation methods), the maximum conducted output power is the highest total transmit power occurring in any mode. |
| Test Method:      | ANSI C63.10-2013, section 11.9.1<br>KDB 558074 D01 15.247 Meas Guidance v05r02                                                                                                                                                                                                                                                                                                                                                                                                                                                                                                                                                                                                                                                                                                                                                                                                                                                     |
| Procedure:        | ANSI C63.10-2013, section 11.9.1 Maximum peak conducted output power                                                                                                                                                                                                                                                                                                                                                                                                                                                                                                                                                                                                                                                                                                                                                                                                                                                               |

#### 6.3.1 E.U.T. Operation:

|                        |       |           |      |                       |        |
|------------------------|-------|-----------|------|-----------------------|--------|
| Operating Environment: |       |           |      |                       |        |
| Temperature:           | 25 °C | Humidity: | 56 % | Atmospheric Pressure: | 99 kPa |
| Pre test mode:         | Mode1 |           |      |                       |        |
| Final test mode:       | Mode1 |           |      |                       |        |

#### 6.3.2 Test Setup Diagram:

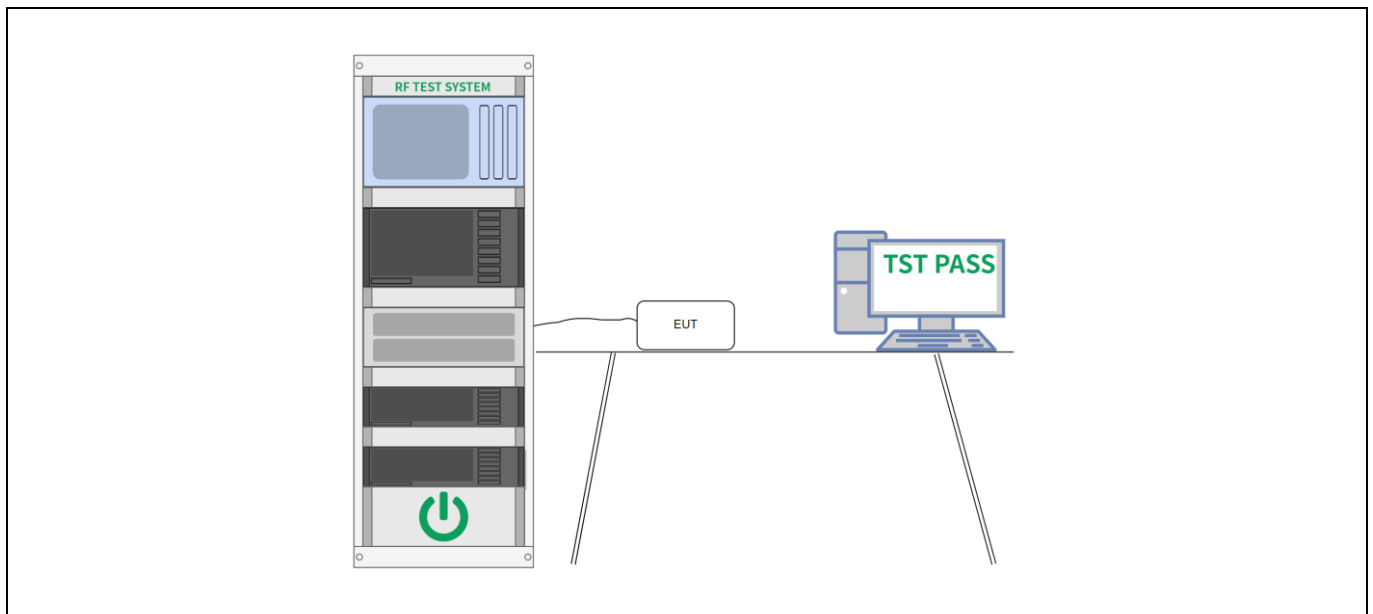

#### 6.3.3 Test Data:

Please Refer to Appendix for Details.



#### 6.4 Power Spectral Density

|                   |                                                                                                                                                                                                                                                                                                                                                                                                                                                                                           |
|-------------------|-------------------------------------------------------------------------------------------------------------------------------------------------------------------------------------------------------------------------------------------------------------------------------------------------------------------------------------------------------------------------------------------------------------------------------------------------------------------------------------------|
| Test Requirement: | 47 CFR 15.247(e)                                                                                                                                                                                                                                                                                                                                                                                                                                                                          |
| Test Limit:       | Refer to 47 CFR 15.247(e), For digitally modulated systems, the power spectral density conducted from the intentional radiator to the antenna shall not be greater than 8 dBm in any 3 kHz band during any time interval of continuous transmission. This power spectral density shall be determined in accordance with the provisions of paragraph (b) of this section. The same method of determining the conducted output power shall be used to determine the power spectral density. |
| Test Method:      | ANSI C63.10-2013, section 11.10<br>KDB 558074 D01 15.247 Meas Guidance v05r02                                                                                                                                                                                                                                                                                                                                                                                                             |
| Procedure:        | ANSI C63.10-2013, section 11.10, Maximum power spectral density level in the fundamental emission                                                                                                                                                                                                                                                                                                                                                                                         |

##### 6.4.1 E.U.T. Operation:

|                        |       |           |      |                       |        |
|------------------------|-------|-----------|------|-----------------------|--------|
| Operating Environment: |       |           |      |                       |        |
| Temperature:           | 25 °C | Humidity: | 56 % | Atmospheric Pressure: | 99 kPa |
| Pre test mode:         | Mode1 |           |      |                       |        |
| Final test mode:       | Mode1 |           |      |                       |        |

##### 6.4.2 Test Setup Diagram:

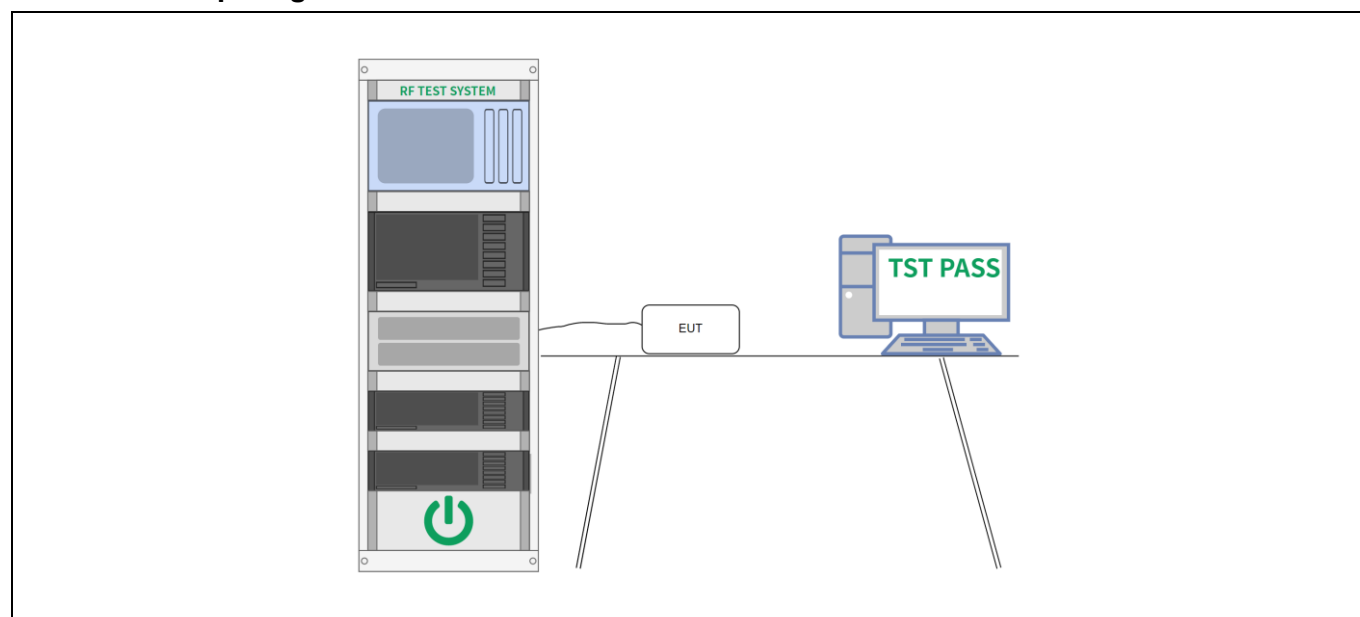

##### 6.4.3 Test Data:

Please Refer to Appendix for Details.

### 6.5 RF conducted spurious emissions and band edge measurement

|                   |                                                                                                                                                                                                                                                                                                                                                                                                                                                                                                                                                                                                                                                                                                                                                                                                                                                                         |
|-------------------|-------------------------------------------------------------------------------------------------------------------------------------------------------------------------------------------------------------------------------------------------------------------------------------------------------------------------------------------------------------------------------------------------------------------------------------------------------------------------------------------------------------------------------------------------------------------------------------------------------------------------------------------------------------------------------------------------------------------------------------------------------------------------------------------------------------------------------------------------------------------------|
| Test Requirement: | 47 CFR 15.247(d), 15.209, 15.205                                                                                                                                                                                                                                                                                                                                                                                                                                                                                                                                                                                                                                                                                                                                                                                                                                        |
| Test Limit:       | Refer to 47 CFR 15.247(d), In any 100 kHz bandwidth outside the frequency band in which the spread spectrum or digitally modulated intentional radiator is operating, the radio frequency power that is produced by the intentional radiator shall be at least 20 dB below that in the 100 kHz bandwidth within the band that contains the highest level of the desired power, based on either an RF conducted or a radiated measurement, provided the transmitter demonstrates compliance with the peak conducted power limits. If the transmitter complies with the conducted power limits based on the use of RMS averaging over a time interval, as permitted under paragraph (b)(3) of this section, the attenuation required under this paragraph shall be 30 dB instead of 20 dB. Attenuation below the general limits specified in § 15.209(a) is not required. |
| Test Method:      | ANSI C63.10-2013 section 11.11<br>KDB 558074 D01 15.247 Meas Guidance v05r02                                                                                                                                                                                                                                                                                                                                                                                                                                                                                                                                                                                                                                                                                                                                                                                            |
| Procedure:        | ANSI C63.10-2013<br>Section 11.11.1, Section 11.11.2, Section 11.11.3                                                                                                                                                                                                                                                                                                                                                                                                                                                                                                                                                                                                                                                                                                                                                                                                   |

#### 6.5.1 E.U.T. Operation:

|                        |       |           |      |                       |        |
|------------------------|-------|-----------|------|-----------------------|--------|
| Operating Environment: |       |           |      |                       |        |
| Temperature:           | 25 °C | Humidity: | 56 % | Atmospheric Pressure: | 99 kPa |
| Pre test mode:         | Mode1 |           |      |                       |        |
| Final test mode:       | Mode1 |           |      |                       |        |

#### 6.5.2 Test Setup Diagram:

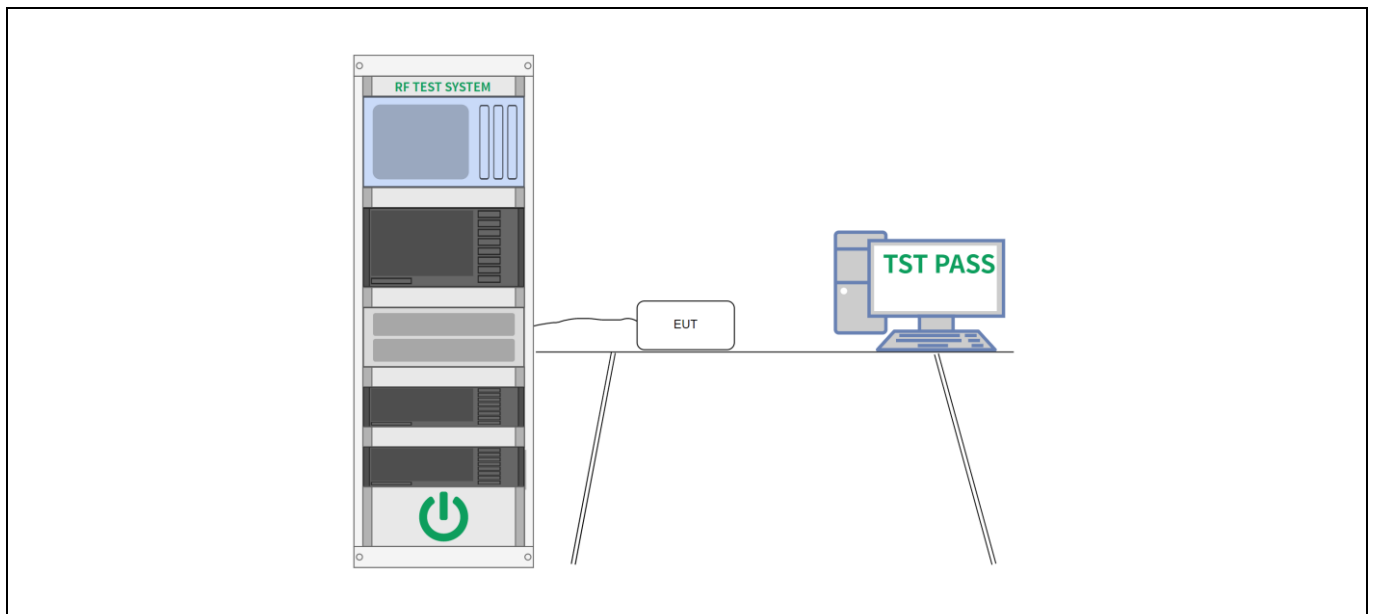

#### 6.5.3 Test Data:

Please Refer to Appendix for Details.

**6.6 Band edge emissions (Radiated)**

|                   |                                                                                                                                                                                                                                                                                                                                                                                                                                                                                                                                                                                                                                                                                                                           |                                   |                               |
|-------------------|---------------------------------------------------------------------------------------------------------------------------------------------------------------------------------------------------------------------------------------------------------------------------------------------------------------------------------------------------------------------------------------------------------------------------------------------------------------------------------------------------------------------------------------------------------------------------------------------------------------------------------------------------------------------------------------------------------------------------|-----------------------------------|-------------------------------|
| Test Requirement: | Refer to 47 CFR 15.247(d), In addition, radiated emissions which fall in the restricted bands, as defined in § 15.205(a), must also comply with the radiated emission limits specified in § 15.209(a)(see § 15.205(c)).`                                                                                                                                                                                                                                                                                                                                                                                                                                                                                                  |                                   |                               |
| Test Limit:       | Frequency (MHz)                                                                                                                                                                                                                                                                                                                                                                                                                                                                                                                                                                                                                                                                                                           | Field strength (microvolts/meter) | Measurement distance (meters) |
|                   | 0.009-0.490                                                                                                                                                                                                                                                                                                                                                                                                                                                                                                                                                                                                                                                                                                               | 2400/F(kHz)                       | 300                           |
|                   | 0.490-1.705                                                                                                                                                                                                                                                                                                                                                                                                                                                                                                                                                                                                                                                                                                               | 24000/F(kHz)                      | 30                            |
|                   | 1.705-30.0                                                                                                                                                                                                                                                                                                                                                                                                                                                                                                                                                                                                                                                                                                                | 30                                | 30                            |
|                   | 30-88                                                                                                                                                                                                                                                                                                                                                                                                                                                                                                                                                                                                                                                                                                                     | 100 **                            | 3                             |
|                   | 88-216                                                                                                                                                                                                                                                                                                                                                                                                                                                                                                                                                                                                                                                                                                                    | 150 **                            | 3                             |
|                   | 216-960                                                                                                                                                                                                                                                                                                                                                                                                                                                                                                                                                                                                                                                                                                                   | 200 **                            | 3                             |
|                   | Above 960                                                                                                                                                                                                                                                                                                                                                                                                                                                                                                                                                                                                                                                                                                                 | 500                               | 3                             |
|                   | ** Except as provided in paragraph (g), fundamental emissions from intentional radiators operating under this section shall not be located in the frequency bands 54-72 MHz, 76-88 MHz, 174-216 MHz or 470-806 MHz. However, operation within these frequency bands is permitted under other sections of this part, e.g., §§ 15.231 and 15.241.<br>In the emission table above, the tighter limit applies at the band edges. The emission limits shown in the above table are based on measurements employing a CISPR quasi-peak detector except for the frequency bands 9–90 kHz, 110–490 kHz and above 1000 MHz. Radiated emission limits in these three bands are based on measurements employing an average detector. |                                   |                               |
| Test Method:      | ANSI C63.10-2013 section 6.10<br>KDB 558074 D01 15.247 Meas Guidance v05r02                                                                                                                                                                                                                                                                                                                                                                                                                                                                                                                                                                                                                                               |                                   |                               |
| Procedure:        | ANSI C63.10-2013 section 6.10.5.2                                                                                                                                                                                                                                                                                                                                                                                                                                                                                                                                                                                                                                                                                         |                                   |                               |

**6.6.1 E.U.T. Operation:**

|                                                                                                                      |       |           |      |                       |         |
|----------------------------------------------------------------------------------------------------------------------|-------|-----------|------|-----------------------|---------|
| Operating Environment:                                                                                               |       |           |      |                       |         |
| Temperature:                                                                                                         | 25 °C | Humidity: | 59 % | Atmospheric Pressure: | 100 kPa |
| Pre test mode:                                                                                                       | Mode1 |           |      |                       |         |
| Final test mode:                                                                                                     | Mode1 |           |      |                       |         |
| Note:<br>The amplitude of spurious emissions which are attenuated more than 20 dB below the limits are not reported. |       |           |      |                       |         |

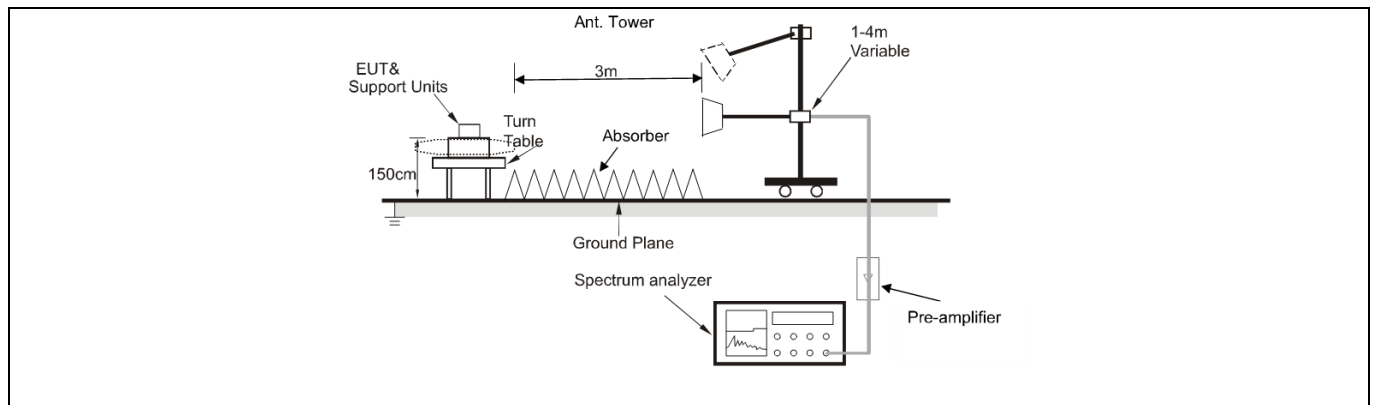
**6.6.2 Test Setup Diagram:**

**6.6.3 Test Data:**

Mode1 / Polarization: Horizontal/ CH: L

| No. | Mk. | Freq.    | Reading Level | Correct Factor | Measurement | Limit  | Over   | Detector |
|-----|-----|----------|---------------|----------------|-------------|--------|--------|----------|
|     |     | MHz      | dBuV          | dB             | dBuV/m      | dBuV/m | dB     |          |
| 1   |     | 2310.000 | 52.47         | -12.92         | 39.55       | 74.00  | -34.45 | peak     |
| 2   |     | 2310.000 | 43.03         | -12.92         | 30.11       | 54.00  | -23.89 | AVG      |
| 3   |     | 2390.000 | 52.17         | -12.49         | 39.68       | 74.00  | -34.32 | peak     |
| 4   | *   | 2390.000 | 42.79         | -12.49         | 30.30       | 54.00  | -23.70 | AVG      |

Mode1 / Polarization: Vertical/ CH: L

| No. | Mk. | Freq.    | Reading Level | Correct Factor | Measurement | Limit  | Over   | Detector |
|-----|-----|----------|---------------|----------------|-------------|--------|--------|----------|
|     |     | MHz      | dBuV          | dB             | dBuV/m      | dBuV/m | dB     |          |
| 1   |     | 2310.000 | 55.86         | -12.92         | 42.94       | 74.00  | -31.06 | peak     |
| 2   |     | 2310.000 | 44.40         | -12.92         | 31.48       | 54.00  | -22.52 | AVG      |
| 3   |     | 2390.000 | 56.52         | -12.49         | 44.03       | 74.00  | -29.97 | peak     |
| 4   | *   | 2390.000 | 46.18         | -12.49         | 33.69       | 54.00  | -20.31 | AVG      |

Mode1 / Polarization: Horizontal/ CH: H

| No. | Mk. | Freq.    | Reading Level | Correct Factor | Measurement | Limit  | Over   | Detector |
|-----|-----|----------|---------------|----------------|-------------|--------|--------|----------|
|     |     | MHz      | dBuV          | dB             | dBuV/m      | dBuV/m | dB     |          |
| 1   |     | 2483.500 | 54.58         | -12.50         | 42.08       | 74.00  | -31.92 | peak     |
| 2   | *   | 2483.500 | 44.90         | -12.50         | 32.40       | 54.00  | -21.60 | AVG      |
| 3   |     | 2500.000 | 52.40         | -12.41         | 39.99       | 74.00  | -34.01 | peak     |
| 4   |     | 2500.000 | 42.80         | -12.41         | 30.39       | 54.00  | -23.61 | AVG      |

Mode1 / Polarization: Vertical/ CH: H

| No. | Mk. | Freq.    | Reading Level | Correct Factor | Measurement | Limit  | Over   | Detector |
|-----|-----|----------|---------------|----------------|-------------|--------|--------|----------|
|     |     | MHz      | dBuV          | dB             | dBuV/m      | dBuV/m | dB     |          |
| 1   |     | 2483.500 | 53.69         | -12.50         | 41.19       | 74.00  | -32.81 | peak     |
| 2   |     | 2483.500 | 43.72         | -12.50         | 31.22       | 54.00  | -22.78 | AVG      |
| 3   |     | 2500.000 | 52.82         | -12.41         | 40.41       | 74.00  | -33.59 | peak     |
| 4   | *   | 2500.000 | 44.77         | -12.41         | 32.36       | 54.00  | -21.64 | AVG      |

**6.7 Radiated emissions (below 1GHz)**

|                   |                                                                                                                                                                                                                                                                                                                                                                                                                                                                                                                                                                                                                                                                                                                           |                                   |                               |
|-------------------|---------------------------------------------------------------------------------------------------------------------------------------------------------------------------------------------------------------------------------------------------------------------------------------------------------------------------------------------------------------------------------------------------------------------------------------------------------------------------------------------------------------------------------------------------------------------------------------------------------------------------------------------------------------------------------------------------------------------------|-----------------------------------|-------------------------------|
| Test Requirement: | Refer to 47 CFR 15.247(d), In addition, radiated emissions which fall in the restricted bands, as defined in § 15.205(a), must also comply with the radiated emission limits specified in § 15.209(a)(see § 15.205(c)).`                                                                                                                                                                                                                                                                                                                                                                                                                                                                                                  |                                   |                               |
| Test Limit:       | Frequency (MHz)                                                                                                                                                                                                                                                                                                                                                                                                                                                                                                                                                                                                                                                                                                           | Field strength (microvolts/meter) | Measurement distance (meters) |
|                   | 0.009-0.490                                                                                                                                                                                                                                                                                                                                                                                                                                                                                                                                                                                                                                                                                                               | 2400/F(kHz)                       | 300                           |
|                   | 0.490-1.705                                                                                                                                                                                                                                                                                                                                                                                                                                                                                                                                                                                                                                                                                                               | 24000/F(kHz)                      | 30                            |
|                   | 1.705-30.0                                                                                                                                                                                                                                                                                                                                                                                                                                                                                                                                                                                                                                                                                                                | 30                                | 30                            |
|                   | 30-88                                                                                                                                                                                                                                                                                                                                                                                                                                                                                                                                                                                                                                                                                                                     | 100 **                            | 3                             |
|                   | 88-216                                                                                                                                                                                                                                                                                                                                                                                                                                                                                                                                                                                                                                                                                                                    | 150 **                            | 3                             |
|                   | 216-960                                                                                                                                                                                                                                                                                                                                                                                                                                                                                                                                                                                                                                                                                                                   | 200 **                            | 3                             |
|                   | Above 960                                                                                                                                                                                                                                                                                                                                                                                                                                                                                                                                                                                                                                                                                                                 | 500                               | 3                             |
|                   | ** Except as provided in paragraph (g), fundamental emissions from intentional radiators operating under this section shall not be located in the frequency bands 54-72 MHz, 76-88 MHz, 174-216 MHz or 470-806 MHz. However, operation within these frequency bands is permitted under other sections of this part, e.g., §§ 15.231 and 15.241.<br>In the emission table above, the tighter limit applies at the band edges. The emission limits shown in the above table are based on measurements employing a CISPR quasi-peak detector except for the frequency bands 9–90 kHz, 110–490 kHz and above 1000 MHz. Radiated emission limits in these three bands are based on measurements employing an average detector. |                                   |                               |
| Test Method:      | ANSI C63.10-2013 section 6.6.4<br>KDB 558074 D01 15.247 Meas Guidance v05r02                                                                                                                                                                                                                                                                                                                                                                                                                                                                                                                                                                                                                                              |                                   |                               |
| Procedure:        | ANSI C63.10-2013 section 6.6.4                                                                                                                                                                                                                                                                                                                                                                                                                                                                                                                                                                                                                                                                                            |                                   |                               |

**6.7.1 E.U.T. Operation:**

|                                                                                                                                                                                                                                                                                                   |       |                       |         |
|---------------------------------------------------------------------------------------------------------------------------------------------------------------------------------------------------------------------------------------------------------------------------------------------------|-------|-----------------------|---------|
| Operating Environment:                                                                                                                                                                                                                                                                            |       |                       |         |
| Temperature:                                                                                                                                                                                                                                                                                      | 25 °C | Humidity:             | 58 %    |
|                                                                                                                                                                                                                                                                                                   |       | Atmospheric Pressure: | 100 kPa |
| Pre test mode:                                                                                                                                                                                                                                                                                    | Mode1 |                       |         |
| Final test mode:                                                                                                                                                                                                                                                                                  | Mode1 |                       |         |
| Note:<br>The amplitude of spurious emissions which are attenuated more than 20 dB below the limits are not reported.<br>All modes of operation of the EUT were investigated, and only the worst-case results are reported.<br>There were no emissions found below 30MHz within 20dB of the limit. |       |                       |         |

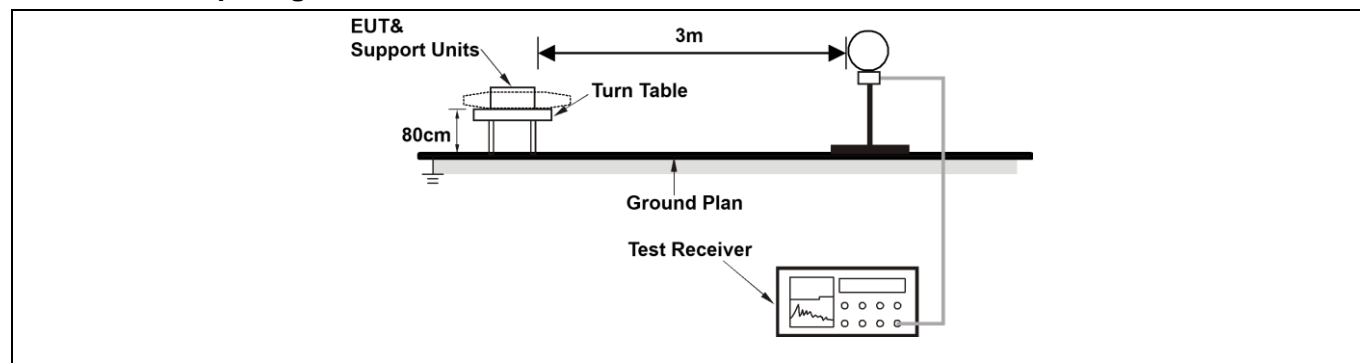
**6.7.2 Test Setup Diagram:**

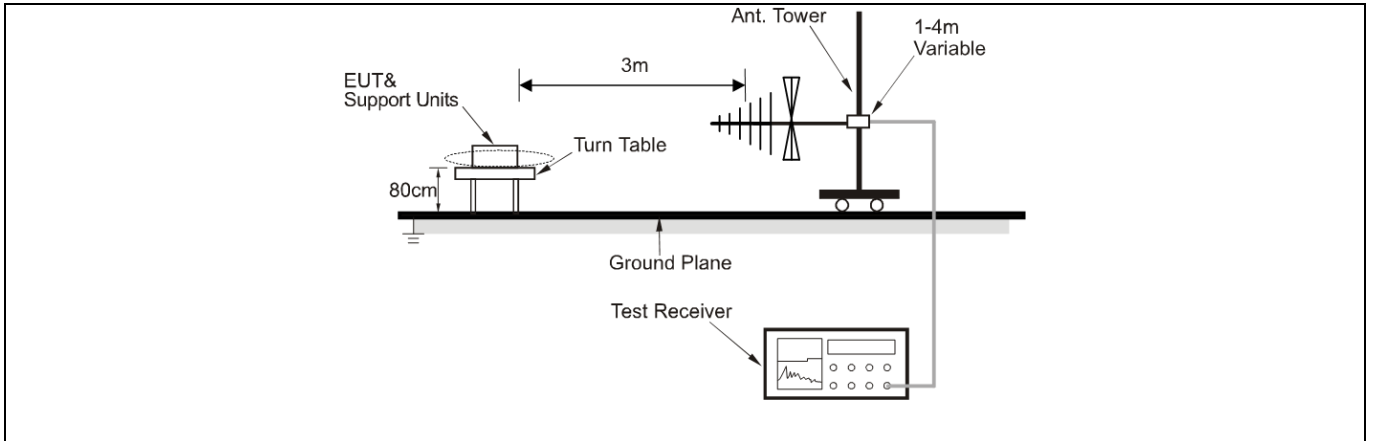

**6.7.3 Test Data:**

Mode1 / Polarization: Horizontal

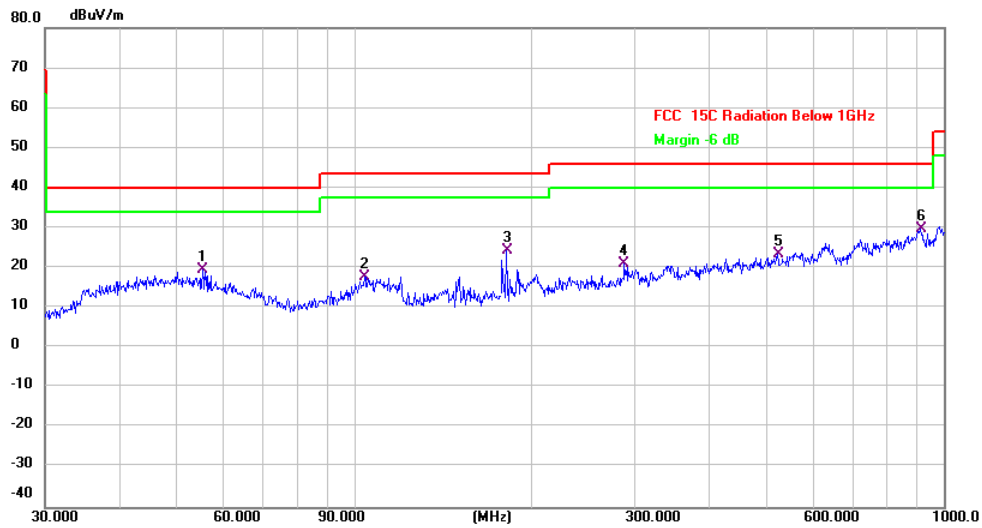

| No. Mk. | Freq.<br>MHz | Reading<br>Level<br>dBuV | Correct<br>Factor<br>dB | Measure-<br>ment<br>dBuV/m | Limit<br>dBuV/m | Over<br>dB | Detector | Comment |
|---------|--------------|--------------------------|-------------------------|----------------------------|-----------------|------------|----------|---------|
| 1       | 55.4147      | 28.52                    | -8.85                   | 19.67                      | 40.00           | -20.33     | QP       |         |
| 2       | 104.1701     | 25.47                    | -7.65                   | 17.82                      | 43.50           | -25.68     | QP       |         |
| 3       | 181.9202     | 34.82                    | -10.36                  | 24.46                      | 43.50           | -19.04     | QP       |         |
| 4       | 287.9904     | 26.63                    | -5.60                   | 21.03                      | 46.00           | -24.97     | QP       |         |
| 5       | 522.7180     | 27.06                    | -3.61                   | 23.45                      | 46.00           | -22.55     | QP       |         |
| 6 *     | 912.8620     | 26.57                    | 3.17                    | 29.74                      | 46.00           | -16.26     | QP       |         |

Mode1 / Polarization: Vertical

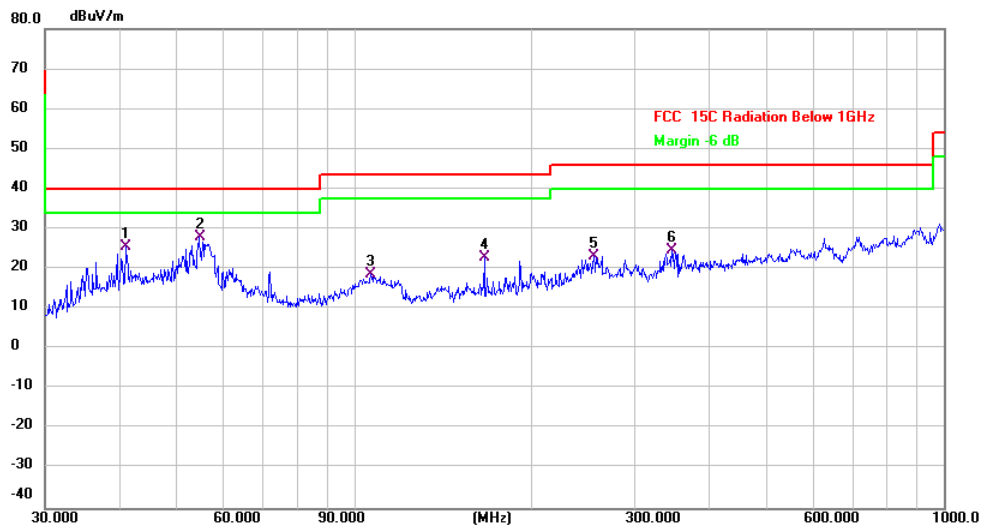

| No. Mk. | Freq.<br>MHz | Reading<br>Level<br>dBuV | Correct<br>Factor<br>dB | Measure-<br>ment<br>dBuV/m | Limit<br>dBuV/m | Over<br>dB | Detector | Comment |
|---------|--------------|--------------------------|-------------------------|----------------------------|-----------------|------------|----------|---------|
| 1       | 41.1320      | 33.74                    | -8.20                   | 25.54                      | 40.00           | -14.46     | QP       |         |
| 2 *     | 54.6429      | 36.05                    | -8.18                   | 27.87                      | 40.00           | -12.13     | QP       |         |
| 3       | 106.7587     | 25.74                    | -7.02                   | 18.72                      | 43.50           | -24.78     | QP       |         |
| 4       | 166.0680     | 33.97                    | -11.02                  | 22.95                      | 43.50           | -20.55     | QP       |         |
| 5       | 255.6231     | 30.74                    | -7.51                   | 23.23                      | 46.00           | -22.77     | QP       |         |
| 6       | 346.8092     | 28.77                    | -4.11                   | 24.66                      | 46.00           | -21.34     | QP       |         |



**6.8 Radiated emissions (above 1GHz)**

|                   |                                                                                                                                                                                                                                                                                                                                                                                                                                                                                                                                                                                                                                                                                                                           |                                   |                               |
|-------------------|---------------------------------------------------------------------------------------------------------------------------------------------------------------------------------------------------------------------------------------------------------------------------------------------------------------------------------------------------------------------------------------------------------------------------------------------------------------------------------------------------------------------------------------------------------------------------------------------------------------------------------------------------------------------------------------------------------------------------|-----------------------------------|-------------------------------|
| Test Requirement: | In addition, radiated emissions which fall in the restricted bands, as defined in § 15.205(a), must also comply with the radiated emission limits specified in § 15.209(a)(see § 15.205(c)).`                                                                                                                                                                                                                                                                                                                                                                                                                                                                                                                             |                                   |                               |
| Test Limit:       | Frequency (MHz)                                                                                                                                                                                                                                                                                                                                                                                                                                                                                                                                                                                                                                                                                                           | Field strength (microvolts/meter) | Measurement distance (meters) |
|                   | 0.009-0.490                                                                                                                                                                                                                                                                                                                                                                                                                                                                                                                                                                                                                                                                                                               | 2400/F(kHz)                       | 300                           |
|                   | 0.490-1.705                                                                                                                                                                                                                                                                                                                                                                                                                                                                                                                                                                                                                                                                                                               | 24000/F(kHz)                      | 30                            |
|                   | 1.705-30.0                                                                                                                                                                                                                                                                                                                                                                                                                                                                                                                                                                                                                                                                                                                | 30                                | 30                            |
|                   | 30-88                                                                                                                                                                                                                                                                                                                                                                                                                                                                                                                                                                                                                                                                                                                     | 100 **                            | 3                             |
|                   | 88-216                                                                                                                                                                                                                                                                                                                                                                                                                                                                                                                                                                                                                                                                                                                    | 150 **                            | 3                             |
|                   | 216-960                                                                                                                                                                                                                                                                                                                                                                                                                                                                                                                                                                                                                                                                                                                   | 200 **                            | 3                             |
|                   | Above 960                                                                                                                                                                                                                                                                                                                                                                                                                                                                                                                                                                                                                                                                                                                 | 500                               | 3                             |
|                   | ** Except as provided in paragraph (g), fundamental emissions from intentional radiators operating under this section shall not be located in the frequency bands 54-72 MHz, 76-88 MHz, 174-216 MHz or 470-806 MHz. However, operation within these frequency bands is permitted under other sections of this part, e.g., §§ 15.231 and 15.241.<br>In the emission table above, the tighter limit applies at the band edges. The emission limits shown in the above table are based on measurements employing a CISPR quasi-peak detector except for the frequency bands 9–90 kHz, 110–490 kHz and above 1000 MHz. Radiated emission limits in these three bands are based on measurements employing an average detector. |                                   |                               |
| Test Method:      | ANSI C63.10-2013 section 6.6.4<br>KDB 558074 D01 15.247 Meas Guidance v05r02                                                                                                                                                                                                                                                                                                                                                                                                                                                                                                                                                                                                                                              |                                   |                               |
| Procedure:        | ANSI C63.10-2013 section 6.6.4                                                                                                                                                                                                                                                                                                                                                                                                                                                                                                                                                                                                                                                                                            |                                   |                               |

**6.8.1 E.U.T. Operation:**

|                                                                                                                                                                                                                                                                |       |           |      |                       |         |
|----------------------------------------------------------------------------------------------------------------------------------------------------------------------------------------------------------------------------------------------------------------|-------|-----------|------|-----------------------|---------|
| Operating Environment:                                                                                                                                                                                                                                         |       |           |      |                       |         |
| Temperature:                                                                                                                                                                                                                                                   | 25 °C | Humidity: | 59 % | Atmospheric Pressure: | 100 kPa |
| Pre test mode:                                                                                                                                                                                                                                                 | Mode1 |           |      |                       |         |
| Final test mode:                                                                                                                                                                                                                                               | Mode1 |           |      |                       |         |
| Note: Test frequency are from 1GHz to 25GHz, the amplitude of spurious emissions which are attenuated more than 20 dB below the limits are not reported.<br>All modes of operation of the EUT were investigated, and only the worst-case results are reported. |       |           |      |                       |         |

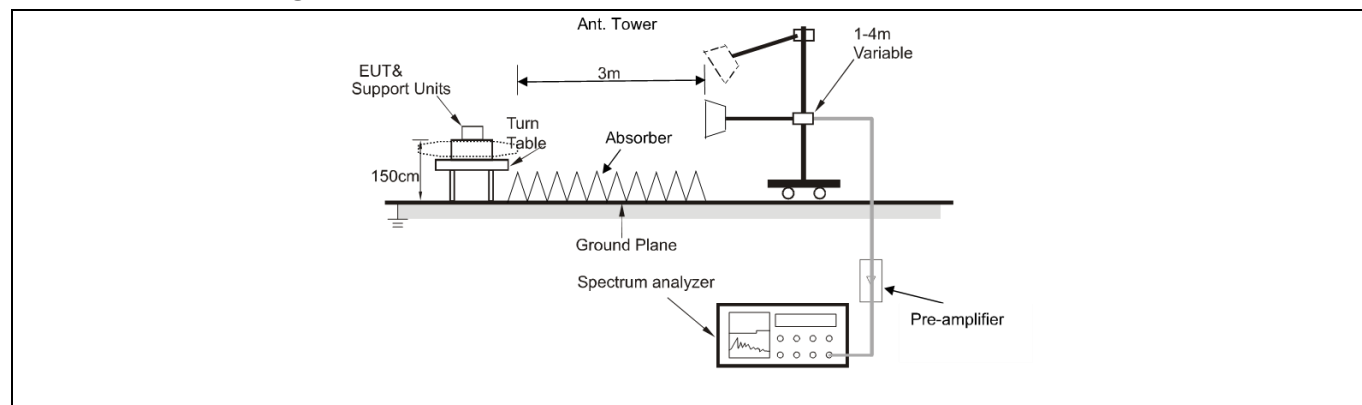
**6.8.2 Test Setup Diagram:**

**6.8.3 Test Data:**

Mode1 / Polarization: Horizontal/ CH: L

| No. | Mk. | Freq.    | Reading Level | Correct Factor | Measurement | Limit  | Over   | Detector |
|-----|-----|----------|---------------|----------------|-------------|--------|--------|----------|
|     |     | MHz      | dBuV          | dB             | dBuV/m      | dBuV/m | dB     |          |
| 1   |     | 4804.000 | 57.18         | -7.70          | 49.48       | 74.00  | -24.52 | peak     |
| 2   |     | 4804.000 | 53.37         | -7.70          | 45.67       | 54.00  | -8.33  | AVG      |
| 3   |     | 7206.000 | 53.58         | 0.84           | 54.42       | 74.00  | -19.58 | peak     |
| 4   | *   | 7206.000 | 49.30         | 0.84           | 50.14       | 54.00  | -3.86  | AVG      |
| 5   |     | 9608.000 | 47.88         | 1.81           | 49.69       | 74.00  | -24.31 | peak     |
| 6   |     | 9608.000 | 43.87         | 1.81           | 45.68       | 54.00  | -8.32  | AVG      |

Mode1 / Polarization: Vertical/ CH: L

| No. | Mk. | Freq.    | Reading Level | Correct Factor | Measurement | Limit  | Over   | Detector |
|-----|-----|----------|---------------|----------------|-------------|--------|--------|----------|
|     |     | MHz      | dBuV          | dB             | dBuV/m      | dBuV/m | dB     |          |
| 1   |     | 4804.000 | 53.14         | -7.70          | 45.44       | 74.00  | -28.56 | peak     |
| 2   |     | 4804.000 | 49.06         | -7.70          | 41.36       | 54.00  | -12.64 | AVG      |
| 3   |     | 7206.000 | 50.68         | 0.84           | 51.52       | 74.00  | -22.48 | peak     |
| 4   | *   | 7206.000 | 46.81         | 0.84           | 47.65       | 54.00  | -6.35  | AVG      |
| 5   |     | 9608.000 | 49.01         | 1.81           | 50.82       | 74.00  | -23.18 | peak     |
| 6   |     | 9608.000 | 45.06         | 1.81           | 46.87       | 54.00  | -7.13  | AVG      |

Mode1 / Polarization: Horizontal/ CH: M

| No. | Mk. | Freq.    | Reading Level | Correct Factor | Measurement | Limit  | Over   | Detector |
|-----|-----|----------|---------------|----------------|-------------|--------|--------|----------|
|     |     | MHz      | dBuV          | dB             | dBuV/m      | dBuV/m | dB     |          |
| 1   |     | 4880.000 | 57.65         | -7.84          | 49.81       | 74.00  | -24.19 | peak     |
| 2   |     | 4880.000 | 53.20         | -7.84          | 45.36       | 54.00  | -8.64  | AVG      |
| 3   |     | 7320.000 | 52.97         | 0.60           | 53.57       | 74.00  | -20.43 | peak     |
| 4   | *   | 7320.000 | 49.02         | 0.60           | 49.62       | 54.00  | -4.38  | AVG      |
| 5   |     | 9760.000 | 47.87         | 2.60           | 50.47       | 74.00  | -23.53 | peak     |
| 6   |     | 9760.000 | 44.07         | 2.60           | 46.67       | 54.00  | -7.33  | AVG      |

Mode1 / Polarization: Vertical/ CH: M

| No. | Mk. | Freq.    | Reading Level | Correct Factor | Measurement | Limit  | Over   | Detector |
|-----|-----|----------|---------------|----------------|-------------|--------|--------|----------|
|     |     | MHz      | dBuV          | dB             | dBuV/m      | dBuV/m | dB     |          |
| 1   |     | 4880.000 | 54.15         | -7.84          | 46.31       | 74.00  | -27.69 | peak     |
| 2   |     | 4880.000 | 50.40         | -7.84          | 42.56       | 54.00  | -11.44 | AVG      |
| 3   |     | 7320.000 | 50.56         | 0.60           | 51.16       | 74.00  | -22.84 | peak     |
| 4   | *   | 7320.000 | 47.02         | 0.60           | 47.62       | 54.00  | -6.38  | AVG      |
| 5   |     | 9760.000 | 47.80         | 2.60           | 50.40       | 74.00  | -23.60 | peak     |
| 6   |     | 9760.000 | 43.76         | 2.60           | 46.36       | 54.00  | -7.64  | AVG      |

Mode1 / Polarization: Horizontal/ CH: H

| No. | Mk. | Freq.    | Reading Level | Correct Factor | Measurement | Limit  | Over   | Detector |
|-----|-----|----------|---------------|----------------|-------------|--------|--------|----------|
|     |     | MHz      | dBuV          | dB             | dBuV/m      | dBuV/m | dB     |          |
| 1   |     | 4960.000 | 59.05         | -7.73          | 51.32       | 74.00  | -22.68 | peak     |
| 2   |     | 4960.000 | 55.35         | -7.73          | 47.62       | 54.00  | -6.38  | AVG      |
| 3   |     | 7440.000 | 53.30         | 0.78           | 54.08       | 74.00  | -19.92 | peak     |
| 4   | *   | 7440.000 | 49.34         | 0.78           | 50.12       | 54.00  | -3.88  | AVG      |
| 5   |     | 9920.000 | 48.13         | 2.47           | 50.60       | 74.00  | -23.40 | peak     |
| 6   |     | 9920.000 | 43.89         | 2.47           | 46.36       | 54.00  | -7.64  | AVG      |

Mode1 / Polarization: Vertical/ CH: H

| No. | Mk. | Freq.    | Reading Level | Correct Factor | Measurement | Limit  | Over   | Detector |
|-----|-----|----------|---------------|----------------|-------------|--------|--------|----------|
|     |     | MHz      | dBuV          | dB             | dBuV/m      | dBuV/m | dB     |          |
| 1   |     | 4960.000 | 54.88         | -7.73          | 47.15       | 74.00  | -26.85 | peak     |
| 2   |     | 4960.000 | 50.94         | -7.73          | 43.21       | 54.00  | -10.79 | AVG      |
| 3   |     | 7440.000 | 50.06         | 0.78           | 50.84       | 74.00  | -23.16 | peak     |
| 4   | *   | 7440.000 | 46.07         | 0.78           | 46.85       | 54.00  | -7.15  | AVG      |
| 5   |     | 9920.000 | 47.63         | 2.47           | 50.10       | 74.00  | -23.90 | peak     |
| 6   |     | 9920.000 | 43.74         | 2.47           | 46.21       | 54.00  | -7.79  | AVG      |

## Photographs of the test setup

Refer to Appendix - Test Setup Photos

## Photographs of the EUT

Refer to Appendix - EUT Photos

# Appendix

## Appendix A: DTS Bandwidth

### Test Result

| Test Mode | Antenna | Frequency [MHz] | DTS BW [MHz] | Limit [MHz] | Verdict |
|-----------|---------|-----------------|--------------|-------------|---------|
| BLE_2M    | Ant1    | 2402            | 1.300        | 0.5         | PASS    |
|           |         | 2440            | 1.416        | 0.5         | PASS    |
|           |         | 2480            | 1.392        | 0.5         | PASS    |



## Test Graphs



## Appendix B: Maximum conducted output power

### Test Result-Peak

| Test Mode | Antenna | Frequency [MHz] | Conducted Peak Power [dBm] | Limit [dBm] | Verdict |
|-----------|---------|-----------------|----------------------------|-------------|---------|
| BLE_2M    | Ant1    | 2402            | -22.52                     | ≤30         | PASS    |
|           |         | 2440            | -21.60                     | ≤30         | PASS    |
|           |         | 2480            | -21.44                     | ≤30         | PASS    |

## Test Graphs

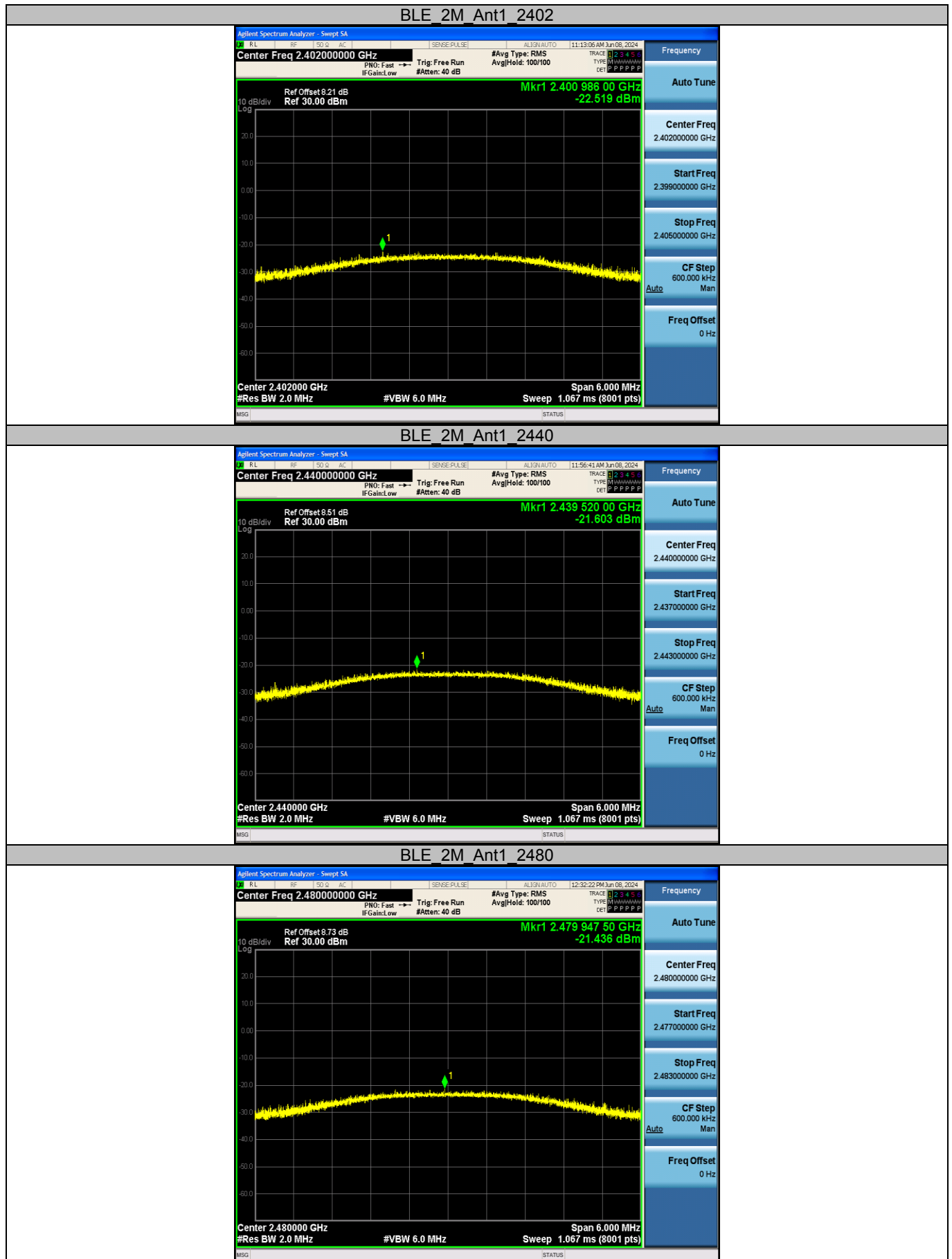

## Appendix C: Maximum power spectral density

### Test Result

| Test Mode | Antenna | Frequency [MHz] | Result [dBm/3kHz] | Limit [dBm/3kHz] | Verdict |
|-----------|---------|-----------------|-------------------|------------------|---------|
| BLE_2M    | Ant1    | 2402            | -39.17            | ≤8.00            | PASS    |
|           |         | 2440            | -38.94            | ≤8.00            | PASS    |
|           |         | 2480            | -38.41            | ≤8.00            | PASS    |

## Test Graphs

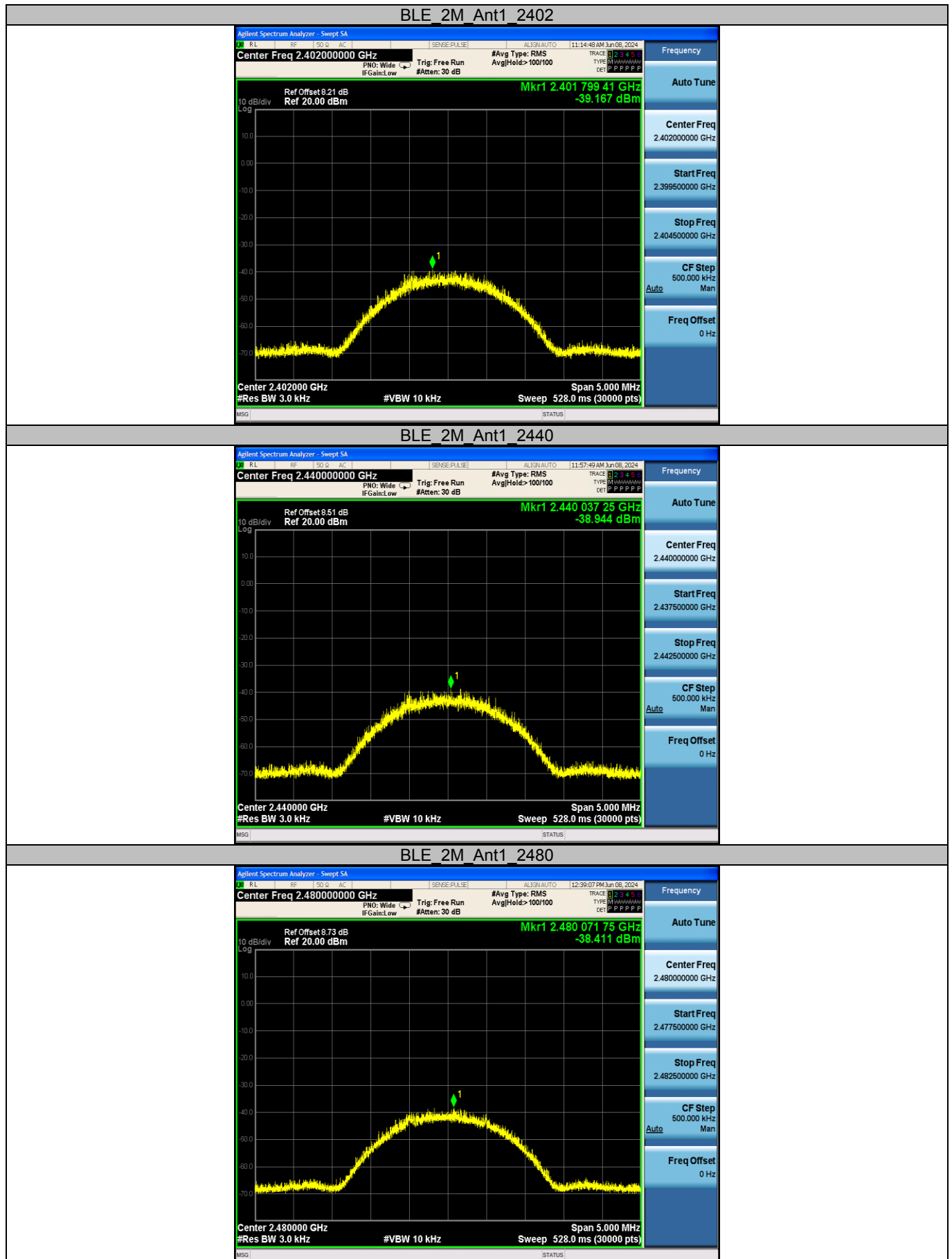

## Appendix D: Band edge measurements

### Test Graphs

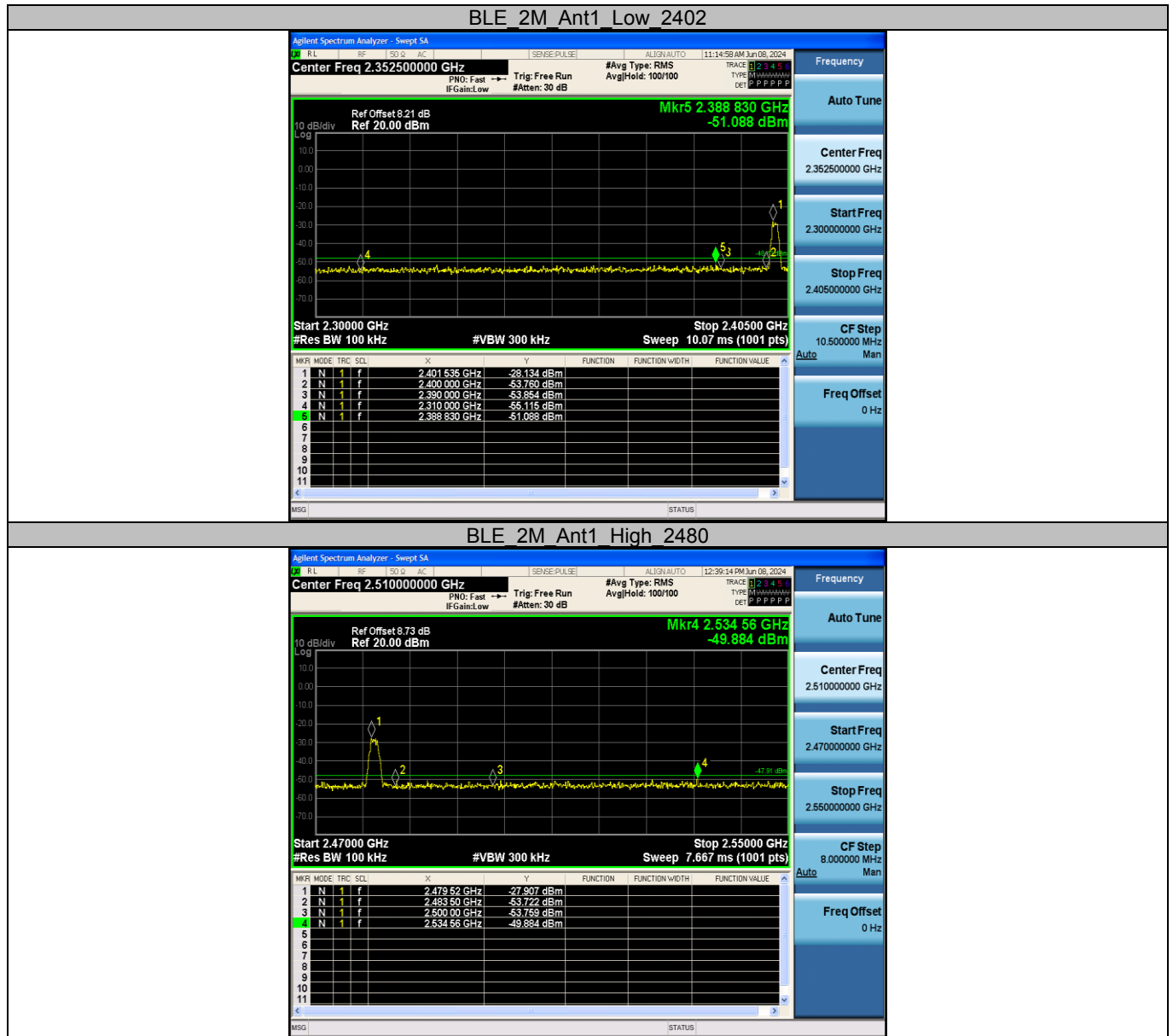

## Appendix E: Conducted Spurious Emission

### Test Graphs

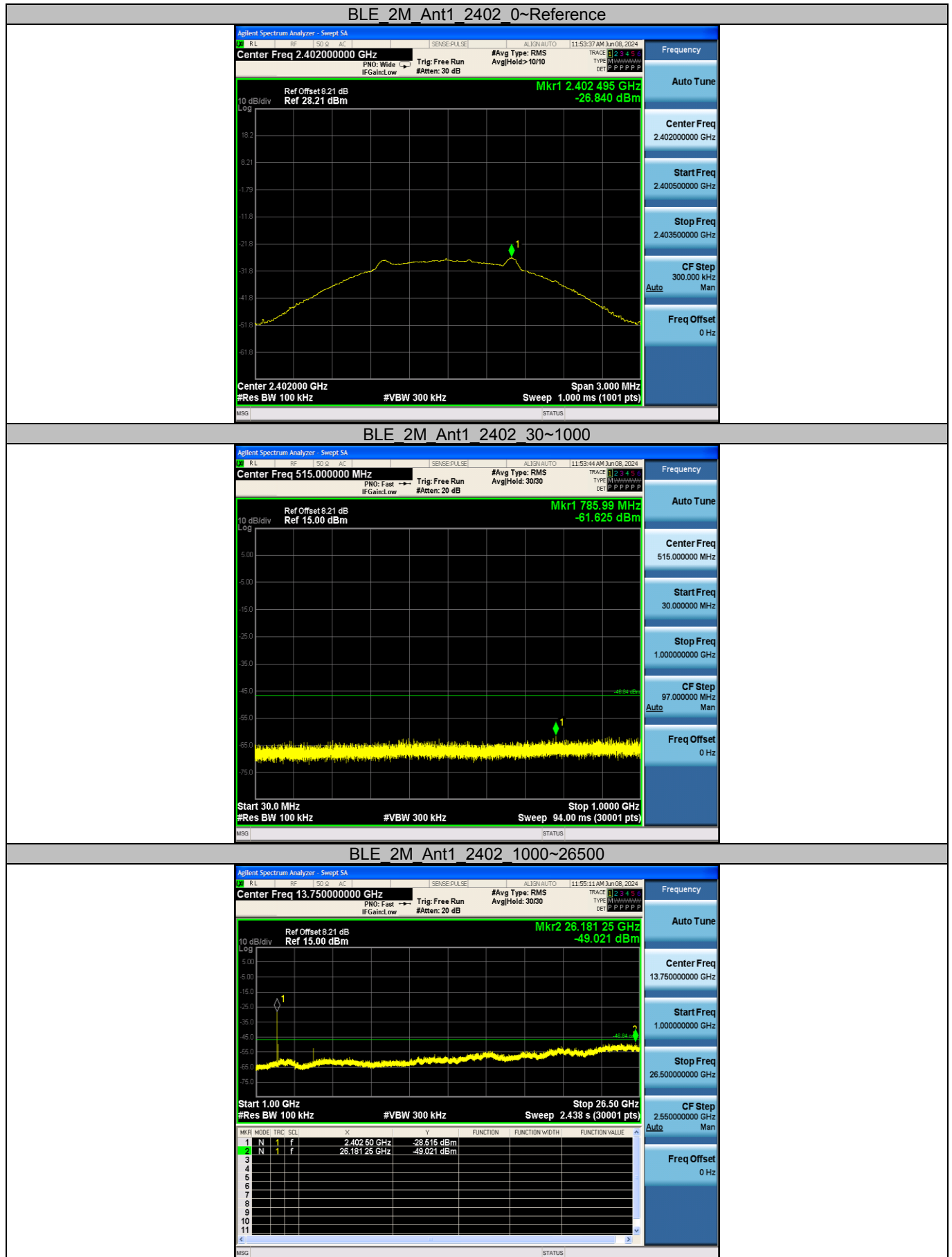

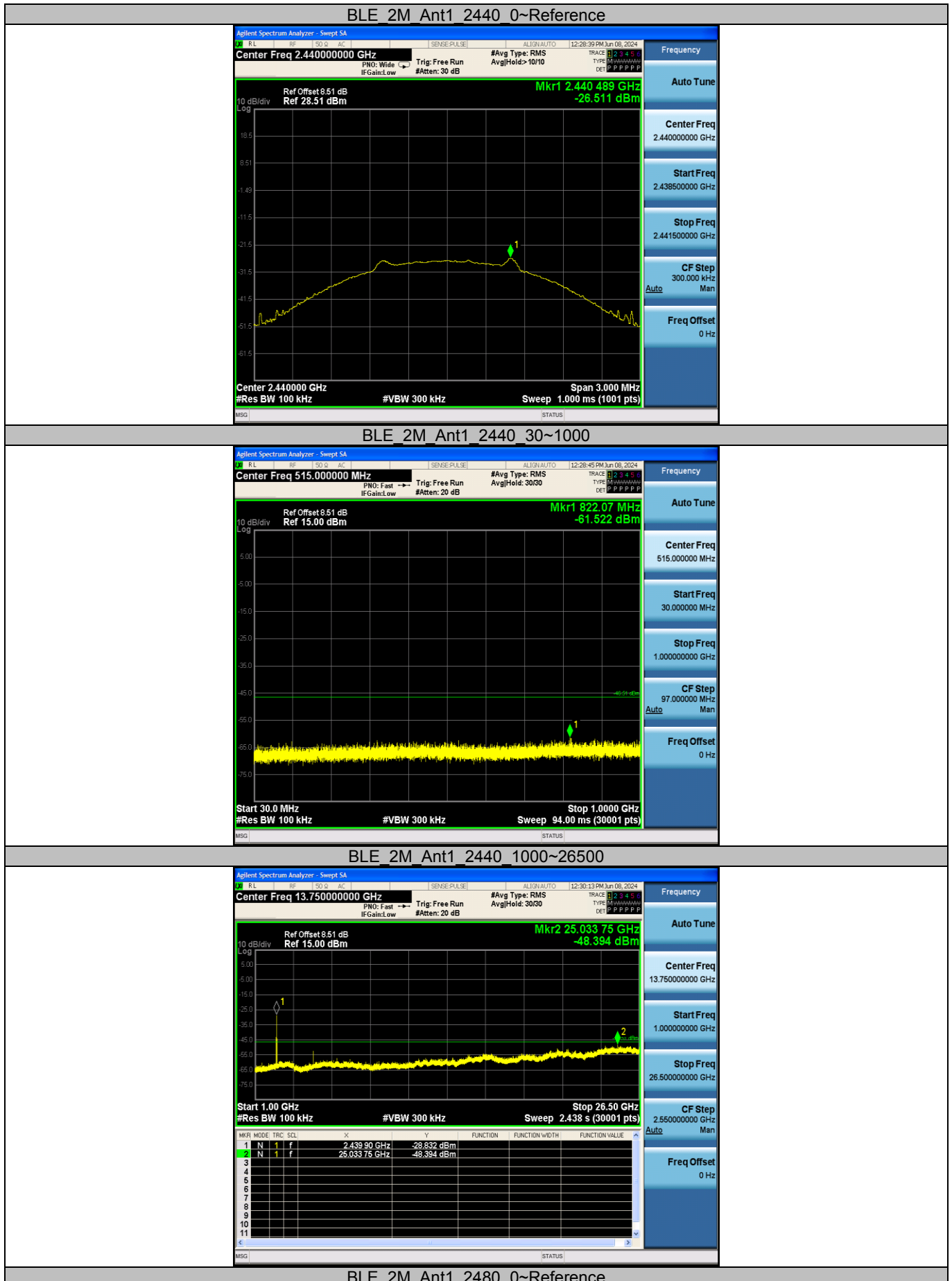



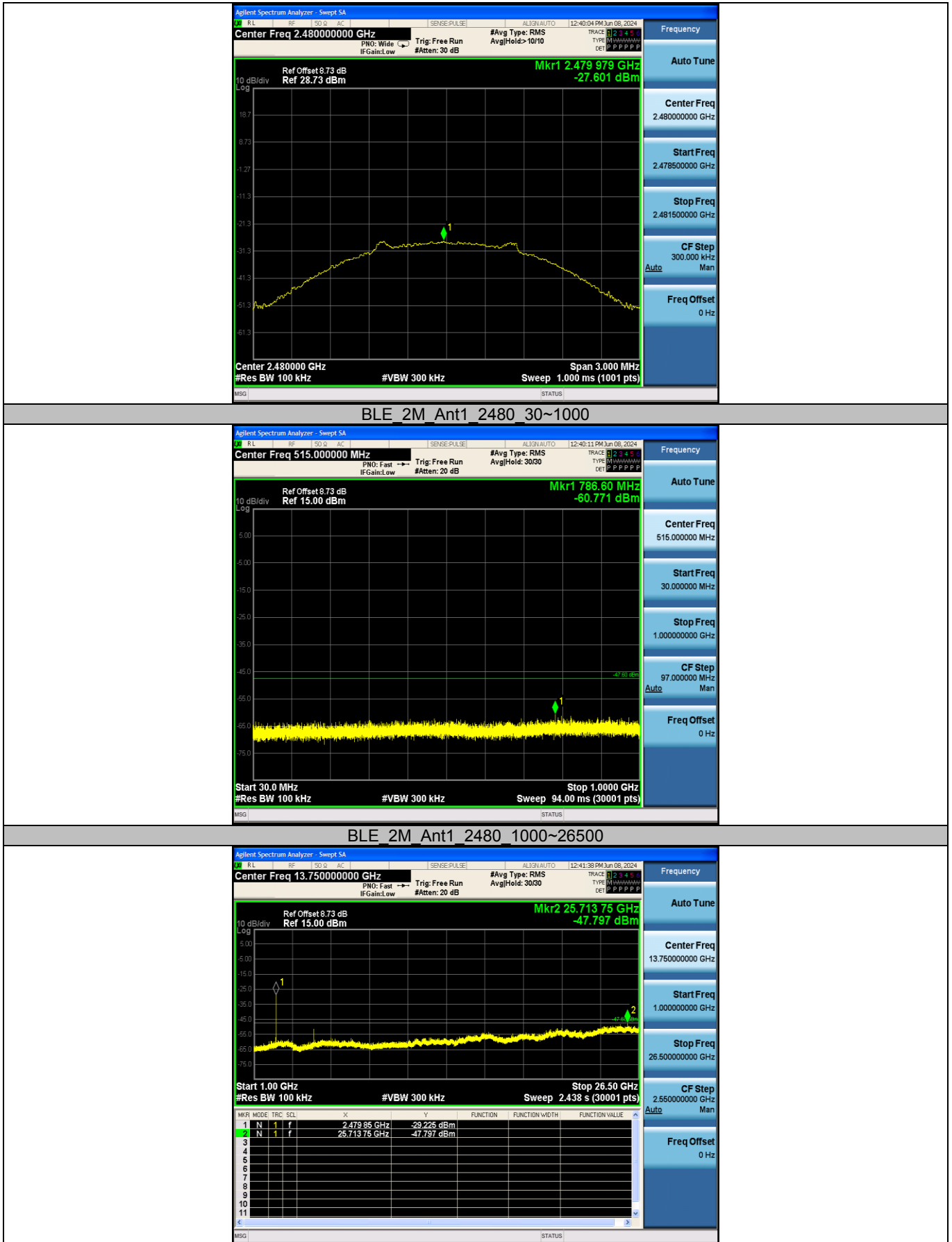

## Appendix F: Duty Cycle

### Test Result

| Test Mode | Antenna | Frequency [MHz] | ON Time [ms] | Period [ms] | Duty Cycle [%] | Duty Cycle Factor[dB] |
|-----------|---------|-----------------|--------------|-------------|----------------|-----------------------|
| BLE_2M    | Ant1    | 2402            | 19.00        | 19.00       | 100.00         | 0.00                  |
|           |         | 2440            | 19.00        | 19.00       | 100.00         | 0.00                  |
|           |         | 2480            | 19.00        | 19.00       | 100.00         | 0.00                  |

## Test Graphs

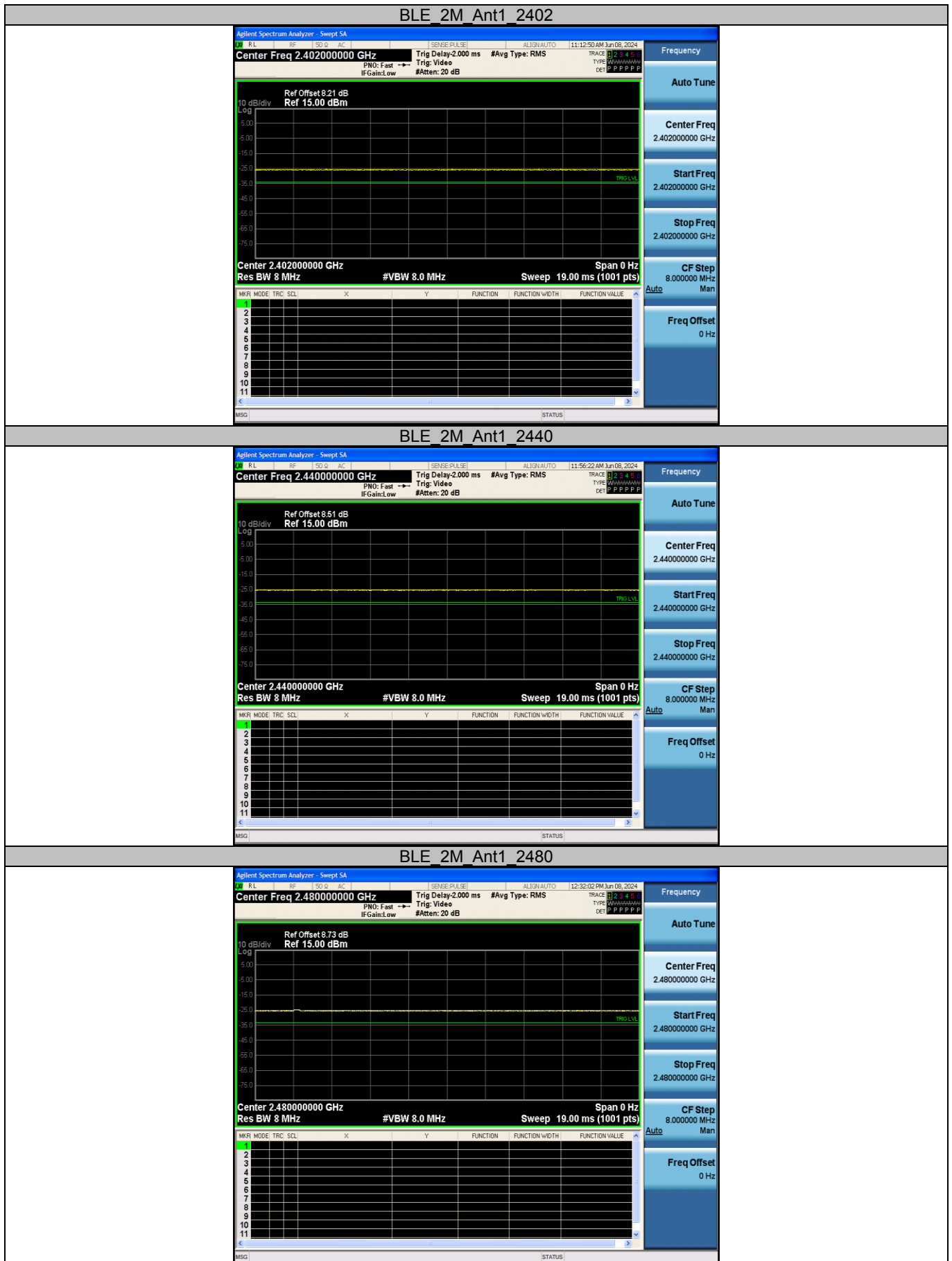

----End of Report----