



SAR REFERENCE DIPOLE CALIBRATION REPORT

Ref: ACR.53.29.24.BES.A

1 INTRODUCTION

This document contains a summary of the requirements set forth by the IEC/IEEE 62209-1528 and FCC KDB865664 D01 standards for reference dipoles used for SAR measurement system validations and the measurements that were performed to verify that the product complies with the fore mentioned standards.

2 DEVICE UNDER TEST

| Device Under Test | |
|--------------------------------|-----------------------------------|
| Device Type | COMOSAR 2450 MHz REFERENCE DIPOLE |
| Manufacturer | MVG |
| Model | SID2450 |
| Serial Number | SN 03/15DIP2G450-352 |
| Product Condition (new / used) | Used |

3 PRODUCT DESCRIPTION

3.1 GENERAL INFORMATION

MVG’s COMOSAR Validation Dipoles are built in accordance to the IEC/IEEE 62209-1528 and FCC KDB865664 D01 standards. The product is designed for use with the COMOSAR test bench only.



Figure 1 – MVG COMOSAR Validation Dipole



SAR REFERENCE DIPOLE CALIBRATION REPORT

Ref: ACR.53.29.24.BES.A

4 MEASUREMENT METHOD

4.1 MECHANICAL REQUIREMENTS

The IEC/IEEE 62209-1528 and FCC KDB865664 D01 standards specify the mechanical components and dimensions of the validation dipoles, with the dimension's frequency and phantom shell thickness dependent. The COMOSAR test bench employs a 2 mm phantom shell thickness therefore the dipoles sold for use with the COMOSAR test bench comply with the requirements set forth for a 2 mm phantom shell thickness. A direct method is used with a ISO17025 calibrated caliper.

4.2 S11 PARAMETER REQUIREMENTS

The dipole used for SAR system validation measurements and checks must have a S11 of -20 dB or better. The S11 measurement shall be performed against a liquid filled flat phantom, with the phantom constructed as outlined in the fore mentioned standards. A direct method is used with a network analyser and its calibration kit, both with a valid ISO17025 calibration.

4.3 SAR REQUIREMENTS

The IEC/IEEE 62209-1528 and FCC KDB865664 D01 standards provide requirements for reference dipoles used for system validation measurements. The following measurements were performed to verify that the product complies with the fore-mentioned standards.

5 MEASUREMENT UNCERTAINTY

5.1 MECHANICAL DIMENSIONS

For the measurement in the range 0-300mm, the estimated expanded uncertainty (k=2) in calibration for the dimension measurement in mm is +/-0.20 mm with respect to measurement conditions.

For the measurement in the range 300-450mm, the estimated expanded uncertainty (k=2) in calibration for the dimension measurement in mm is +/-0.44 mm with respect to measurement conditions.

5.2 S11 PARAMETER

The estimated expanded uncertainty (k=2) in calibration for the S11 parameter in linear is +/-0.08 with respect to measurement conditions.

5.3 SAR

The guidelines outlined in the IEC/IEEE 62209-1528 and FCC KDB865664 D01 standards were followed to generate the measurement uncertainty for validation measurements.

The estimated expanded uncertainty (k=2) in calibration for the 1g and 10g SAR measurement in W/kg is +/-19% with respect to measurement conditions.

Page: 5/8

Template_ACR.DDD.N.YY.MVGB.ISSUE_SAR Reference Dipole vL

This document shall not be reproduced, except in full or in part, without the written approval of MVG. The information contained herein is to be used only for the purpose for which it is submitted and is not to be released in whole or part without written approval of MVG.



SAR REFERENCE DIPOLE CALIBRATION REPORT

Ref: ACR.53.29.24.BES.A

6 CALIBRATION RESULTS

6.1 MECHANICAL DIMENSIONS

| L mm | | h mm | | d mm | |
|----------|--------------|----------|--------------|----------|-------------|
| Measured | Required | Measured | Required | Measured | Required |
| - | 51.50 +/- 2% | - | 30.40 +/- 2% | - | 3.60 +/- 2% |

6.2 S11 PARAMETER

6.2.1 S11 parameter in Head Liquid

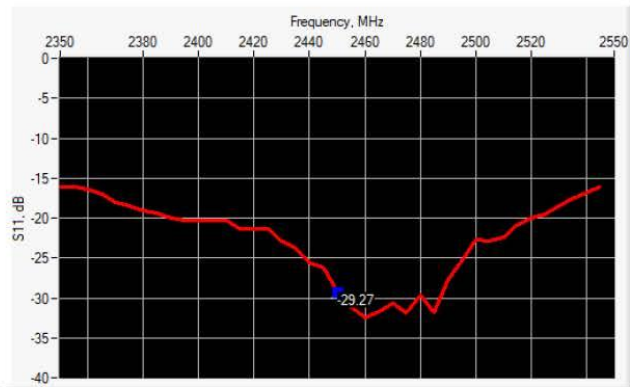

| Frequency (MHz) | S11 parameter (dB) | Requirement (dB) | Impedance |
|-----------------|--------------------|------------------|---------------|
| 2450 | -29.27 | -20 | 53.6Ω + 0.1jΩ |

6.3 SAR

The IEC/IEEE 62209-1528 and FCC KDB865664 D01 standards state that the system validation measurements must be performed using a reference dipole meeting the fore mentioned return loss and mechanical dimension requirements. The validation measurement must be performed against a liquid filled flat phantom, with the phantom constructed as outlined in the fore mentioned standards. Per the standards, the dipole shall be positioned below the bottom of the phantom, with the dipole length centered and parallel to the longest dimension of the flat phantom, with the top surface of the dipole at the described distance from the bottom surface of the phantom.

6.3.1 SAR with Head Liquid

The IEC/IEEE 62209-1528 and FCC KDB865664 D01 standards state that the system validation measurements should produce the SAR values shown below (for phantom thickness of 2 mm), within the uncertainty for the system validation. All SAR values are normalized to 1 W forward power. In bracket, the measured SAR is given with the used input power.



SAR REFERENCE DIPOLE CALIBRATION REPORT

Ref: ACR.53.29.24.BES.A

| | |
|---|--|
| Software | OPENSAR V5 |
| Phantom | SN 13/09 SAM68 |
| Probe | 3523-EPGO-429 |
| Liquid | Head Liquid Values: eps' : 42.1 sigma : 1.83 |
| Distance between dipole center and liquid | 10.0 mm |
| Area scan resolution | dx=8mm/dy=8mm |
| Zoon Scan Resolution | dx=5mm/dy=5mm/dz=5mm |
| Frequency | 2450 MHz |
| Input power | 20 dBm |
| Liquid Temperature | 20 +/- 1 °C |
| Lab Temperature | 20 +/- 1 °C |
| Lab Humidity | 30-70 % |

| Frequency | 1g SAR (W/kg) | | | 10g SAR (W/kg) | | |
|-----------|---------------|---------------------------|-------------------------|----------------|---------------------------|-------------------------|
| | Measured | Measured normalized to 1W | Target normalized to 1W | Measured | Measured normalized to 1W | Target normalized to 1W |
| 2450 MHz | 5.00 | 50.05 | 52.40 | 2.38 | 23.80 | 24.00 |

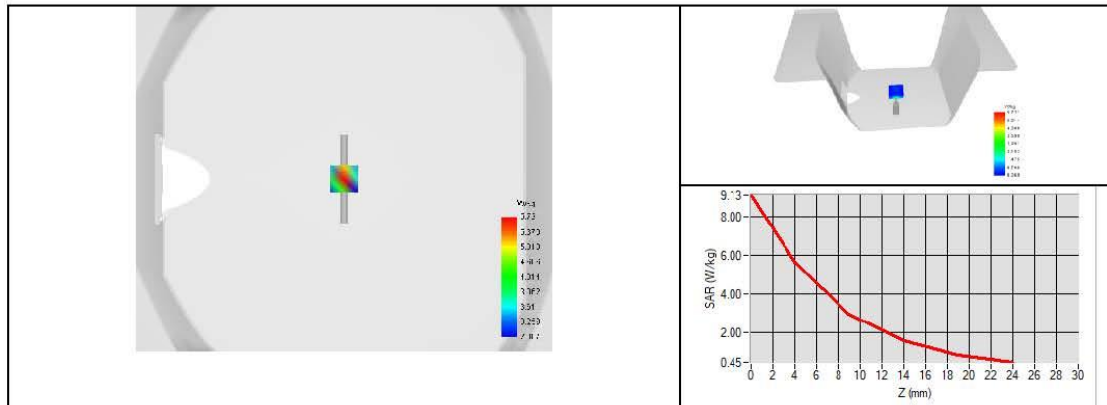



SAR REFERENCE DIPOLE CALIBRATION REPORT

Ref: ACR.53.29.24.BES.A

7 LIST OF EQUIPMENT

| Equipment Summary Sheet | | | | |
|------------------------------------|-------------------------|--------------------|---|---|
| Equipment Description | Manufacturer / Model | Identification No. | Current Calibration Date | Next Calibration Date |
| SAM Phantom | MVG | SN 13/09 SAM68 | Validated. No cal required. | Validated. No cal required. |
| COMOSAR Test Bench | Version 3 | NA | Validated. No cal required. | Validated. No cal required. |
| Network Analyzer | Rohde & Schwarz ZVM | 100203 | 08/2021 | 08/2024 |
| Network Analyzer – Calibration kit | Rohde & Schwarz ZV-Z235 | 101223 | 07/2022 | 07/2025 |
| Calipers | Mitutoyo | SN 0009732 | 11/2022 | 11/2025 |
| Reference Probe | MVG | 3523-EPGO-429 | 11/2023 | 11/2024 |
| Multimeter | Keithley 2000 | 4013982 | 02/2023 | 02/2026 |
| Signal Generator | Rohde & Schwarz SMB | 106589 | 03/2022 | 03/2025 |
| Amplifier | MVG | MODU-023-C-0002 | Characterized prior to test. No cal required. | Characterized prior to test. No cal required. |
| Power Meter | NI-USB 5680 | 170100013 | 06/2021 | 06/2024 |
| Power Meter | Keysight U2000A | SN: MY62340002 | 10/2022 | 10/2025 |
| Directional Coupler | Krytar 158020 | 131467 | Characterized prior to test. No cal required. | Characterized prior to test. No cal required. |
| Temperature / Humidity Sensor | Testo 184 H1 | 44225320 | 06/2021 | 06/2024 |



SAR Reference Dipole Calibration Report

Ref : ACR.53.30.24.BES.A

**SHENZHEN NTEK TESTING TECHNOLOGY
CO., LTD.**

**BUILDING E, FENDA SCIENCE PARK, SANWEI
COMMUNITY, XIXIANG STREET,
BAO'AN DISTRICT, SHENZHEN GUANGDONG, CHINA
MVG COMOSAR REFERENCE DIPOLE**

FREQUENCY: 2600 MHZ

SERIAL NO.: SN 03/15DIP2G600-356

Calibrated at MVG

Z.I. de la pointe du diable

**Technopôle Brest Iroise – 295 avenue Alexis de Rochon
29280 PLOUZANE - FRANCE**

Calibration date: 02/21/2024



Accreditations #2-6789 and #2-6814
Scope available on www.cofrac.fr

The use of the Cofrac brand and the accreditation references is prohibited from any reproduction.

Summary:

This document presents the method and results from an accredited SAR reference dipole calibration performed in MVG using the COMOSAR test bench. All calibration results are traceable to national metrology institutions.



SAR REFERENCE DIPOLE CALIBRATION REPORT

Ref: ACR.53.30.24.BES.A

| | <i>Name</i> | <i>Function</i> | <i>Date</i> | <i>Signature</i> |
|-----------------------------------|--------------|-------------------------|-------------|------------------|
| <i>Prepared by :</i> | Pedro Ruiz | Measurement Responsible | 2/22/2024 | |
| <i>Checked & approved by:</i> | Jérôme Luc | Technical Manager | 2/22/2024 | |
| <i>Authorized by:</i> | Yann Toutain | Laboratory Director | 2/27/2024 | |

Yann
Toutain
ID

Signature numérique de
Yann Toutain ID
Date : 2024.02.27
08:58:12 +01'00'

| | <i>Customer Name</i> |
|-----------------------|---|
| <i>Distribution :</i> | SHENZHEN NTEK TESTING TECHNOLOGY CO., LTD. |

| <i>Issue</i> | <i>Name</i> | <i>Date</i> | <i>Modifications</i> |
|--------------|-------------|-------------|----------------------|
| A | Pedro Ruiz | 2/22/2024 | Initial release |
| | | | |
| | | | |
| | | | |



SAR REFERENCE DIPOLE CALIBRATION REPORT

Ref: ACR.53.30.24.BES.A

TABLE OF CONTENTS

| | | |
|-----|----------------------------------|---|
| 1 | Introduction..... | 4 |
| 2 | Device Under Test | 4 |
| 3 | Product Description | 4 |
| 3.1 | General Information | 4 |
| 4 | Measurement Method | 5 |
| 4.1 | Mechanical Requirements | 5 |
| 4.2 | S11 parameter Requirements | 5 |
| 4.3 | SAR Requirements | 5 |
| 5 | Measurement Uncertainty | 5 |
| 5.1 | Mechanical dimensions | 5 |
| 5.2 | S11 Parameter | 5 |
| 5.3 | SAR | 5 |
| 6 | Calibration Results..... | 6 |
| 6.1 | Mechanical Dimensions | 6 |
| 6.2 | S11 parameter | 6 |
| 6.3 | SAR | 6 |
| 7 | List of Equipment | 8 |



SAR REFERENCE DIPOLE CALIBRATION REPORT

Ref: ACR.53.30.24.BES.A

1 INTRODUCTION

This document contains a summary of the requirements set forth by the IEC/IEEE 62209-1528 and FCC KDB865664 D01 standards for reference dipoles used for SAR measurement system validations and the measurements that were performed to verify that the product complies with the fore mentioned standards.

2 DEVICE UNDER TEST

| Device Under Test | |
|--------------------------------|-----------------------------------|
| Device Type | COMOSAR 2600 MHz REFERENCE DIPOLE |
| Manufacturer | MVG |
| Model | SID2600 |
| Serial Number | SN 03/15DIP2G600-356 |
| Product Condition (new / used) | Used |

3 PRODUCT DESCRIPTION

3.1 GENERAL INFORMATION

MVG’s COMOSAR Validation Dipoles are built in accordance to the IEC/IEEE 62209-1528 and FCC KDB865664 D01 standards. The product is designed for use with the COMOSAR test bench only.



Figure 1 – MVG COMOSAR Validation Dipole



SAR REFERENCE DIPOLE CALIBRATION REPORT

Ref: ACR.53.30.24.BES.A

4 MEASUREMENT METHOD

4.1 MECHANICAL REQUIREMENTS

The IEC/IEEE 62209-1528 and FCC KDB865664 D01 standards specify the mechanical components and dimensions of the validation dipoles, with the dimension's frequency and phantom shell thickness dependent. The COMOSAR test bench employs a 2 mm phantom shell thickness therefore the dipoles sold for use with the COMOSAR test bench comply with the requirements set forth for a 2 mm phantom shell thickness. A direct method is used with a ISO17025 calibrated caliper.

4.2 S11 PARAMETER REQUIREMENTS

The dipole used for SAR system validation measurements and checks must have a S11 of -20 dB or better. The S11 measurement shall be performed against a liquid filled flat phantom, with the phantom constructed as outlined in the fore mentioned standards. A direct method is used with a network analyser and its calibration kit, both with a valid ISO17025 calibration.

4.3 SAR REQUIREMENTS

The IEC/IEEE 62209-1528 and FCC KDB865664 D01 standards provide requirements for reference dipoles used for system validation measurements. The following measurements were performed to verify that the product complies with the fore-mentioned standards.

5 MEASUREMENT UNCERTAINTY

5.1 MECHANICAL DIMENSIONS

For the measurement in the range 0-300mm, the estimated expanded uncertainty (k=2) in calibration for the dimension measurement in mm is +/-0.20 mm with respect to measurement conditions.

For the measurement in the range 300-450mm, the estimated expanded uncertainty (k=2) in calibration for the dimension measurement in mm is +/-0.44 mm with respect to measurement conditions.

5.2 S11 PARAMETER

The estimated expanded uncertainty (k=2) in calibration for the S11 parameter in linear is +/-0.08 with respect to measurement conditions.

5.3 SAR

The guidelines outlined in the IEC/IEEE 62209-1528 and FCC KDB865664 D01 standards were followed to generate the measurement uncertainty for validation measurements.

The estimated expanded uncertainty (k=2) in calibration for the 1g and 10g SAR measurement in W/kg is +/-19% with respect to measurement conditions.

Page: 5/8

Template_ACR.DDD.N.YY.MVGB.ISSUE_SAR Reference Dipole vL

This document shall not be reproduced, except in full or in part, without the written approval of MVG. The information contained herein is to be used only for the purpose for which it is submitted and is not to be released in whole or part without written approval of MVG.



SAR REFERENCE DIPOLE CALIBRATION REPORT

Ref: ACR.53.30.24.BES.A

6 CALIBRATION RESULTS

6.1 MECHANICAL DIMENSIONS

| L mm | | h mm | | d mm | |
|----------|--------------|----------|--------------|----------|-------------|
| Measured | Required | Measured | Required | Measured | Required |
| - | 48.50 +/- 2% | - | 28.80 +/- 2% | - | 3.60 +/- 2% |

6.2 S11 PARAMETER

6.2.1 S11 parameter in Head Liquid

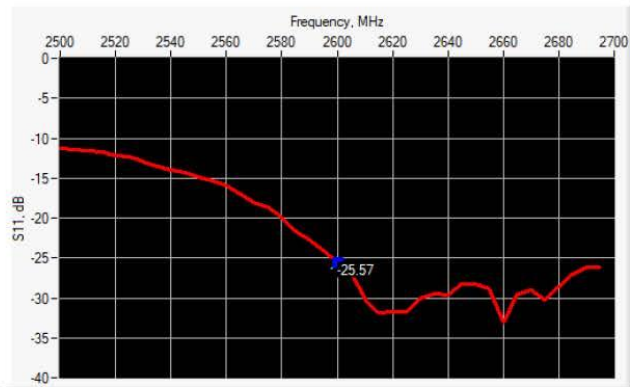

| Frequency (MHz) | S11 parameter (dB) | Requirement (dB) | Impedance |
|-----------------|--------------------|------------------|---------------|
| 2600 | -25.57 | -20 | 54.5Ω - 3.2jΩ |

6.3 SAR

The IEC/IEEE 62209-1528 and FCC KDB865664 D01 standards state that the system validation measurements must be performed using a reference dipole meeting the fore mentioned return loss and mechanical dimension requirements. The validation measurement must be performed against a liquid filled flat phantom, with the phantom constructed as outlined in the fore mentioned standards. Per the standards, the dipole shall be positioned below the bottom of the phantom, with the dipole length centered and parallel to the longest dimension of the flat phantom, with the top surface of the dipole at the described distance from the bottom surface of the phantom.

6.3.1 SAR with Head Liquid

The IEC/IEEE 62209-1528 and FCC KDB865664 D01 standards state that the system validation measurements should produce the SAR values shown below (for phantom thickness of 2 mm), within the uncertainty for the system validation. All SAR values are normalized to 1 W forward power. In bracket, the measured SAR is given with the used input power.



SAR REFERENCE DIPOLE CALIBRATION REPORT

Ref: ACR.53.30.24.BES.A

| | |
|---|--|
| Software | OPENSAR V5 |
| Phantom | SN 13/09 SAM68 |
| Probe | 3523-EPGO-429 |
| Liquid | Head Liquid Values: eps' : 41.3 sigma : 1.95 |
| Distance between dipole center and liquid | 10.0 mm |
| Area scan resolution | dx=8mm/dy=8mm |
| Zoon Scan Resolution | dx=5mm/dy=5mm/dz=5mm |
| Frequency | 2600 MHz |
| Input power | 20 dBm |
| Liquid Temperature | 20 +/- 1 °C |
| Lab Temperature | 20 +/- 1 °C |
| Lab Humidity | 30-70 % |

| Frequency | 1g SAR (W/kg) | | | 10g SAR (W/kg) | | |
|-----------|---------------|---------------------------|-------------------------|----------------|---------------------------|-------------------------|
| | Measured | Measured normalized to 1W | Target normalized to 1W | Measured | Measured normalized to 1W | Target normalized to 1W |
| 2600 MHz | 5.42 | 54.16 | 55.30 | 2.49 | 24.85 | 24.60 |

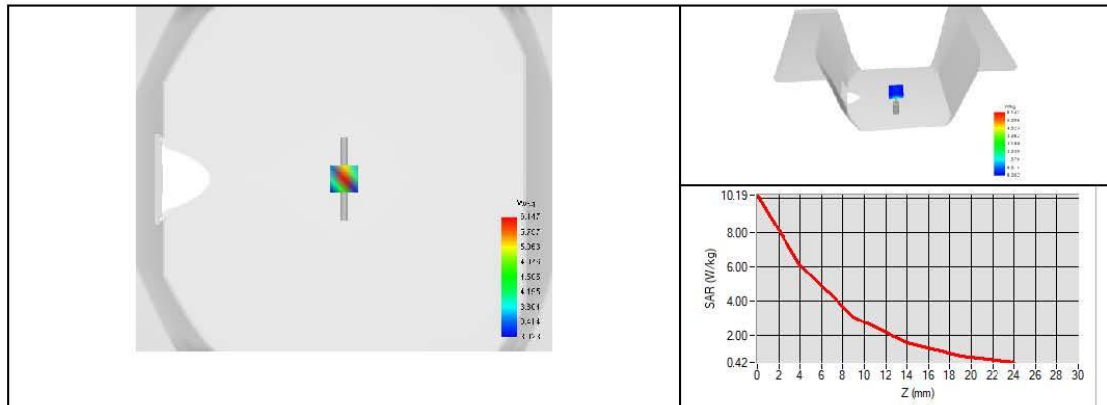



SAR REFERENCE DIPOLE CALIBRATION REPORT

Ref: ACR.53.30.24.BES.A

7 LIST OF EQUIPMENT

| Equipment Summary Sheet | | | | |
|------------------------------------|-------------------------|--------------------|---|---|
| Equipment Description | Manufacturer / Model | Identification No. | Current Calibration Date | Next Calibration Date |
| SAM Phantom | MVG | SN 13/09 SAM68 | Validated. No cal required. | Validated. No cal required. |
| COMOSAR Test Bench | Version 3 | NA | Validated. No cal required. | Validated. No cal required. |
| Network Analyzer | Rohde & Schwarz ZVM | 100203 | 08/2021 | 08/2024 |
| Network Analyzer – Calibration kit | Rohde & Schwarz ZV-Z235 | 101223 | 07/2022 | 07/2025 |
| Calipers | Mitutoyo | SN 0009732 | 11/2022 | 11/2025 |
| Reference Probe | MVG | 3523-EPGO-429 | 11/2023 | 11/2024 |
| Multimeter | Keithley 2000 | 4013982 | 02/2023 | 02/2026 |
| Signal Generator | Rohde & Schwarz SMB | 106589 | 03/2022 | 03/2025 |
| Amplifier | MVG | MODU-023-C-0002 | Characterized prior to test. No cal required. | Characterized prior to test. No cal required. |
| Power Meter | NI-USB 5680 | 170100013 | 06/2021 | 06/2024 |
| Power Meter | Keysight U2000A | SN: MY62340002 | 10/2022 | 10/2025 |
| Directional Coupler | Krytar 158020 | 131467 | Characterized prior to test. No cal required. | Characterized prior to test. No cal required. |
| Temperature / Humidity Sensor | Testo 184 H1 | 44225320 | 06/2021 | 06/2024 |



SAR Reference Waveguide Calibration Report

Ref : ACR.53.31.24.BES.A

**SHENZHEN NTEK TESTING TECHNOLOGY
CO., LTD.**
**BUILDING E, FENDA SCIENCE PARK, SANWEI
COMMUNITY, XIXIANG STREET, BAO'AN
DISTRICT, SHENZHEN GUANGDONG, CHINA MVG
COMOSAR REFERENCE WAVEGUIDE**
FREQUENCY: 5000-6000 MHZ
SERIAL NO.: SN 13/14 WGA 33

Calibrated at MVG
Z.I. de la pointe du diable
Technopôle Brest Iroise – 295 avenue Alexis de Rochon
29280 PLOUZANE - FRANCE
Calibration date: 02/21/2024



Accreditations #2-6789 and #2-6814
Scope available on www.cofrac.fr

The use of the Cofrac brand and the accreditation references is prohibited from any reproduction.

Summary:

This document presents the method and results from an accredited SAR reference waveguide calibration performed at MVG, using the COMOSAR test bench. The test results covered by accreditation are traceable to the International System of Units (SI).



SAR REFERENCE WAVEGUIDE CALIBRATION REPORT

Ref: ACR.53.31.24.BES.A

| | <i>Name</i> | <i>Function</i> | <i>Date</i> | <i>Signature</i> |
|-----------------------------------|--------------|-------------------------|-------------|------------------|
| <i>Prepared by:</i> | Pedro Ruiz | Measurement Responsible | 2/22/2024 | |
| <i>Checked & approved by:</i> | Jérôme Luc | Technical Manager | 2/22/2024 | |
| <i>Authorized by:</i> | Yann Toutain | Laboratory Director | 2/27/2024 | |

Yann Toutain ID
 Signature numérique de Yann Toutain ID
 Date : 2024.02.27 08:58:45 +01'00'

| | <i>Customer Name</i> |
|-----------------------|--|
| <i>Distribution :</i> | SHENZHEN NTEK TESTING TECHNOLOGY CO., LTD. |

| <i>Issue</i> | <i>Name</i> | <i>Date</i> | <i>Modifications</i> |
|--------------|-------------|-------------|----------------------|
| A | Pedro Ruiz | 2/22/2024 | Initial release |
| | | | |
| | | | |
| | | | |



SAR REFERENCE WAVEGUIDE CALIBRATION REPORT

Ref: ACR.53.31.24.BES.A

TABLE OF CONTENTS

| | | |
|-----|----------------------------------|---|
| 1 | Introduction..... | 4 |
| 2 | Device Under Test | 4 |
| 3 | Product Description | 4 |
| 3.1 | General Information | 4 |
| 4 | Measurement Method | 4 |
| 4.1 | Mechanical Requirements | 4 |
| 4.2 | S11 parameter Requirements | 4 |
| 4.3 | SAR Requirements | 5 |
| 5 | Measurement Uncertainty | 5 |
| 5.1 | Mechanical dimensions | 5 |
| 5.2 | S11 Parameter | 5 |
| 5.3 | SAR | 5 |
| 6 | Calibration Results..... | 5 |
| 6.1 | Mechanical Dimensions | 5 |
| 6.2 | S11 parameter | 6 |
| 6.3 | SAR | 6 |
| 7 | List of Equipment | 9 |



SAR REFERENCE WAVEGUIDE CALIBRATION REPORT

Ref: ACR.53.31.24.BES.A

1 INTRODUCTION

This document contains a summary of the requirements set forth by the IEC/IEEE 62209-1528 and FCC KDB865664 D01 standards for reference waveguides used for SAR measurement system validations and the measurements that were performed to verify that the product complies with the fore mentioned standards.

2 DEVICE UNDER TEST

| Device Under Test | |
|--------------------------------|---|
| Device Type | COMOSAR 5000-6000 MHz REFERENCE WAVEGUIDE |
| Manufacturer | MVG |
| Model | SWG5500 |
| Serial Number | SN 13/14 WGA 33 |
| Product Condition (new / used) | Used |

3 PRODUCT DESCRIPTION

3.1 GENERAL INFORMATION

MVG’s COMOSAR Validation Waveguides are built in accordance to the IEC/IEEE 62209-1528 and FCC KDB865664 D01 standards.

4 MEASUREMENT METHOD

4.1 MECHANICAL REQUIREMENTS

The IEC/IEEE 62209-1528 and FCC KDB865664 D01 standards specify the mechanical components and dimensions of the validation dipoles, with the dimension’s frequency and phantom shell thickness dependent. The COMOSAR test bench employs a 2 mm phantom shell thickness therefore the dipoles sold for use with the COMOSAR test bench comply with the requirements set forth for a 2 mm phantom shell thickness. A direct method is used with a ISO17025 calibrated caliper.

4.2 S11 PARAMETER REQUIREMENTS

The dipole used for SAR system validation measurements and checks must have a S11 of -8 dB or better. The S11 measurement shall be performed against a liquid filled flat phantom, with the phantom constructed as outlined in the fore mentioned standards. A direct method is used with a network analyser and its calibration kit, both with a valid ISO17025 calibration.



SAR REFERENCE WAVEGUIDE CALIBRATION REPORT

Ref: ACR.53.31.24.BES.A

4.3 SAR REQUIREMENTS

The IEC/IEEE 62209-1528 and FCC KDB865664 D01 standards provide requirements for reference dipoles used for system validation measurements. The following measurements were performed to verify that the product complies with the fore-mentioned standards.

5 MEASUREMENT UNCERTAINTY

5.1 MECHANICAL DIMENSIONS

The estimated expanded uncertainty (k=2) in calibration for the dimension measurement in mm is +/- 0.20 mm with respect to measurement conditions.

5.2 S11 PARAMETER

The estimated expanded uncertainty (k=2) in calibration for the S11 parameter in linear is +/-0.08 with respect to measurement conditions.

5.3 SAR

The guidelines outlined in the IEC/IEEE 62209-1528 and FCC KDB865664 D01 standards were followed to generate the measurement uncertainty for validation measurements.

The estimated expanded uncertainty (k=2) in calibration for the 1g and 10g SAR measurement in W/kg is +/-19% with respect to measurement conditions.

6 CALIBRATION RESULTS

6.1 MECHANICAL DIMENSIONS

| Frequency (MHz) | L (mm) | | W (mm) | | Lr (mm) | | Wr (mm) | |
|-----------------|--------------|----------|--------------|----------|--------------|----------|--------------|----------|
| | Required | Measured | Required | Measured | Required | Measured | Required | Measured |
| 5800 | 40.39 ± 0.13 | - | 20.19 ± 0.13 | - | 81.03 ± 0.13 | - | 61.98 ± 0.13 | - |

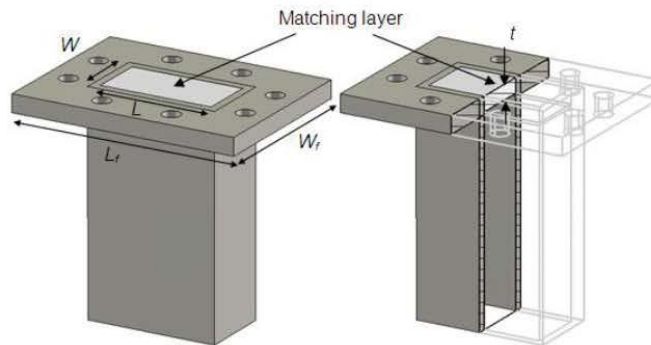

Figure 1: Validation Waveguide Dimensions



SAR REFERENCE WAVEGUIDE CALIBRATION REPORT

Ref: ACR.53.31.24.BES.A

6.2 S11 PARAMETER

6.2.1 S11 parameter In Head Liquid

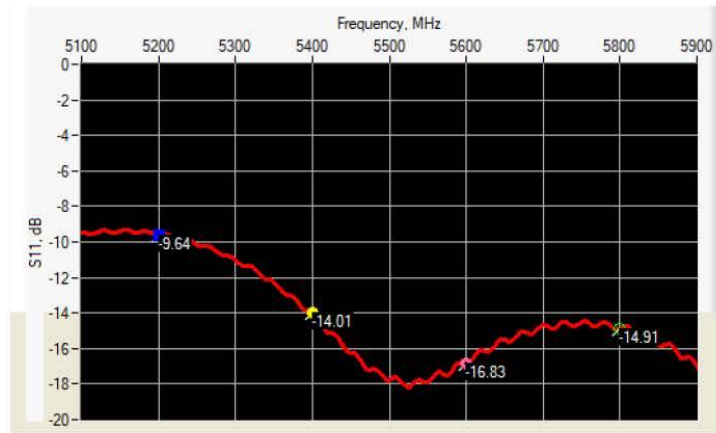

| Frequency (MHz) | S11 parameter (dB) | Requirement (dB) | Impedance |
|-----------------|--------------------|------------------|--------------------|
| 5200 | -9.64 | -8 | 25.80 Ω - 6.58 jΩ |
| 5400 | -14.01 | -8 | 51.53 Ω + 20.60 jΩ |
| 5600 | -16.83 | -8 | 44.12 Ω - 12.35 jΩ |
| 5800 | -14.91 | -8 | 38.53 Ω + 11.21 jΩ |

6.3 SAR

The IEC/IEEE 62209-1528 and FCC KDB865664 D01 standards state that the system validation measurements must be performed using a reference waveguide meeting the fore mentioned return loss and mechanical dimension requirements. The validation measurement must be performed with the matching layer placed in the open end of the waveguide, with the waveguide and matching layer in direct contact with the phantom shell.

6.3.1 SAR With Head Liquid

At those frequencies, the target SAR value can not be generic. Hereunder is the target SAR value defined by MVG, within the uncertainty for the system validation. All SAR values are normalized to 1 W net power. In bracket, the measured SAR is given with the used input power.



SAR REFERENCE WAVEGUIDE CALIBRATION REPORT

Ref: ACR.53.31.24.BES.A

| | |
|--|--|
| Software | OPENSAR V5 |
| Phantom | SN 13/09 SAM68 |
| Probe | 3523-EPGO-429 |
| Liquid | Head Liquid Values 5200 MHz: eps' :34.16 sigma : 4.42 Head Liquid Values 5400 MHz: eps' :33.63 sigma : 4.64 Head Liquid Values 5600 MHz: eps' :33.12 sigma : 4.87 Head Liquid Values 5800 MHz: eps' :32.57 sigma : 5.12 |
| Distance between dipole waveguide and liquid | 0 mm |
| Area scan resolution | dx=8mm/dy=8mm |
| Zoon Scan Resolution | dx=4mm/dy=4m/dz=2mm |
| Frequency | 5200 MHz 5400 MHz 5600 MHz 5800 MHz |
| Input power | 20 dBm |
| Liquid Temperature | 20 +/- 1 °C |
| Lab Temperature | 20 +/- 1 °C |
| Lab Humidity | 30-70 % |

| Frequency (MHz) | 1 g SAR (W/kg) | | | 10 g SAR (W/kg) | | |
|-----------------|----------------|---------------------------|-------------------------|-----------------|---------------------------|-------------------------|
| | Measured | Measured normalized to 1W | Target normalized to 1W | Measured | Measured normalized to 1W | Target normalized to 1W |
| 5200 | 16.26 | 162.59 | 159.00 | 5.62 | 56.21 | 56.90 |
| 5400 | 15.98 | 159.81 | 166.40 | 5.50 | 55.00 | 58.43 |
| 5600 | 17.91 | 179.15 | 173.80 | 6.10 | 61.01 | 59.97 |
| 5800 | 18.22 | 182.20 | 181.20 | 6.13 | 61.32 | 61.50 |

SAR MEASUREMENT PLOTS @ 5200 MHz

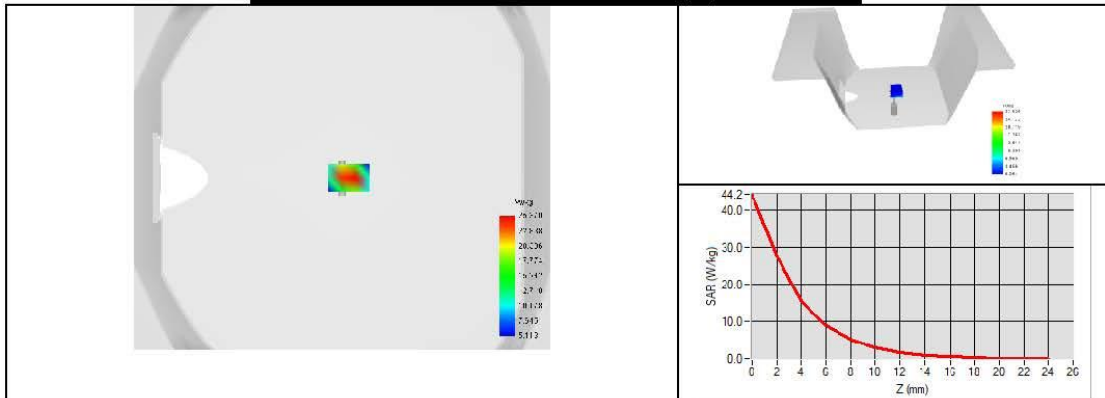



SAR REFERENCE WAVEGUIDE CALIBRATION REPORT

Ref: ACR.53.31.24.BES.A

SAR MEASUREMENT PLOTS @ 5400 MHz

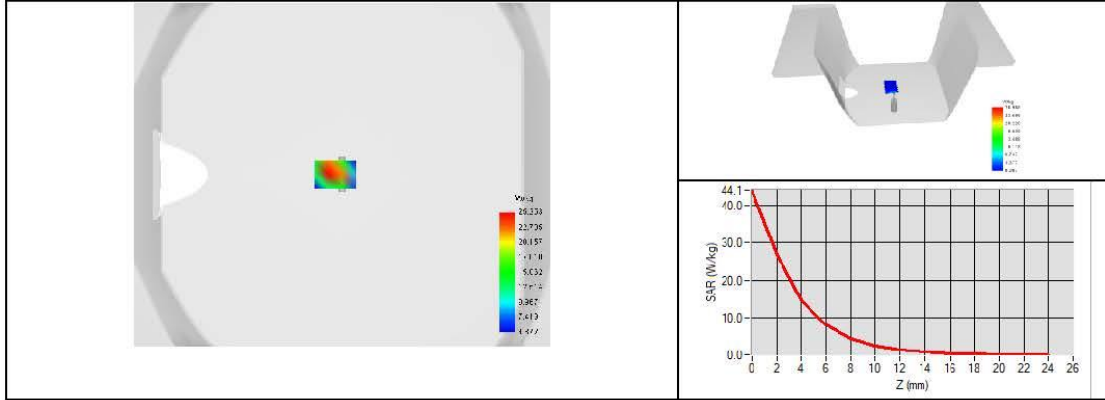

SAR MEASUREMENT PLOTS @ 5600 MHz

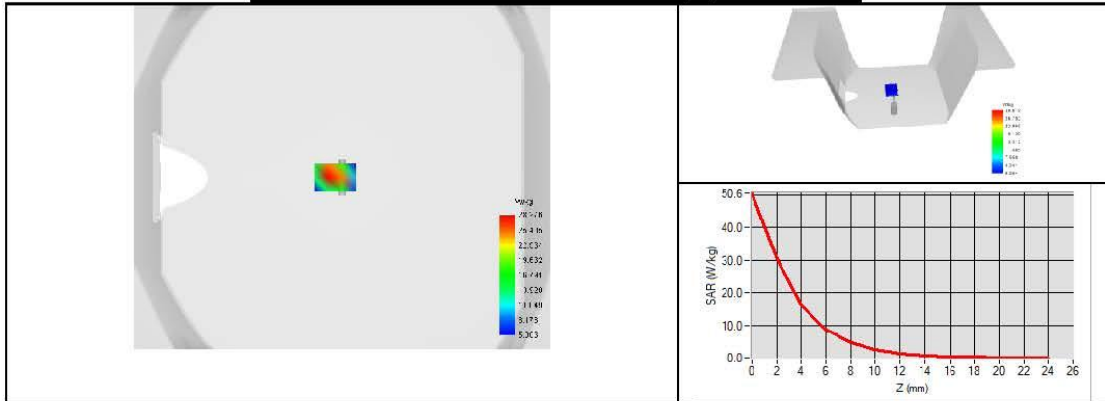

SAR MEASUREMENT PLOTS @ 5800 MHz

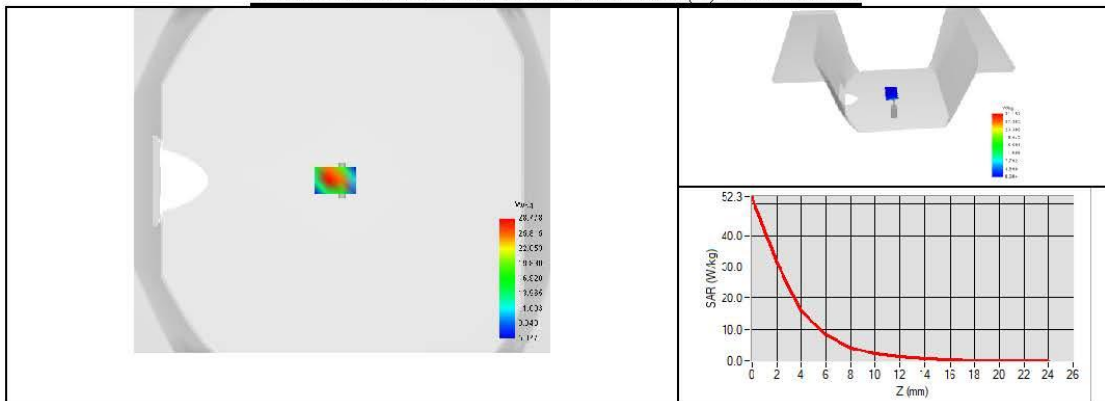



SAR REFERENCE WAVEGUIDE CALIBRATION REPORT

Ref: ACR.53.31.24.BES.A

7 LIST OF EQUIPMENT

| Equipment Summary Sheet | | | | |
|------------------------------------|-------------------------|--------------------|---|---|
| Equipment Description | Manufacturer / Model | Identification No. | Current Calibration Date | Next Calibration Date |
| SAM Phantom | MVG | SN 13/09 SAM68 | Validated. No cal required. | Validated. No cal required. |
| COMOSAR Test Bench | Version 3 | NA | Validated. No cal required. | Validated. No cal required. |
| Network Analyzer | Rohde & Schwarz ZVM | 100203 | 08/2021 | 08/2024 |
| Network Analyzer – Calibration kit | Rohde & Schwarz ZV-Z235 | 101223 | 07/2022 | 07/2025 |
| Calipers | Mitutoyo | SN 0009732 | 11/2022 | 11/2025 |
| Reference Probe | MVG | 3623-EPGO-431 | 11/2023 | 11/2024 |
| Multimeter | Keithley 2000 | 4013982 | 02/2023 | 02/2026 |
| Signal Generator | Rohde & Schwarz SMB | 106589 | 03/2022 | 03/2025 |
| Amplifier | MVG | MODU-023-C-0002 | Characterized prior to test. No cal required. | Characterized prior to test. No cal required. |
| Power Meter | NI-USB 5680 | 170100013 | 06/2021 | 06/2024 |
| Power Meter | Keysight U2000A | SN: MY62340002 | 10/2022 | 10/2025 |
| Directional Coupler | Krytar 158020 | 131467 | Characterized prior to test. No cal required. | Characterized prior to test. No cal required. |
| Temperature / Humidity Sensor | Testo 184 H1 | 44225320 | 06/2021 | 06/2024 |