

FCC ID:2AT9N-WS-MC-20  
IC:25357-WSMC20

HIGH PERFORMANCE AUDIO

# WS-MC-20

WS-MC-20 1-Piece Marine Receiver  
OWNER'S MANUAL

  
READY



WETSOUNDS.COM

# 1

## THANK YOU FOR PURCHASING WET SOUNDS!

**Congratulations! Thank You for purchasing the  
Wet Sounds WS-MC-20 1 Piece Marine Receiver!**



Wet Sounds professional marine audio products represent the ultimate in high performance marine audio. Wet Sounds products are specifically engineered to withstand the rigorous marine environment.

Please take a moment to read the instruction manual & connection guide before starting the installation. If you have any questions or concerns, please contact a certified Wet Sounds dealer or Wet Sounds Tech Support:

### **FCC Compliance Statement**

This device complies with Part 15 of the FCC Rules. Operation is subject to the following two conditions.

1. This device may not cause harmful interference, and
2. This device must accept any interference received, including interference that may cause undesired operation.

These limits are designed to provide reasonable protection against harmful interference in a residential installation.

This equipment generates—and can radiate—radio frequency energy and, if not installed and used in accordance with the instructions, may cause harmful interference to radio communications. However, there is no guarantee that interference will not occur in a particular installation. If the equipment does not cause harmful interference to radio or television reception, which can be determined by turning the equipment off and on, the user is encouraged to try to correct the interference by one or more of the following measures:

- Reorient or relocate the receiving antenna
- Increase the separation between the equipment and the receiver
- Connect the equipment into an outlet on a circuit different from that to which the receiver is connected.
- Consult the dealer or an experienced radio/TV technician for help.

The provided shielded USB cable must be used with this unit to ensure compliance with the class B FCC limits. Warning: Changes or modifications to this unit not expressly approved by the party responsible for compliance could void the user's authority to operate the equipment.

**Wet Sounds WS-MC20 1 Piece Marine Receiver Operations / Installation Manual**

## WS-MC-20 is a marine grade 1- piece receiver

2

### FEATURES INCLUDE:

- AM/FM/Weather Band tuner with RBDS
- Bluetooth Streaming, Auxiliary, & USB Inputs
- SiriusXM-Ready™ (SiriusXM Connect Tuner and Subscription sold separately)
- Simple & Secure Bluetooth Pairing for Android & IOS (A2DP/AVRCP 1.4)
- 2.7" Ultra Bright full color TFT display – displays album art via compatible devices
- Playlist & folder browsing via BT or USB Connection via compatible devices
- Internal Power Amplifier 4x50W @ 2 Ohm Max Output
- Front & Rear Preamp outputs with fading capability
- Front Panel Mounted Independent Secondary Zone Control – Full Range or Subwoofer
- Reverse Camera Video Input with Reverse Trigger
- NMEA 2000 Connectivity (Optional interface accessory required)
- Adjustable Input Gains for all inputs
- Day/Night Illumination & Dimming
- Accepts the optional MC-TR transom remote
- Optional Flush Mount Bezel

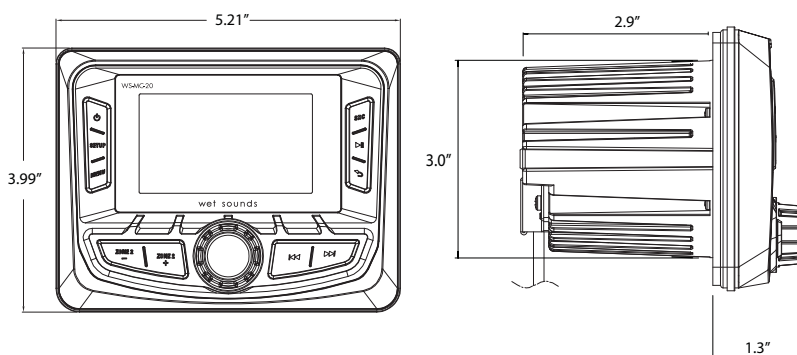

### **Included with the WS-MC-20:**

- Wiring Harness & Mounting hardware

Please take a moment to read the instruction manual & connection guide before starting the installation. If you have any questions or concerns, please contact a certified Wet Sounds dealer or Wet Sounds Tech Support: **1-877-938-7757** / [www.wetsounds.com](http://www.wetsounds.com)

### 3

## WS-MC-20 BASIC CONTROLS



**1. Main Control Knob (MCK)** This allows adjustment of Main Volume, as well as making selections when the SETUP and MENU features are being used. Rotate the MCK to highlight a feature, then depress the MCK to select the highlighted feature.

**2. POWER/MUTE** Press & hold this button for power on/off. Short press this button to MUTE/UNMUTE the volume of all zones. The MC2 will confirm the volume is muted in the display.

**3. SETUP** Allows access to controls that affect all functions of the MC2. Rotate the MCK until the desired function is highlighted, then depress the MCK for access. The functions are:

**AUDIO** Allows access to the following audio adjustments:

**Position** Allows adjustment of the Balance (Left/ Right) and Fader (Front Rear) of the main outputs – both powered & pre-amp. Rotate the MCK to highlight the desired function, depress the MCK then rotate the MCK to adjust the function.

**Equalization** The WS-MC-20 has 7 different factory equalization settings for the 7 Band equalizer. Also available is CUSTOM setting, allowing the user to set their own equalization curve. Rotate & depress the MCK to select one of 7 the bands of equalization, rotate the MCK to adjust.

**CROSSOVER** Select to allow adjustment of the Crossovers:

**FRONT HPF** This controls the frequencies which are allowed to pass through the Front outputs – both powered and pre-amp. Choosing 60Hz, 80Hz, or 120Hz means that all frequencies below those will be blocked from passing. Choosing All Pass Filter (APF) will allow all frequencies to pass through the front outputs.

**REAR HPF** Same as above, but affects the Rear Outputs.

**ZONE 2 LPF** Select to allow adjustment of the Crossovers:

### **SUBWOOFER**

This controls the frequencies which are allowed to pass through the ZONE 2 outputs – which are mixed mono & Pre-amp only. Choosing 60Hz, 80Hz, or 120Hz means that all frequencies above those will be blocked from passing. This would be ideal for an amplifier driving a subwoofer or a self-amplified subwoofer.

### **FULL RANGE**

Choosing All Pass Filter will allow all frequencies to pass through the ZONE 2 Outputs. This would be ideal for an amplifier driving a set of Tower Speakers.

**SYSTEM** Allows access to the following system adjustments:

**AREA** The WS-MC-20 is defaulted to receive broadcasts in the USA region, but Russia, Latin America, Asia, Japan, Middle East, Australia & Europe regions are also available through this setting.

**DAY NIGHT MODE** Allows the ability to scroll through the display options of DAY (white screen/black characters) NIGHT (black screen/ white characters) or AUTO.

In AUTO mode, the display is in DAY mode until the vehicle's lights are turned on, then the display goes into NIGHT mode. **PLEASE NOTE** – in order for the AUTO function to operate properly, the Orange wire in the WS-MC-20 harness labeled DIM INPUT must be wired to a circuit in the vehicle that gets +12V whenever the main lighting switch is turned on.

**AUX IN / SIRIUSXM** This allows selection between the auxiliary input or SiriusXM input.

**SOFTWARE** Allows access to the software menu of the WS-MC-20:

**VERSION** Displays what version of the operating software is currently running on the MC2.

Visit [www.wetsounds.com/downloads](http://www.wetsounds.com/downloads) to see the most up to date MC2 operating software.

**SPLASH SCREEN** Allows the splash screen to be updated with alternate images of choice via USB input.

**UPDATE** Allows the operating software of the WS-MC-20 to be updated while still installed in the vehicle.

For detailed Software updating instructions, please visit [www.wetsounds.com](http://www.wetsounds.com).

**FACTORY DEFAULT** Selecting this will return all settings of the MC2 back to the original.

**BLUETOOTH** Allows access to the following Bluetooth functions:

**DEVICE LIST** Displays a list of available Bluetooth devices. To connect a Bluetooth compatible device to the WS-MC-20, make sure no other devices are paired to the WS-MC-20, then enable BT on the device. Search on the device's Bluetooth menu for "WS-MC-20" and connect with it. The WS-MC-20 will confirm connection on the display.

**DEVICE NAME** Displays the Bluetooth device name.

**4. MENU** Allows access to functions for each source

**5. SOURCE (SRC)** Allows access to five different sources:

**RADIO OPERATION** Press SOURCE, then select the  symbol for AM, FM, and WB radio. Short Press the |<>| buttons (#10/#11) to automatically seek the next strongest station either up or down. Long press the same buttons to Manually Tune either up or down.

## WS-MC-20 BASIC CONTROLS

6

Press **MENU** while in Radio operation to select between the following features:

**Favorite** Press Favorite to display what stations are set, then rotate the MCK to highlight a selection, then press the MCK to select that station.

**Set Favorite** Allows the manual addition of station presets for each Source. Choose from FM (10 presets), AM (10 Presets); and Weather Band (7 Presets), and Sirius XM (10 Presets).

**AUTO STORE** Will automatically store Presets into the BAND currently being used.

**LOCAL** Select ON/OFF to enable the WS-MC-20 to narrow tuning to local stations only.

**RBDS** Select ON/OFF to enable or disable the Radio Broadcast Data System. Note – not all FM radio stations support RBDS, so availability of this feature may be limited.

**USB OPERATION** Press SRC, then select the  symbol to access the USB input. Please note – if there is nothing plugged into the USB port on the WS-MC-20, this selection will not be possible. The USB port on the WS-MC-202 is capable of both connecting & charging Apple devices & only charging many Android devices. The WS-MC-20 can also read MP3 files via a USB drive.

**PLAY/PAUSE (#6)** Forward/Reverse Track (#10/#11) will operate when in USB mode. Album Art is available for display on compatible MP3 files.

Press **MENU** while in USB operation to select the following features:

**BROWSER** Press this to display all the selections available via the USB input. Rotate the MCK to highlight, the depress the MCK to choose your selection.

**REPEAT** Choose between repeating ONE selection, only the selections in the current FOLDER or ALL selections available.

**SHUFFLE** Choosing between ON/OFF to enable random order play of only the current FOLDER or ALL selections available.

**BLUETOOTH STREAMING OPERATION** Press SRC, then select the  symbol to access the Bluetooth streaming input.

**PLAY/PAUSE** (#7) Forward/Reverse Track (#10/#11) will operate when in Bluetooth mode. Album Art is available for display on compatible devices.

Press **MENU** while in USB operation to select the following features:

**BROWSER** Press this to search for Playlists, Artists, Albums, Genres, Songs, Composers, Audio Books, or Podcasts.

**REPEAT** Choose between repeating ONE selection, or ALL selections available.

**SHUFFLE** Choose between ON/OFF to enable random order play, or ALL selections available.

### **SiriusXM® Operation**

Only SiriusXM® brings you more of what you love to listen to, all in one place. Get over 140 channels, including commercial free music, plus the best sports, news, talk, comedy and entertainment. Welcome to the world of satellite radio. A SiriusXM Connect Tuner and Subscription are required. For more information, visit [www.siriusxm.com](http://www.siriusxm.com)

#### **Activating your SiriusXM Subscription**

After installing your SiriusXM Connect Tuner and antenna, power on your source unit and select SOURCE, then SiriusXM. You should be able to hear the SiriusXM Preview Channel on Channel 1. If you cannot hear the preview channels, please check the installation instructions to make sure your SiriusXM Connect Tuner is properly installed.

After you can hear the Preview channel, tune to Channel 0 to find the RADIO ID of your tuner. In addition, the Radio ID is located on the bottom of the SiriusXM Connect Tuner and its packaging.

You will need this number to activate your subscription. Write down the number for reference.



Note: The SiriusXM Radio ID does not contain the letters I, O, S, or F.

In the USA, you can activate online, or by calling SiriusXM listener care:

- Visit [www.siriusxm.com/activatenow](http://www.siriusxm.com/activatenow)
- Call SiriusXM Listener Care at 1-866-635-2349

For Canadian Subscriptions, please contact:

- Visit [www.siriusxm.ca/activatexm](http://www.siriusxm.ca/activatexm)
- Call XM Customer Care at 1-877-438-9677

As part of the activation process, the SiriusXM satellites will send an activation message to your tuner. When your radio detects that the tuner has received the activation message, your radio will display "Subscription Updated". Once subscribed, you can tune to channels in your subscriptions plan. Note, the activation process usually takes 10 to 15 minutes, but may take up to an hour. Your radio will need to be powered on and receiving the SiriusXM signal to receive the activation message.



### SETTINGS

To access the SiriusXM SETTINGS, short press the MENU when using the SiriusXM source. This will give you access to the settings specific to SiriusXM (SXM>Favorites>Add Favorites>Channels>Category).

### PRESETS

Using this feature allows you to see what Favorites are saved on the unit. Press the Menu button and select FAVORITES list using the MCK.

**ADD FAVORITES**

This feature allows you to save channels to the unit. Press the Menu button and select the ADD FAVORITES option using the MCK. You will need to be on the channel you want to add first. Once selected, use the rotary encoder to select the PRESET number (1-10) you want the channel saved to.

**CHANNEL**

This feature displays a complete listing of channels. Press the Menu button and select the CHANNEL list using the MCK. Once selected, use the rotary encoder to select the CHANNEL.

**CATEGORY**

This feature displays a complete listing of CATEGORY. Press the Menu button and select the CATEGORY list using the MCK. This feature displays a complete listing of CATEGORY. Once selected, use the MCK to select the CATEGORY.

**DIRECT TUNING**

This feature allows you to directly tune to a channel if you already know the channel number. Press the Menu button and select the DIRECT TUNING option using the MCK. Rotate the MCK until you reach the desired numeral and press to enter your selection. Repeat until the channel number is completed.

**PARENTAL CONTROLS**

The Parental Control feature allows you to limit access to any SiriusXM Channels, including those with mature content. Press the Menu button and select the PARENTAL CONTROL. To turn this feature on, select PARENTAL CONTROLS using the MCK. You will be asked to enter a code to activate it. Enter "1111" for your code. Once the code is entered correctly, this will give you access to the PARENTAL CONTROL features (Lock Channels>Change My Code).

**Use the MCK knob to scroll through the options and press to select.**

**LOCK CHANNELS**

This option allows you to select any channel to be locked out for listening. Press the MCK on the LOCK CHANNELS option to select this feature. When attempting to tune to a locked channel, you will need to enter the correct passcode. Use the MCK to enter the passcode. To unlock previously locked channels, press the MCK on the LOCK CHANNELS option and select the channel to unlock.

### CHANGE PASSCODE

Press the MCK to select the CHANGE PASSCODE option in order to change the PARENTAL CONTROL passcode.

First use the MCK to enter the current code then enter the new code.

### SXM DEFAULT RESET

Press SET-UP button and use the MCK to select SYSTEM, FACTORY DEFAULT, RESET SXM and depress the MCK to confirm.

### ALBUM ART

Album art can be displayed for most of the SiriusXM music channels. When album art is not available, the channel logo or the SiriusXM logo will be displayed.

Note-- Compatible with SXV200 or later tuner models. Not all music channels contain album art images.

**AUXILIARY INPUT OPERATION** Press **SOURCE**, then select the  symbol to allow access to the 3.5mm auxiliary input on the WS-MC-20. This can be used to allow connection of a variety of audio sources.

**6. PLAY/PAUSE** This is active when using the Bluetooth Streaming. Press once for pause, once again for play.

**7. BACK** This will revert to the previous screen.

**8. ZONE 2** - Decrease the output sent to the ZONE 2 preamp outputs.

**9. ZONE 2 +** Increase the output sent to the ZONE 2 preamp outputs. Please note – the main volume control will still override final output of Front, Rear & ZONE 2 outputs.

**10. TRACK BACK/RADIO TUNER SEEK DOWN** In Bluetooth mode, this will go back to the previous track. In Radio mode, this will seek out the strongest station in decreasing frequency order.

**11. TRACK FORWARD/TUNER SEEK UP** In Bluetooth mode, this will go forward to the next track. In Radio mode, this will seek out the strongest station in increasing frequency order.

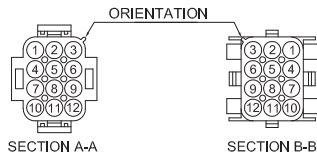

PIN NO.	WIRE COLOR	WIRE DEFINITION	AWG
1	GREEN	SPEAKER REAR LEFT (+)	20
2	GREEN/BLACK	SPEAKER REAR LEFT (-)	20
3	ORANGE/WHITE	ILLUMINATION/DIMMER	20
4	WHITE	SPEAKER FRONT LEFT (+)	20
5	WHITE/BLACK	SPEAKER FRONT LEFT (-)	20
6	RED	ACC (+12V)	16
7	GREY	SPEAKER FRONT RIGHT (+)	20
8	GREY/BLACK	SPEAKER FRONT RIGHT (-)	20
9	BLUE/WHITE	REMOTE (+)	20
10	PURPLE	SPEAKER REAR RIGHT (+)	20
11	PURPLE/BLACK	SPEAKER REAR RIGHT (-)	20
12	BLACK	GROUND (-)	16

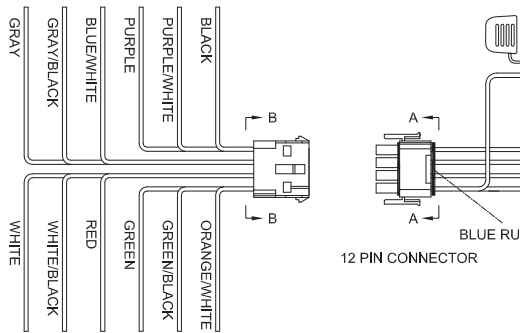
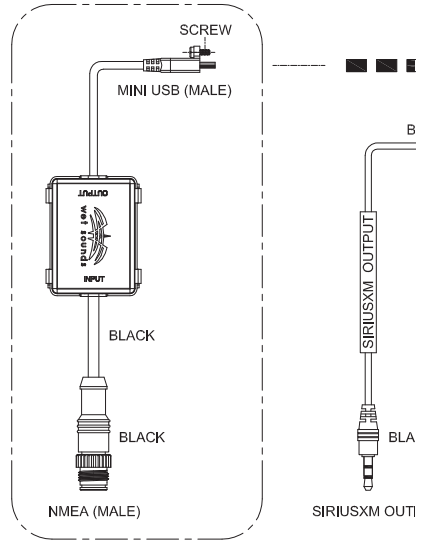

Cancel Prestripped for 12 pin connector harness  
-20190614



Symptom	Diagnosis	Solution
<b>SiriusXM</b>		
“Check Antenna” is displayed	The unit has detected a fault with the SiriusXM antenna. The antenna cable may be either disconnected or damaged.	Verify that the antenna cable is connected to the SiriusXM Connect Tuner. Inspect the antenna cable for damage and kinks. Replace the antenna if the cable is damaged. SiriusXM products are available at your local car audio retailer or online at <a href="http://www.shop.siriusxm.com">www.shop.siriusxm.com</a>
“Check Tuner” is displayed	The radio is having difficulty communicating with the SiriusXM Connect Tuner. The tuner may be disconnected or damaged.	Verify that the SiriusXM Connect Tuner cable is securely connected to the radio
“No Signal” is displayed	The SiriusXM Connect Tuner is having difficulty receiving the SiriusXM satellite signal.	<p>Verify that your vehicle is outdoors with a clear view of the sky.</p> <p>Verify that the SiriusXM magnetic mount antenna is mounted on a metal surface on the outside of the vehicle.</p> <p>Move the SiriusXM antenna away from any obstructions.</p> <p>Inspect the antenna cable for damage and kinks.</p> <p>Consult the SiriusXM Connect Tuner installation manual for more information on antenna installation. Replace the antenna if the cable is damaged.</p> <p>SiriusXM products are available at your local car audio retailer or at <a href="http://www.shop.siriusxm.com">www.shop.siriusxm.com</a></p>

Symptom	Diagnosis	Solution
<b>SiriusXM continued</b>		
“Subscription Updated” is displayed	<p>The radio has detected a change in your SiriusXM subscription status.</p> <p>Press “Enter” to clear the message</p>	<p><b>In the U.S.A.</b> visit <a href="http://www.siriusXM.com">www.siriusXM.com</a> or call 1-866-635-2349 if you have questions about your subscription.</p> <p><b>In Canada</b>, visit <a href="http://www.siriusxm.ca">www.siriusxm.ca</a> or call 1-877-438-9677 if you have questions about your subscription.</p>
“Channel Not Available” is displayed	<p>The channel that you have requested is not a valid SiriusXM channel or the channel that you were listening to is no longer available. You may also see this message briefly when first connecting a new SiriusXM Connect Tuner.</p>	<p>Visit <a href="http://www.siriusxm.com">www.siriusxm.com</a> for more information about the SiriusXM channel lineup.</p>
“Channel Not Subscribed” is displayed	<p>The channel that you have requested is not included in your SiriusXM subscription package or the channel that you were listening to is no longer included in your SiriusXM subscription package.</p>	<p><b>In the U.S.A.</b> visit <a href="http://www.siriusxm.com">www.siriusxm.com</a> or call 1-866-635-2349 if you have questions about your subscription package or if you would like to subscribe to this channel.</p> <p><b>In Canada</b> visit <a href="http://www.siriusxm.ca">www.siriusxm.ca</a> or call 1-877-438-9677.</p>
“Channel Locked” is displayed	<p>The channel you have requested is Locked by the radio Parental Control</p>	<p>See page 9 for more information on the Parental Control feature and how to access locked channels.</p>

SiriusXM and all related marks and logos are trademarks of Sirius XM Radio, Inc. All rights reserved.

The Bluetooth® word mark and logos are registered trademarks owned by Bluetooth SIG, Inc.

iPhone® are registered trademarks of Apple.

**What This Warranty Covers** This is a “limited” warranty. This warranty covers any defect in materials and workmanship. This warranty only covers the original purchaser and is not transferable. This warranty is also only valid if the original purchase was made from an authorized Wet Sounds™ dealer.

**How Long Coverage Lasts** This warranty extends for 2 years from the date of purchase. It is recommended to REGISTER your warranty online within 45 days of purchase at [www.wetsounds.com](http://www.wetsounds.com) – click on “warranty registration”.

**What Is Not Covered** This warranty does not cover fading or discoloration caused by exposure to sunlight or chemicals such as ammonia, household bleach, or any cleaning material that contains abrasive substances. Wet Sounds, Inc. does not cover the expense for removal or re-installation. Additionally, shipping TO Wet Sounds, Inc. must be paid for by the purchaser. This warranty is void and inapplicable if Wet Sounds deems that the product was abused or misused; including but not limited to damage caused by accident, mishandling, improper installation, removing the inline fuse on the power connection, negligence, normal; wear and tear, excessive water or heat damage, freight/shipping damage, or products that have been disassembled by anyone other than Wet Sounds technical staff. Wet Sounds will not be responsible for any incidental or consequential damages, except to the extent provided (or prohibited) by applicable law. This warranty gives you specific rights, and you may also have other rights which vary from state to state.

**What Wet Sounds, Inc. Will Do** Wet Sounds, Inc. will repair any part of your product that proves to be defective in materials or workmanship. In the event repair is not possible, Wet Sounds will replace the product in question. If it is deemed necessary Wet Sounds, Inc. will either replace the entire product with a refurbished unit or it will be replaced with a model that is similar in price if that model is no longer available. Labor costs and materials needed to complete this service will be at No Charge to the purchaser. Additionally, return shipping FROM Wet Sounds, Inc. to the purchaser will be paid for by Wet Sounds.



**How To Get Service** Contact Wet Sounds, Inc. either by phone (877-938-7757) or by email ([warranty@wetsounds.com](mailto:warranty@wetsounds.com)). A service representative will assist you in confirming that the problem you are experiencing is caused by a defective product and if that product is covered under warranty. The service representative will issue you a Return Manufacturer's Authorization (RMA) and other details to obtain service for your product.

**DO NOT RETURN YOUR PRODUCT WITHOUT THE PROPER RETURN AUTHORIZATION (RMA)!**

**Internet Warning** Wet Sounds, Inc. products sold on any non-authorized web site or internet auction site are void of any and all manufacturer's warranty.

**Please contact Wet Sounds** (877-938-7757) or visit our web site ([www.wetsounds.com](http://www.wetsounds.com)) for a list of authorized online sellers or to find an authorized installing retailer near you.



## Federal Communication Commission (FCC) Radiation Exposure Statement

The device has been evaluated to meet general RF exposure requirement, The device can be used in portable exposure condition without restriction

FCC statements:

This device complies with part 15 of the FCC rules. Operation is subject to the following two conditions: (1) this device may not cause harmful interference, and (2) this device must accept any interference received, including interference that may cause undesired operation.

NOTE: The manufacturer is not responsible for any radio or TV interference caused by unauthorized modifications or changes to this equipment. Such modifications or changes could void the user's authority to operate the equipment.

NOTE: This equipment has been tested and found to comply with the limits for a Class B digital device, pursuant to part 15 of the FCC Rules. These limits are designed to provide reasonable protection against harmful interference in a residential installation. This equipment generates uses and can radiate radiofrequency energy and, if not installed and used in accordance with the instructions, may cause harmful interference to radio communications. However, there is no guarantee that interference will not occur in a particular installation. If this equipment does cause harmful interference to radio or television reception, which can be determined by turning the equipment off and on, the user is encouraged to try to correct the interference by one or more of the following measures:

- Reorient or relocate the receiving antenna.
- Increase the separation between the equipment and receiver.
- Connect the equipment into an outlet on a circuit different from that to which the receiver is connected.
- Consult the dealer or an experienced radio/TV technician for help.

ISED:

This device complies with Industry Canada license-exempt RSS standard(s).

Operation is subject to the following two conditions:

- (1) this device may not cause interference, and
  - (2) this device must accept any interference, including interference that may cause undesired operation of the device.
- Cet appareil est conforme avec Industrie Canada RSS exemptes de licence standard(s).

Son fonctionnement est soumis aux deux conditions suivantes:

- (1) cet appareil ne peut pas provoquer d'interférences, et
- (2) cet appareil doit accepter toute interférence, y compris celles pouvant causer un mauvais fonctionnement de l'appareil.

This Class B digital apparatus complies with Canadian ICES-003.  
Cet appareil numérique de la classe B est conforme à la norme NMB-003 du Canada.

#### Radiation Exposure Statement

The product comply with the Canada portable RF exposure limit set forth for an uncontrolled environment and are safe for intended operation as described in this manual. The further RF exposure reduction can be achieved if the product can be kept as far as possible from the user body or set the device to lower output power if such function is available.

#### Déclaration d'exposition aux radiations:

Le produit est conforme aux limites d'exposition pour les appareils portables RF pour les États-Unis et le Canada établies pour un environnement non contrôlé.

Le produit est sûr pour un fonctionnement tel que décrit dans ce manuel. La réduction aux expositions RF peut être augmentée si l'appareil peut être conservé aussi loin que possible du corps de l'utilisateur ou que le dispositif est réglé sur la puissance de sortie la plus faible si une telle fonction est disponible.

This device is operated the frequency bands(s) and the maximum output power (E.I.R.P) :

BT: 2402MHz – 2480MHz : 1.13dBm

AM: 526.5kHz-1606.5kHz Receiver

FM: 87.5MHz-108MHz Receiver

The suitable temperature for the product and accessories is -20~ +70°C.

**CAN ICES-003(B)/NMB-003(B)**



WET SOUNDS INC.  
[www.wetsounds.com](http://www.wetsounds.com)  
877-938-7757

10621 S. Sam Houston PKWY W, Suite 100  
Houston, Texas 77071  
USA

