



FCC TEST REPORT

Test report

On Behalf of

Shanghai 3Core technologies, Inc.

For

reader

Model No.: TCE7110

FCC ID: 2AT8Z-TCE7110

Prepared for: Shanghai 3Core technologies, Inc.
No.7, lane175, Wanhuangdu Road, Jingan District, Shanghai, PR China

Prepared By: Shenzhen HUAKE Testing Technology Co., Ltd.
1F, B2 Building, Junfeng Zhongcheng Zhizao Innovation Park, Fuhai Street,
Bao'an District, Shenzhen City, China

Date of Test: Aug. 06, 2019 ~ Aug. 10, 2019

Date of Report: Aug. 10, 2019

Report Number: HK1908081955-2E



TEST RESULT CERTIFICATION

Applicant's name : Shanghai 3Core technologies, Inc.
 No.7, lane175, Wanhuangdu Road, Jingan District, Shanghai, PR
Address : China

Manufacture's Name..... : Shanghai 3Core technologies, Inc.
 No.7, lane175, Wanhuangdu Road, Jingan District, Shanghai, PR
Address : China

Product description

Trade Mark: 3CORE
Product name : reader
Model and/or type reference : TCE7110

Standards : FCC Rules and Regulations Part 15 Subpart C Section 15.249
 ANSI C63.10: 2013

This publication may be reproduced in whole or in part for non-commercial purposes as long as the Shenzhen HUAKE Testing Technology Co., Ltd. is acknowledged as copyright owner and source of the material. Shenzhen HUAKE Testing Technology Co., Ltd. takes no responsibility for and will not assume liability for damages resulting from the reader's interpretation of the reproduced material due to its placement and context.

Date of Test :
Date (s) of performance of tests : Aug. 06, 2019~ Aug. 10, 2019
Date of Issue..... : Aug. 10, 2019
Test Result..... : **Pass**

Testing Engineer : Gary Qian
 (Gary Qian)

Technical Manager : Eden Hu
 (Eden Hu)

Authorized Signatory : Jason Zhou
 (Jason Zhou)



Table of Contents	Page
1 . TEST SUMMARY	4
2 . GENERAL INFORMATION	5
2.1 GENERAL DESCRIPTION OF EUT	5
2.2 Carrier Frequency of Channels	6
2.3 Operation of EUT during testing	6
2.4 DESCRIPTION OF TEST SETUP	6
2.5 MEASUREMENT INSTRUMENTS LIST	7
3 . CONDUCTED EMISSIONS TEST	8
3.1 Conducted Power Line Emission Limit	8
3.2 Test Setup	8
3.3 Test Procedure	8
3.4 Test Result	8
4 RADIATED EMISSION TEST	9
4.1 Radiation Limit	9
4.2 Test Setup	9
4.3 Test Procedure	10
4.4 Test Result	10
5 BAND EDGE	16
5.1 Limits	16
5.2 Test Procedure	16
5.3 Test Result	16
6 OCCUPIED BANDWIDTH MEASUREMENT	18
6.1 Test Setup	18
6.2 Test Procedure	18
6.3 Measurement Equipment Used	18
6.4 Test Result	18
7 ANTENNA REQUIREMENT	20
8 PHOTOGRAPH OF TEST	21
Radiated Emission	21
Conducted Emission	错误!未定义书签。



1. TEST SUMMARY

1.1 TEST PROCEDURES AND RESULTS

DESCRIPTION OF TEST		RESULT
15.207	Conducted Emission	COMPLIANT
15.249&15.209	Fundamental & Radiated Spurious Emission Measurement	COMPLIANT
15.215	Bandwidth	COMPLIANT
15.205	Band Edge Emission	COMPLIANT
15.203	Antenna Requirement	COMPLIANT

1.2 TEST FACILITY

Test Firm : Shenzhen HUAKE Testing Technology Co., Ltd.

Address : 1F, B2 Building, Junfeng Zhongcheng Zhizao Innovation Park, Fuhai Street, Bao'an District, Shenzhen City, China

1.3 MEASUREMENT UNCERTAINTY

Measurement Uncertainty

Conducted Emission Expanded Uncertainty = 2.23dB, k=2

Radiated emission expanded uncertainty(9kHz-30MHz) = 3.08dB, k=2

Radiated emission expanded uncertainty(30MHz-1000MHz) = 4.42dB, k=2

Radiated emission expanded uncertainty(Above 1GHz) = 4.06dB, k=2



2. GENERAL INFORMATION

2.1 GENERAL DESCRIPTION OF EUT

Equipment	reader
Model Name	TCE7110
Serial No.	N/A
Trade Mark	3CORE
Model Difference	N/A
FCC ID	2AT8Z-TCE7110
Antenna Type	PCB Antenna
Antenna Gain	1dBi
BT Operation frequency	2402-2480MHz
Number of Channels	40CH
Modulation Type	GFSK
Battery	DC 12V
Power Source	DC 12V from DC storage battery



2.2 Carrier Frequency of Channels

Channel List							
Channel	Frequency (MHz)	Channel	Frequency (MHz)	Channel	Frequency (MHz)	Channel	Frequency (MHz)
0	2402	10	2422	20	2442	30	2462
1	2404	11	2424	21	2444	31	2464
2	2406	12	2426	22	2446	32	2466
3	2408	13	2428	23	2448	33	2468
4	2410	14	2430	24	2450	34	2470
5	2412	15	2432	25	2452	35	2472
6	2414	16	2434	26	2454	36	2474
7	2416	17	2436	27	2456	37	2476
8	2418	18	2438	28	2458	38	2478
9	2420	19	2440	29	2460	39	2480

2.3 Operation of EUT during testing

Operating Mode

The mode is used: **Transmitting mode**

Low Channel: 2402MHz

Middle Channel: 2440MHz

High Channel: 2480MHz

2.4 DESCRIPTION OF TEST SETUP

Operation of EUT during Conducted testing:

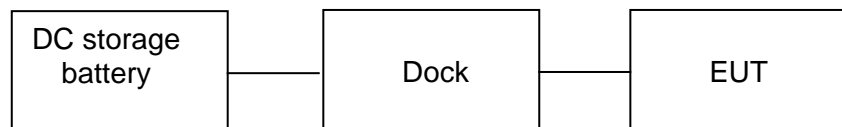

Note: Dock is only a connector, there is no extra circuit.

Operation of EUT during Radiation and Above1GHz Radiation testing:





2.5 MEASUREMENT INSTRUMENTS LIST

Item	Equipment	Manufacturer	Model No.	Serial No.	Last Cal.	Cal. Interval
1.	L.I.S.N. Artificial Mains Network	R&S	ENV216	HKE-002	Dec. 28, 2018	1 Year
2.	Receiver	R&S	ESCI 7	HKE-010	Dec. 28, 2018	1 Year
3.	RF automatic control unit	Tonscend	JS0806-2	HKE-060	Dec. 28, 2018	1 Year
4.	Spectrum analyzer	R&S	FSP40	HKE-025	Dec. 28, 2018	1 Year
5.	Spectrum analyzer	Agilent	N9020A	HKE-048	Dec. 28, 2018	1 Year
6.	Preamplifier	Schwarzbeck	BBV 9743	HKE-006	Dec. 28, 2018	1 Year
7.	EMI Test Receiver	Rohde & Schwarz	ESCI 7	HKE-010	Dec. 28, 2018	1 Year
8.	Bilog Broadband Antenna	Schwarzbeck	VULB9163	HKE-012	Dec. 28, 2018	1 Year
9.	Loop Antenna	Schwarzbeck	FMZB 1519 B	HKE-014	Dec. 28, 2018	1 Year
10.	Horn Antenna	Schwarzbeck	9120D	HKE-013	Dec. 28, 2018	1 Year
11.	Pre-amplifier	EMCI	EMC051845 SE	HKE-015	Dec. 28, 2018	1 Year
12.	Pre-amplifier	Agilent	83051A	HKE-016	Dec. 28, 2018	1 Year
13.	EMI Test Software EZ-EMC	Tonscend	JZOZtheBO T120-B Version	HKE-083	N/A	N/A
14.	Power Sensor	Agilent	E9300A	HKE-086	Dec. 28, 2018	1 Year
15.	Spectrum analyzer	Agilent	N9020A	HKE-048	Dec. 28, 2018	1 Year
16.	Signal generator	Agilent	N5182A	HKE-029	Dec. 28, 2018	1 Year
17.	Signal Generator	Agilent	83630A	HKE-028	Dec. 28, 2018	1 Year
18.	Shielded room	Shiel Hong	4*3*3	HKE-039	Dec. 28, 2017	3 Year
19.	Hf antenna	Schwarzbeck	LB-180400- KF	HKE-031	Dec. 28, 2018	1 Year



3. CONDUCTED EMISSIONS TEST

3.1 Conducted Power Line Emission Limit

For unintentional device, according to § 15.107(a) Line Conducted Emission Limits is as following

Frequency (MHz)	Maximum RF Line Voltage (dB μ V)			
	CLASS A		CLASS B	
	Q.P.	Ave.	Q.P.	Ave.
0.15 - 0.50	79	66	66-56*	56-46*
0.50 - 5.00	73	60	56	46
5.00 - 30.0	73	60	60	50

* Decreasing linearly with the logarithm of the frequency

For intentional device, according to §15.207(a) Line Conducted Emission Limit is same as above table.

3.2 Test Setup

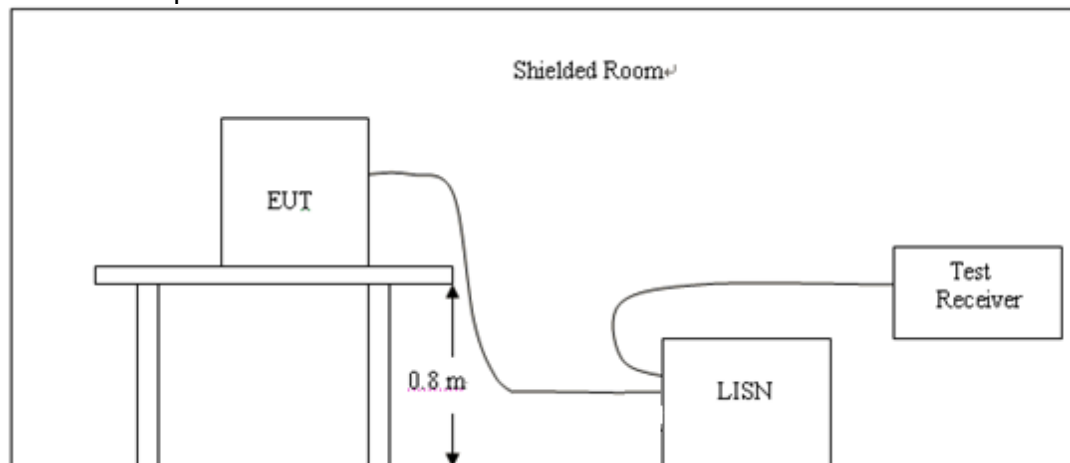

3.3 Test Procedure

- 1, The equipment was set up as per the test configuration to simulate typical actual usage per the user's manual. The EUT is a tabletop system, a wooden table with a height of 0.8 meters is used and is placed on the ground plane as per ANSI C63.10.
- 2, Support equipment, if needed, was placed as per ANSI C63.10.
- 3, All I/O cables were positioned to simulate typical actual usage as per ANSI C63.10.
- 4, If a EUT received DC power from the USB Port of Notebook PC, the PC's adapter received AC120V/60Hz power through a Line Impedance Stabilization Network (LISN) which supplied power source and was grounded to the ground plane.
- 5, All support equipments received AC power from a second LISN, if any.
- 6, The EUT test program was started. Emissions were measured on each current carrying line of the EUT using a spectrum Analyzer / Receiver connected to the LISN powering the EUT. The LISN has two monitoring points: Line 1 (Hot Side) and Line 2 (Neutral Side). Two scans were taken: one with Line 1 connected to Analyzer / Receiver and Line 2 connected to a 50 ohm load; the second scan had Line 1 connected to a 50 ohm load and Line 2 connected to the Analyzer / Receiver.
- 7, Analyzer / Receiver scanned from 150 KHz to 30MHz for emissions in each of the test modes.

3.4 Test Result

The power supply of EUT is DC 12V, so it is not applicable.

4 RADIATED EMISSION TEST

4.1 Radiation Limit

For unintentional device, according to § 15.109(a), except for Class B digital devices, the field strength of radiated emissions from unintentional radiators at a distance of 3 meters shall not exceed the following values:

Frequency (MHz)	Distance (Meters)	Radiated (dB μ V/m)	Radiated (μ V/m)
30-88	3	40	100
88-216	3	43.5	150
216-960	3	46	200
Above 960	3	54	500

For intentional device, according to § 15.209(a), the general requirement of field strength of radiated emissions from intentional radiators at a distance of 3 meters shall not exceed the above table.

4.2 Test Setup

(1) Radiated Emission Test-Up Frequency Below 30MHz

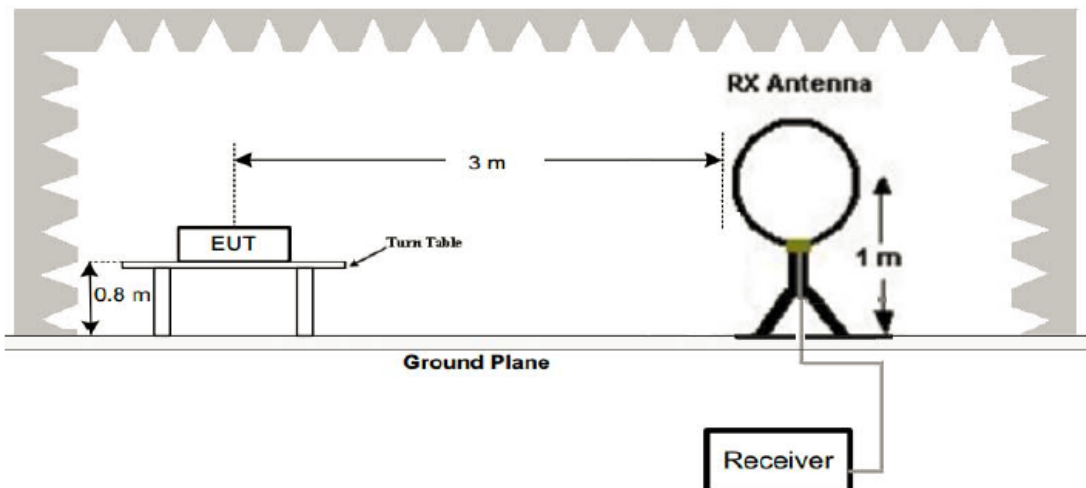

(2) Radiated Emission Test-Up Frequency 30MHz~1GHz

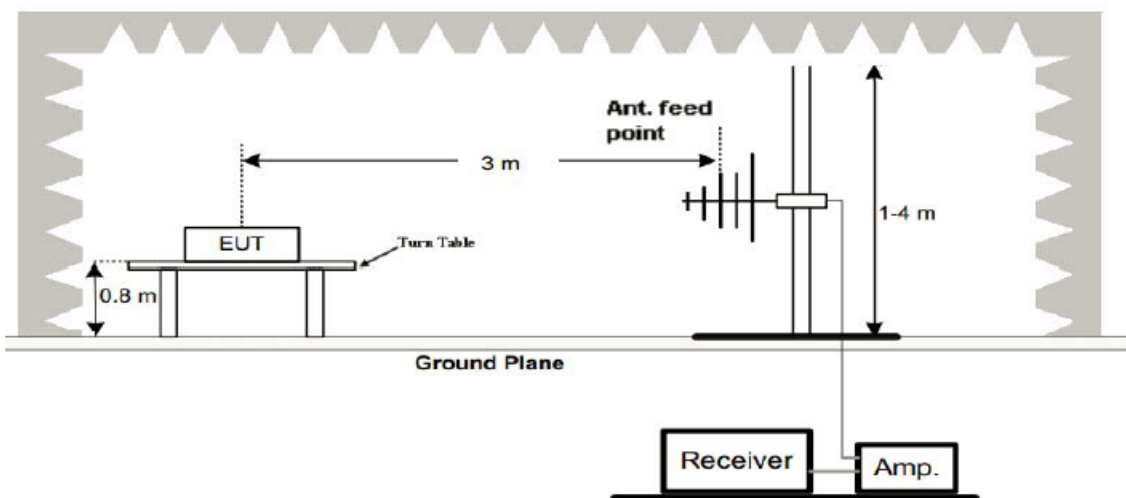

(3) Radiated Emission Test-Up Frequency Above 1GHz

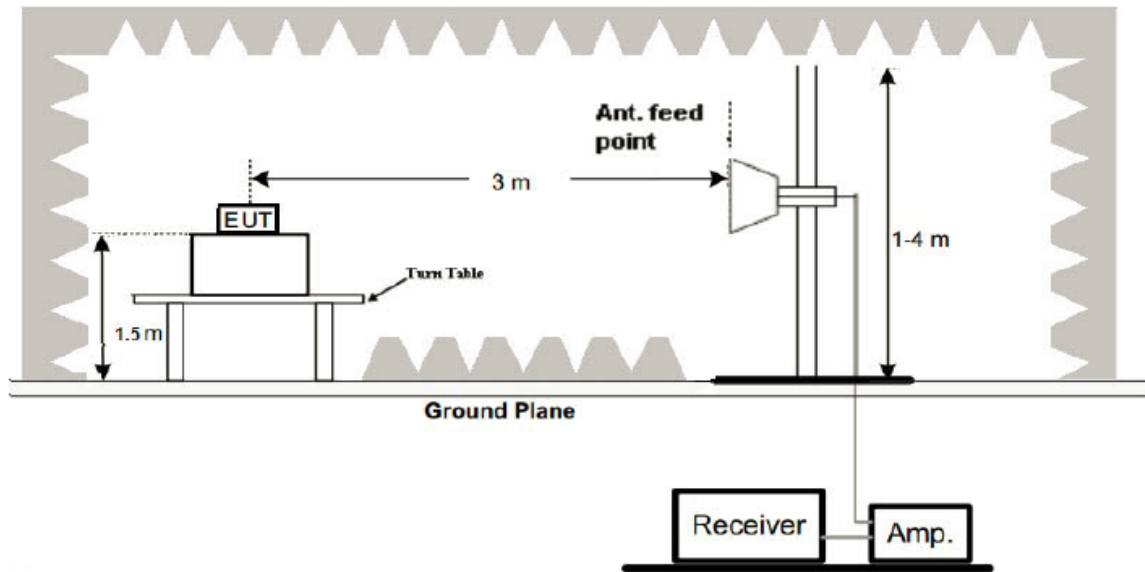

4.3 Test Procedure

1. Below 1GHz measurement the EUT is placed on turntable which is 0.8m above ground plane. And above 1GHz measurement EUT was placed on low permittivity and low tangent turn table which is 1.5m above ground plane.
2. The turntable shall be rotated for 360 degrees to determine the position of maximum emission level.
3. EUT is set 3m away from the receiving antenna, which is varied from 1m to 4m to find out the highest emissions.
4. Maximum procedure was performed on the six highest emissions to ensure EUT compliance.
5. And also, each emission was to be maximized by changing the polarization of receiving antenna both horizontal and vertical.
6. Repeat above procedures until the measurements for all frequencies are complete.
7. The test frequency range from 9KHz to 25GHz per FCC PART 15.33(a).

Note:

For battery operated equipment, the equipment tests shall be performed using a new battery.

4.4 Test Result

PASS

Remark:

1. All the test modes completed for test. The worst case of Radiated Emission is Low channel, the test data of this mode was reported.
2. By preliminary testing and verifying three axis (X, Y and Z) position of EUT transmitted status, it was found that "Z axis" position was the worst, and test data recorded in this report.
3. Radiated emission test from 9KHz to 10th harmonic of fundamental was verified, and no emission found except system noise floor in 9KHz to 30MHz and not recorded in this report.



Below 1GHz Test Results:

Antenna polarity: H

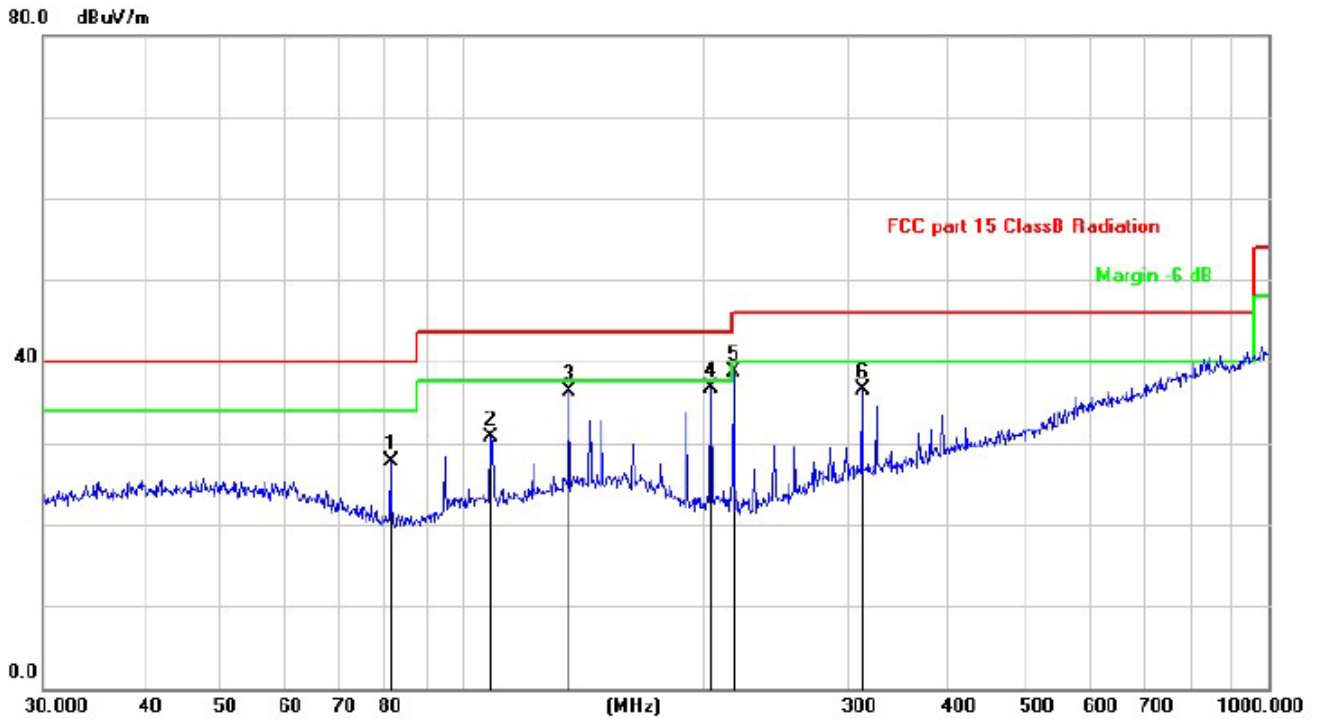

No.	Mk.	Freq.	Reading	Correct	Measurement	Limit	Over	Antenna	Table	
		MHz	Level	Factor	dBuV/m	dB/m	dB	Height	Degree	Comment
			dBuV	dB				cm	degree	
1		81.2117	38.68	-10.92	27.76	40.00	-12.24	101	132	
2		108.2667	40.02	-9.38	30.64	43.50	-12.86	103	142	
3		135.5062	43.44	-7.15	36.29	43.50	-7.21	114	32	
4	*	203.5228	46.23	-9.56	36.67	43.50	-6.83	120	24	
5		216.7828	48.49	-9.72	38.77	46.00	-7.23	113	25	
6		312.1794	41.50	-5.03	36.47	46.00	-9.53	100	53	

Remark: Factor= Cableloss + Antenna factor - Pre-amplifier; Margin = Limit – Level



Antenna polarity: V

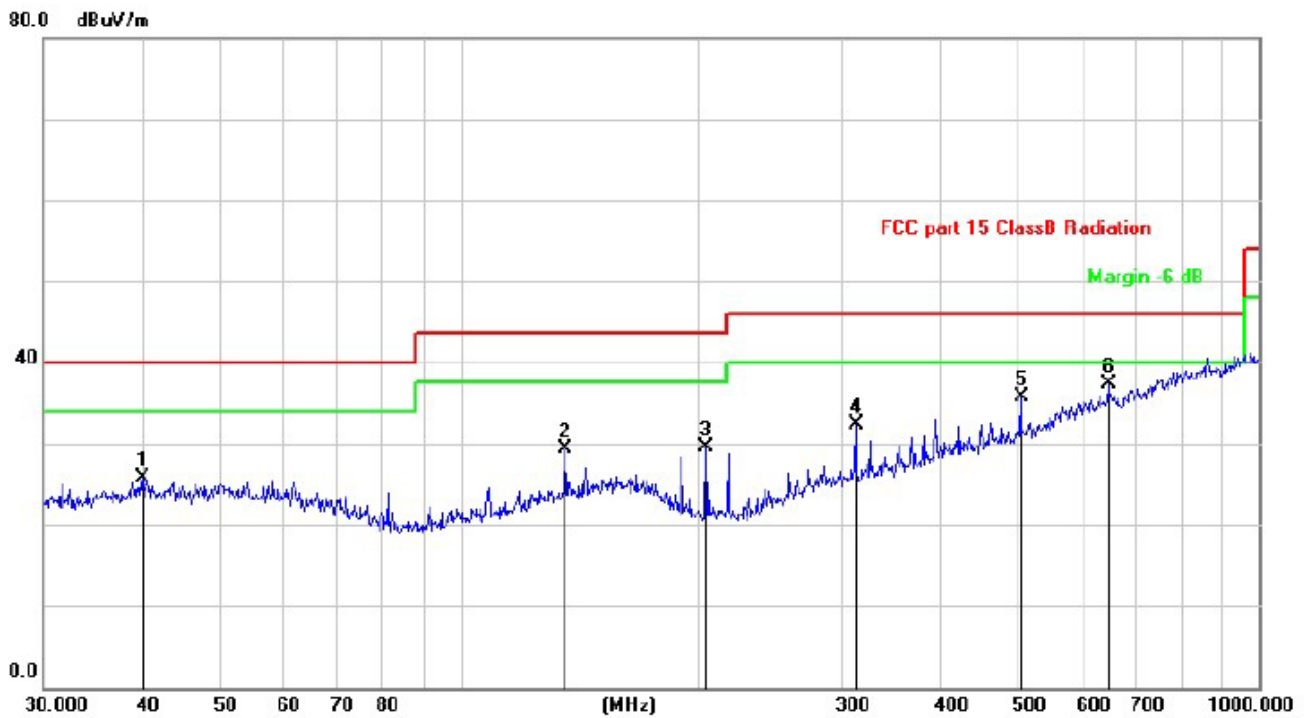

No.	Mk.	Freq. MHz	Reading Level dBuV	Correct Factor dB	Measure- ment dBuV/m	Limit dB/m	Over dB	Antenna Height cm	Table Degree	Comment
1		39.9942	32.20	-6.43	25.77	40.00	-14.23	peak	100	123
2		135.5062	36.42	-7.15	29.27	43.50	-14.23	peak	100	220
3		203.5228	39.11	-9.56	29.55	43.50	-13.95	peak	123	34
4		312.1794	37.37	-5.03	32.34	46.00	-13.66	peak	115	356
5		502.9395	36.06	-0.26	35.80	46.00	-10.20	peak	105	253
6	*	647.3856	33.72	3.64	37.36	46.00	-8.64	peak	108	113

Remark: Factor = Cableloss + Antenna factor - Pre-amplifier; Margin = Limit – Level

Remark:

- (1) Measuring frequencies from 9 KHz to the 1 GHz, radiated emission test from 9KHz to 30MHz was verified, and no any emission was found except system noise floor.
- (2) * denotes emission frequency which appearing within the Restricted Bands specified in provision of 15.205, then the general radiated emission limits in 15.209 apply.
- (3) The IF bandwidth of EMI Test Receiver between 30MHz to 1GHz was 120KHz, 1 MHz for measuring above 1 GHz, below 30MHz was 10KHz.



Above 1 GHz Test Results:
CH Low (2402MHz)

Horizontal:

Frequency	Meter Reading	Factor	Emission Level	Limits	Margin	Detector Type
(MHz)	(dB μ V)	(dB)	(dB μ V/m)	(dB μ V/m)	(dB)	
2402	108.88	-5.84	103.04	114	-10.96	peak
2402	95.74	-5.84	89.90	94	-4.10	AVG
4804	56.52	-3.64	52.88	74	-21.12	peak
4804	47.74	-3.64	44.10	54	-9.90	AVG
7206	58.75	-0.95	57.80	74	-16.20	peak
7206	48.28	-0.95	47.33	54	-6.67	AVG

Remark: Factor = Antenna Factor + Cable Loss – Pre-amplifier. Emission level = Reading Result + Factor, Margin = Emission level - Limits

Vertical:

Frequency	Meter Reading	Factor	Emission Level	Limits	Margin	Detector Type
(MHz)	(dB μ V)	(dB)	(dB μ V/m)	(dB μ V/m)	(dB)	
2402	108.35	-5.84	102.51	114	-11.49	peak
2402	95.52	-5.84	89.68	94	-4.32	AVG
4804	56.32	-3.64	52.68	74	-21.32	peak
4804	47.04	-3.64	43.40	54	-10.60	AVG
7206	58.22	-0.95	57.27	74	-16.73	peak
7206	48.14	-0.95	47.19	54	-6.81	AVG

Remark: Factor = Antenna Factor + Cable Loss – Pre-amplifier. Emission level = Reading Result + Factor, Margin = Emission level - Limits



CH Middle (2440MHz)

Horizontal:

Frequency	Meter Reading	Factor	Emission Level	Limits	Margin	Detector Type
(MHz)	(dB μ V)	(dB)	(dB μ V/m)	(dB μ V/m)	(dB)	
2440	108.21	-5.71	102.50	114	-11.50	peak
2440	93.17	-5.71	87.46	94	-6.54	AVG
4880	56.09	-3.51	52.58	74	-21.42	peak
4880	46.87	-3.51	43.36	54	-10.64	AVG
7320	57.85	-0.82	57.03	74	-16.97	peak
7320	47.75	-0.82	46.93	54	-7.07	AVG

Remark: Factor = Antenna Factor + Cable Loss – Pre-amplifier. Emission level = Reading Result + Factor, Margin = Emission level - Limits

Vertical:

Frequency	Meter Reading	Factor	Emission Level	Limits	Margin	Detector Type
(MHz)	(dB μ V)	(dB)	(dB μ V/m)	(dB μ V/m)	(dB)	
2440	108.01	-5.71	102.30	114	-11.70	peak
2440	93.16	-5.71	87.45	94	-6.55	AVG
4880	56.02	-3.51	52.51	74	-21.49	peak
4880	46.83	-3.51	43.32	54	-10.68	AVG
7320	57.93	-0.82	57.11	74	-16.89	peak
7320	47.73	-0.82	46.91	54	-7.09	AVG

Remark: Factor = Antenna Factor + Cable Loss – Pre-amplifier. Emission level = Reading Result + Factor, Margin = Emission level - Limits



CH High (2480MHz)

Horizontal:

Frequency	Meter Reading	Factor	Emission Level	Limits	Margin	Detector Type
(MHz)	(dB μ V)	(dB)	(dB μ V/m)	(dB μ V/m)	(dB)	
2480	108.27	-5.65	102.62	114	-11.38	peak
2480	93.15	-5.65	87.50	94	-6.50	AVG
4960	56.13	-3.43	52.70	74	-21.30	peak
4960	47.32	-3.43	43.89	54	-10.11	AVG
7440	57.26	-0.75	56.51	74	-17.49	peak
7440	47.57	-0.75	46.82	54	-7.18	AVG

Remark: Factor = Antenna Factor + Cable Loss – Pre-amplifier. Emission level = Reading Result + Factor, Margin = Emission level - Limits

Vertical:

Frequency	Meter Reading	Factor	Emission Level	Limits	Margin	Detector Type
(MHz)	(dB μ V)	(dB)	(dB μ V/m)	(dB μ V/m)	(dB)	
2480	107.24	-5.65	101.59	114	-12.41	peak
2480	92.64	-5.65	86.99	94	-7.01	AVG
4960	56.06	-3.43	52.63	74	-21.37	peak
4960	47.50	-3.43	44.07	54	-9.93	AVG
7440	56.98	-0.75	56.23	74	-17.77	peak
7440	47.40	-0.75	46.65	54	-7.35	AVG

Remark: Factor = Antenna Factor + Cable Loss – Pre-amplifier. Emission level = Reading Result + Factor, Margin = Emission level - Limits

Remark :

- (1) Measuring frequencies from 1 GHz to the 25 GHz.
- (2) "F" denotes fundamental frequency; "H" denotes spurious frequency. "E" denotes band edge frequency.
- (3) * denotes emission frequency which appearing within the Restricted Bands specified in provision of 15.205, then the general radiated emission limits in 15.209 apply.
- (4) Data of measurement within this frequency range shown "---" in the table above means the reading of emissions are attenuated more than 20dB below the permissible limits or the field strength is too small to be measured.
- (5) The IF bandwidth of EMI Test Receiver between 30MHz to 1GHz was 120KHz, 1 MHz for measuring above 1 GHz, below 30MHz was 10KHz. The resolution bandwidth of test receiver/spectrum analyzer is 1MHz and video bandwidth is 3MHz for peak measurement with peak detector at frequency above 1GHz. The resolution bandwidth of test receiver/spectrum analyzer is 1MHz and video bandwidth is 10Hz for Average measurement with peak detection at frequency above 1GHz.
- (6) When the test results of Peak Detected below the limits of Average Detected, the Average Detected is not need completed. For example: Top Channel at Fundamental 73.16dBuV/m(PK Value) <93.98(AV Limit), at harmonic 53.20 dBuV/m(PK Value) <54 dBuV/m(AV Limit), the Average Detected not need to completed.
- (7) RBW > 20dB BW, VBW>=3XRBW, PK detector for PK value, RMS detector for AV value
- (8) All modes of operation were investigated and the worst-case emissions are reported.



5 BAND EDGE

5.1 Limits

FCC PART 15.249(d) Emissions radiated outside of the specified frequency bands, except for harmonics, shall be attenuated by at least 50 dB below the level of the fundamental or to the general radiated emission limits in §15.209, whichever is the lesser attenuation.

5.2 Test Procedure

The band edge compliance of RF radiated emission should be measured by following the guidance in ANSI C63.10 with respect to maximizing the emission by rotating the EUT, measuring the emission while the EUT is situated in three orthogonal planes (if appropriate), adjusting the measurement antenna height and polarization etc. RBW 1MHz VBW 3MHz PK detector is for PK value, RBW 1MHz VBW 10Hz PK detector is for AV value. The conducted RF band edge was measured by using a spectrum analyzer. Set span wide enough to capture the highest in-band emission and the emission at the band edge. Set RBW to 100 KHz and VBW to 300 KHz, to measure the conducted peak band edge.

5.3 Test Result

PASS

Radiated Band Edge Test:

Operation Mode: TX CH Low (2402MHz)

Horizontal (Worst case)

Frequency (MHz)	Meter Reading (dBμV)	Factor (dB)	Emission Level (dBμV/m)	Limits (dBμV/m)	Margin (dB)	Detector Type
2310	55.56	-5.81	49.75	74	-24.25	peak
2310	/	-5.81	/	54	/	AVG
2390	53.95	-5.84	48.11	74	-25.89	peak
2390	/	-5.84	/	54	/	AVG
2400	53.69	-5.84	47.85	74	-26.15	peak
2400	/	-5.84	/	54	/	AVG

Remark: Factor = Antenna Factor + Cable Loss – Pre-amplifier. Emission level = Reading Result + Factor, Margin = Emission level - Limits

Vertical:

Frequency (MHz)	Meter Reading (dBμV)	Factor (dB)	Emission Level (dBμV/m)	Limits (dBμV/m)	Margin (dB)	Detector Type
2310	54.99	-5.81	49.18	74	-24.82	peak
2310	/	-5.81	/	54	/	AVG
2390	53.48	-5.84	47.64	74	-26.36	peak
2390	/	-5.84	/	54	/	AVG
2400	52.95	-5.84	47.11	74	-26.89	peak
2400	/	-5.84	/	54	/	AVG

Remark: Factor = Antenna Factor + Cable Loss – Pre-amplifier. Emission level = Reading Result + Factor, Margin = Emission level - Limits



Operation Mode: TX CH High (2480MHz)

Horizontal (Worst case)

Frequency (MHz)	Reading Result (dB μ V)	Factor (dB)	Emission Level (dB μ V/m)	Limits (dB μ V/m)	Margin (dB)	Detector Type
2483.50	56.12	-5.65	50.47	74	-23.53	peak
2483.50	/	-5.65	/	54	/	AVG
2500.00	54.25	-5.65	48.6	74	-25.4	peak
2500.00	/	-5.65	/	54	/	AVG

Remark: Factor = Antenna Factor + Cable Loss – Pre-amplifier. Emission level = Reading Result + Factor,
Margin = Emission level - Limits

Vertical:

Frequency (MHz)	Reading Result (dB μ V)	Factor (dB)	Emission Level (dB μ V/m)	Limits (dB μ V/m)	Margin (dB)	Detector Type
2483.50	54.26	-5.65	48.61	74	-25.39	peak
2483.50	/	-5.65	/	54	/	AVG
2500.00	52.87	-5.65	47.22	74	-26.78	peak
2500.00	/	-5.65	/	54	/	AVG

Remark: Factor = Antenna Factor + Cable Loss – Pre-amplifier. Emission level = Reading Result + Factor,
Margin = Emission level - Limits

Remark: All the other emissions not reported were too low to read and deemed to comply with FCC limit.



6 OCCUPIED BANDWIDTH MEASUREMENT

6.1 Test Setup

Same as Radiated Emission Measurement

6.2 Test Procedure

1. The EUT was placed on a turn table which is 0.8m above ground plane.
2. Set EUT as normal operation.
3. Based on ANSI C63.10 section 6.9.2: RBW= 30KHz. VBW= 91 KHz, Span=2MHz.
4. The useful radiated emission from the EUT was detected by the spectrum analyser with peak detector.

6.3 Measurement Equipment Used

Same as Radiated Emission Measurement

6.4 Test Result

PASS

Frequency	20dB Bandwidth (MHz)	Result
2402 MHz	1.1092	PASS
2440 MHz	1.1129	PASS
2480 MHz	1.1139	PASS

CH: 2402MHz

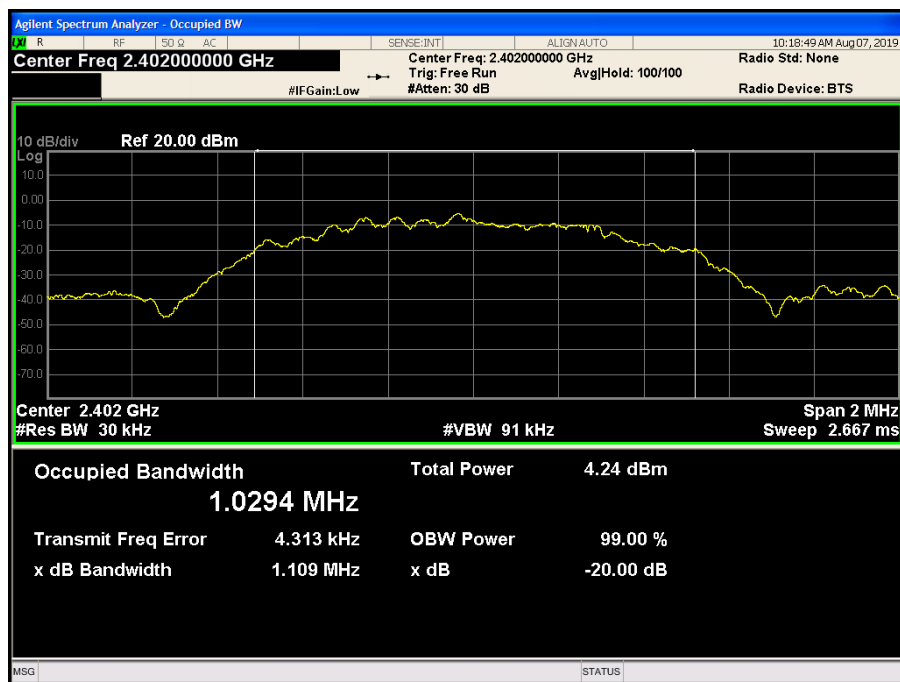



CH: 2440MHz

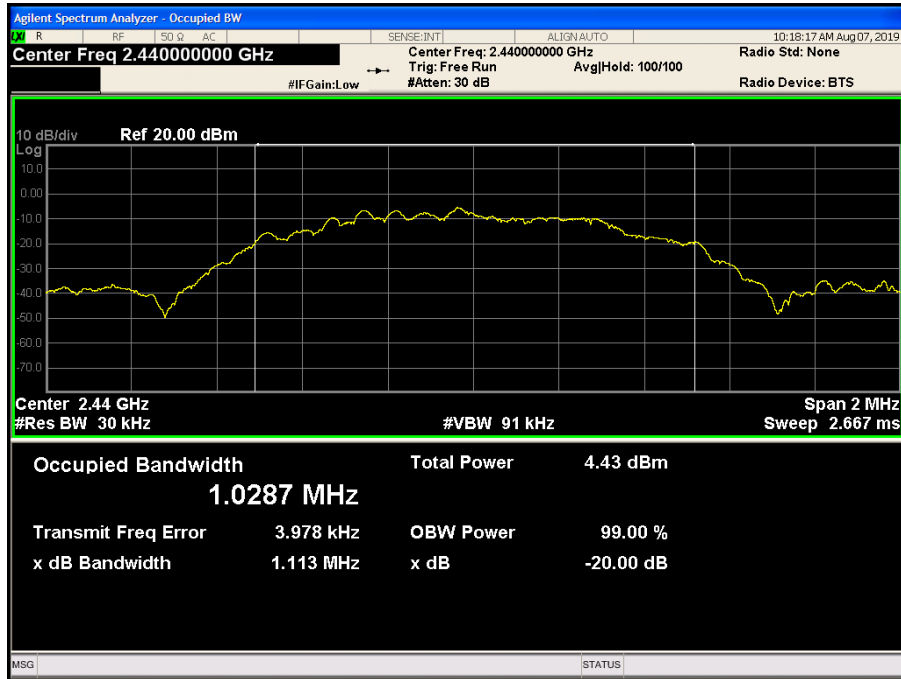

CH: 2480MHz

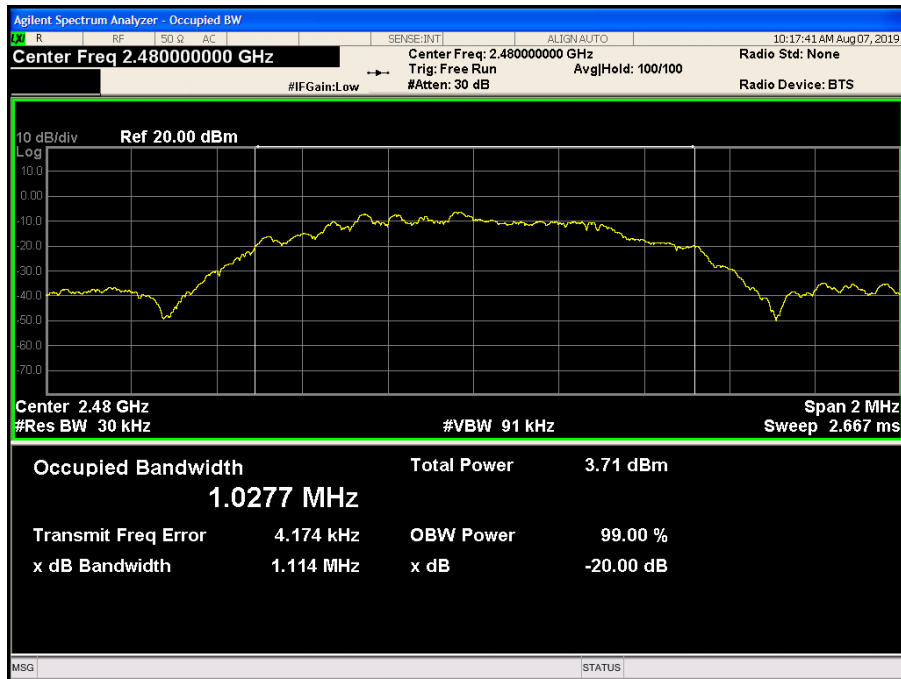

7 ANTENNA REQUIREMENT

Standard Applicable

For intentional device, according to FCC 47 CFR Section 15.203, an intentional radiator shall be designed to ensure that no antenna other than that furnished by the responsible party shall be used with the device. And according to FCC 47 CFR Section 15.249, if transmitting antennas of directional gain greater than 6dBi are used, the power shall be reduced by the amount in dB that the directional gain of the antenna exceeds 6dBi.

Antenna Connected Construction

The antenna used in this product is PCB Antenna, the directional gains of antenna used for transmitting is 1dBi.

BT ANTENNA

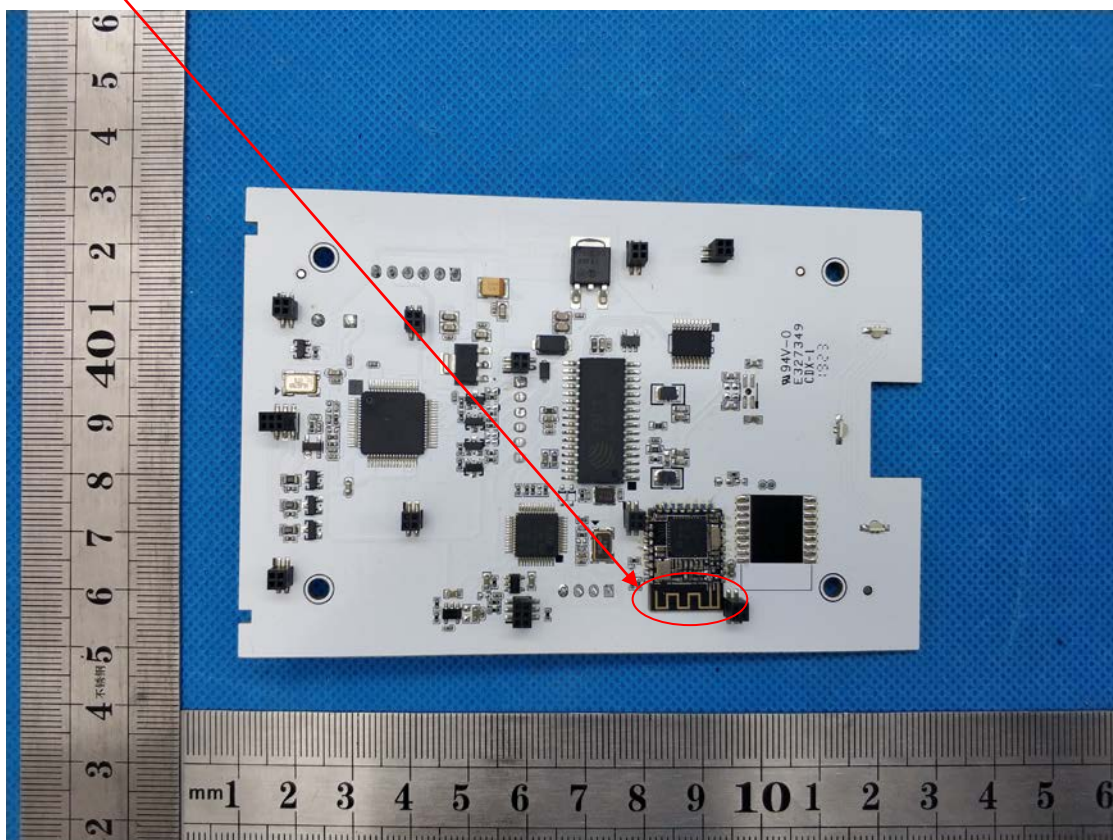

8 PHOTOGRAPH OF TEST

Radiated Emission

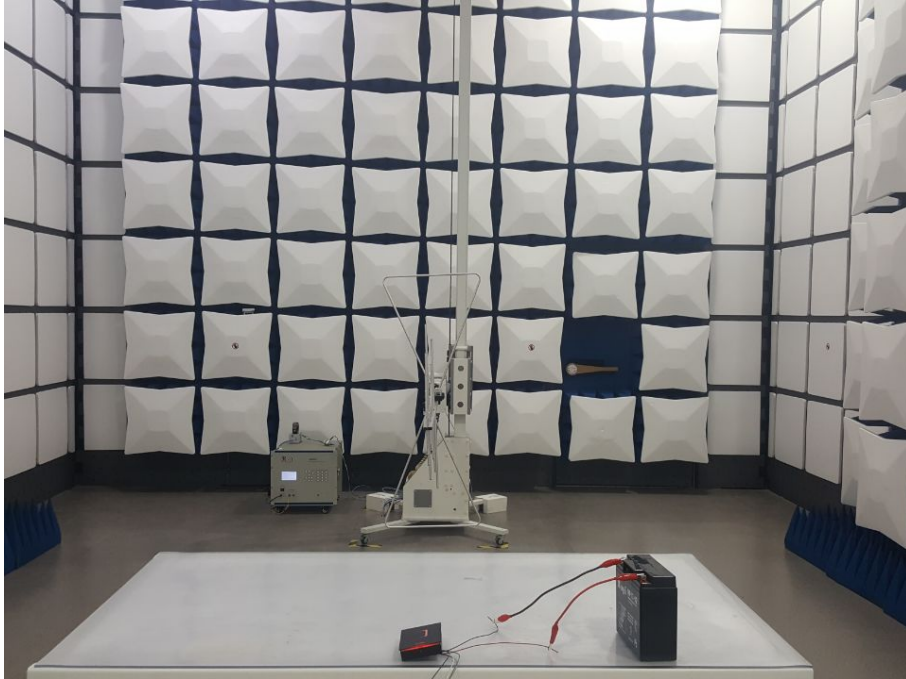

End of Report