



TEST REPORT

Report No. : **CHTEW20040047** Report Verification: 

Project No...... : **SHT1906037411EW**

FCC ID..... : **2AT8M-AN-S4-V3X0**

Applicant's name..... : **Ackcio Pte. Ltd.**

Address..... : 75 Ayer Rajah Crescent #03-01/02 Singapore 139953

Manufacturer..... : Ackcio Pte. Ltd.

Address..... : 75 Ayer Rajah Crescent #03-01/02 Singapore 139953

Test item description : **BEAM-AN-S4**

Trade Mark : -

Model/Type reference..... : BEAM-AN-S4

Listed Model(s) : -

Standard : **FCC CFR Title 47 Part 15 Subpart C Section 15.247**

Date of receipt of test sample..... : Mar.19, 2020

Date of testing..... : Mar.19, 2020- Apr.07, 2020

Date of issue..... : Apr.08, 2020

Result..... : **PASS**

Compiled by
 (Position+Printed name+Signature): File administrator Echo Wei

Supervised by
 (Position+Printed name+Signature): Project Engineer Kiki Kong

Approved by
 (Position+Printed name+Signature): RF Manager Hans Hu

Echo Wei

Kiki Kong

Hans Hu

Testing Laboratory Name : **Shenzhen Huatongwei International Inspection Co., Ltd.**

Address..... : 1/F, Bldg 3, Hongfa Hi-tech Industrial Park, Genyu Road, Tianliao, Gongming, Shenzhen, China

Shenzhen Huatongwei International Inspection Co., Ltd. All rights reserved.

This publication may be reproduced in whole or in part for non-commercial purposes as long as the Shenzhen Huatongwei International Inspection Co., Ltd. is acknowledged as copyright owner and source of the material. Shenzhen Huatongwei International Inspection Co., Ltd. takes no responsibility for and will not assume liability for damages resulting from the reader's interpretation of the reproduced material due to its placement and context. The test report merely correspond to the test sample.

Contents

1.	<u>TEST STANDARDS AND REPORT VERSION</u>	3
1.1.	Test Standards	3
1.2.	Report version	3
2.	<u>TEST DESCRIPTION</u>	4
3.	<u>SUMMARY</u>	5
3.1.	Client Information	5
3.2.	Product Description	5
3.3.	Radio Specification Description	5
3.4.	Testing Laboratory Information	6
4.	<u>TEST CONFIGURATION</u>	7
4.1.	Test frequency list	7
4.2.	Test mode	7
4.3.	Support unit used in test configuration and system	7
4.4.	Testing environmental condition	8
4.5.	Measurement uncertainty	8
4.6.	Equipment Used during the Test	9
5.	<u>TEST CONDITIONS AND RESULTS</u>	11
5.1.	Antenna Requirement	11
5.2.	AC Conducted Emission	12
5.3.	Peak Output Power	13
5.4.	Power Spectral Density	14
5.5.	6dB bandwidth	15
5.6.	99% Occupied Bandwidth	16
5.7.	Duty Cycle	17
5.8.	Conducted Band edge and Spurious Emission	18
5.9.	Radiated Band edge Emission	20
5.10.	Radiated Spurious Emission	22
6.	<u>TEST SETUP PHOTOS</u>	27
7.	<u>EXTERANAL AND INTERNAL PHOTOS</u>	29
8.	<u>APPENDIX REPORT</u>	33

1. TEST STANDARDS AND REPORT VERSION

1.1. Test Standards

The tests were performed according to following standards:

- [FCC Rules Part 15.247](#): Frequency Hopping, Direct Spread Spectrum and Hybrid Systems that are in operation within the bands of 902-928 MHz, 2400-2483.5 MHz, and 5725-5850 MHz
- [ANSI C63.10:2013](#): American National Standard for Testing Unlicensed Wireless Devices
- [KDB 558074 D01 15.247 Meas Guidance v05r02](#): Guidance for Compliance Measurements on Digital Transmission System, Frequency Hopping Spread Spectrum System, and Hybrid System Devices Operating under Section 15.247 of The FCC Rules

1.2. Report version

Revision No.	Date of issue	Description
N/A	2020-04-08	Original

2. TEST DESCRIPTION

Report clause	Test Items	Standard Requirement	Result
5.1	Antenna Requirement	15.203/15.247(c)	PASS
5.2	AC Conducted Emission	15.207	N/A
5.3	Peak Output Power	15.247(b)(3)	PASS
5.4	Power Spectral Density	15.247(e)	PASS
5.5	6dB Bandwidth	15.247(a)(2)	PASS
5.6	99% Occupied Bandwidth	-	PASS
5.7	Duty cycle	-	PASS
5.8	Conducted Band Edge and Spurious Emission	15.247(d)/15.205	PASS
5.9	Radiated Band Edge Emission	15.205/15.209	PASS
5.10	Radiated Spurious Emission	15.247(d)/15.205/15.209	PASS

Note:

- The measurement uncertainty is not included in the test result.
- *1: No requirement on standard, only report these test data.

3. SUMMARY

3.1. Client Information

Applicant:	Ackcio Pte. Ltd.
Address:	75 Ayer Rajah Crescent #03-01/02 Singapore 139953
Manufacturer:	Ackcio Pte. Ltd.
Address:	75 Ayer Rajah Crescent #03-01/02 Singapore 139953

3.2. Product Description

Name of EUT:	BEAM-AN-S4
Trade Mark:	-
Model No.:	BEAM-AN-S4
Listed Model(s):	-
Power supply:	DC 3.6V
Hardware version:	1.0
Software version:	4.4

3.3. Radio Specification Description

Modulation:	2-GFSK
Operation frequency:	902MHz - 928MHz
Channel number:	50
Channel separation:	-
Antenna type:	Omnidirectional Dipole Antenna
Antenna gain:	3 dBi

3.4. Testing Laboratory Information

Laboratory Name	Shenzhen Huatongwei International Inspection Co., Ltd.	
Laboratory Location	1/F, Bldg 3, Hongfa Hi-tech Industrial Park, Genyu Road, Tianliao, Gongming, Shenzhen, China	
Qualifications	Type	Accreditation Number
	CNAS	L1225
	A2LA	3902.01
	FCC	762235
	Canada	5377A

4. TEST CONFIGURATION

4.1. Test frequency list

According to section 15.31(m), regards to the operating frequency range over 10 MHz, must select three channels which were tested. The Lowest frequency, the middle frequency, and the highest frequency of channel were selected to perform the test, please see the below blue front.

Channel	Frequency (MHz)
00	902.5
01	903
⋮	⋮
25	915
⋮	⋮
48	927
49	927.5

4.2. Test mode

For RF test items
The engineering test program was provided and enabled to make EUT continuous transmit.
For Radiated spurious emissions test item:
The engineering test program was provided and enabled to make EUT continuous transmit. The EUT in each of three orthogonal axis emissions had been tested, but only the worst case (X axis) data Recorded in the report.

4.3. Support unit used in test configuration and system

The EUT has been associated with peripherals and configuration operated in a manner tended to maximize its emission characteristics in a typical application.

The following peripheral devices and interface cables were connected during the measurement:

Whether support unit is used?					
✓ No					
Item	Equipement	Trade Name	Model No.	FCC ID	Power cord
1					
2					

4.4. Testing environmental condition

Type	Requirement	Actual
Temperature:	15~35°C	25°C
Relative Humidity:	25~75%	50%
Air Pressure:	860~1060mbar	1000mbar

4.5. Measurement uncertainty

Test Item	Measurement Uncertainty
AC Conducted Emission (150kHz~30MHz)	3.02 dB
Radiated Emission (30MHz~1000MHz)	4.90 dB
Radiated Emissions (1GHz~25GHz)	4.96 dB
Peak Output Power	0.51 dB
Power Spectral Density	0.51 dB
Conducted Spurious Emission	0.51 dB
6dB Bandwidth	70 Hz

This uncertainty represents an expanded uncertainty expressed at approximately the 95% confidence level using a coverage factor of $k=1.96$.

4.6. Equipment Used during the Test

● Conducted Emission							
Used	Test Equipment	Manufacturer	Equipment No.	Model No.	Serial No.	Last Cal. Date (YY-MM-DD)	Next Cal. Date (YY-MM-DD)
●	Shielded Room	Albatross projects	HTWE0114	N/A	N/A	2018/09/28	2023/09/27
●	EMI Test Receiver	R&S	HTWE0111	ESCI	101247	2019/10/26	2020/10/25
●	Artificial Mains	SCHWARZBECK	HTWE0113	NNLK 8121	573	2019/10/23	2020/10/22
●	Pulse Limiter	R&S	HTWE0033	ESH3-Z2	100499	2019/10/23	2020/10/22
●	RF Connection Cable	HUBER+SUHNER	HTWE0113-02	ENVIROFLE X_142	EF-NM-BNCM-2M	2019/10/23	2020/10/22
●	Test Software	R&S	N/A	ES-K1	N/A	N/A	N/A

● Radiated emission-6th test site							
Used	Test Equipment	Manufacturer	Equipment No.	Model No.	Serial No.	Last Cal. Date (YY-MM-DD)	Next Cal. Date (YY-MM-DD)
●	Semi-Anechoic Chamber	Albatross projects	HTWE0127	SAC-3m-02	C11121	2018/09/30	2021/09/29
●	EMI Test Receiver	R&S	HTWE0099	ESCI	100900	2019/10/26	2020/10/25
●	Loop Antenna	R&S	HTWE0170	HFH2-Z2	100020	2018/04/02	2021/04/01
●	Ultra-Broadband Antenna	SCHWARZBECK	HTWE0119	VULB9163	546	2020/04/05	2023/04/04
●	Pre-Amplifier	SCHWARZBECK	HTWE0295	BBV 9742	N/A	2019/11/14	2020/11/13
●	RF Connection Cable	HUBER+SUHNER	HTWE0062-01	N/A	N/A	2019/08/21	2020/08/20
●	RF Connection Cable	HUBER+SUHNER	HTWE0062-02	SUCOFLEX 104	501184/4	2019/05/27	2020/05/26
●	Test Software	R&S	N/A	ES-K1	N/A	N/A	N/A

● Radiated emission-7th test site							
Used	Test Equipment	Manufacturer	Equipment No.	Model No.	Serial No.	Last Cal. Date (YY-MM-DD)	Next Cal. Date (YY-MM-DD)
●	Semi-Anechoic Chamber	Albatross projects	HTWE0122	SAC-3m-01	N/A	2018/09/27	2021/09/26
●	Spectrum Analyzer	R&S	HTWE0098	FSP40	100597	2019/10/26	2020/10/25
●	Horn Antenna	SCHWARZBECK	HTWE0126	9120D	1011	2020/04/01	2023/03/31
●	Horn Antenna	SCHWARZBECK	HTWE0103	BBHA9170	25841	2018/10/11	2021/10/10
●	Broadband Horn Antenna	SCHWARZBECK	HTWE0103	BBHA9170	BBHA9170472	2018/10/11	2021/10/11
●	Pre-amplifier	CD	HTWE0071	PAP-0102	12004	2019/11/14	2020/11/13
●	Broadband Pre-amplifier	SCHWARZBECK	HTWE0201	BBV 9718	9718-248	2019/05/23	2020/05/22
●	RF Connection Cable	HUBER+SUHNER	HTWE0120-01	6m 18GHz S Serisa	N/A	2019/05/10	2020/05/09
●	RF Connection Cable	HUBER+SUHNER	HTWE0120-02	6m 3GHz RG Serisa	N/A	2019/05/10	2020/05/09
●	RF Connection Cable	HUBER+SUHNER	HTWE0120-03	6m 3GHz RG Serisa	N/A	2019/05/10	2020/05/09
●	RF Connection Cable	HUBER+SUHNER	HTWE0120-04	6m 3GHz RG Serisa	N/A	2019/05/10	2020/05/09
●	RF Connection Cable	HUBER+SUHNER	HTWE0121-01	6m 18GHz S Serisa	N/A	2019/05/10	2020/05/09
●	Test Software	Audix	N/A	E3	N/A	N/A	N/A

● RF Conducted Method						
Used	Test Equipment	Manufacturer	Model No.	Serial No.	Last Cal. Date (YY-MM-DD)	Next Cal. Date (YY-MM-DD)
●	Signal and spectrum Analyzer	R&S	FSV40	100048	2019/10/26	2020/10/25
●	Spectrum Analyzer	Agilent	N9020A	MY50510187	2019/10/26	2020/10/25
●	Power Meter	Anritsu	ML249A	N/A	2019/10/26	2020/10/25
○	Radio communication tester	R&S	CMW500	137688-Lv	2019/10/26	2020/10/25

5. TEST CONDITIONS AND RESULTS

5.1. Antenna Requirement

Requirement

FCC CFR Title 47 Part 15 Subpart C Section 15.203:

An intentional radiator shall be designed to ensure that no antenna other than that furnished by the responsible party shall be used with the device. The use of a permanently attached antenna or of an antenna that uses a unique coupling to the intentional radiator, the manufacturer may design the unit so that a broken antenna can be replaced by the user, but the use of a standard antenna jack or electrical connector is prohibited.

FCC CFR Title 47 Part 15 Subpart C Section 15.247(c) (1)(i):

(i) Systems operating in the 2400-2483.5 MHz band that is used exclusively for fixed. Point-to-point operations may employ transmitting antennas with directional gain greater than 6 dBi provided the maximum conducted output power of the intentional radiator is reduced by 1 dB for every 3 dB that the directional gain of the antenna exceeds 6 dBi.

TEST RESULT

Passed Not Applicable

The antenna type is a Omnidirectional Dipole antenna, the directional gain of the antenna less than 6 dBi, please refer to the below antenna photo.

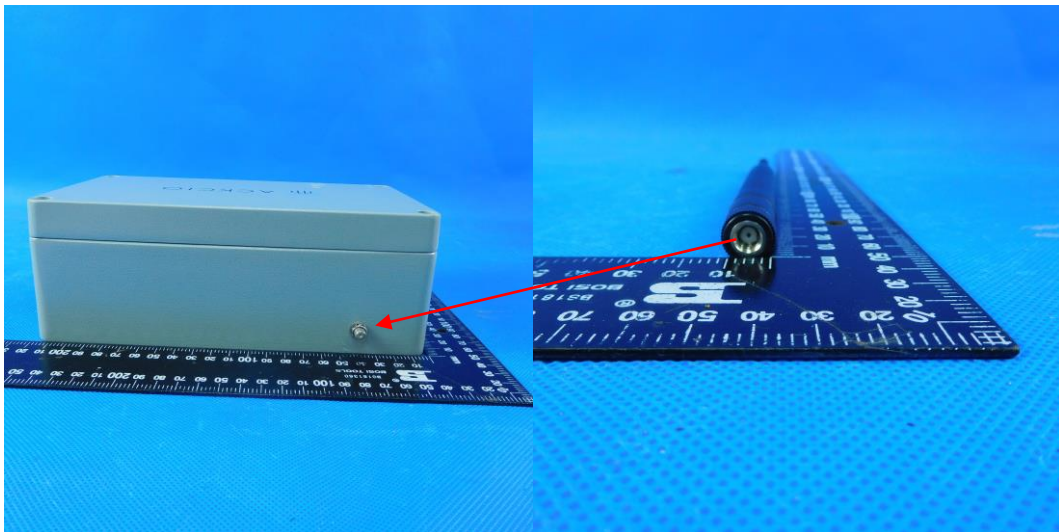

5.2. AC Conducted Emission

LIMIT

FCC CFR Title 47 Part 15 Subpart C Section 15.207

Frequency range (MHz)	Limit (dBuV)	
	Quasi-peak	Average
0.15-0.5	66 to 56*	56 to 46*
0.5-5	56	46
5-30	60	50

* Decreases with the logarithm of the frequency.

TEST CONFIGURATION

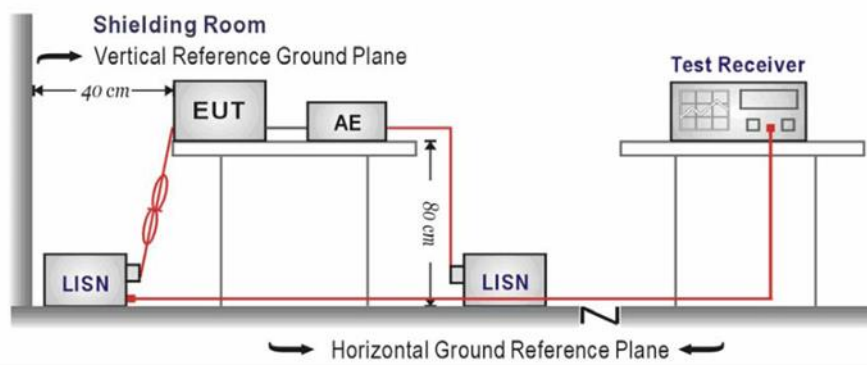

TEST PROCEDURE

1. The EUT was setup according to ANSI C63.10 requirements.
2. The EUT was placed on a platform of nominal size, 1 m by 1.5 m, raised 80 cm above the conducting ground plane. The vertical conducting plane was located 40 cm to the rear of the EUT. All other surfaces of EUT were at least 80 cm from any other grounded conducting surface.
3. The EUT and simulators are connected to the main power through a line impedances stabilization network (LISN). The LISN provides a 50 ohm /50uH coupling impedance for the measuring equipment.
4. The peripheral devices are also connected to the main power through a LISN. (Please refer to the block diagram of the test setup and photographs)
5. Each current-carrying conductor of the EUT power cord, except the ground (safety) conductor, was individually connected through a LISN to the input power source.
6. The excess length of the power cord between the EUT and the LISN receptacle were folded back and forth at the center of the lead to form a bundle not exceeding 40 cm in length.
7. Conducted emissions were investigated over the frequency range from 0.15MHz to 30MHz using a receiver bandwidth of 9 kHz.
8. During the above scans, the emissions were maximized by cable manipulation.

TEST MODE:

Please refer to the clause 4.2

TEST RESULT

Passed Not Applicable

5.3. Peak Output Power

LIMIT

FCC CFR Title 47 Part 15 Subpart C Section 15.247 (b)(3): 30dBm

TEST CONFIGURATION

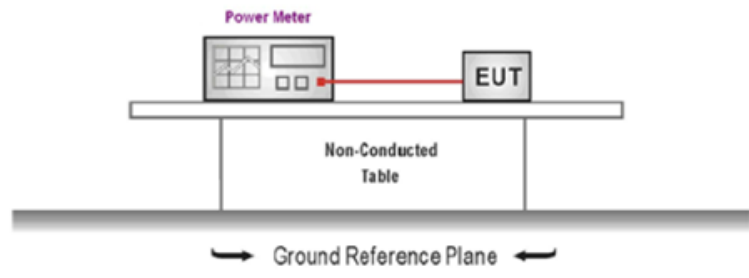

TEST PROCEDURE

1. The EUT was tested according to ANSI C63.10 and KDB 558074 D01 requirements.
2. The maximum peak conducted output power may be measured using a broadband peak RF power meter.
3. The power meter shall have a video bandwidth that is greater than or equal to the DTS bandwidth and shall utilize a fast-responding diode detector.
4. Record the measurement data.

TEST MODE:

Please refer to the clause 4.2

TEST RESULT

Passed Not Applicable

TEST Data

Please refer to appendix A on the appendix report

5.4. Power Spectral Density

LIMIT

FCC CFR Title 47 Part 15 Subpart C Section 15.247 (e):

For digitally modulated systems, the power spectral density conducted from the intentional radiator to the antenna shall not be greater than 8dBm in any 3 kHz band during any time interval of continuous transmission.

TEST CONFIGURATION

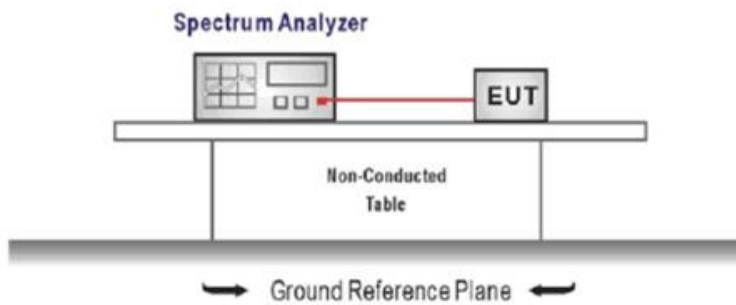

TEST PROCEDURE

1. Connect the antenna port(s) to the spectrum analyzer input,
2. Configure the spectrum analyzer as shown below:
Center frequency=DTS channel center frequency
Span =1.5 times the DTS bandwidth
RBW = 3 kHz ≤ RBW ≤ 100 kHz, VBW ≥ 3 × RBW
Sweep time = auto couple
Detector = peak
Trace mode = max hold
3. Place the radio in continuous transmit mode, allow the trace to stabilize, view the transmitter wave form on the spectrum analyzer.
4. Use the peak marker function to determine the maximum amplitude level within the RBW.
5. If measured value exceeds limit, reduce RBW (no less than 3 kHz) and repeat.

TEST MODE:

Please refer to the clause 4.2

TEST RESULT

Passed Not Applicable

TEST Data

Please refer to appendix B on the appendix report

5.5. 6dB bandwidth

LIMIT

FCC CFR Title 47 Part 15 Subpart C Section 15.247 (a)(2):

For digital modulation systems, the minimum 6 dB bandwidth shall be at least 500 kHz.

TEST CONFIGURATION

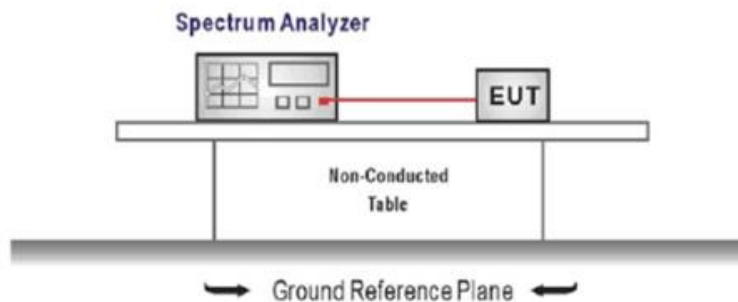

TEST PROCEDURE

1. Connect the antenna port(s) to the spectrum analyzer input.
2. Configure the spectrum analyzer as shown below (enter all losses between the transmitter output and the spectrum analyzer).
Center Frequency =DTS channel center frequency
Span=2 x DTS bandwidth
RBW = 100 kHz, VBW \geq 3 x RBW
Sweep time= auto couple
Detector = Peak
Trace mode = max hold
3. Place the radio in continuous transmit mode, allow the trace to stabilize, view the transmitter waveform on the spectrum analyzer.
4. Measure the maximum width of the emission that is constrained by the frequencies associated with the two outermost amplitude points (upper and lower frequencies) that are attenuated by 6 dB relative to the maximum level measured in the fundamental emission, and record the pertinent measurements.

TEST MODE:

Please refer to the clause 4.2

TEST RESULT

Passed Not Applicable

TEST Data

Please refer to appendix C on the appendix report

5.6. 99% Occupied Bandwidth

LIMIT

N/A

TEST CONFIGURATION

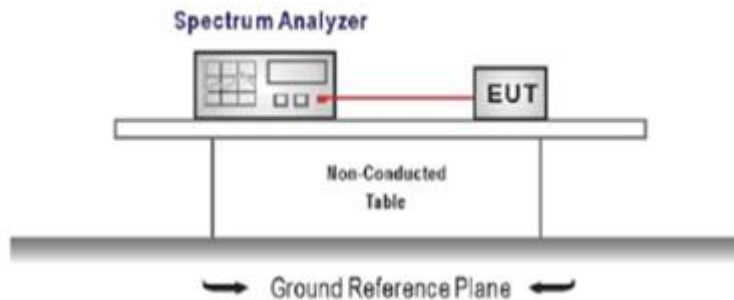

TEST PROCEDURE

1. Connect the antenna port(s) to the spectrum analyzer input.
2. Configure the spectrum analyzer as shown below (enter all losses between the transmitter output and the spectrum analyzer).
Center Frequency = channel center frequency
Span $\geq 1.5 \times$ OBW
RBW = 1%~5%OBW
VBW $\geq 3 \times$ RBW
Sweep time = auto couple
Detector = Peak
Trace mode = max hold
3. Place the radio in continuous transmit mode, allow the trace to stabilize, view the transmitter waveform on the spectrum analyzer.

TEST MODE:

Please refer to the clause 4.2

TEST RESULT

Passed Not Applicable

TEST Data

Please refer to appendix D on the appendix report

5.7. Duty Cycle

LIMIT

N/A

TEST CONFIGURATION

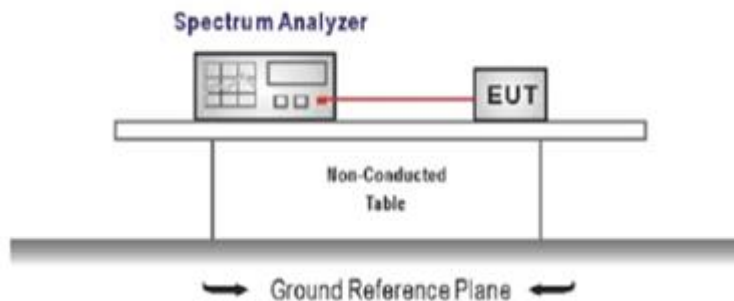

TEST PROCEDURE

1. The transmitter output was connected to the spectrum analyzer through an attenuator, the path loss was compensated to the results for each measurement.
2. Set to the maximum power setting and enable the EUT transmit continuously
3. Use the following spectrum analyzer settings:
Span=zero span, Frequency=centered channel, RBW= 1 MHz, VBW \geq RBW
Sweep=as necessary to capture the entire dwell time,
Detector function = peak, Trigger mode
4. Measure and record the duty cycle data

TEST MODE:

Please refer to the clause 4.2

TEST Data

Please refer to appendix E on the appendix report

5.8. Conducted Band edge and Spurious Emission

LIMIT

FCC CFR Title 47 Part 15 Subpart C Section 15.247 (d): In any 100 kHz bandwidth outside the frequency band in which the spread spectrum intentional radiator is operating, the radio frequency power that is produced by the intentional radiator shall be at least 20 dB below that in the 100 kHz bandwidth within the band that contains the highest level of the desired power, based on either an RF conducted or a radiated measurement.

TEST CONFIGURATION

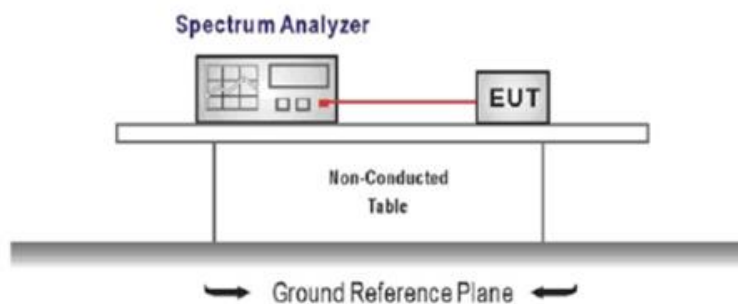

TEST PROCEDURE

1. Connect the antenna port(s) to the spectrum analyzer input.
2. Establish a reference level by using the following procedure
Center frequency=DTS channel center frequency
The span = 1.5 times the DTS bandwidth.
RBW = 100 kHz, VBW $\geq 3 \times$ RBW
Detector = peak, Sweep time = auto couple, Trace mode = max hold
Allow trace to fully stabilize
Use the peak marker function to determine the maximum PSD level

Note that the channel found to contain the maximum PSD level can be used to establish the reference level.

3. Emission level measurement
Set the center frequency and span to encompass frequency range to be measured
RBW = 100 kHz, VBW $\geq 3 \times$ RBW
Detector = peak, Sweep time = auto couple, Trace mode = max hold
Allow trace to fully stabilize
Use the peak marker function to determine the maximum amplitude level.
4. Place the radio in continuous transmit mode, allow the trace to stabilize, view the transmitter waveform on the spectrum analyzer.
5. Ensure that the amplitude of all unwanted emission outside of the authorized frequency band excluding restricted frequency bands) are attenuated by at least the minimum requirements specified (at least 20 dB relative to the maximum in-band peak PSD level in 100 kHz). Report the three highest emission relative to the limit.

TEST MODE:

Please refer to the clause 4.2

TEST RESULT

Passed **Not Applicable**

TEST Data

Please refer to appendix F on the appendix report

5.9. Radiated Band edge Emission

LIMIT

FCC CFR Title 47 Part 15 Subpart C Section 15.247 (d):

In any 100 kHz bandwidth outside the frequency band in which the spread spectrum or digitally modulated intentional radiator is operating, Radiated Emissions which fall in the restricted bands, as defined in §15.205(a), must also comply with the Radiated Emissions limits specified in §15.209(a) (see §15.205(c)).

TEST CONFIGURATION

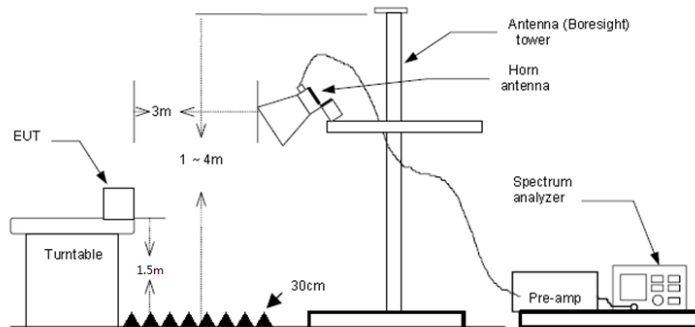

TEST PROCEDURE

1. The EUT was setup and tested according to ANSI C63.10 .
2. The EUT is placed on a turn table which is 1.5 meter above ground. The turn table is rotated 360 degrees to determine the position of the maximum emission level.
3. The EUT was positioned such that the distance from antenna to the EUT was 3 meters.
4. The antenna is scanned from 1 meter to 4 meters to find out the maximum emission level. This is repeated for both horizontal and vertical polarization of the antenna. In order to find the maximum emission, all of the interface cables were manipulated according to ANSI C63.10 on radiated measurement.
5. Use the following spectrum analyzer settings:
 - a) Span shall wide enough to fully capture the emission being measured
 - b) Set RBW=100kHz for <1GHz, VBW=3*RBW, Sweep time=auto, Detector=peak, Trace=max hold
 - c) Set RBW=1MHz, VBW=3MHz for >1GHz, Sweep time=auto, Detector=peak, Trace=max hold for Peak measurement

For average measurement:

 - VBW=10Hz, When duty cycle is no less than 98 percent
 - VBW \geq 1/T, when duty cycle is less than 98 percent where T is the minimum transmission duration over which the transmitter is on and is transmitting at its maximum power control level for the tested mode of operation, so refer to this clause 5.6 duty cycle.

TEST MODE:

Please refer to the clause 4.2

TEST RESULT

Passed Not Applicable

Note:

- 1) Level= Reading + Factor; Factor =Antenna Factor+ Cable Loss- Preamp Factor
- 2) Margin = Limit – Level
- 3) Average measurement was not performed if peak level is lower than average limit(54 dBuV/m).

Test channel	CH00	Polarity	Horizontal					
Suspected Data List								
NO.	Freq. [MHz]	Reading [dB μ V/m]	Factor [dB]	Level [dB μ V/m]	Limit [dB μ V/m]	Margin [dB]	Polarity	Detector
1	902.0025	25.56	32.20	57.76	74.00	16.24	Horizontal	PK
Suspected Data List								
NO.	Freq. [MHz]	Reading [dB μ V/m]	Factor [dB]	Level [dB μ V/m]	Limit [dB μ V/m]	Margin [dB]	Polarity	Detector
1	902.0025	15.79	32.20	47.99	54.00	6.01	Horizontal	AV
Test channel	CH00	Polarity	Vertical					
Suspected Data List								
NO.	Freq. [MHz]	Reading [dB μ V/m]	Factor [dB]	Level [dB μ V/m]	Limit [dB μ V/m]	Margin [dB]	Polarity	Detector
1	902.0025	30.72	32.20	62.92	74.00	11.08	Vertical	PK
Suspected Data List								
NO.	Freq. [MHz]	Reading [dB μ V/m]	Factor [dB]	Level [dB μ V/m]	Limit [dB μ V/m]	Margin [dB]	Polarity	Detector
1	902.0025	18.55	32.20	50.75	54.00	3.25	Vertical	AV

Test channel	CH49	Polarity	Horizontal					
Suspected Data List								
NO.	Freq. [MHz]	Reading [dB μ V/m]	Factor [dB]	Level [dB μ V/m]	Limit [dB μ V/m]	Margin [dB]	Polarity	Detector
1	928.0000	21.06	32.31	53.37	74.00	20.63	Horizontal	PK
Suspected Data List								
NO.	Freq. [MHz]	Reading [dB μ V/m]	Factor [dB]	Level [dB μ V/m]	Limit [dB μ V/m]	Margin [dB]	Polarity	Detector
1	928.0000	16.85	32.31	49.16	54.00	4.84	Horizontal	AV
Test channel	CH49	Polarity	Vertical					
Suspected Data List								
NO.	Freq. [MHz]	Reading [dB μ V/m]	Factor [dB]	Level [dB μ V/m]	Limit [dB μ V/m]	Margin [dB]	Polarity	Detector
1	928.0000	23.48	32.31	55.79	74.00	18.21	Vertical	PK
Suspected Data List								
NO.	Freq. [MHz]	Reading [dB μ V/m]	Factor [dB]	Level [dB μ V/m]	Limit [dB μ V/m]	Margin [dB]	Polarity	Detector
1	928.0000	18.59	32.31	50.90	54.00	3.10	Vertical	AV

5.10. Radiated Spurious Emission

LIMIT

FCC CFR Title 47 Part 15 Subpart C Section 15.209

Frequency	Limit (dBuV/m)	Value
0.009 MHz ~0.49 MHz	2400/F(kHz) @300m	Quasi-peak
0.49 MHz ~ 1.705 MHz	24000/F(kHz) @30m	Quasi-peak
1.705 MHz ~30 MHz	30 @30m	Quasi-peak

Note: Limit dBuV/m @3m = Limit dBuV/m @300m + 40*log(300/3)= Limit dBuV/m @300m +80,

Limit dBuV/m @3m = Limit dBuV/m @30m +40*log(30/3)= Limit dBuV/m @30m + 40.

Frequency	Limit (dBuV/m @3m)	Value
30MHz~88MHz	40.00	Quasi-peak
88MHz~216MHz	43.50	Quasi-peak
216MHz~960MHz	46.00	Quasi-peak
960MHz~1GHz	54.00	Quasi-peak
Above 1GHz	54.00	Average
	74.00	Peak

TEST CONFIGURATION

- 9 kHz ~ 30 MHz

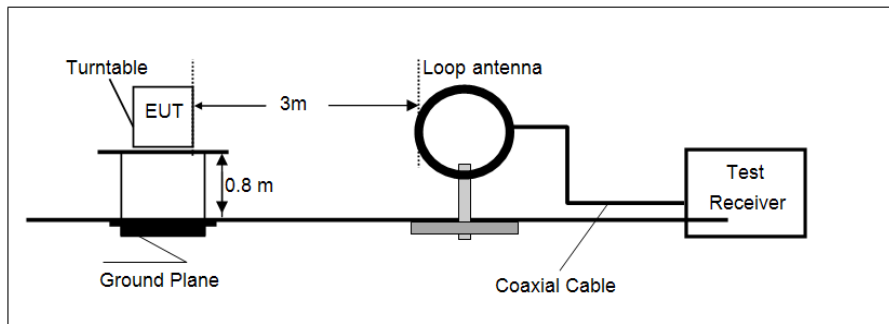

- 30 MHz ~ 1 GHz

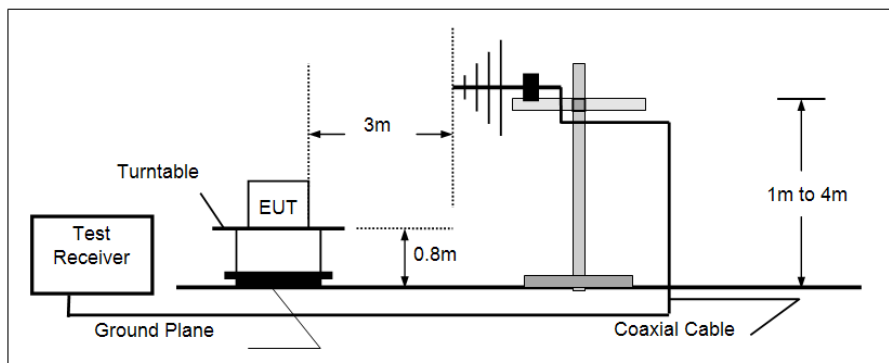

- Above 1 GHz

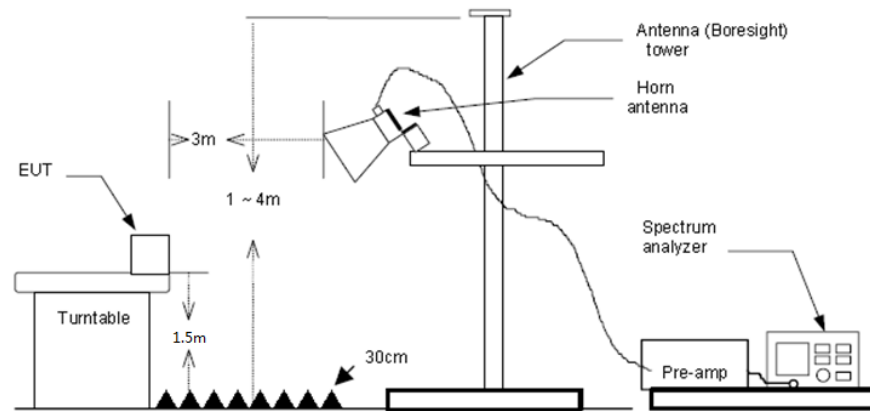

TEST PROCEDURE

1. The EUT was setup and tested according to ANSI C63.10 .
2. The EUT is placed on a turn table which is 0.8 meter above ground for below 1 GHz, and 1.5 m for above 1 GHz. The turn table is rotated 360 degrees to determine the position of the maximum emission level.
3. The EUT was set 3 meters from the receiving antenna, which was mounted on the top of a variable height antenna tower.
4. For each suspected emission, the EUT was arranged to its worst case and then tune the Antenna tower (from 1 m to 4 m) and turntable (from 0 degree to 360 degrees) to find the maximum reading. A pre-amp and a high pass filter are used for the test in order to get better signal level to comply with the guidelines.
5. Set to the maximum power setting and enable the EUT transmit continuously.
6. Use the following spectrum analyzer settings
 - a) Span shall wide enough to fully capture the emission being measured;
 - b) Below 1 GHz:
 - RBW=120 kHz, VBW=300 kHz, Sweep=auto, Detector function=peak, Trace=max hold;
 - If the emission level of the EUT measured by the peak detector is 3 dB lower than the applicable limit, the peak emission level will be reported. Otherwise, the emission measurement will be repeated using the quasi-peak detector and reported.
 - c) Set RBW=1MHz, VBW=3MHz for >1GHz, Sweep time=auto, Detector=peak, Trace=max hold for Peak measurement
 - For average measurement:
 - VBW=10Hz, When duty cycle is no less than 98 percent
 - $VBW \geq 1/T$, when duty cycle is less than 98 percent where T is the minimum transmission duration over which the transmitter is on and is transmitting at its maximum power control level for the tested mode of operation, so refer to this clause 5.6 duty cycle.

TEST MODE:

Please refer to the clause 4.2

TEST RESULT

Passed **Not Applicable**

Note:

- 1) Level= Reading + Factor/Transd; Factor/Transd =Antenna Factor+ Cable Loss- Preamp Factor
- 2) Margin = Limit – Level
- 3) Average measurement was not performed if peak level is lower than average limit(54 dBuV/m) for above 1GHz.

TEST DATA FOR 9 kHz ~ 30 MHz

The EUT was pre-scanned this frequency band, found the radiated level 20dB lower than the limit, so don't show data on this report.

TEST DATA FOR 30 MHz ~ 1000 MHz

Have pre-scan all test channel, found CH49 which it was worst case, so only show the worst case's data on this report.

Polarization:

Horizontal

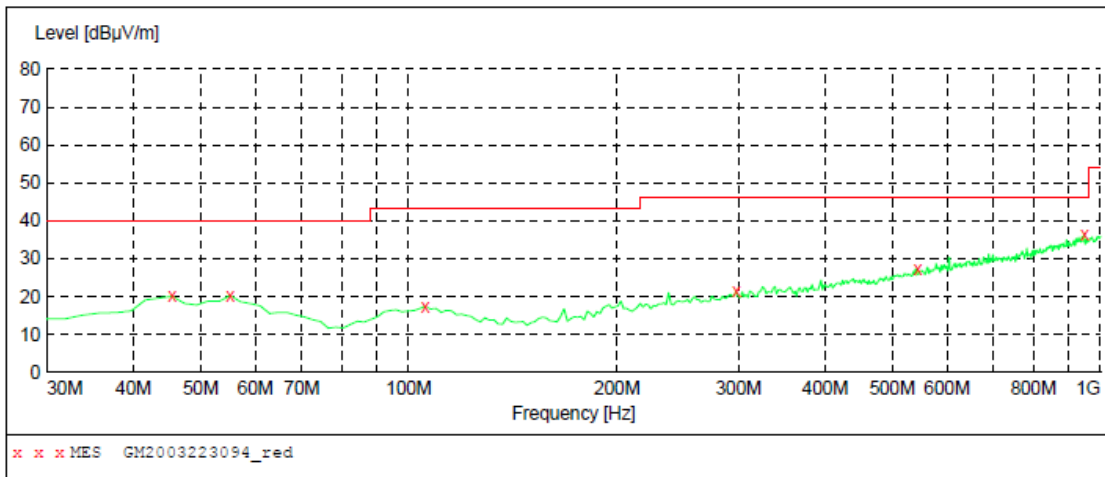

MEASUREMENT RESULT: "GM2003223094_red"

3/23/2020 8:26PM

Frequency MHz	Level dBuV/m	Transd dB	Limit dBuV/m	Margin dB	Det.	Height cm	Azimuth deg	Polarization
45.520000	20.10	-8.4	40.0	19.9	QP	100.0	0.00	HORIZONTAL
55.220000	20.30	-8.4	40.0	19.7	QP	100.0	283.00	HORIZONTAL
105.660000	17.50	-10.3	43.5	26.0	QP	300.0	281.00	HORIZONTAL
297.720000	21.40	-6.4	46.0	24.6	QP	300.0	344.00	HORIZONTAL
544.100000	27.40	0.0	46.0	18.6	QP	300.0	184.00	HORIZONTAL
947.620000	36.50	8.1	46.0	9.5	QP	100.0	31.00	HORIZONTAL

Polarization:

Vertical

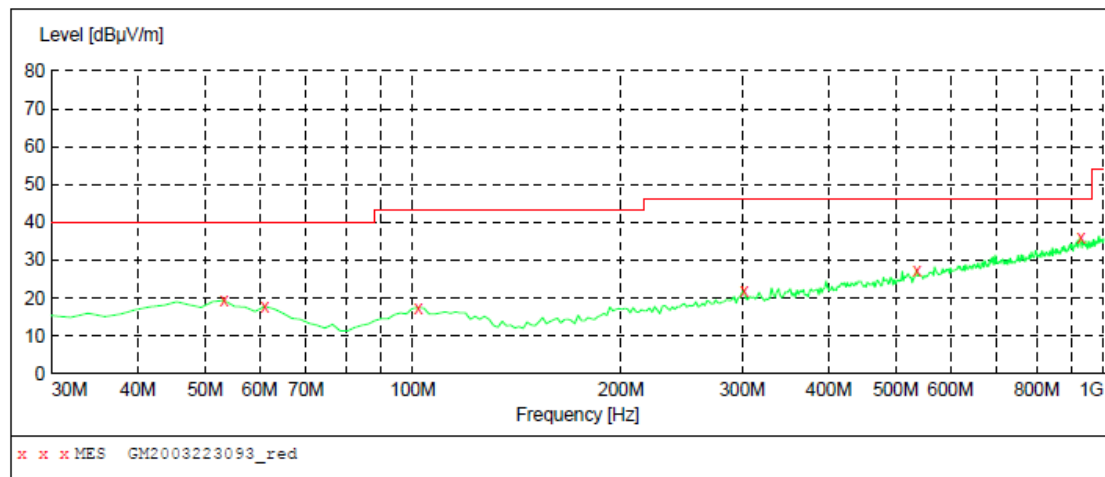

MEASUREMENT RESULT: "GM2003223093_red"

3/23/2020 8:23PM

Frequency MHz	Level dBuV/m	Transd dB	Limit dBuV/m	Margin dB	Det.	Height cm	Azimuth deg	Polarization
53.280000	19.50	-8.6	40.0	20.5	QP	100.0	304.00	VERTICAL
61.040000	17.80	-9.7	40.0	22.2	QP	100.0	6.00	VERTICAL
101.780000	17.50	-10.2	43.5	26.0	QP	100.0	280.00	VERTICAL
301.600000	22.00	-6.3	46.0	24.0	QP	100.0	15.00	VERTICAL
536.340000	27.40	-0.3	46.0	18.6	QP	100.0	268.00	VERTICAL
926.280000	35.90	7.7	46.0	10.1	QP	100.0	207.00	VERTICAL

TEST DATA FOR 1 GHz ~ 25 GHz

Test channel					CH00			
Suspected Data List								
NO.	Freq. [MHz]	Reading [dB μ V/m]	Factor [dB]	Level [dB μ V/m]	Limit [dB μ V/m]	Margin [dB]	Polarity	Detector
1	1136.593	37.63	-6.50	31.13	74.00	42.87	Horizontal	PK
2	3162.000	33.57	0.64	34.21	74.00	39.79	Horizontal	PK
3	5155.093	31.18	8.90	40.08	74.00	33.92	Horizontal	PK
4	9504.062	31.30	17.97	49.27	74.00	24.73	Horizontal	PK
Suspected Data List								
NO.	Freq. [MHz]	Reading [dB μ V/m]	Factor [dB]	Level [dB μ V/m]	Limit [dB μ V/m]	Margin [dB]	Polarity	Detector
1	1398.031	39.85	-5.58	34.27	74.00	39.73	Vertical	PK
2	3680.468	33.96	1.56	35.52	74.00	38.48	Vertical	PK
3	5133.062	30.87	8.86	39.73	74.00	34.27	Vertical	PK
4	9007.625	31.09	16.75	47.84	74.00	26.16	Vertical	PK
Test channel					CH25			
Suspected Data List								
NO.	Freq. [MHz]	Reading [dB μ V/m]	Factor [dB]	Level [dB μ V/m]	Limit [dB μ V/m]	Margin [dB]	Polarity	Detector
1	1098.406	41.80	-6.90	34.90	74.00	39.10	Horizontal	PK
2	3592.343	32.53	1.42	33.95	74.00	40.05	Horizontal	PK
3	6313.937	31.25	11.04	42.29	74.00	31.71	Horizontal	PK
4	9189.750	33.15	16.69	49.84	74.00	24.16	Horizontal	PK
Suspected Data List								
NO.	Freq. [MHz]	Reading [dB μ V/m]	Factor [dB]	Level [dB μ V/m]	Limit [dB μ V/m]	Margin [dB]	Polarity	Detector
1	1258.500	37.35	-5.68	31.67	74.00	42.33	Vertical	PK
2	3178.156	32.85	0.73	33.58	74.00	40.42	Vertical	PK
3	5118.375	30.90	8.83	39.73	74.00	34.27	Vertical	PK
4	8048.531	31.92	16.26	48.18	74.00	25.82	Vertical	PK
Test channel					CH49			
Suspected Data List								
NO.	Freq. [MHz]	Reading [dB μ V/m]	Factor [dB]	Level [dB μ V/m]	Limit [dB μ V/m]	Margin [dB]	Polarity	Detector
1	1195.343	41.19	-5.88	35.31	74.00	38.69	Horizontal	PK
2	3087.093	33.22	0.26	33.48	74.00	40.52	Horizontal	PK
3	5094.875	30.98	8.75	39.73	74.00	34.27	Horizontal	PK
4	9483.500	31.96	17.90	49.86	74.00	24.14	Horizontal	PK
Suspected Data List								
NO.	Freq. [MHz]	Reading [dB μ V/m]	Factor [dB]	Level [dB μ V/m]	Limit [dB μ V/m]	Margin [dB]	Polarity	Detector
1	1196.812	38.35	-5.86	32.49	74.00	41.51	Vertical	PK
2	2824.187	28.34	1.70	30.04	74.00	43.96	Vertical	PK
3	4861.343	30.72	7.13	37.85	74.00	36.15	Vertical	PK
4	8232.125	32.16	15.97	48.13	74.00	25.87	Vertical	PK

6. TEST SETUP PHOTOS

Radiated Emission

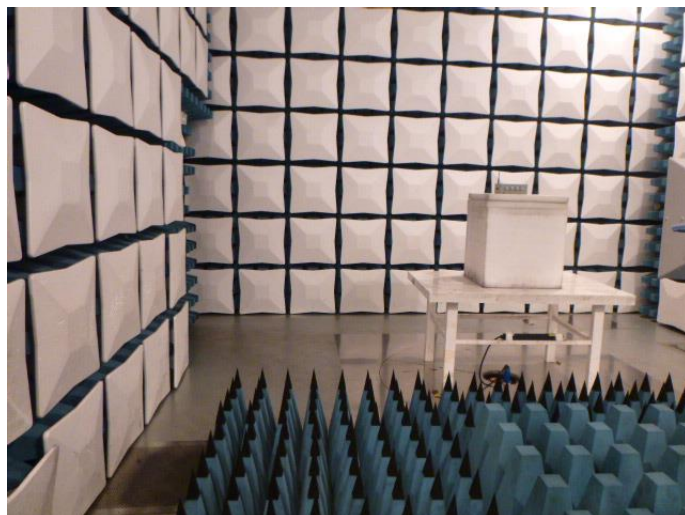



7. EXTERANAL AND INTERNAL PHOTOS

External Photos of the EUT

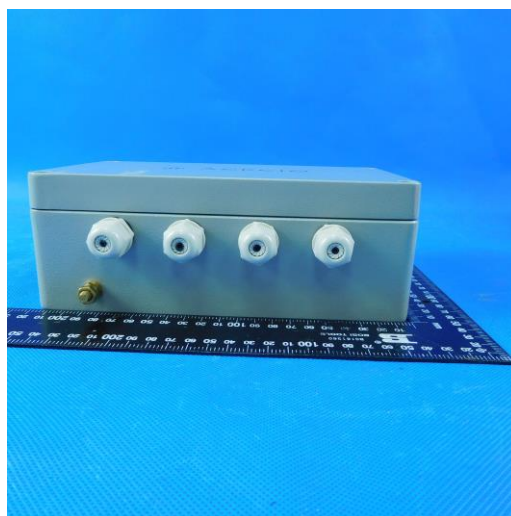
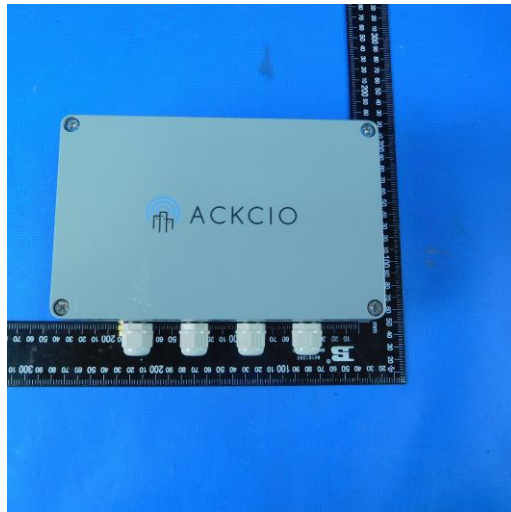
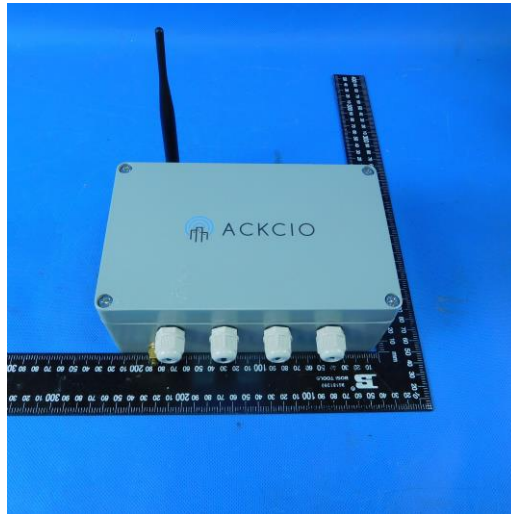

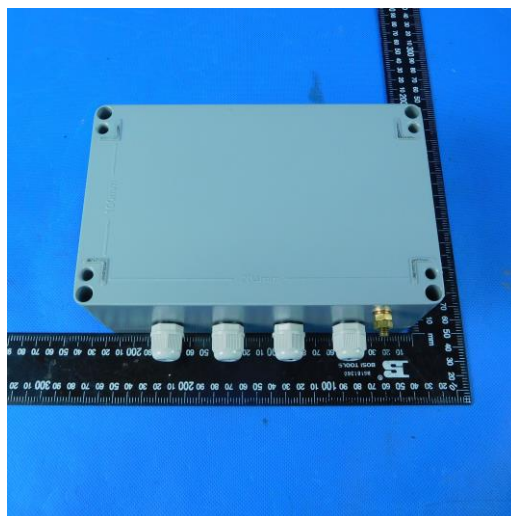
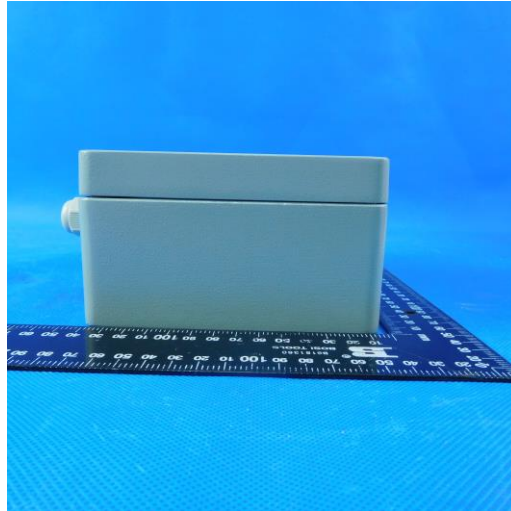

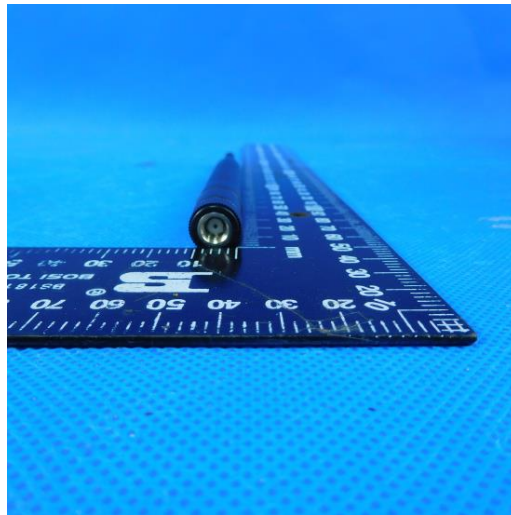
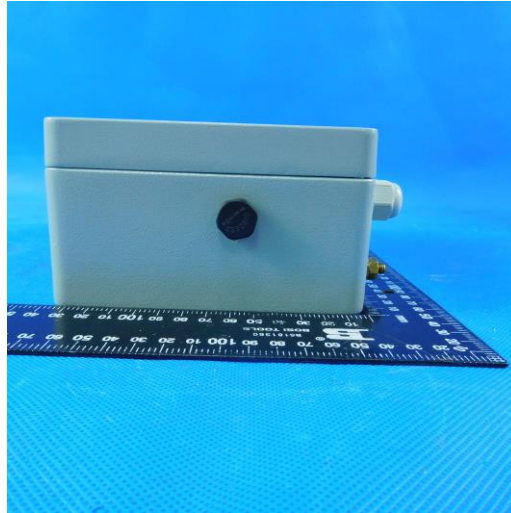

Internal Photos of the EUT

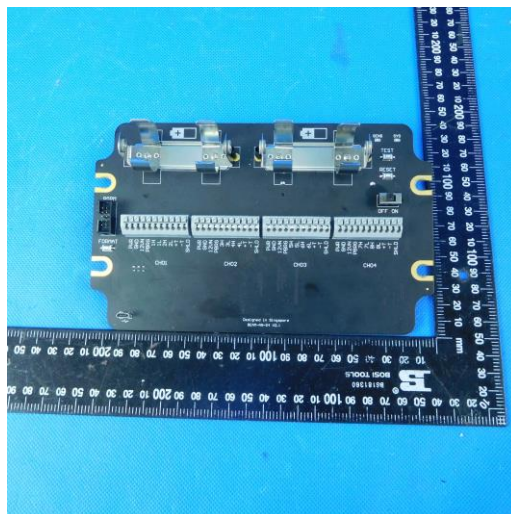
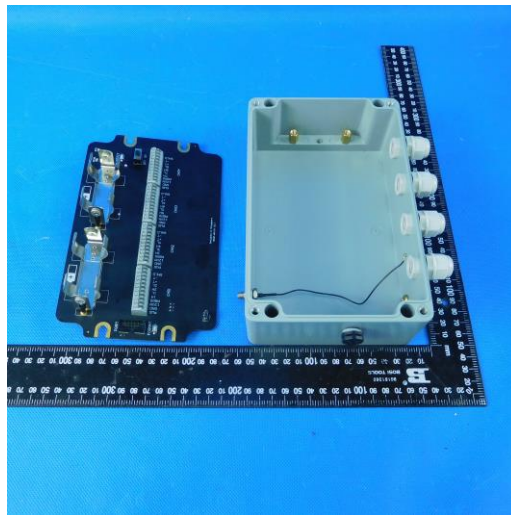
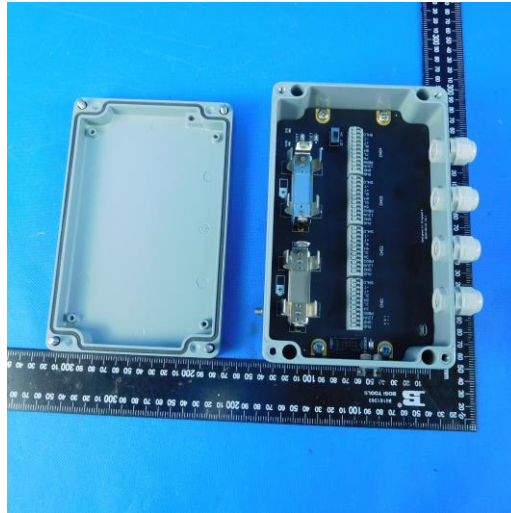

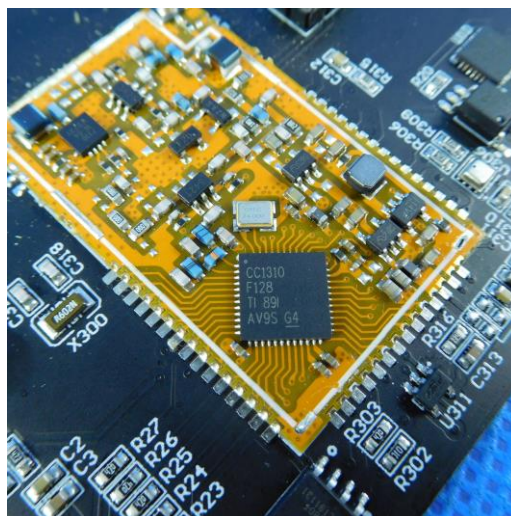
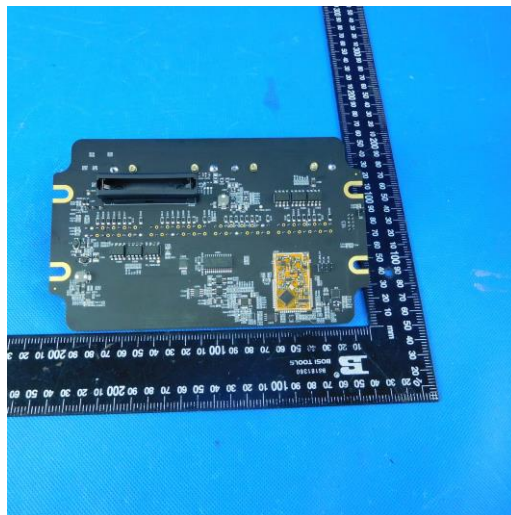
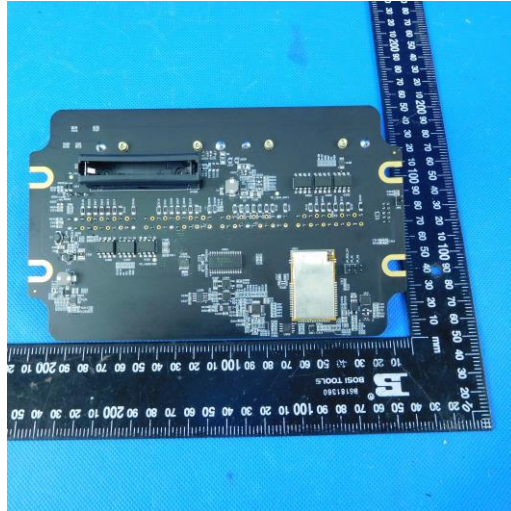

8. APPENDIX REPORT

APPENDIX REPORT

Project No.	SHT1906037411EW		
Test sample No.	YPHT19060374032	Model No.	BEAM-AN-S4
Start test date	2020/3/30	Finish date	2020/3/30
Temperature	25°C	Humidity	50%
Test Engineer	Jinyue.Yan	Auditor	<i>William.wang</i>

Appendix clause	Test item	Result
A	Peak Output Power	PASS
B	Power Spectral Density	PASS
C	6 dB Bandwidth	PASS
D	99% Occupied Bandwidth	PASS
E	Duty cycle	PASS
F	Band edge and Spurious Emissions (conducted)	PASS

Appendix A: Peak Output Power

Type	Channel	Output power (dBm)	Limit (dBm)	Result
2-GFSK	00	12.52	≤30.00	Pass
	25	11.90		
	49	11.54		

Appendix B: Power Spectral Density

Type	Channel	Power Spectral Density(dBm/3KHz)	Limit (dBm/3KHz)	Result
2-GFSK	00	3.99	≤8.00	Pass
	25	3.06		
	49	3.09		

<p>00</p>	<p>Spectrum</p> <p>Ref Level 20.00 dBm Offset 1.00 dB RBW 3 kHz Att 35 dB SWT 632.3 μs VBW 10 kHz Mode Auto FFT Count 100/100</p> <p>IPK Max</p> <p>M1[1] 3.99 dBm 902.27710 MHz</p> <p>CF 902.5 MHz 691 pts Span 1.0 MHz</p> <p>Date: 31.MAR.2020 20:29:17</p>
<p>25</p>	<p>Spectrum</p> <p>Ref Level 20.00 dBm Offset 1.00 dB RBW 3 kHz Att 35 dB SWT 632.3 μs VBW 10 kHz Mode Auto FFT Count 100/100</p> <p>IPK Max</p> <p>M1[1] 3.06 dBm 914.79880 MHz</p> <p>CF 915.0 MHz 691 pts Span 1.0 MHz</p> <p>Date: 31.MAR.2020 20:38:00</p>
<p>49</p>	<p>Spectrum</p> <p>Ref Level 20.00 dBm Offset 1.00 dB RBW 3 kHz Att 35 dB SWT 632.3 μs VBW 10 kHz Mode Auto FFT Count 100/100</p> <p>IPK Max</p> <p>M1[1] 3.09 dBm 927.27710 MHz</p> <p>CF 927.5 MHz 691 pts Span 1.0 MHz</p> <p>Date: 31.MAR.2020 20:41:50</p>

Appendix C: 6dB bandwidth

Type	Channel	6dB Bandwidth(kHz)	Limit (kHz)	Result
2-GFSK	00	538.00	≥500	Pass
	25	542.00		
	49	538.00		

<p style="text-align: center;">00</p>	<p>Spectrum Ref Level 20.00 dBm Offset 1.00 dB RBW 100 kHz Att 35 dB SWT 19.1 μs VBW 300 kHz Mode Auto FFT Count 500/500</p> <p>IPK View</p> <p>CF 902.5 MHz 1001 pts Span 2.0 MHz</p> <table border="1"> <thead> <tr> <th>Type</th> <th>Ref</th> <th>Trc</th> <th>X-value</th> <th>Y-value</th> <th>Function</th> <th>Function Result</th> </tr> </thead> <tbody> <tr> <td>M1</td> <td>1</td> <td></td> <td>902.226 MHz</td> <td>6.36 dBm</td> <td></td> <td></td> </tr> <tr> <td>M2</td> <td>1</td> <td></td> <td>902.302 MHz</td> <td>12.49 dBm</td> <td></td> <td></td> </tr> <tr> <td>D3</td> <td>M1</td> <td>1</td> <td>538.0 kHz</td> <td>-0.09 dB</td> <td></td> <td></td> </tr> </tbody> </table> <p>Date: 31.MAR.2020 20:28:45</p>	Type	Ref	Trc	X-value	Y-value	Function	Function Result	M1	1		902.226 MHz	6.36 dBm			M2	1		902.302 MHz	12.49 dBm			D3	M1	1	538.0 kHz	-0.09 dB		
Type	Ref	Trc	X-value	Y-value	Function	Function Result																							
M1	1		902.226 MHz	6.36 dBm																									
M2	1		902.302 MHz	12.49 dBm																									
D3	M1	1	538.0 kHz	-0.09 dB																									
<p style="text-align: center;">25</p>	<p>Spectrum Ref Level 20.00 dBm Offset 1.00 dB RBW 100 kHz Att 35 dB SWT 19.1 μs VBW 300 kHz Mode Auto FFT Count 500/500</p> <p>IPK View</p> <p>CF 915.0 MHz 1001 pts Span 2.0 MHz</p> <table border="1"> <thead> <tr> <th>Type</th> <th>Ref</th> <th>Trc</th> <th>X-value</th> <th>Y-value</th> <th>Function</th> <th>Function Result</th> </tr> </thead> <tbody> <tr> <td>M1</td> <td>1</td> <td></td> <td>914.724 MHz</td> <td>5.40 dBm</td> <td></td> <td></td> </tr> <tr> <td>M2</td> <td>1</td> <td></td> <td>914.798 MHz</td> <td>11.69 dBm</td> <td></td> <td></td> </tr> <tr> <td>D3</td> <td>M1</td> <td>1</td> <td>542.0 kHz</td> <td>0.07 dB</td> <td></td> <td></td> </tr> </tbody> </table> <p>Date: 31.MAR.2020 20:38:18</p>	Type	Ref	Trc	X-value	Y-value	Function	Function Result	M1	1		914.724 MHz	5.40 dBm			M2	1		914.798 MHz	11.69 dBm			D3	M1	1	542.0 kHz	0.07 dB		
Type	Ref	Trc	X-value	Y-value	Function	Function Result																							
M1	1		914.724 MHz	5.40 dBm																									
M2	1		914.798 MHz	11.69 dBm																									
D3	M1	1	542.0 kHz	0.07 dB																									
<p style="text-align: center;">49</p>	<p>Spectrum Ref Level 20.00 dBm Offset 1.00 dB RBW 100 kHz Att 35 dB SWT 19.1 μs VBW 300 kHz Mode Auto FFT Count 500/500</p> <p>IPK View</p> <p>CF 927.5 MHz 1001 pts Span 2.0 MHz</p> <table border="1"> <thead> <tr> <th>Type</th> <th>Ref</th> <th>Trc</th> <th>X-value</th> <th>Y-value</th> <th>Function</th> <th>Function Result</th> </tr> </thead> <tbody> <tr> <td>M1</td> <td>1</td> <td></td> <td>927.226 MHz</td> <td>5.38 dBm</td> <td></td> <td></td> </tr> <tr> <td>M2</td> <td>1</td> <td></td> <td>927.302 MHz</td> <td>11.43 dBm</td> <td></td> <td></td> </tr> <tr> <td>D3</td> <td>M1</td> <td>1</td> <td>538.0 kHz</td> <td>0.04 dB</td> <td></td> <td></td> </tr> </tbody> </table> <p>Date: 31.MAR.2020 20:41:18</p>	Type	Ref	Trc	X-value	Y-value	Function	Function Result	M1	1		927.226 MHz	5.38 dBm			M2	1		927.302 MHz	11.43 dBm			D3	M1	1	538.0 kHz	0.04 dB		
Type	Ref	Trc	X-value	Y-value	Function	Function Result																							
M1	1		927.226 MHz	5.38 dBm																									
M2	1		927.302 MHz	11.43 dBm																									
D3	M1	1	538.0 kHz	0.04 dB																									

Appendix D: 99% Occupied Bandwidth

Type	Channel	99% Occupied Bandwidth(MHz)	Limit (kHz)	Result
2-GFSK	00	0.71	-	Pass
	25	0.72		
	49	0.72		

<p>00</p>	<p> Spectrum Ref Level 20.00 dBm Offset 1.00 dB RBW 30 kHz Att 35 dB SWT 63.3 μs VBW 100 kHz Mode Auto FFT Count 500/500 IPK View M1 12.03 dBm 902.30020 MHz 709.290709291 kHz T1 T2 Occ Bw CF 902.5 MHz 1001 pts Span 2.0 MHz Date: 31.MAR.2020 20:28:53 </p>
<p>25</p>	<p> Spectrum Ref Level 20.00 dBm Offset 1.00 dB RBW 30 kHz Att 35 dB SWT 63.3 μs VBW 100 kHz Mode Auto FFT Count 500/500 IPK View M1 11.59 dBm 914.80020 MHz 715.284715285 kHz T1 T2 Occ Bw CF 915.0 MHz 1001 pts Span 2.0 MHz Date: 31.MAR.2020 20:38:26 </p>
<p>49</p>	<p> Spectrum Ref Level 20.00 dBm Offset 1.00 dB RBW 30 kHz Att 35 dB SWT 63.3 μs VBW 100 kHz Mode Auto FFT Count 500/500 IPK View M1 11.24 dBm 927.30020 MHz 719.280719281 kHz T1 T2 Occ Bw CF 927.5 MHz 1001 pts Span 2.0 MHz Date: 31.MAR.2020 20:41:26 </p>

Appendix E: Duty cycle

Test Frequency (MHz)	T _{on} time for single burst (ms)	T _{period} (ms)	Duty cycle	1/T _{on} time (kHz)
915	1	1	100%	1.0

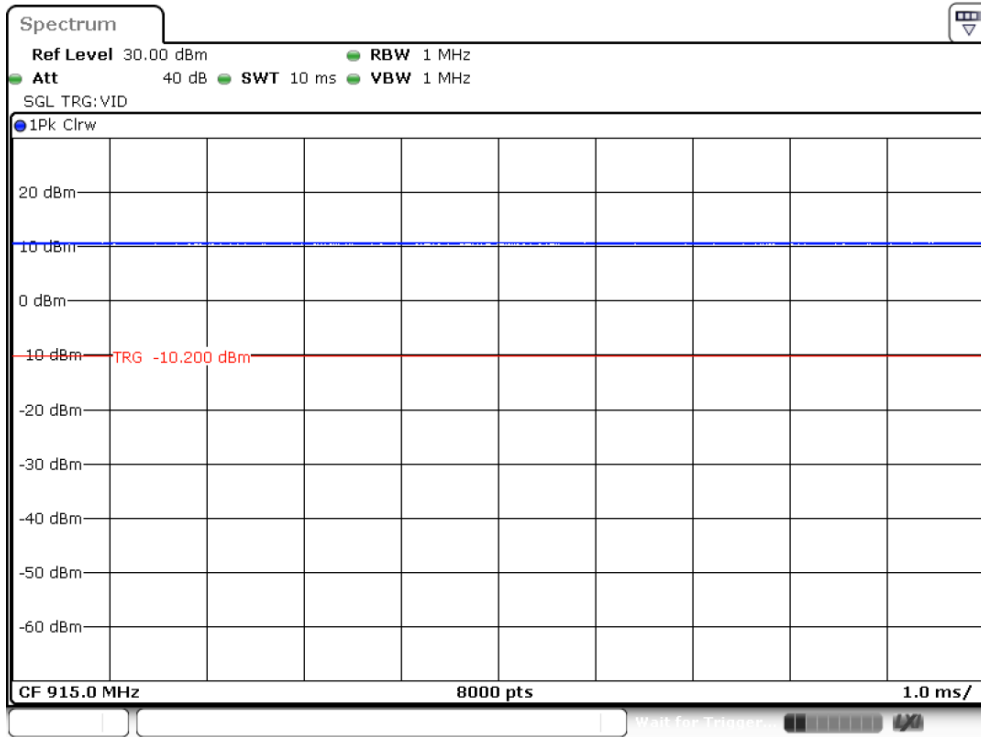

Date: 31.MAR.2020 20:36:39

Appendix F: Band edge and Spurious Emissions (conducted)

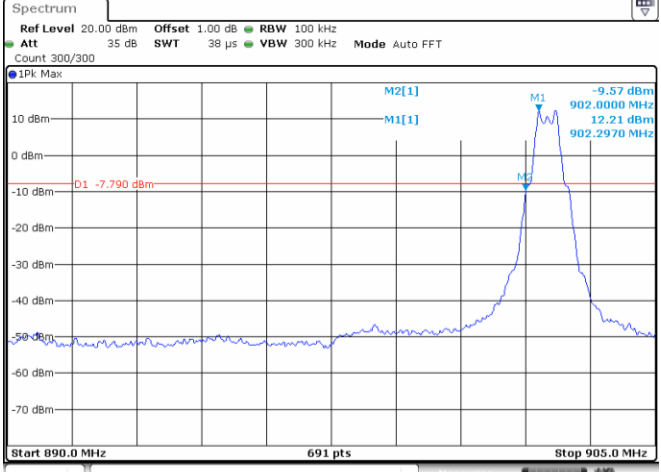
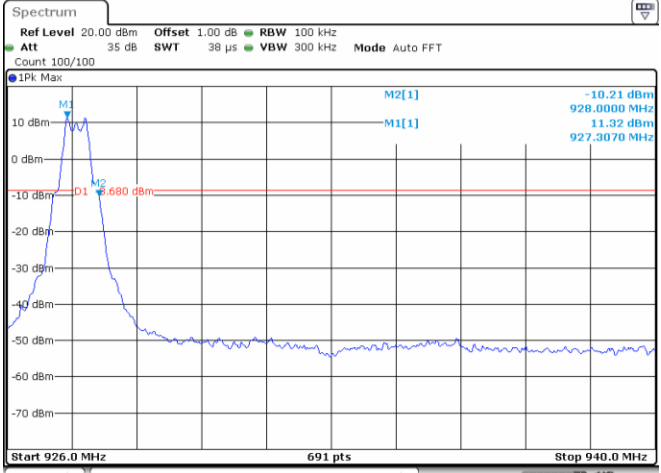
Test Item:	Band edge
00	 <p> Spectrum Ref Level 20.00 dBm Offset 1.00 dB RBW 100 kHz Att 35 dB SWT 38 μs VBW 300 kHz Mode Auto FFT Count 300/300 1Pk Max M2[1] -9.57 dBm 902.0000 MHz M1[1] 12.21 dBm 902.2970 MHz D1 -7.790 dBm Start 890.0 MHz 691 pts Stop 905.0 MHz Date: 31.MAR.2020 20:30:27 </p>
49	 <p> Spectrum Ref Level 20.00 dBm Offset 1.00 dB RBW 100 kHz Att 35 dB SWT 38 μs VBW 300 kHz Mode Auto FFT Count 100/100 1Pk Max M2[1] -10.21 dBm 928.0000 MHz M1[1] 11.32 dBm 927.3070 MHz D1 -6.680 dBm Start 926.0 MHz 691 pts Stop 940.0 MHz Date: 31.MAR.2020 20:42:50 </p>

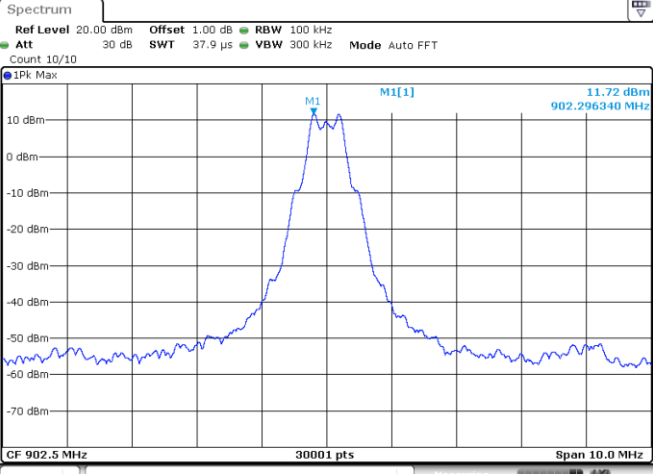
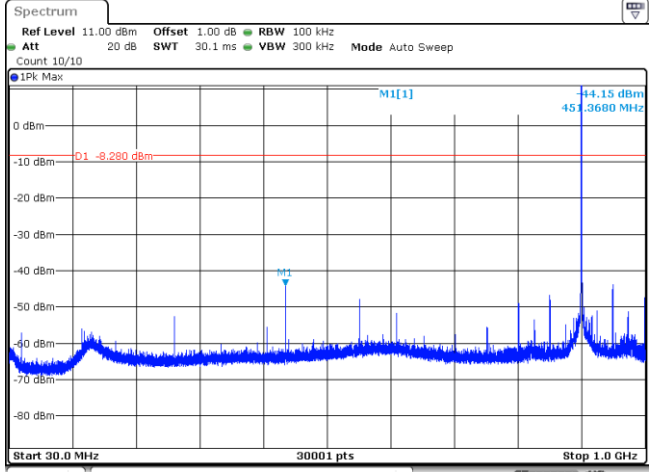
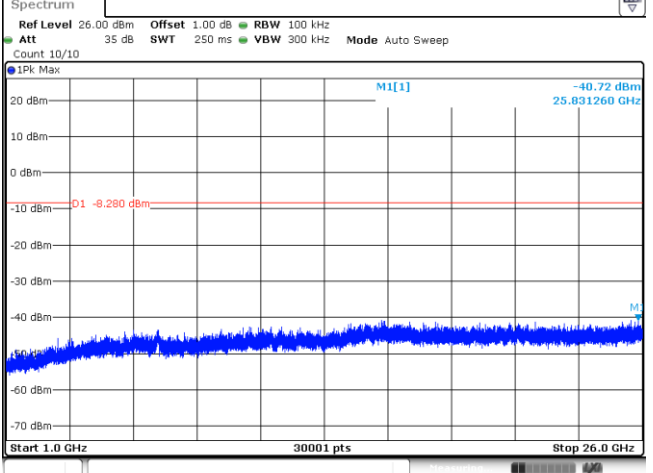
Test Item:	SE
<p>00 Reference level</p>	 <p>CF 902.5 MHz 30001 pts Span 10.0 MHz</p> <p>Date: 31.MAR.2020 20:32:16</p>
<p>00 30MHz~1000MHz</p>	 <p>Start 30.0 MHz 30001 pts Stop 1.0 GHz</p> <p>Date: 31.MAR.2020 20:33:13</p>
<p>00 1GHz~26GHz</p>	 <p>Start 1.0 GHz 30001 pts Stop 26.0 GHz</p> <p>Date: 31.MAR.2020 20:33:29</p>

25
Reference level

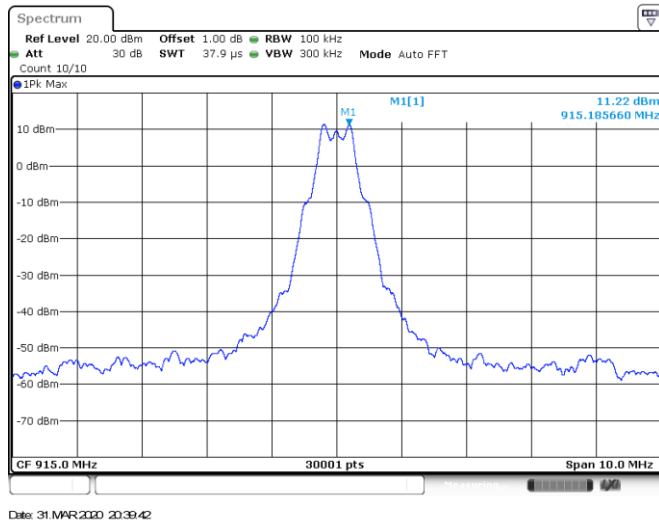

Date: 31.MAR.2020 20:39:42

25
30MHz~1000MHz

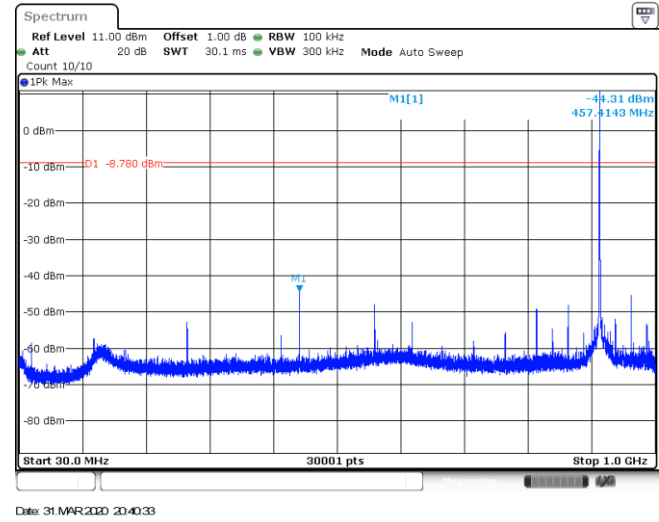

Date: 31.MAR.2020 20:40:33

25
1GHz~26GHz

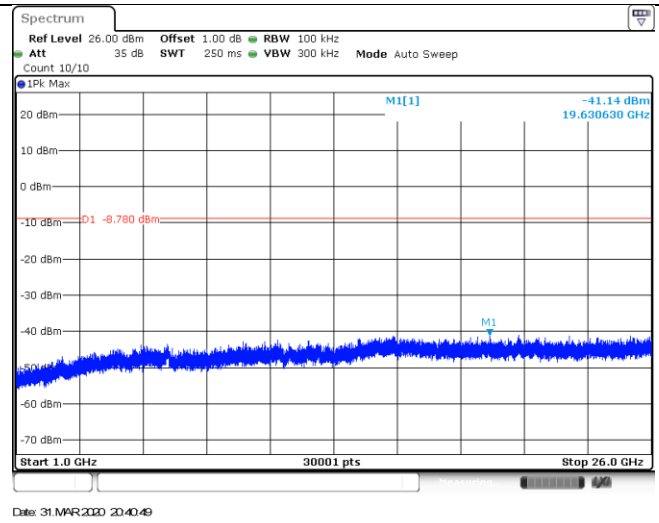

Date: 31.MAR.2020 20:40:49

<p>49 Reference level</p>	<p>Spectrum Ref Level 20.00 dBm Offset 1.00 dB RBW 100 kHz Att 30 dB SWT 37.9 μs VBW 300 kHz Mode Auto FFT Count 10/10 1Pk Max 11.15 dBm 927.299010 MHz CF 927.5 MHz 30001 pts Span 10.0 MHz Date: 31.MAR.2020 20:43:49</p>
<p>49 30MHz~1000MHz</p>	<p>Spectrum Ref Level 11.00 dBm Offset 1.00 dB RBW 100 kHz Att 20 dB SWT 30.1 ms VBW 300 kHz Mode Auto Sweep Count 10/10 1Pk Max -44.63 dBm 463.8487 MHz -8.850 dBm Start 30.0 MHz 30001 pts Stop 1.0 GHz Date: 31.MAR.2020 20:44:27</p>
<p>49 1GHz~26GHz</p>	<p>Spectrum Ref Level 26.00 dBm Offset 1.00 dB RBW 100 kHz Att 35 dB SWT 250 ms VBW 300 kHz Mode Auto Sweep Count 10/10 1Pk Max -40.08 dBm 15.166610 GHz -8.850 dBm Start 1.0 GHz 30001 pts Stop 26.0 GHz Date: 31.MAR.2020 20:44:43</p>

-----End of Report-----