

# TEST REPORT

**Product Name** : Robot Vacuum Cleaner  
R530,R530W,R530B,R530L,R530Y,R530O,R53  
**Model Number** : 0G,R530P,Q4,Q6 Lite,L1,L1+,L1 pro,L2,L2+,L2  
pro  
**FCC ID** : 2AT7JR530

**Prepared for** : Shenzhen Free Dynamic Development Co., LTD.  
**Address** : 402,Kingson Building,No.1 ChuangSheng Road,xili  
street,Nanshan District,shenzhen,China

**Prepared by** : EMTEK (SHENZHEN) CO., LTD.  
**Address** : Building 69, Majialong Industry Zone, Nanshan District,  
Shenzhen, Guangdong, China

Tel: (0755) 26954280  
Fax: (0755) 26954282

**Report Number** : ES210611062W  
**Date(s) of Tests** : Jun 17,2021 to Jul 9,2021  
**Date of issue** : Jul 26,2021

## TABLE OF CONTENTS

<b>1</b>	<b>TEST RESULT CERTIFICATION .....</b>	<b>3</b>
<b>2</b>	<b>EUT TECHNICAL DESCRIPTION .....</b>	<b>4</b>
<b>3</b>	<b>SUMMARY OF TEST RESULT .....</b>	<b>5</b>
<b>4</b>	<b>TEST METHODOLOGY .....</b>	<b>6</b>
4.1	GENERAL DESCRIPTION OF APPLIED STANDARDS .....	6
4.2	MEASUREMENT EQUIPMENT USED .....	6
4.3	DESCRIPTION OF TEST MODES .....	7
<b>5</b>	<b>FACILITIES AND ACCREDITATIONS .....</b>	<b>8</b>
5.1	FACILITIES.....	8
5.2	LABORATORY ACCREDITATIONS AND LISTINGS .....	8
<b>6</b>	<b>TEST SYSTEM UNCERTAINTY .....</b>	<b>9</b>
<b>7</b>	<b>SETUP OF EQUIPMENT UNDER TEST .....</b>	<b>10</b>
7.1	RADIO FREQUENCY TEST SETUP 1.....	10
7.2	RADIO FREQUENCY TEST SETUP 2.....	10
7.3	CONDUCTED EMISSION TEST SETUP .....	11
7.4	BLOCK DIAGRAM CONFIGURATION OF TEST SYSTEM.....	12
7.5	SUPPORT EQUIPMENT.....	12
<b>8</b>	<b>TEST REQUIREMENTS.....</b>	<b>13</b>
8.1	DTS (6DB) BANDWIDTH.....	13
8.2	MAXIMUM PEAK CONDUCTED OUTPUT POWER .....	20
8.3	MAXIMUM POWER SPECTRAL DENSITY .....	24
8.4	UNWANTED EMISSIONS IN NON-RESTRICTED FREQUENCY BANDS.....	31
8.5	RADIATED SPURIOUS EMISSION .....	36
8.6	CONDUCTED EMISSIONS TEST .....	48
8.7	ANTENNA APPLICATION .....	51

# 1 TEST RESULT CERTIFICATION

Applicant : Shenzhen Free Dynamic Development Co., LTD.  
 Address : 402,Kingson Building,No.1 ChuangSheng Road,xili street,Nanshan District,shenzhen,China  
 Manufacturer : Shenzhen Free Dynamic Development Co., LTD.  
 Address : 402,Kingson Building,No.1 ChuangSheng Road,xili street,Nanshan District,shenzhen,China  
 EUT : Robot Vacuum Cleaner  
 Model Name : R530,R530W,R530B,R530L,R530Y,R530O,R530G,R530P,Q4,Q6 Lite,L1,L1+,L1 pro,L2,L2+,L2 pro  
 Trademark : N/A

Measurement Procedure Used:

APPLICABLE STANDARDS	
STANDARD	TEST RESULT
FCC 47 CFR Part 2 , Subpart J FCC 47 CFR Part 15 , Subpart C	PASS

The above equipment was tested by EMTEK (SHENZHEN) CO., LTD. The test data, data evaluation, test procedures, and equipment configurations shown in this report were made in accordance with the procedures given in ANSI C63.10 (2013) and the energy emitted by the sample EUT tested as described in this report is in compliance with the requirements of FCC Rules Part 2 and Part 15.247

The test results of this report relate only to the tested sample identified in this report.

Date of Test : Jun 17,2021 to Jul 9,2021

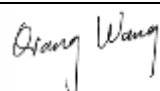
Prepared by :   
 Qiang Wang /Editor

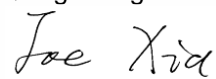
Reviewer :   
 Joe Xia/Editor

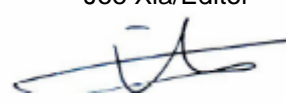
Approve & Authorized Signer :   
 Lisa Wang/Manager



## 2 EUT TECHNICAL DESCRIPTION

Characteristics	Description
Product	Robot Vacuum Cleaner
Model Number	R530,R530W,R530B,R530L,R530Y,R530O,R530G,R530P,Q4,Q6 Lite,L1,L1+,L1 pro,L2,L2+,L2 pro (The test data is gathered from a production sample,provided by the manufacturer.The appearance of others models listed in the report is different from main-test model R530,but the circuit and the electronic construction do not change, declared by the manufacturer. We prepare R530 for test)
IEEE 802.11 WLAN Mode Supported	<input checked="" type="checkbox"/> 802.11b <input checked="" type="checkbox"/> 802.11g <input checked="" type="checkbox"/> 802.11n(20MHz channel bandwidth) <input checked="" type="checkbox"/> 802.11n(40MHz channel bandwidth)
Data Rate	802.11 b:1,2,5.5,11Mbps; 802.11 g:6,9,12,18,24,36,48,54Mbps; 802.11n(HT20): up to 72.2Mbps; 802.11n(HT40): up to 150Mbps;
Modulation	DSSS with DBPSK/DQPSK/CCK for 802.11b; OFDM with BPSK/QPSK/16QAM/64QAM for 802.11g/n;
Operating Frequency Range	<input checked="" type="checkbox"/> 2412-2462MHz for 802.11b/g/n(HT20); <input checked="" type="checkbox"/> 2422-2452MHz for 802.11n(HT40);
Number of Channels	<input checked="" type="checkbox"/> 11 channels for 802.11b/g n(HT20); <input checked="" type="checkbox"/> 7 Channels for 802.11n(HT40);
Transmit Power Max	16.43 dBm
Antenna Type	Integral Antenna
Antenna Gain	5.2 dBi
Power Supply	DC 19V from adapter; DC 14.8V from Battery
Test Voltage	AC 120V/60Hz
Adapter1	Model No:GQ12-190060-AU Input:100-240V 50/60Hz 0.4A Max Output:DC 19V 600mA
Adapter2	Model No:DBS012A-1900600U Input:100-240V 50/60Hz 0.35A Max Output:DC 19V 0.6A 11.4W

**Note:** for more details, please refer to the User's manual of the EUT.

### 3 SUMMARY OF TEST RESULT

FCC PartClause	Test Parameter	Verdict	Remark
15.247(a)(2)	DTS (6dB) Bandwidth	PASS	
15.247(b)(3)	Maximum Peak Conducted Output Power	PASS	
15.247(e)	Maximum Power Spectral Density Level	PASS	
15.247(d)	Unwanted Emission Into Non-Restricted Frequency Bands	PASS	
15.247(d) 15.209	Unwanted Emission Into Restricted Frequency Bands (conducted)	PASS	
15.247(d) 15.209	Radiated Spurious Emission	PASS	
15.207	Conducted EmissionTest	PASS	
15.247(b)	Antenna Application	PASS	
	NOTE1:N/A (Not Applicable) NOTE2: According to FCC OET KDB 558074, the report use radiated measurements in the restricted frequency bands. In addition, the radiated test is also performed to ensure the emissions emanating from the device cabinet also comply with the applicable limits.		

#### RELATED SUBMITTAL(S) / GRANT(S):

This submittal(s) (test report) is intended for FCC ID: 2AT7JR530 filing to comply with Section 15.247 of the FCC Part 15, Subpart C Rules.

## 4 TEST METHODOLOGY

### 4.1 GENERAL DESCRIPTION OF APPLIED STANDARDS

According to its specifications, the EUT must comply with the requirements of the following standards:  
 FCC 47 CFR Part 2, Subpart J  
 FCC 47 CFR Part 15, Subpart C  
 FCC KDB 558074 D01 15.247 Meas Guidance v05r02

### 4.2 MEASUREMENT EQUIPMENT USED

#### 4.2.1 Conducted Emission Test Equipment

EQUIPMENT TYPE	MFR	MODEL NUMBER	SERIAL NUMBER	LASTCAL.
Test Receiver	Rohde & Schwarz	ESCS30	828985/018	May 15, 2021
L.I.S.N.	Schwarzbeck	NNLK8129	8129203	May 15, 2021
50Ω Coaxial Switch	Anritsu	MP59B	M20531	May 15, 2021
Pulse Limiter	Rohde & Schwarz	ESH3-Z2	100006	May 15, 2021
Voltage Probe	Rohde & Schwarz	TK9416	N/A	May 15, 2021
I.S.N	Rohde & Schwarz	ENY22	1109.9508.02	May 15, 2021

#### 4.2.2 Radiated Emission Test Equipment

EQUIPMENT TYPE	MFR	MODEL NUMBER	SERIAL NUMBER	LAST CAL.
EMI Test Receiver	Rohde & Schwarz	ESU	1302.6005.26	May 15, 2021
Pre-Amplifier	HP	8447D	2944A07999	May 15, 2021
Bilog Antenna	Schwarzbeck	VULB9163	142	May 15, 2021
Loop Antenna	ARA	PLA-1030/B	1029	May 15, 2021
Horn Antenna	Schwarzbeck	BBHA 9170	BBHA9170399	May 15, 2021
Horn Antenna	Schwarzbeck	BBHA 9120	D143	May 15, 2021
Cable	Schwarzbeck	AK9513	ACRX1	May 15, 2021
Cable	Rosenberger	N/A	FP2RX2	May 15, 2021
Cable	Schwarzbeck	AK9513	CRPX1	May 15, 2021
Cable	Schwarzbeck	AK9513	CRRX2	May 15, 2021

#### 4.2.3 Radio Frequency Test Equipment

EQUIPMENT TYPE	MFR	MODEL NUMBER	SERIAL NUMBER	LASTCAL.
Spectrum Analyzer	Agilent	E4407B	88156318	May 15, 2021
Signal Analyzer	Agilent	N9010A	My53470879	May 15, 2021
Power meter	Anritsu	ML2495A	0824006	May 15, 2021
Power sensor	Anritsu	MA2411B	0738172	May 15, 2021

**Remark:** Each piece of equipment is scheduled for calibration once a year.

### 4.3 DESCRIPTION OF TEST MODES

The EUT has been tested under its typical operating condition.

The EUT configuration for testing is installed on RF field strength measurement to meet the Commissions requirement and operating in a manner which intends to maximize its emission characteristics in a continuous normal application.

The Transmitter was operated in the normal operating mode. The TX frequency was fixed which was for the purpose of the measurements.

Test of channel included the lowest and middle and highest frequency to perform the test, then record on this report.

Those data rates (802.11b:1 Mbps; 802.11g: 6 Mbps; 802.11n(HT20): MCS0; 802.11n(HT40): MCS0) were used for all test.

Pre-defined engineering program for regulatory testing used to control the EUT for staying in continuous transmitting and receiving mode is programmed.

Frequency and Channel list for 802.11b/g/n (HT20):

Channel	Frequency (MHz)	Channel	Frequency (MHz)	Channel	Frequency (MHz)
1	2412	6	2437	11	2462
2	2417	7	2442		
3	2422	8	2447		
4	2427	9	2452		
5	2432	10	2457		

Frequency and Channel list for 802.11n (HT40):

Channel	Frequency (MHz)	Channel	Frequency (MHz)	Channel	Frequency (MHz)
		6	2437		
		7	2442		
3	2422	8	2447		
4	2427	9	2452		
5	2432				

Test Frequency and Channel for 802.11b/g/n (HT20):

Lowest Frequency		Middle Frequency		Highest Frequency	
Channel	Frequency (MHz)	Channel	Frequency (MHz)	Channel	Frequency (MHz)
1	2412	6	2437	11	2462

Test Frequency and channel for 802.11n (HT40):

Lowest Frequency		Middle Frequency		Highest Frequency	
Channel	Frequency (MHz)	Channel	Frequency (MHz)	Channel	Frequency (MHz)
3	2422	6	2437	9	2452

## 5 FACILITIES AND ACCREDITATIONS

### 5.1 FACILITIES

All measurement facilities used to collect the measurement data are located at

Bldg 69, Majialong Industry Zone District, Nanshan District, Shenzhen, China

The sites are constructed in conformance with the requirements of ANSI C63.7, ANSI C63.10 and CISPR Publication 22.

### 5.2 LABORATORY ACCREDITATIONS AND LISTINGS

Site Description

EMC Lab.

: **Accredited by CNAS**

The Certificate Registration Number is L2291.

The Laboratory has been assessed and proved to be in compliance with CNAS-CL01 (identical to ISO/IEC 17025:2017)

**Accredited by FCC**

Designation Number: CN1204

Test Firm Registration Number: 882943

**Accredited by A2LA**

The Certificate Number is 4321.01.

**Accredited by Industry Canada**

The Conformity Assessment Body Identifier is CN0008

Name of Firm

: EMTEK (SHENZHEN) CO., LTD.

Site Location

: Building 69, Majialong Industry Zone,  
Nanshan District, Shenzhen, Guangdong, China



## 6 TEST SYSTEM UNCERTAINTY

The following measurement uncertainty levels have been estimated for tests performed on the apparatus:

Parameter	Uncertainty
Radio Frequency	$\pm 1 \times 10^{-5}$
Maximum Peak Output Power Test	$\pm 1.0\text{dB}$
Conducted Emissions Test	$\pm 2.0\text{dB}$
Radiated Emission Test	$\pm 2.0\text{dB}$
Power Density	$\pm 2.0\text{dB}$
Occupied Bandwidth Test	$\pm 1.0\text{dB}$
Band Edge Test	$\pm 3\text{dB}$
All emission, radiated	$\pm 3\text{dB}$
Antenna Port Emission	$\pm 3\text{dB}$
Temperature	$\pm 0.5^\circ\text{C}$
Humidity	$\pm 3\%$

Measurement Uncertainty for a level of Confidence of 95%

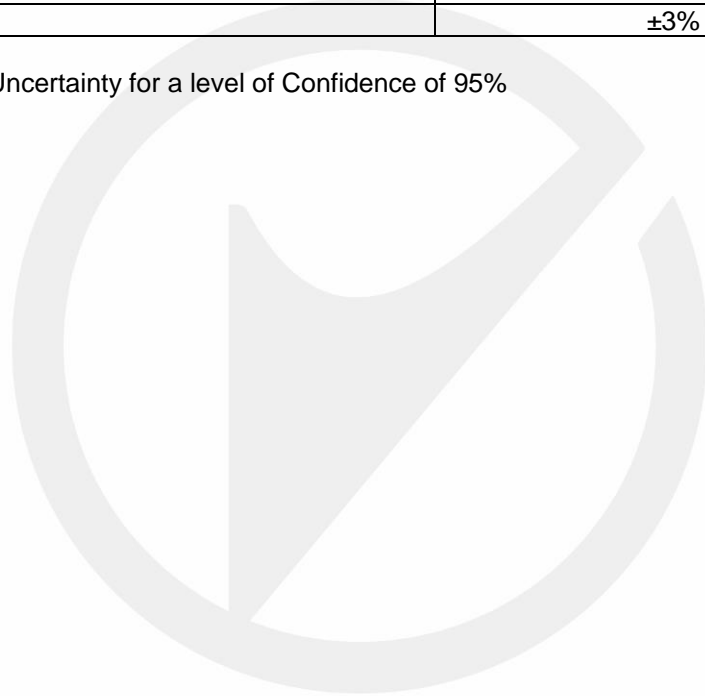

## 7 SETUP OF EQUIPMENT UNDER TEST

### 7.1 RADIO FREQUENCY TEST SETUP 1

The WLAN component's antenna ports(s) of the EUT are connected to the measurement instrument per an appropriate attenuator. The EUT is controlled by PC/software to emit the specified signals for the purpose of measurements.

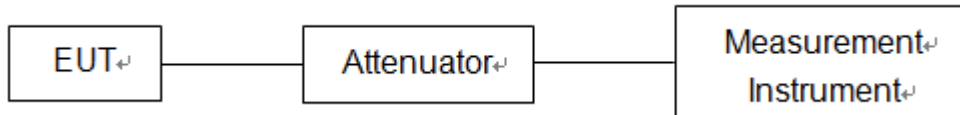

### 7.2 RADIO FREQUENCY TEST SETUP 2

The test site semi-anechoic chamber has met the requirement of NSA tolerance 4 dB according to the standards: ANSI C63.10. The test distance is 3m. The setup is according to the requirements in Section 13.1.4.1 of ANSI C63.10-2013 and CAN/CSA-CEI/IEC CISPR 22.

Below 30MHz:

The EUT is placed on a turntable 0.8 meters above the ground in the chamber, 3 meter away from the antenna (loop antenna). The Antenna should be positioned with its plane vertical at the specified distance from the EUT and rotated about its vertical axis for maximum response at each azimuth about the EUT. The center of the loop shall be 1 m above the ground. For certain applications, the loop antenna plane may also need to be positioned horizontally at the specified distance from the EUT.

30MHz-1GHz:

The EUT is placed on a turntable 0.8 meters above the ground in the chamber, 3 meter away from the antenna. The maximal emission value is acquired by adjusting the antenna height, polarisation and turntable azimuth. Normally, the height range of antenna is 1 m to 4 m, the azimuth range of turntable is 0° to 360°, and the receive antenna has two polarizations Vertical (V) and Horizontal (H).

Above 1GHz:

The EUT is placed on a turntable 1.5 meters above the ground in the chamber, 3 meter away from the antenna. The maximal emission value is acquired by adjusting the antenna height, polarisation and turntable azimuth. Normally, the height range of antenna is 1 m to 4 m, the azimuth range of turntable is 0° to 360°, and the receive antenna has two polarizations Vertical (V) and Horizontal (H).

(a) Radiated Emission Test Set-Up, Frequency Below 30MHz

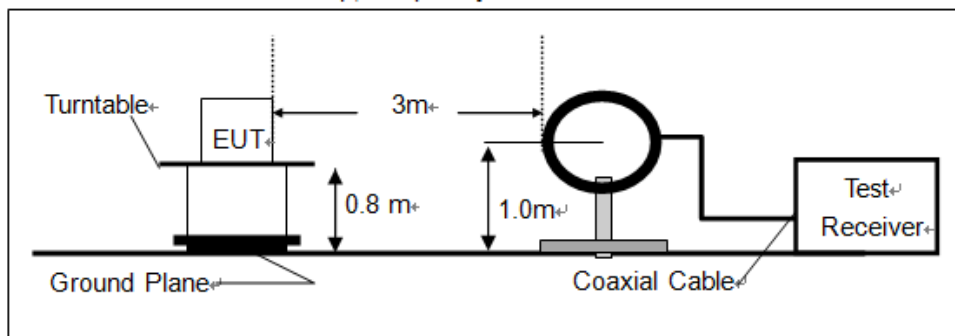

(b) Radiated Emission Test Set-Up, Frequency Below 1000MHz

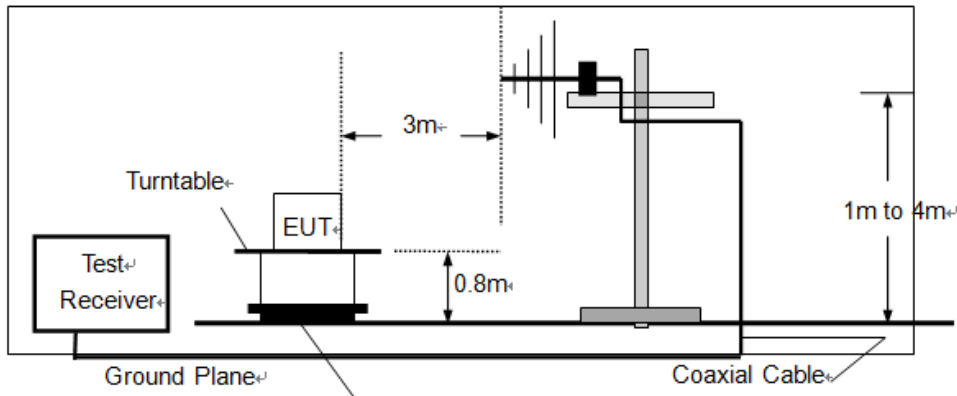

(c) Radiated Emission Test Set-Up, Frequency above 1000MHz

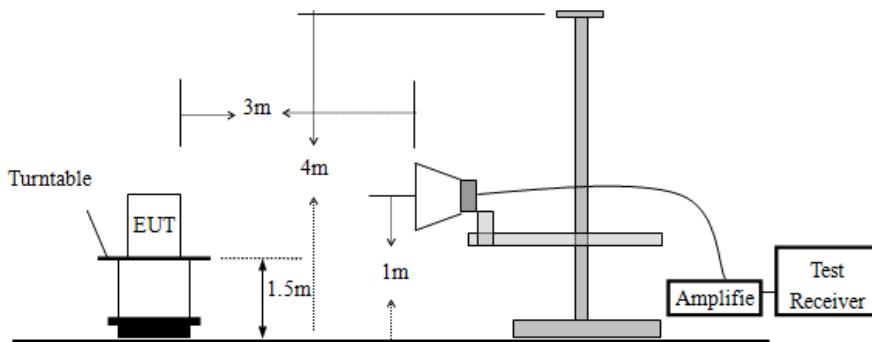

### 7.3 CONDUCTED EMISSION TEST SETUP

The mains cable of the EUT (maybe per AC/DC Adapter) must be connected to LISN. The LISN shall be placed 0.8 m from the boundary of EUT and bonded to a ground reference plane for LISN mounted on top of the ground reference plane. This distance is between the closest points of the LISN and the EUT. All other units of the EUT and associated equipment shall be at least 0.8m from the LISN.

Ground connections, where required for safety purposes, shall be connected to the reference ground point of the LISN and, where not otherwise provided or specified by the manufacturer, shall be of same length as the mains cable and run parallel to the mains connection at a separation distance of not more than 0.1 m.

According to the requirements in Section 13.1.4.1 of ANSI C63.10-2013 Conducted emissions from the EUT measured in the frequency range between 0.15 MHz and 30 MHz using CISPR Quasi-Peak and average detector mode.

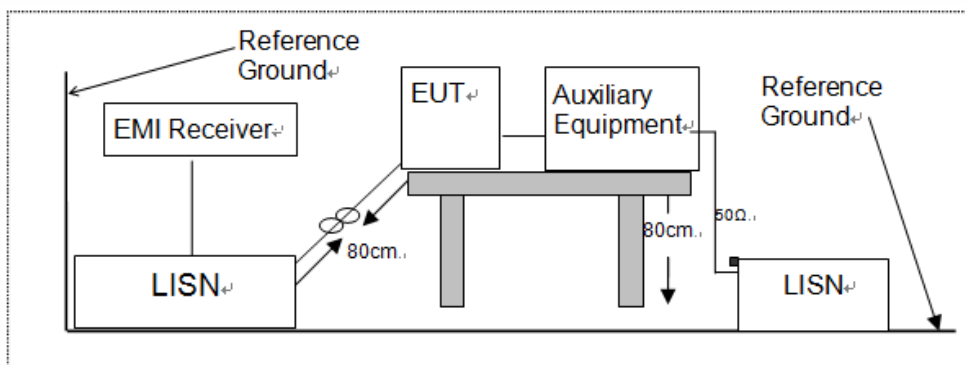

**7.4 BLOCK DIAGRAM CONFIGURATION OF TEST SYSTEM**

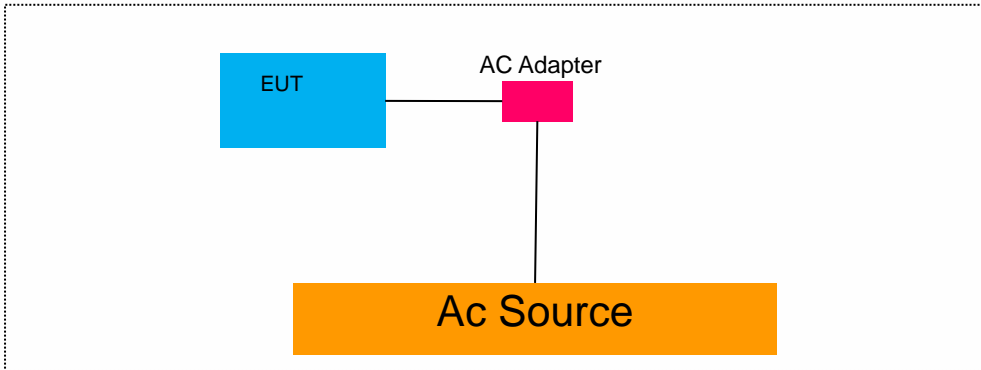

**7.5 SUPPORT EQUIPMENT**

EUT Cable List and Details			
Cable Description	Length (m)	Shielded/Unshielded	With / Without Ferrite
/	/	/	/
/	/	/	/

Auxiliary Cable List and Details			
Cable Description	Length (m)	Shielded/Unshielded	With / Without Ferrite
/	/	/	/

Auxiliary Equipment List and Details			
Description	Manufacturer	Model	Serial Number
/	/	/	/

**Notes:**

1. All the equipment/cables were placed in the worst-case configuration to maximize the emission during the test.
2. Grounding was established in accordance with the manufacturer's requirements and conditions for the intended use.
3. Unless otherwise denoted as EUT in [Remark] column, device(s) used in tested system is a support equipment

## 8 TEST REQUIREMENTS

### 8.1 DTS (6DB) BANDWIDTH

#### 8.1.1 Applicable Standard

According to FCC Part15.247 (a)(2) and KDB 558074 D01 15.247 Meas Guidance v05r02

#### 8.1.2 Conformance Limit

The minimum -6 dB bandwidth shall be at least 500 kHz.

#### 8.1.3 Test Configuration

Test according to clause 7.1 radio frequency test setup 1

#### 8.1.4 Test Procedure

The EUT was operating in IEEE 802.11b/g/n mode and controlled its channel. Printed out the test result from the spectrum by hard copy function.

The RF output of EUT was connected to the spectrum analyzer by RF cable and attenuator. The path loss was compensated to the results for each measurement.

Set to the maximum power setting and enable the EUT transmit continuously

Set RBW = 100 kHz.

Set the video bandwidth (VBW) =300kHz.

Set Span=2 times OBW

Set Detector = Peak.

Set Trace mode = max hold.

Set Sweep = auto couple.

Allow the trace to stabilize.

Measure the maximum width of the emission that is constrained by the frequencies associated with the two outermost amplitude points (upper and lower frequencies) that are attenuated by 6 dB relative to the maximum level measured in the fundamental emission.

Measure and record the results in the test report.

#### 8.1.5 Test Results

Temperature:	26° C
Relative Humidity:	54%
ATM Pressure:	1011 mbar

Operation Mode	Channel Number	Channel Frequency (MHz)	Measurement Bandwidth (MHz)	Limit (kHz)	Verdict
802.11b	1	2412	10.09	>500	PASS
	6	2437	10.09	>500	PASS
	11	2462	10.08	>500	PASS
802.11g	1	2412	16.39	>500	PASS
	6	2437	16.39	>500	PASS
	11	2462	16.39	>500	PASS
802.11n (HT20)	1	2412	17.64	>500	PASS
	6	2437	17.64	>500	PASS
	11	2462	17.64	>500	PASS
802.11n (HT40)	3	2422	36.11	>500	PASS
	6	2437	36.37	>500	PASS
	9	2452	35.37	>500	PASS

Test Model DTS (6dB) Bandwidth  
802.11b  
Channel 1: 2412MHz



Test Model DTS (6dB) Bandwidth  
802.11b  
Channel 6: 2437MHz



Test Model

DTS (6dB) Bandwidth  
802.11b  
Channel 11: 2462MHz



Test Model

DTS (6dB) Bandwidth  
802.11g  
Channel 1: 2412MHz

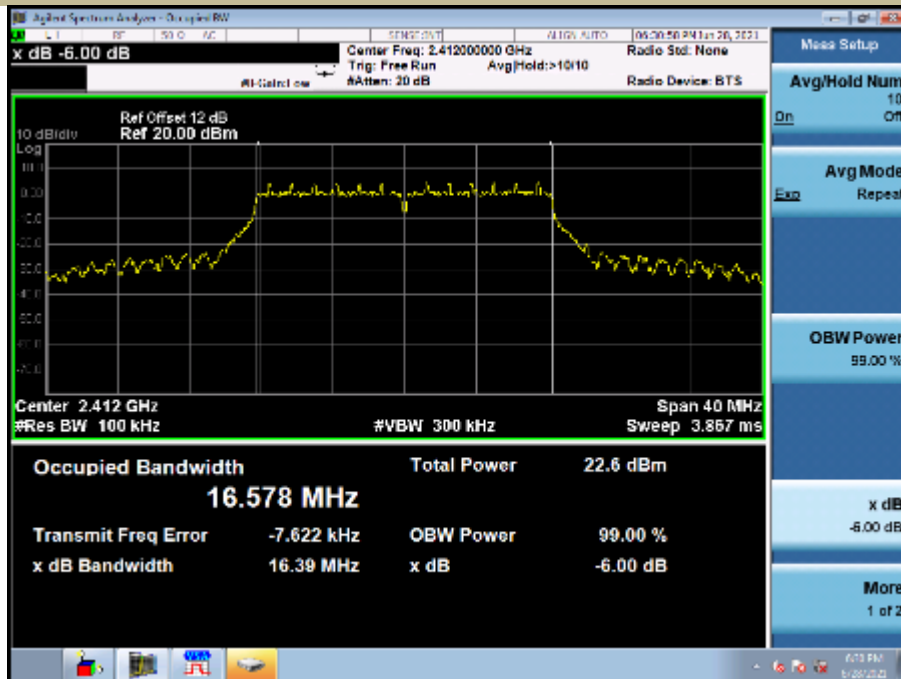

Test Model

DTS (6dB) Bandwidth  
802.11g  
Channel 6: 2437MHz

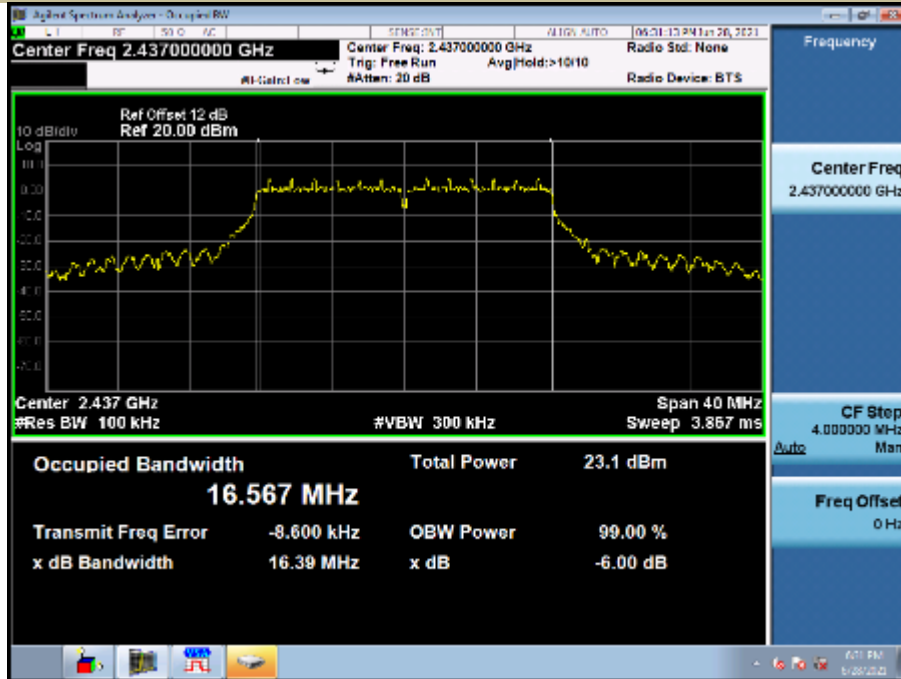

Test Model

DTS (6dB) Bandwidth  
802.11g  
Channel 11: 2462MHz





Test Model

DTS (6dB) Bandwidth  
802.11n (HT20)  
Channel 1: 2412MHz

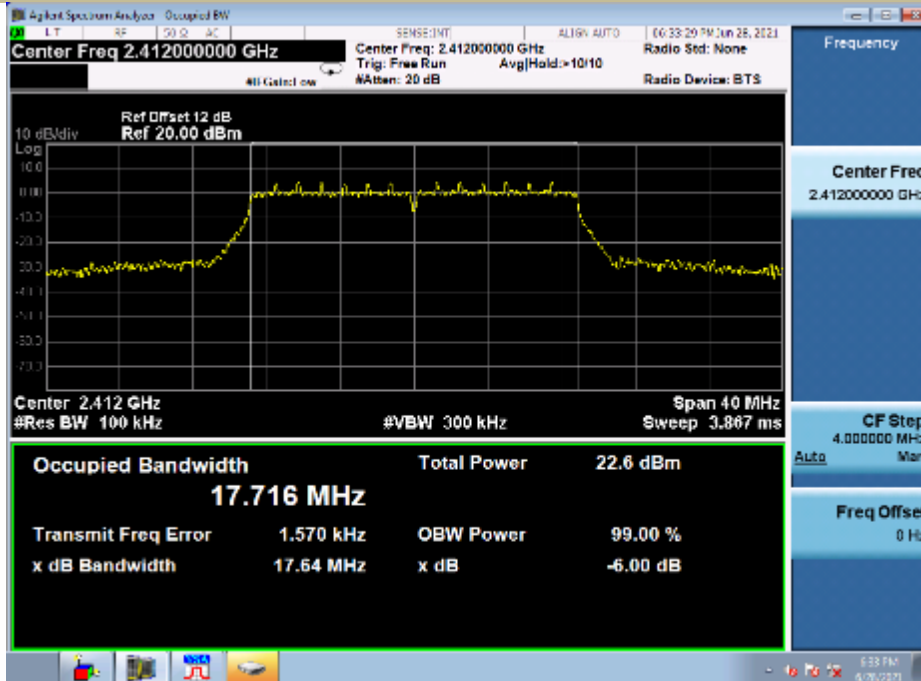

Test Model

DTS (6dB) Bandwidth  
802.11n (HT20)  
Channel 6: 2437MHz

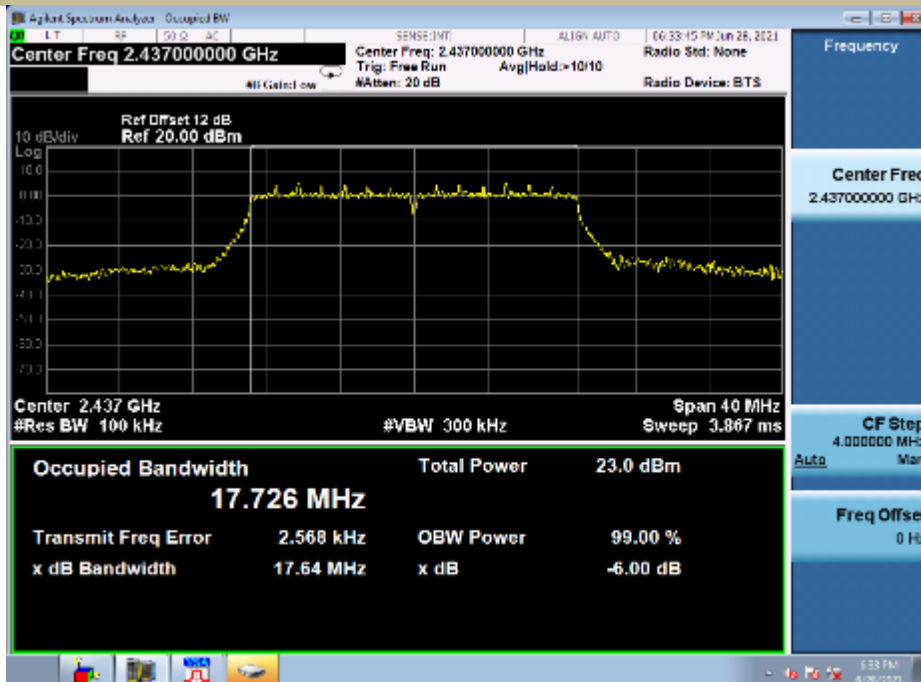

Test Model DTS (6dB) Bandwidth  
802.11n (HT20)  
Channel 11: 2462MHz

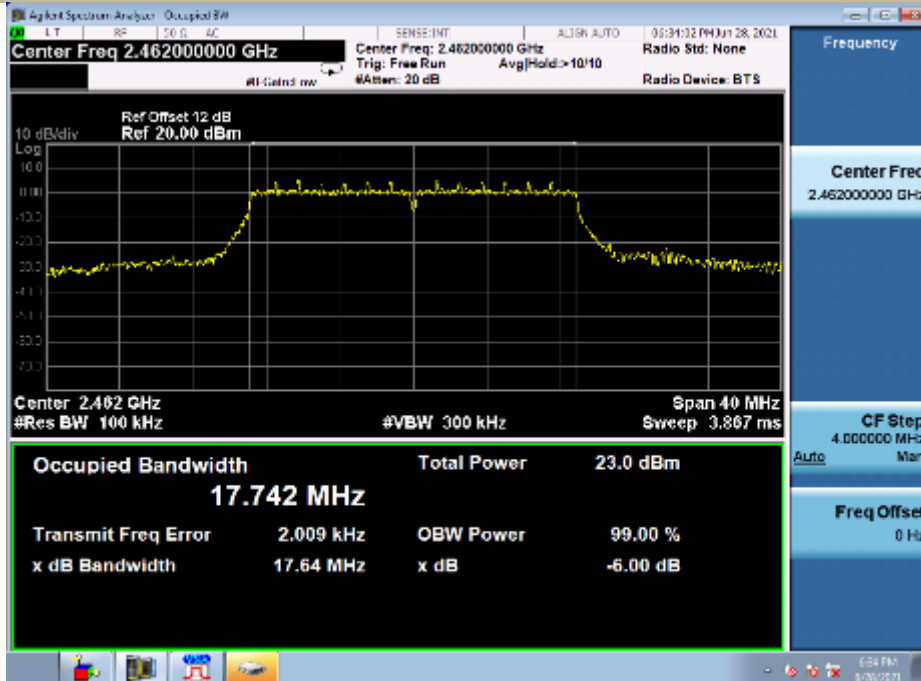

Test Model DTS (6dB) Bandwidth  
802.11n (HT40)  
Channel 3: 2422MHz

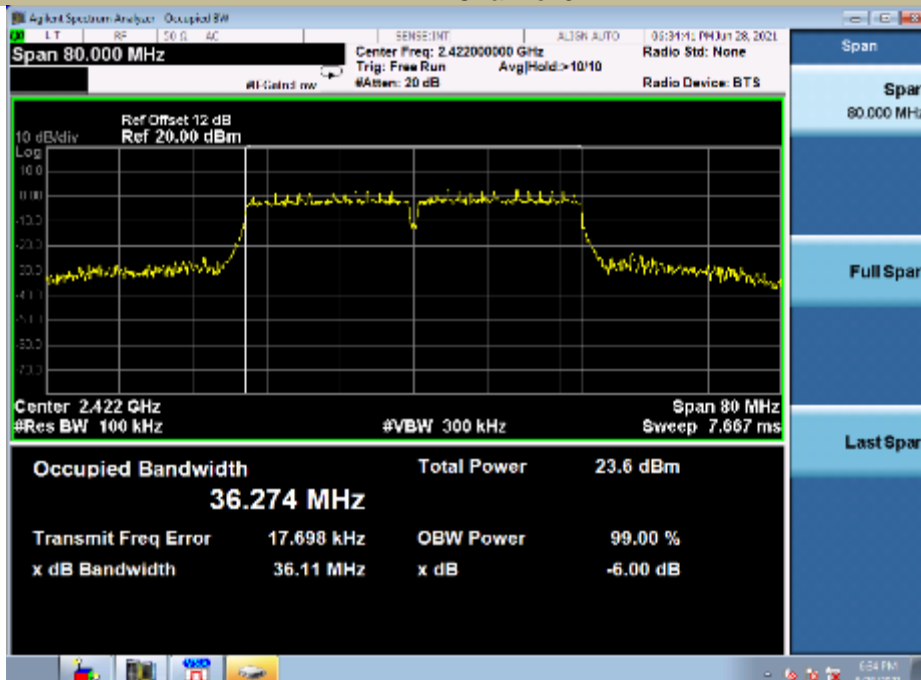

Test Model DTS (6dB) Bandwidth  
802.11n (HT40)  
Channel 6: 2437MHz

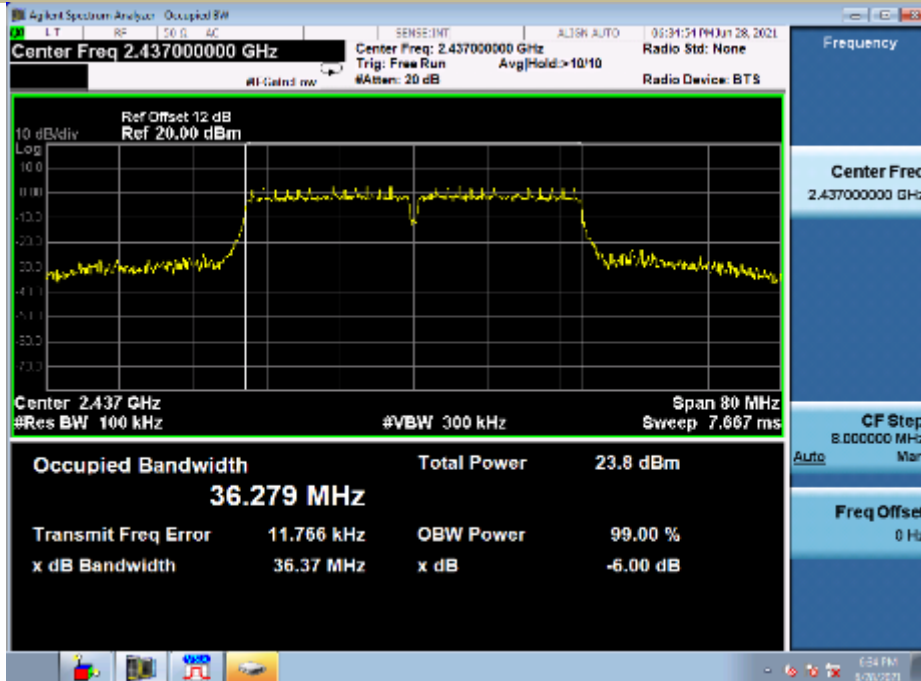

Test Model DTS (6dB) Bandwidth  
802.11n (HT40)  
Channel 9: 2452MHz

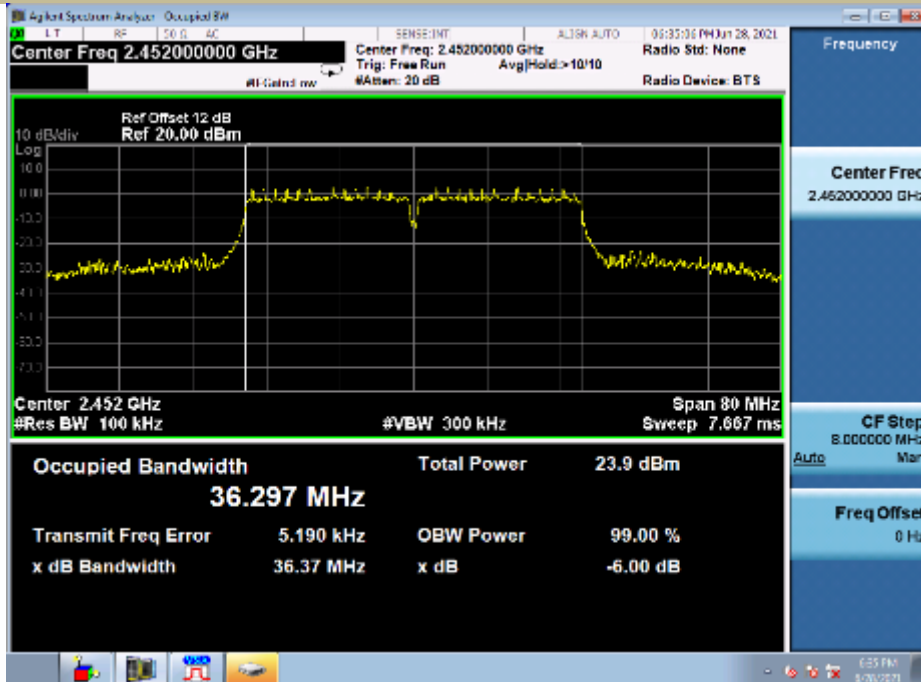

## 8.2 MAXIMUM PEAK CONDUCTED OUTPUT POWER

### 8.2.1 Applicable Standard

According to FCC Part15.247 (b)(3) and KDB 558074 D01 15.247 Meas Guidance v05r02

### 8.2.2 Conformance Limit

The maximum peak conducted output power of the intentional radiator for systems using digital modulation in the 2400 - 2483.5 MHz bands shall not exceed: 1 Watt (30dBm).

### 8.2.3 Test Configuration

Test according to clause 7.1 radio frequency test setup 1

### 8.2.4 Test Procedure

#### ■ According to FCC Part15.247(b)(3)

The maximum peak conducted output power may be measured using a broadband peak RF power meter. The power meter shall have a video bandwidth that is greater than or equal to the DTS bandwidth and shall utilize a fast-responding diode detector.

The testing follows FCC public Notice DA 00-705 Measurement Guidelines.

The RF output of EUT was connected to the power meter by RF cable and attenuator. The path loss was compensated to the results for each measurement.

Set to the maximum output power setting and enable the EUT transmit continuously.

Measure the conducted output power with cable loss and record the results in the test report.

Measure and record the results in the report.

#### ■ According to FCC Part 15.247(b)(4):

Conducted output power limit specified in paragraph (b) of this section is based on the use of antennas with directional gains that do not exceed 6 dBi. If transmitting antennas of directional gain greater than 6 dBi are used, the conducted output power from the intentional radiator shall be reduced below the stated values in paragraphs (b)(3) of this section, as appropriate, by the amount in dB that the directional gain of the antenna exceeds 6 dBi.

Note: If antenna Gain exceeds 6 dBi, then Output power Limit=30-(Gain- 6)

### 8.2.5 Test Results

Temperature:	26° C
Relative Humidity:	54%
ATM Pressure:	1011 mbar

Operation Mode	Channel Number	Channel Frequency (MHz)	Measurement Level (dBm)	Limit (dBm)	Verdict
802.11b	1	2412	14.71	30	PASS
	6	2437	15.29	30	PASS
	11	2462	15.19	30	PASS
802.11g	1	2412	15.29	30	PASS
	6	2437	15.82	30	PASS
	11	2462	15.80	30	PASS
802.11n (HT20)	1	2412	15.42	30	PASS
	6	2437	15.95	30	PASS
	11	2462	15.90	30	PASS
802.11n (HT40)	3	2422	16.09	30	PASS
	6	2437	16.36	30	PASS
	9	2452	16.43	30	PASS

Note:

802.11b Duty cycle factor= $10\log(1/\text{duty cycle})=0.03\text{db}$

802.11g Duty cycle factor= $10\log(1/\text{duty cycle})=0.28\text{db}$

802.11n(HT20) Duty cycle factor= $10\log(1/\text{duty cycle})=0.08\text{db}$

802.11n(HT40) Duty cycle factor= $10\log(1/\text{duty cycle})=0.20\text{db}$

Test Model Duty cycle 802.11b  
802.11b  
Channel 6: 2437MHz



Test Model Duty cycle 802.11g  
802.11g  
Channel 6: 2437MHz

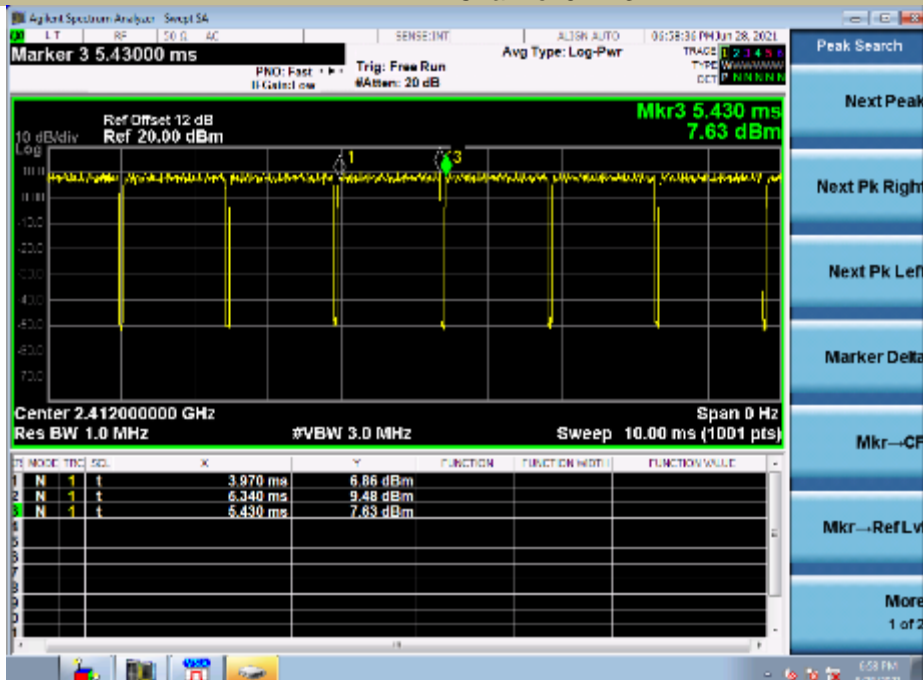

Test Model

Duty cycle  
802.11n(HT20)  
Channel 6: 2437MHz

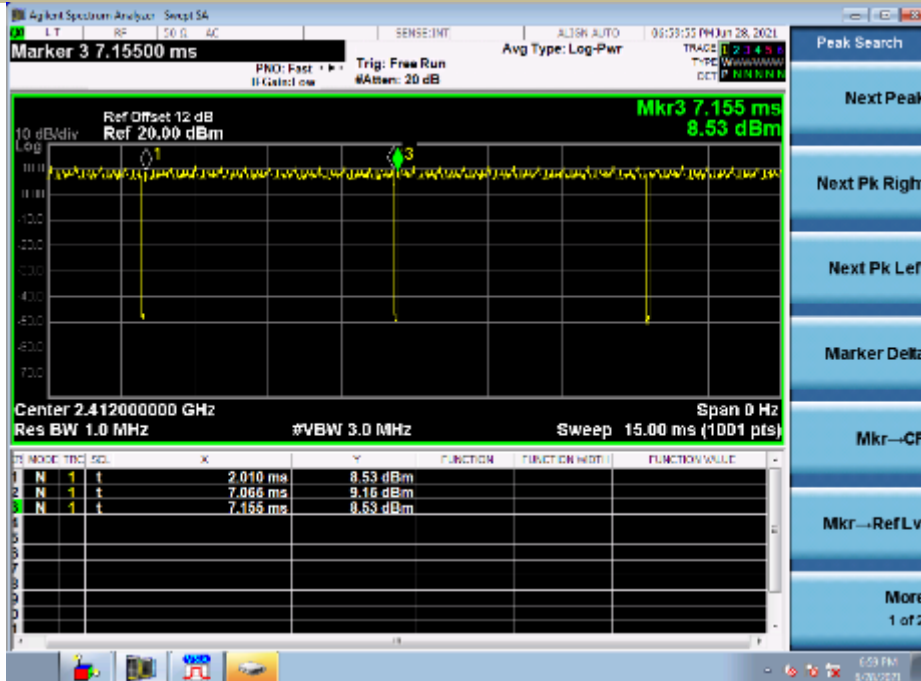

Test Model

Duty cycle  
802.11n(HT40)  
Channel 6: 2437MHz

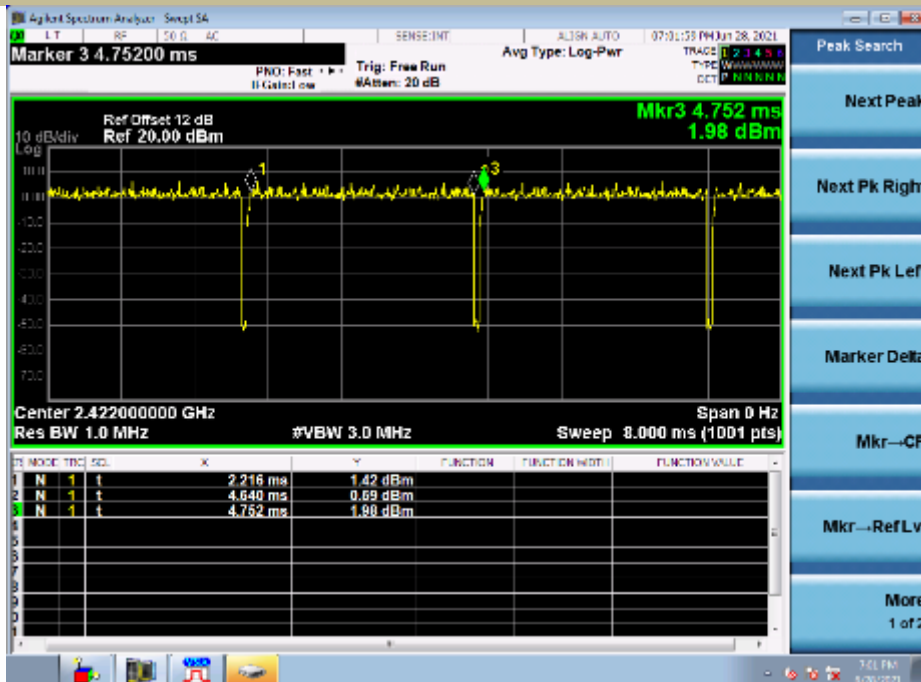

### 8.3 MAXIMUM POWER SPECTRAL DENSITY

#### 8.3.1 Applicable Standard

According to FCC Part15.247(e) and KDB 558074 D01 15.247 Meas Guidance v05r02

#### 8.3.2 Conformance Limit

The transmitter power spectral density conducted from the transmitter to the antenna shall not be greater than 8 dBm in any 3 kHz band during any time interval of continuous transmission.

#### 8.3.3 Test Configuration

Test according to clause 7.1 radio frequency test setup 1

#### 8.3.4 Test Procedure

This procedure shall be used if maximum peak conducted output power was used to demonstrate compliance

The transmitter output (antenna port) was connected to the spectrum analyzer

Set analyzer center frequency to DTS channel center frequency.

Set the span to 1.5 times the DTS bandwidth.

Set the RBW to: 3 kHz

Set the VBW to:10 kHz.

Set Detector = peak.

Set Sweep time = auto couple.

Set Trace mode = max hold.

Allow trace to fully stabilize.

Use the peak marker function to determine the maximum amplitude level within the RBW.

Note: If antenna Gain exceeds 6 dBi, then PSD Limit=8-(Gain- 6)

#### 8.3.5 Test Results

Temperature:	26° C
Relative Humidity:	54%
ATM Pressure:	1011 mbar

Operation Mode	Channel Number	Channel Frequency (MHz)	Measurement Level (dBm/3kHz)	Limit (dBm/3kHz)	Verdict
802.11b	1	2412	-11.49	8	PASS
	6	2437	-11.89	8	PASS
	11	2462	-12.13	8	PASS
802.11g	1	2412	-12.45	8	PASS
	6	2437	-11.15	8	PASS
	11	2462	-11.53	8	PASS
802.11n (HT20)	1	2412	-9.99	8	PASS
	6	2437	-11.65	8	PASS
	11	2462	-10.75	8	PASS
802.11n (HT40)	3	2422	-13.32	8	PASS
	6	2437	-13.95	8	PASS
	9	2452	-11.28	8	PASS



Test Model Power Spectral Density  
802.11b  
Channel 1: 2412MHz



Test Model Power Spectral Density  
802.11b  
Channel 6: 2437MHz



Test Model Power Spectral Density  
802.11b  
Channel 11: 2462MHz

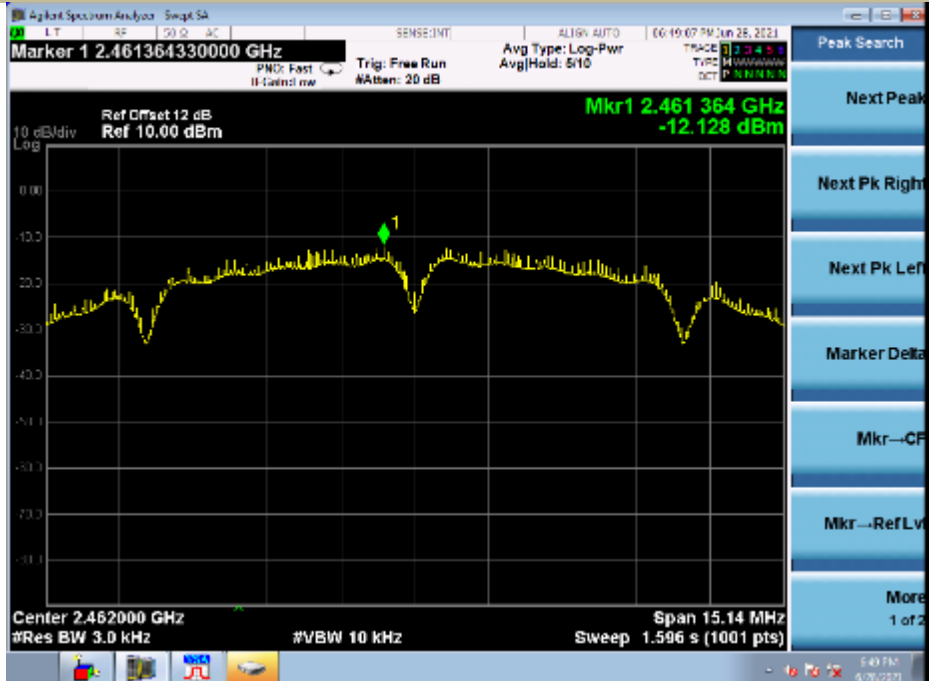

Test Model Power Spectral Density  
802.11g  
Channel 1: 2412MHz

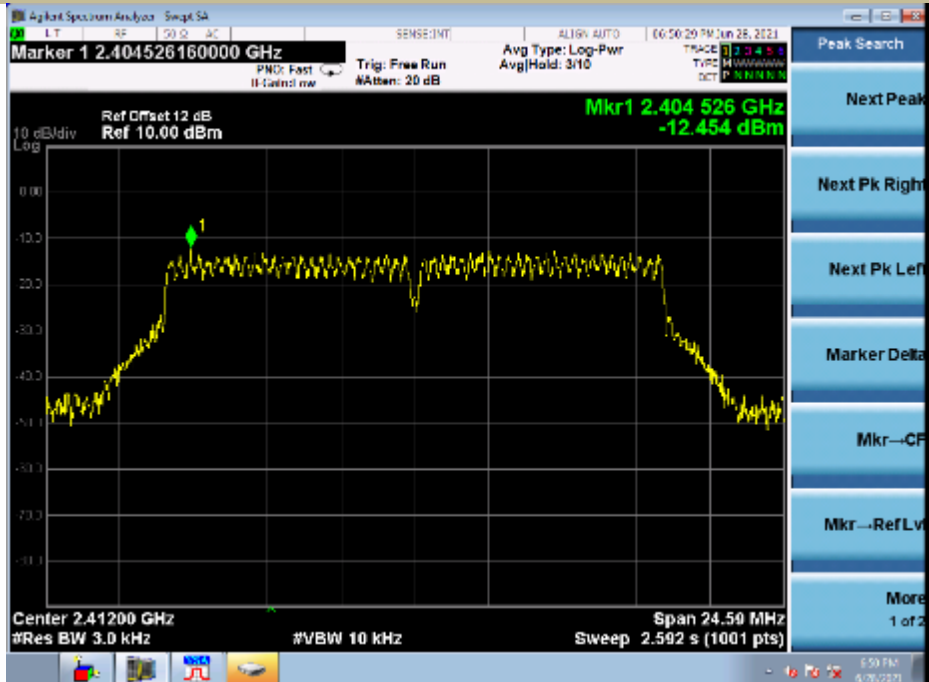

Test Model Power Spectral Density  
802.11g  
Channel 6: 2437MHz

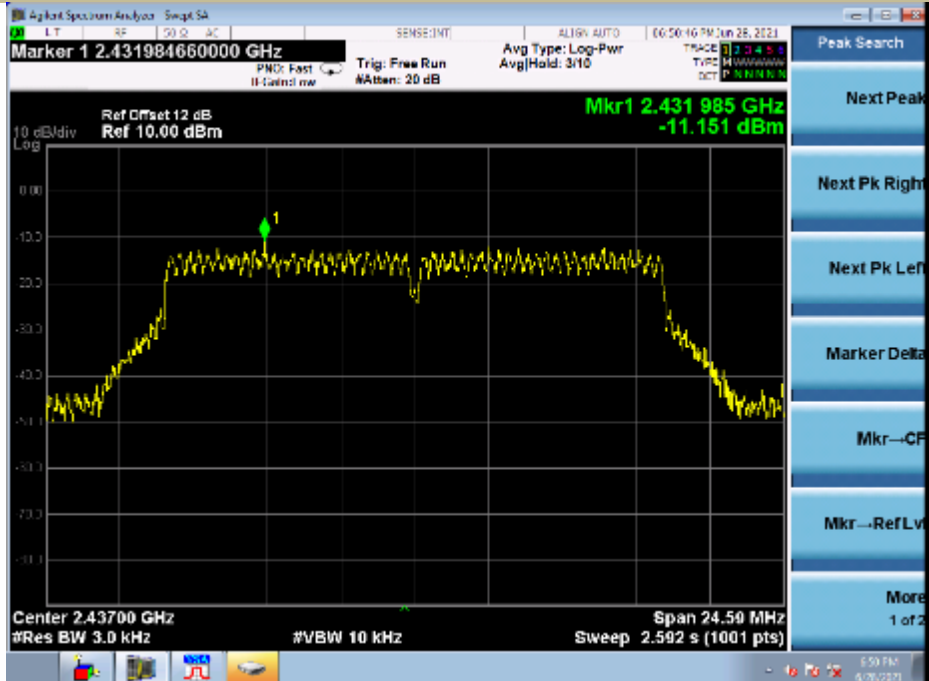

Test Model Power Spectral Density  
802.11g  
Channel 11: 2462MHz

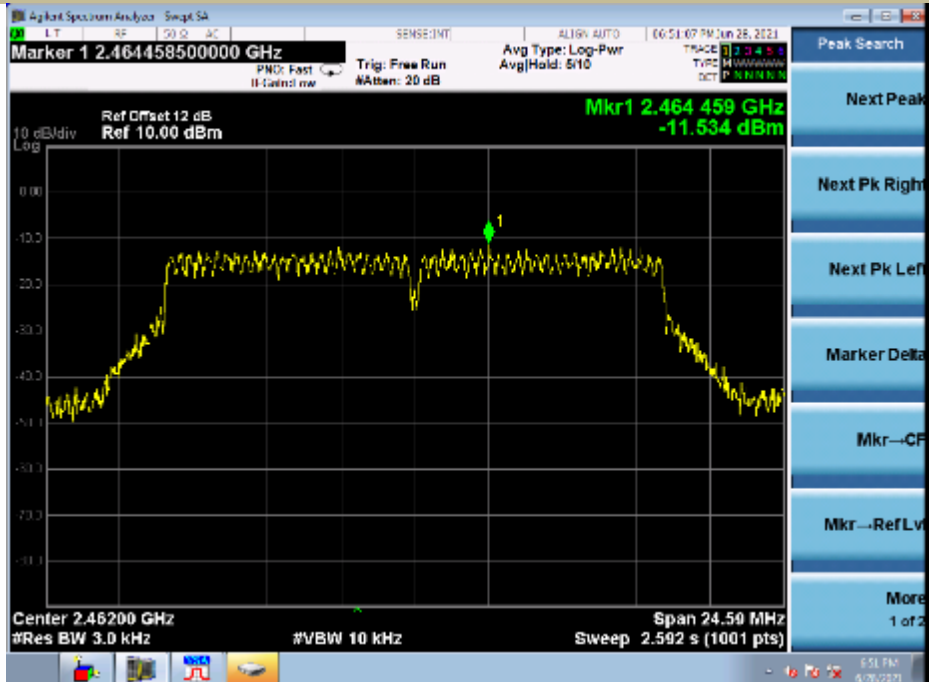

Test Model Power Spectral Density  
802.11n (HT20)  
Channel 1: 2412MHz

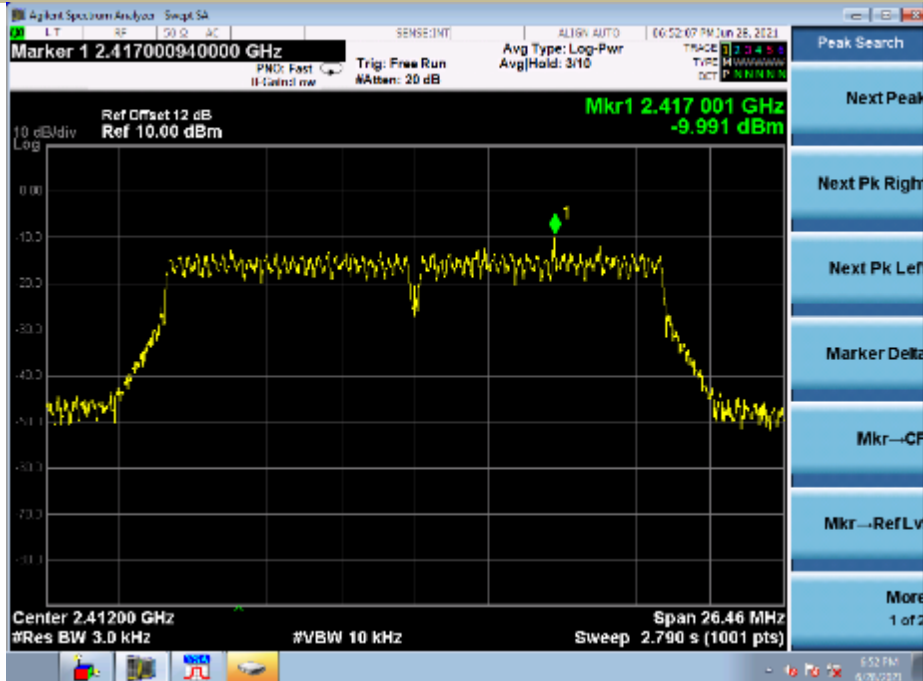

Test Model Power Spectral Density  
802.11n (HT20)  
Channel 6: 2437MHz

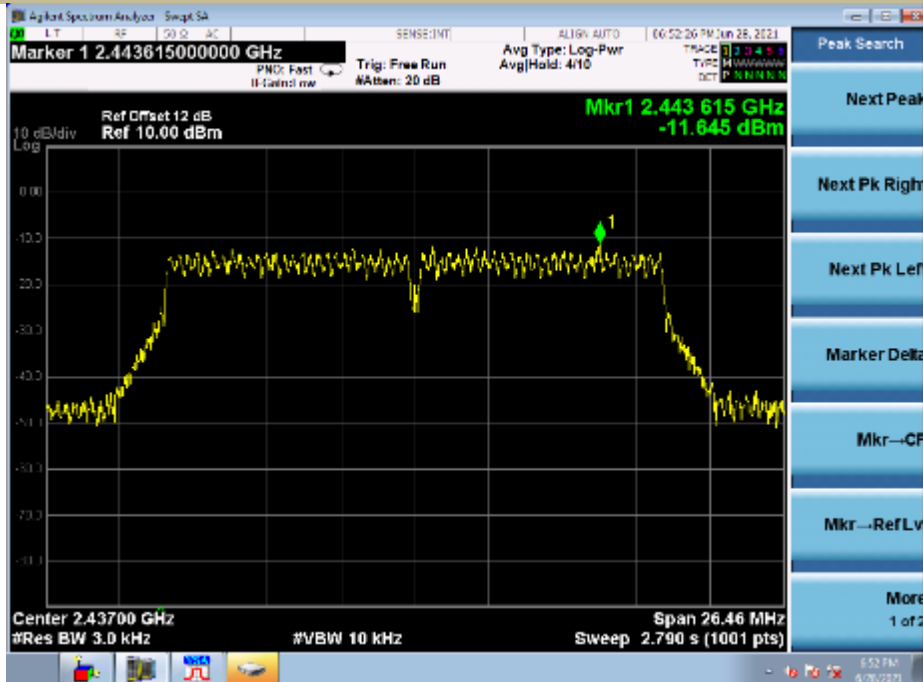

Test Model Power Spectral Density  
802.11n (HT20)  
Channel 11: 2462MHz

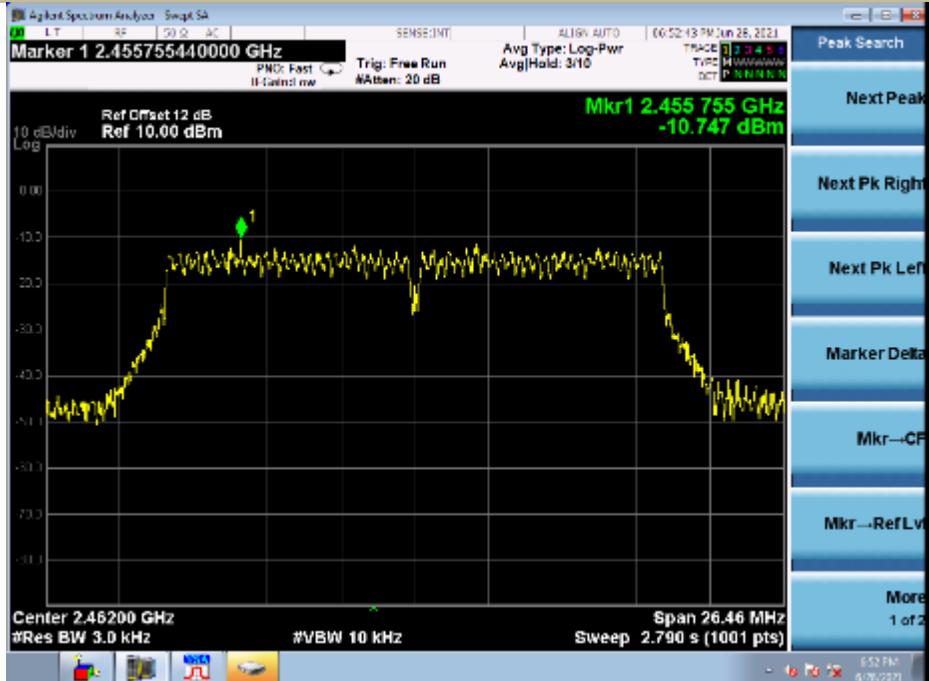

Test Model Power Spectral Density  
802.11n (HT40)  
Channel 3: 2422MHz

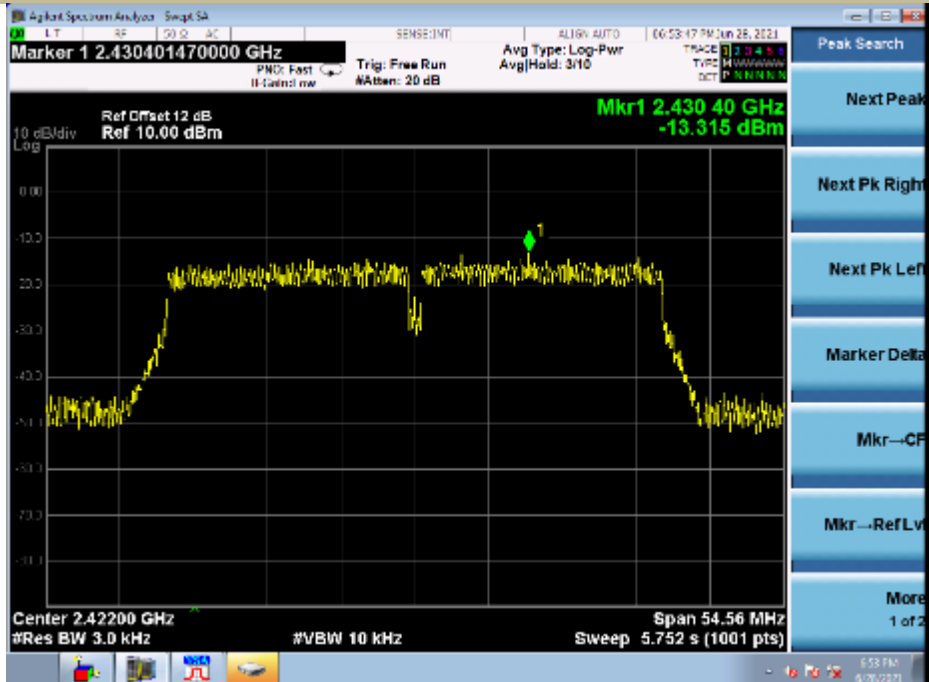

Test Model Power Spectral Density  
802.11n (HT40)  
Channel 6: 2437MHz

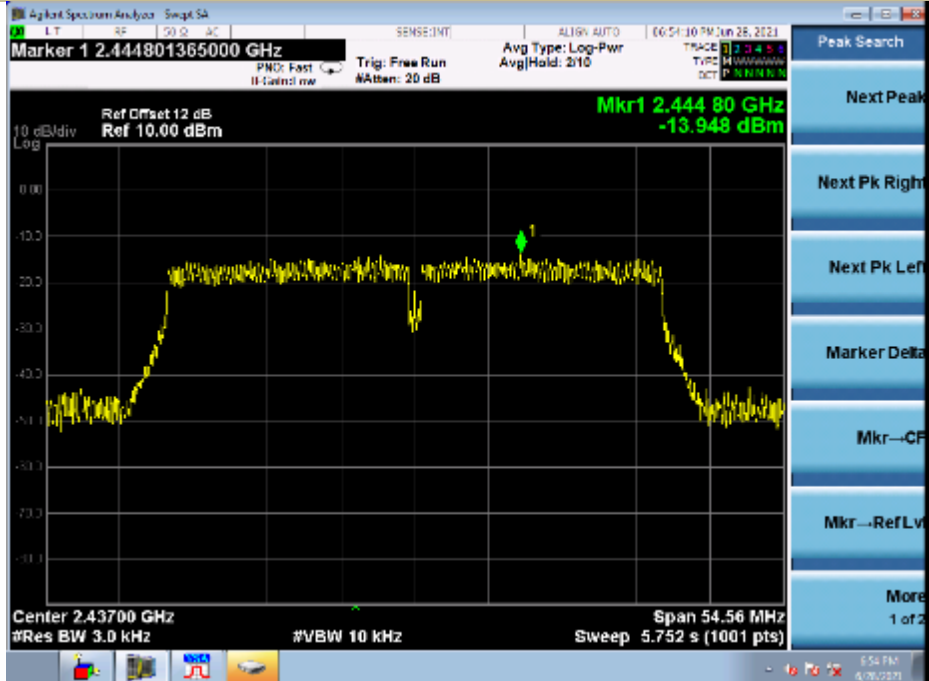

Test Model Power Spectral Density  
802.11n (HT40)  
Channel 9: 2452MHz

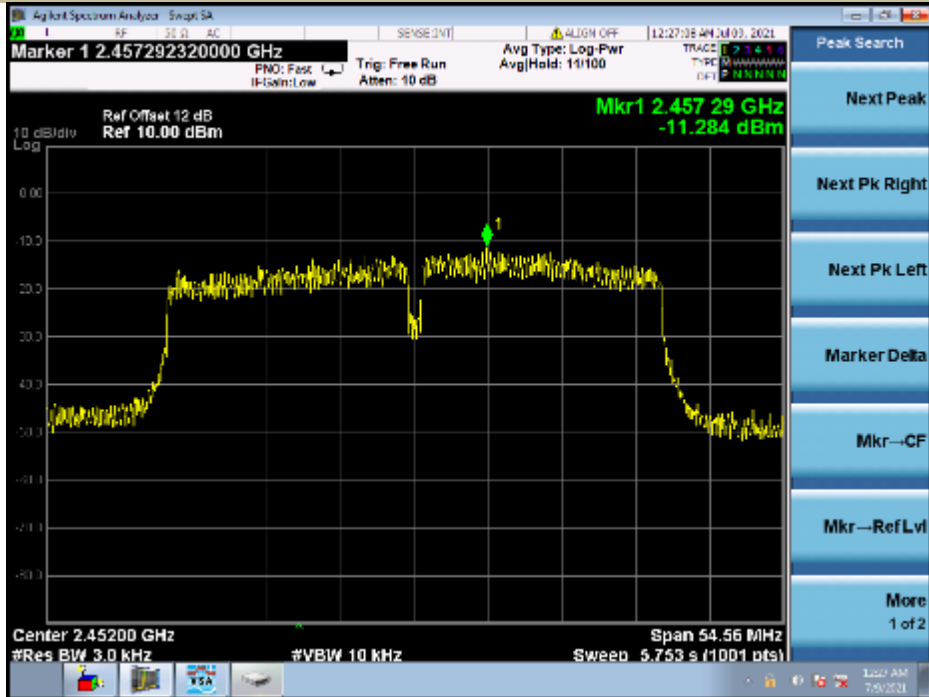

## 8.4 UNWANTED EMISSIONS IN NON-RESTRICTED FREQUENCY BANDS

### 8.4.1 Applicable Standard

According to FCC Part15.247(d) and KDB 558074 D01 15.247 Meas Guidance v05r02

### 8.4.2 Conformance Limit

According to FCC Part 15.247(d):

In any 100 kHz bandwidth outside the frequency band in which the spread spectrum or digitally modulated intentional radiator is operating, the radio frequency power that is produced by the intentional radiator shall be at least 20 dB below that in the 100 kHz bandwidth within the band that contains the highest level of the desired power, based on either an RF conducted or a radiated measurement, provided the transmitter demonstrates compliance with the peak conducted power limits. If the transmitter complies with the conducted power limits based on the use of RMS averaging over a time interval, as permitted under paragraph (b)(3) of this section, the attenuation required under this paragraph shall be 30 dB instead of 20 dB.

### 8.4.3 Test Configuration

Test according to clause 7.1 radio frequency test setup 1

### 8.4.4 Test Procedure

The transmitter output (antenna port) was connected to the spectrum analyzer

#### ■ Reference level measurement

Establish a reference level by using the following procedure:

Set instrument center frequency to DTS channel center frequency.

Set the span to  $\geq 1.5$  times the DTS bandwidth.

Set the RBW = 100 kHz.

Set the VBW  $\geq 3 \times$  RBW.

Set Detector = peak.

Set Sweep time = auto couple.

Set Trace mode = max hold.

Allow trace to fully stabilize.

Use the peak marker function to determine the maximum PSD level.

Note that the channel found to contain the maximum PSD level can be used to establish the reference level.

#### ■ Emission level measurement

Set the center frequency and span to encompass frequency range to be measured.

Set the RBW = 100 kHz.

Set the VBW = 300 kHz.

Set Detector = peak

Sweep time = auto couple.

Trace mode = max hold.

Allow trace to fully stabilize.

Use the peak marker function to determine the maximum amplitude level.

Ensure that the amplitude of all unwanted emissions outside of the authorized frequency band (excluding restricted frequency bands) are attenuated by at least the minimum requirements . Report the three highest emissions relative to the limit.

### 8.4.5 Test Results

All modes 2.4G 802.11b/g/n have been tested, and the worst result 802.11n(HT40) recorded was report as below:

PSD(Power Spectral Density ) RBW=100kHz

Test Model      802.11b      802.11g      802.11n(HT20)      802.11n(HT40)

Channel 1: 2412MHz      Channel 3: 2422MHz

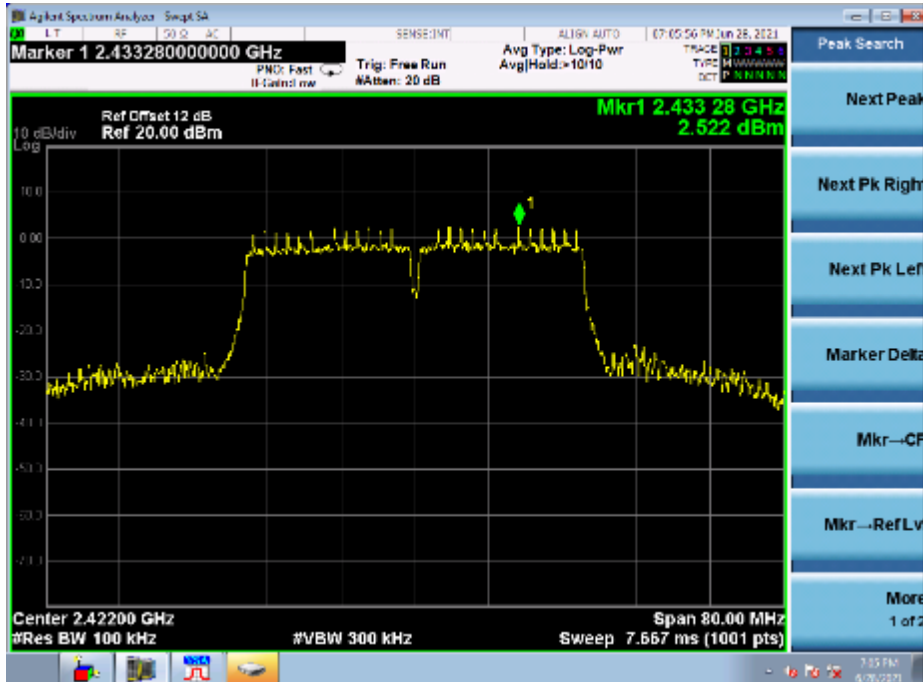

Unwanted Emissions in non-restricted frequency bands

Test Model      802.11b      802.11g      802.11n(HT20)      802.11n(HT40)

Channel 1: 2412MHz      Channel 3: 2422MHz





Test Model  802.11b  802.11g  802.11n(HT20)  802.11n(HT40)  
 Channel 1: 2412MHz  Channel 3: 2422MHz



Test Model  802.11b  802.11g  802.11n(HT20)  802.11n(HT40)  
 PSD(Power Spectral Density ) RBW=100kHz  
 Channel 6: 2437MHz



Unwanted Emissions In Non-Restricted Frequency Bands

Test Model  802.11b  802.11g  802.11n(HT20)  802.11n(HT40)

Channel 6: 2437MHz



PSD(Power Spectral Density ) RBW=100kHz

Test Model  802.11b  802.11g  802.11n(HT20)  802.11n(HT40)

Channel 11: 2462MHz  Channel 9: 2452MHz



**Unwanted Emissions In Non-Restricted Frequency Bands**

Test Model    802.11b    802.11g    802.11n(HT20)    802.11n(HT40)  
Channel 11: 2462MHz    Channel 9: 2452MHz

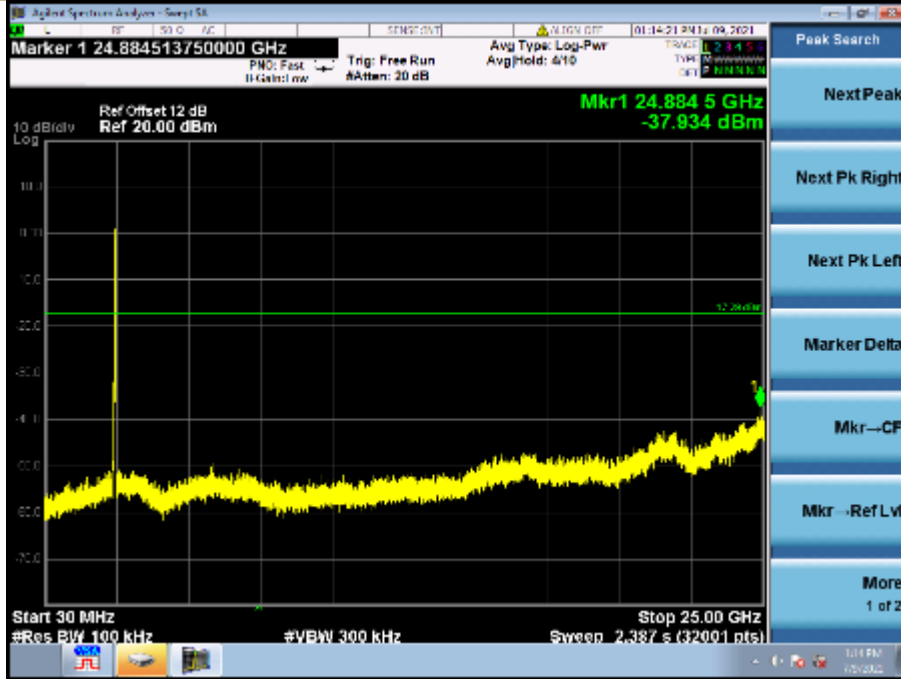

**Band edge**

Test Model    802.11b    802.11g    802.11n(HT20)    802.11n(HT40)  
Channel 11: 2462MHz    Channel 9: 2452MHz

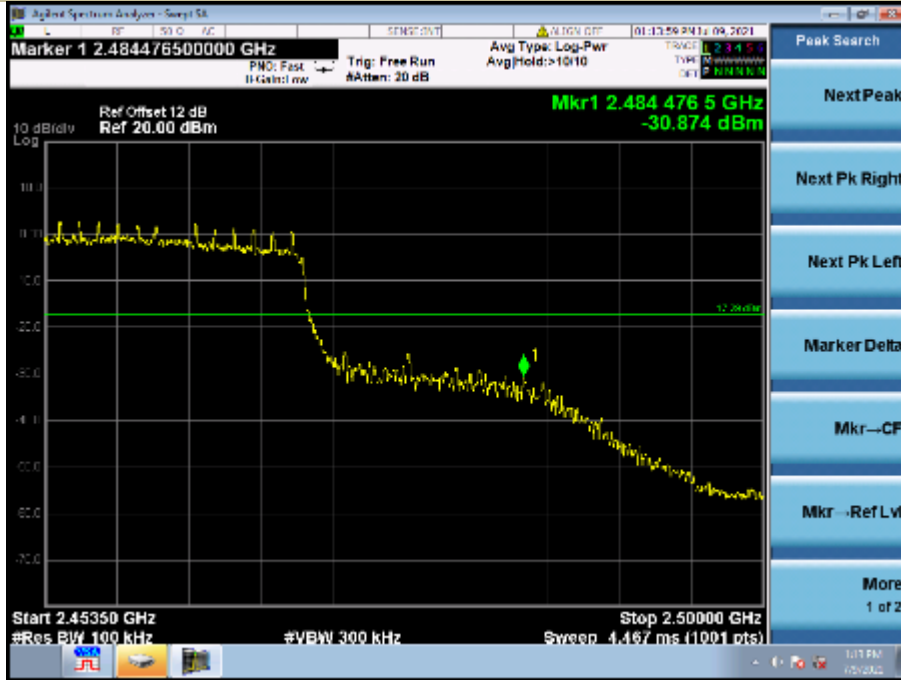

## 8.5 RADIATED SPURIOUS EMISSION

### 8.5.1 Applicable Standard

According to FCC Part 15.247(d) and 15.209 and KDB 558074 D01 15.247 Meas Guidance v05r02

### 8.5.2 Conformance Limit

According to FCC Part 15.247(d): radiated emissions which fall in the restricted bands, as defined in §15.205(a), must also comply with the radiated emission limits specified in §15.209(a) (see §15.205(c)).  
According to FCC Part 15.205, Restricted bands

MHz	MHz	MHz	GHz
0.090-0.110	16.42-16.423	399.9-410	4.5-5.15
10.495-0.505	16.69475-16.69525	608-614	5.35-5.46
2.1735-2.1905	16.80425-16.80475	960-1240	7.25-7.75
4.125-4.128	25.5-25.67	1300-1427	8.025-8.5
4.17725-4.17775	37.5-38.25	1435-1626.5	9.0-9.2
4.20725-4.20775	73-74.6	1645.5-1646.5	9.3-9.5
6.215-6.218	74.8-75.2	1660-1710	10.6-12.7
6.26775-6.26825	123-138	2200-2300	14.47-14.5
8.291-8.294	149.9-150.05	2310-2390	15.35-16.2
8.362-8.366	156.52475-156.52525	2483.5-2500	17.7-21.4
8.37625-8.38675	156.7-156.9	2690-2900	22.01-23.12
8.41425-8.41475	162.0125-167.17	3260-3267	23.6-24.0
12.29-12.293	167.72-173.2	3332-3339	31.2-31.8
12.51975-12.52025	240-285	3345.8-3358	36.43-36.5
12.57675-12.57725	322-335.4	3600-4400	(2)
13.36-13.41			

According to FCC Part 15.205, the level of any transmitter spurious emission in Restricted bands shall not exceed the level of the emission specified in the following table

Restricted Frequency (MHz)	Field Strength ( $\mu\text{V/m}$ )	Field Strength ( $\text{dB}\mu\text{V/m}$ )	Measurement Distance
0.009-0.490	2400/F(KHz)	20 log ( $\mu\text{V/m}$ )	300
0.490-1.705	2400/F(KHz)	20 log ( $\mu\text{V/m}$ )	30
1.705-30	30	29.5	30
30-88	100	40	3
88-216	150	43.5	3
216-960	200	46	3
Above 960	500	54	3

### 8.5.3 Test Configuration

Test according to clause 7.2 radio frequency test setup 2

### 8.5.4 Test Procedure

This test is required for any spurious emission that falls in a Restricted Band, as defined in Section 15.205. It must be performed with the highest gain of each type of antenna proposed for use with the EUT. Use the following spectrum analyzer settings:

The EUT was placed on a turn table which is 0.8m above ground plane.

Maximum procedure was performed on the highest emissions to ensure EUT compliance.

Span = wide enough to fully capture the emission being measured

RBW = 1 MHz for  $f \geq 1$  GHz (1GHz to 25GHz), 100 kHz for  $f < 1$  GHz (30MHz to 1GHz), 200Hz for  $f < 150$  KHz (9KHz to 150KHz), 9KHz for  $f < 30$  MHz (150KHz to 30KHz)

VBW  $\geq$  RBW

Sweep = auto

Detector function = peak

Trace = max hold

Follow the guidelines in ANSI C63.10-2013 with respect to maximizing the emission by rotating the EUT, measuring the emission while the EUT is situated in three orthogonal planes (if appropriate), adjusting the measurement antenna height and polarization, etc. A pre-amp and a high pass filter are required for this test, in order to provide the measuring system with sufficient sensitivity. Allow the trace to stabilize. The peak reading of the emission, after being corrected by the antenna factor, cable loss, pre-amp gain, etc., is the peak field strength, which must comply with the limit specified in Section 15.35(b). Submit this data.

Now set the VBW to 10 Hz, while maintaining all of the other instrument settings. This peak level, once corrected, must comply with the limit specified in Section 15.209. If the dwell time per channel of the hopping signal is less than 100 ms, then the reading obtained with the 10 Hz VBW may be further adjusted by a “duty cycle correction factor”, derived from  $20\log(\text{dwell time}/100 \text{ ms})$ , in an effort to demonstrate compliance with the 15.209 limit. Submit this data.

Repeat above procedures until all frequency measured was complete.

### 8.5.5 Test Results

Temperature:	26° C
Relative Humidity:	54%
ATM Pressure:	1011 mbar

#### ■ Spurious Emission below 30MHz(9KHz to 30MHz)

Freq. (MHz)	Ant.Pol. H/V	Emission Level(dBuV/m)		Limit 3m(dBuV/m)		Over(dB)	
		PK	AV	PK	AV	PK	AV
--	--	--	--	--	--	--	--

Note: the amplitude of spurious emission that is attenuated by more than 20dB below the permissible limit has no need to be reported.

Distance extrapolation factor =  $40\log(\text{Specific distance}/ \text{test distance})(\text{dB})$ ;

Limit line=Specific limits(dBuV) + distance extrapolation factor

- Spurious Emission Above 1GHz(1GHz to 25GHz)
- All modes 2.4G 802.11b/g/n have been tested, and the worst result of 802.11b recorded was report as below:

Test mode: 802.11 b Frequency: Channel 1: 2412MHz

Freq. (MHz)	Ant.Pol. H/V	Emission Level(dBuV/m)		Limit 3m(dBuV/m)		Over(dB)	
		PK	AV	PK	AV	PK	AV
4824.29	V	59.26	41.26	74	54	-14.74	-12.74
14858.84	V	55.93	37.93	74	54	-18.07	-16.07
17992.19	V	64.11	46.11	74	54	-9.89	-7.89
4824.29	H	63.25	45.25	74	54	-10.75	-8.75
14912.63	H	56.09	38.09	74	54	-17.91	-15.91
17953.23	H	65.13	47.13	74	54	-8.87	-6.87

Test mode: 802.11 b Frequency: Channel 6: 2437MHz

Freq. (MHz)	Ant.Pol. H/V	Emission Level(dBuV/m)		Limit 3m(dBuV/m)		Over(dB)	
		PK	AV	PK	AV	PK	AV
4874.04	V	58.54	40.54	74	54	-15.46	-13.46
14884.64	V	55.83	37.83	74	54	-18.17	-16.17
17974.00	V	64.18	46.18	74	54	-9.82	-7.82
4874.04	H	60.11	42.11	74	54	-13.89	-11.89
14876.03	H	56.49	38.49	74	54	-17.51	-15.51
17922.12	H	64.43	46.43	74	54	-9.57	-7.57

Test mode: 802.11 b Frequency: Channel 11: 2462MHz

Freq. (MHz)	Ant.Pol. H/V	Emission Level(dBuV/m)		Limit 3m(dBuV/m)		Over(dB)	
		PK	AV	PK	AV	PK	AV
4924.31	V	59.72	41.72	74	54	-14.28	-12.28
14848.11	V	55.77	37.77	74	54	-18.23	-16.23
17922.12	V	64.34	46.34	74	54	-9.66	-7.66
4924.31	H	60.39	42.39	74	54	-13.61	-11.61
14408.42	H	56.71	38.71	74	54	-17.29	-15.29
17823.97	H	64.86	46.86	74	54	-9.14	-7.14

- Note:**
- (1) All Readings are Peak Value (VBW=3MHz) and Peak Value (VBW=10Hz).
  - (2) Emission Level= Reading Level+Correct Factor +Cable Loss.
  - (3) Correct Factor= Ant\_F + Cab\_L - Preamp
  - (4)The reading of emissions are attenuated more than 20dB below the permissible limits or the field strength is too small to be measured.

■ Spurious Emission in Restricted Band 2310-2390MHz and 2483.5-2500MHz

All modes 2.4G 802.11b/g/n have been tested, and the worst result of 802.11b recorded was report as below:

Test mode: 802.11 b Frequency: Channel 1: 2412MHz

Frequency (MHz)	Polarity	PK(dBuV/m) (VBW=3MHz)	Limit 3m (dBuV/m)	AV(dBuV/m) (VBW=10Hz)	Limit 3m (dBuV/m)
2358.430	V	37.92	74	31.02	54
2355.220	H	38.41	74	30.44	54

Test mode: 802.11 b Frequency: Channel 11: 2462MHz

Frequency (MHz)	Polarity	PK(dBuV/m) (VBW=3MHz)	Limit 3m (dBuV/m)	AV(dBuV/m) (VBW=10Hz)	Limit 3m (dBuV/m)
2484.192	V	37.75	74	31.26	54
2488.491	H	37.71	74	28.62	54

- Note:**
- (1) All Readings are Peak Value (VBW=3MHz) and Peak Value (VBW=10Hz).
  - (2) Emission Level= Reading Level+Correct Factor +Cable Loss.
  - (3) Correct Factor= Ant\_F + Cab\_L - Preamp
  - (4) The reading of emissions are attenuated more than 20dB below the permissible limits or the field strength is too small to be measured.

**Spurious Emission in Restricted Band 2310-2390MHz**

Test Model    802.11b    802.11g    802.11n(HT20)    802.11n(HT40)  
Channel 1: 2412MHz    Channel 3: 2422MHz    Polarity: H  
 VBW=3MHz

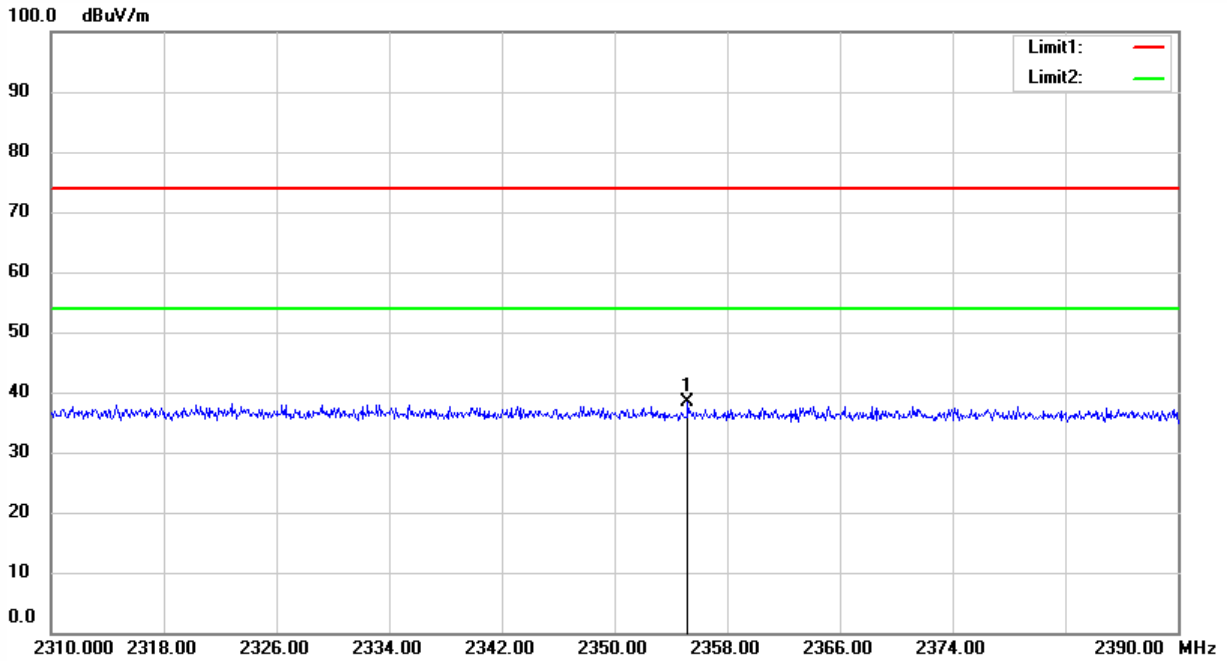

**Spurious Emission in Restricted Band 2310-2390MHz**

Test Model    802.11b    802.11g    802.11n(HT20)    802.11n(HT40)  
Channel 1: 2412MHz    Channel 3: 2422MHz    Polarity: V  
 VBW=3MHz

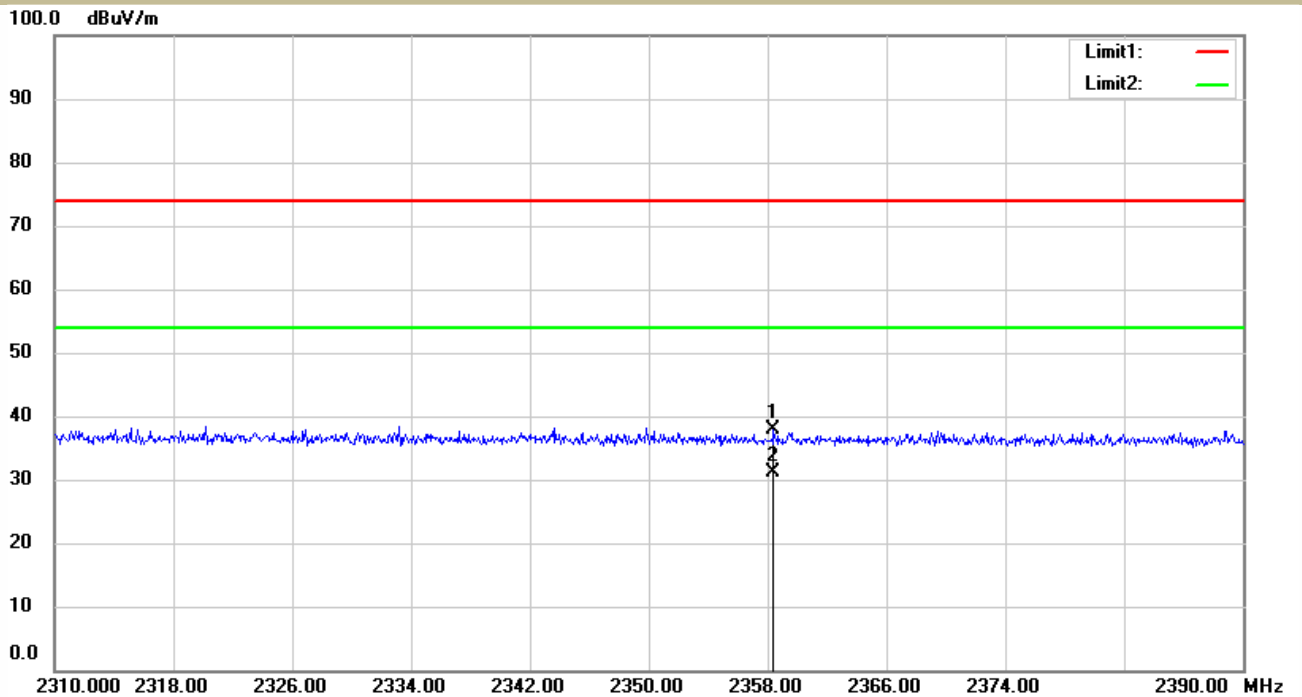



**Spurious Emission in Restricted Band 2483.5-2500MHz**

Test Model     802.11b     802.11g     802.11n(HT20)     802.11n(HT40)  
 Channel 11: 2462MHz     Channel 9: 2452MHz    Polarity: H  
 VBW=3MHz

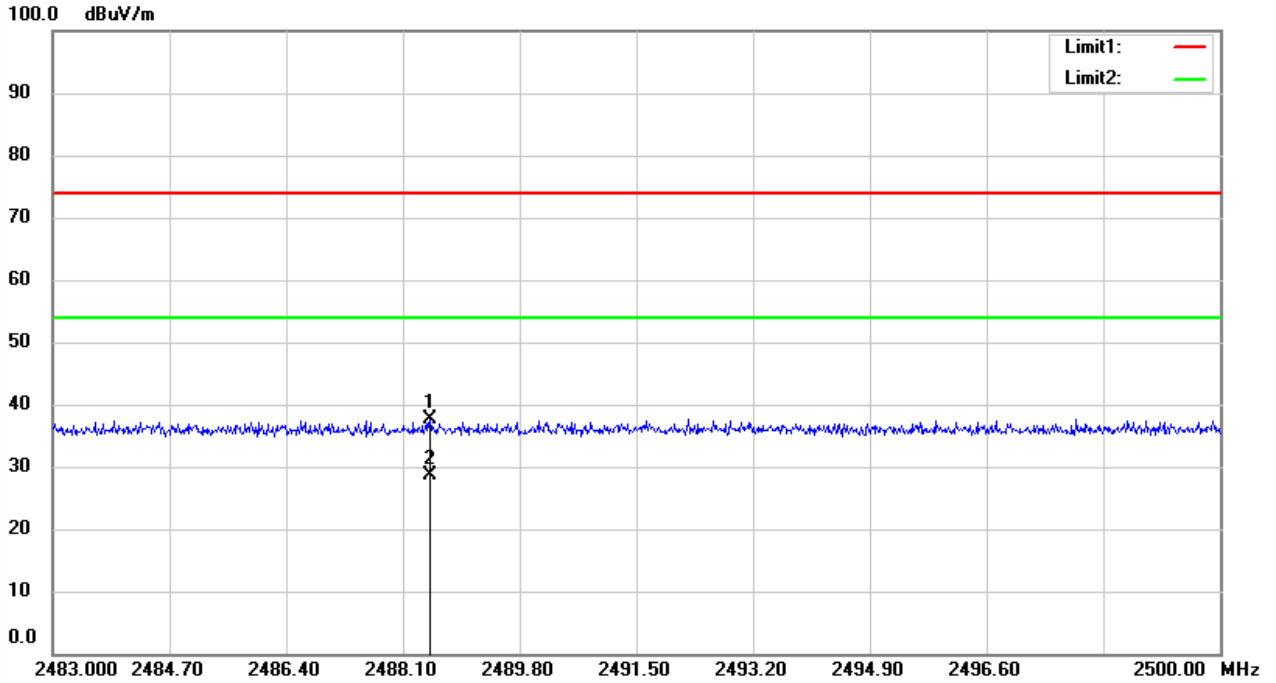

**Spurious Emission in Restricted Band 2483.5-2500MHz**

Test Model     802.11b     802.11g     802.11n(HT20)     802.11n(HT40)  
 Channel 11: 2462MHz     Channel 9: 2452MHz    Polarity: V  
 VBW=3MHz

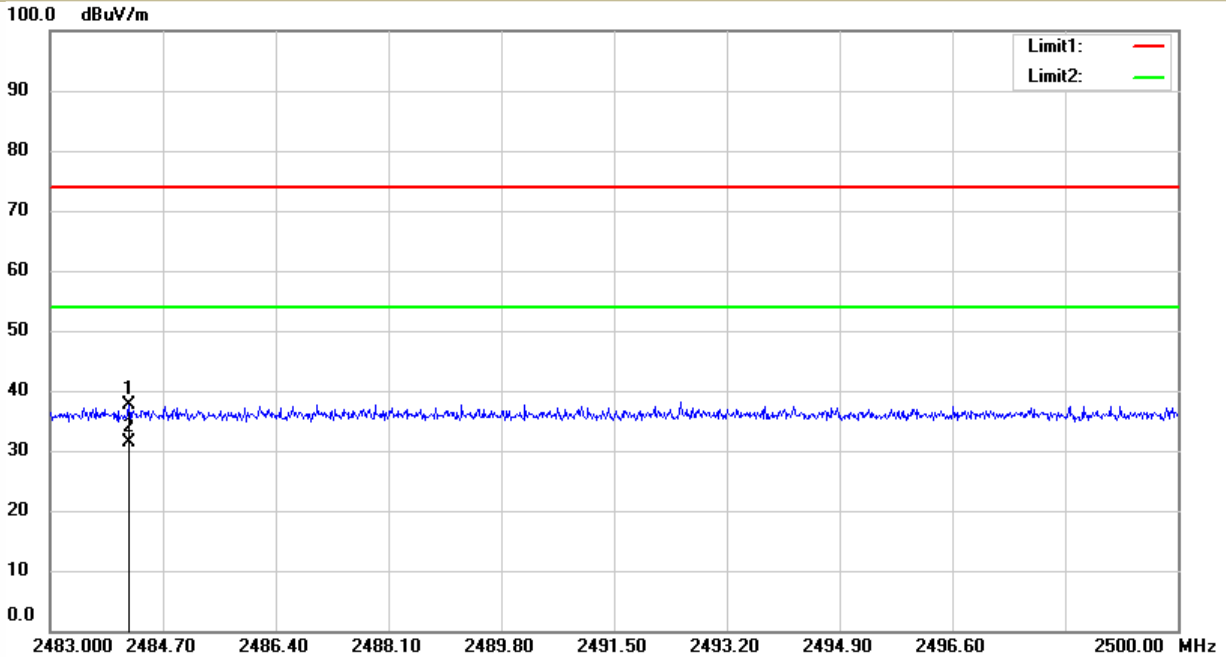

- Spurious Emission below 1GHz (30MHz to 1GHz)
- All modes 2.4G 802.11b/g/n have been tested, and the worst result of 802.11b recorded was report as below:

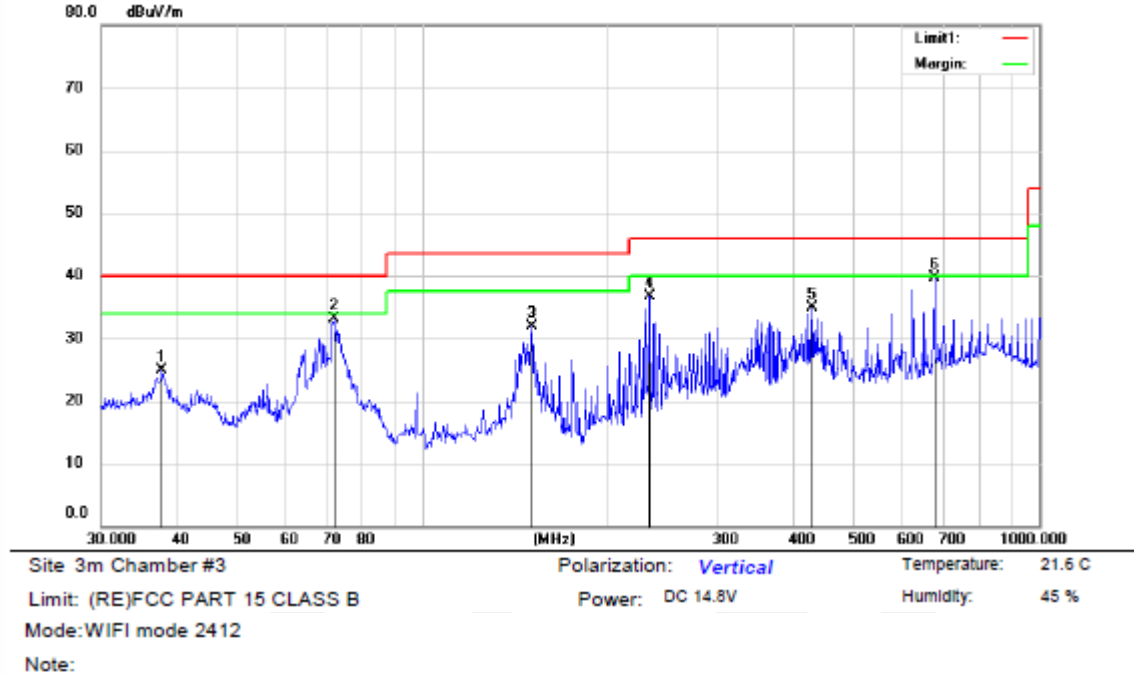

No.	Mk.	Freq.	Reading Level	Correct Factor	Measurement	Limit	Over	Antenna Height	Table Degree	
		MHz	dBuV	dB	dBuV/m	dBuV/m	dB	cm	degree	Comment
1		37.7293	40.87	-16.06	24.81	40.00	-15.19			QP
2		71.8747	49.41	-16.28	33.13	40.00	-8.87			QP
3		150.0108	49.04	-17.14	31.90	43.50	-11.60			QP
4		233.3486	52.60	-15.98	36.62	46.00	-9.38			QP
5		429.3345	43.44	-8.50	34.94	46.00	-11.06			QP
6	*	675.2080	42.91	-3.21	39.70	46.00	-6.30			QP

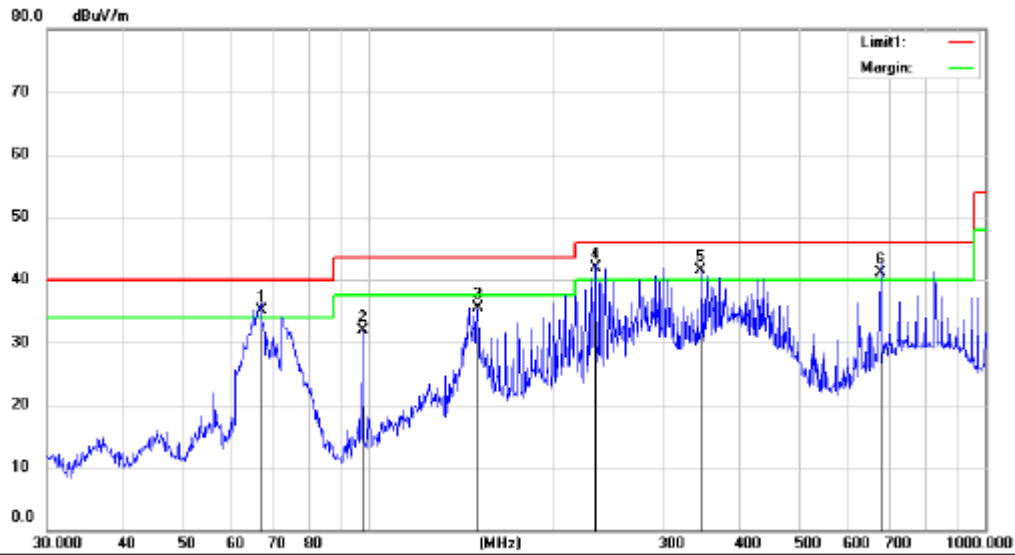

Site: 3m Chamber #3      Polarization: *Horizontal*      Temperature: 21.6 C  
 Limit: (RE)FCC PART 15 CLASS B      Power: DC 14.8V      Humidity: 45 %  
 Mode: WIFI mode 2412  
 Note:

No.	Mk.	Freq.	Reading Level	Correct Factor	Measurement	Limit	Over	Antenna Height	Table Degree	Comment
		MHz	dBuV	dB	dBuV/m	dBuV/m	dB	cm	degree	
1	!	66.8203	50.36	-15.24	35.12	40.00	-4.88	QP		
2		97.7983	49.45	-17.60	31.85	43.50	-11.65	QP		
3		150.0108	52.70	-17.14	35.56	43.50	-7.94	QP		
4	*	233.3486	57.93	-15.98	41.95	46.00	-4.05	QP		
5	!	345.8982	52.71	-11.23	41.48	46.00	-4.52	QP		
6	!	675.2080	44.32	-3.21	41.11	46.00	-4.89	QP		

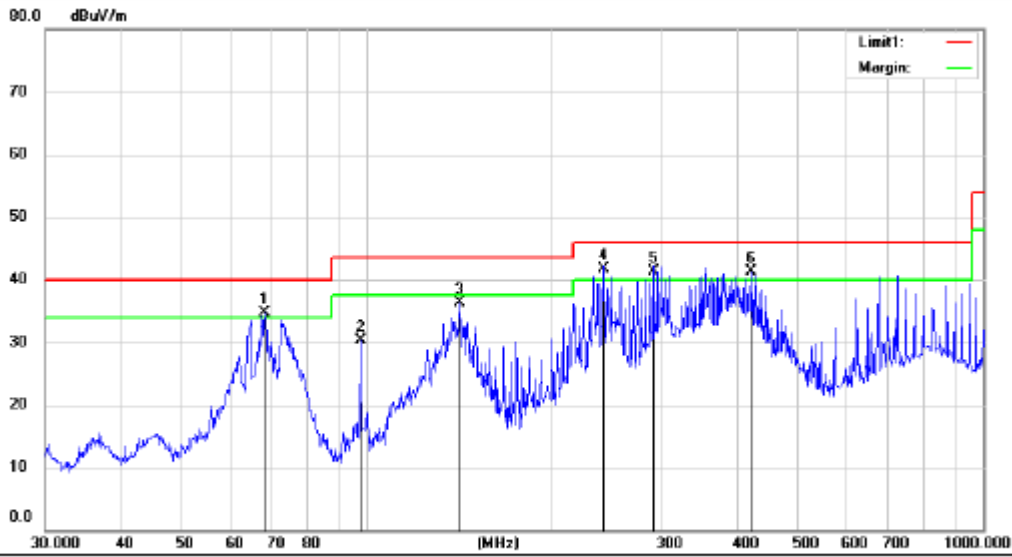

Site: 3m Chamber #3      Polarization: *Horizontal*      Temperature: 21.6 C  
 Limit: (RE)FCC PART 15 CLASS B      Power: DC 14.8V      Humidity: 45 %  
 Mode: WIFI mode 2437  
 Note:

No.	Mk.	Freq.	Reading Level	Correct Factor	Measurement	Limit	Over	Antenna Height	Table Degree	
		MHz	dBuV	dB	dBuV/m	dBuV/m	dB	cm	degree	Comment
1	!	68.2411	50.31	-15.54	34.77	40.00	-5.23			QP
2		97.7983	47.91	-17.60	30.31	43.50	-13.19			QP
3		141.6397	53.98	-17.64	36.34	43.50	-7.16			QP
4	*	241.6763	57.32	-15.67	41.65	46.00	-4.35			QP
5	!	291.6744	54.48	-13.25	41.23	46.00	-4.77			QP
6	!	420.9492	50.18	-8.96	41.22	46.00	-4.78			QP

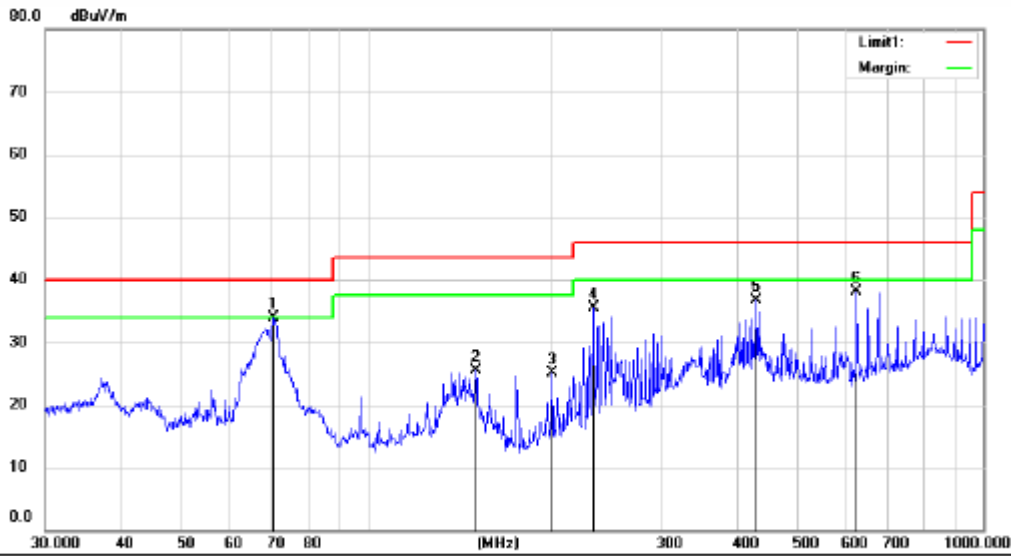

Site 3m Chamber #3      Polarization: **Vertical**      Temperature: 21.6 C  
 Limit: (RE)FCC PART 15 CLASS B      Power: DC 14.8V      Humidity: 45 %  
 Mode: WIFI mode 2437  
 Note:

No.	Mk.	Freq.	Reading Level	Correct Factor	Measurement	Limit	Over	Antenna Height	Table Degree
		MHz	dBuV	dB	dBuV/m	dBuV/m	dB	cm	degree
1	*	70.3385	49.97	-15.99	33.98	40.00	-8.02	QP	
2		150.0108	42.56	-17.14	25.42	43.50	-18.08	QP	
3		200.0732	42.08	-17.02	25.06	43.50	-18.44	QP	
4		233.3487	51.57	-15.98	35.59	46.00	-10.41	QP	
5		429.1464	45.30	-8.51	36.79	46.00	-9.21	QP	
6		625.0780	42.70	-4.60	38.10	46.00	-7.90	QP	

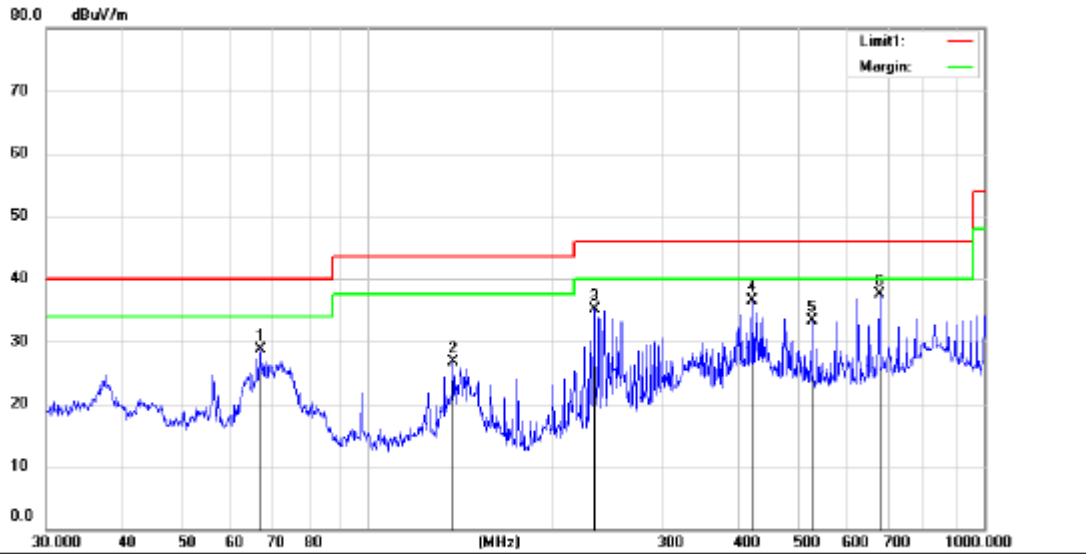

Site 3m Chamber #3      Polarization: *Vertical*      Temperature: 21.6 C  
 Limit: (RE)FCC PART 15 CLASS B      Power: DC 14.8V      Humidity: 45 %  
 Mode: WIFI mode 2462  
 Note:

No.	Mk.	Freq.	Reading Level	Correct Factor	Measurement	Limit	Over	Antenna Height	Table Degree
		MHz	dBuV	dB	dBuV/m	dBuV/m	dB	cm	degree
1		66.7618	43.99	-15.23	28.76	40.00	-11.24	QP	
2		137.4805	44.34	-17.57	26.77	43.50	-16.73	QP	
3		233.3487	51.04	-15.98	35.06	46.00	-10.94	QP	
4		420.9492	45.39	-8.96	36.43	46.00	-9.57	QP	
5		525.0142	40.51	-7.23	33.28	46.00	-12.72	QP	
6	*	675.2080	40.78	-3.21	37.57	46.00	-8.43	QP	

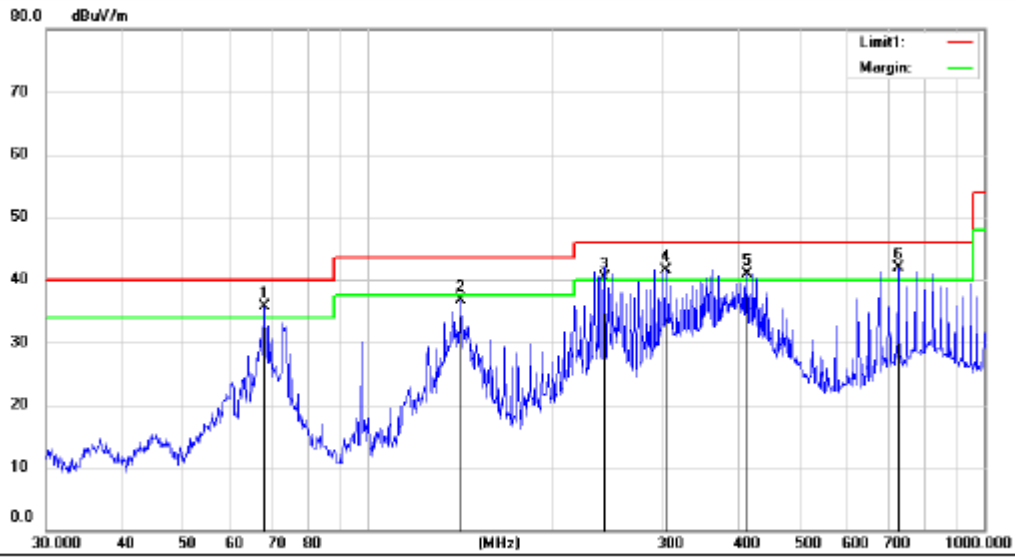

Site 3m Chamber #3      Polarization: *Horizontal*      Temperature: 21.6 C  
 Limit: (RE)FCC PART 15 CLASS B      Power: DC 14.8V      Humidity: 45 %  
 Mode: WIFI mode 2462  
 Note:

No.	Mk.	Freq.	Reading Level	Correct Factor	Measurement	Limit	Over	Antenna Height	Table Degree	
		MHz	dBuV	dB	dBuV/m	dBuV/m	dB	cm	degree	Comment
1	!	67.9425	51.09	-15.48	35.61	40.00	-4.39	QP		
2		141.6397	54.42	-17.64	36.78	43.50	-6.72	QP		
3	!	241.6780	55.88	-15.67	40.21	46.00	-5.79	QP		
4	!	304.2096	54.39	-12.89	41.50	46.00	-4.50	QP		
5	!	412.5466	50.08	-9.16	40.92	46.00	-5.08	QP		
6	*	725.2140	43.97	-2.14	41.83	46.00	-4.17	QP		



## 8.6 CONDUCTED EMISSIONS TEST

### 8.6.1 Applicable Standard

According to FCC Part 15.207(a)

### 8.6.2 Conformance Limit

Frequency(MHz)	Conducted Emission Limit	
	Quasi-peak	Average
0.15-0.5	66-56	56-46
0.5-5.0	56	46
5.0-30.0	60	50

Note: 1. The lower limit shall apply at the transition frequencies  
2. The limit decreases in line with the logarithm of the frequency in the range of 0.15 to 0.50MHz.

### 8.6.3 Test Configuration

Test according to clause 7.3conducted emission test setup

### 8.6.4 Test Procedure

The EUT was placed on a table which is 0.8m above ground plane.  
Maximum procedure was performed on the highest emissions to ensure EUT compliance.  
Repeat above procedures until all frequency measured were complete.

### 8.6.5 Test Results

Pass

The 120V &240V voltagehave been tested, and the worst result recorded was report as below:



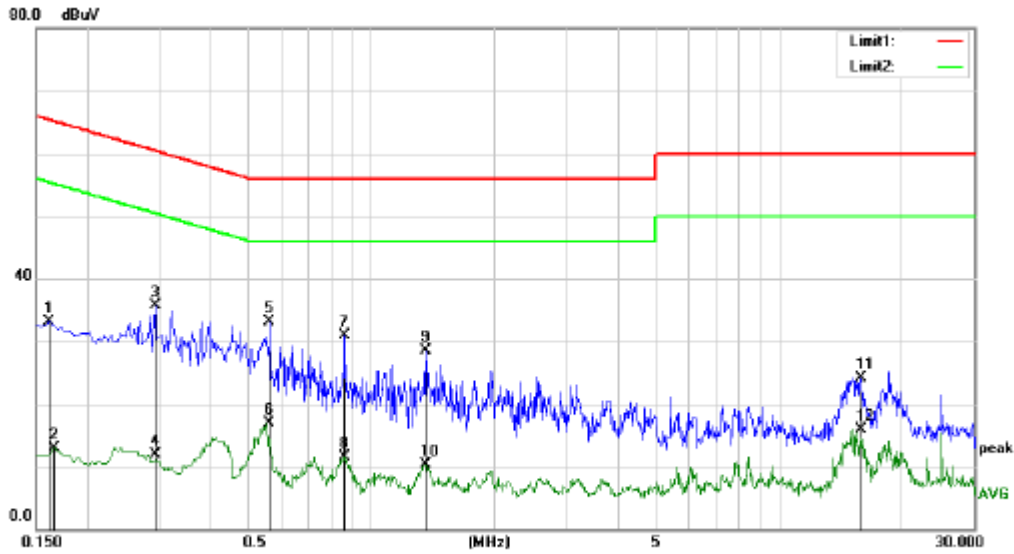

Site Conduction #1 Phase: **N** Temperature: 19.4  
 Limit: (CE)FCC PART 15 class B\_QP Power: AC 120V/60Hz Humidity: 37 %  
 Mode: CHARGING  
 Note:

No.	Mk.	Freq.	Reading Level	Correct Factor	Measurement	Limit	Over	Detector	Comment
		MHz	dBuV	dB	dBuV	dBuV	dB		
1		0.1620	23.64	9.54	33.18	65.36	-32.18	QP	
2		0.1660	3.41	9.53	12.94	55.16	-42.22	AVG	
3		0.2940	26.36	9.30	35.66	60.41	-24.75	QP	
4		0.2940	2.52	9.30	11.82	50.41	-38.59	AVG	
5	*	0.5620	23.76	9.26	33.02	56.00	-22.98	QP	
6		0.5620	7.61	9.26	16.87	46.00	-29.13	AVG	
7		0.8580	21.31	9.60	30.91	56.00	-25.09	QP	
8		0.8580	1.91	9.60	11.51	46.00	-34.49	AVG	
9		1.3580	18.55	9.91	28.46	56.00	-27.54	QP	
10		1.3580	0.38	9.91	10.29	46.00	-35.71	AVG	
11		15.8140	13.90	10.17	24.07	60.00	-35.93	QP	
12		15.8140	5.66	10.17	15.83	50.00	-34.17	AVG	

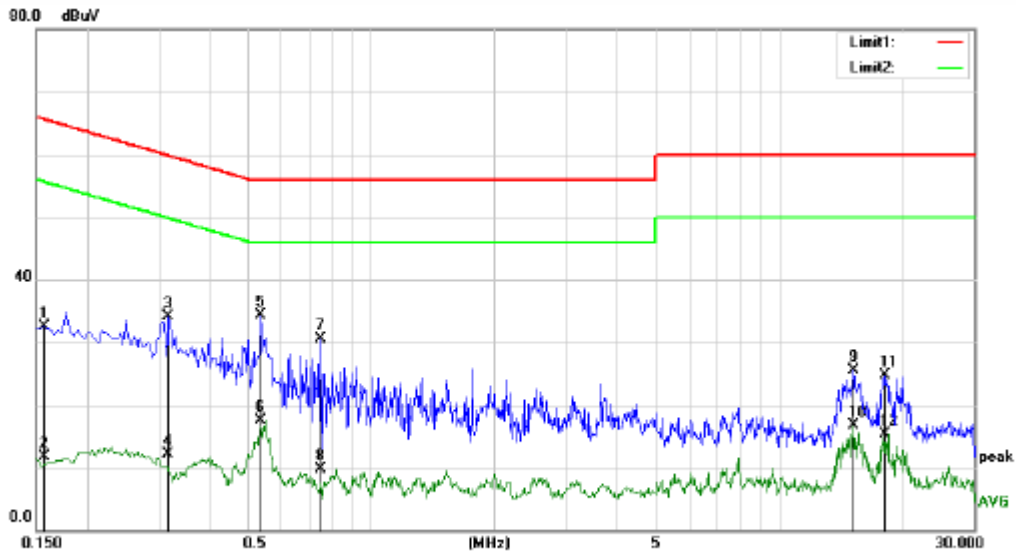

Site Conduction #1 Phase: **L1** Temperature: 19.4  
 Limit: (CE)FCC PART 15 class B\_QP Power: AC 120V/60Hz Humidity: 37 %  
 Mode: CHARGING  
 Note:

No.	Mk.	Freq.	Reading Level	Correct Factor	Measurement	Limit	Over	Detector	Comment
		MHz	dBuV	dB	dBuV	dBuV	dB		
1		0.1580	22.90	9.55	32.45	65.57	-33.12	QP	
2		0.1580	2.16	9.55	11.71	55.57	-43.86	AVG	
3		0.3180	24.80	9.30	34.10	59.76	-25.66	QP	
4		0.3180	2.80	9.30	12.10	49.76	-37.66	AVG	
5	*	0.5340	25.04	9.26	34.30	56.00	-21.70	QP	
6		0.5340	8.19	9.26	17.45	46.00	-28.55	AVG	
7		0.7500	21.04	9.38	30.42	56.00	-25.58	QP	
8		0.7500	0.39	9.38	9.77	46.00	-36.23	AVG	
9		15.1940	15.40	10.17	25.57	60.00	-34.43	QP	
10		15.1940	6.44	10.17	16.61	50.00	-33.39	AVG	
11		18.0900	14.48	10.17	24.65	60.00	-35.35	QP	
12		18.0900	5.04	10.17	15.21	50.00	-34.79	AVG	

## 8.7 ANTENNA APPLICATION

### 8.7.1 Antenna Requirement

Standard	Requirement
FCC CRF Part15.203	An intentional radiator shall be designed to ensure that no antenna other than that furnished by the responsible party shall be used with the device. The use of a permanently attached antenna or of an antenna that uses a unique coupling to the intentional radiator shall be considered sufficient to comply with the provisions of this section. The manufacturer may design the unit so that a broken antenna can be replaced by the user, but the use of a standard antenna jack or electrical connector is prohibited. This requirement does not apply to carrier current devices or to devices operated under the provisions of §15.211, §15.213, §15.217, §15.219, or §15.221. Further, this requirement does not apply to intentional radiators that must be professionally installed, such as perimeter protection systems and some field disturbance sensors, or to other intentional radiators which, in accordance with §15.31(d), must be measured at the installation site. However, the installer shall be responsible for ensuring that the proper antenna is employed so that the limits in this part are not exceeded.

For intentional device, according to FCC 47 CFR Section 15.203, an intentional radiator shall be designed to ensure that no antenna other than that furnished by the responsible party shall be used with the device. And according to FCC 47 CFR Section 15.247 (b), if transmitting antennas of directional gain greater than 6dBi are used, the power shall be reduced by the amount in dB that the directional gain of the antenna exceeds 6dBi.

### 8.7.2 Result

PASS.

- The EUT has a PCB Antenna for WIFI 2.4G, the antenna gain is 5.2 dBi.

Note:  Antenna uses a permanently attached antenna which is not replaceable.  
 Not using a standard antenna jack or electrical connector for antenna replacement  
 The antenna has to be professionally installed (please provide method of installation)

Which in accordance to section 15.203, please refer to the internal photos.

Detail of factor for radiated emission

Frequency(MHz)	Ant_F(dB)	Cab_L(dB)	Preamp(dB)	Correct Factor(dB)
0.009	20.6	0.03	\	20.63
0.15	20.7	0.1	\	20.8
1	20.9	0.15	\	21.05
10	20.1	0.28	\	20.38
30	18.8	0.45	\	19.25
30	11.7	0.62	27.9	-15.58
100	12.5	1.02	27.8	-14.28
300	12.9	1.91	27.5	-12.69
600	19.2	2.92	27	-4.88
800	21.1	3.54	26.6	-1.96
1000	22.3	4.17	26.2	0.27
1000	25.6	1.76	41.4	-14.04
3000	28.9	3.27	43.2	-11.03
5000	31.1	4.2	44.6	-9.3
8000	36.2	5.95	44.7	-2.55
10000	38.4	6.3	43.9	0.8
12000	38.5	7.14	42.3	3.34
15000	40.2	8.15	41.4	6.95
18000	45.4	9.02	41.3	13.12
18000	37.9	1.81	47.9	-8.19
21000	37.9	1.95	48.7	-8.85
25000	39.3	2.01	42.8	-1.49
28000	39.6	2.16	46.0	-4.24
31000	41.2	2.24	44.5	-1.06
34000	41.5	2.29	46.6	-2.81
37000	43.8	2.30	46.4	-0.3
40000	43.2	2.50	42.2	3.5

\*\*\* End of Report \*\*\*