

Robotic Vacuum Cleaner

R530

Instruction Manual

Important Safety Instructions

To reduce the risk of injury or damage, read these safety instructions carefully and keep them at hand when setting up, using, and maintaining this device.



WARNING SYMBOLS USED

This is the safety alert symbol. This symbol alerts you to potential hazards that could result in property damage and/or serious bodily harm or death.

- This device can be used by children aged from 8 years and above and persons with reduced physical, sensory or mental capabilities or lack of experience and knowledge if they have been given supervision or instruction concerning use of this device in a safe way and understand the hazards involved.
- Children should be supervised to ensure they do not play with this device.
- Cleaning and maintenance shall not be performed by children without adult supervision.
- This device is only to be used with the power supply unit provided.
- For the purposes of recharging the battery, only use the detachable power supply unit provided with this device.
- The battery must be removed from this device before this device is disposed of. To remove the battery from this device, first remove the screws on the bottom, then remove the battery by disconnecting the quick connector.
- The used battery should be placed in a sealed plastic bag and disposed of safely according to local environmental regulations.
- The external flexible cable or cord of the power supply unit cannot be replaced; if the cord is damaged, the power supply unit shall be disposed of.
- This device is for indoor use only.
- This device is not a toy. Do not sit or stand on this device. Small children and pets should be supervised when this device is operating.
- Store and operate this device in room temperature environments only.
- Clean with a cloth dampened with water only.
- Do not use this device to pick up anything that is burning or smoking.
- Do not use this device to pick up spills of bleach, paint, chemicals, or anything wet.

- Before using this device, pick up objects like clothing and loose paper. Lift up cords for blinds or curtains, and move power cords and fragile objects out of the way. If this device passes over a power cord and drags it, an object could be pulled off a table or shelf.
- If the room to be cleaned has a balcony, a physical barrier should be used to prevent access to the balcony and to ensure safe operation.
- Do not place anything on top of this device.
- Be aware that this device moves around on its own. Take care when walking in the area where this device is operating to avoid stepping on it.
- Do not operate this device in areas with exposed electrical outlets on the floor.
- Do not expose the electronics of this device, its battery, or the integrated Charging Base. There are no user-serviceable parts inside.
- Do not use this device on an unfinished, unsealed, waxed or rough floor. It may result in damage to the floor and this device. Use only on hard floor surfaces or low-pile carpet.
- This device has been designed to be used on floors without scratching them. We still recommend that you test this device on a small area of the room to be cleaned to ensure no scratches are made before cleaning the whole room.

This symbol on the device or its packaging indicates: Do not dispose of

Notice



electrical appliances as unsorted municipal waste; use separate collection facilities. Contact your local authority for information regarding the collection systems available. If electrical appliances are disposed of in landfills or dumps, hazardous substances can leak into the groundwater and get into the food chain, damaging your health and well-being. When replacing old appliances with new ones, the retailer is legally obliged to take back your old appliance for disposal at least free of charge.

Contents

Product Composition / Package Contents	4
Product Composition / Part Name	5
Icons Display Function	6
Dust Box, Water Tank and Charging Dock	7
Product Usage / Preparation	8
Product Use/ Robot Charging	9
Product Use / Turn On / Turn Off	10
Product Use / Start Pause, Wake up	10
Product Usage / Select a Cleaning Mode	11
Time Scheduling Setting	12
Mopping / Water Tank	13
Cleaning and Maintenance	14
Troubleshooting	19
Product Parameter	20

Product Composition / Package Contents

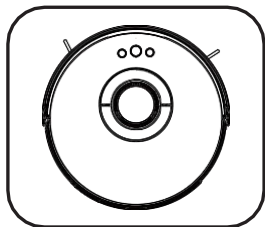

Robot

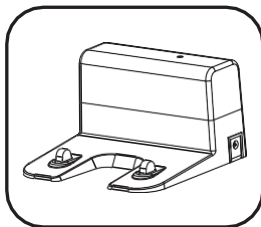

Charging Dock

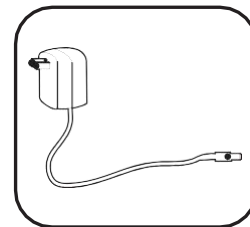

Power Adapter

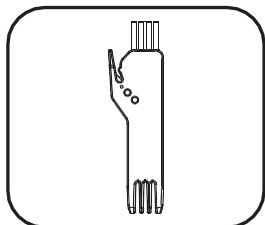

Cleaning Brush

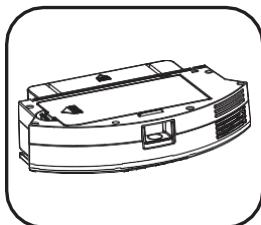

Dust Box

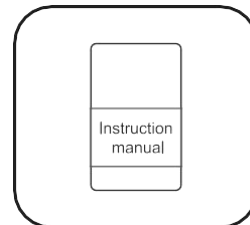

Instruction Manual

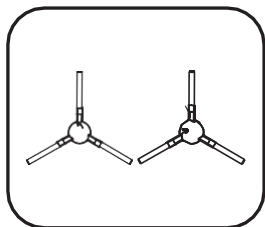

Side Brush x4

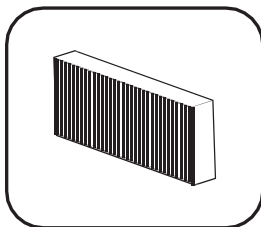

HEPA Filter x2

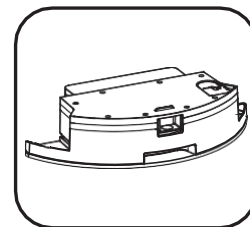

Water Tank

Product Composition / Part Name

Front Robot

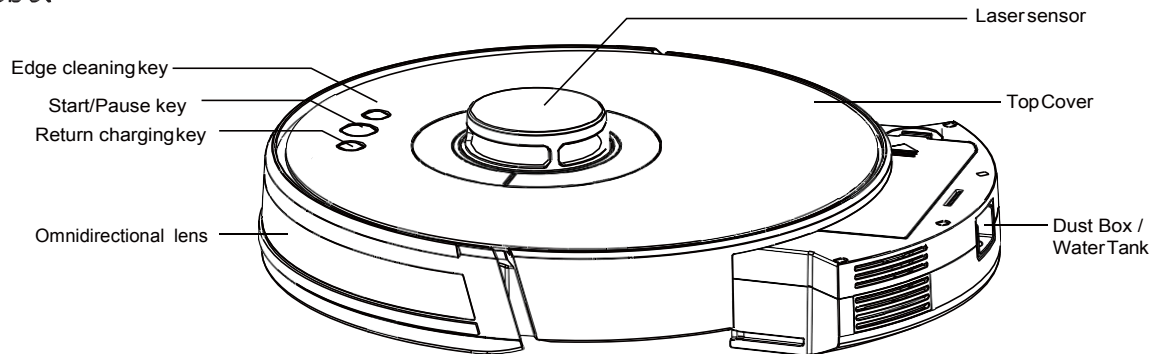

Press and hold "Return" key for 3 second to ener WIFI setting

Back Robot

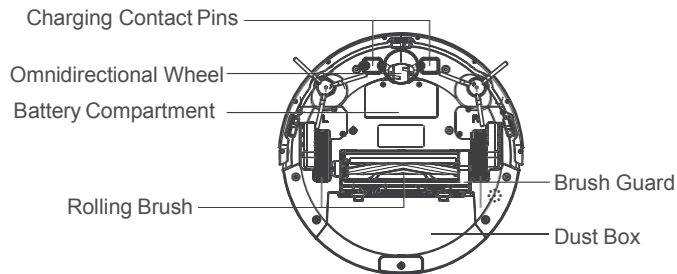
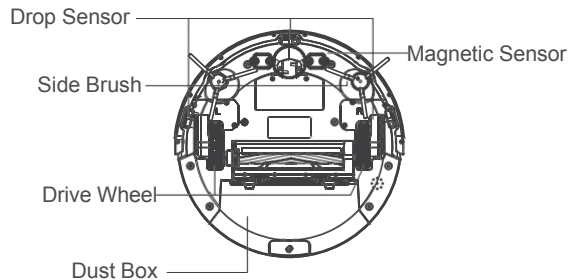

1 use mobile phone to scan the QR code to download APP



APP

IOS:

Use iPhone "APP store" search "SWEAFT" to download the APP

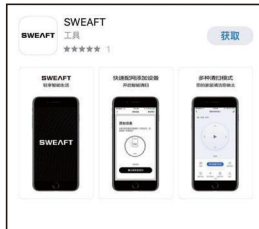

iPhone screenshot

Andriod:

Use Andriod phone "Market" search "SWEAFT" to download the APP



Andriod phone
screenshot

2 APP usage guide

iOS / Andriod smart phone:

1. Login APP, or register as new user in the first time of use. Please fill up necessary information in APP registration in order to access the APP
2. Existing account login: you can login through registered mobile phone number, binding WeChat account or QQ account



iOS login screen

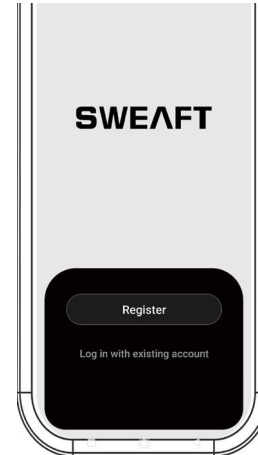

Andriod login screen

3 APP connects to Robot operation guide

Switch on Robot, then press and hold the “Return” or “Home” button for 3 sec after a “Ding” sound, Robot will have a voice message of “Smart link”. Then, the Wi-Fi icon will flash and ready for Wi-Fi connection.

Open up the “SWEAFT” APP, press “Add device” and select the correct Robot vacuum cleaner model to establish the connection

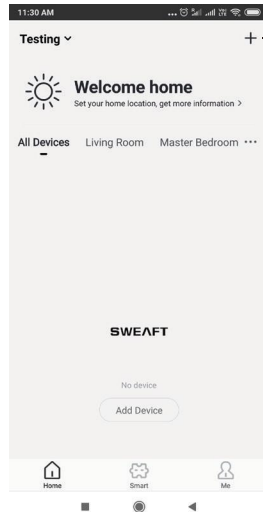

Press “+” to add device

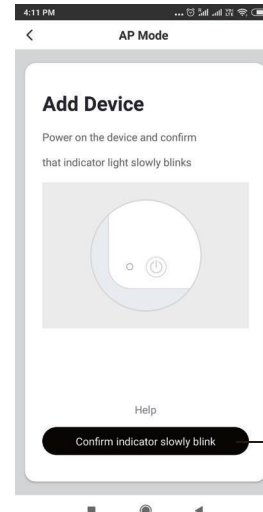

Press to confirm establishing connection

Select P8 Model

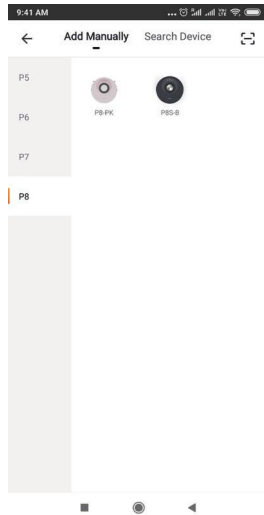

Select network to connect

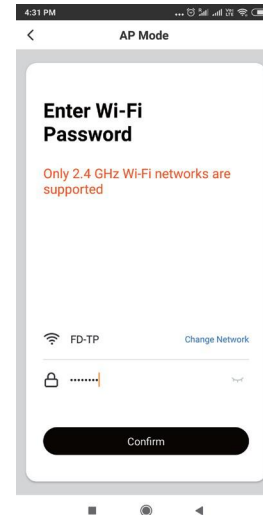

Attention:

1. Select the Wi-Fi network, enters user name and password, wait for establish connection



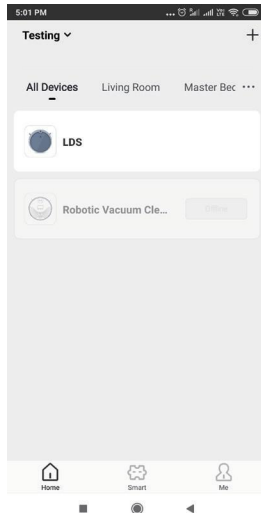



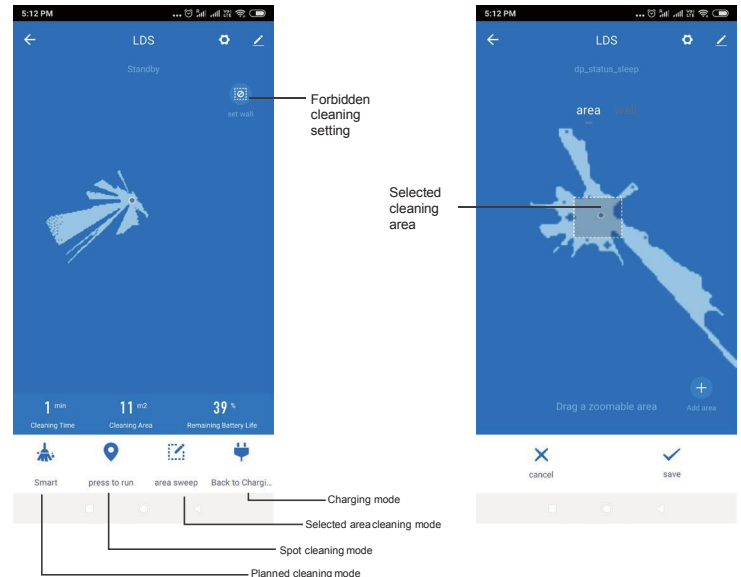



4 Successful connected to Wi-Fi, press name of the Robot, “LDS” as below, enter to APP operation





5 After connection established, APP interface guide



APP Display Function:

Function Description	
	Edge cleaning mode: icon always light up, start cleaning; icon flashing, cleaning pause
	Auto cleaning mode: icon always light up, start auto cleaning; icon flashing, cleaning pause
	Single room mode: icon always light up, start single room cleaning; icon flashing, cleaning pause
	Section cleaning: user able to create cleaning area in the map available in APP. Robot will start cleaning after area set.
	Location mode: user able to spot any location in the map available in APP. Robot will go to the location and start circular cleaning once in 2M radius.
	Zig-Zag cleaning mode: robot will start edge cleaning to create area block. Robot will start Zig-Zag cleaning in the block and return to started point once cleaning is done.
	Spot mode: icon always light up, start intensive cleaning in the selected area; icon flashing, cleaning pause.
	Set undesired cleaning area
	Return charging: icon always light up, robot will automatically return to Charging Dock; icon flashing, cleaning pause.
	Scheduled cleaning mode: icon always light up, scheduled cleaning is set; icon flashing setting up schedule time cleaning.
	Charging mode: icon flashing, when battery is charging. Otherwise, display available battery level.

Button	Function Mode	Switch Function	Function Description
	Power button	Press once > 0.3 Sec	Start up robot
		Press and hold > 3 Sec	Turn off robot
		Press once > 0.3 Sec	Start Zig-Zag cleaning
		Press once > 0.3 Sec	Pause
	Return button	Press once > 0.3 Sec	Robot return to Charging Dock for charging
		Press once > 0.3 Sec	Pause
		Press and hold > 3 Sec	Go to Wifi connection mode
	Edge cleaning button	Press once > 0.3 Sec	Start edge cleaning
		Press once > 0.3 Sec	Pause

Dust Box, Water Tank and Charging Dock

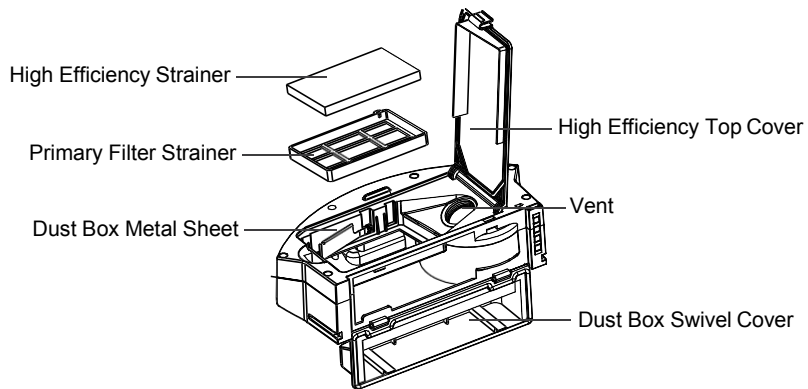

Dust Box

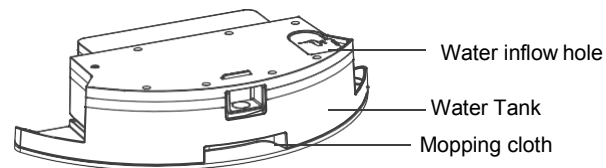

Water Tank

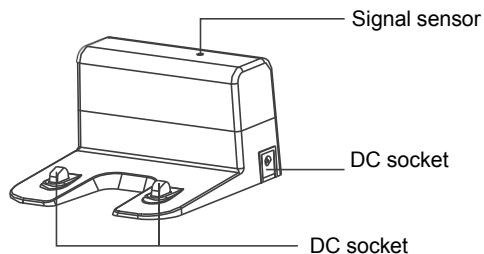

Charging Dock

Product Usage / Preparation

Before using the Robot, remove the protective strip on the Robot and Charging Dock.

Remove Protection

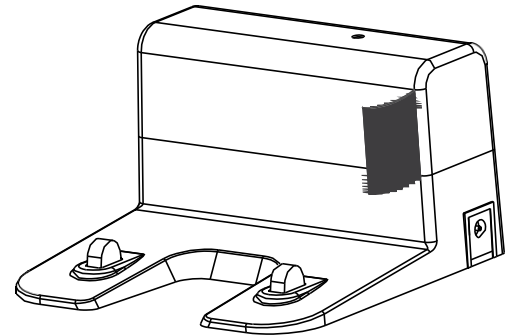
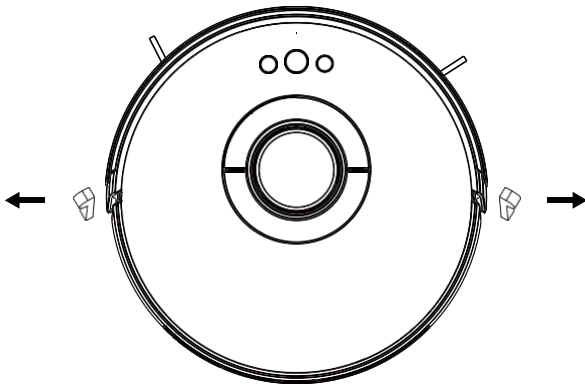

Product Usage / Robot Charging

- ① Place the Charging Dock on a hard, level surface and against a wall. Remove objects within 1.5 ft/0.5 m on both sides and within 3 ft/1 m in front of the Charging Dock.

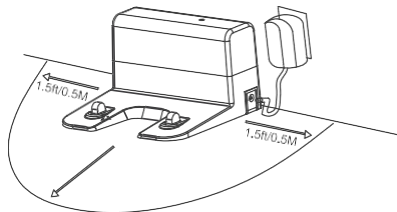

- ② Plug the adapter into the a wall outlet and plug the DC jack into the DC socket of the Charging Dock.

When the Charging Dock connects to AC power, the LED indicator on the Charging Dock is flashing green.

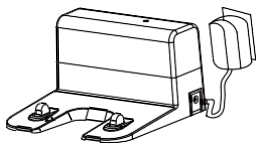

💡 Install the Charging Base in a location that Robot can easily access. Please place the Charging Base against a wall, and on a hard-level surface rather than on rugs or carpets.

- Always keep the Charging Base plugged in, otherwise Robot will not automatically return to it.

- ③ Install the side brushes before use.

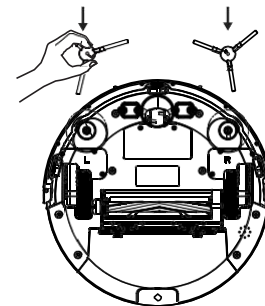

- ④ Charging your robot

Place the robot on the Charging Dock for battery charging (When charging, indication light is flashing. Light will stay light up when charging is finished. Normal charging time is about 5 hours)

Robot returns to the Charging Dock at the end of a cleaning cycle or when its battery is running low

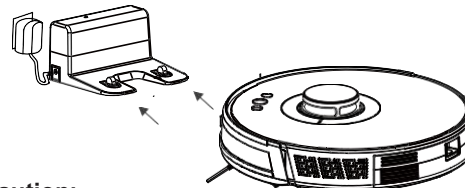



Caution:

- Do not expose Charging Dock with direct sunlight or any strong reflection on light source. If cannot be avoided, please cover the bottom part of Charging Dock about 7 cm.
- Recommend to fully charge the robot to ensure operating time.
- Avoid to have Water Tank inserted in robot when charging. Avoid to have wet mopping cloth in which may damage wooden floor.

Product Use / Turn On and Turn Off

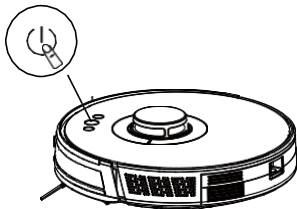
Turn On: Press the Robot  on the Robot until the indicator light on the robot turns on and the "Welcome to use sweeping robot prompt tone.



Turn Off: Press  on the Robot until the indicator light on the robot turns off.



Turn off the Robot if it will not be used for a long period of time. To preserve the battery's lifespan, recharge at least once every 6 months.

Start / Stop / Wake up



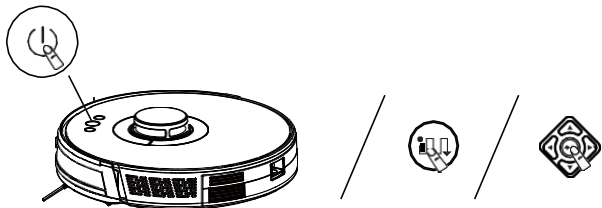

Make sure the Robot is turned on before use.

1. Press  on the Robot or  /  on the Remote Handset to start cleaning in Auto Mode

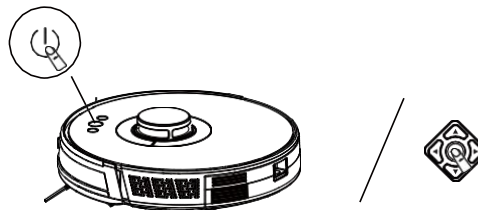

2. Press  on the Robot or  on the Remote Handset to stop cleaning



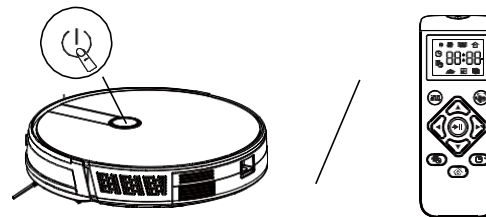

3. Press  on the Robot or any key on the Remote Handset to wake up



If the Robot stops working for more than ten minutes, it will automatically enter the sleep mode (all the lights on the robot will turn off)

Product Use / Select a Cleaning Mode

1. Auto Cleaning

- Robot optimizes its cleaning path by selecting different cleaning modes automatically until cleaning is complete. This is the most commonly used cleaning mode.
- Press  on the Robot or  /  on the Remote Handset to start cleaning in Auto Mode

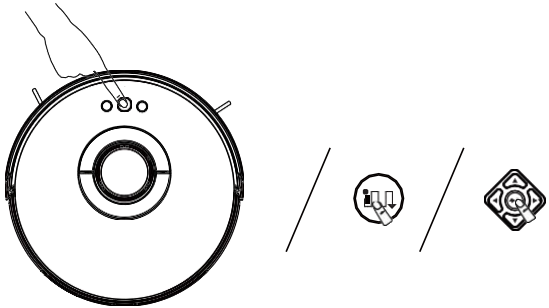

- Robot will return to the Charging Base automatically when the battery level becomes low or when Robot is finished cleaning.
- By default, Robot starts in Auto Cleaning mode when it is turned on.

2. Spot Cleaning

- Robot intensively cleans a specific area in a spiral pattern within the 5 ft radius, useful if there is a concentrated area of dust or debris.
- Press  on the Remote Handset repeatedly, until the icon of Spot Cleaning Mode is displayed on the screen

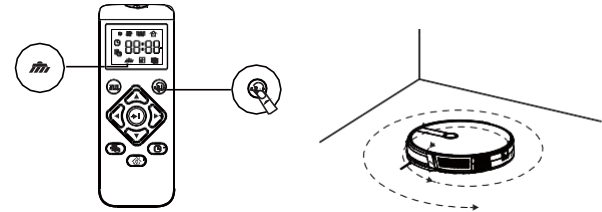

3. Edge Cleaning

- Robot reduces the moving speed when detects a wall and then follows the wall to ensure the edge is cleaned thoroughly. Robot will return to the Charging Dock when finish.
- Press  on the Remote Handset repeatedly, until the icon of Edge Cleaning Mode is displayed on the screen

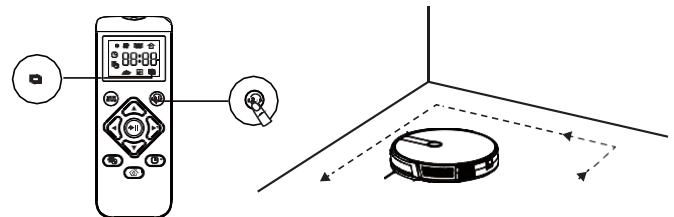

Product Use / Select a Cleaning Mode

4. Single Room Cleaning

Select this mode only when one specific room needs to be cleaned. Make sure to confine Robot to the room by closing the door. Robot will also clean the edges before finish.

Press  on the Remote Handset repeatedly, until the icon of Single Room Cleaning Mode is displayed on the screen

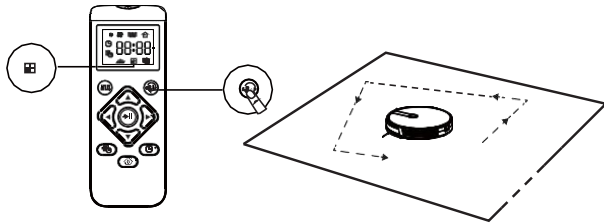

5. Manual Cleaning

You can direct Robot to clean a particular area by using the directional buttons on the Remote Handset.

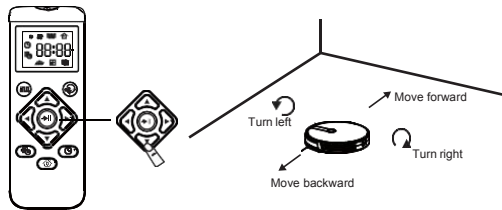







6. Set Time and Scheduled Cleaning

Set Time









- Make sure the time is set correctly to your local time before setting a scheduled cleaning.
- Make sure the Robot is turned on

1. Press  on the Remote Handset. The time will blink on the display
2. Press     to set the “ hour” and “ minute”
3. Press  to save the setting.



Set a Scheduled Cleaning

- You can schedule Robot to start cleaning at a specified time.
- To cancel a previously scheduled cleaning, press and hold  for 3 seconds

1. Press  on the Remote Handset. The time will blink on the display
2. Press     to set the “ hour” and “ minute”
3. Press  to save the setting.



Mopping / Water Tank



- Do not use mopping function with any carpet floor
- Please remove mopping cloth and clean it after mopping is completed.
- Please empty the water tank after each use.

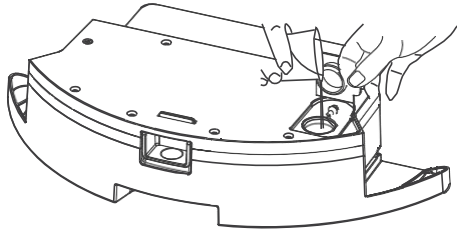

Open the water inflow hole cover, inject water slowly into the water tank.

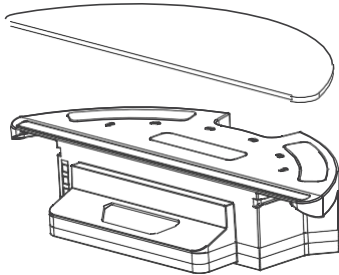

Take out the mopping cloth and place it on top of the water tank. Press the mopping cloth gently to ensure it sticks firmly with water tank.

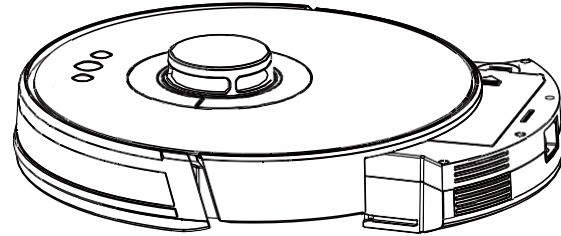

Replace the dust box of the robot with water tank. Mopping is ready.

Cleaning and Maintenance

For optimal performance, follow the instructions below to clean and maintain Robot regularly. The cleaning/replacement frequency will depend on your usage habits of Robot.

Recommended cleaning/replacement frequency:

Robot Part	Cleaning Frequency	Replacement Frequency
Filters	Once every week	Every 2 months
Rolling Brush	Once every week	Every 6-12 months
Side Brushes	Once every month	Every 3-6 months (or when visibly worn)
Brush Guard	Once every month	Every 3-6 months (or when the silicone rubber strip on the brush guard becomes visibly worn)
Sensors	Once every month	
Charging Pins	Once every month	
Swivel Wheel	Once every month	

Clean the DustB α and Filters

1. Press the Dust Box release button to pull the Dust Box out

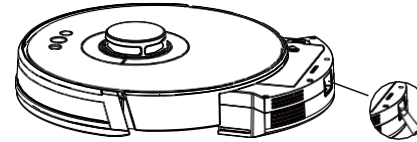

2. Open and empty the Dust Box

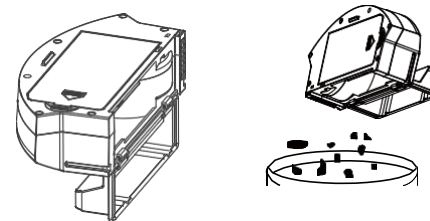

3. Take out the foam filter and high-performance filter

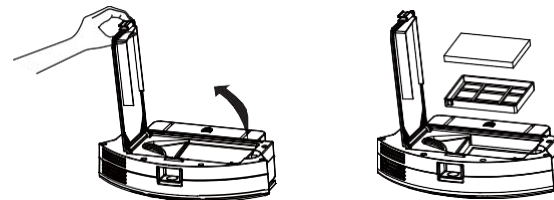

Cleaning and Maintenance

4. Clean the Dust Box and filters with a vacuum cleaner or a cleaning brush.

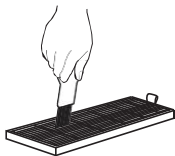

5. Use water to rinse the primary filter screen



6. The dust box can be scrubbed clean with dishcloth.

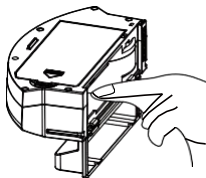

Do not allow water into the fan port during cleaning the dust box

7. Dry the dust box and filter assembly, and keep the robot dry to ensure its service life.



-It is recommended to clean the primary strainer with water every 15 - 30 days after been used. The use life of the high efficiency filter screen is 3 months.

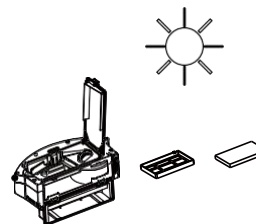

1. Before installing the filter screen, please ensure that the high efficiency filter screen and the primary filter screen are dry.
2. Do not expose the high efficiency strainer and primary strainer into the sun.

8. Put the filters and pre-filter back together in the Dust Box.

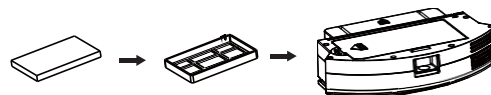

Cleaning and Maintenance

Water Tank and mopping cloth care

1. Press the Water Tank release button to pull the Water Tank out

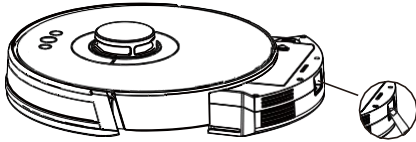

2. Remove the mopping cloth from the Water Tank

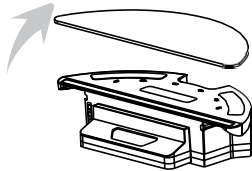

3. Open the water inflow hole cover and empty water from Water Tank

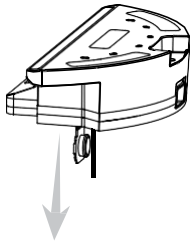

4. Use water to clean the mopping cloth



5. Dry the mopping cloth with sunlight

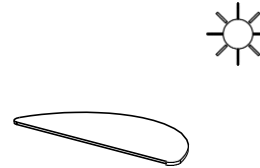

6. The Water Tank can be dried with dry cloth or let it naturally dry with air.

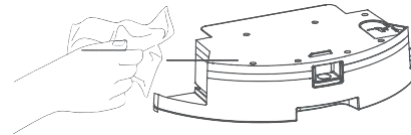

Clean the Rolling Brush

- 1 Pull on the release tabs to unlock the brush guard as shown.
- 2 Lift the rolling brush to remove.
- 3 Clean the rolling brush with the provided cleaning tool or a vacuum cleaner.
- 4 Reinstall the rolling brush by inserting the fixed protruding end first and then clicking into place.
- 5 Press down to snap the brush guard into place

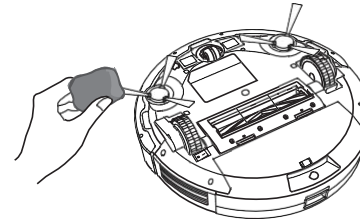
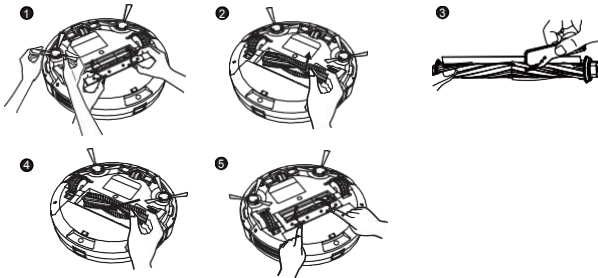

Only use the side brushes when completely dried.

Replace the Side Brushes

The side brushes may become bent or damaged after being used for a period of time. Follow the instructions below to replace them

Pull off the old side brushes and snap the new ones into place

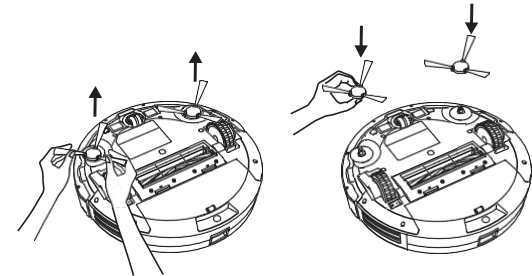

Clean the Side Brushes

Foreign substances, such as hair, can easily get tangled in the side brushes, and dirt may adhere to them. Be sure to clean them regularly

- 1 Remove the side brushes
- 2 Carefully unwind and pull off any hair or string that is wrapped between the main unit and the side brushes
- 3 Use a cloth dampened with warm water to remove dust from the brushes or to gently reshape them.

Clean the Sensors and Charging Pins

To maintain the best performance, clean the drop sensors and charging pins regularly.

Dust off the drop sensors and charging contact pins using a cloth or cleaning brush.



please use dry dishcloth for cleaning, and do not use wet dishcloth to prevent damage caused by water.

Clean up charging dock pins

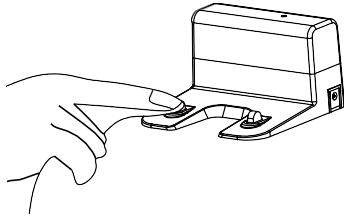

Clean the down-view sensor

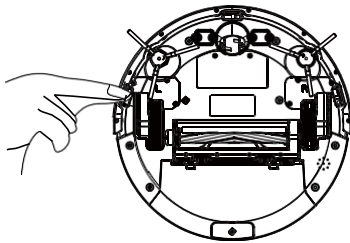

Clean drive wheels and omnidirectional wheel

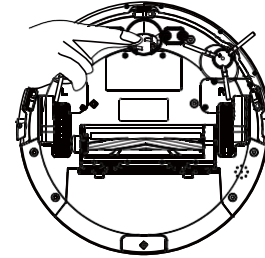

Troubleshooting

No.	Prompt Tone	Cause of Failure	Solution
1	Wheels off the ground	Robot suspended	Please put the Robot back to the ground and press the cleaning key again.
2	Dust Box not installed	Dust box removed and not installed	Return the dust box to the Robot and press the cleaning key again.
3	Battery failure	Abnormal battery charging	Contact our customer service department to test battery.
4	Please check if the wheel is stuck	Wheel jammed	Check whether the wheel is entangled with foreign objects and clean up the entangled objects.
5	Please check if the front collision is stuck	Front impact bracket stuck	Check whether the front collision can rebound normally
6	Robot's Wifi connection failure	Robot connected to server failure	Check whether can access internet when connection is done
7	The battery is low, please charge the Robot	Battery power less than 20%	Robot automatically enters the recharge mode
8	Please check whether the side brush is tangled or jammed	Abnormal edge brushing	Check whether the side brush is wound by wire and clean up the wound.
9	Please move the Robot to the open area.	Robot failed to get out of trouble	Please move the Robot to an empty place and press the cleaning key again

Product Parameter

Classification	Projects	Parameter
Structural class	Diameter	330 mm / 1.08 ft
	Height Net	74mm / 0.25 ft
	weight	2.7 kg / 5.94 lbs
Battery	Voltage	14.8 volts
	Battery	3000 mAh rechargeable lithium battery pack
parameter	Dust box capacity	600 ml
	Charging type	Automatic charging / Manual charging
	Cleaning mode	Auto / Single Room / Edge / Spot / Mopping
	Primary charging time	About 300 minutes
	Working time	About 150 minutes
Robot	Rated power (w)	28w
	Operating voltage (v)	14.8v

* Due to the continuous improvement of the product, this information product is subject to the physical object, and our company reserves the right to update the product.

Component	Harmful Substance					
	Pb/Pb compound	Hg/Hg compound	Cd/Cd compound	Cr(VI)Cr(VI) compound	PBB	PBDE
Plastic	○	○	○	○	○	○
Hardware	×	○	○	○	○	○
Host circuit module	×	○	○	○	○	○
Electronic	○	○	×	○	○	○
Battery	○	○	○	○	○	○
Plug power cord (Metal part)	×	○	○	○	○	○

Description: This form is prepared in accordance with the provisions of SJ/T 11364.

○ : Indicates that the content of the hazardous substance in all homogeneous materials of the part is below the limit requirement specified in the current valid version of GB/T26572.

× : Indicates that the content of the hazardous substance in at least one of the homogeneous materials of the part exceeds the limit requirement stipulated in the current effective version of GB/T26572, and there is no mature alternative in the industry, which meets the environmental protection requirements of the EU RoHS Directive.



The number in this logo indicates that the product has an environmental protection period of 10 years under normal use.

Executive standard:

GB4706.1- 2005
GB4343.1- 2009

GB4706.7- 2014
GB17625.1- 2012

WARNING

- 1、 This appliance can be used by children aged from 8 years and above and persons with reduced physical, sensory or mental capabilities or lack of experience and knowledge if they have been given supervision or instruction concerning use of the appliance in a safe way and understand the hazards involved. Children shall not play with the appliance. Cleaning and user maintenance shall not be made by children without supervision
- 2、 the adapter must be removed from the socket-outlet before cleaning or maintaining the appliance.
- 3、 the appliance must be disconnected from the supply mains when removing the battery;
- 4、 WARNING: For the purposes of recharging the battery, only use the detachable supply unit (model: GQ12-190060-AU) provided with this appliance.

- English: "

This device complies with Industry Canada licence-exempt RSS standard(s). Operation is subject to the following two conditions:

- (1) this device may not cause interference, and
- (2) this device must accept any interference, including interference that may cause undesired operation of the device."

- French:"

Le présent appareil est conforme aux CNR d'Industrie Canada applicables aux appareils radio exempts de licence. L'exploitation est autorisée aux deux conditions suivantes :

- (1) l'appareil n' doit pas produire de brouillage, et
- (2) l'utilisateur de l'appareil doit accepter tout brouillage radioélectrique subi, même si le brouillage est susceptible d'en compromettre le fonctionnement."

FCC ID: 2AT7JR530**FCC Radiation Exposure Statement:**

The transmitter must not be colocated or operated in conjunction with any other antenna or transmitter. This equipment complies with the FCC RF radiation exposure limits set forth for an uncontrolled environment. This equipment should be installed and operated with a minimum distance of 20cm between the radiator and any part of your body.

FCC Warning

This device complies with Part 15 of the FCC Rules. Operation is subject to the following two conditions:

(1) This device may not cause harmful interference, and (2) This device must accept any interference received, including interference that may cause undesired operation.

NOTE 1: This equipment has been tested and found to comply with the limits for a Class B digital device, pursuant to part 15 of the FCC Rules. These limits are designed to provide reasonable protection against harmful interference in a residential installation. This equipment generates, uses and can radiate radio frequency energy and, if not installed and used in accordance with the instructions, may cause harmful interference to radio communications. However, there is no guarantee that interference will not occur in a particular installation. If this equipment does cause harmful interference to radio or television reception, which can be determined by turning the equipment off and on, the user is encouraged to try to correct the interference by one or more of the following measures:

- Reorient or relocate the receiving antenna.
- Increase the separation between the equipment and receiver.
- Connect the equipment into an outlet on a circuit different from that to which the receiver is connected.
- Consult the dealer or an experienced radio/TV technician for help.

NOTE 2: Any changes or modifications to this unit not expressly approved by the party responsible for compliance could void the user's authority to operate the equipment