

Test Report

FCC ID: 2AT7I-S2

Date of issue: Apr. 03, 2020

Report number:	MTi19081312-9E3
Sample description:	4G Wireless Data Terminal
Model(s):	S2
Applicant:	iFREE GROUP (HK) Ltd
Address:	Suite 06, 19/F, Mira Place Tower A, 132 Nathan Road, Tsim Sha Tsui, Kowloon, Hong Kong.
Date of test:	Sept. 19, 2019 to Apr. 03, 2020

Shenzhen Microtest Co., Ltd.
<http://www.mtitest.com>

This test report is valid for the tested samples only. It cannot be reproduced except in full without prior written consent of Shenzhen Microtest Co., Ltd.



Table of Contents

1	General description	4
1.1	Feature of equipment under test (EUT)	4
1.2	Test frequency channel	5
1.3	EUT operation mode	5
1.4	Test conditions	5
1.5	Testing site	5
1.6	Ancillary equipment list	5
1.7	Measurement uncertainty	5
2	Summary of Test Result	6
3	Test facilities and accreditations	7
4.1	Test laboratory	7
4.2	Environmental conditions	7
4.3	Measurement uncertainty	7
4.4	Test software	7
4	List of test equipment	8
5	Test Result	10
4.5	Maximum output power and EIRP & ERP	10
4.6	Peak to average power ratio(PAPR)	16
4.7	Occupied bandwidth	20
4.8	Conducted spurious emissions	23
4.9	Band edge	27
4.10	Radiated spurious emission	31
4.11	Frequency stability	36
	Photographs of the Test Setup	39
	Photographs of the EUT	40



Test Result Certification

Applicant's name: iFREE GROUP (HK) Ltd

Address: Suite 06, 19/F, Mira Place Tower A, 132 Nathan Road, Tsim Sha Tsui, Kowloon, Hong Kong.

Manufacture's name: iFREE GROUP (HK) Ltd

Address: Suite 06, 19/F, Mira Place Tower A, 132 Nathan Road, Tsim Sha Tsui, Kowloon, Hong Kong.

Product name: 4G Wireless Data Terminal

Trademark: MOGO

Model name: S2

Standards: FCC Part 22 Subpart H
FCC Part 24 Subpart E
FCC CFR 47 Part 27

Test procedure: ANSI/TIA-603-E-2016
ANSI C63.26:2015
KDB 971168 D01 Power Meas License Digital Systems v03r01

This device described above has been tested by Shenzhen Microtest Co., Ltd. and the test results show that the equipment under test (EUT) compliance with the FCC requirements. And it is applicable only to the tested sample identified in the report.

Tested by: 

Danny Xu Apr. 03, 2020

Reviewed by: 

Leo Su Apr. 03, 2020

Approved by: 

Tom Xue Apr. 03, 2020

1 General description

1.1 Feature of equipment under test (EUT)

Product name:	4G Wireless Data Terminal
Trade name	MOGO
Model name:	S2
Serial model:	N/A
Difference in series models:	N/A
Frequency range:	WCDMA Band II: TX 1852.4MHz~1907.6MHz; RX 1932.4MHz~1987.6MHz; WCDMA Band IV: TX 1712.4-1752.6 MHz; RX 2112.4-2152.6 MHz WCDMA Band V: TX 826.4MHz~846.6MHz; RX 871.4MHz~891.6MHz;
Modulation type:	QPSK/16QAM for WCDMA bands;
SIM card:	The 4G Wireless Data Terminal has One SIM Card socket
Antenna Type	FPC Antenna
Antenna gain:	WCDMA Band II: 0.33dBi WCDMA Band IV: 0.52dBi WCDMA Band V: 0.76dBi
Hardware version	S2M1_VER.A
Software version	S2_V03.02.07.19101T
Power supply:	DC 5V from adapter or DC 3.8V from battery
Battery:	DC 3.8V 2000mAh
Adapter information:	N/A

1.2 Test frequency channel

Frequency Band	Frequency	Channel	Frequency(MHz)
WCDMA Band II	Low	9262	1852.4
	Middle	9400	1880
	High	9538	1907.6
WCDMA Band IV	Low	1312	1712.4
	Middle	1450	1732.6
	High	1513	1752.6
WCDMA Band V	Low	4132	826.4
	Middle	4183	836.4
	High	4233	846.6

1.3 EUT operation mode

During testing, RF test program provided by the manufacture to control the Tx operation followed the test requirement. The EUT is configured to transmit continuously (duty cycle > 98 %) at the maximum power control level.

1.4 Test conditions

During the measurement the environmental conditions were within the listed ranges:

- Temperature: 20°C~30°C
- Humidity: 30%~70%
- Atmospheric pressure: 98kPa~101kPa

1.5 Testing site

Test Site	Shenzhen Microtest Co., Ltd.
Test Site Location	No.102A & 302A, East Block, Hengfang Industrial Park, Xingye Road, Xixiang, Bao'an District, Shenzhen, Guangdong, China
FCC Registration No.:	448573

1.6 Ancillary equipment list

Equipment	Model	S/N	Manufacturer	Certificate type
/	/	/	/	/

1.7 Measurement uncertainty

Measurement Uncertainty for a Level of Confidence of 95 %, $U=2xUc(y)$

RF frequency	1×10^{-7}
RF power, conducted	± 1 dB
Conducted emission(150kHz~30MHz)	± 2.5 dB
Radiated emission(30MHz~1GHz)	± 4.2 dB
Radiated emission (above 1GHz)	± 4.3 dB
Temperature	± 1 degree
Humidity	± 5 %



2 Summary of Test Result

Item	FCC Part No.	Description of Test	Result
1	2.1046, 22.913(a); 24.232(c) 27.50(d) (4)	Maximum output power	Pass
2	2.1046, 22.913(a); 24.232(c) 27.50(d)(5)	Peak to average power ratio(PAPR)	Pass
3	2.1046, 22.913(a); 24.232(c) 27.50(d)(4)	Transmitter Radiated Power (EIRP/ERP)	Pass
4	2.1049; 22.917(b); 24.238(b) 27.53(h)	Occupied Bandwidth	Pass
5	2.1051; 22.917(a); 24.238(a) 27.53(h)	Conducted spurious emissions	Pass
6	2.1051; 22.917(b); 24.238(b) 27.53(h)	Spurious emissions at band edge	Pass
7	2.1053; 22.917(a); 24.238(a) 27.53(h)	Radiated spurious emissions	Pass
8	2.1055; 22.355; 24.235 27.54	Frequency Stability	Pass

3 Test facilities and accreditations

4.1 Test laboratory

Test Laboratory	Shenzhen Microtest Co., Ltd
Location	No.102A & 302A, East Block, Hengfang Industrial Park, Xingye Road, Xixiang, Bao'an District, Shenzhen, Guangdong, China
FCC Registration No.:	448573

4.2 Environmental conditions

Temperature:	15°C~35°C
Humidity	20%~75%
Atmospheric pressure	98kPa~101kPa

4.3 Measurement uncertainty

Measurement Uncertainty for a Level of Confidence of 95 %, $U=2xUc(y)$

RF frequency	1×10^{-7}
RF power, conducted	± 1 dB
Conducted emission(150kHz~30MHz)	± 2.5 dB
Radiated emission(30MHz~1GHz)	± 4.2 dB
Radiated emission (above 1GHz)	± 4.3 dB
Temperature	± 1 degree
Humidity	± 5 %

4.4 Test software

Software Name	Manufacturer	Model	Version
WCDMA	Shenzhen JS tonskend co., ltd	JS1120-2	2.1.5.10

4 List of test equipment

Equipment No.	Equipment Name	Manufacturer	Model	Serial No.	Calibration date	Due date
MTI-E004	EMI Test Receiver	Rohde&schwarz	ESPI7	100314	2018/10/09	2019/10/08
					2019/10/09	2020/10/08
MTI-E006	TRILOG Broadband Antenna	schwarzbeck	VULB 9163	9163-872	2018/10/15	2019/10/14
					2019/10/15	2020/10/14
MTI-E007	Double Ridged Broadband Horn Antenna	schwarzbeck	BBHA 9120 D	9120D-1145	2018/10/13	2019/10/12
					2019/10/13	2020/10/12
MTI-E014	amplifier	Hewlett-Packard	8447D	3113A06150	2018/10/09	2019/10/08
					2019/10/09	2020/10/08
MTI-E036	Single path vehicle AMN(LISN)	Schwarzbeck	NNBM 8124	01175	2018/10/09	2019/10/08
					2019/10/09	2020/10/08
MTI-E038	Low noise active vertical monopole antenna	Schwarzbeck	VAMP 9243	#565	2018/10/16	2019/10/15
					2019/10/16	2020/10/15
MTI-E039	Biconical antenna	Schwarzbeck	BBA 9106	#164	2018/10/15	2019/10/14
					2019/10/15	2020/10/14
MTI-E041	MXG Vector Signal Generator	Agilent	N5182A	MY49060455	2019/04/16	2020/04/15
MTI-E042	ESG Series Analog signal generator	Agilent	E4421B	GB40051240	2019/05/21	2020/05/20
MTI-E044	Thermometer clock humidity monitor	-	HTC-1	/	2019/04/17	2020/04/16
MTI-E062	Log Periodic Antenna	Schwarzbeck	VUSLP 9111B	#312	2018/04/11	2020/04/10
MTI-E063	Log Periodic Dipole Array Antenna	ETS-LINDGREN	3148B	00224524	2018/04/11	2020/04/10
MTI-E065	Amplifier	EMtrace	RP06A	00117	2019/04/29	2020/04/28
MTI-E066	Comprehensive test instrument	Rohde&schwarz	CMW500	149155	2019/04/16	2020/04/15
MTI-E071	PXA Signal Analyzer	Agilent	N9030A	MY51350296	2018/10/25	2019/10/24
					2019/10/25	2020/10/24
MTI-E076	EMI Test Receiver	Rohde&schwarz	ESIB26	100273	2019/04/16	2020/04/15
MTI-E078	Synthesized Sweeper	Agilent	83752A	3610A01957	2019/04/16	2020/04/15
MTI-E079	DC Power Supply	Agilent	E3632A	MY40027695	2019/04/16	2020/04/15
MTI-E093	Artificial mains network	3ctest	LISN J50	ES3911805	2019/04/16	2020/04/15
MTI-E096	Power amplifier	Space-Dtronics	EWLNA0118G-P40	1852001	2019/04/29	2020/04/28
MTI-E097	Current Probe	SOLAR ELECTRONICS CO.	9207-1	220095-1	2019/04/17	2020/04/16
MTI-E098	Loop Sensor	SOLAR ELECTRONICS CO.	7334-1	220095-2	2019/04/21	2020/04/20



Note: the calibration interval of the above test instruments is 12 months and the calibrations are traceable to international system unit (SI).

5 Test Result

4.5 Maximum output power and EIRP & ERP

5.1.1 Limit

For FCC 22.913: The ERP of mobile transmitters and auxiliary test transmitters must not exceed 7 Watts.

For FCC 24.234: Mobile and portable stations are limited to 2 watts EIRP and the equipment must employ a means for limiting power to the minimum necessary for successful communications. In measuring transmissions in this band using an average power technique, the peak-to-average ratio (PAR) of the transmission may not exceed 13dB.

For 27.50 (d)(4) The following power and antenna height requirements apply to stations transmitting in the 1710–1755 MHz and 2110–2155 MHz bands: Fixed, mobile, and portable (hand-held) stations operating in the 1710–1755 MHz band are limited to 1 watt EIRP.

5.1.2 Test method

For Conducted output power:

1. Use a universal radio communication tester, the output power of EUT was measured at the antenna terminal. The path loss was calibrated and entered as an offset into the test equipment.
2. The EUT was configured to transmit on maximum power by the radio communication tester.
3. Measured the peak and average powers.

For EIRP & ERP:

1. In many cases, the RF output power limits for licensed digital transmission devices is specified in terms of effective radiated power (ERP) or equivalent isotropic radiated power (EIRP). Typically, ERP is specified when the operating frequency is less than or equal to 1 GHz and EIRP is specified when the operating frequency is greater than 1 GHz. Both are determined by adding the transmit antenna gain to the conducted RF output power with the primary difference between the two being that when determining the ERP, the transmit antenna gain is referenced to a dipole antenna (i.e., dBd) whereas when determining the EIRP, the transmit antenna gain is referenced to an isotropic antenna (dBi).

2. The relevant equation for determining the ERP or EIRP from the conducted RF output power measured using the guidance provided above is:

$$\text{ERP/EIRP} = P_{\text{Meas}} + \text{GT} - \text{LC}$$

where:

ERP/EIRP = effective or equivalent radiated power, respectively (expressed in the same units as P_{Meas} , typically dBW or dBm);

P_{Meas} = measured transmitter output power or PSD, in dBm or dBW;

GT = gain of the transmitting antenna, in dBd (ERP) or dBi (EIRP);

dBd (ERP) = dBi (EIRP) - 2.15 dB

LC = signal attenuation in the connecting cable between the transmitter and antenna, in dB.

For devices utilizing multiple antennas, KDB 662911 provides guidance for determining the effective array transmit antenna gain term to be used in the above equation.



5.1.3 Test setup

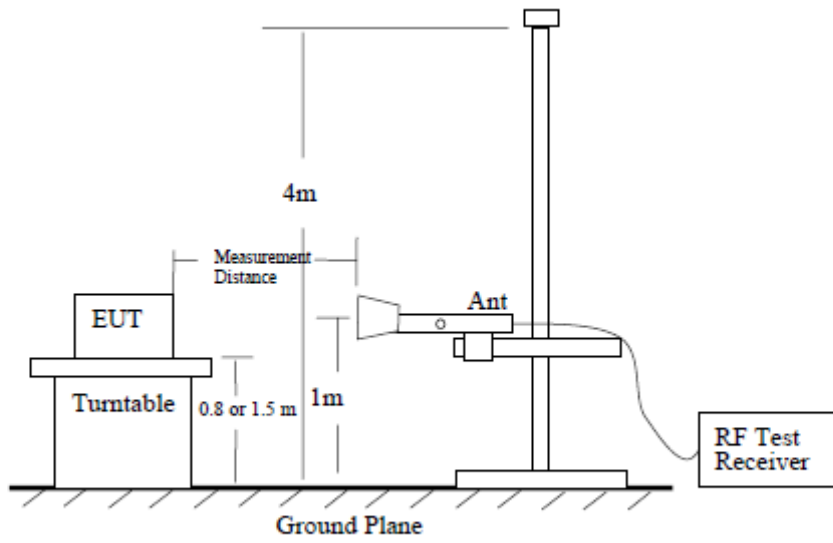

Figure 6—Test site-up for radiated ERP and/or EIRP measurements



5.1.4 Test Result

For Conducted output power:

Output Power for WCDMA BAND II

Mode	Frequency(MHz)	Maximum Average Output Power
HSDPA Subtest 1	1852.4	21.74
	1880	21.85
	1907.6	21.83
HSDPA Subtest 2	1852.4	21.32
	1880	21.41
	1907.6	21.37
HSDPA Subtest 3	1852.4	21.36
	1880	21.40
	1907.6	21.37
HSDPA Subtest 4	1852.4	21.36
	1880	21.40
	1907.6	21.37
HSUPA Subtest 1	1852.4	21.33
	1880	21.32
	1907.6	20.94
HSUPA Subtest 2	1852.4	20.65
	1880	20.79
	1907.6	20.54
HSUPA Subtest 3	1852.4	20.11
	1880	20.12
	1907.6	20.23
HSUPA Subtest 4	1852.4	20.48
	1880	20.41
	1907.6	20.90
HSUPA Subtest 5	1852.4	21.82
	1880	21.59
	1907.6	21.56



Output Power for WCDMA BAND IV

Mode	Frequency(MHz)	Maximum Average Output Power
HSDPA Subtest 1	1712.4	22.23
	1732.6	22.48
	1752.6	22.55
HSDPA Subtest 2	1712.4	21.77
	1732.6	22.05
	1752.6	22.16
HSDPA Subtest 3	1712.4	21.81
	1732.6	22.10
	1752.6	22.11
HSDPA Subtest 4	1712.4	21.75
	1732.6	22.12
	1752.6	22.12
HSUPA Subtest 1	1712.4	21.55
	1732.6	22.04
	1752.6	21.50
HSUPA Subtest 2	1712.4	21.08
	1732.6	21.29
	1752.6	21.34
HSUPA Subtest 3	1712.4	20.88
	1732.6	21.35
	1752.6	20.62
HSUPA Subtest 4	1712.4	21.46
	1732.6	21.20
	1752.6	21.44
HSUPA Subtest 5	1712.4	22.02
	1732.6	22.17
	1752.6	22.19



Output Power for WCDMA BAND V

Mode	Frequency(MHz)	Maximum Average Output Power
HSDPA Subtest 1	826.4	20.14
	836.4	20.25
	846.6	20.42
HSDPA Subtest 2	826.4	19.68
	836.4	19.86
	846.6	19.72
HSDPA Subtest 3	826.4	19.61
	836.4	19.93
	846.6	19.82
HSDPA Subtest 4	826.4	19.63
	836.4	19.87
	846.6	19.82
HSUPA Subtest 1	826.4	19.13
	836.4	19.94
	846.6	19.92
HSUPA Subtest 2	826.4	18.93
	836.4	19.01
	846.6	19.16
HSUPA Subtest 3	826.4	18.46
	836.4	18.16
	846.6	18.17
HSUPA Subtest 4	826.4	19.06
	836.4	19.08
	846.6	19.11
HSUPA Subtest 5	826.4	19.92
	836.4	20.10
	846.6	20.08

For EIRP & ERP:

For WCDMA BAND II

Frequency	Polarization	SG Level	Cable Loss	Antenna Gain	EIRP	EIRP
(MHz)		(dBm)	(dB)	(dB)	(dBm)	(W)
1852.4	H	21.22	0.47	0.33	21.08	0.1282
1880	H	21.12	0.47	0.33	20.98	0.1253
1907.6	H	21.33	0.46	0.33	21.20	0.1318
1852.4	V	21.14	0.47	0.33	21.00	0.1259
1880	V	21.36	0.47	0.33	21.22	0.1324
1907.6	V	21.45	0.46	0.33	21.32	0.1355

Note: EIRP=SG Level+ Cable Loss + Antenna Gain

For WCDMA BAND IV

Frequency	Polarization	SG Level	Cable Loss	Antenna Gain	EIRP	EIRP
(MHz)		(dBm)	(dB)	(dB)	(dBm)	(W)
1712.4	H	22.12	0.39	0.52	22.25	0.1679
1732.6	H	22.16	0.35	0.52	22.33	0.1710
1752.6	H	22.34	0.32	0.52	22.54	0.1795
1712.4	V	21.65	0.39	0.52	21.78	0.1507
1732.6	V	21.51	0.35	0.52	21.68	0.1472
1752.6	V	22.18	0.32	0.52	22.38	0.1730

Note: EIRP= SG Level+ Cable Loss + Antenna Gain

For WCDMA BAND V

Radiated Power (ERP) for UMTS band V							
Frequency	Polarization	SG Level	Cable Loss	Antenna Gain	Correction	(ERP)	ERP
(MHz)		(dBm)	(dB)	(dB)	(dBi)	(dBm)	(W)
826.4	H	21.91	0.39	0.76	2.15	20.13	0.1030
836.4	H	22.03	0.35	0.76	2.15	20.29	0.1069
846.6	H	21.78	0.32	0.76	2.15	20.07	0.1016
826.4	V	22.36	0.39	0.76	2.15	20.58	0.1143
836.4	V	21.85	0.35	0.76	2.15	20.11	0.1026
846.6	V	21.08	0.32	0.76	2.15	19.37	0.0865

Note: ERP= SG Level+ Cable Loss + Antenna Gain - Correction

4.6 Peak to average power ratio(PAPR)

5.1.5 Limit

The peak-to-average power ratio (PAPR) of the transmitter output power must not exceed 13 dB. The PAPR measurements should be made using either an instrument with complementary cumulative distribution function (CCDF) capabilities to determine that PAPR will not exceed 13 dB for more than 0.1 percent of the time or other Commission approved procedure. The measurement must be performed using a signal corresponding to the highest PAPR expected during periods of continuous transmission.

5.1.6 Test method

The EUT was connected to Spectrum Analyzer and Base Station via power divider. The RF output of EUT was connected to the spectrum analyzer by RF cable and attenuator. The path loss was compensated to the results for each measurement.

Set the number of counts to a value that stabilizes the measured CCDF curve.

Set the measurement interval to 1 ms.

Record the maximum PAPR level associated with a probability of 0.1%.



- a) Refer to instrument's analyzer instruction manual for details on how to use the power statistics/CCDF function;
- b) Set resolution/measurement bandwidth \geq signal's occupied bandwidth;
- c) Set the number of counts to a value that stabilizes the measured CCDF curve;
- d) Set the measurement interval as follows:
 - 1) for continuous transmissions, set to 1 ms,
 - 2) for burst transmissions, employ an external trigger that is synchronized with the EUT burst timing sequence, or use the internal burst trigger with a trigger level that allows the burst to stabilize and set the measurement interval to a time that is less than or equal to the burst duration.
- e) Record the maximum PAPR level associated with a probability of 0.1%.



5.1.7 Test Result

Cellular Band						
Modes	WCDMA BAND II			WCDMA BAND IV		
Channel	9262 (Low)	9400 (Mid)	9538 (High)	1312 (Low)	1450 (Mid)	1513 (High)
Frequency(MHz)	1852.4	1880	1907.6	1712.4	1732.6	1752.6
Peak-to-Average Ratio (dB)	3.18	2.93	2.84	3.12	3.29	3.20

Cellular Band						
Modes	WCDMA BAND V			/		
Channel	4132 (Low)	4183 (Mid)	4233 (High)	/	/	/
Frequency(MHz)	826.4	836.4	846.6	/	/	/
Peak-to-Average Ratio (dB)	2.55	3.07	2.64	/	/	/

Test plot	
(WCDMA BAND II)	(WCDMA BAND IV)
Peak-to-Average Ratio on channel 9262	Peak-to-Average Ratio on channel 1312
	
Peak-to-Average Ratio on channel 9400	Peak-to-Average Ratio on channel 1450
	
Peak-to-Average Ratio on channel 9538	Peak-to-Average Ratio on channel 1513
	



Test plot	
(WCDMA BAND V)	/
Peak-to-Average Ratio on channel 4132	/
	/
Peak-to-Average Ratio on channel 4183	/
	/
Peak-to-Average Ratio on channel 4233	/
	/

Note: all modes of EUT have been tested; only the data of worst case mode is reported. Worst mode is HSDPA

4.7 Occupied bandwidth

5.1.8 Test method

1. The EUT was directly connected to the spectrum analyzer and Base station via power splitter as show in the block diagram above.
2. The resolution bandwidth of the Spectrum Analyzer is set to at least 1% of the occupied bandwidth.
3. The low, middle and the high channels are selected to perform tests respectively.
4. Set the frequency range of the Spectrum Analyzer suitably to capture the waveform; search peak; make a line whose value is 26dB lower than the peak; mark two points which the line intersected the waveform at; finally record the delta of the two points as the occupied bandwidth and the plot.
5. Set the Spectrum Analyzer Occupied bandwidth function to measure the 99% occupied bandwidth.

5.1.9 Test result

Channel	Frequency (MHz)	26dB Bandwidth (MHz)	99% Bandwidth (MHz)
WCDMA Band II			
9262	1852.4	4.714	4.1283
9400	1880	4.735	4.1381
9538	1907.6	4.747	4.1499
WCDMA Band VI			
1312	1712.4	4.709	4.1350
1450	1732.6	4.702	4.1357
1513	1752.6	4.715	4.1340
WCDMA Band V			
4132	826.4	4.784	4.1558
4183	836.4	5.934	4.1444
4233	846.6	5.330	4.1530



WCDMA Band II – 1852.4MHz

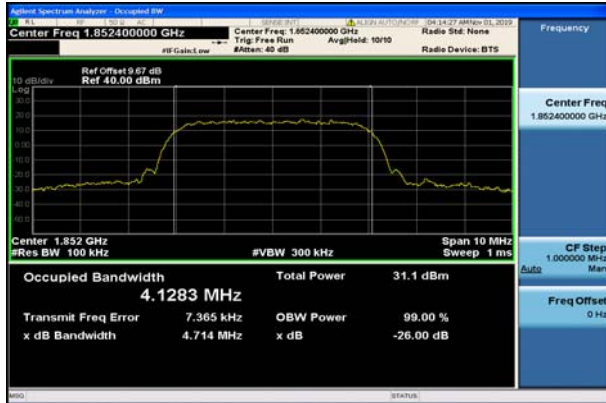

WCDMA Band IV –1712.4MHz

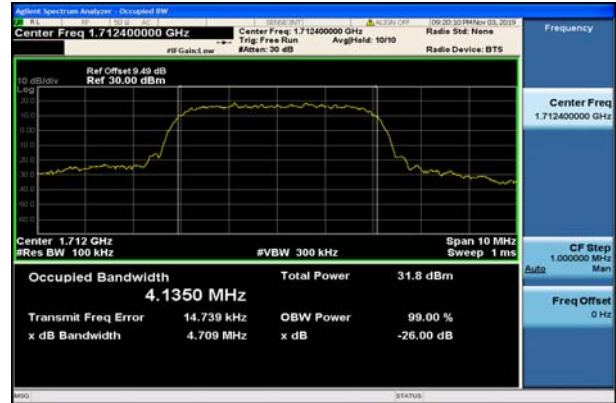

WCDMA Band II - 1880MHz

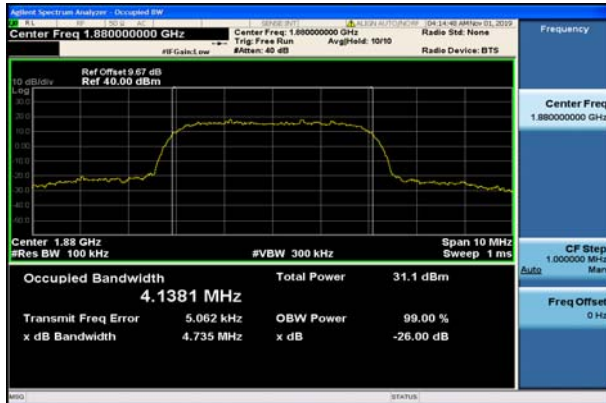

WCDMA Band IV –1732.6.0MHz



WCDMA Band II – 1907.6MHz

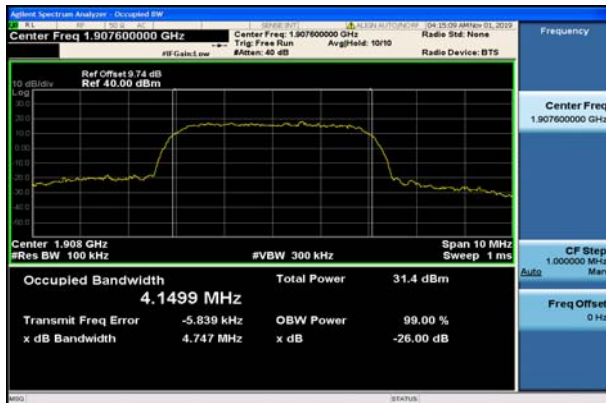

WCDMA Band IV –1752.6MHz



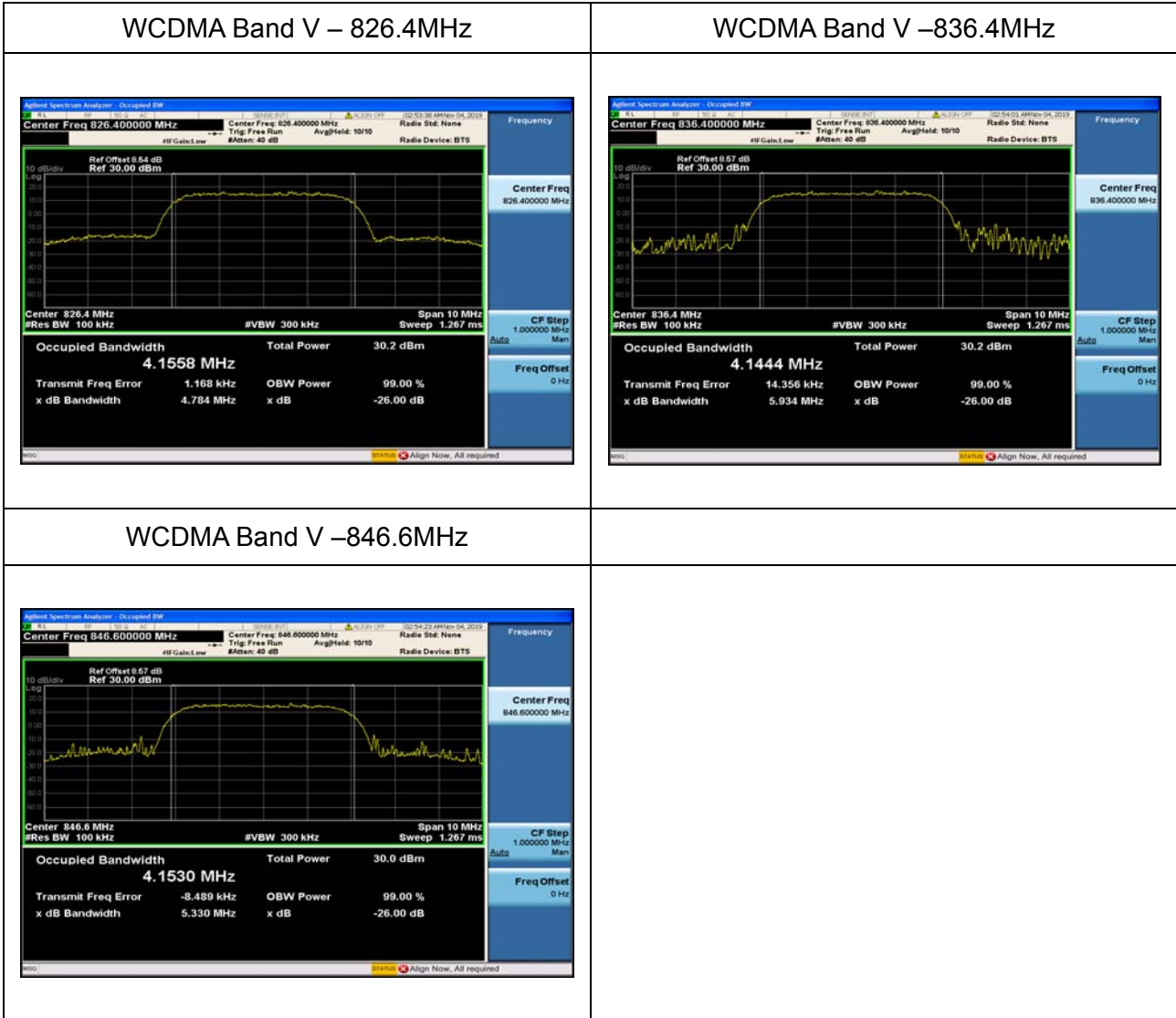

Note: all modes of EUT have been tested; only the data of worst case mode is reported. Worst mode is HSDPA

4.8 Conducted spurious emissions

5.1.10 Limits

The power of any emission outside of the authorized operating frequency ranges must be attenuated below the transmitting power (P) by a factor of at least $43+10\log(P)$ dB

5.1.11 Test method

1, The EUT was directly connected to the spectrum analyzer and Base station via power splitter as show in the block diagram above.

2, Spectrum Setting:

Frequency bellow 1 GHz: RBW=100 kHz, VBW=300 kHz.

Frequency above 1 GHz: RBW=1 MHz, VBW=3 MHz.

3, The low, middle and high channels of each band and mode's spurious emissions for 30 MHz to 10th Harmonic were measured by Spectrum analyzer.

5.1.12 Test result

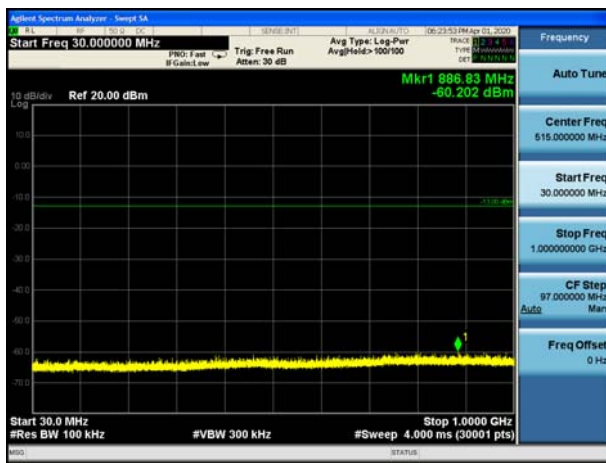
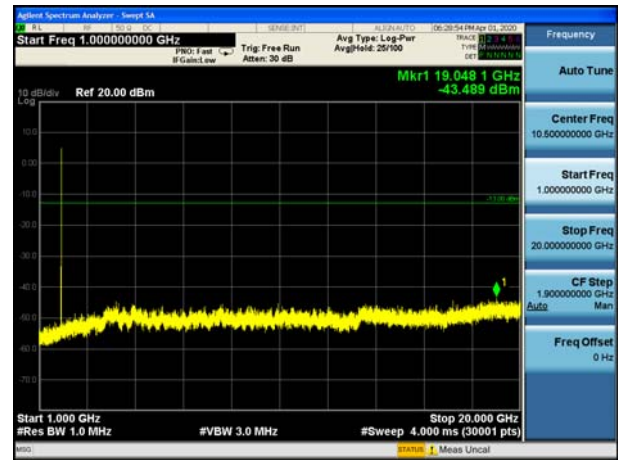
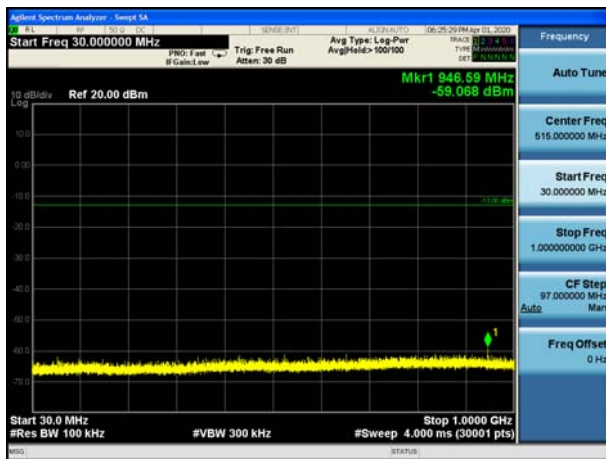
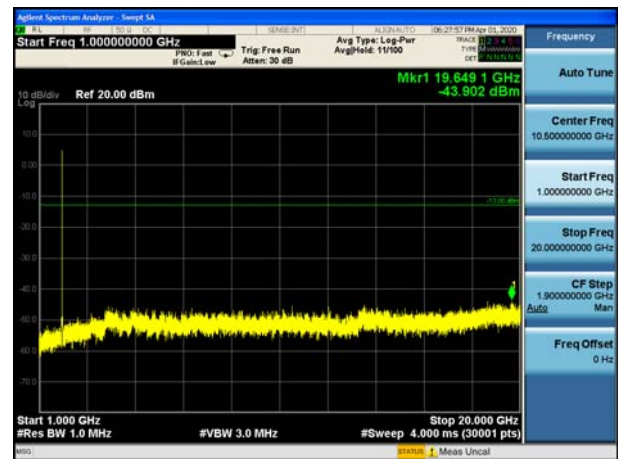
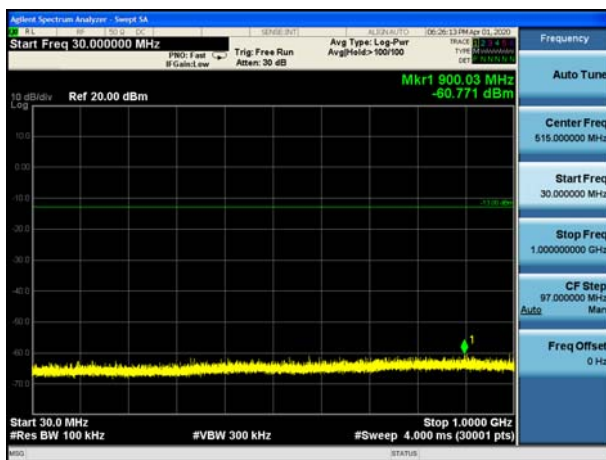
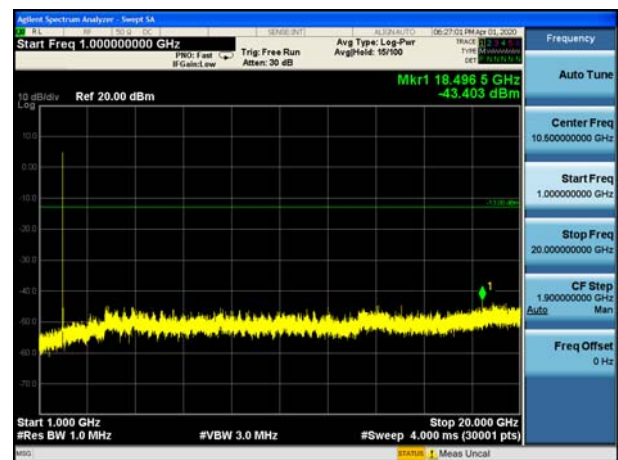
WCDMA Band II
Low Channel – 30MHz-1GHz

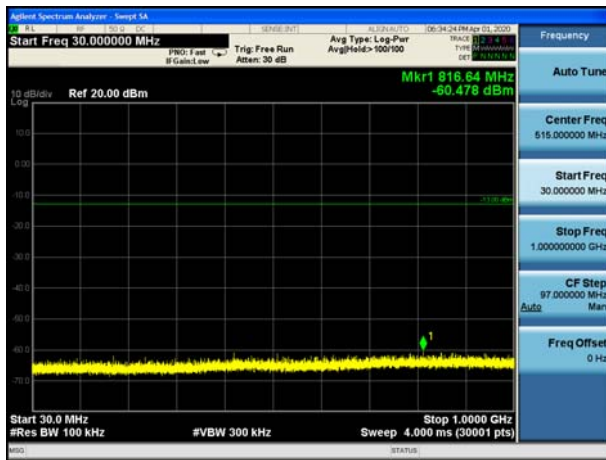
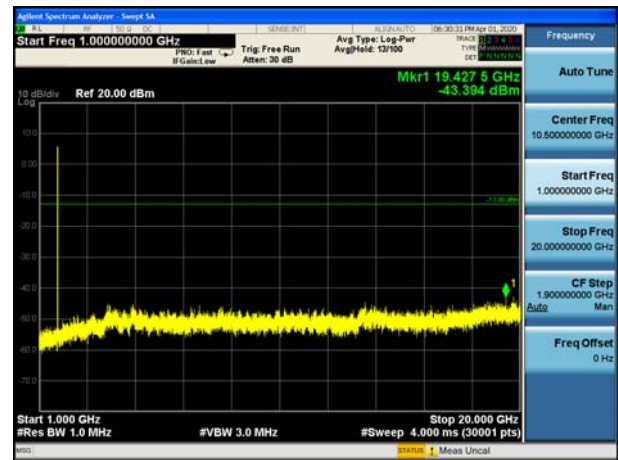
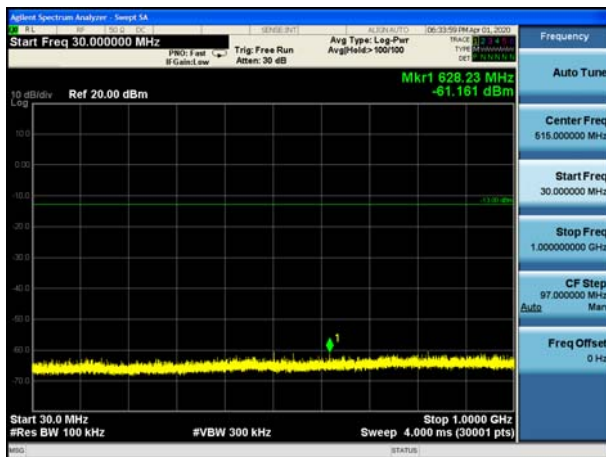
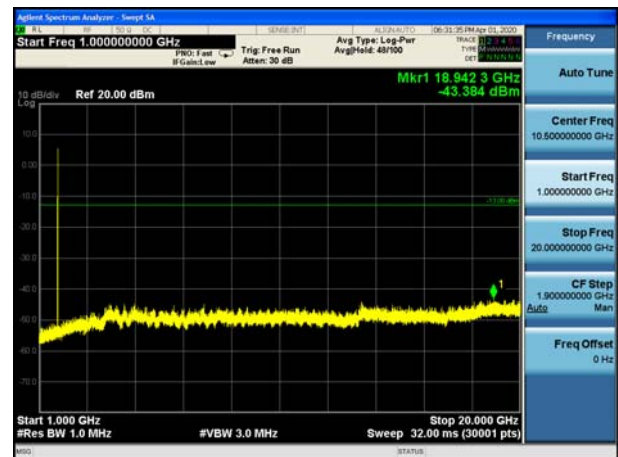
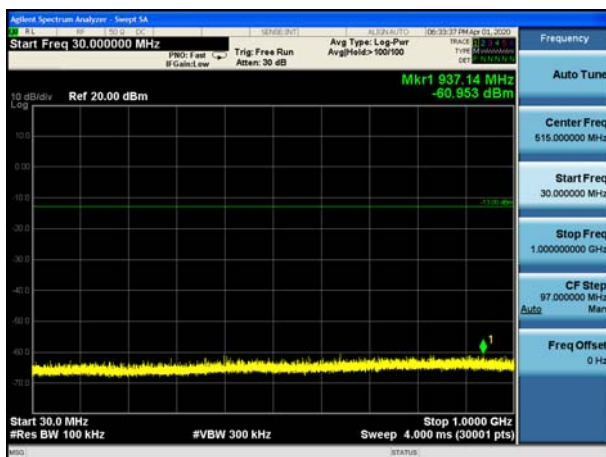
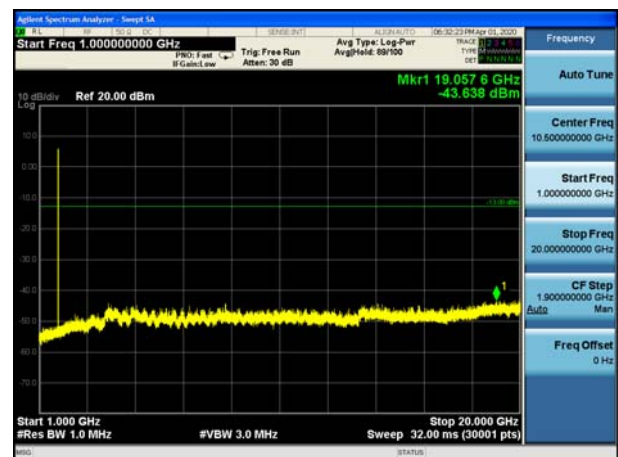
Low Channel –1GHz - 20GHz

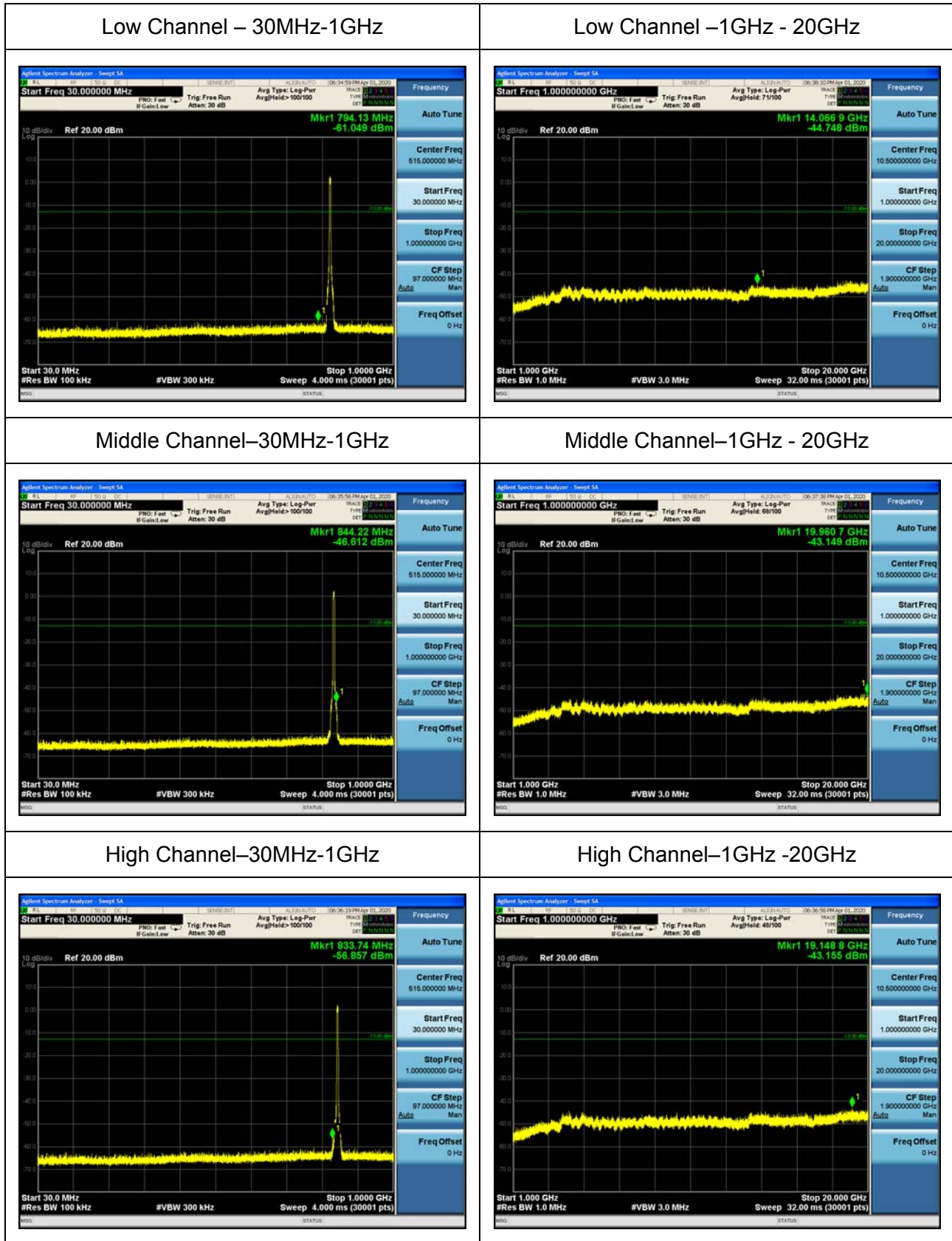
Middle Channel– 30MHz-1GHz

Middle Channel– 1GHz-20GHz

High Channel– 30MHz-1GHz

High Channel–1GHz - 20GHz

WCDMA Band IV
Low Channel – 30MHz-1GHz

Low Channel –1GHz - 20GHz

Middle Channel–30MHz-1GHz

Middle Channel–1GHz - 20GHz

High Channel–30MHz-1GHz

High Channel–10GHz - 2GHz

WCDMA Band V

Note: all modes of EUT have been tested; only the data of worst case mode is reported. Worst mode is HSDPA



4.9 Band edge

5.1.13 Limits

The power of any emission outside of the authorized operating frequency ranges must be attenuated below the transmitting power (P) by a factor of at least $43+10\log(P)$ dB, for all power levels +30 dBm to 0 dBm, this becomes a constant specification limit of -13 dBm

5.1.14 Test method

The testing follows FCC KDB 971168 v03r01 Section 6.0.

The EUT was connected to Spectrum Analyzer and Base Station via power divider.

The RF output of EUT was connected to the spectrum analyzer by RF cable and attenuator.

The path loss was compensated to the results for each measurement.

The band edges of low and high channels for the highest RF powers were measured.

The RF fundamental frequency should be excluded against the limit line in the operating frequency band.

The limit line is derived from $43 + 10\log(P)$ dB below the transmitter power P(Watts)

= $P(W) - [43 + 10\log(P)]$ (dB)

= $[30 + 10\log(P)]$ (dBm) - $[43 + 10\log(P)]$ (dB)

= -13dBm.

5.1.15 Test result



WCDMA Band II – Left band



WCDMA Band II – Right band





WCDMA Band IV – Left band



WCDMA Band IV– Right band





WCDMA Band V – Left band



WCDMA Band V – Right band



Note: all modes of EUT have been tested; only the data of worst case mode is reported. Worst mode is HSDPA



4.10 Radiated spurious emission

5.1.16 Limit

The power of any emission outside of the authorized operating frequency ranges must be attenuated below the transmitting power (P) by a factor of at least $43+10\log(P)$ dB

5.1.17 Test method

1. The test system setup as show in the block diagram above.
2. The EUT was placed on an non-conductive rotating platform in an anechoic chamber. The radiated spurious emissions from 30MHz to 10th harmonious of fundamental frequency were measured at 3 m with a test antenna and a spectrum analyzer with RBW=1 MHz, VBW=1 MHz, peak detector settings.
3. During the measurement, the EUT was enforced in maximum power and linked with a base station. All the spurious emissions at 3m were measured by rotation of the turntable and the test antenna raised and lowered over a range from 1 to 4 meters in both horizontally and vertically polarized orientations.
4. When found the maximum level of emissions from the EUT. Remove the EUT and replace it with substitution antenna. A signal generator was connected to the substitution antenna by a non-radiating cable. The absolute levels of the spurious emissions were measured by the substitution.

Spurious emissions in dB= $10 \log(\text{TX power in Watts}/0.001)$ -the absolute level

Spurious attenuation limit in dB= $43+10 \log(\text{power out in Watts})$.

5.1.18 Test setup

Radiated emission test-up frequency 30MHz~1GHz

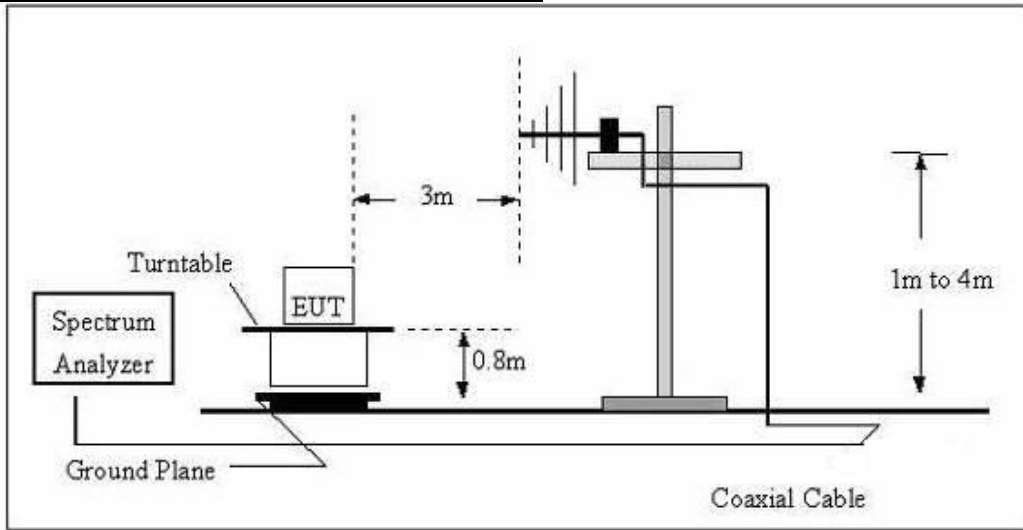

Radiated emission test-up frequency above 1GHz

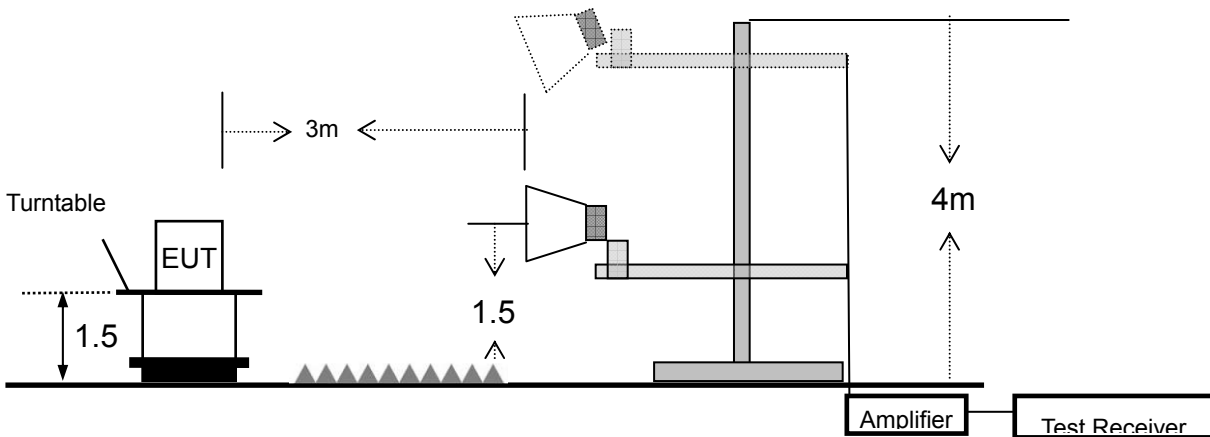

5.1.19 Test Result

Note: All the configuration was tested and only the worse case was reported

For WCDMA (30MHz – 20GHz)

WCDMA Band II _ Low Channel								
Frequency	SG Level	Cable Loss	Diatance	Antenna Gain	Absolute Level	Limit	Margin	Polarization
(MHz)	(dBm)	(dB)	(m)	(dB)	(dBm)	(dBm)	(dB)	
3704.8	-44.42	5.26	3	9.88	-39.80	-13	-26.80	H
5557.2	-48.72	6.11	3	11.36	-43.47	-13	-30.47	H
3704.8	-49.33	5.26	3	9.88	-44.71	-13	-31.71	V
5557.2	-54.99	6.11	3	11.36	-49.74	-13	-36.74	V
WCDMA Band II _ Middle Channel								
Frequency	SG Level	Cable Loss	Diatance	Antenna Gain	Absolute Level	Limit	Margin	Polarization
(MHz)	(dBm)	(dB)	(m)	(dB)	(dBm)	(dBm)	(dB)	
3760	-38.19	5.32	3	10.03	-33.48	-13	-20.48	H
5640	-47.58	6.19	3	11.41	-42.36	-13	-29.36	H
3760	-46.02	5.32	3	10.03	-41.31	-13	-28.31	V
5640	-54.15	6.19	3	11.41	-48.93	-13	-35.93	V
WCDMA Band II _ High Channel								
Frequency	SG Level	Cable Loss	Diatance	Antenna Gain	Absolute Level	Limit	Margin	Polarization
(MHz)	(dBm)	(dB)	(m)	(dB)	(dBm)	(dBm)	(dB)	
3815.2	-49.03	5.36	3	9.62	-44.77	-13	-31.77	H
5722.8	-54.54	6.24	3	11.46	-49.32	-13	-36.32	H
3815.2	-52.66	5.36	3	9.62	-48.40	-13	-35.40	V
5722.8	-57.13	6.24	3	11.46	-51.91	-13	-38.91	V



WCDMA Band IV _ Low Channel								
Frequency	SG Level	Cable Loss	Diatance	Antenna Gain	Absolute Level	Limit	Margin	Polarization
(MHz)	(dBm)	(dB)	(m)	(dB)	(dBm)	(dBm)	(dB)	
1946.4	-44.89	3.86	3	8.56	-40.19	-13	-27.19	H
3424.8	-48.28	4.29	3	6.98	-45.59	-13	-32.59	H
1946.4	-41.93	3.86	3	8.56	-37.23	-13	-24.23	V
3424.8	-41.72	4.29	3	6.98	-39.03	-13	-26.03	V
WCDMA Band IV _ Middle Channel								
Frequency	SG Level	Cable Loss	Diatance	Antenna Gain	Absolute Level	Limit	Margin	Polarization
(MHz)	(dBm)	(dB)	(m)	(dB)	(dBm)	(dBm)	(dB)	
1982.4	-42.75	3.9	3	8.58	-38.07	-13	-25.07	H
3480	-44.40	4.32	3	6.8	-41.92	-13	-28.92	H
1982.4	-38.13	3.9	3	8.58	-33.45	-13	-20.45	V
3480	-42.19	4.32	3	6.8	-39.71	-13	-26.71	V
WCDMA Band IV _ High Channel								
Frequency	SG Level	Cable Loss	Diatance	Antenna Gain	Absolute Level	Limit	Margin	Polarization
(MHz)	(dBm)	(dB)	(m)	(dB)	(dBm)	(dBm)	(dB)	
2015.2	-47.14	3.91	3	9.06	-41.99	-13	-28.99	H
3505.2	-47.84	4.32	3	6.65	-45.51	-13	-32.51	H
2015.2	-44.03	3.91	3	9.06	-38.88	-13	-25.88	V
3505.2	-44.46	4.32	3	6.65	-42.13	-13	-29.13	V



WCDMA Band V _ Low Channel								
Frequency	SG Level	Cable Loss	Diatance	Antenna Gain	Absolute Level	Limit	Margin	Polarization
(MHz)	(dBm)	(dB)	(m)	(dB)	(dBm)	(dBm)	(dB)	
1652.8	-45.99	3.86	3	8.56	-41.29	-13	-28.29	H
2479.2	-48.00	4.29	3	6.98	-45.31	-13	-32.31	H
1652.8	-41.10	3.86	3	8.56	-36.40	-13	-23.40	V
2479.2	-41.92	4.29	3	6.98	-39.23	-13	-26.23	V
WCDMA Band V _ Middle Channel								
Frequency	SG Level	Cable Loss	Diatance	Antenna Gain	Absolute Level	Limit	Margin	Polarization
(MHz)	(dBm)	(dB)	(m)	(dB)	(dBm)	(dBm)	(dB)	
1672.8	-44.13	3.9	3	8.58	-39.45	-13	-26.45	H
2509.2	-45.30	4.32	3	6.8	-42.82	-13	-29.82	H
1672.8	-37.57	3.9	3	8.58	-32.89	-13	-19.89	V
2509.2	-42.28	4.32	3	6.8	-39.80	-13	-26.80	V
WCDMA Band V _ High Channel								
Frequency	SG Level	Cable Loss	Diatance	Antenna Gain	Absolute Level	Limit	Margin	Polarization
(MHz)	(dBm)	(dB)	(m)	(dB)	(dBm)	(dBm)	(dB)	
1693.2	-47.15	3.91	3	9.06	-42.00	-13	-29.00	H
2539.8	-48.70	4.32	3	6.65	-46.37	-13	-33.37	H
1693.2	-43.71	3.91	3	9.06	-38.56	-13	-25.56	V
2539.8	-44.69	4.32	3	6.65	-42.36	-13	-29.36	V

4.11 Frequency stability

5.1.20 Limit

For FCC part 22.355: the carrier frequency of each transmitter in the Public Mobile Services must be maintained within the tolerances 2.5ppm for mobile $\leq 3W$ condition.

For FCC part 24.235: The frequency stability shall be sufficient to ensure that the fundamental emission stays within the authorized frequency block.

For FCC Part 27.

The frequency stability shall be sufficient to ensure that the fundamental emission stays within the authorized frequency block. As this transceiver is considered "Hand carried, battery powered equipment" Section 2.1055(d) (2) applies. This requires that the lower voltage for frequency stability testing be specified by the manufacturer. This transceiver is specified to operate with an input voltage of between 32.4VDC and 41.4VDC, with a nominal voltage of 36VDC. Operation above or below these voltage limits is prohibited by transceiver software in order to prevent improper operation as well as to protect components from overstress. These voltages represent a tolerance from -5.4% to 10.8%. For the purposes of measuring frequency stability these voltage limits are to be used.

5.1.21 Test method

Test Procedures for Temperature Variation:

- 1, The EUT was set up in the thermal chamber and connected with the base station.
- 2, With power off, the temperature was decreased to -30°C and the EUT was stabilized for three hours. Power was applied and the maximum change in frequency was recorded within one minute.
- 3, With power off, the temperature was raised in 10°C set up to 50°C and the EUT was stabilized for three hours. Power was applied and the maximum change in frequency was recorded within one minute.
- 4, measure the carrier frequency error.

Test Procedures for Voltage Variation:

Frequency Stability vs. Temperature: The equipment under test was connected to an external DC power supply and the RF output was connected to communication test set via feed-through attenuators. The EUT was placed inside the temperature chamber. The DC leads and RF output cable exited the chamber through an opening made for the purpose.

After the temperature stabilized for approximately 20 minutes, the frequency output was recorded from the communication test set.

Frequency Stability vs. Voltage: An external variable DC power supply was connected to the battery terminals of the equipment under test. The voltage was set to 115% of the nominal value and was then decreased until the transmitter light no longer illuminated; i.e., the battery end point. The output frequency was recorded for each battery voltage.



5.1.22 Test Result

Band	Voltage (V)	Frequency Error (Hz)	Frequency Error (ppm)
WCDMA Band II	3.42	12	0.000189
	3.8	19	-0.000286
	4.18	24	0.000062

Band	Temperature (°C)	Frequency Error (Hz)	Frequency Error (ppm)
WCDMA Band II	-30	37	-0.000274
	-20	15	-0.000100
	-10	34	-0.000197
	0	29	-0.000120
	10	30	-0.000031
	20	36	-0.000085
	30	22	0.000162
	40	28	0.000344
	50	21	0.000027

Band	Voltage (V)	Frequency Error (Hz)	Frequency Error (ppm)
WCDMA Band IV	3.42	17	0.001073
	3.8	20	0.001917
	4.18	21	0.000827

Band	Temperature (°C)	Frequency Error (Hz)	Frequency Error (ppm)
WCDMA Band IV	-30	16	0.001491
	-20	19	0.001846
	-10	14	0.001729
	0	19	0.001900
	10	25	0.002030
	20	19	0.002410
	30	15	0.001646
	40	16	0.002114
	50	13	0.002001

This test report is valid for the tested samples only. It cannot be reproduced except in full without prior written consent of Shenzhen Microtest Co., Ltd.



Band	Voltage (V)	Frequency Error (Hz)	Frequency Error (ppm)
WCDMA Band V	3.42	24	-0.001333
	3.8	19	-0.000744
	4.18	12	0.000346

Band	Temperature (°C)	Frequency Error (Hz)	Frequency Error (ppm)
WCDMA Band V	-30	33	0.000606
	-20	27	-0.000909
	-10	31	-0.000043
	0	25	-0.001177
	10	21	-0.001740
	20	18	-0.001160
	30	14	-0.000926
	40	19	-0.001272
	50	24	-0.000615

Note:

1. Normal Voltage = 3.8V; Battery End Point (BEP) = 3.42V; Maximum Voltage =4.12V
2. All modes of EUT have been tested; only the data of worst case mode is reported.

Photographs of the Test Setup

Radiated emission

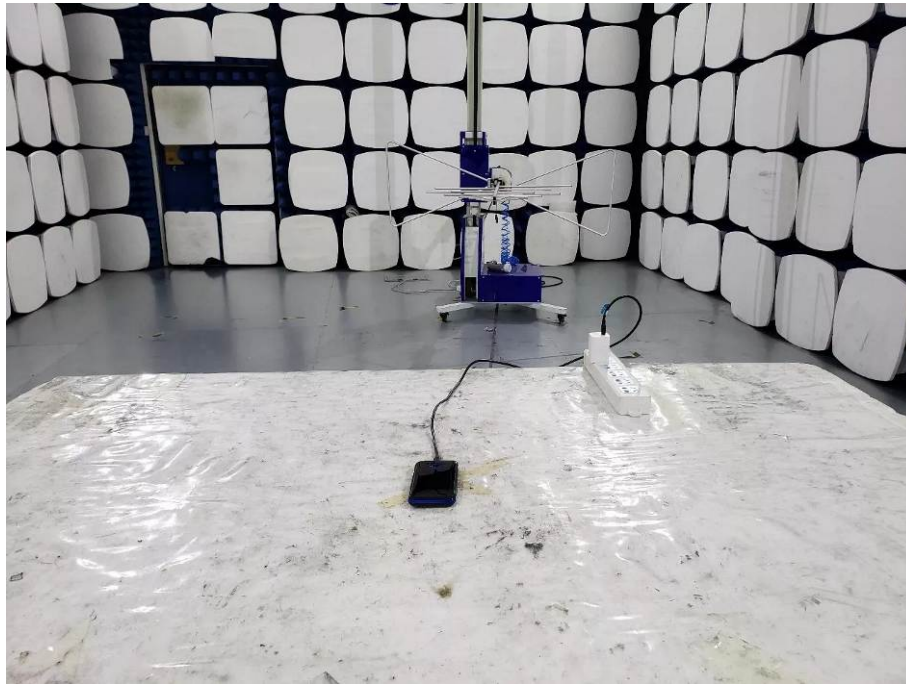



Photographs of the EUT

See the APPENDIX 1: EUT PHOTO in the report No.: MTi19081312-9E1-1.

----END OF REPORT----