

ebuynow ecommerce Ltd

TEST REPORT

SCOPE OF WORK
EMC TESTING-AP550

REPORT NUMBER
190903074GZU-001

ISSUE DATE **[REVISED DATE]**
07-May-2020 [-----]

PAGES
116

DOCUMENT CONTROL NUMBER
FCC WIFI-d
© 2017 INTERTEK



TEST REPORT

Telephone: 86-20-8213 9688

Facsimile: 86-20-3205 7538

www.intertek.com

Applicant Name & Address : ebuynow ecommerce Ltd
1321 Blanshard St Suite 301, Victoria, BC V8W 0B6, Victoria, Canada
Manufacturing Site : Foshan Shunde Alford Electronics Company Limited (subsidiary of Alford Industries Limited)
Xinjiao Industrial Park, DaLiang, ShunDe, Foshan City, Guangdong Province, China.
Intertek Report No: 190903074GZU-001
FCC ID: 2AT76-AP550

Test standards

47 CFR PART 15 Subpart C: 2018 section 15.247

Sample Description

Product : Smart Air Purifier
Model No. : AP550
Electrical Rating : 15Vdc, 1.5A (Power by adaptor)
Adaptor: Model name: NF-15V-1.5C-DC
Input: 100-240Vac, 50/60Hz, 0.8A, Max
Output: 15Vdc, 1.5A
power cable: 1.8 m x 2 wires unscreened DC cable
Serial No. : Not Labeled
Date Received : 01 April 2020
Date Test : 01 April 2020-29 April 2020
Conducted

Prepared and Checked By

Approved By:





Daniel He

Helen Ma

Project Engineer

Team Leader

Intertek Guangzhou

Intertek Guangzhou

This report is for the exclusive use of Intertek's Client and is provided pursuant to the agreement between Intertek and its Client. Intertek's responsibility and liability are limited to the terms and conditions of the agreement. Intertek assumes no liability to any party, other than to the Client in accordance with the agreement, for any loss, expense or damage occasioned by the use of this report. Only the Client is authorized to permit copying or distribution of this report and then only in its entirety. Any use of the Intertek name or one of its marks for the sale or advertisement of the tested material, product or service must first be approved in writing by Intertek. The observations and test results in this report are relevant only to the sample tested. This report by itself does not imply that the material, product, or service is or has ever been under an Intertek certification program.

TEST REPORT

CONTENT

TESTREPORT..... 1

CONTENT..... 3

1.0 TEST RESULT SUMMARY..... 4

2.0 GENERAL DESCRIPTION 5

 2.1 PRODUCT DESCRIPTION.....5

 2.2 RELATED SUBMITTAL(S) GRANTS6

 2.3 TEST METHODOLOGY6

 2.4 TEST FACILITY6

3.0 SYSTEM TEST CONFIGURATION 6

 3.1 JUSTIFICATION6

 3.2 EUT EXERCISING SOFTWARE.....7

 3.3 SPECIAL ACCESSORIES7

 3.4 MEASUREMENT UNCERTAINTY8

 3.5 EQUIPMENT MODIFICATION8

 3.6 SUPPORT EQUIPMENT LIST AND DESCRIPTION.....9

4.0 MEASUREMENT RESULTS 10

 4.1 ANTENNA REQUIREMENT 10

 4.2 6 DB BANDWIDTH (DTS BANDWIDTH)..... 11

 4.3 MAXIMUM PEAK CONDUCTED OUTPUT POWER..... 19

 4.4 PEAK POWER SPECTRAL DENSITY 27

 4.5 OUT OF BAND CONDUCTED EMISSIONS 35

 4.6 OUT OF BAND RADIATED EMISSIONS..... 49

 4.7 RADIATED EMISSIONS IN RESTRICTED BANDS 50

 4.8 BAND EDGES REQUIREMENT 107

 4.9 CONDUCTED EMISSION TEST 113

5.0 TEST EQUIPMENT LIST..... 116

TEST REPORT

1.0 TEST RESULT SUMMARY

| Test Item | Test Requirement | Test Method | Result |
|---|---|---|--------|
| Antenna Requirement | FCC PART 15 C section 15.247 (c) and Section 15.203 | FCC PART 15 C section 15.247 (c) and Section 15.203 | PASS |
| 6 dB Bandwidth (DTS bandwidth) | FCC PART 15 C section 15.247 (a)(2) | ANSI C63.10: Clause 11.8 | PASS |
| Maximum Peak Conducted Output Power | FCC PART 15 C section 15.247(b)(3) | ANSI C63.10: Clause 11.9.1.2 | PASS |
| Peak Power Spectral Density | FCC PART 15 C section 15.247(e) | ANSI C63.10: Clause 11.10.2 | PASS |
| Out of Band Conducted Emissions | FCC PART 15 C section 15.209 &15.247(d) | ANSI C63.10: Clause 11.11 | PASS |
| Out of Band Radiated Emission | FCC PART 15 C section 15.209 &15.247(d) | ANSI C63.10: Clause 11.11, 6.4, 6.5 and 6.6 | N/A |
| Radiated Emissions in Restricted Bands | FCC PART 15 C section 15.209 &15.247(d) | ANSI C63.10: Clause 11.12.1, 6.4, 6.5 and 6.6 | PASS |
| Band Edges Measurement | FCC PART 15 C section 15.247 (d) &15.205 | ANSI C63.10: Clause 11.11 and 11.13 | PASS |
| Conducted Emissions at Mains Terminals | FCC PART 15 C section 15.207 | ANSI C63.10: Clause 6.2 | PASS |
| <p>Remark: N/A: not applicable. Refer to the relative section for the details. EUT: In this whole report EUT means Equipment Under Test. Tx: In this whole report Tx (or tx) means Transmitter. Rx: In this whole report Rx (or rx) means Receiver. RF: In this whole report RF means Radio Frequency. ANSI C63.10: the detail version is ANSI C63.10:2013 in the whole report</p> | | | |

TEST REPORT

2.0 General Description

2.1 Product Description

| | |
|----------------------|---|
| Operating Frequency: | 2412 MHz to 2462 MHz for 802.11b/g/n(HT20) 2422 MHz to 2452 MHz for 802.11n(HT40) |
| Type of Modulation: | 802.11b: DSSS(CCK) 802.11g: OFDM(BPSK/QPSK/16QAM/64QAM) 802.11n: OFDM (BPSK/QPSK/16QAM/64QAM) |
| Transmit Data Rate: | 802.11b: 1/2/5.5/11 Mbps 802.11g: 6/9/12/18/24/36/48/54 Mbps 802.11n(HT20): 6.5/13/19.5/26/39/52/58.5/65Mbps/72.2Mbps 802.11n(HT40):13.5/27/40.5/54/81/108/121.5/135Mbps |
| Number of Channels | 11 Channels for 802.11b/g/n(HT20) 7 Channels for 802.11n(HT40) |
| Channel Separation: | 5 MHz |
| Antenna Type | PCB Layout |
| EUT Power Supply: | 120Vac, 60Hz |

EUT channels and frequencies list:

For 802.11b/g/n(HT20): test frequencies are lowest channel 1: 2412 MHz, middle channel 6: 2437 MHz and highest channel 11: 2462 MHz.

For 802.11n(HT40): test frequencies are lowest channel 3: 2422 MHz, middle channel 6: 2437 MHz and highest channel 9: 2452 MHz.

| Channel | Frequency (MHz) | Channel | Frequency (MHz) |
|---------|-----------------|---------|-----------------|
| 1 | 2412 | 7 | 2442 |
| 2 | 2417 | 8 | 2447 |
| 3 | 2422 | 9 | 2452 |
| 4 | 2427 | 10 | 2457 |
| 5 | 2432 | 11 | 2462 |
| 6 | 2437 | / | |

TEST REPORT

2.2 Related Submittal(s) Grants

This is an application for certification of:
DTS- Part 15 Digital Transmission Systems (WIFI transmitter portion)

Remaining portions are subject to the following procedures:

1. Receiver portion of WIFI: exempt from technical requirement of this Part.
2. Others function: it is evaluated by FCC SDOC

2.3 Test Methodology

Both AC mains line-conducted and radiated emission measurements were performed according to the procedures in ANSI C63.10. Radiated emission measurement was performed in semi-anechoic chamber and conducted emission measurement was performed in shield room. For radiated emission measurement, preliminary scans and final tests were performed in the semi-anechoic chamber to determine the worst case modes. All radiated tests were performed at an antenna to EUT distance of 3 meters, unless stated otherwise.

2.4 Test Facility

All tests were performed at:
Room102/104, No 203, KeZhu Road, Science City, GETDD Guangzhou, China
Except Conducted Emissions was performed at:
Block E, No.7-2 Guang Dong Software Science Park, Caipin Road, Guangzhou Science City, GETDD Guangzhou, China

A2LA Certificate Number 0078.10
Intertek Testing Services Shenzhen Ltd. Guangzhou Branch is accredited by A2LA and Listed in FCC website. FCC accredited test labs may perform both Certification testing under Parts 15 and 18 and Declaration of Conformity testing.

3.0 System Test Configuration

3.1 Justification

For emissions testing, the equipment under test (EUT) setup to transmit continuously to simplify the measurement methodology. Care was taken to ensure proper power supply voltages during testing. During testing, it was powered by 120Vac supply.

TEST REPORT

The signal is maximized through rotation and placement in the three orthogonal axes. The antenna height and polarization are varied during the search for maximum signal level. The antenna height is varied from 1 to 4 meters. Radiated emissions are taken at three meters unless the signal level is too low for measurement at that distance. If necessary, a pre-amplifier is used and/or the test is conducted at a closer distance.

All readings are extrapolated back to the equivalent three meter reading using inverse scaling with distance. The spurious emissions more than 20 dB below the permissible value are not reported.

For an intentional radiator, the spectrum shall be investigated from the lowest radio frequency signal generated in the device, without going below 9 kHz, up to at least the frequency shown in the following table:

Frequency range of radiated emission measurements

| Lowest frequency generated in the device | Upper frequency range of measurement |
|--|---|
| 9 kHz to below 10 GHz | 10th harmonic of highest fundamental frequency or to 40 GHz, whichever is lower |
| At or above 10 GHz to below 30 GHz | 5th harmonic of highest fundamental frequency or to 100 GHz, whichever is lower |
| At or above 30 GHz | 5th harmonic of highest fundamental frequency or to 200 GHz, whichever is lower, unless otherwise specified |

Number of fundamental frequencies to be tested in EUT transmit band

| Frequency range in which device operates | Number of frequencies | Location in frequency range of operation |
|--|-----------------------|---|
| 1 MHz or less | 1 | Middle |
| 1 MHz to 10 MHz | 2 | 1 near top and 1 near bottom |
| More than 10 MHz | 3 | 1 near top, 1 near middle and 1 near bottom |

3.2 EUT Exercising Software

N/A

3.3 Special Accessories

No special accessories used.

TEST REPORT

3.4 Measurement Uncertainty

| No. | Item | Measurement Uncertainty |
|-----|--|-------------------------|
| 1 | 20 dB Bandwidth | 2.3% |
| | 6dB Bandwidth | |
| | 99% Bandwidth | |
| 2 | Carrier Frequencies Separated | 2.3% |
| 3 | Dwell Time | 1.2% |
| 4 | Maximum Peak Conducted Output Power | 1.5dB |
| 5 | Peak Power Spectral Density | 1.5dB |
| 6 | Out of Band Conducted Emissions | 1.5dB |
| 7 | Band edges measurement | 1.5dB |
| 8 | Radiated Emissions | 4.7 dB (25 MHz-1 GHz) |
| | | 4.8 dB (1 GHz-18 GHz) |
| | | 5.21dB (18GZH-26GHz) |
| 9 | Conducted Emissions at Mains Terminals | 2.58dB |
| 10 | Temperature | 0.5 °C |
| 11 | Humidity | 0.4 % |
| 12 | Time | 1.2% |

The measurement uncertainty describes the overall uncertainty of the given measured value during the operation of the EUT.

Measurement uncertainty is calculated in accordance with ETSI TR 100 028-2001.

The measurement uncertainty is given with a confidence of 95%, k=2.

When determining of the test conclusion, the Measurement Uncertainty of test has been considered.

Uncertainty and Compliance – Unless the standard specifically states that measured values are to be extended by the measurement uncertainty in determining compliance, all compliance determinations are based on the actual measured value

3.5 Equipment Modification

Any modifications installed previous to testing by ebuynow ecommerce Ltd. will be incorporated in each production model sold / leased in the United States.

No modifications were installed by Intertek Testing Services Shenzhen Ltd. Guangzhou Branch.

TEST REPORT

3.6 Support Equipment List and Description

This product was tested with corresponding support equipment as below:

Support Equipment

| Description | Manufacturer | Model No. | SN/Version | Supplied by |
|--------------|--------------|-----------|------------|-------------|
| Fix software | -- | Tera Term | -- | Client |
| Notebook | HP | T430 | -- | Intertek |

Cable

| Description | Model No. | Connector type | Cable length/type | Supplied by |
|---------------|-----------|----------------|-------------------|-------------|
| Antenna cable | RF-02 | SMA | 0.2 m(shielded) | Intertek |
| USB cord | USB-01 | USB | 0.8 m(shielded) | Client |

TEST REPORT

4.0 Measurement Results

4.1 Antenna Requirement

Standard requirement:

15.203 requirement:

For intentional device. According to 15.203 an intentional radiator shall be designed to Ensure that no antenna other than that furnished by the responsible party shall be used with the device.

15.247(c) (1)(i) requirement:

(i) Systems operating in the 2400-2483.5 MHz bands that are used exclusively for fixed. Point-to-point operations may employ transmitting antennas with directional gain greater than 6 dBi provided the maximum conducted output power of the intentional radiator is reduced by 1 dB for every 3 dB that the directional gain of the antenna exceeds 6 dBi.

EUT Antenna

The antenna is an integral antenna and no consideration of replacement. The best case gain of the antenna is 0 dBi.



TEST REPORT

4.2 6 dB Bandwidth (DTS bandwidth)

Test Requirement: FCC Part 15 C section 15.247
(a)(2) Systems using digital modulation techniques may operate in the 902-928 MHz, 2400-2483.5MHz, and 5725-5850 MHz bands. The minimum 6 dB bandwidth shall be at least 500 kHz.

Test Method: ANSI C63.10: Clause 11.8

Test Status: Pre-Scan has been conducted to determine the worst-case mode from all possible combinations between available modulations, data rates and antenna ports (if EUT with antenna diversity architecture). Following channel(s) was (were) selected for the final test as listed below.

Test Configuration:

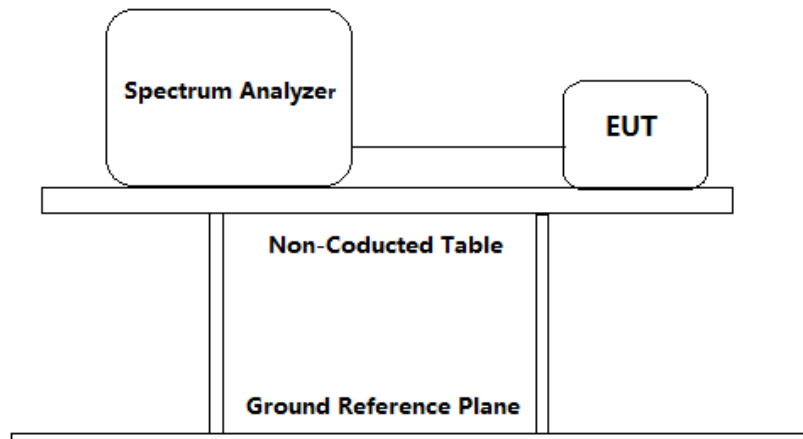

Test Procedure:

1. Remove the antenna from the EUT and then connect a low attention attenuation RF cable (cable loss+ attenuator =12 dB) from the antenna port to the spectrum.
2. Set the spectrum analyzer:
 - a) Set RBW = 100 kHz
 - b) Set the VBW $\geq [3 \times \text{RBW}]$
 - c) Detector = peak.
 - d) Trace mode = max hold.
 - e) Sweep = auto couple
 - f) Allow the trace to stabilize.
 - g) Measure the maximum width of the emission that is constrained by the frequencies associated with the two outermost amplitude points (upper and lower frequencies) that are attenuated by 6 dB relative to the maximum level measured in the fundamental emission.
 - h) Span=2*BW~5*BW
3. Repeat until all the test status is investigated.

TEST REPORT

4. Report the worst case.

Used Test Equipment List

Spectrum Analyzer. Refer to Clause 5 Test Equipment List for details.

| Channel No. | Frequency (MHz) | Mode | Data Rate | Measured 6dB bandwidth (MHz) | Limit | Result |
|-------------|-----------------|----------------|-----------|------------------------------|---------|--------|
| 1 | 2412 | 802.11b | 1 Mbps | 8.612 | ≥500KHz | Pass |
| 6 | 2437 | | 1 Mbps | 8.600 | | Pass |
| 11 | 2462 | | 1 Mbps | 8.596 | | Pass |
| 1 | 2412 | 802.11g | 6 Mbps | 16.408 | | Pass |
| 6 | 2437 | | 6 Mbps | 16.408 | | Pass |
| 11 | 2462 | | 6 Mbps | 16.208 | | Pass |
| 1 | 2412 | 802.11n (HT20) | 6.5 Mbps | 17.528 | | Pass |
| 6 | 2437 | | 6.5 Mbps | 17.288 | | Pass |
| 11 | 2462 | | 6.5 Mbps | 17.512 | | Pass |
| 3 | 2422 | 802.11n (HT40) | 13.5 Mbps | 36.096 | | Pass |
| 6 | 2437 | | 13.5 Mbps | 35.848 | | Pass |
| 9 | 2452 | | 13.5 Mbps | 35.736 | | Pass |

Test result: The unit does meet the FCC requirements.

TEST REPORT

Result plot as follows:

802.11b mode with 1Mbps data rate

Channel 1: 2.412GHz

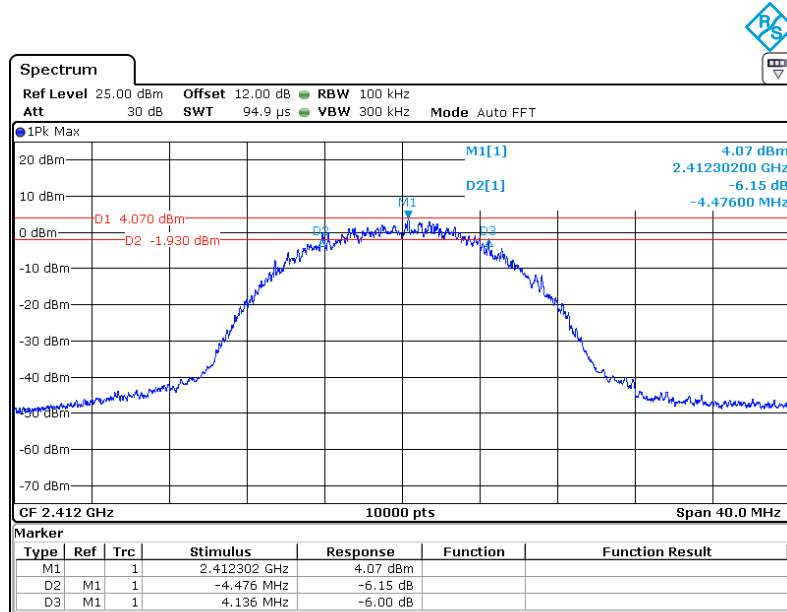

Channel 6: 2.437GHz:

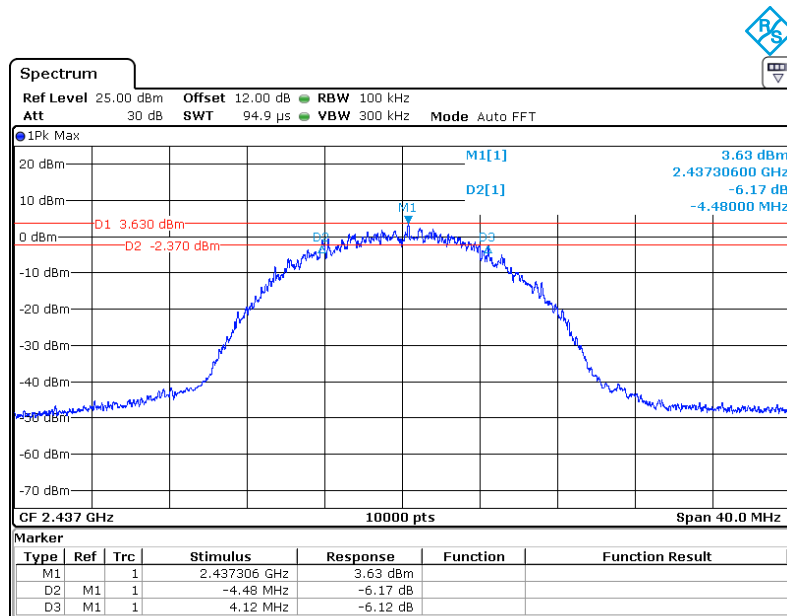

TEST REPORT

Channel 11: 2.462GHz:

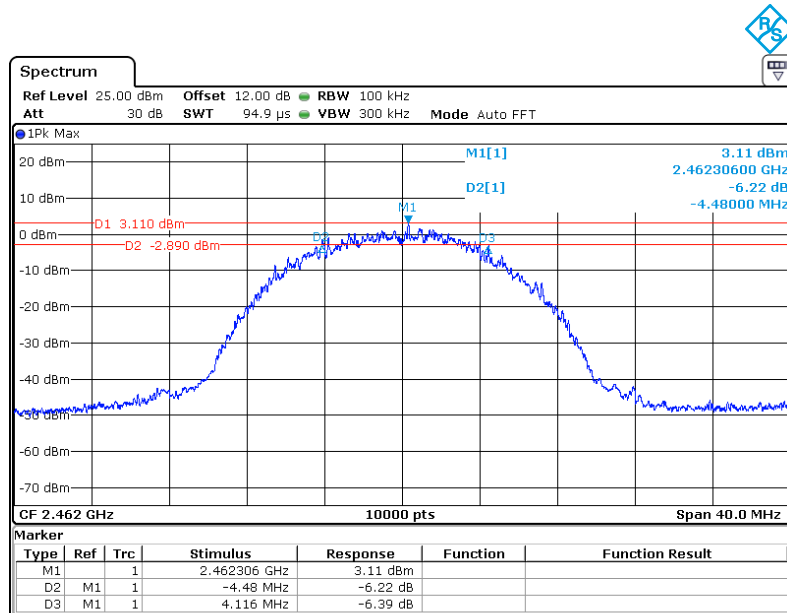

802.11g mode with 6Mbps data rate

Channel 1: 2.412GHz:

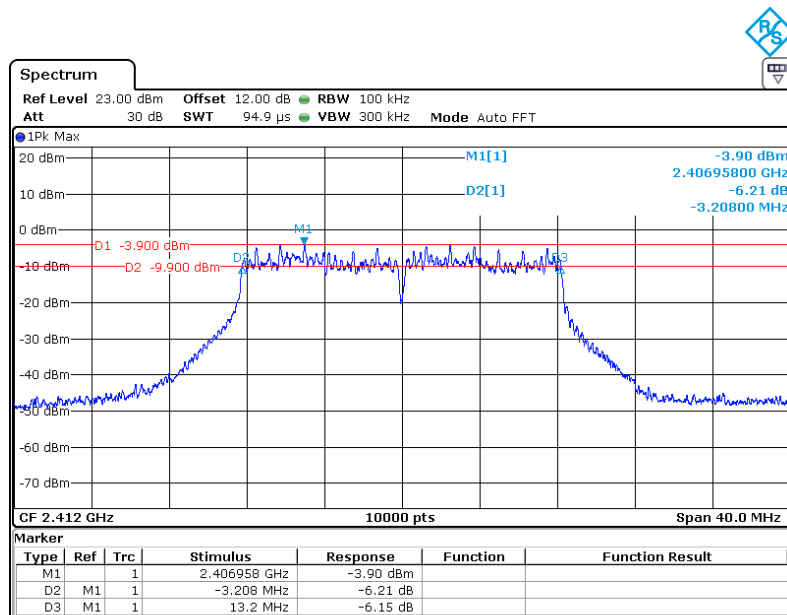

TEST REPORT

Channel 6: 2.437GHz:

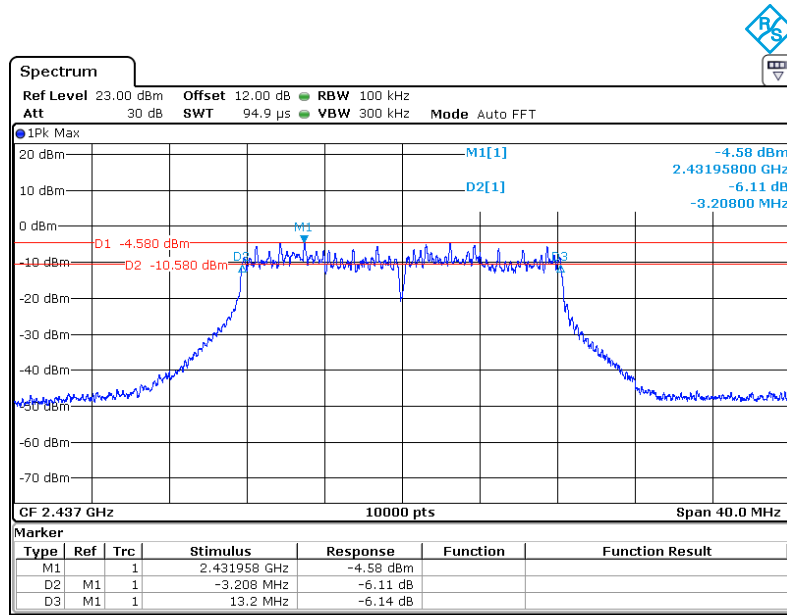

Channel 11: 2.462GHz:

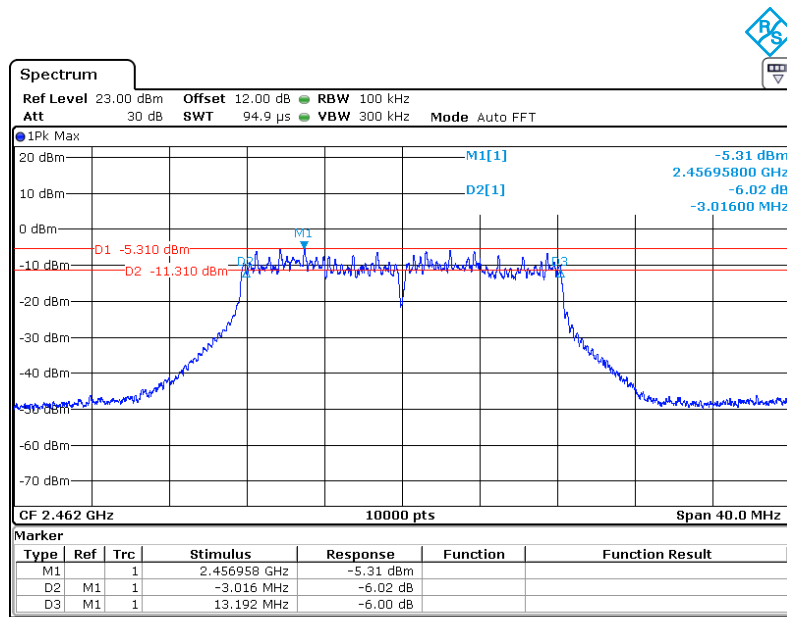

TEST REPORT

802.11n(HT20) mode with 6.5Mbps data rate
Channel 1: 2.412GHz:

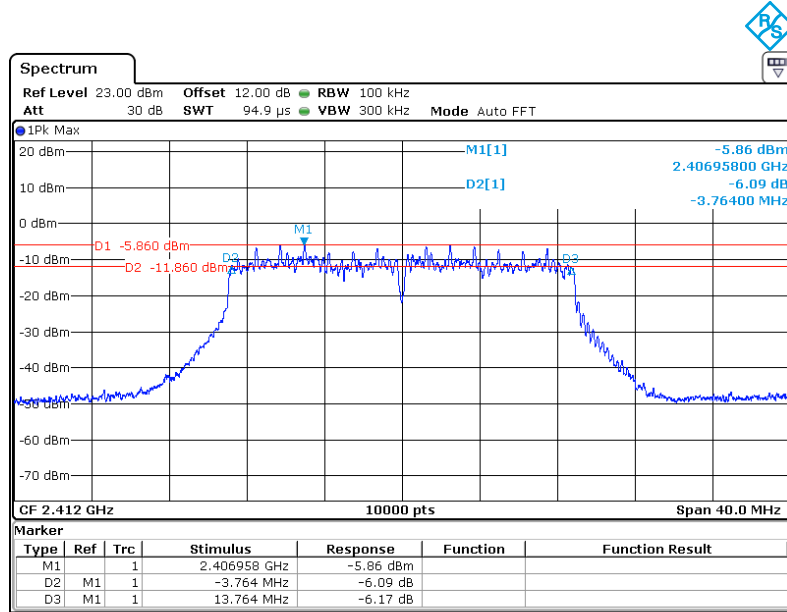

Channel 6: 2.437GHz:

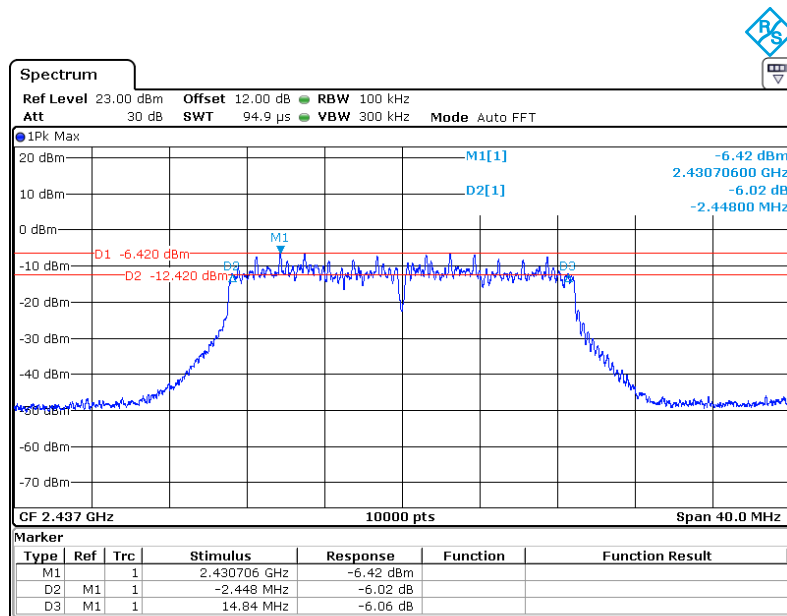

TEST REPORT

Channel 11: 2.462GHz:

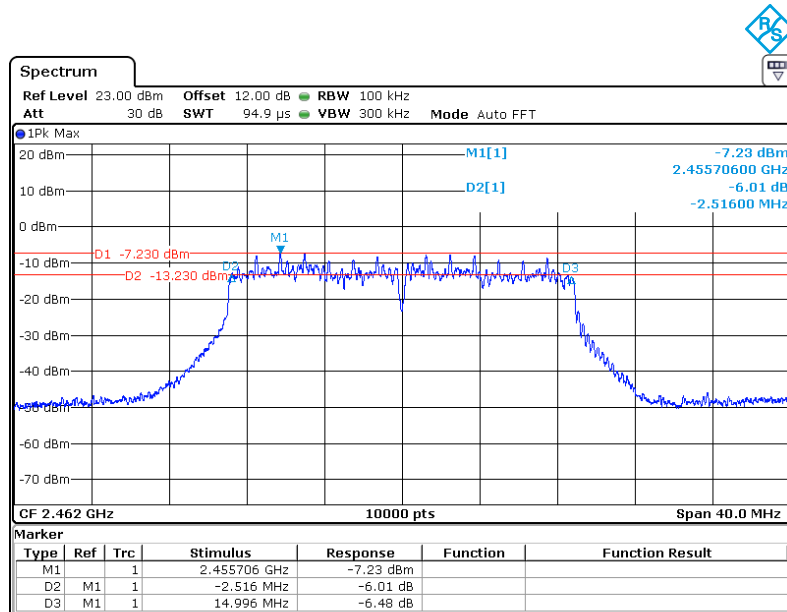

802.11n(HT40) mode with 13.5Mbps data rate

Channel 3: 2.422GHz:

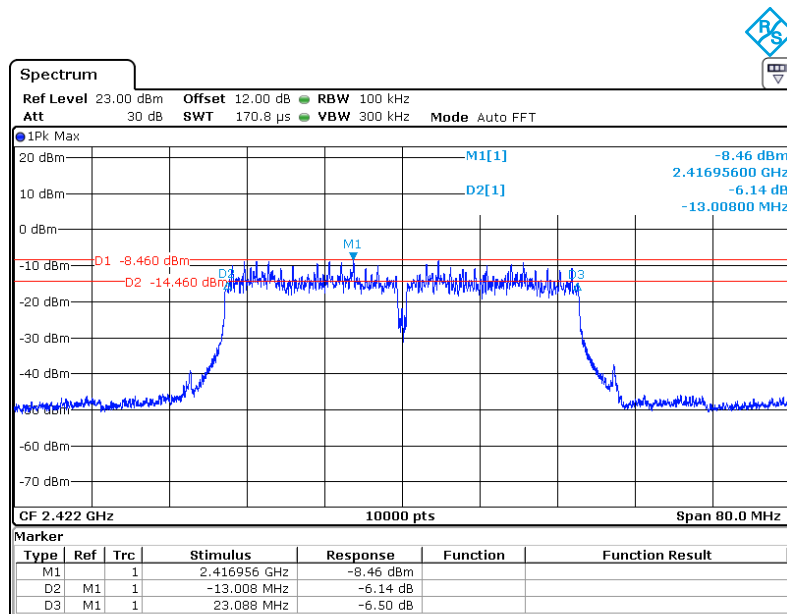

TEST REPORT

Channel 6: 2.437GHz:

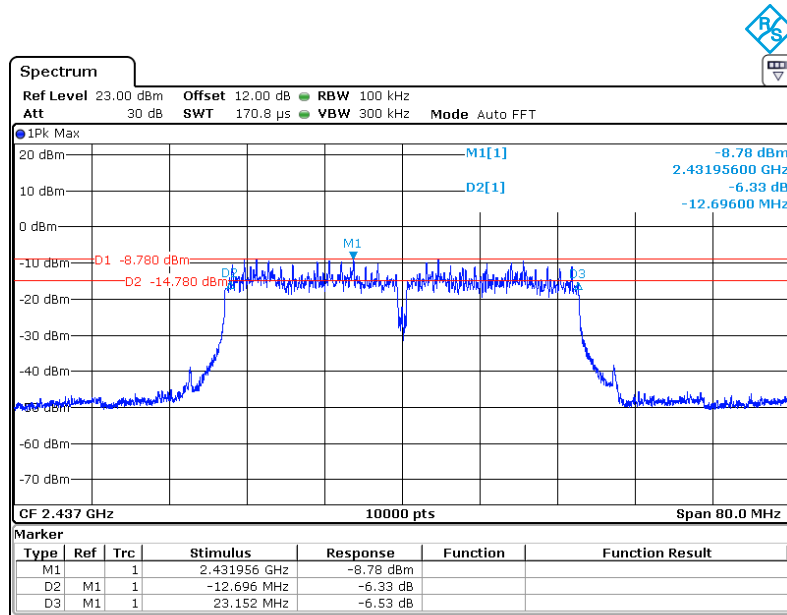

Channel 9: 2.452GHz:

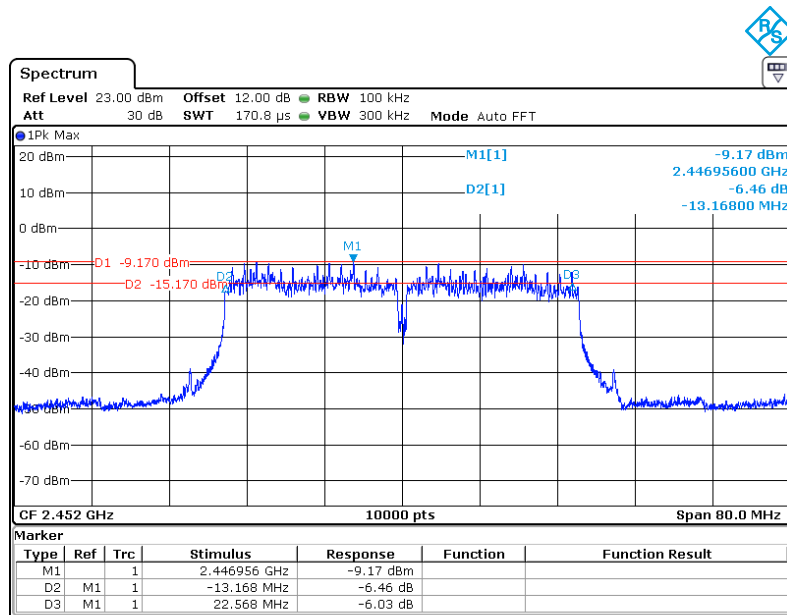

TEST REPORT

4.3 Maximum Peak Conducted Output Power

Test Requirement: FCC Part 15 C section 15.247
(b)(3) For systems using digital modulation in the 902-928 MHz, 2400-2483.5 MHz, and 5725-5850 MHz bands: 1 Watt.
Except as shown in paragraph (c) of this section, if transmitting antennas of directional gain greater than 6 dBi are used, the conducted output power from the intentional radiator shall be reduced below the stated values in paragraphs (b) (1), (b) (2), and (b) (3) of this section, as appropriate, by the amount in dB that the directional gain of the antenna exceeds 6 dBi.

Test Method: ANSI C63.10: Clause 11.9.1.2(Integrated band power method)

Test Status: Pre-Scan has been conducted to determine the worst-case mode from all possible combinations between available modulations, data rates and antenna ports (if EUT with antenna diversity architecture). Following channel(s) was (were) selected for the final test as listed below.

Test Configuration:

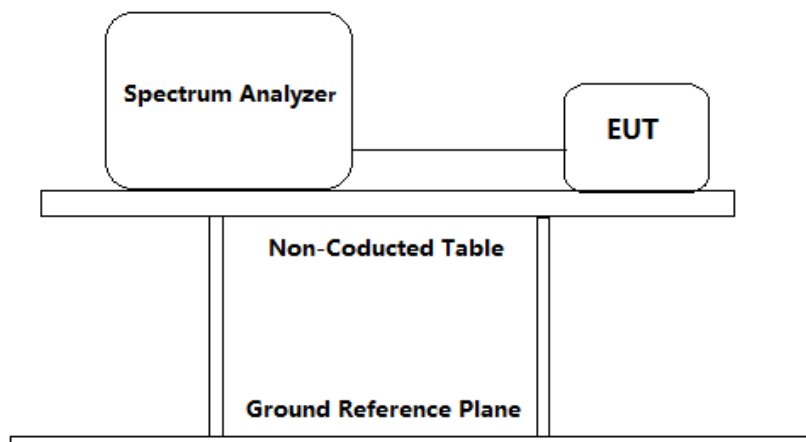

Test Procedure:

1. Remove the antenna from the EUT and then connect a low attention attenuation RF cable (cable loss+ attenuator =12 dB) from the antenna port to the spectrum.
2. Set the spectrum analyzer:
 - a) Set the RBW = 1 MHz.
 - b) Set the VBW \geq [3 \times RBW].
 - c) Set the span \geq [1.5 \times DTS bandwidth].
 - d) Detector = peak.
 - e) Sweep time = auto couple.
 - f) Trace mode = max hold.
 - g) Allow trace to fully stabilize.
 - h) Use the instrument's band/channel power measurement function with the band limits set equal to the DTS bandwidth edges.

TEST REPORT

3. Repeat until all the test status is investigated.
4. Report the worst case.

Used Test Equipment List

Spectrum Analyzer. Refer to Clause 5 Test Equipment List for details.

Test result:

| Channel No. | Frequency (MHz) | Mode | Data Rate | Measured Channel Power (dBm) | Limit | Result |
|-------------|-----------------|-------------------|-----------|------------------------------|---------------|--------|
| 1 | 2412 | 802.11b | 1 Mbps | 17.92 | 1W (30dBm) | Pass |
| 6 | 2437 | | 1 Mbps | 17.64 | | Pass |
| 11 | 2462 | | 1 Mbps | 16.81 | | Pass |
| 1 | 2412 | 802.11g | 6 Mbps | 15.10 | | Pass |
| 6 | 2437 | | 6 Mbps | 14.36 | | Pass |
| 11 | 2462 | | 6 Mbps | 13.44 | | Pass |
| 1 | 2412 | 802.11n (HT20) | 6.5 Mbps | 12.74 | | Pass |
| 6 | 2437 | | 6.5 Mbps | 12.02 | | Pass |
| 11 | 2462 | | 6.5 Mbps | 11.11 | | Pass |
| 3 | 2422 | 802.11n (HT40) | 13.5 Mbps | 12.42 | | Pass |
| 6 | 2437 | | 13.5 Mbps | 12.07 | | Pass |
| 9 | 2452 | | 13.5 Mbps | 11.64 | | Pass |

Remark:

cable loss+ attenuator =12 dB

Remark: Level = Read Level + Cable Loss

The unit does meet the FCC requirements.

TEST REPORT

Result plot as follows:

802.11b mode with 1Mbps data rate

Channel 1: 2.412GHz:

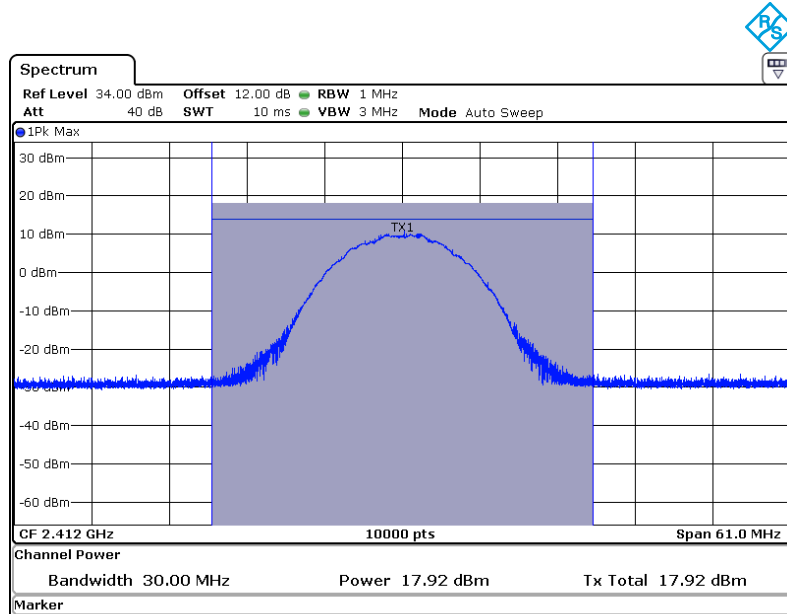

Channel 6: 2.437GHz:

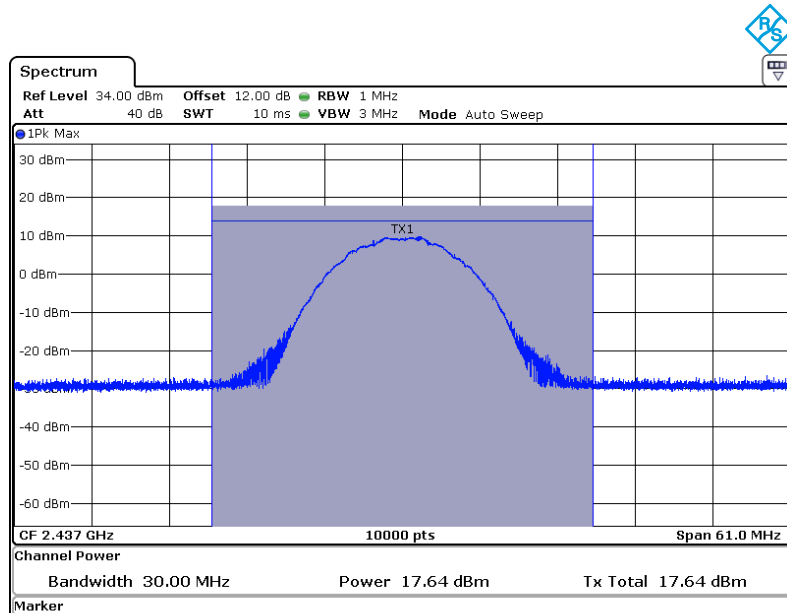

TEST REPORT

Channel 11: 2.462GHz:

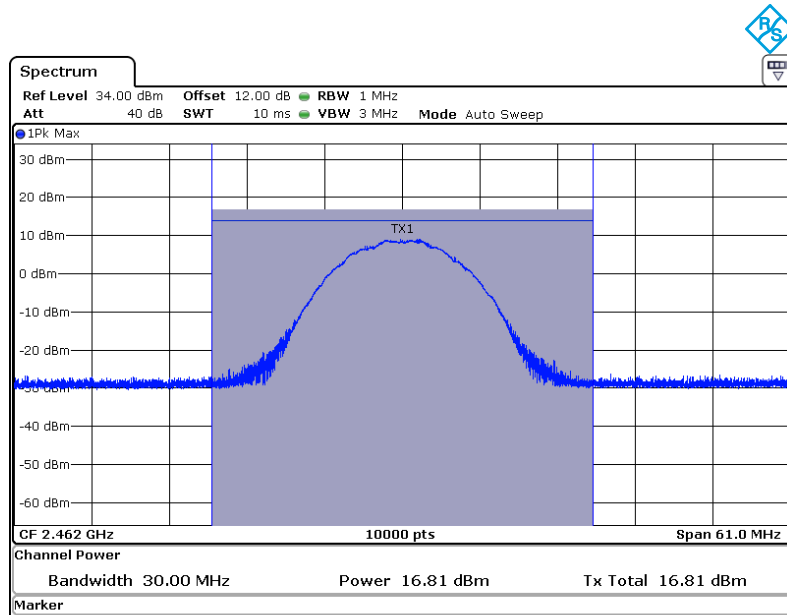

802.11g mode with 6Mbps data rate

Channel 1: 2.412GHz:

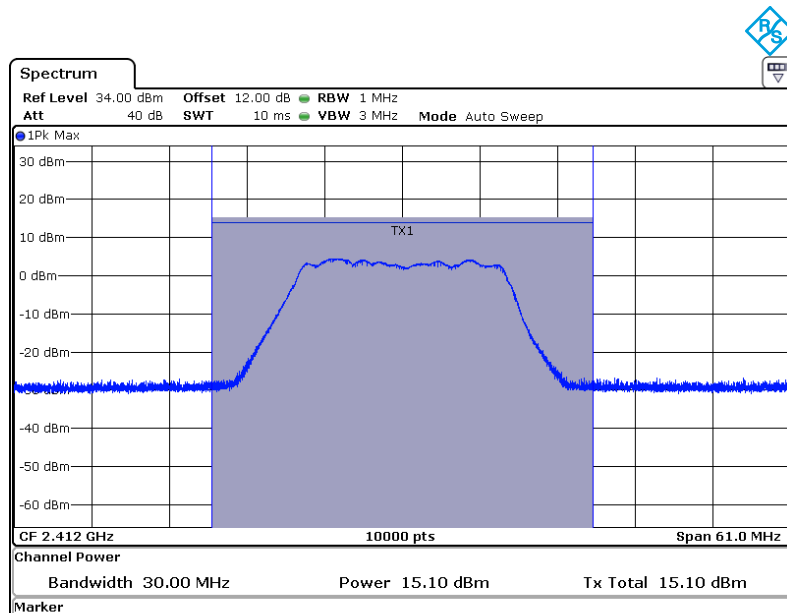

TEST REPORT

Channel 6: 2.437GHz:

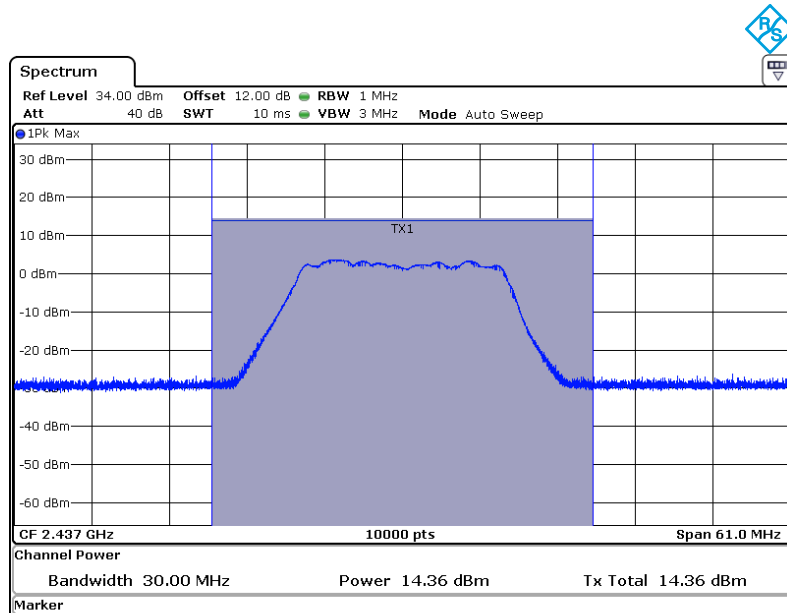

Channel 11: 2.462GHz:

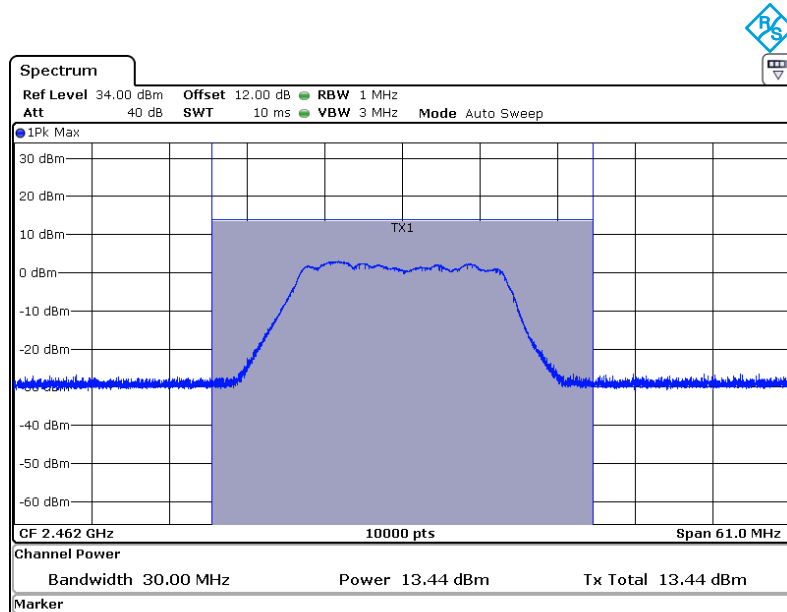

TEST REPORT

802.11n(HT20) mode with 6.5Mbps data rate
Channel 1: 2.412GHz:

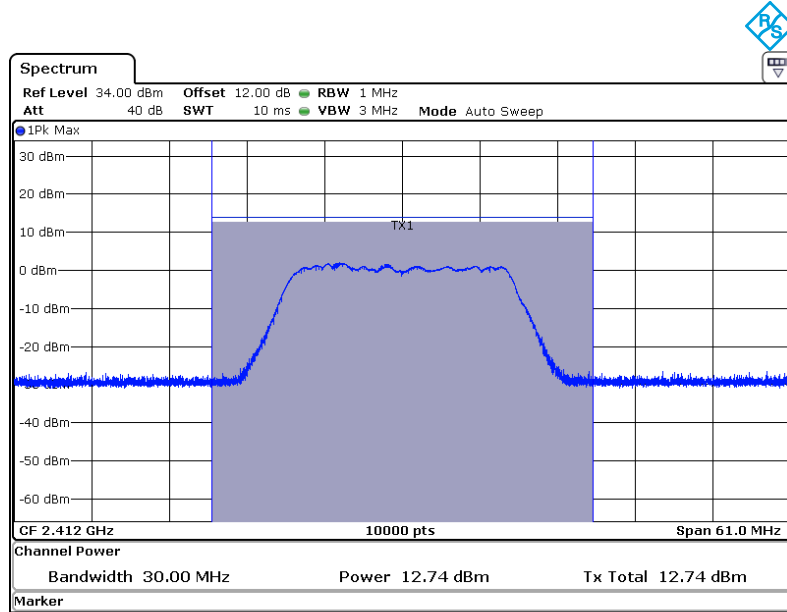

Channel 6: 2.437GHz:

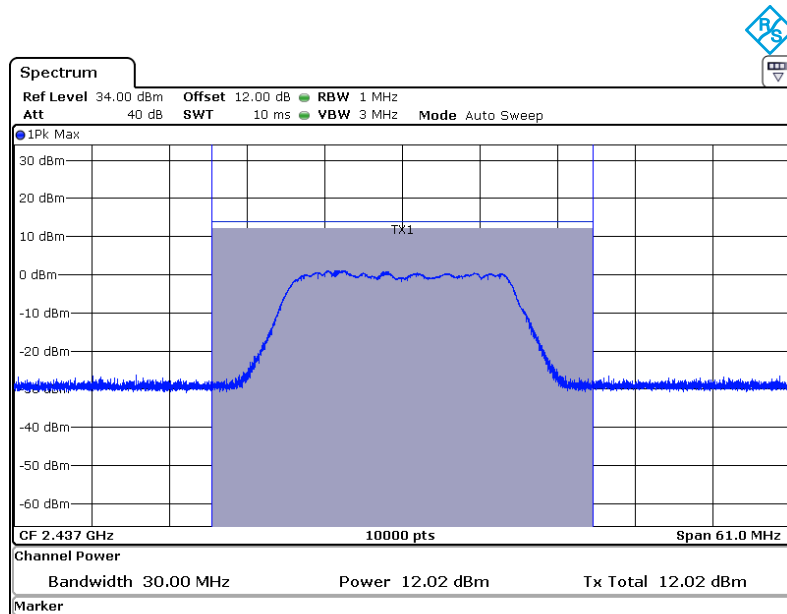

TEST REPORT

Channel 11: 2.462GHz:

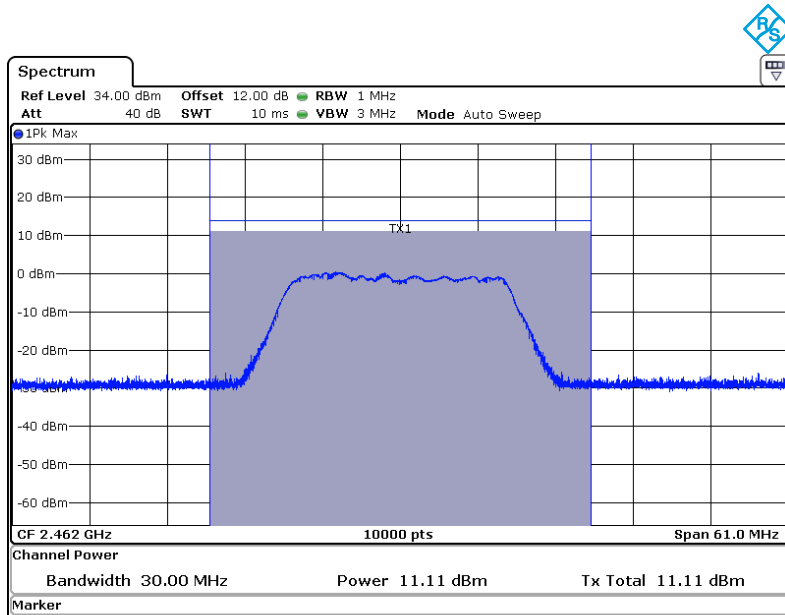

802.11n(HT40) mode with 13.5Mbps data rate
Channel 3: 2.422GHz:

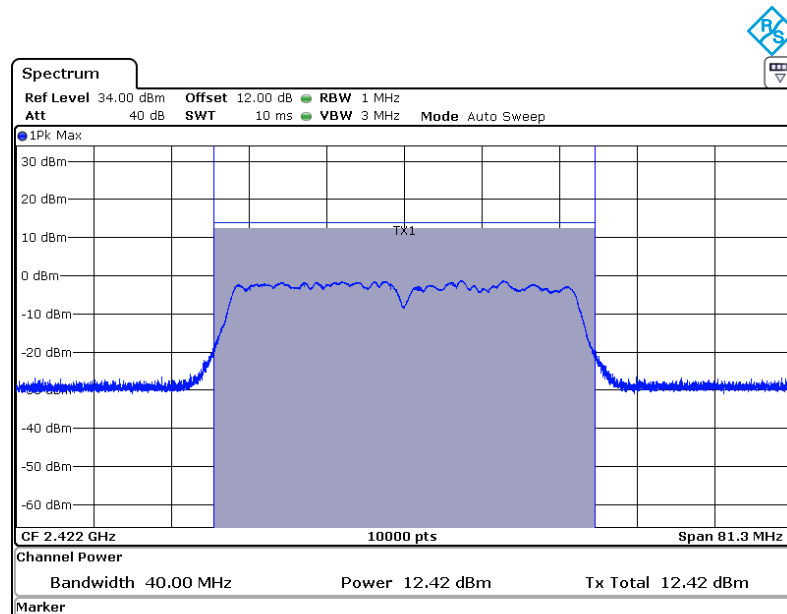

TEST REPORT

Channel 6: 2.437GHz:

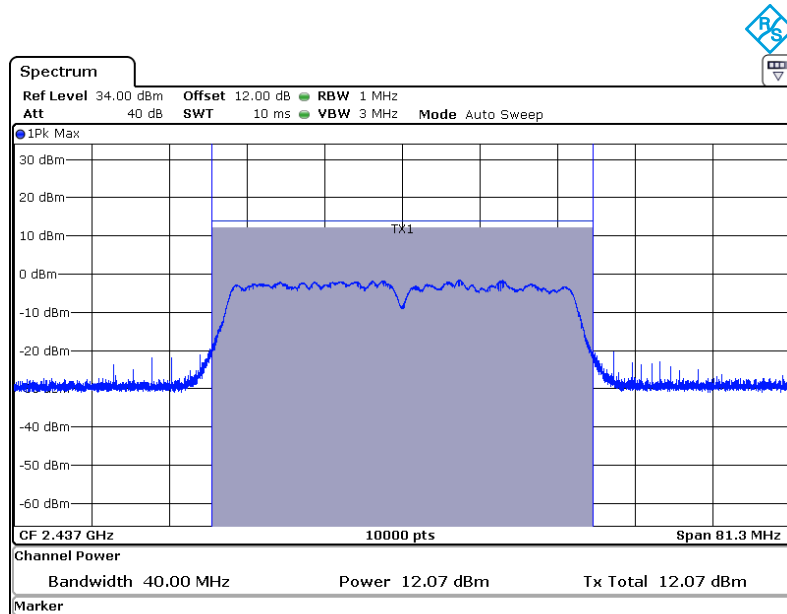

Channel 9: 2.452GHz:

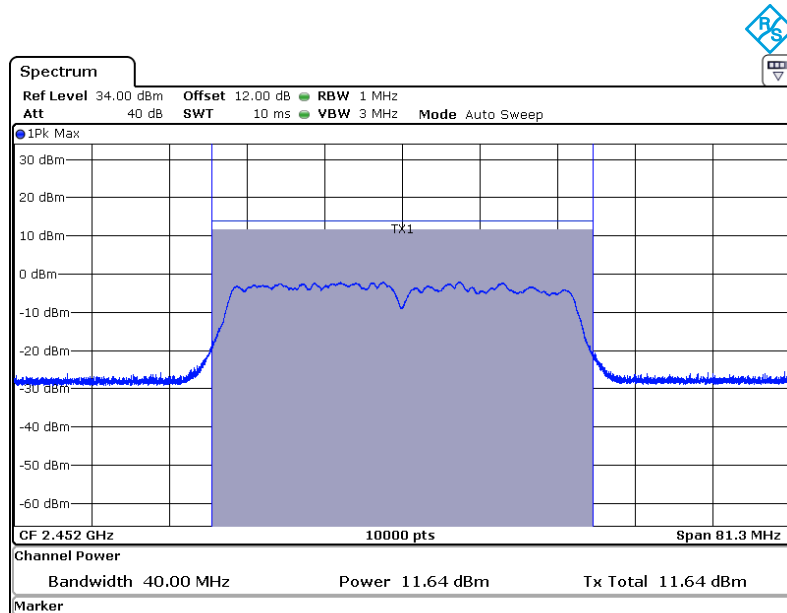

Test result: The unit does meet the FCC requirements.

TEST REPORT

4.4 Peak Power Spectral Density

Test Requirement: FCC Part 15 C section 15.247
(e) For digitally modulated systems, the power spectral density conducted from the intentional radiator to the antenna shall not be greater than 8 dBm in any 3 kHz band during any time interval of continuous transmission.
This power spectral density shall be determined in accordance with the provisions of paragraph (b) of this section. The same method of determining the conducted output power shall be used to determine the power spectral density.

Test Method: ANSI C63.10: Clause 11.10.2

Test Status: Pre-Scan has been conducted to determine the worst-case mode from all possible combinations between available modulations, data rates and antenna ports (if EUT with antenna diversity architecture). Following channel(s) was (were) selected for the final test as listed below.

Test Configuration:

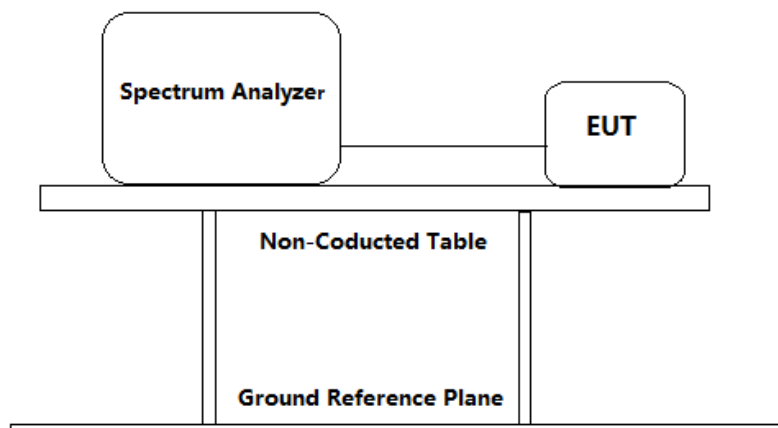

Test Procedure:

1. Remove the antenna from the EUT and then connect a low attention attenuation RF cable(cable loss+ attenuator =12 dB) from the antenna port to the spectrum analyzer or power meter.
2. Set the spectrum analyzer:
 - a) Set analyzer center frequency to DTS channel center frequency.
 - b) Set the span= $1.5 \times$ DTS bandwidth.
 - c) Set the RBW to $3 \text{ kHz} \leq \text{RBW} \leq 100 \text{ kHz}$.
 - d) Set the VBW $\geq [3 \times \text{RBW}]$.
 - e) Detector = peak.
 - f) Sweep time = auto couple.
 - g) Trace mode = max hold.
 - h) Allow trace to fully stabilize.

TEST REPORT

- i) Use the peak marker function to determine the maximum amplitude level within the RBW.
- j) If measured value exceeds requirement, then reduce RBW (but no less than 3 kHz) and repeat.
- 3. Measure the Power Spectral Density of the test frequency with special test status.
- 4. Repeat until all the test status is investigated.
- 5. Report the worst case.

Used Test Equipment List

Spectrum Analyzer. Refer to Clause 5 Test Equipment List for details.

Test result:

| Channel No. | Frequency (MHz) | Mode | Data Rate | Measured Peak Power Spectral Density (dBm/3kHz) | Limit | Result |
|-------------|-----------------|-------------------|-----------|---|----------------|--------|
| 1 | 2412 | 802.11b | 1 Mbps | 4.33 | 8dBm/ 3 KHz | Pass |
| 6 | 2437 | | 1 Mbps | 3.73 | | Pass |
| 11 | 2462 | | 1 Mbps | 2.90 | | Pass |
| 1 | 2412 | 802.11g | 6 Mbps | -20.12 | | Pass |
| 6 | 2437 | | 6 Mbps | -20.80 | | Pass |
| 11 | 2462 | | 6 Mbps | -21.64 | | Pass |
| 1 | 2412 | 802.11n (HT20) | 6.5 Mbps | -20.98 | | Pass |
| 6 | 2437 | | 6.5 Mbps | -21.66 | | Pass |
| 11 | 2462 | | 6.5 Mbps | -22.38 | | Pass |
| 3 | 2422 | 802.11n (HT40) | 13.5 Mbps | -25.59 | | Pass |
| 6 | 2437 | | 13.5 Mbps | -25.91 | | Pass |
| 9 | 2452 | | 13.5 Mbps | -26.26 | | Pass |

Test result: Level = Read Level + cable loss+ attenuator

TEST REPORT

Result plot as follows:

802.11b mode with 1Mbps data rate

Channel 1: 2.412GHz:

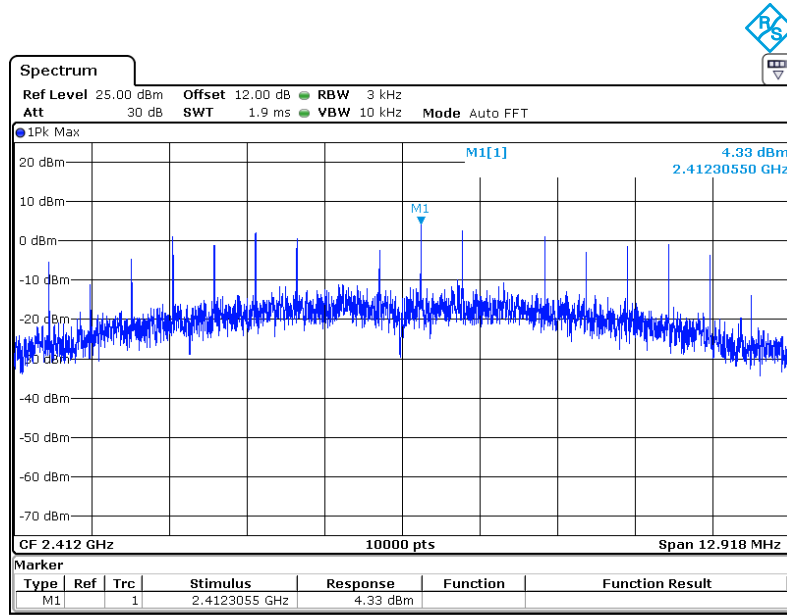

Channel 6: 2.437GHz:

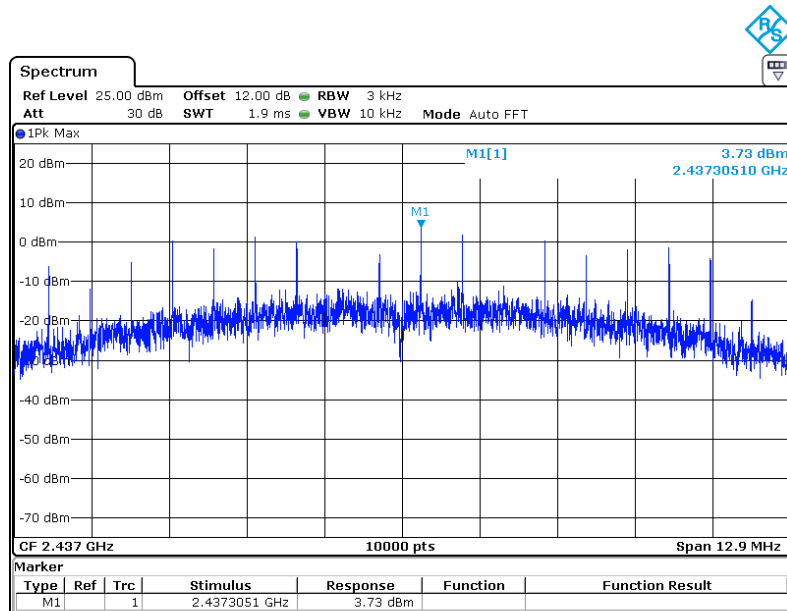

TEST REPORT

Channel 11: 2.462GHz:

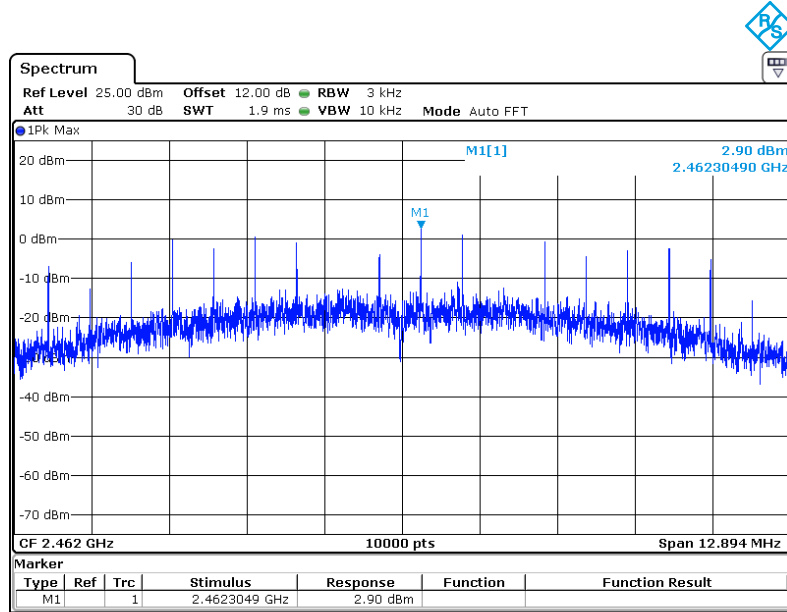

802.11g mode with 6Mbps data rate
Channel 1: 2.412GHz:

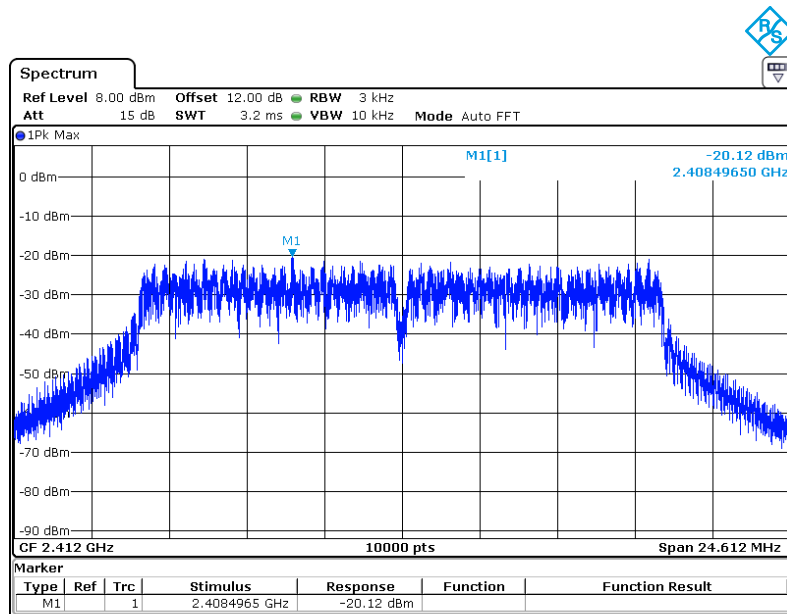

TEST REPORT

Channel 6: 2.437GHz:

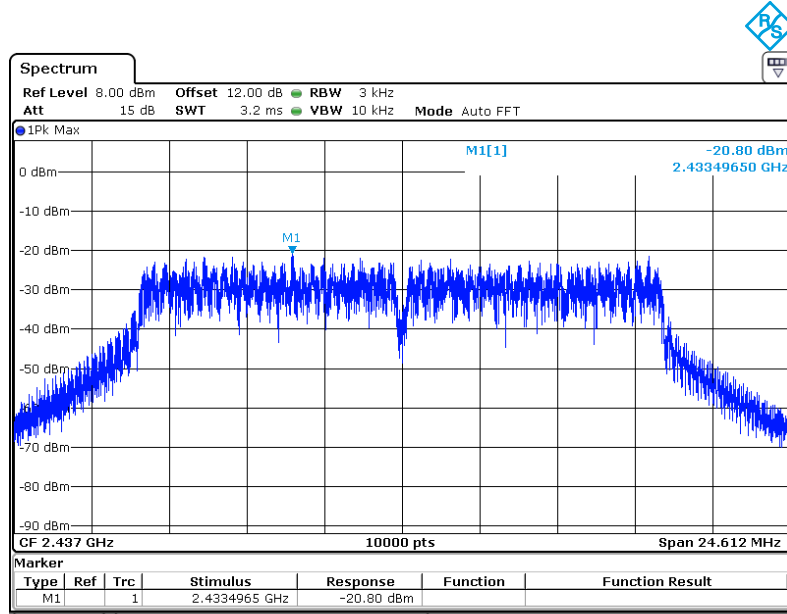

Channel 11: 2.462GHz:

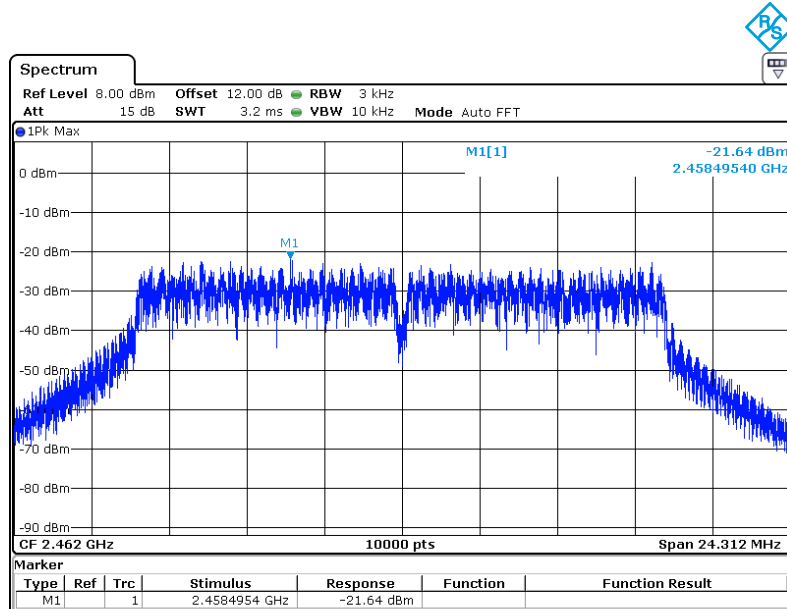

TEST REPORT

802.11n(HT20) mode with 6.5Mbps data rate
Channel 1: 2.412GHz:

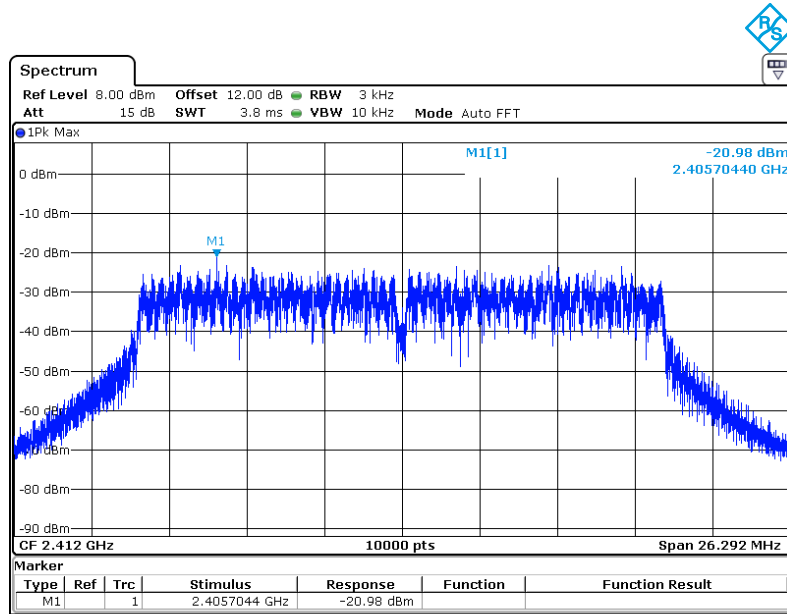

Channel 6: 2.437GHz:

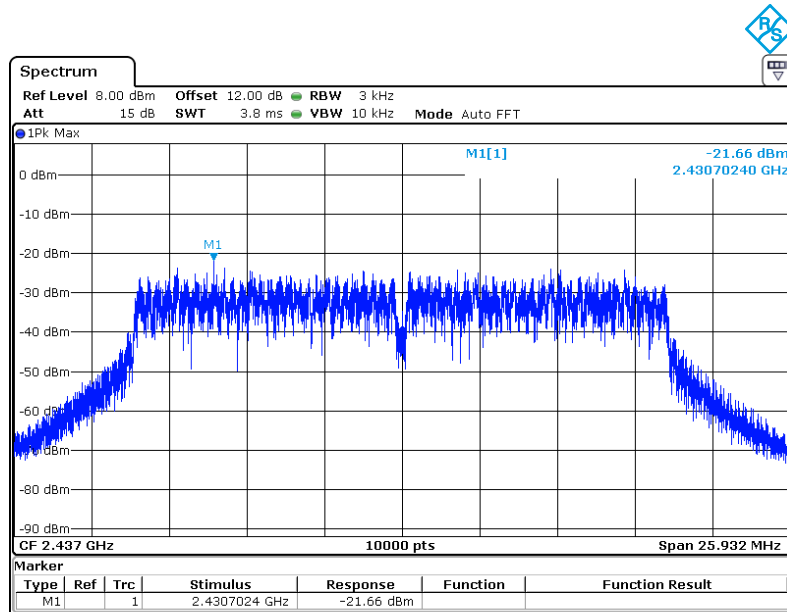

TEST REPORT

Channel 11: 2.462GHz:

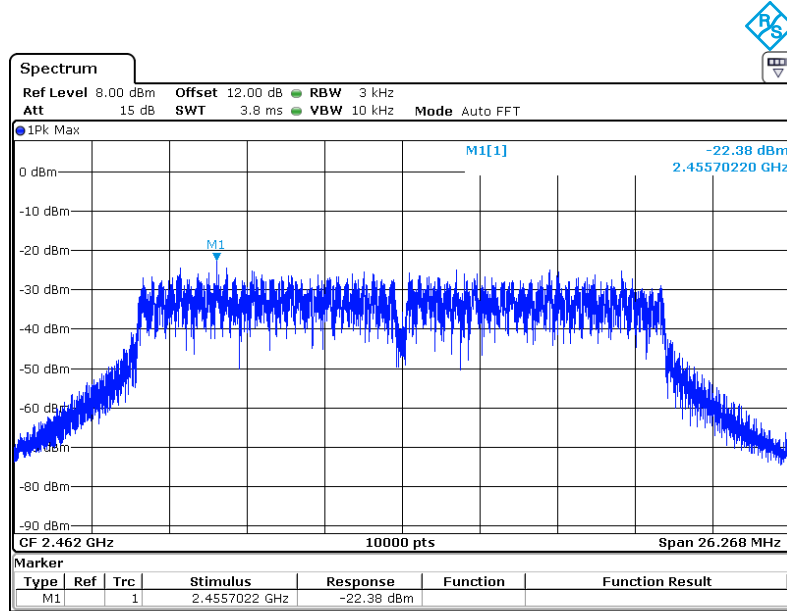

802.11n(HT40) mode with 13.5Mbps data rate

Channel 3: 2.422GHz:

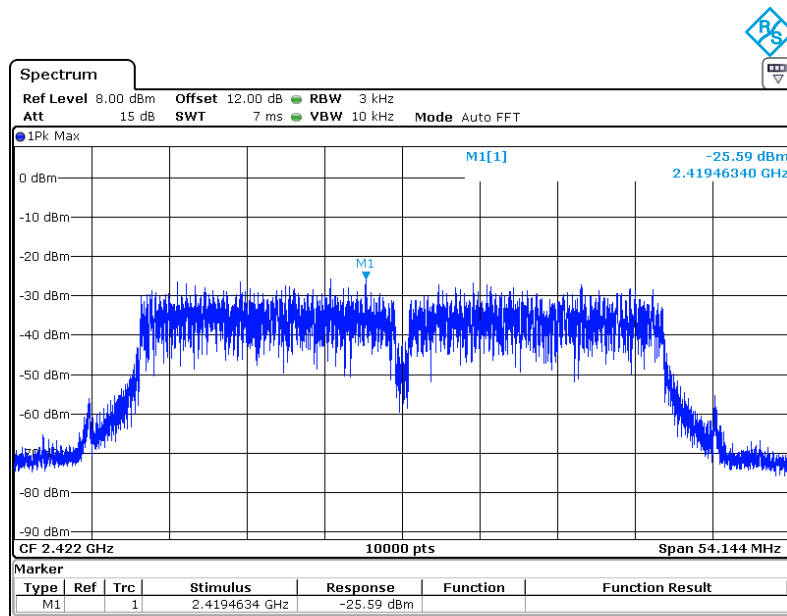

TEST REPORT

Channel 6: 2.437GHz:

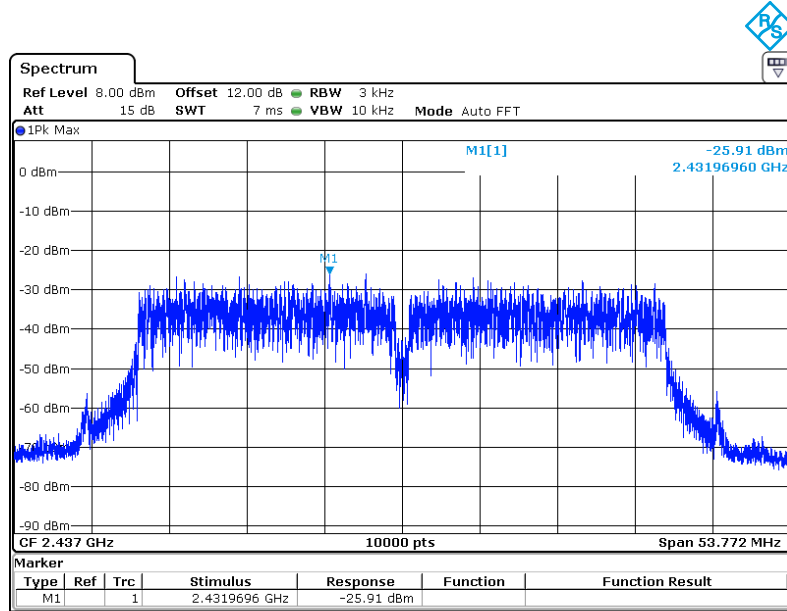

Channel 9: 2.452GHz:

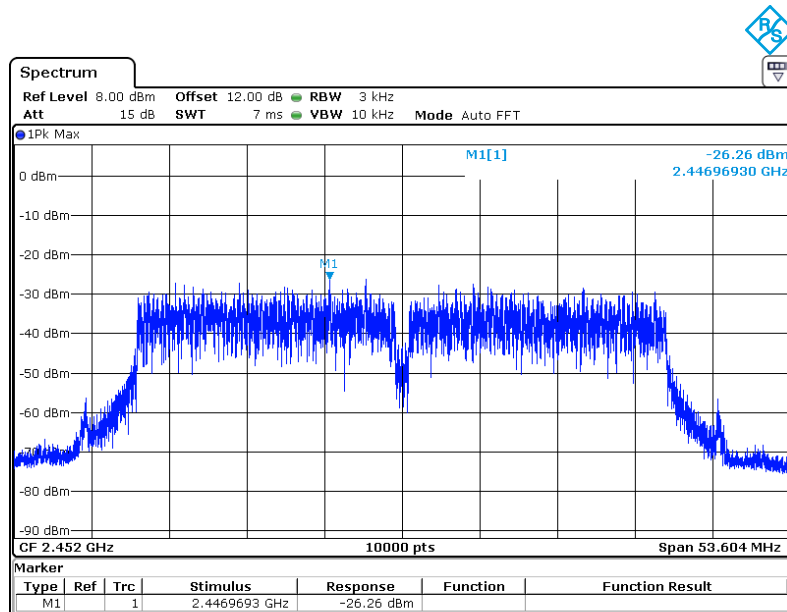

TEST REPORT

4.5 Out of Band Conducted Emissions

Test Requirement: FCC Part 15 C section 15.247

(d) In any 100 kHz bandwidth outside the frequency band in which the spread spectrum or digitally modulated intentional radiator is operating. The radio frequency power that is produced by the intentional radiator shall be at least 20 dB below that in the 100 kHz bandwidth within the band that contains the highest level of the desired power. Based on either an RF conducted or a radiated measurement. Provided the transmitter demonstrates compliance with the peak conducted power limits.

Test Method: ANSI C63.10: Clause 11.11

Test Status: Pre-Scan has been conducted to determine the worst-case mode from all possible combinations between available modulations, data rates and antenna ports (if EUT with antenna diversity architecture). Following channel(s) was (were) selected for the final test as listed below.

Test Configuration:

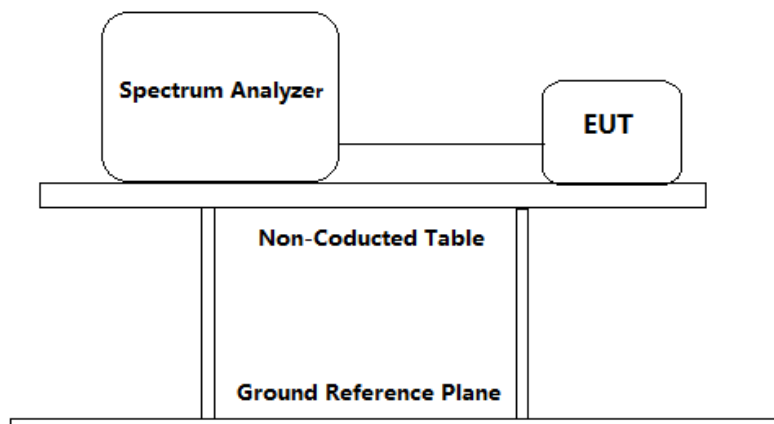

Test Procedure:

1. Remove the antenna from the EUT and then connect a low RF cable (cable loss+ attenuator =12 dB) from the antenna port to the spectrum analyzer or power meter.
2. Establish a reference level by using the following procedure:
 - a) Set instrument center frequency to DTS channel center frequency.
 - b) Set the span to $\geq 1.5 \times$ DTS bandwidth.
 - c) Set the RBW = 100 kHz.
 - d) Set the VBW $\geq [3 \times$ RBW].
 - e) Detector = peak.
 - f) Sweep time = auto couple.
 - g) Trace mode = max hold.
 - h) Allow trace to fully stabilize.
 - i) Use the peak marker function to determine the maximum PSD level.

TEST REPORT

Note that the channel found to contain the maximum PSD level can be used to establish the reference level

3. Emission level measurement
 - a) Set the center frequency and span to encompass frequency range to be measured.
 - b) Set the RBW = 100 kHz.
 - c) Set the VBW $\geq [3 \times \text{RBW}]$.
 - d) Detector = peak.
 - e) Sweep time = auto couple.
 - f) Trace mode = max hold.
 - g) Allow trace to fully stabilize.
 - h) Use the peak marker function to determine the maximum amplitude level.
4. Measure the Conducted unwanted Emissions of the test frequency with special test status.
5. Repeat until all the test status is investigated.
6. Report the worst case.

Used Test Equipment List

Spectrum Analyzer. Refer to Clause 5 Test Equipment List for details.

TEST REPORT

Result plot as follows:

802.11b mode with 1Mbps data rate

Channel 1: 2.412GHz:

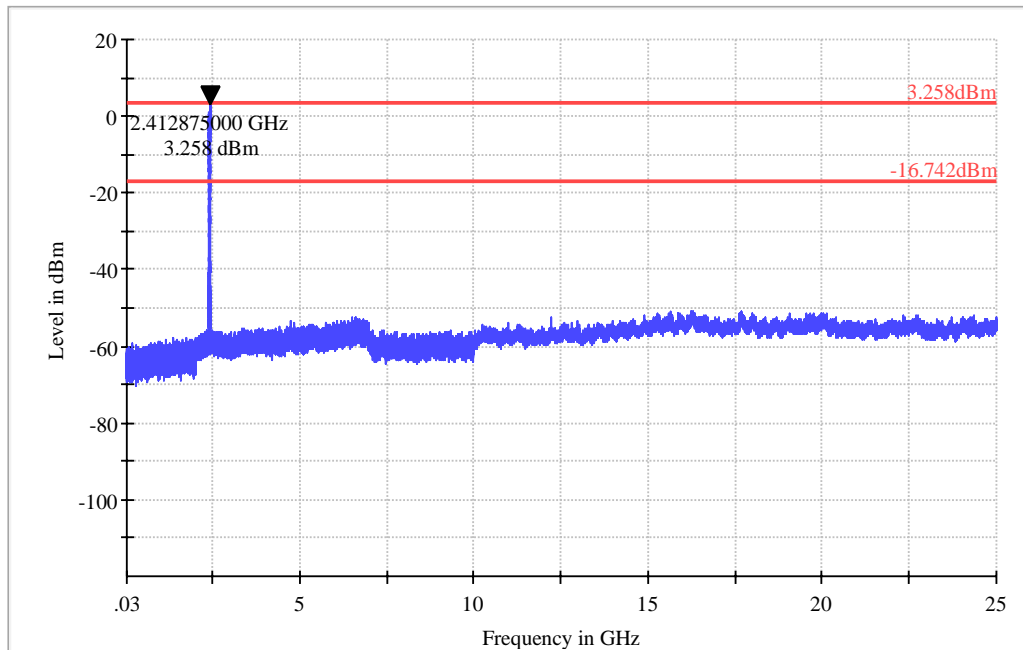

In any 100kHz bandwidth, the Conducted Spurious Emissions from 30 MHz to 25 GHz were greater than 20dB below the peak emission within the band that contains the highest level of the desired power.

TEST REPORT

Channel 6: 2.437GHz:

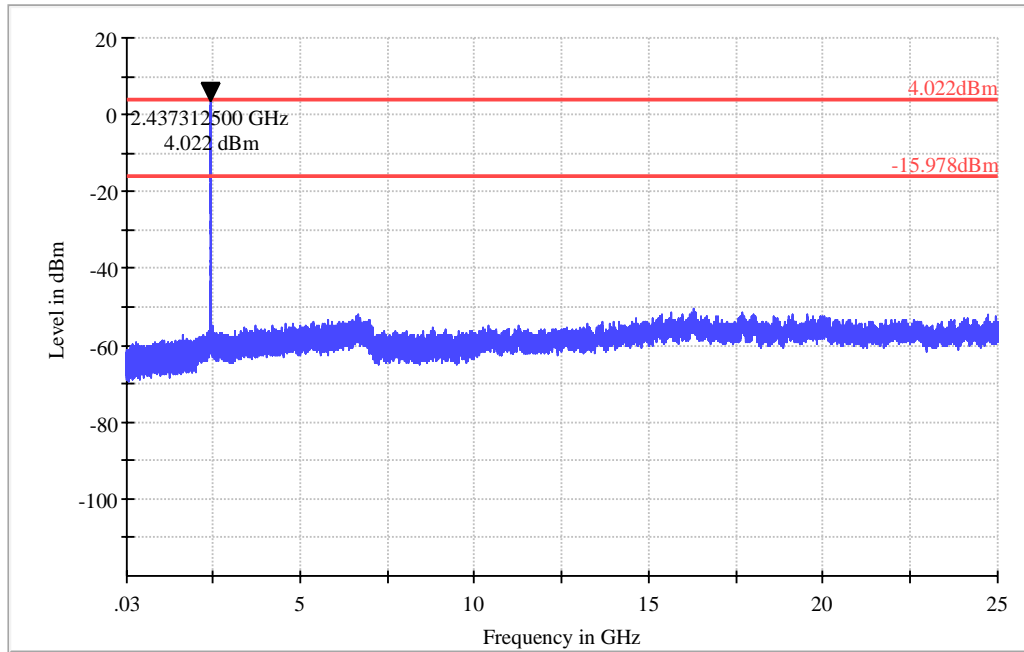

In any 100kHz bandwidth, the Conducted Spurious Emissions from 30 MHz to 25 GHz were greater than 20dB below the peak emission within the band that contains the highest level of the desired power.

TEST REPORT

Channel 11:2.462 GHz:

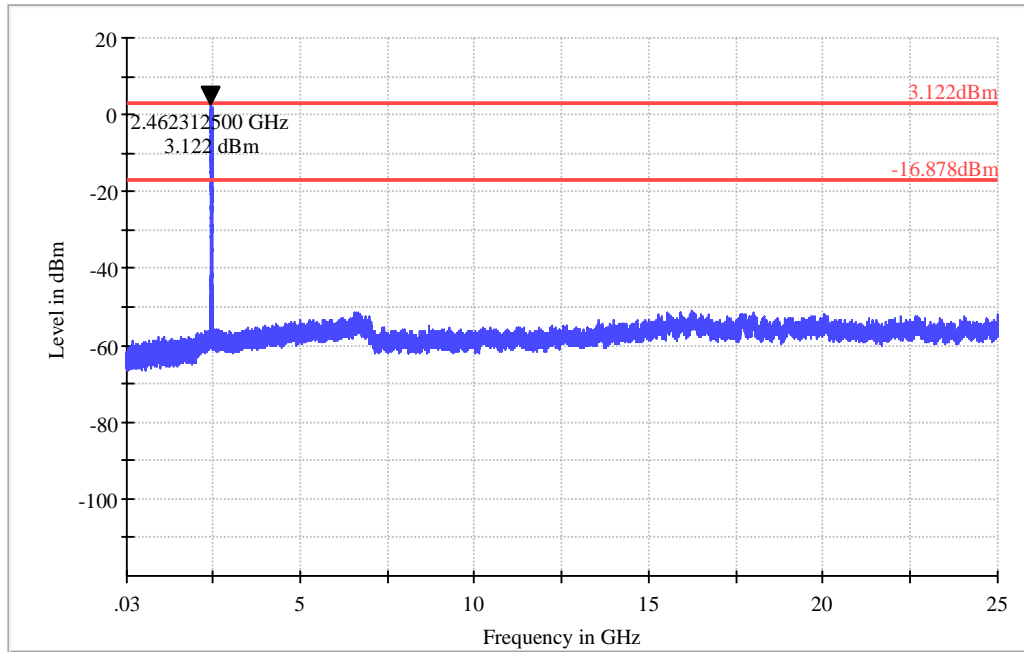

In any 100kHz bandwidth, the Conducted Spurious Emissions from 30 MHz to 25 GHz were greater than 20dB below the peak emission within the band that contains the highest level of the desired power.

TEST REPORT

802.11g mode with 6Mbps data rate

Channel 1: 2.412GHz:

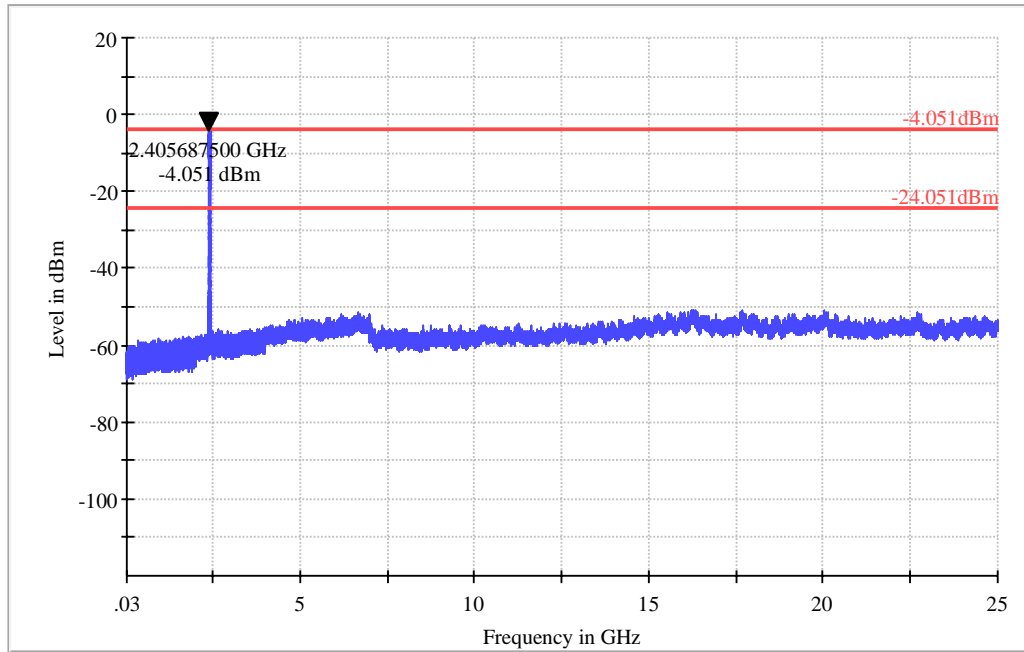

In any 100kHz bandwidth, the Conducted Spurious Emissions from 30 MHz to 25 GHz were greater than 20dB below the peak emission within the band that contains the highest level of the desired power.

TEST REPORT

Channel 6: 2.437GHz:

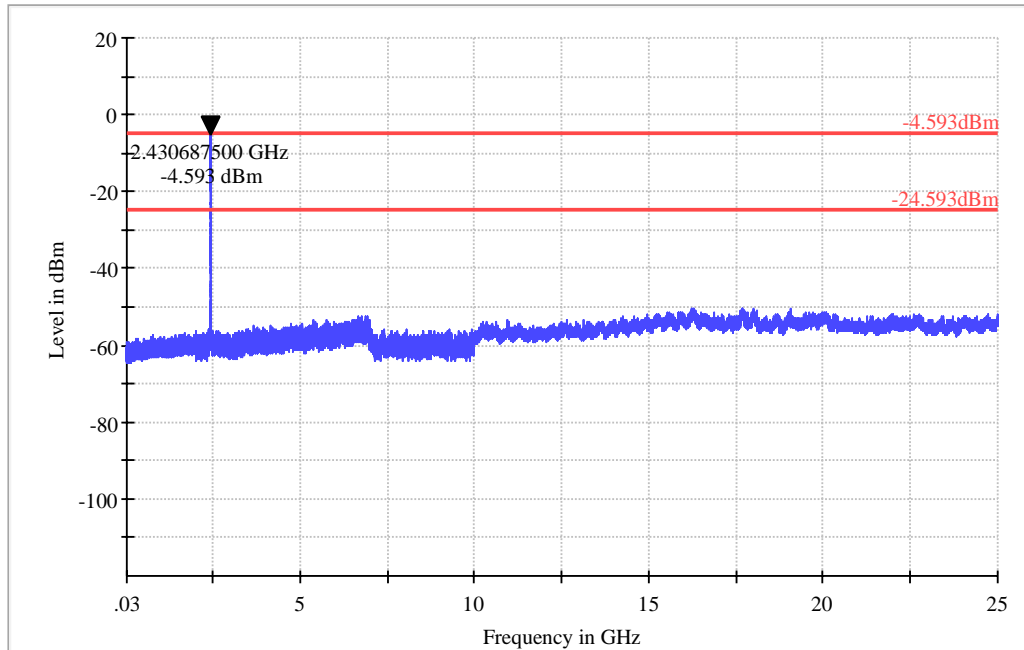

In any 100kHz bandwidth, the Conducted Spurious Emissions from 30 MHz to 25 GHz were greater than 20dB below the peak emission within the band that contains the highest level of the desired power.

TEST REPORT

Channel 11: 2.462 GHz:

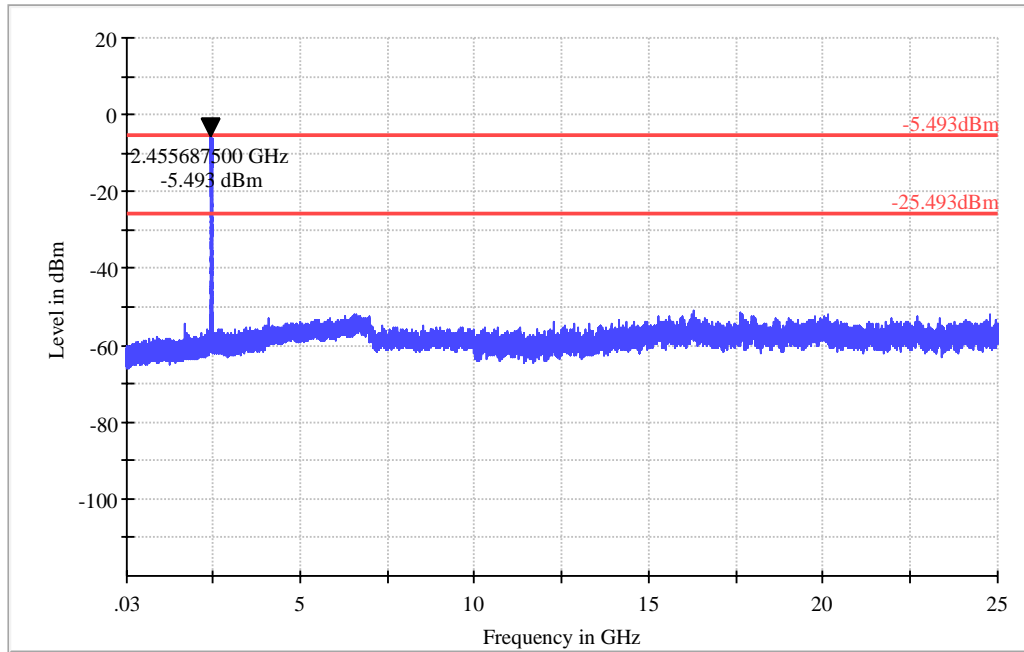

In any 100kHz bandwidth, the Conducted Spurious Emissions from 30 MHz to 25 GHz were greater than 20dB below the peak emission within the band that contains the highest level of the desired power.

TEST REPORT

802.11n(HT20) mode with 6.5Mbps data rate
Channel 1: 2.412GHz:

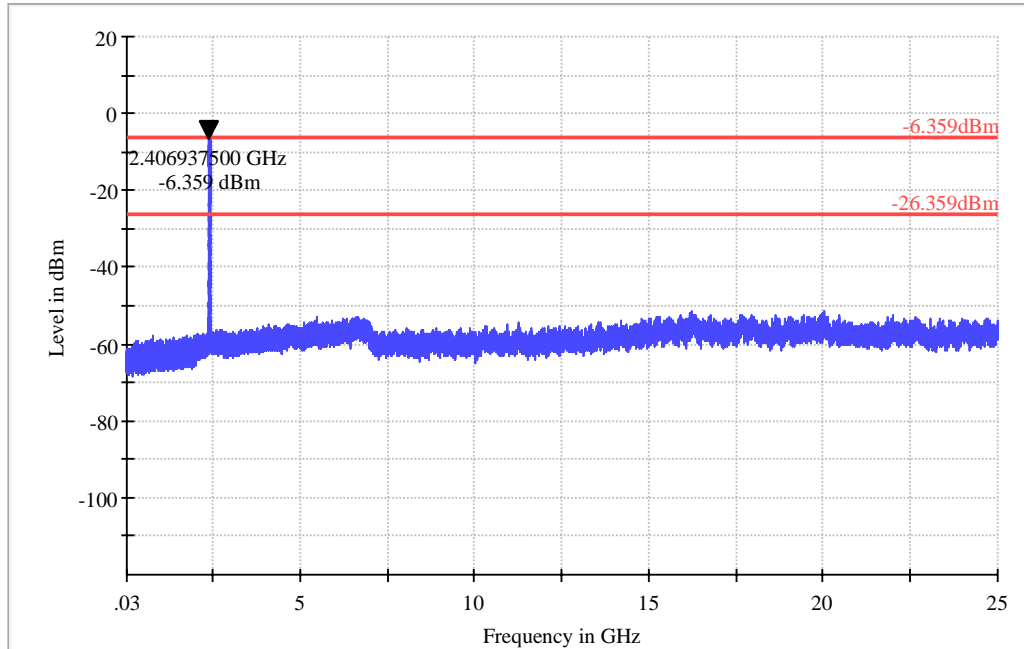

In any 100kHz bandwidth, the Conducted Spurious Emissions from 30 MHz to 25 GHz were greater than 20dB below the peak emission within the band that contains the highest level of the desired power.

TEST REPORT

Channel 6: 2.437GHz:

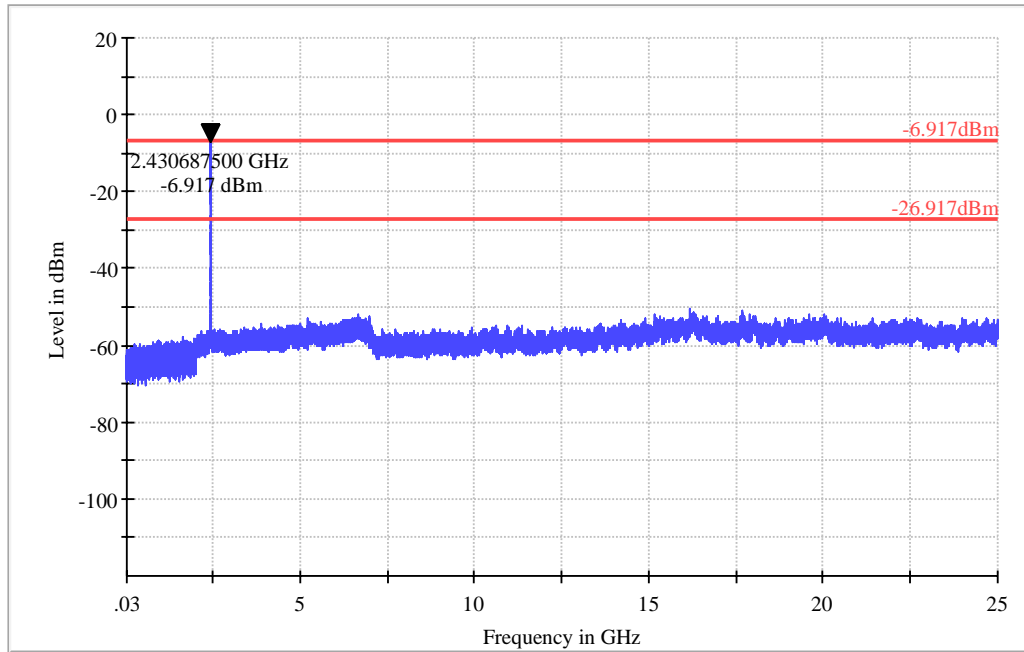

In any 100kHz bandwidth, the Conducted Spurious Emissions from 30 MHz to 25 GHz were greater than 20dB below the peak emission within the band that contains the highest level of the desired power.

TEST REPORT

Channel 11:2.462 GHz:

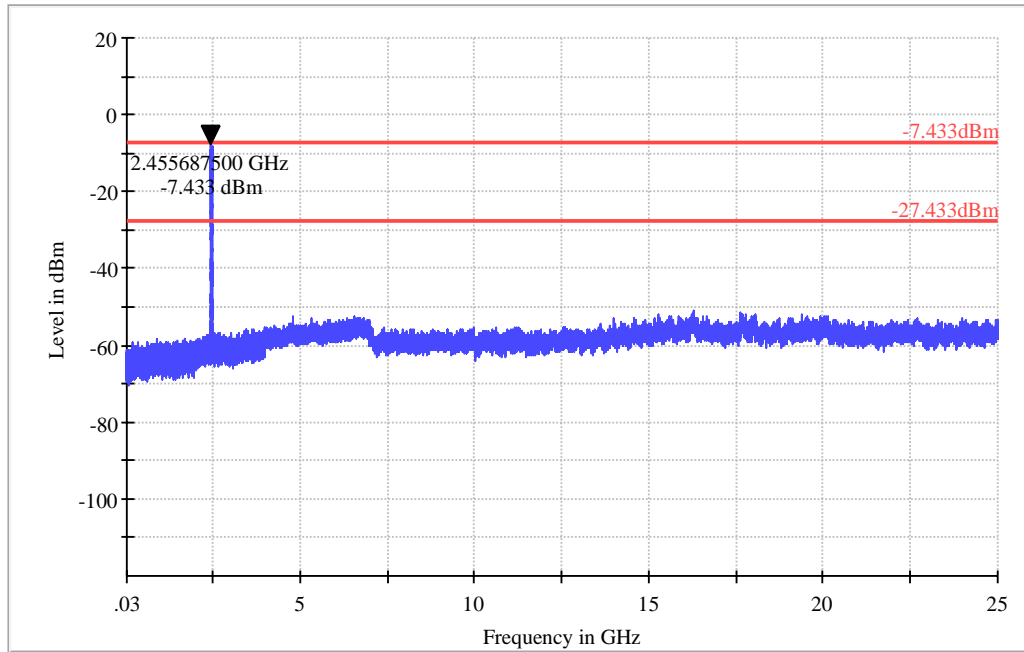

In any 100kHz bandwidth, the Conducted Spurious Emissions from 30 MHz to 25 GHz were greater than 20dB below the peak emission within the band that contains the highest level of the desired power.

TEST REPORT

802.11n(HT40) mode with 13.5Mbps data rate
Channel 3: 2.422GHz:

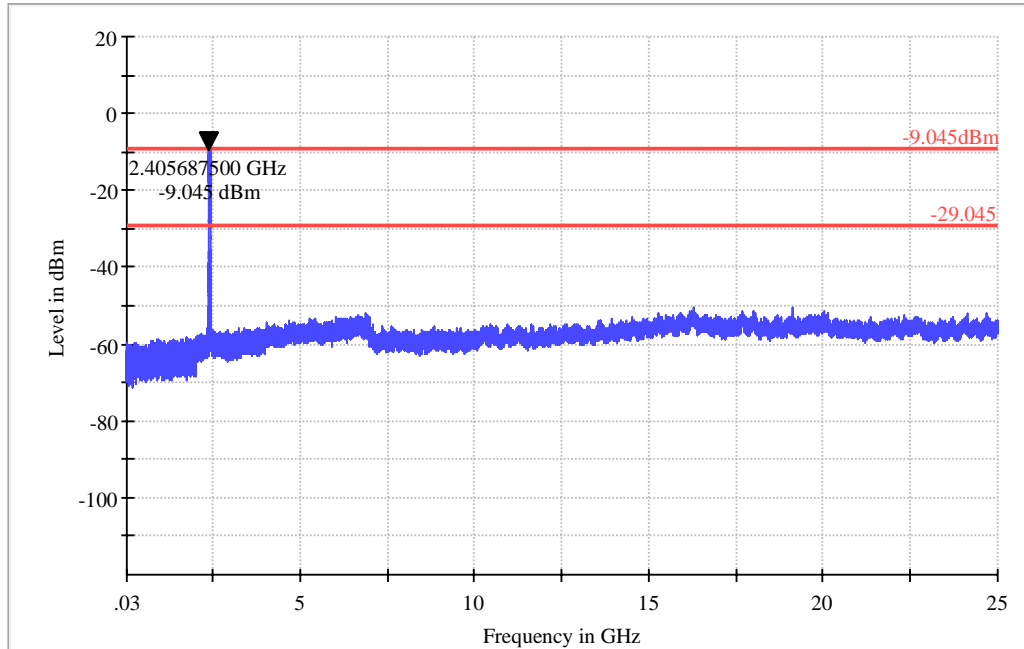

In any 100kHz bandwidth, the Conducted Spurious Emissions from 30 MHz to 25 GHz were greater than 20dB below the peak emission within the band that contains the highest level of the desired power.

TEST REPORT

Channel 6: 2.437GHz:

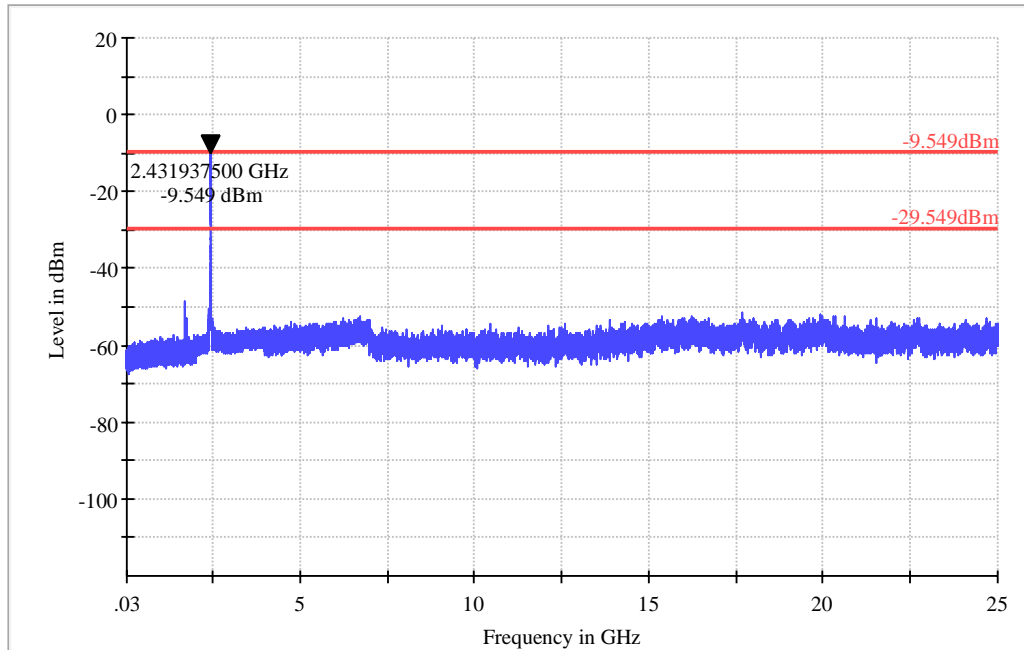

In any 100kHz bandwidth, the Conducted Spurious Emissions from 30 MHz to 25 GHz were greater than 20dB below the peak emission within the band that contains the highest level of the desired power.

TEST REPORT

Channel 9: 2.452 GHz:

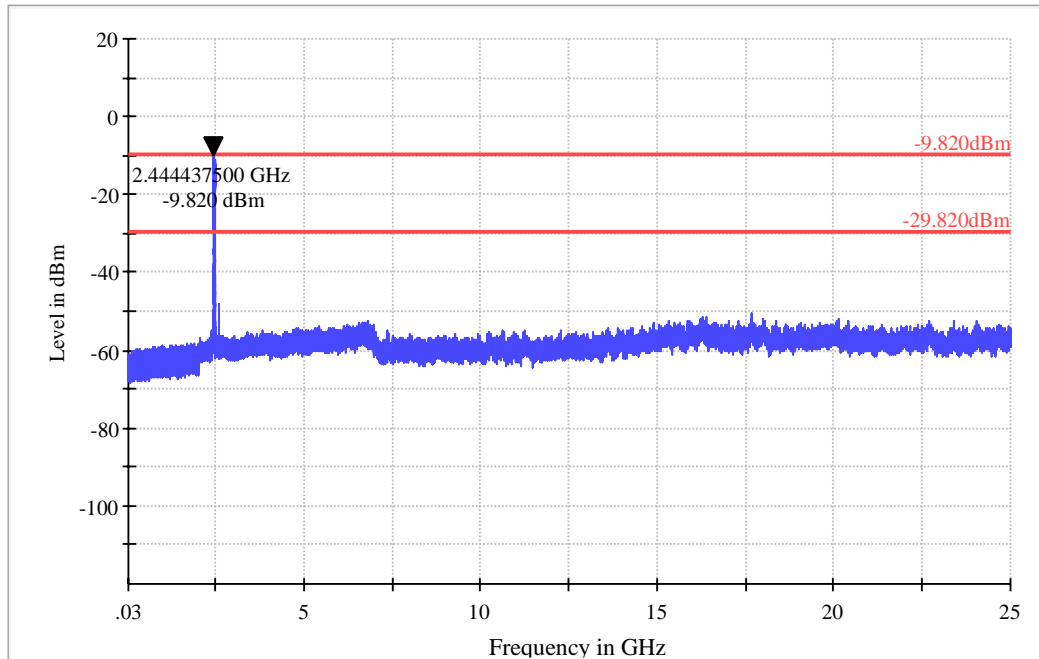

In any 100kHz bandwidth, the Conducted Spurious Emissions from 30 MHz to 25 GHz were greater than 20dB below the peak emission within the band that contains the highest level of the desired power.

TEST REPORT

4.6 Out of Band Radiated Emissions

For out of band radiated emissions into Non-Restricted Frequency Bands were performed at a 3m separation distance to determine whether these emissions complied with the 20dB attenuation requirement.

Not required, since all emissions are more than 20dB below fundamental

See attached data sheet

TEST REPORT

4.7 Radiated Emissions in Restricted Bands

| | |
|-----------------------------|--|
| Test Requirement: | FCC Part 15 C section 15.247 (d) In addition, radiated emissions which fall in the restricted bands, as defined in Section 15.205(a), must also comply with the radiated emission limits specified in Section 15.209(a) (see Section 15.205(c)). |
| Test Method: | ANSI C63.10: Clause 11.12.1, 6.4, 6.5 and 6.6 |
| Test Status: | Pre-Scan has been conducted to determine the worst-case mode from all possible combinations between available modulations, data rates and antenna ports (if EUT with antenna diversity architecture). Following channel(s) was (were) selected for the final test as listed below. |
| Test site: | Measurement Distance: 3m (Semi-Anechoic Chamber) |
| Limit: | 40.0 dB μ V/m between 30MHz & 88MHz; 43.5 dB μ V/m between 88MHz & 216MHz; 46.0 dB μ V/m between 216MHz & 960MHz; 54.0 dB μ V/m above 960MHz. |
| Detector: | For Peak and Quasi-Peak value: RBW = 1 MHz for $f \geq 1$ GHz, 200 Hz for 9 kHz to 150 kHz 9 kHz for 150 kHz to 30 MHz 120 kHz for 30 MHz to 1GHz VBW \geq RBW Sweep = auto Detector function = peak for $f \geq 1$ GHz, QP for $f < 1$ GHz Trace = max hold For AV value: RBW = 1 MHz for $f \geq 1$ GHz, 100 kHz for $f < 1$ GHz VBW=10 Hz Sweep = auto Trace = max hold |
| Field Strength Calculation: | The field strength is calculated by adding the reading on the Spectrum Analyzer to the factors associated with preamplifiers (if any), antennas, cables, pulse desensitization and average factors (when specified limit is in average and measurements are made with peak detectors). A sample calculation is included below: FS = RA + AF + CF - AG + PD + AV FS = RA + Correct Factor + AV FS = Field Strength in dB μ V/m |
| Where: | |

TEST REPORT

RA = Receiver Amplitude (including preamplifier) in dB μ V

AF = Antenna Factor in dB

CF = Cable Attenuation Factor in dB

AG = Amplifier Gain in dB

PD = Pulse Desensitization in dB

AV = Average Factor in -dB

Correct Factor = AF + CF - AG + PD

In the radiated emission table which follows, the reading shown on the data table may reflect the preamplifier gain. An example of the calculations, where the reading does not reflect the preamplifier gain, follows:

$FS = RA + AF + CF - AG + PD + AV$

Assume a receiver reading of 62.0 dB μ V is obtained. The antenna factor of 7.4 dB and cable factor of 1.6 dB is added. The amplifier gain of 29 dB is subtracted. The pulse desensitization factor of the spectrum analyzer was 0 dB, and the resultant average factor was -10 dB. The net field strength for comparison to the appropriate emission limit is 32 dB μ V/m.

RA = 62.0 dB μ V

AF = 7.4 dB

CF = 1.6 dB

AG = 29.0 dB

PD = 0 dB

AV = -10 dB

Correct Factor = 7.4 + 1.6 - 29.0 + 0 = -20 dB

$FS = 62 + (-20) + (-10) = 32$ dB μ V/m

Remark: Above the 1GHz, spectrum used the RBW

1MHz(1/RBW=1us) for test, which is shorter than the width of one pulse, so PD=0dB

Section 15.205 Restricted bands of operation.

(a) Except as shown in paragraph (d) of this section. Only spurious emissions are permitted in any of the frequency bands listed below:

TEST REPORT

| MHz | MHz | MHz | GHz |
|---------------------|---------------------|-----------------|---------------|
| 0.090 - 0.110 | 16.42 - 16.423 | 399.9 - 410 | 4.5 - 5.15 |
| 10.495 - 0.505 | 16.69475 - 16.69525 | 608 - 614 | 5.35 - 5.46 |
| 2.1735 - 2.1905 | 16.80425 - 16.80475 | 960 - 1240 | 7.25 - 7.75 |
| 4.125 - 4.128 | 25.5 - 25.67 | 1300 - 1427 | 8.025 - 8.5 |
| 4.17725 - 4.17775 | 37.5 - 38.25 | 1435 - 1626.5 | 9.0 - 9.2 |
| 4.20725 - 4.20775 | 73 - 74.6 | 1645.5 - 1646.5 | 9.3 - 9.5 |
| 6.215 - 6.218 | 74.8 - 75.2 | 1660 - 1710 | 10.6 - 12.7 |
| 6.26775 - 6.26825 | 108 - 121.94 | 1718.8 - 1722.2 | 13.25 - 13.4 |
| 6.31175 - 6.31225 | 123 - 138 | 2200 - 2300 | 14.47 - 14.5 |
| 8.291 - 8.294 | 149.9 - 150.05 | 2310 - 2390 | 15.35 - 16.2 |
| 8.362 - 8.366 | 156.52475 - | 2483.5 - 2500 | 17.7 - 21.4 |
| 8.37625 - 8.38675 | 156.52525 | 2655 - 2900 | 22.01 - 23.12 |
| 8.41425 - 8.41475 | 156.7 - 156.9 | 3260 - 3267 | 23.6 - 24.0 |
| 12.29 - 12.293 | 162.0125 - 167.17 | 3332 - 3339 | 31.2 - 31.8 |
| 12.51975 - 12.52025 | 167.72 - 173.2 | 3345.8 - 3358 | 36.43 - 36.5 |
| 12.57675 - 12.57725 | 240 - 285 | 3600 - 4400 | |
| 13.36 - 13.41 | 322 - 335.4 | | |

TEST REPORT

Test Configuration:

1) 9 kHz to 30 MHz emissions:

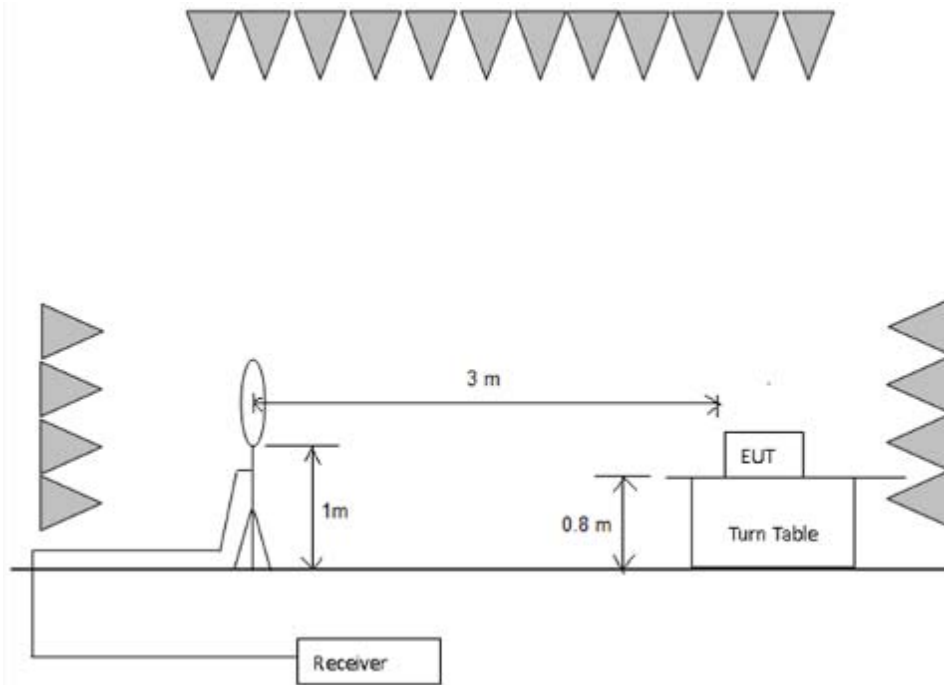

2) 30 MHz to 1 GHz emissions:

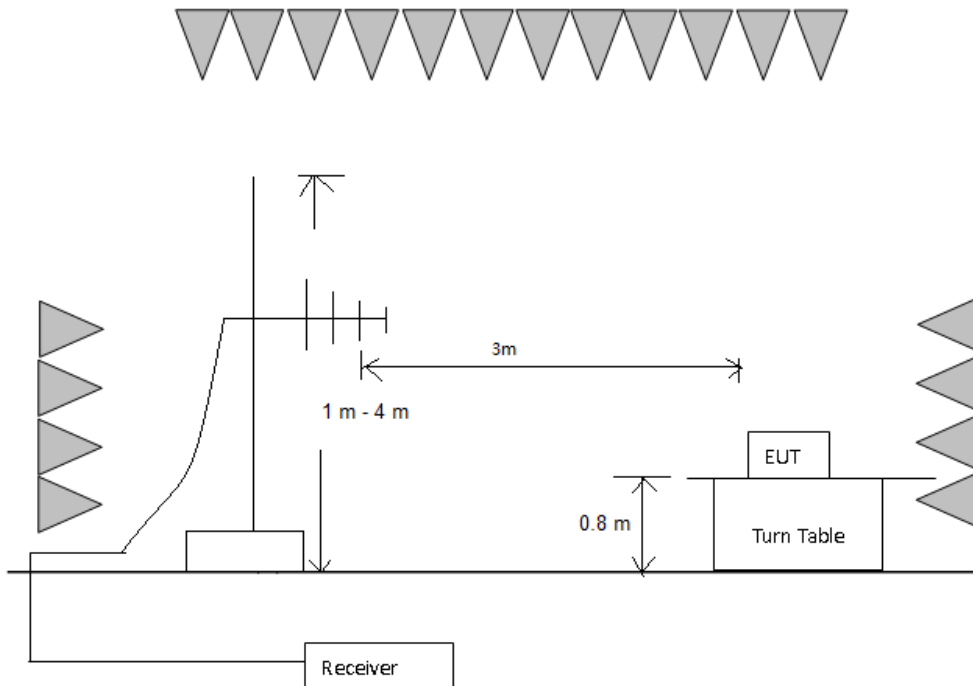

TEST REPORT

3) 1 GHz to 40 GHz emissions:

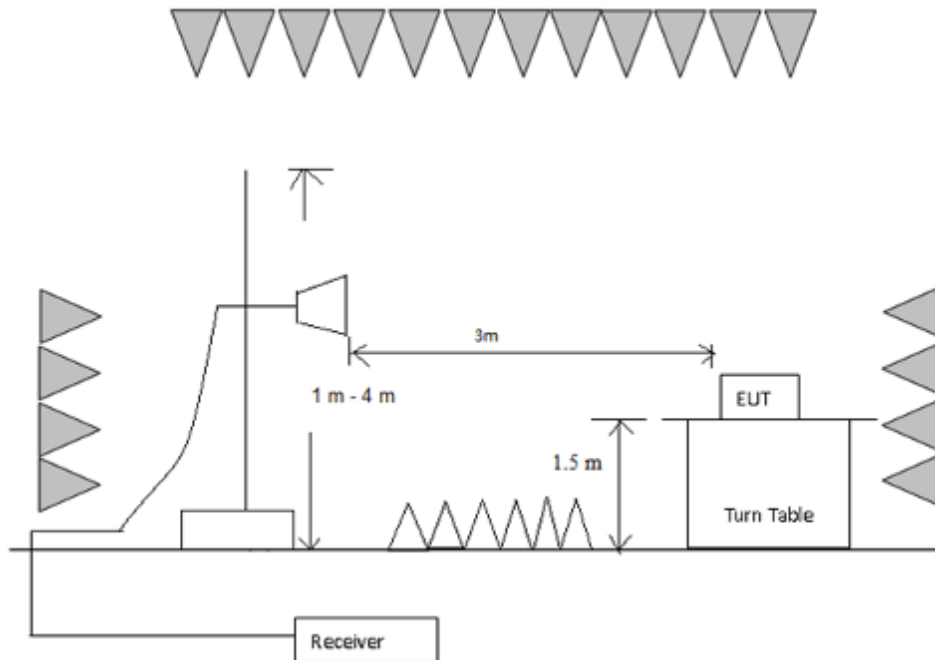

Test Procedure:

Test site with RF absorbing material covering the ground plane that met the site validation criterion called out in CISPR 16-1-4:2010 was used to perform radiated emission test above 1 GHz.

The receiver was scanned from 9 kHz to 25 GHz. When an emission was found, the table was rotated to produce the maximum signal strength. An initial pre-scan was performed for in peak detection mode using the receiver. The EUT was measured for both the Horizontal and Vertical polarities and performed a pre-test three orthogonal planes. For intentional radiators, measurements of the variation of the input power or the radiated signal level of the fundamental frequency component of the emission, as appropriate, shall be performed with the supply voltage varied between 85% and 115% of the nominal rated supply voltage. The worst case emissions were reported.

Used Test Equipment List:

3m Semi-Anechoic Chamber, EMI Test Receiver (9 kHz~7 GHz), Signal and Spectrum Analyzer (10 Hz~40 GHz), Loop antenna (9 kHz-30 MHz). TRILOG Super Broadband test Antenna(30 MHz-3 GHz) (RX), Double-Ridged Waveguide Horn Antenna (800 MHz-18 GHz)(RX) and High Frequency Antenna & preamplifier(18 GHz~26.5 GHz) (RX). Refer to Clause 5 Test Equipment List for details.

TEST REPORT

802.11b mode with 1Mbps data rate

9 kHz~30 MHz Field Strength of Unwanted Emissions. Quasi-Peak Measurement

The measurements with active loop antenna were greater than 20dB below the limit, so the test data were not recorded in the test report.

Test at Channel 1 (2.412 GHz) in transmitting status

30 MHz~1 GHz Spurious Emissions. Quasi-Peak Measurement

Horizontal:

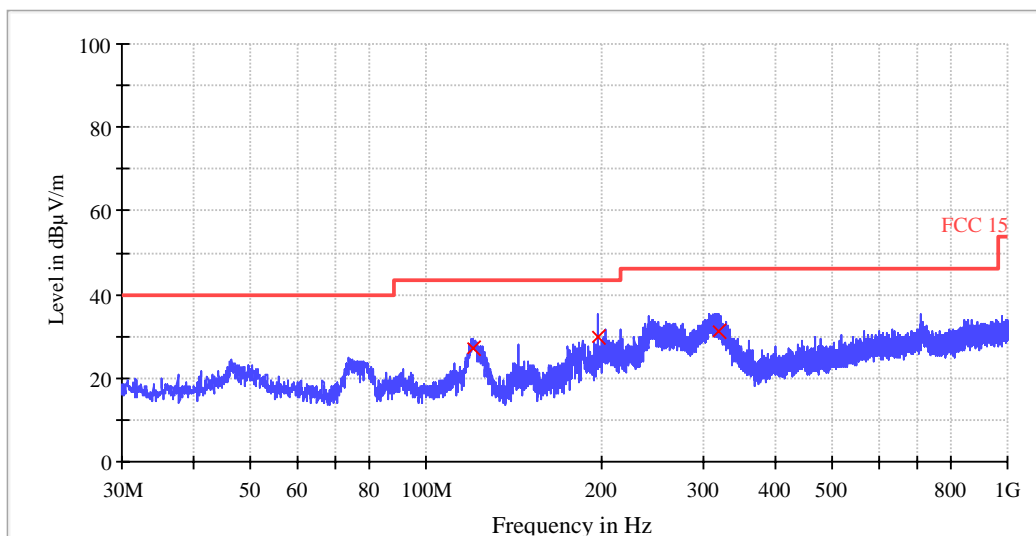

| Frequency (MHz) | Receiver Reading Level (dBµV) | Correction factors (dB/m) | Emission Level (dBµV/m) | Limit (dBµV/m) |
|-----------------|-------------------------------|---------------------------|-------------------------|----------------|
| 120.32 | 16.3 | 11.0 | 27.3 | 43.5 |
| 196.88 | 17.4 | 12.6 | 30.0 | 43.5 |
| 318.52 | 14.8 | 16.3 | 31.1 | 46.0 |

Remark:

1. Corr. (dB) = Antenna Factor (dB) + Cable Loss (dB)
2. Quasi Peak (dBµV/m) = Corr. (dB) + Read Level (dBµV)
3. Margin (dB) = Limit QPK (dBµV/m) –Quasi Peak (dBµV/m)

TEST REPORT

Vertical:

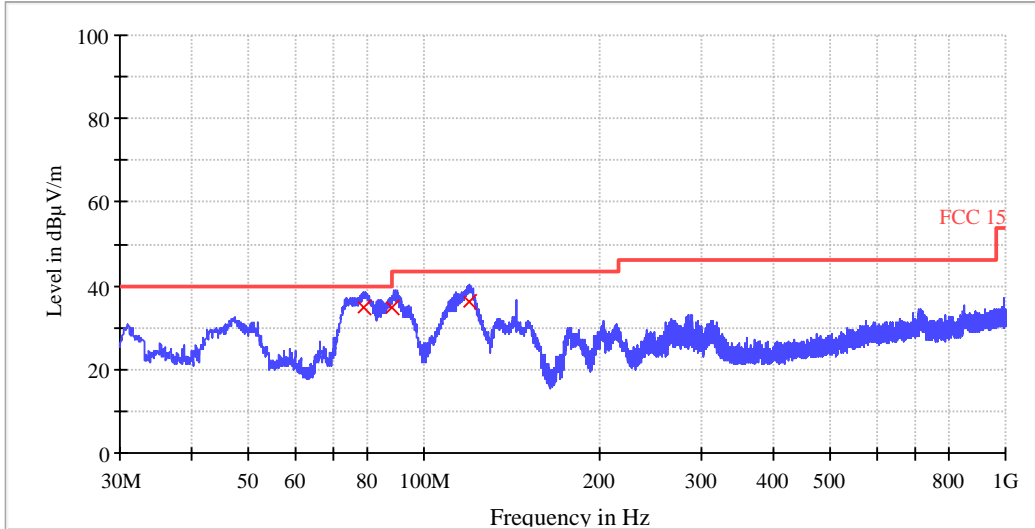

| Frequency (MHz) | Receiver Reading Level (dBµV) | Correction factors (dB/m) | Emission Level (dBµV/m) | Limit (dBµV/m) |
|-----------------|-------------------------------|---------------------------|-------------------------|----------------|
| 78.96 | 25.2 | 9.9 | 35.1 | 40.0 |
| 87.92 | 24.1 | 10.9 | 35.0 | 40.0 |
| 119.88 | 25.3 | 11.0 | 36.3 | 43.5 |

Remark:

1. Corr. (dB) = Antenna Factor (dB) + Cable Loss (dB)
2. Quasi Peak (dBµV/m) = Corr. (dB) + Read Level (dBµV)
3. Margin (dB) = Limit QPK (dBµV/m) – Quasi Peak (dBµV/m)

TEST REPORT

1~25 GHz Radiated Emissions.

PK Measurement:

| Frequency (MHz) | PK Reading Level (dBμV) | Correction factors (dB/m) | PK Emission Level (dBμV/m) | PK Limit (dBμV/m) | Antenna polarization |
|-----------------|-------------------------|---------------------------|----------------------------|-------------------|----------------------|
| 4823.24 | 47.4 | -0.5 | 46.9 | 74 | Horizontal |
| 7266.21 | 43.8 | 3.4 | 47.2 | 74 | Horizontal |
| 9648.19 | 43.2 | 6.3 | 49.5 | 74 | Horizontal |
| 4823.24 | 46.9 | -0.5 | 46.4 | 74 | Vertical |
| 7266.21 | 43.7 | 3.4 | 47.1 | 74 | Vertical |
| 9648.19 | 42.0 | 6.3 | 48.3 | 74 | Vertical |

AV Measurement:

| Frequency (MHz) | AV Reading Level (dBμV) | Correction factors (dB/m) | AV Emission Level (dBμV/m) | AV Limit (dBμV/m) | Antenna polarization |
|-----------------|-------------------------|---------------------------|----------------------------|-------------------|----------------------|
| 4823.24 | / | -0.5 | / | 54 | Horizontal |
| 7266.21 | / | 3.4 | / | 54 | Horizontal |
| 9648.19 | / | 6.3 | / | 54 | Horizontal |
| 4823.24 | / | -0.5 | / | 54 | Vertical |
| 7266.21 | / | 3.4 | / | 54 | Vertical |
| 9648.19 | / | 6.3 | / | 54 | Vertical |

The field strength is calculated by adding the Antenna Factor, Cable Factor & Pre-amplifier. The basic equation with a sample calculation is as follows:

Final Test Level = Receiver Reading + Correction Factor

Correction Factor = Antenna Factor + Cable Loss – Pre-amplifier Factor.

Remark:

Harmonic Emissions was tested with filter (Product name: MICRO-TRONICS, model name: BRM50702), other radiated emissions were found below the reference noise level. When Peak emission level was below AV limit, the AV emission level was not recorded.

TEST REPORT

Band Edge test Restricted Bands
Horizontal

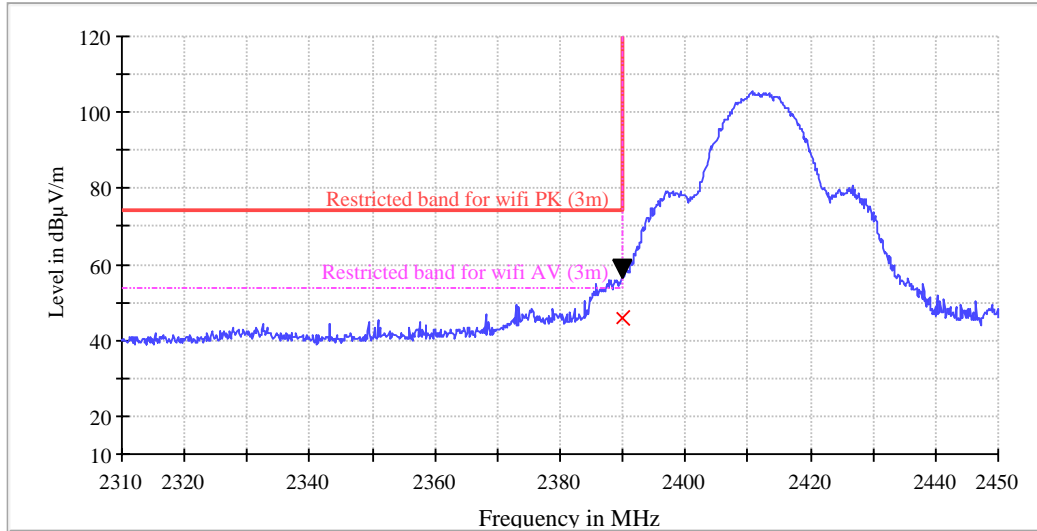

| Frequency (MHz) | PK Reading Level (dBµV) | Correction factors (dB/m) | PK Emission Level (dBµV/m) | Limit (dBµV/m) |
|-----------------|-------------------------|---------------------------|----------------------------|----------------|
| 2389.94 | 59.2 | -2.3 | 56.9 | 74.0 |

| Frequency (MHz) | AV Reading Level (dBµV) | Correction factors (dB/m) | AV Emission Level (dBµV/m) | Limit (dBµV/m) |
|-----------------|-------------------------|---------------------------|----------------------------|----------------|
| 2389.94 | 48.1 | -2.3 | 45.8 | 54.0 |

Remark:

Final Test Level = Receiver Reading + Correction Factor

Correction Factor = Antenna Factor + Cable Loss – Preamplifier Factor.

When Peak emission level was below AV limit, the AV emission level was not recorded.

TEST REPORT

Vertical

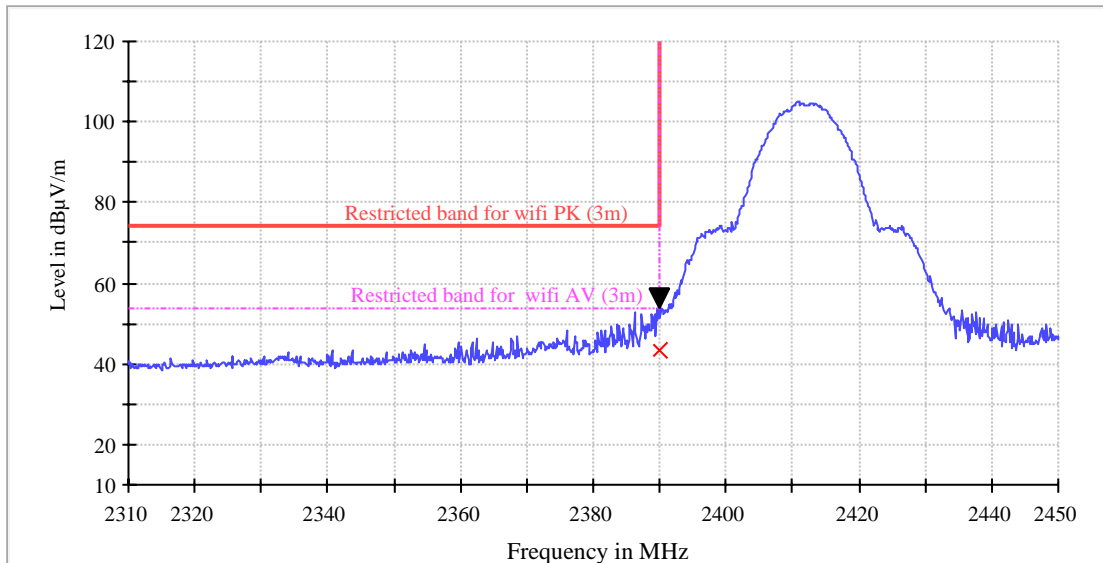

| Frequency (MHz) | PK Reading Level (dBµV) | Correction factors (dB/m) | PK Emission Level (dBµV/m) | Limit (dBµV/m) |
|-----------------|-------------------------|---------------------------|----------------------------|----------------|
| 2389.94 | 56.5 | -2.3 | 54.2 | 74.0 |

| Frequency (MHz) | AV Reading Level (dBµV) | Correction factors (dB/m) | AV Emission Level (dBµV/m) | Limit (dBµV/m) |
|-----------------|-------------------------|---------------------------|----------------------------|----------------|
| 2389.94 | 45.7 | -2.3 | 43.4 | 54.0 |

Remark:

Final Test Level = Receiver Reading + Correction Factor

Correction Factor = Antenna Factor + Cable Loss – Preamplifier Factor.

When Peak emission level was below AV limit, the AV emission level was not recorded.

TEST REPORT

Test at Channel 6 (2.437 GHz) in transmitting status.
30 MHz~1 GHz Radiated Emissions .Quasi-Peak Measurement

Horizontal:

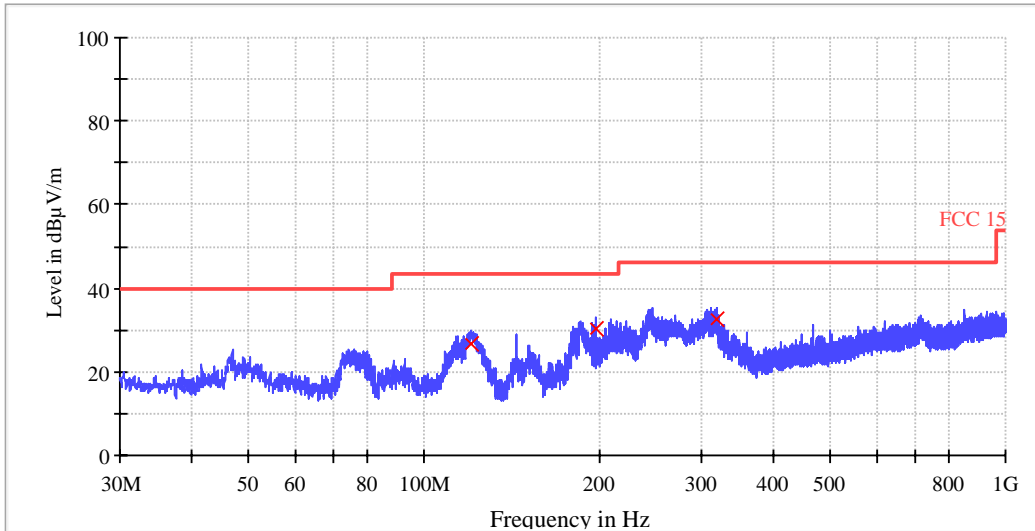

| Frequency (MHz) | Receiver Reading Level (dBµV) | Correction factors (dB/m) | Emission Level (dBµV/m) | Limit (dBµV/m) |
|-----------------|-------------------------------|---------------------------|-------------------------|----------------|
| 120.80 | 15.7 | 10.9 | 26.6 | 43.5 |
| 196.92 | 17.7 | 12.6 | 30.3 | 43.5 |
| 317.72 | 16.4 | 16.3 | 32.7 | 46.0 |

TEST REPORT

Vertical:

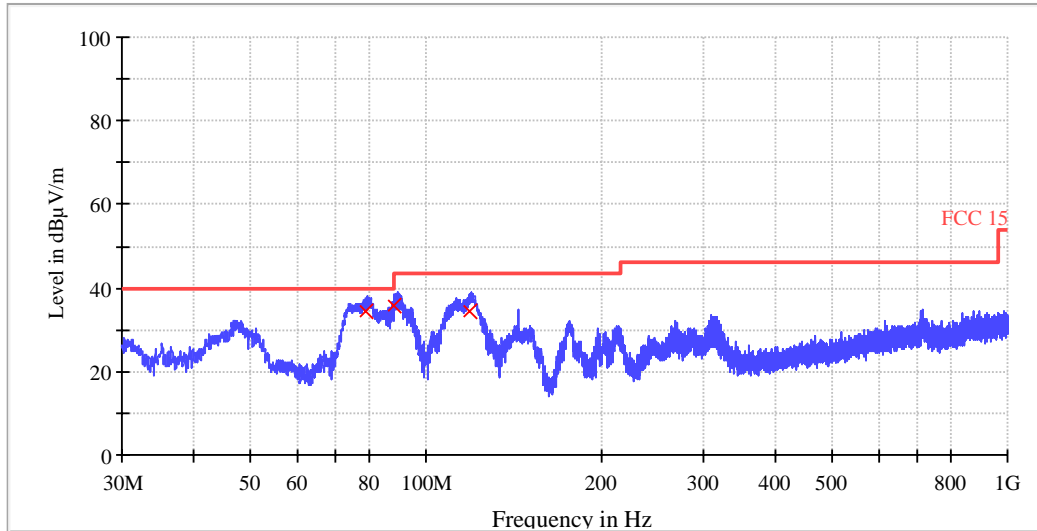

| Frequency (MHz) | Receiver Reading Level (dBµV) | Correction factors (dB/m) | Emission Level (dBµV/m) | Limit (dBµV/m) |
|-----------------|-------------------------------|---------------------------|-------------------------|----------------|
| 78.84 | 24.4 | 9.9 | 34.3 | 40.0 |
| 87.76 | 24.8 | 10.9 | 35.7 | 40.0 |
| 118.80 | 23.1 | 11.2 | 34.3 | 43.5 |

Remark:

1. Corr. (dB) = Antenna Factor (dB) + Cable Loss (dB)
2. Quasi Peak (dBµV/m) = Corr. (dB) + Read Level (dBµV)
3. Margin (dB) = Limit QPK (dBµV/m) – Quasi Peak (dBµV/m)

TEST REPORT

1~25 GHz Radiated Emissions. Peak & Average Measurement

PK Measurement:

| Frequency (MHz) | PK Reading Level (dBμV) | Correction factors (dB/m) | PK Emission Level (dBμV/m) | PK Limit (dBμV/m) | Antenna polarization |
|-----------------|-------------------------|---------------------------|----------------------------|-------------------|----------------------|
| 4873.79 | 46.7 | -0.5 | 46.2 | 74 | Horizontal |
| 7310.31 | 42.9 | 3.8 | 46.7 | 74 | Horizontal |
| 9749.25 | 40.5 | 6.8 | 47.3 | 74 | Horizontal |
| 4873.79 | 47.0 | -0.5 | 46.5 | 74 | Vertical |
| 7310.31 | 43.3 | 3.8 | 47.1 | 74 | Vertical |
| 9749.25 | 40.1 | 6.8 | 46.9 | 74 | Vertical |

AV Measurement:

| Frequency (MHz) | AV Reading Level (dBμV) | Correction factors (dB/m) | AV Emission Level (dBμV/m) | AV Limit (dBμV/m) | Antenna polarization |
|-----------------|-------------------------|---------------------------|----------------------------|-------------------|----------------------|
| 4873.79 | / | -0.5 | / | 54 | Horizontal |
| 7310.31 | / | 3.8 | / | 54 | Horizontal |
| 9749.25 | / | 6.8 | / | 54 | Horizontal |
| 4873.79 | / | -0.5 | / | 54 | Vertical |
| 7310.31 | / | 3.8 | / | 54 | Vertical |
| 9749.25 | / | 6.8 | / | 54 | Vertical |

The field strength is calculated by adding the Antenna Factor, Cable Factor & Pre-amplifier. The basic equation with a sample calculation is as follows:

Final Test Level = Receiver Reading + Correction Factor

Correction Factor = Antenna Factor + Cable Loss – Pre-amplifier Factor.

Remark:

Harmonic Emissions was tested with filter (Product name: MICRO-TRONICS, model name: BRM50702), other radiated emissions were found below the reference noise level. When Peak emission level was below AV limit, the AV emission level was not recorded.

TEST REPORT

Test at Channel 11 (2.462 GHz) in transmitting status
30 MHz~1 GHz Radiated Emissions .Quasi-Peak Measurement

Horizontal:

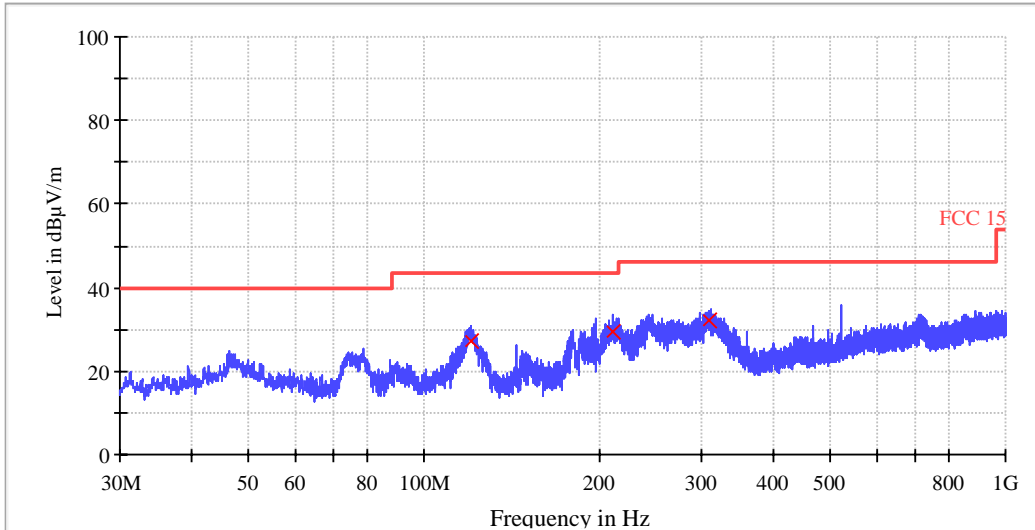

| Frequency (MHz) | Receiver Reading Level (dBµV) | Correction factors (dB/m) | Emission Level (dBµV/m) | Limit (dBµV/m) |
|-----------------|-------------------------------|---------------------------|-------------------------|----------------|
| 120.16 | 16.4 | 11.0 | 27.4 | 43.5 |
| 210.96 | 16.0 | 13.2 | 29.2 | 43.5 |
| 308.60 | 16.0 | 16.1 | 32.1 | 46.0 |

Remark:

1. Corr. (dB) = Antenna Factor (dB) + Cable Loss (dB)
2. Quasi Peak (dBµV/m) = Corr. (dB) + Read Level (dBµV)
3. Margin (dB) = Limit QPK (dBµV/m) –Quasi Peak (dBµV/m)

TEST REPORT

Vertical:

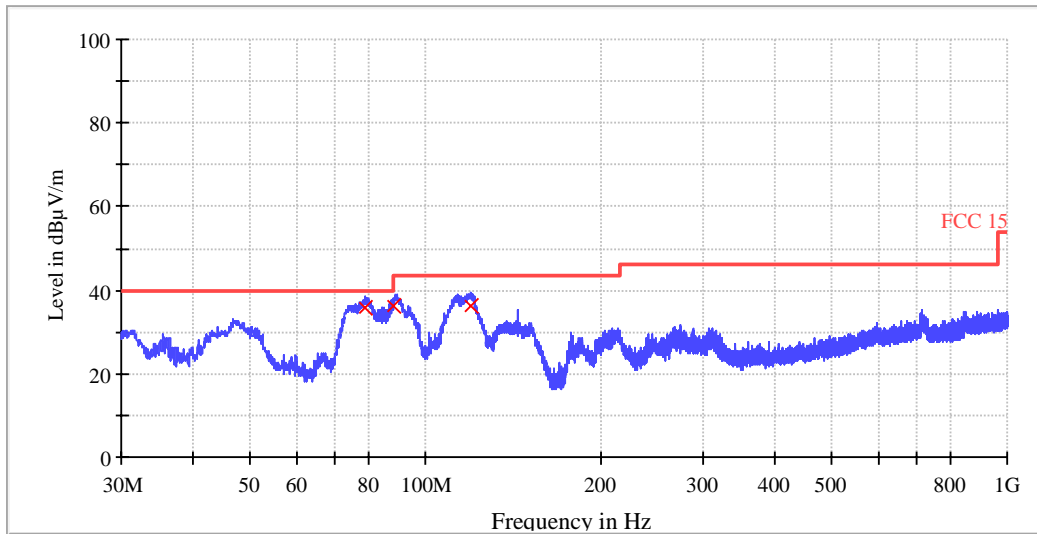

| Frequency (MHz) | Receiver Reading Level (dBµV) | Correction factors (dB/m) | Emission Level (dBµV/m) | Limit (dBµV/m) |
|-----------------|-------------------------------|---------------------------|-------------------------|----------------|
| 78.60 | 25.9 | 9.9 | 35.8 | 40.0 |
| 87.84 | 25.1 | 10.9 | 36.0 | 40.0 |
| 119.48 | 25.2 | 11.1 | 36.3 | 43.5 |

Remark:

1. Corr. (dB) = Antenna Factor (dB) + Cable Loss (dB)
2. Quasi Peak (dBµV/m) = Corr. (dB) + Read Level (dBµV)
3. Margin (dB) = Limit QPK (dBµV/m) – Quasi Peak (dBµV/m)

TEST REPORT

1~25 GHz Radiated Emissions. Peak & Average Measurement

PK Measurement:

| Frequency (MHz) | PK Reading Level (dBμV) | Correction factors (dB/m) | PK Emission Level (dBμV/m) | PK Limit (dBμV/m) | Antenna polarization |
|-----------------|-------------------------|---------------------------|----------------------------|-------------------|----------------------|
| 4923.56 | 47.7 | -0.5 | 47.2 | 74 | Horizontal |
| 7386.47 | 42.7 | 4.2 | 46.9 | 74 | Horizontal |
| 9573.32 | 40.5 | 7.3 | 47.8 | 74 | Horizontal |
| 4923.56 | 47.2 | -0.5 | 46.7 | 74 | Vertical |
| 7386.47 | 43.1 | 4.2 | 47.3 | 74 | Vertical |
| 9573.32 | 40.2 | 7.3 | 47.5 | 74 | Vertical |

AV Measurement:

| Frequency (MHz) | AV Reading Level (dBμV) | Correction factors (dB/m) | AV Emission Level (dBμV/m) | AV Limit (dBμV/m) | Antenna polarization |
|-----------------|-------------------------|---------------------------|----------------------------|-------------------|----------------------|
| 4923.56 | / | -0.5 | / | 54 | Horizontal |
| 7386.47 | / | 4.2 | / | 54 | Horizontal |
| 9573.32 | / | 7.3 | / | 54 | Horizontal |
| 4923.56 | / | -0.5 | / | 54 | Vertical |
| 7386.47 | / | 4.2 | / | 54 | Vertical |
| 9573.32 | / | 7.3 | / | 54 | Vertical |

The field strength is calculated by adding the Antenna Factor, Cable Factor & Pre-amplifier. The basic equation with a sample calculation is as follows:

Final Test Level = Receiver Reading + Correction Factor

Correction Factor = Antenna Factor + Cable Loss – Pre-amplifier Factor.

Remark:

Harmonic Emissions was tested with filter (Product name: MICRO-TRONICS, model name: BRM50702), other radiated emissions were found below the reference noise level. When Peak emission level was below AV limit, the AV emission level was not recorded.

TEST REPORT

Band Edge test Restricted Bands
Horizontal

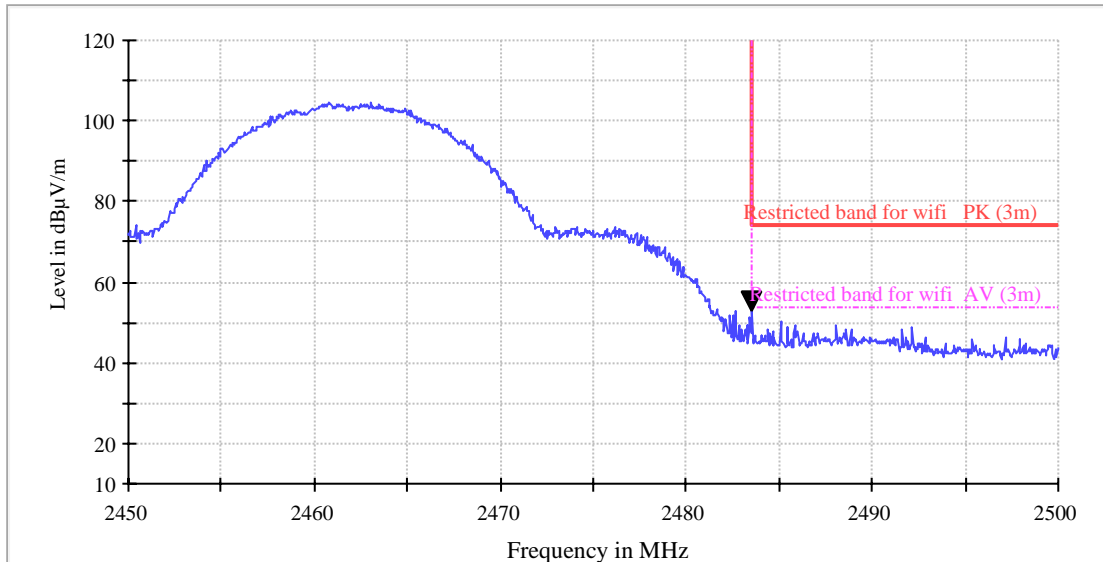

| Frequency (MHz) | PK Reading Level (dBµV) | Correction factors (dB/m) | PK Emission Level (dBµV/m) | Limit (dBµV/m) |
|-----------------|-------------------------|---------------------------|----------------------------|----------------|
| 2483.5 | 55.1 | -2.1 | 53.0 | 74.0 |

Remark:

Final Test Level = Receiver Reading + Correction Factor

Correction Factor = Antenna Factor + Cable Loss – Preamplifier Factor.

When Peak emission level was below AV limit, the AV emission level was not recorded.

TEST REPORT

Vertical

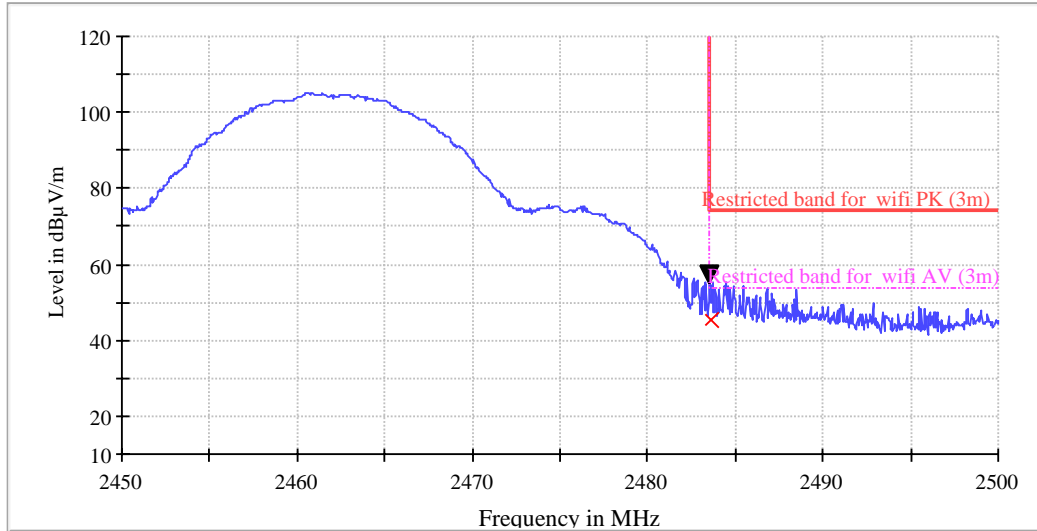

| Frequency (MHz) | PK Reading Level (dBµV) | Correction factors (dB/m) | PK Emission Level (dBµV/m) | Limit (dBµV/m) |
|-----------------|-------------------------|---------------------------|----------------------------|----------------|
| 2483.5 | 57.6 | -2.1 | 55.5 | 74.0 |

| Frequency (MHz) | AV Reading Level (dBµV) | Correction factors (dB/m) | AV Emission Level (dBµV/m) | Limit (dBµV/m) |
|-----------------|-------------------------|---------------------------|----------------------------|----------------|
| 2483.5 | 47.3 | -2.1 | 45.2 | 54.0 |

Remark:

Final Test Level = Receiver Reading + Correction Factor

Correction Factor = Antenna Factor + Cable Loss – Pre-amplifier Factor.

When Peak emission level was below AV limit, the AV emission level was not recorded.

TEST REPORT

802.11g mode with 6Mbps data rate

9 kHz~30 MHz Field Strength of Unwanted Emissions. Quasi-Peak Measurement

The measurements with active loop antenna were greater than 20dB below the limit, so the test data were not recorded in the test report.

Test at Channel 1 (2.412 GHz) in transmitting status

30 MHz~1 GHz Spurious Emissions .Quasi-Peak Measurement

Horizontal:

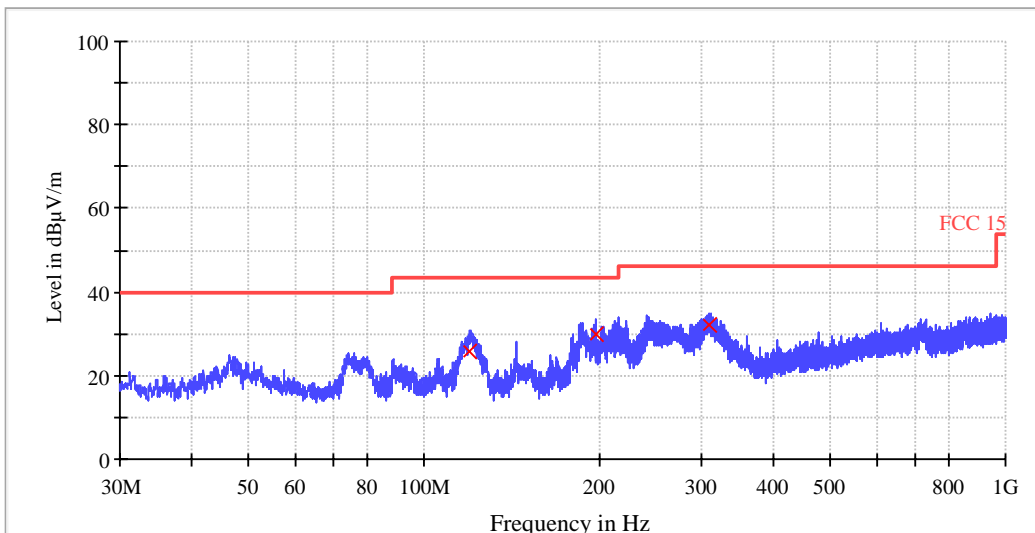

| Frequency (MHz) | Receiver Reading Level (dBµV) | Correction factors (dB/m) | Emission Level (dBµV/m) | Limit (dBµV/m) |
|-----------------|-------------------------------|---------------------------|-------------------------|----------------|
| 120.04 | 14.8 | 11.0 | 25.8 | 43.5 |
| 196.92 | 17.5 | 12.6 | 30.1 | 43.5 |
| 308.96 | 16.0 | 16.1 | 32.1 | 46.0 |

Remark:

1. Corr. (dB) = Antenna Factor (dB) + Cable Loss (dB)
2. Quasi Peak (dBµV/m) = Corr. (dB) + Read Level (dBµV)
3. Margin (dB) = Limit QPK (dBµV/m) –Quasi Peak (dBµV/m)

TEST REPORT

Vertical:

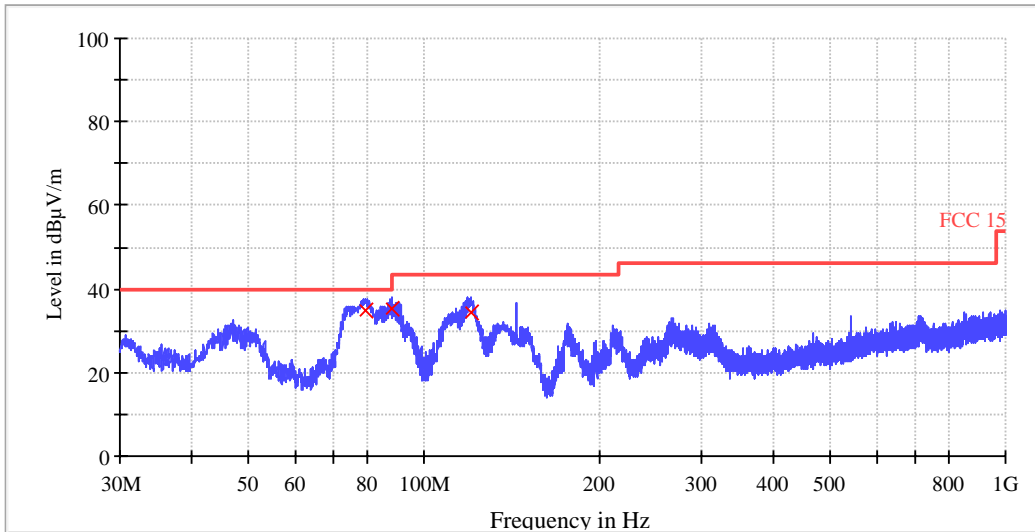

| Frequency (MHz) | Receiver Reading Level (dBµV) | Correction factors (dB/m) | Emission Level (dBµV/m) | Limit (dBµV/m) |
|-----------------|-------------------------------|---------------------------|-------------------------|----------------|
| 79.48 | 25.1 | 9.8 | 34.9 | 40.0 |
| 87.88 | 24.6 | 10.9 | 35.5 | 40.0 |
| 120.84 | 23.4 | 10.9 | 34.3 | 43.5 |

Remark:

1. Corr. (dB) = Antenna Factor (dB) + Cable Loss (dB)
2. Quasi Peak (dBµV/m) = Corr. (dB) + Read Level (dBµV)
3. Margin (dB) = Limit QPK (dBµV/m) – Quasi Peak (dBµV/m)

TEST REPORT

1~25 GHz Radiated Emissions.

PK Measurement:

| Frequency (MHz) | PK Reading Level (dBμV) | Correction factors (dB/m) | PK Emission Level (dBμV/m) | PK Limit (dBμV/m) | Antenna polarization |
|-----------------|-------------------------|---------------------------|----------------------------|-------------------|----------------------|
| 4828.47 | 46.4 | -0.5 | 45.9 | 74 | Horizontal |
| 7226.69 | 42.9 | 3.4 | 46.3 | 74 | Horizontal |
| 9647.32 | 41.5 | 6.3 | 47.8 | 74 | Horizontal |
| 4828.47 | 47.2 | -0.5 | 46.7 | 74 | Vertical |
| 7226.69 | 44.1 | 3.4 | 47.5 | 74 | Vertical |
| 9647.32 | 40.6 | 6.3 | 46.9 | 74 | Vertical |

AV Measurement:

| Frequency (MHz) | AV Reading Level (dBμV) | Correction factors (dB/m) | AV Emission Level (dBμV/m) | AV Limit (dBμV/m) | Antenna polarization |
|-----------------|-------------------------|---------------------------|----------------------------|-------------------|----------------------|
| 4828.47 | / | -0.5 | / | 54 | Horizontal |
| 7226.69 | / | 3.4 | / | 54 | Horizontal |
| 9647.32 | / | 6.3 | / | 54 | Horizontal |
| 4828.47 | / | -0.5 | / | 54 | Vertical |
| 7226.69 | / | 3.4 | / | 54 | Vertical |
| 9647.32 | / | 6.3 | / | 54 | Vertical |

The field strength is calculated by adding the Antenna Factor, Cable Factor & Pre-amplifier. The basic equation with a sample calculation is as follows:

Final Test Level = Receiver Reading + Correction Factor

Correction Factor = Antenna Factor + Cable Loss – Pre-amplifier Factor.

Remark:

Harmonic Emissions was tested with filter (Product name: MICRO-TRONICS, model name: BRM50702), other radiated emissions were found below the reference noise level. When Peak emission level was below AV limit, the AV emission level was not recorded.

TEST REPORT

Band Edge test Restricted Bands
Horizontal

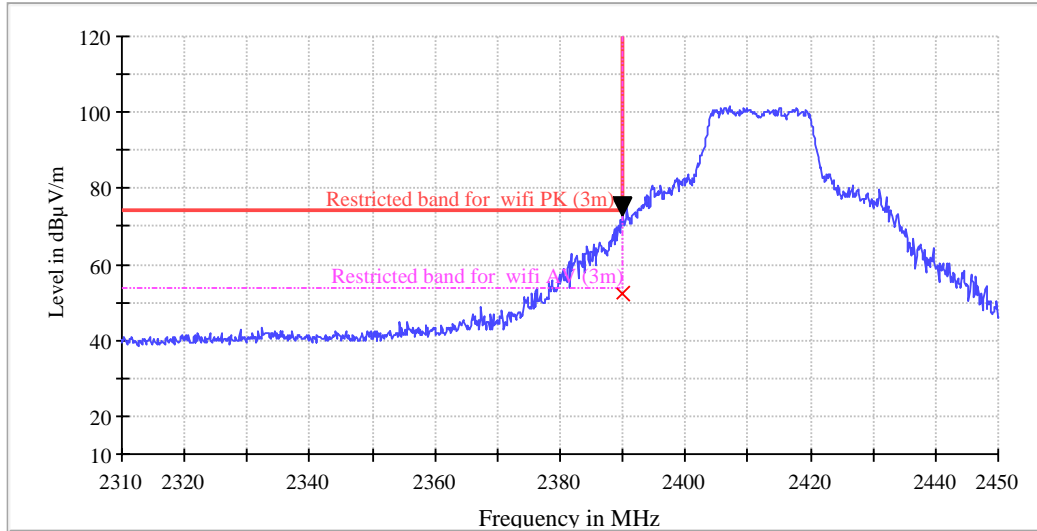

| Frequency (MHz) | PK Reading Level (dBµV) | Correction factors (dB/m) | PK Emission Level (dBµV/m) | Limit (dBµV/m) |
|-----------------|-------------------------|---------------------------|----------------------------|----------------|
| 2390.00 | 75.3 | -2.3 | 73.0 | 74.0 |

| Frequency (MHz) | AV Reading Level (dBµV) | Correction factors (dB/m) | AV Emission Level (dBµV/m) | Limit (dBµV/m) |
|-----------------|-------------------------|---------------------------|----------------------------|----------------|
| 2390.00 | 54.6 | -2.3 | 52.3 | 54.0 |

Remark:

Final Test Level = Receiver Reading + Correction Factor

Correction Factor = Antenna Factor + Cable Loss – Pre-amplifier Factor.

When Peak emission level was below AV limit, the AV emission level was not recorded.

TEST REPORT

Vertical

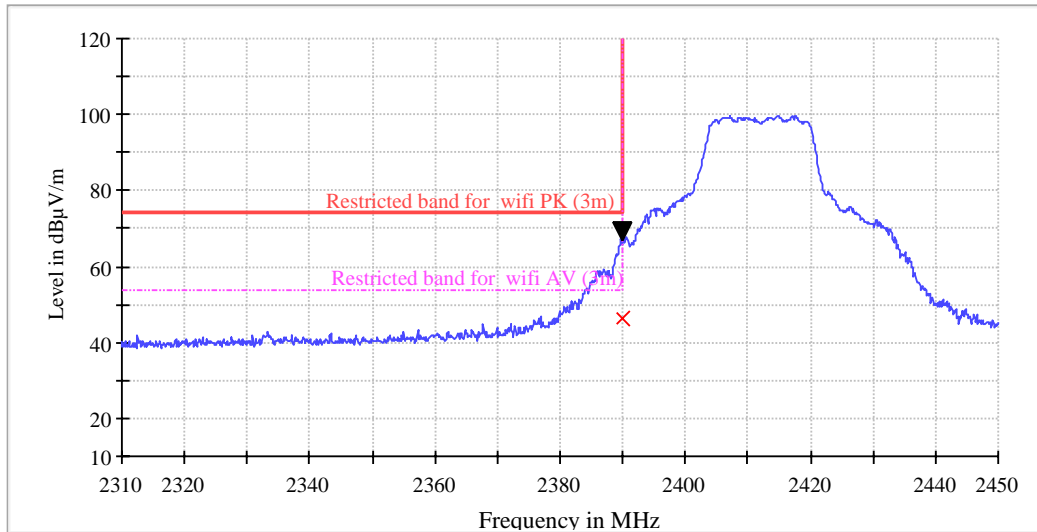

| Frequency (MHz) | PK Reading Level (dBµV) | Correction factors (dB/m) | PK Emission Level (dBµV/m) | Limit (dBµV/m) |
|-----------------|-------------------------|---------------------------|----------------------------|----------------|
| 2390.00 | 69.8 | -2.3 | 67.5 | 74.0 |

| Frequency (MHz) | AV Reading Level (dBµV) | Correction factors (dB/m) | AV Emission Level (dBµV/m) | Limit (dBµV/m) |
|-----------------|-------------------------|---------------------------|----------------------------|----------------|
| 2390.00 | 48.6 | -2.3 | 46.3 | 54.0 |

Remark:

Final Test Level = Receiver Reading + Correction Factor

Correction Factor = Antenna Factor + Cable Loss – Preamplifier Factor.

When Peak emission level was below AV limit, the AV emission level was not recorded.

TEST REPORT

Test at Channel 6 (2.437 GHz) in transmitting status
30 MHz~1 GHz Radiated Emissions .Quasi-Peak Measurement

Horizontal:

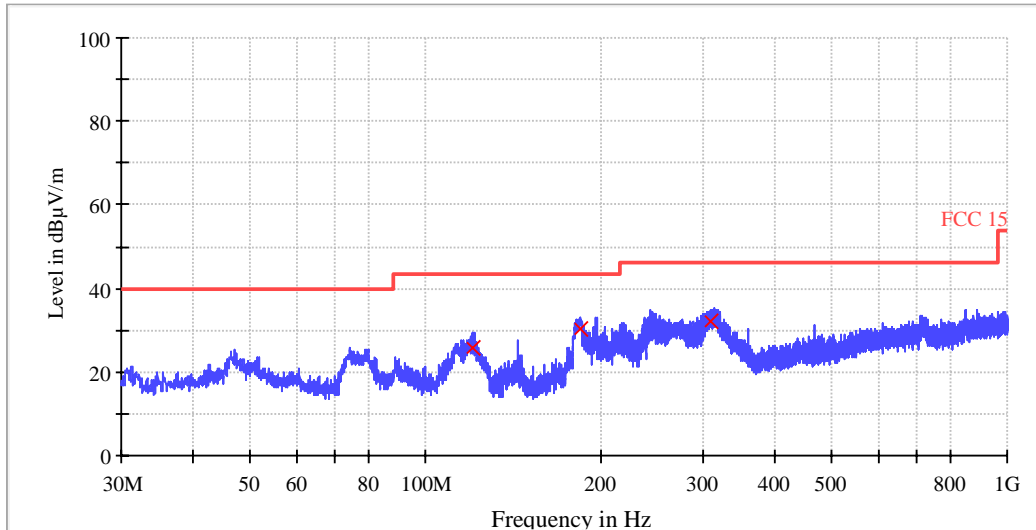

| Frequency (MHz) | Receiver Reading Level (dBµV) | Correction factors (dB/m) | Emission Level (dBµV/m) | Limit (dBµV/m) |
|-----------------|-------------------------------|---------------------------|-------------------------|----------------|
| 120.32 | 14.7 | 11.0 | 25.7 | 43.5 |
| 184.28 | 19.0 | 11.5 | 30.5 | 43.5 |
| 308.32 | 15.9 | 16.1 | 32.0 | 46.0 |

TEST REPORT

Vertical:

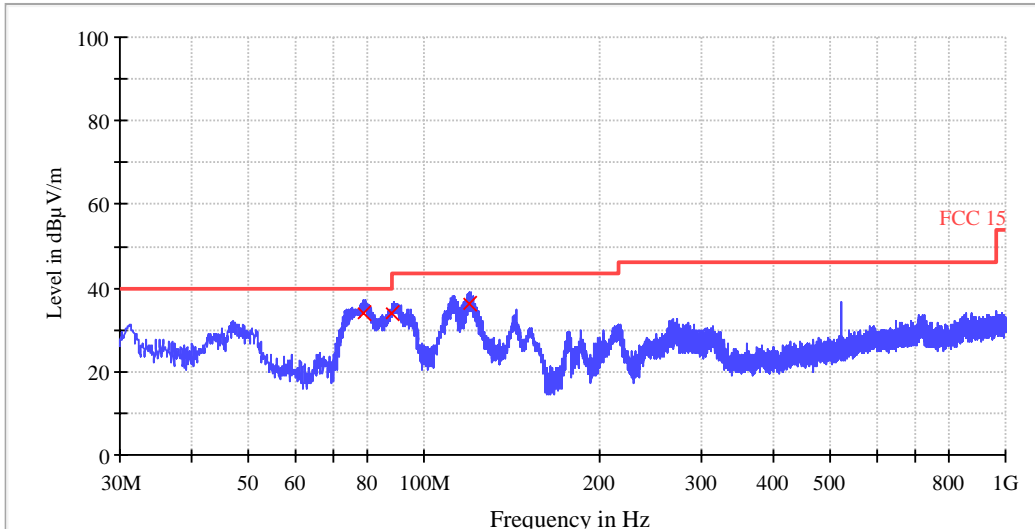

| Frequency (MHz) | Receiver Reading Level (dBµV) | Correction factors (dB/m) | Emission Level (dBµV/m) | Limit (dBµV/m) |
|-----------------|-------------------------------|---------------------------|-------------------------|----------------|
| 78.88 | 24.0 | 9.9 | 33.9 | 40.0 |
| 87.84 | 23.2 | 10.9 | 34.1 | 40.0 |
| 119.72 | 25.0 | 11.1 | 36.1 | 43.5 |

Remark:

1. Corr. (dB) = Antenna Factor (dB) + Cable Loss (dB)
2. Quasi Peak (dBµV/m) = Corr. (dB) + Read Level (dBµV)
3. Margin (dB) = Limit QPK (dBµV/m) – Quasi Peak (dBµV/m)

TEST REPORT

1~25 GHz Radiated Emissions. Peak & Average Measurement

PK Measurement:

| Frequency (MHz) | PK Reading Level (dBμV) | Correction factors (dB/m) | PK Emission Level (dBμV/m) | PK Limit (dBμV/m) | Antenna polarization |
|-----------------|-------------------------|---------------------------|----------------------------|-------------------|----------------------|
| 4869.23 | 47.0 | -0.5 | 46.5 | 74 | Horizontal |
| 7651.77 | 42.1 | 3.8 | 45.9 | 74 | Horizontal |
| 9749.56 | 39.4 | 6.8 | 46.2 | 74 | Horizontal |
| 4869.23 | 46.8 | -0.5 | 46.3 | 74 | Vertical |
| 7651.77 | 43.2 | 3.8 | 47.0 | 74 | Vertical |
| 9749.56 | 40.1 | 6.8 | 46.9 | 74 | Vertical |

AV Measurement:

| Frequency (MHz) | AV Reading Level (dBμV) | Correction factors (dB/m) | AV Emission Level (dBμV/m) | AV Limit (dBμV/m) | Antenna polarization |
|-----------------|-------------------------|---------------------------|----------------------------|-------------------|----------------------|
| 4869.23 | / | -0.5 | / | 54 | Horizontal |
| 7651.77 | / | 3.8 | / | 54 | Horizontal |
| 9749.56 | / | 6.8 | / | 54 | Horizontal |
| 4869.23 | / | -0.5 | / | 54 | Vertical |
| 7651.77 | / | 3.8 | / | 54 | Vertical |
| 9749.56 | / | 6.8 | / | 54 | Vertical |

The field strength is calculated by adding the Antenna Factor, Cable Factor & Pre-amplifier. The basic equation with a sample calculation is as follows:

Final Test Level = Receiver Reading + Correction Factor

Correction Factor = Antenna Factor + Cable Loss – Pre-amplifier Factor.

Remark:

Harmonic Emissions was tested with filter (Product name: MICRO-TRONICS, model name: BRM50702), other radiated emissions were found below the reference noise level. When Peak emission level was below AV limit, the AV emission level was not recorded.

TEST REPORT

Test at Channel 11 (2.462 GHz) in transmitting status
30 MHz~1 GHz Radiated Emissions .Quasi-Peak Measurement

Horizontal:

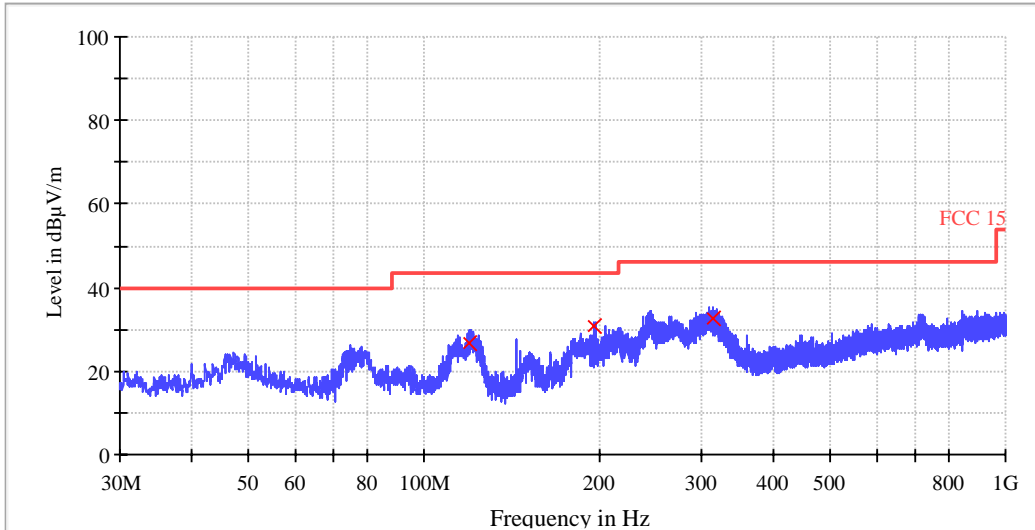

| Frequency (MHz) | Receiver Reading Level (dBµV) | Correction factors (dB/m) | Emission Level (dBµV/m) | Limit (dBµV/m) |
|-----------------|-------------------------------|---------------------------|-------------------------|----------------|
| 119.92 | 15.6 | 11.0 | 26.6 | 43.5 |
| 196.00 | 18.3 | 12.5 | 30.8 | 43.5 |
| 314.52 | 16.6 | 16.2 | 32.8 | 46.0 |

Remark:

1. Corr. (dB) = Antenna Factor (dB) + Cable Loss (dB)
2. Quasi Peak (dBµV/m) = Corr. (dB) + Read Level (dBµV)
3. Margin (dB) = Limit QPK (dBµV/m) –Quasi Peak (dBµV/m)

TEST REPORT

Vertical:

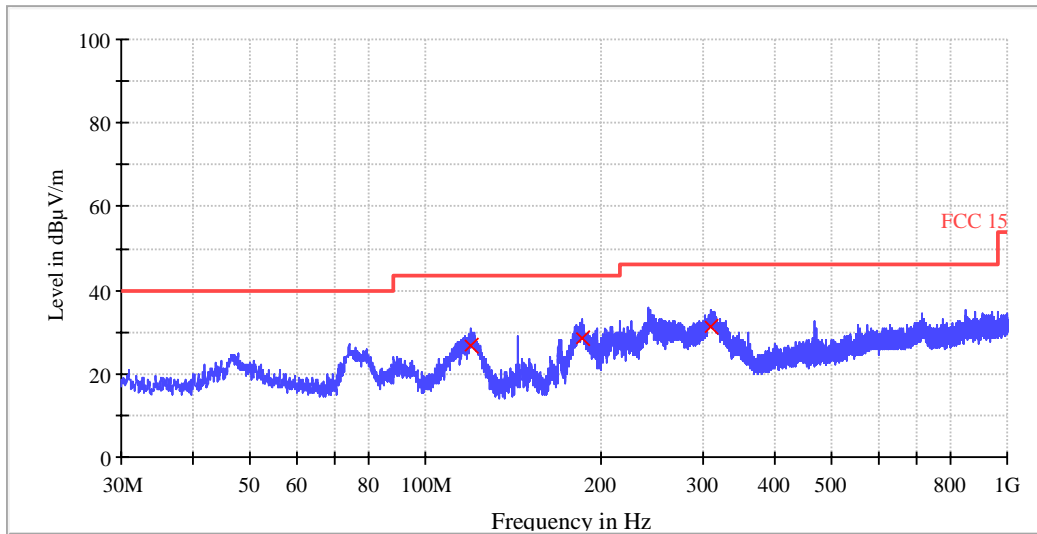

| Frequency (MHz) | Receiver Reading Level (dBµV) | Correction factors (dB/m) | Emission Level (dBµV/m) | Limit (dBµV/m) |
|-----------------|-------------------------------|---------------------------|-------------------------|----------------|
| 119.84 | 15.5 | 11.0 | 26.5 | 43.5 |
| 185.32 | 16.8 | 11.6 | 28.4 | 43.5 |
| 309.32 | 15.3 | 16.1 | 31.4 | 46.0 |

Remark:

1. Corr. (dB) = Antenna Factor (dB) + Cable Loss (dB)
2. Quasi Peak (dBµV/m) = Corr. (dB) + Read Level (dBµV)
3. Margin (dB) = Limit QPK (dBµV/m) – Quasi Peak (dBµV/m)

TEST REPORT

1~25 GHz Radiated Emissions. Peak & Average Measurement

PK Measurement:

| Frequency (MHz) | PK Reading Level (dBμV) | Correction factors (dB/m) | PK Emission Level (dBμV/m) | PK Limit (dBμV/m) | Antenna polarization |
|-----------------|-------------------------|---------------------------|----------------------------|-------------------|----------------------|
| 4925.39 | 48.1 | -0.5 | 47.6 | 74 | Horizontal |
| 7385.48 | 43.1 | 4.2 | 47.3 | 74 | Horizontal |
| 9847.64 | 39.6 | 7.3 | 46.9 | 74 | Horizontal |
| 4925.39 | 48.4 | -0.5 | 47.9 | 74 | Vertical |
| 7385.48 | 42.6 | 4.2 | 46.8 | 74 | Vertical |
| 9847.64 | 39.9 | 7.3 | 47.2 | 74 | Vertical |

AV Measurement:

| Frequency (MHz) | AV Reading Level (dBμV) | Correction factors (dB/m) | AV Emission Level (dBμV/m) | AV Limit (dBμV/m) | Antenna polarization |
|-----------------|-------------------------|---------------------------|----------------------------|-------------------|----------------------|
| 4925.39 | / | -0.5 | / | 54 | Horizontal |
| 7385.48 | / | 4.2 | / | 54 | Horizontal |
| 9847.64 | / | 7.3 | / | 54 | Horizontal |
| 4925.39 | / | -0.5 | / | 54 | Vertical |
| 7385.48 | / | 4.2 | / | 54 | Vertical |
| 9847.64 | / | 7.3 | / | 54 | Vertical |

The field strength is calculated by adding the Antenna Factor, Cable Factor & Pre-amplifier. The basic equation with a sample calculation is as follows:

Final Test Level = Receiver Reading + Correction Factor

Correction Factor = Antenna Factor + Cable Loss – Pre-amplifier Factor.

Remark:

Harmonic Emissions was tested with filter (Product name: MICRO-TRONICS, model name: BRM50702), other radiated emissions were found below the reference noise level. When Peak emission level was below AV limit, the AV emission level was not recorded.

TEST REPORT

Band Edge test Restricted Bands
Horizontal

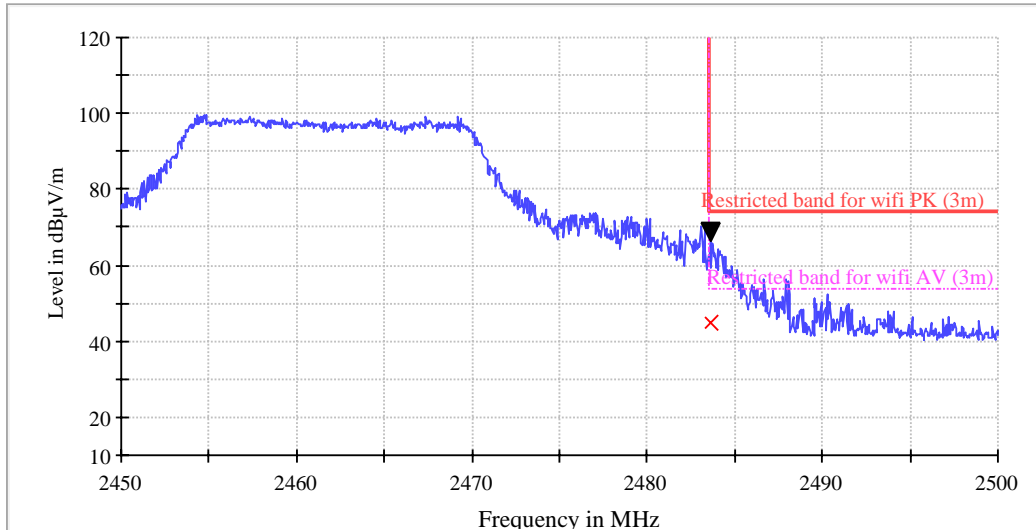

| Frequency (MHz) | PK Reading Level (dBµV) | Correction factors (dB/m) | PK Emission Level (dBµV/m) | Limit (dBµV/m) |
|-----------------|-------------------------|---------------------------|----------------------------|----------------|
| 2483.5 | 68.9 | -2.1 | 66.8 | 74.0 |

| Frequency (MHz) | AV Reading Level (dBµV) | Correction factors (dB/m) | AV Emission Level (dBµV/m) | Limit (dBµV/m) |
|-----------------|-------------------------|---------------------------|----------------------------|----------------|
| 2484.50 | 47.2 | -2.1 | 45.1 | 54.0 |

Remark:

Final Test Level = Receiver Reading + Correction Factor

Correction Factor = Antenna Factor + Cable Loss – Preamplifier Factor.

When Peak emission level was below AV limit, the AV emission level was not recorded.

TEST REPORT

Vertical

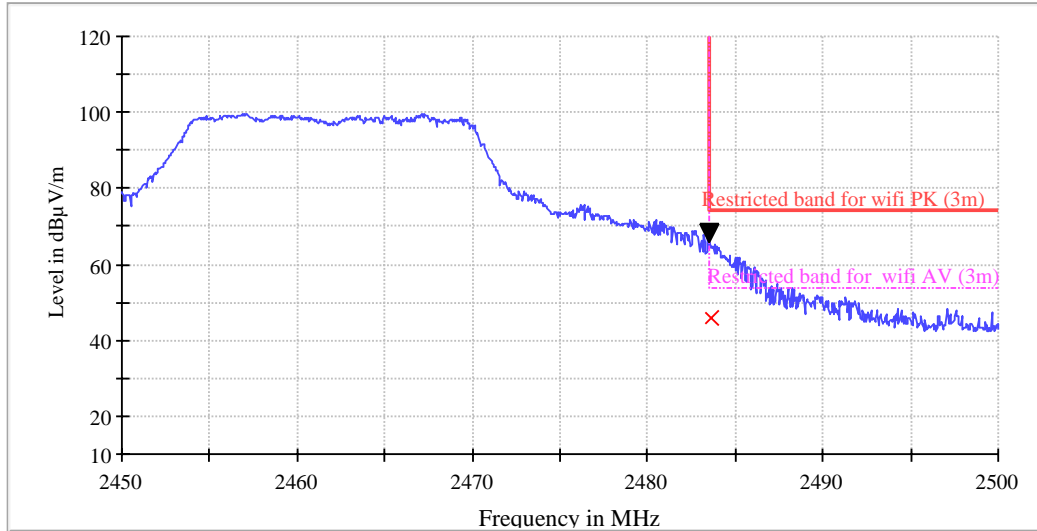

| Frequency (MHz) | PK Reading Level (dBµV) | Correction factors (dB/m) | PK Emission Level (dBµV/m) | Limit (dBµV/m) |
|-----------------|-------------------------|---------------------------|----------------------------|----------------|
| 2484.50 | 68.5 | -2.1 | 66.4 | 74.0 |

| Frequency (MHz) | AV Reading Level (dBµV) | Correction factors (dB/m) | AV Emission Level (dBµV/m) | Limit (dBµV/m) |
|-----------------|-------------------------|---------------------------|----------------------------|----------------|
| 2484.50 | 47.8 | -2.1 | 45.7 | 54.0 |

Remark:

Final Test Level = Receiver Reading + Correction Factor

Correction Factor = Antenna Factor + Cable Loss – Preamplifier Factor.

When Peak emission level was below AV limit, the AV emission level was not recorded.

TEST REPORT

802.11n (HT20) mode with 6.5Mbps data rate
9 kHz~30 MHz Field Strength of Unwanted Emissions. Quasi-Peak Measurement
The measurements with active loop antenna were greater than 20dB below the limit, so the test data were not recorded in the test report.

Test at Channel 1 (2.412 GHz) in transmitting status
30 MHz~1 GHz Spurious Emissions .Quasi-Peak Measurement
Horizontal:

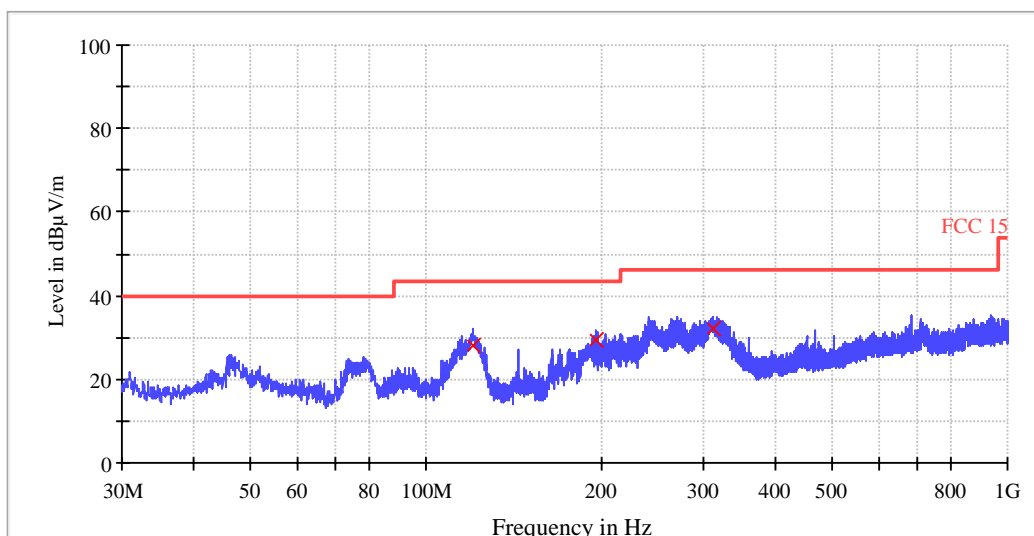

| Frequency (MHz) | Receiver Reading Level (dBµV) | Correction factors (dB/m) | Emission Level (dBµV/m) | Limit (dBµV/m) |
|-----------------|-------------------------------|---------------------------|-------------------------|----------------|
| 120.20 | 16.9 | 11.0 | 27.9 | 43.5 |
| 196.00 | 17.0 | 12.5 | 29.5 | 43.5 |
| 310.36 | 15.9 | 16.1 | 32.0 | 46.0 |

Remark:

1. Corr. (dB) = Antenna Factor (dB) + Cable Loss (dB)
2. Quasi Peak (dBµV/m) = Corr. (dB) + Read Level (dBµV)
3. Margin (dB) = Limit QPK (dBµV/m) –Quasi Peak (dBµV/m)

TEST REPORT

Vertical:

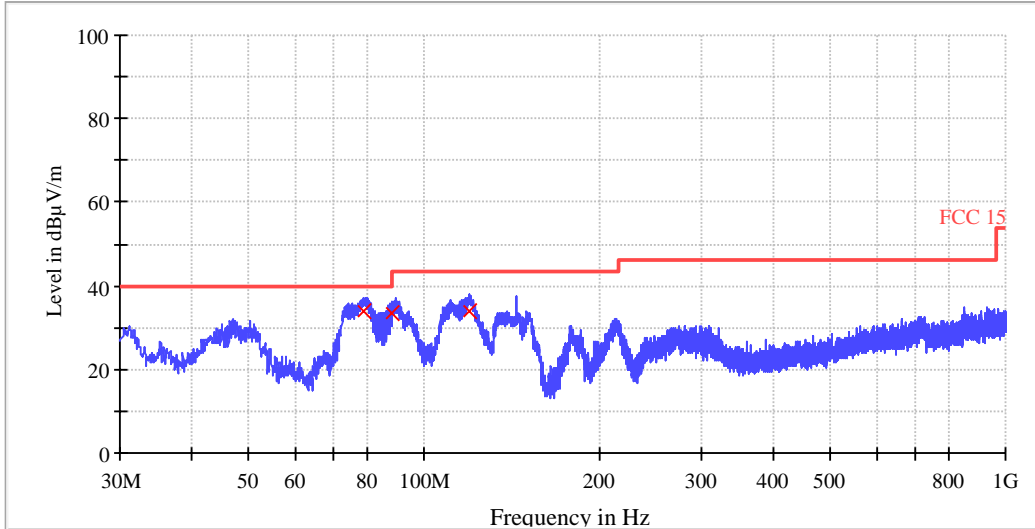

| Frequency (MHz) | Receiver Reading Level (dBµV) | Correction factors (dB/m) | Emission Level (dBµV/m) | Limit (dBµV/m) |
|-----------------|-------------------------------|---------------------------|-------------------------|----------------|
| 78.76 | 24.1 | 9.9 | 34.0 | 40.0 |
| 87.84 | 22.6 | 10.9 | 33.5 | 40.0 |
| 119.36 | 22.9 | 11.1 | 34.0 | 43.5 |

Remark:

1. Corr. (dB) = Antenna Factor (dB) + Cable Loss (dB)
2. Quasi Peak (dBµV/m) = Corr. (dB) + Read Level (dBµV)
3. Margin (dB) = Limit QPK (dBµV/m) – Quasi Peak (dBµV/m)

TEST REPORT

1~25 GHz Radiated Emissions.

PK Measurement:

| Frequency (MHz) | PK Reading Level (dBμV) | Correction factors (dB/m) | PK Emission Level (dBμV/m) | PK Limit (dBμV/m) | Antenna polarization |
|-----------------|-------------------------|---------------------------|----------------------------|-------------------|----------------------|
| 4830.19 | 47.0 | -0.5 | 46.5 | 74 | Horizontal |
| 7236.58 | 43.7 | 3.4 | 47.1 | 74 | Horizontal |
| 9648.74 | 40.6 | 6.3 | 46.9 | 74 | Horizontal |
| 4830.19 | 47.3 | -0.5 | 46.8 | 74 | Vertical |
| 7236.58 | 43.9 | 3.4 | 47.3 | 74 | Vertical |
| 9648.74 | 40.9 | 6.3 | 47.2 | 74 | Vertical |

AV Measurement:

| Frequency (MHz) | AV Reading Level (dBμV) | Correction factors (dB/m) | AV Emission Level (dBμV/m) | AV Limit (dBμV/m) | Antenna polarization |
|-----------------|-------------------------|---------------------------|----------------------------|-------------------|----------------------|
| 4830.19 | / | -0.5 | / | 54 | Horizontal |
| 7236.58 | / | 3.4 | / | 54 | Horizontal |
| 9648.74 | / | 6.3 | / | 54 | Horizontal |
| 4830.19 | / | -0.5 | / | 54 | Vertical |
| 7236.58 | / | 3.4 | / | 54 | Vertical |
| 9648.74 | / | 6.3 | / | 54 | Vertical |

The field strength is calculated by adding the Antenna Factor, Cable Factor & Pre-amplifier. The basic equation with a sample calculation is as follows:

Final Test Level = Receiver Reading + Correction Factor

Correction Factor = Antenna Factor + Cable Loss – Pre-amplifier Factor.

Remark:

Harmonic Emissions was tested with filter (Product name: MICRO-TRONICS, model name: BRM50702), other radiated emissions were found below the reference noise level. When Peak emission level was below AV limit, the AV emission level was not recorded.

TEST REPORT

Band Edge test Restricted Bands

Horizontal

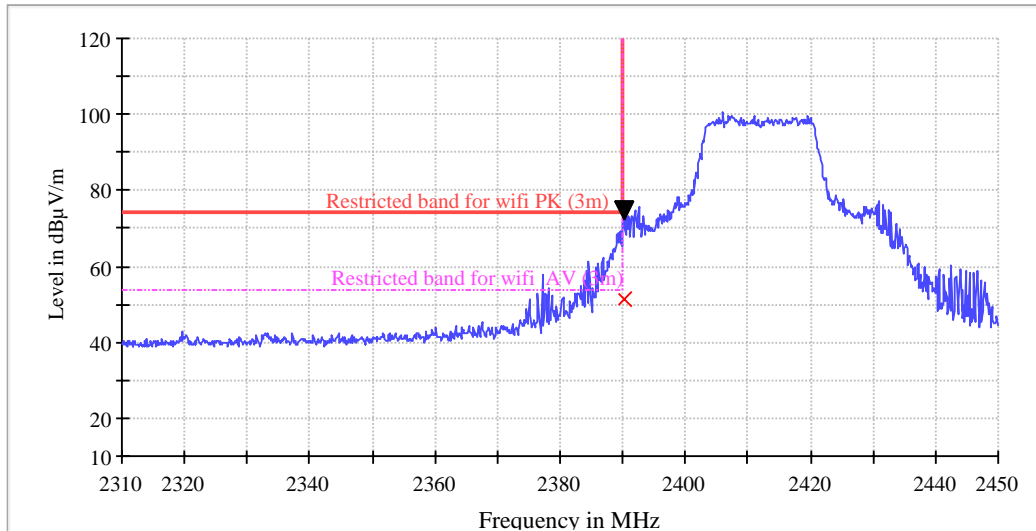

| Frequency (MHz) | PK Reading Level (dBµV) | Correction factors (dB/m) | PK Emission Level (dBµV/m) | Limit (dBµV/m) |
|-----------------|-------------------------|---------------------------|----------------------------|----------------|
| 2390.00 | 74.9 | -2.3 | 72.6 | 74.0 |

| Frequency (MHz) | AV Reading Level (dBµV) | Correction factors (dB/m) | AV Emission Level (dBµV/m) | Limit (dBµV/m) |
|-----------------|-------------------------|---------------------------|----------------------------|----------------|
| 2390.00 | 53.8 | -2.3 | 51.5 | 54.0 |

Remark:

Final Test Level =Receiver Reading + Correction Factor

Correction Factor = Antenna Factor + Cable Loss –Preamplifier Factor.

When Peak emission level was below AV limit, the AV emission level was not recorded.

TEST REPORT

Vertical

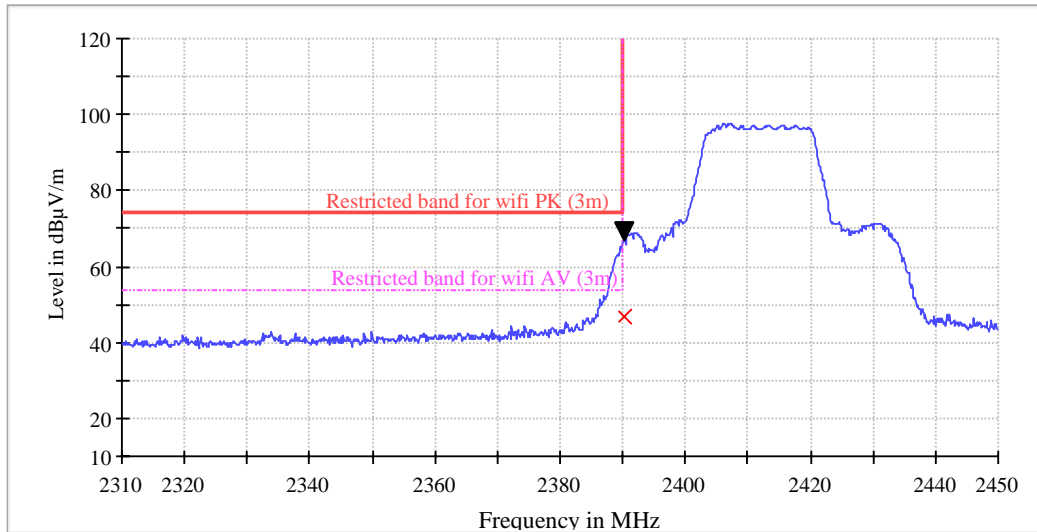

| Frequency (MHz) | PK Reading Level (dBµV) | Correction factors (dB/m) | PK Emission Level (dBµV/m) | Limit (dBµV/m) |
|-----------------|-------------------------|---------------------------|----------------------------|----------------|
| 2390.00 | 69.5 | -2.3 | 67.2 | 74.0 |

| Frequency (MHz) | AV Reading Level (dBµV) | Correction factors (dB/m) | AV Emission Level (dBµV/m) | Limit (dBµV/m) |
|-----------------|-------------------------|---------------------------|----------------------------|----------------|
| 2390.00 | 49.0 | -2.3 | 46.7 | 54.0 |

Remark:

Final Test Level = Receiver Reading + Correction Factor

Correction Factor = Antenna Factor + Cable Loss – Preamplifier Factor.

When Peak emission level was below AV limit, the AV emission level was not recorded.

TEST REPORT

Test at Channel 6 (2.437 GHz) in transmitting status
30 MHz~1 GHz Radiated Emissions.Quasi-Peak Measurement

Horizontal:

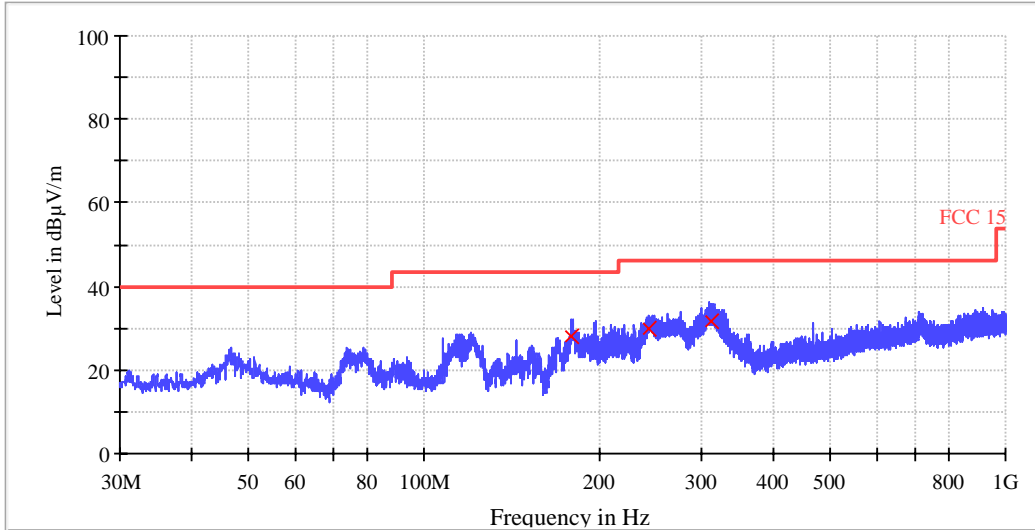

| Frequency (MHz) | Receiver Reading Level (dBµV) | Correction factors (dB/m) | Emission Level (dBµV/m) | Limit (dBµV/m) |
|-----------------|-------------------------------|---------------------------|-------------------------|----------------|
| 179.64 | 16.9 | 11.2 | 28.1 | 43.5 |
| 243.24 | 15.7 | 14.2 | 29.9 | 46.0 |
| 311.28 | 15.6 | 16.1 | 31.7 | 46.0 |

TEST REPORT

Vertical:

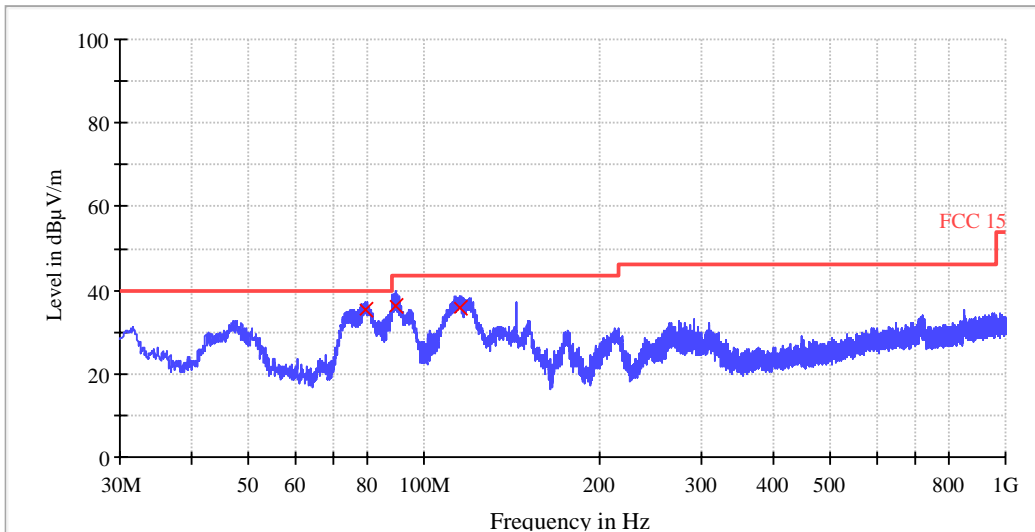

| Frequency (MHz) | Receiver Reading Level (dBµV) | Correction factors (dB/m) | Emission Level (dBµV/m) | Limit (dBµV/m) |
|-----------------|-------------------------------|---------------------------|-------------------------|----------------|
| 79.04 | 25.3 | 9.9 | 35.2 | 40.0 |
| 89.20 | 25.3 | 11.1 | 36.4 | 43.5 |
| 115.28 | 24.3 | 11.6 | 35.9 | 43.5 |

Remark:

1. Corr. (dB) = Antenna Factor (dB) + Cable Loss (dB)
2. Quasi Peak (dBµV/m) = Corr. (dB) + Read Level (dBµV)
3. Margin (dB) = Limit QPK (dBµV/m) – Quasi Peak (dBµV/m)

TEST REPORT

1~25 GHz Radiated Emissions. Peak & Average Measurement

PK Measurement:

| Frequency (MHz) | PK Reading Level (dBμV) | Correction factors (dB/m) | PK Emission Level (dBμV/m) | PK Limit (dBμV/m) | Antenna polarization |
|-----------------|-------------------------|---------------------------|----------------------------|-------------------|----------------------|
| 4874.74 | 48.1 | -0.5 | 47.6 | 74 | Horizontal |
| 7352.63 | 42.4 | 3.8 | 46.2 | 74 | Horizontal |
| 9749.82 | 39.7 | 6.8 | 46.5 | 74 | Horizontal |
| 4874.74 | 47.8 | -0.5 | 47.3 | 74 | Vertical |
| 7352.63 | 42.1 | 3.8 | 45.9 | 74 | Vertical |
| 9749.82 | 39.5 | 6.8 | 46.3 | 74 | Vertical |

AV Measurement:

| Frequency (MHz) | AV Reading Level (dBμV) | Correction factors (dB/m) | AV Emission Level (dBμV/m) | AV Limit (dBμV/m) | Antenna polarization |
|-----------------|-------------------------|---------------------------|----------------------------|-------------------|----------------------|
| 4874.74 | / | -0.5 | / | 54 | Horizontal |
| 7352.63 | / | 3.8 | / | 54 | Horizontal |
| 9749.82 | / | 6.8 | / | 54 | Horizontal |
| 4874.74 | / | -0.5 | / | 54 | Vertical |
| 7352.63 | / | 3.8 | / | 54 | Vertical |
| 9749.82 | / | 6.8 | / | 54 | Vertical |

The field strength is calculated by adding the Antenna Factor, Cable Factor & Preamplifier. The basic equation with a sample calculation is as follows:

Final Test Level = Receiver Reading + Correction Factor

Correction Factor = Antenna Factor + Cable Loss – Preamplifier Factor.

Remark:

Harmonic Emissions was tested with filter (Product name: MICRO-TRONICS, model name: BRM50702), other radiated emissions were found below the reference noise level. When Peak emission level was below AV limit, the AV emission level was not recorded.

TEST REPORT

Test at Channel 11 (2.462 GHz) in transmitting status
30 MHz~1 GHz Radiated Emissions .Quasi-Peak Measurement

Horizontal:

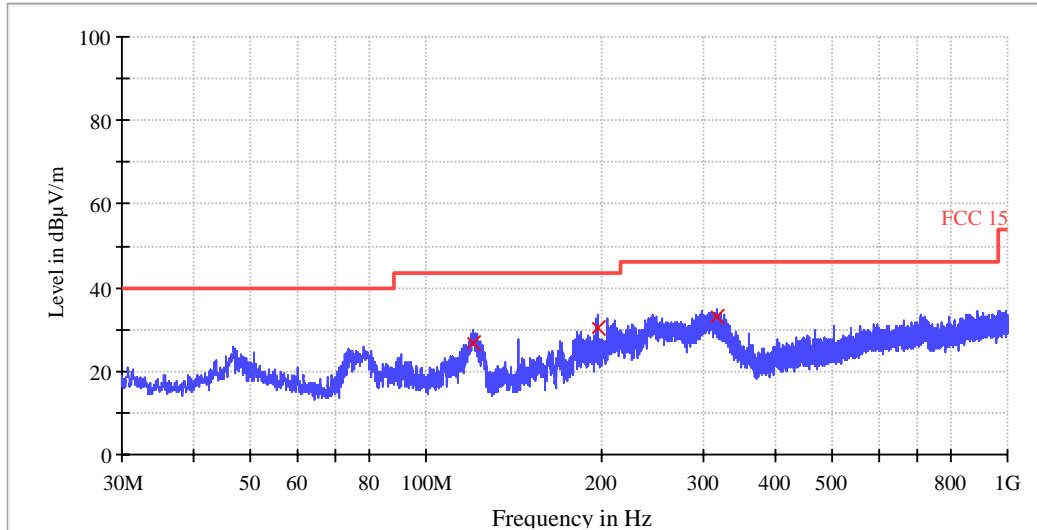

| Frequency (MHz) | Receiver Reading Level (dBµV) | Correction factors (dB/m) | Emission Level (dBµV/m) | Limit (dBµV/m) |
|-----------------|-------------------------------|---------------------------|-------------------------|----------------|
| 120.16 | 15.8 | 11.0 | 26.8 | 43.5 |
| 196.92 | 17.7 | 12.6 | 30.3 | 43.5 |
| 317.16 | 16.8 | 16.2 | 33.0 | 46.0 |

Remark:

1. Corr. (dB) = Antenna Factor (dB) + Cable Loss (dB)
2. Quasi Peak (dBµV/m) = Corr. (dB) + Read Level (dBµV)
3. Margin (dB) = Limit QPK (dBµV/m) –Quasi Peak (dBµV/m)

TEST REPORT

Vertical:

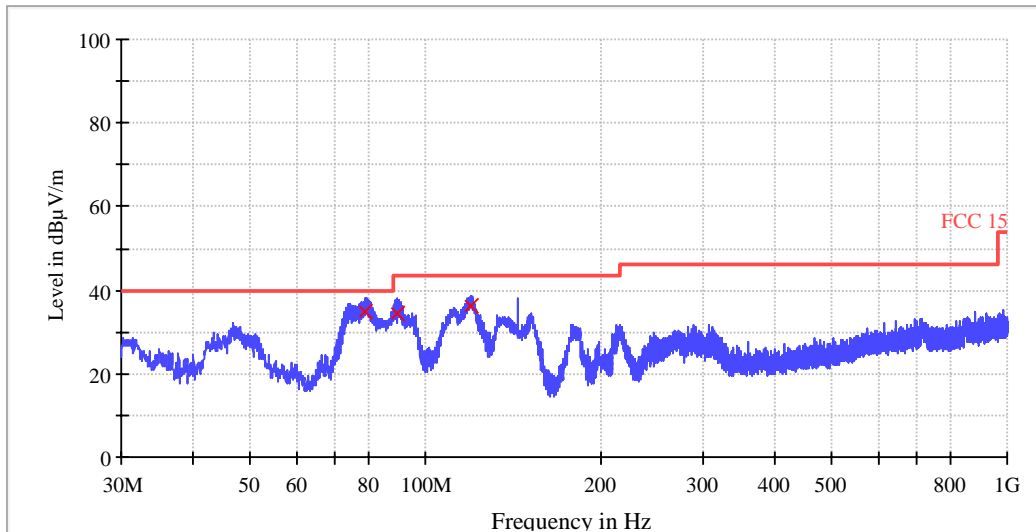

| Frequency (MHz) | Receiver Reading Level (dBµV) | Correction factors (dB/m) | Emission Level (dBµV/m) | Limit (dBµV/m) |
|-----------------|-------------------------------|---------------------------|-------------------------|----------------|
| 78.96 | 25.1 | 9.9 | 35.0 | 40.0 |
| 89.28 | 23.4 | 11.1 | 34.5 | 43.5 |
| 119.56 | 25.2 | 11.1 | 36.3 | 43.5 |

Remark:

1. Corr. (dB) = Antenna Factor (dB) + Cable Loss (dB)
2. Quasi Peak (dBµV/m) = Corr. (dB) + Read Level (dBµV)
3. Margin (dB) = Limit QPK (dBµV/m) – Quasi Peak (dBµV/m)

TEST REPORT

1~25 GHz Radiated Emissions. Peak & Average Measurement

PK Measurement:

| Frequency (MHz) | PK Reading Level (dBμV) | Correction factors (dB/m) | PK Emission Level (dBμV/m) | PK Limit (dBμV/m) | Antenna polarization |
|-----------------|-------------------------|---------------------------|----------------------------|-------------------|----------------------|
| 4923.56 | 47.3 | -0.5 | 46.8 | 74 | Horizontal |
| 7381.74 | 42.1 | 4.2 | 46.3 | 74 | Horizontal |
| 9850.38 | 39.8 | 7.3 | 47.1 | 74 | Horizontal |
| 4923.56 | 46.4 | -0.5 | 45.9 | 74 | Vertical |
| 7381.74 | 42.0 | 4.2 | 46.2 | 74 | Vertical |
| 9850.38 | 39.6 | 7.3 | 46.9 | 74 | Vertical |

AV Measurement:

| Frequency (MHz) | AV Reading Level (dBμV) | Correction factors (dB/m) | AV Emission Level (dBμV/m) | AV Limit (dBμV/m) | Antenna polarization |
|-----------------|-------------------------|---------------------------|----------------------------|-------------------|----------------------|
| 4923.56 | / | -0.5 | / | 54 | Horizontal |
| 7381.74 | / | 4.2 | / | 54 | Horizontal |
| 9850.38 | / | 7.3 | / | 54 | Horizontal |
| 4923.56 | / | -0.5 | / | 54 | Vertical |
| 7381.74 | / | 4.2 | / | 54 | Vertical |
| 9850.38 | / | 7.3 | / | 54 | Vertical |

The field strength is calculated by adding the Antenna Factor, Cable Factor & Pre-amplifier. The basic equation with a sample calculation is as follows:

Final Test Level = Receiver Reading + Correction Factor

Correction Factor = Antenna Factor + Cable Loss – Pre-amplifier Factor.

Remark:

Harmonic Emissions was tested with filter (Product name: MICRO-TRONICS, model name: BRM50702), other radiated emissions were found below the reference noise level. When Peak emission level was below AV limit, the AV emission level was not recorded.

TEST REPORT

Band Edge test Restricted Bands
Horizontal

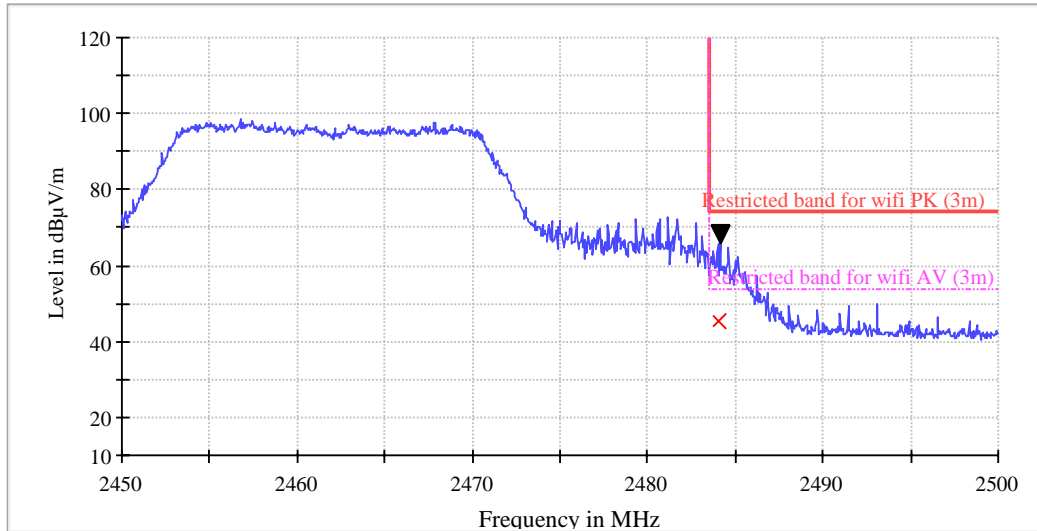

| Frequency (MHz) | PK Reading Level (dBµV) | Correction factors (dB/m) | PK Emission Level (dBµV/m) | Limit (dBµV/m) |
|-----------------|-------------------------|---------------------------|----------------------------|----------------|
| 2484.15 | 68.5 | -2.1 | 66.4 | 74.0 |

| Frequency (MHz) | AV Reading Level (dBµV) | Correction factors (dB/m) | AV Emission Level (dBµV/m) | Limit (dBµV/m) |
|-----------------|-------------------------|---------------------------|----------------------------|----------------|
| 2484.16 | 47.3 | -2.1 | 45.2 | 54.0 |

Remark:

Final Test Level = Receiver Reading + Correction Factor

Correction Factor = Antenna Factor + Cable Loss – Preamplifier Factor.

When Peak emission level was below AV limit, the AV emission level was not recorded.

TEST REPORT

Vertical

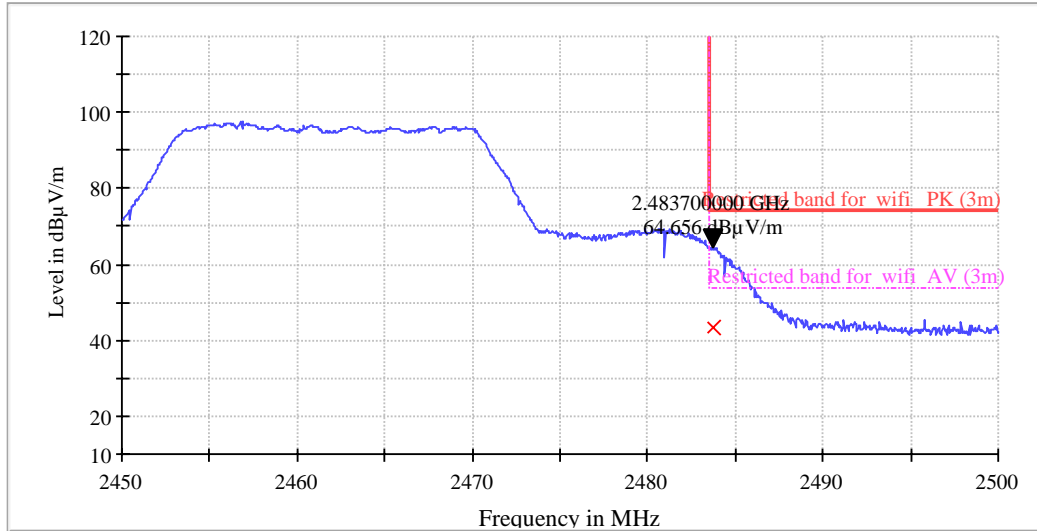

| Frequency (MHz) | PK Reading Level (dBµV) | Correction factors (dB/m) | PK Emission Level (dBµV/m) | Limit (dBµV/m) |
|-----------------|-------------------------|---------------------------|----------------------------|----------------|
| 2483.70 | 66.8 | -2.1 | 64.7 | 74.0 |

| Frequency (MHz) | AV Reading Level (dBµV) | Correction factors (dB/m) | AV Emission Level (dBµV/m) | Limit (dBµV/m) |
|-----------------|-------------------------|---------------------------|----------------------------|----------------|
| 2483.33 | 45.5 | -2.1 | 43.4 | 54.0 |

Remark:

Final Test Level = Receiver Reading + Correction Factor

Correction Factor = Antenna Factor + Cable Loss – Preamplifier Factor.

When Peak emission level was below AV limit, the AV emission level was not recorded.

TEST REPORT

802.11n (HT40) mode with 13.5Mbps data rate
9 kHz~30 MHz Field Strength of Unwanted Emissions. Quasi-Peak Measurement
The measurements with active loop antenna were greater than 20dB below the limit, so the test data were not recorded in the test report.

Test at Channel 3 (2.422 GHz) in transmitting status
30 MHz~1 GHz Spurious Emissions .Quasi-Peak Measurement
Horizontal:

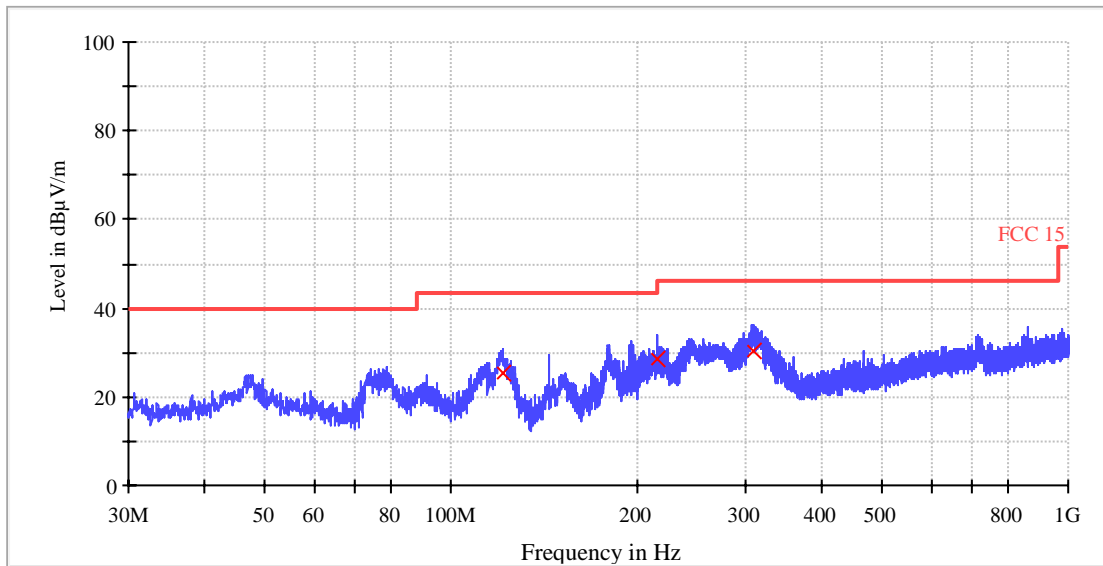

| Frequency (MHz) | Receiver Reading Level (dBµV) | Correction factors (dB/m) | Emission Level (dBµV/m) | Limit (dBµV/m) |
|-----------------|-------------------------------|---------------------------|-------------------------|----------------|
| 121.12 | 14.6 | 10.9 | 25.5 | 43.5 |
| 215.96 | 15.2 | 13.3 | 28.5 | 43.5 |
| 308.44 | 14.4 | 16.1 | 30.5 | 46.0 |

Remark:

1. Corr. (dB) = Antenna Factor (dB) + Cable Loss (dB)
2. Quasi Peak (dBµV/m) = Corr. (dB) + Read Level (dBµV)
3. Margin (dB) = Limit QPK (dBµV/m) –Quasi Peak (dBµV/m)

TEST REPORT

Vertical:

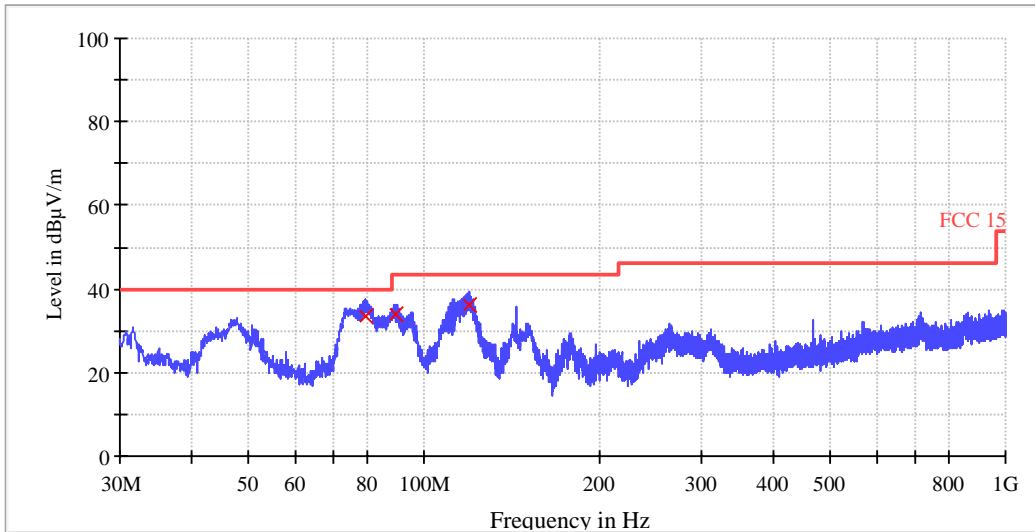

| Frequency (MHz) | Receiver Reading Level (dBµV) | Correction factors (dB/m) | Emission Level (dBµV/m) | Limit (dBµV/m) |
|-----------------|-------------------------------|---------------------------|-------------------------|----------------|
| 79.24 | 23.8 | 9.8 | 33.6 | 40.0 |
| 89.04 | 23.1 | 11.0 | 34.1 | 43.5 |
| 119.84 | 25.0 | 11.0 | 36.0 | 43.5 |

Remark:

1. Corr. (dB) = Antenna Factor (dB) + Cable Loss (dB)
2. Quasi Peak (dBµV/m) = Corr. (dB) + Read Level (dBµV)
3. Margin (dB) = Limit QPK (dBµV/m) – Quasi Peak (dBµV/m)

TEST REPORT

1~25 GHz Radiated Emissions.

PK Measurement:

| Frequency (MHz) | PK Reading Level (dBμV) | Correction factors (dB/m) | PK Emission Level (dBμV/m) | PK Limit (dBμV/m) | Antenna polarization |
|-----------------|-------------------------|---------------------------|----------------------------|-------------------|----------------------|
| 4838.74 | 47.6 | -0.5 | 47.1 | 74 | Horizontal |
| 7257.53 | 43.4 | 3.4 | 46.8 | 74 | Horizontal |
| 9654.62 | 40.9 | 6.3 | 47.2 | 74 | Horizontal |
| 4838.74 | 47.8 | -0.5 | 47.3 | 74 | Vertical |
| 7257.53 | 44.2 | 3.4 | 47.6 | 74 | Vertical |
| 9654.62 | 40.1 | 6.3 | 46.4 | 74 | Vertical |

AV Measurement:

| Frequency (MHz) | AV Reading Level (dBμV) | Correction factors (dB/m) | AV Emission Level (dBμV/m) | AV Limit (dBμV/m) | Antenna polarization |
|-----------------|-------------------------|---------------------------|----------------------------|-------------------|----------------------|
| 4838.74 | / | -0.5 | / | 54 | Horizontal |
| 7257.53 | / | 3.4 | / | 54 | Horizontal |
| 9654.62 | / | 6.3 | / | 54 | Horizontal |
| 4838.74 | / | -0.5 | / | 54 | Vertical |
| 7257.53 | / | 3.4 | / | 54 | Vertical |
| 9654.62 | / | 6.3 | / | 54 | Vertical |

The field strength is calculated by adding the Antenna Factor, Cable Factor & Pre-amplifier. The basic equation with a sample calculation is as follows:

Final Test Level = Receiver Reading + Correction Factor

Correction Factor = Antenna Factor + Cable Loss – Pre-amplifier Factor.

Remark:

Harmonic Emissions was tested with filter (Product name: MICRO-TRONICS, model name: BRM50702), other radiated emissions were found below the reference noise level. When Peak emission level was below AV limit, the AV emission level was not recorded.

TEST REPORT

Band Edge test Restricted Bands

Horizontal

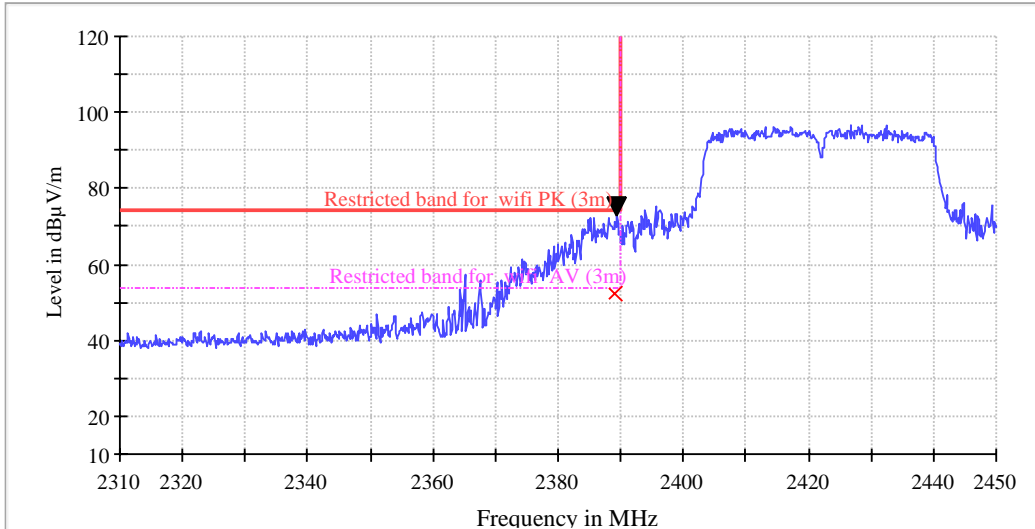

| Frequency (MHz) | PK Reading Level (dBµV) | Correction factors (dB/m) | PK Emission Level (dBµV/m) | Limit (dBµV/m) |
|-----------------|-------------------------|---------------------------|----------------------------|----------------|
| 2389.38 | 75.4 | -2.3 | 73.1 | 74.0 |

| Frequency (MHz) | AV Reading Level (dBµV) | Correction factors (dB/m) | AV Emission Level (dBµV/m) | Limit (dBµV/m) |
|-----------------|-------------------------|---------------------------|----------------------------|----------------|
| 2389.33 | 54.5 | -2.3 | 52.2 | 54.0 |

Remark:

Final Test Level = Receiver Reading + Correction Factor

Correction Factor = Antenna Factor + Cable Loss – Preamplifier Factor.

When Peak emission level was below AV limit, the AV emission level was not recorded.

TEST REPORT

Vertical

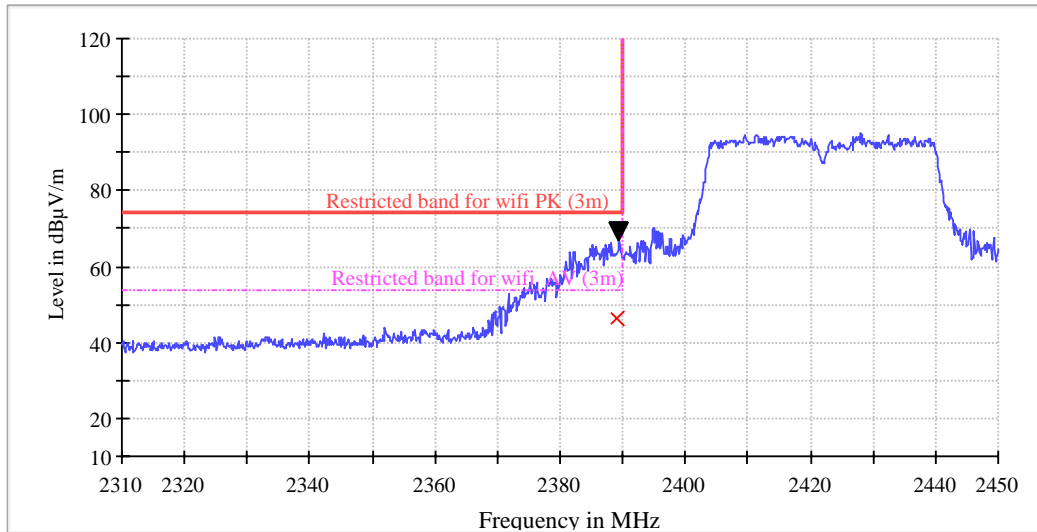

| Frequency (MHz) | PK Reading Level (dBµV) | Correction factors (dB/m) | PK Emission Level (dBµV/m) | Limit (dBµV/m) |
|-----------------|-------------------------|---------------------------|----------------------------|----------------|
| 2389.38 | 69.4 | -2.3 | 67.1 | 74.0 |

| Frequency (MHz) | AV Reading Level (dBµV) | Correction factors (dB/m) | AV Emission Level (dBµV/m) | Limit (dBµV/m) |
|-----------------|-------------------------|---------------------------|----------------------------|----------------|
| 2389.38 | 48.9 | -2.3 | 46.6 | 54.0 |

Remark:

Final Test Level = Receiver Reading + Correction Factor

Correction Factor = Antenna Factor + Cable Loss – Preamplifier Factor.

When Peak emission level was below AV limit, the AV emission level was not recorded.

TEST REPORT

Test at Channel 6 (2.437 GHz) in transmitting status
30 MHz~1 GHz Radiated Emissions.Quasi-Peak Measurement

Horizontal:

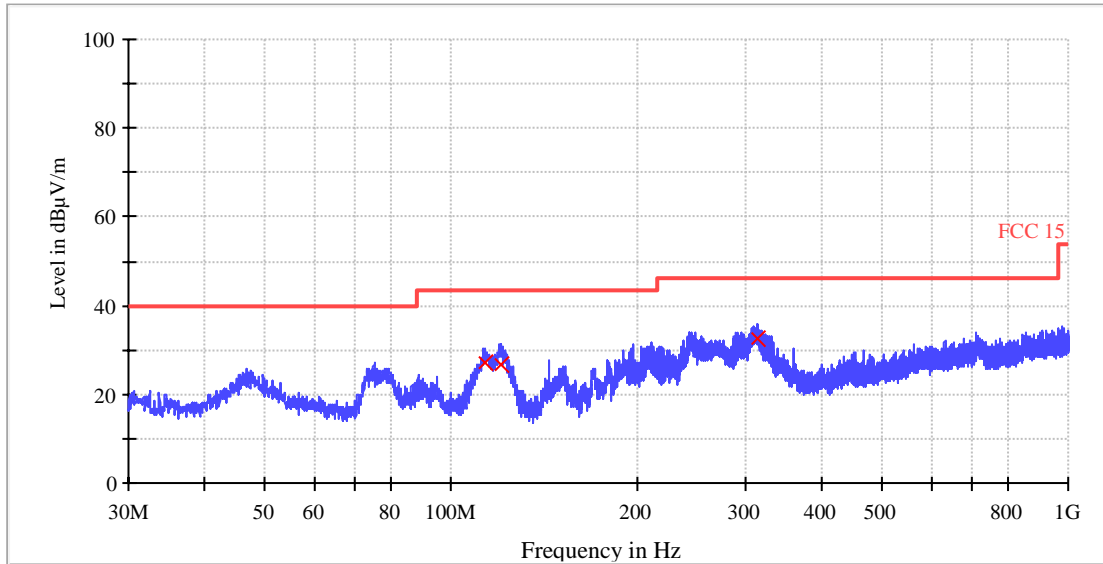

| Frequency (MHz) | Receiver Reading Level (dBµV) | Correction factors (dB/m) | Emission Level (dBµV/m) | Limit (dBµV/m) |
|-----------------|-------------------------------|---------------------------|-------------------------|----------------|
| 113.72 | 15.7 | 11.7 | 27.4 | 43.5 |
| 120.92 | 16.0 | 10.9 | 26.9 | 43.5 |
| 313.68 | 16.4 | 16.2 | 32.6 | 46.0 |

TEST REPORT

Vertical:

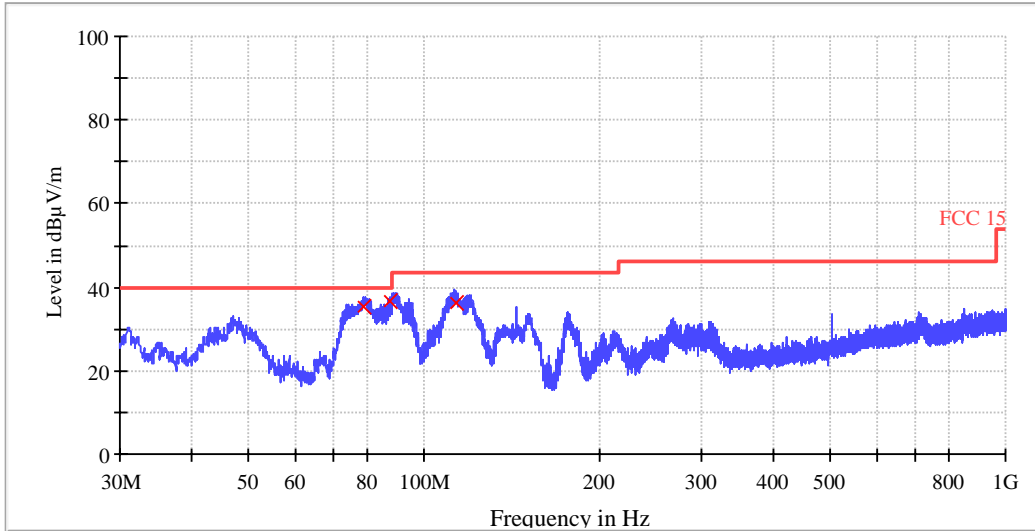

| Frequency (MHz) | Receiver Reading Level (dBµV) | Correction factors (dB/m) | Emission Level (dBµV/m) | Limit (dBµV/m) |
|-----------------|-------------------------------|---------------------------|-------------------------|----------------|
| 78.96 | 25.4 | 9.9 | 35.3 | 40.0 |
| 87.44 | 25.9 | 10.8 | 36.7 | 40.0 |
| 113.24 | 24.6 | 11.8 | 36.4 | 43.5 |

Remark:

1. Corr. (dB) = Antenna Factor (dB) + Cable Loss (dB)
2. Quasi Peak (dBµV/m) = Corr. (dB) + Read Level (dBµV)
3. Margin (dB) = Limit QPK (dBµV/m) – Quasi Peak (dBµV/m)

TEST REPORT

1~25 GHz Radiated Emissions. Peak & Average Measurement

PK Measurement:

| Frequency (MHz) | PK Reading Level (dBμV) | Correction factors (dB/m) | PK Emission Level (dBμV/m) | PK Limit (dBμV/m) | Antenna polarization |
|-----------------|-------------------------|---------------------------|----------------------------|-------------------|----------------------|
| 4876.12 | 47.0 | -0.5 | 46.5 | 74 | Horizontal |
| 7353.35 | 43.3 | 3.8 | 47.1 | 74 | Horizontal |
| 9749.47 | 40.6 | 6.8 | 47.4 | 74 | Horizontal |
| 4876.12 | 46.8 | -0.5 | 46.3 | 74 | Vertical |
| 7353.35 | 43 | 3.8 | 46.8 | 74 | Vertical |
| 9749.47 | 40.2 | 6.8 | 47.0 | 74 | Vertical |

AV Measurement:

| Frequency (MHz) | AV Reading Level (dBμV) | Correction factors (dB/m) | AV Emission Level (dBμV/m) | AV Limit (dBμV/m) | Antenna polarization |
|-----------------|-------------------------|---------------------------|----------------------------|-------------------|----------------------|
| 4876.12 | / | -0.5 | / | 54 | Horizontal |
| 7353.35 | / | 3.8 | / | 54 | Horizontal |
| 9749.47 | / | 6.8 | / | 54 | Horizontal |
| 4876.12 | / | -0.5 | / | 54 | Vertical |
| 7353.35 | / | 3.8 | / | 54 | Vertical |
| 9749.47 | / | 6.8 | / | 54 | Vertical |

The field strength is calculated by adding the Antenna Factor, Cable Factor & Preamplifier. The basic equation with a sample calculation is as follows:

Final Test Level = Receiver Reading + Correction Factor

Correction Factor = Antenna Factor + Cable Loss – Preamplifier Factor.

Remark:

Harmonic Emissions was tested with filter (Product name: MICRO-TRONICS, model name: BRM50702), other radiated emissions were found below the reference noise level. When Peak emission level was below AV limit, the AV emission level was not recorded.

TEST REPORT

Test at Channel 7 (2.452 GHz) in transmitting status
30 MHz~1 GHz Radiated Emissions.Quasi-Peak Measurement

Horizontal:

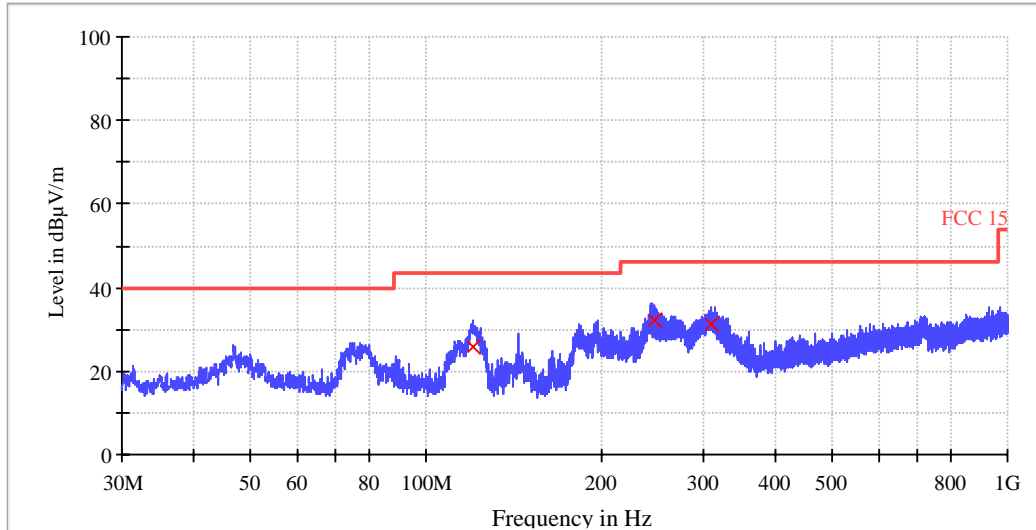

| Frequency (MHz) | Receiver Reading Level (dBµV) | Correction factors (dB/m) | Emission Level (dBµV/m) | Limit (dBµV/m) |
|-----------------|-------------------------------|---------------------------|-------------------------|----------------|
| 120.76 | 15.0 | 10.9 | 25.9 | 43.5 |
| 246.16 | 17.8 | 14.3 | 32.1 | 46.0 |
| 309.00 | 15.1 | 16.1 | 31.2 | 46.0 |

Remark:

1. Corr. (dB) = Antenna Factor (dB) + Cable Loss (dB)
2. Quasi Peak (dBµV/m) = Corr. (dB) + Read Level (dBµV)
3. Margin (dB) = Limit QPK (dBµV/m) –Quasi Peak (dBµV/m)

TEST REPORT

Vertical:

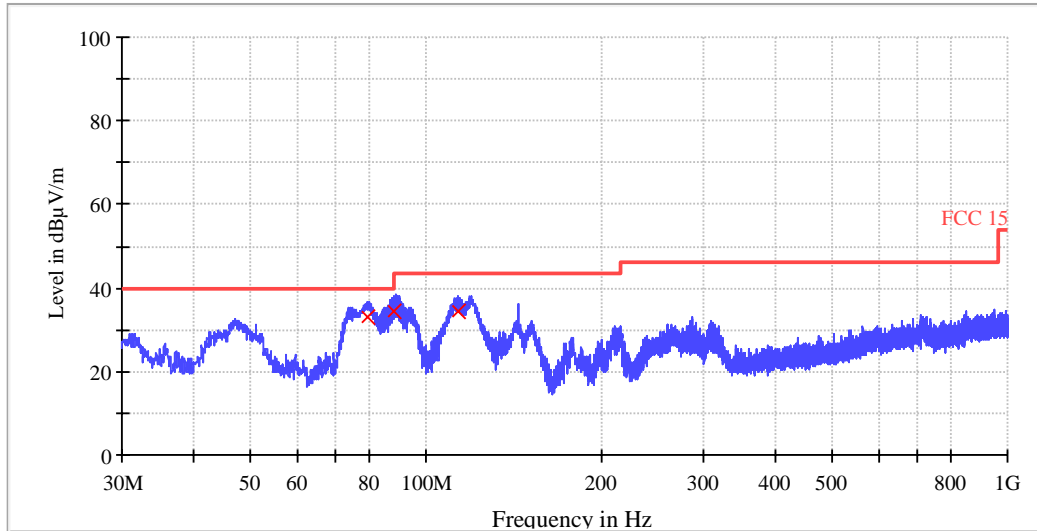

| Frequency (MHz) | Receiver Reading Level (dBµV) | Correction factors (dB/m) | Emission Level (dBµV/m) | Limit (dBµV/m) |
|-----------------|-------------------------------|---------------------------|-------------------------|----------------|
| 79.36 | 23.3 | 9.8 | 33.1 | 40.0 |
| 87.88 | 23.6 | 10.9 | 34.5 | 40.0 |
| 113.12 | 22.7 | 11.8 | 34.5 | 43.5 |

Remark:

1. Corr. (dB) = Antenna Factor (dB) + Cable Loss (dB)
2. Quasi Peak (dBµV/m) = Corr. (dB) + Read Level (dBµV)
3. Margin (dB) = Limit QPK (dBµV/m) – Quasi Peak (dBµV/m)

TEST REPORT

1~25 GHz Radiated Emissions. Peak & Average Measurement

PK Measurement:

| Frequency (MHz) | PK Reading Level (dBμV) | Correction factors (dB/m) | PK Emission Level (dBμV/m) | PK Limit (dBμV/m) | Antenna polarization |
|-----------------|-------------------------|---------------------------|----------------------------|-------------------|----------------------|
| 4906.84 | 47.3 | -0.5 | 46.8 | 74 | Horizontal |
| 7354.73 | 41.7 | 4.2 | 45.9 | 74 | Horizontal |
| 9808.62 | 38.9 | 7.3 | 46.2 | 74 | Horizontal |
| 4906.84 | 45.6 | -0.5 | 45.1 | 74 | Vertical |
| 7354.73 | 42.7 | 4.2 | 46.9 | 74 | Vertical |
| 9808.62 | 39.4 | 7.3 | 46.7 | 74 | Vertical |

AV Measurement:

| Frequency (MHz) | AV Reading Level (dBμV) | Correction factors (dB/m) | AV Emission Level (dBμV/m) | AV Limit (dBμV/m) | Antenna polarization |
|-----------------|-------------------------|---------------------------|----------------------------|-------------------|----------------------|
| 4906.84 | / | -0.5 | / | 54 | Horizontal |
| 7354.73 | / | 4.2 | / | 54 | Horizontal |
| 9808.62 | / | 7.3 | / | 54 | Horizontal |
| 4906.84 | / | -0.5 | / | 54 | Vertical |
| 7354.73 | / | 4.2 | / | 54 | Vertical |
| 9808.62 | / | 7.3 | / | 54 | Vertical |

The field strength is calculated by adding the Antenna Factor, Cable Factor & Preamplifier. The basic equation with a sample calculation is as follows:

Final Test Level = Receiver Reading + Correction Factor

Correction Factor = Antenna Factor + Cable Loss – Preamplifier Factor.

Remark:

Harmonic Emissions was tested with filter (Product name: MICRO-TRONICS, model name: BRM50702), other radiated emissions were found below the reference noise level. When Peak emission level was below AV limit, the AV emission level was not recorded.

TEST REPORT

Band Edge test Restricted Bands
Horizontal

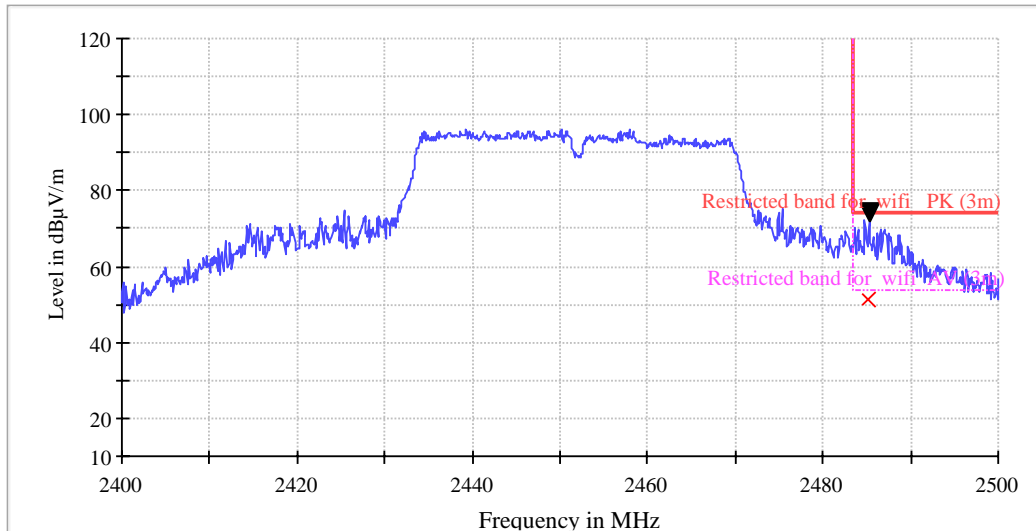

| Frequency (MHz) | PK Reading Level (dBµV) | Correction factors (dB/m) | PK Emission Level (dBµV/m) | Limit (dBµV/m) |
|-----------------|-------------------------|---------------------------|----------------------------|----------------|
| 2485.30 | 74.4 | -2.1 | 72.3 | 74.0 |

| Frequency (MHz) | AV Reading Level (dBµV) | Correction factors (dB/m) | AV Emission Level (dBµV/m) | Limit (dBµV/m) |
|-----------------|-------------------------|---------------------------|----------------------------|----------------|
| 2485.30 | 53.3 | -2.1 | 51.2 | 54.0 |

Remark:

Final Test Level = Receiver Reading + Correction Factor

Correction Factor = Antenna Factor + Cable Loss - Preamplifier Factor.

When Peak emission level was below AV limit, the AV emission level was not recorded.

TEST REPORT

Vertical

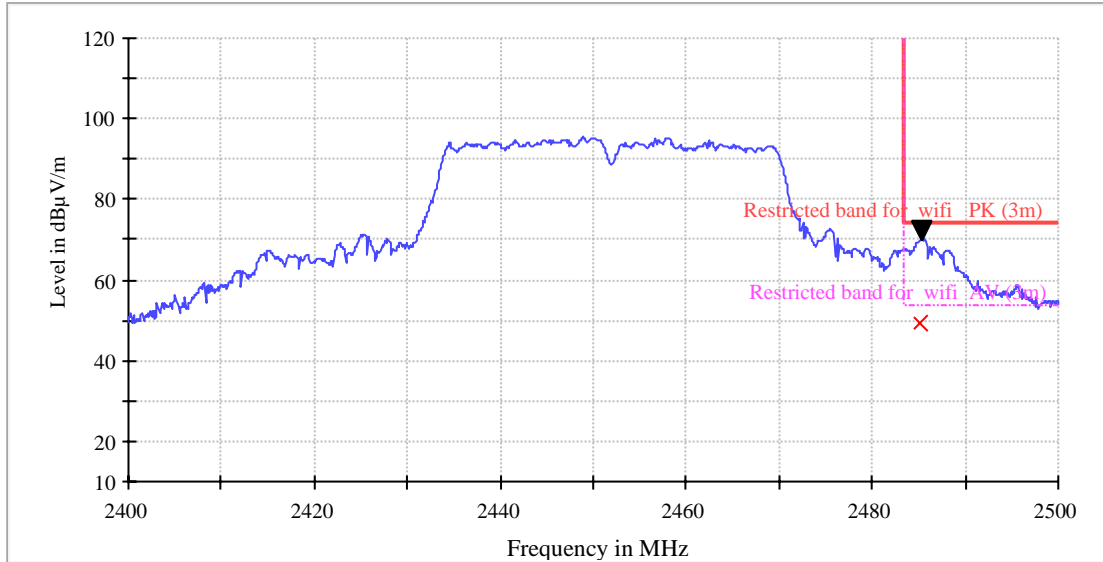

| Frequency (MHz) | PK Reading Level (dBµV) | Correction factors (dB/m) | PK Emission Level (dBµV/m) | Limit (dBµV/m) |
|-----------------|-------------------------|---------------------------|----------------------------|----------------|
| 2485.40 | 72.2 | -2.1 | 70.1 | 74.0 |

| Frequency (MHz) | AV Reading Level (dBµV) | Correction factors (dB/m) | AV Emission Level (dBµV/m) | Limit (dBµV/m) |
|-----------------|-------------------------|---------------------------|----------------------------|----------------|
| 2485.40 | 51.5 | -2.1 | 49.4 | 54.0 |

Remark:

Final Test Level = Receiver Reading + Correction Factor

Correction Factor = Antenna Factor + Cable Loss – Preamplifier Factor.

When Peak emission level was below AV limit, the AV emission level was not recorded.

TEST REPORT

4.8 Band Edges Requirement

| | |
|---------------------|---|
| Test Requirement: | FCC Part 15 C section 15.247 (d) In any 100 kHz bandwidth outside the frequency band in which the spread spectrum or digitally modulated intentional radiator is operating. The radio frequency power that is produced by the intentional radiator shall be at least 20 dB below that in the 100 kHz bandwidth within the band that contains the highest level of the desired power. Based on either an RF conducted or a radiated measurement. Provided the transmitter demonstrates compliance with the peak conducted power limits. |
| Frequency Band: | 2400 MHz to 2483.5 MHz |
| Test Method: | ANSI C63.10: Clause 11.11 and 11.13 |
| Test Status: | Pre-Scan has been conducted to determine the worst-case mode from all possible combinations between available modulations, data rates and antenna ports (if EUT with antenna diversity architecture). Following channel(s) was (were) selected for the final test as listed below. |
| Test Configuration: | For Band Edges Emission in Radiated mode, Please refer to clause 4.7 |

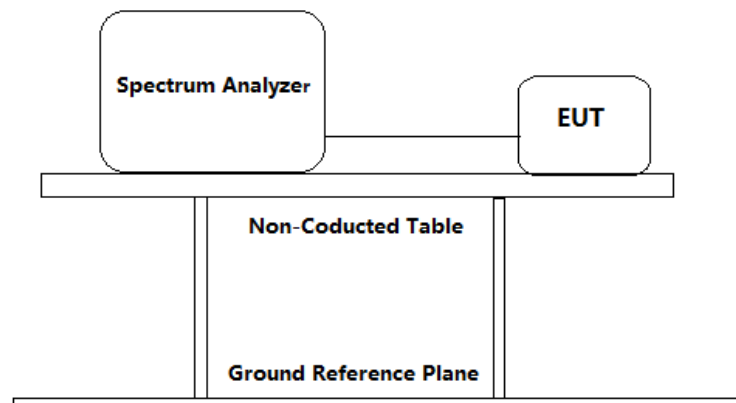

Test Procedure: For Band Edges Emission in Radiated mode, Please refer to clause 4.7

1. Remove the antenna from the EUT and then connect a low RF cable from the antenna port to the spectrum analyzer.
 - a) Set instrument center frequency to the frequency of the emission to be measured (must be within 2 MHz of the authorized band edge).
 - b) Set the center frequency and span to encompass frequency range to be measured.
 - c) RBW = 100 kHz.
 - d) VBW \geq [3 \times RBW].
 - e) Detector = peak.
 - f) Sweep time = auto.

TEST REPORT

- g) Trace mode = max hold.
 - h) Allow sweep to continue until the trace stabilizes (required measurement time may increase for low-duty-cycle applications).
 - i) For radiated Band-edge emissions within a restricted band and within 2 MHz of an authorized band edge, integration method is considered.
2. Repeat until all the test status is investigated.
 3. Report the worst case.

Used Test Equipment List:

3m Semi-Anechoic Chamber, EMI Test Receiver (9 kHz~7 GHz), Signal and Spectrum Analyzer (10 Hz~40 GHz), Loop antenna (9 kHz-30 MHz). TRILOG Super Broadband test Antenna(30 MHz-3 GHz) (RX), Double-Ridged Waveguide Horn Antenna (800 MHz-18 GHz)(RX) and High Frequency Antenna & preamplifier(18 GHz~26.5 GHz) (RX). Refer to Clause 5 Test Equipment List for details.

Test result with plots as follows:

For conduct mode:

The band edges was measured and recorded Result:

The Lower Edges attenuated more than 20dB.

The Upper Edges attenuated more than 20dB.

TEST REPORT

Result plots as follows:
802.11b mode with 1 Mbps data rate
Channel1: 2.412 GHz

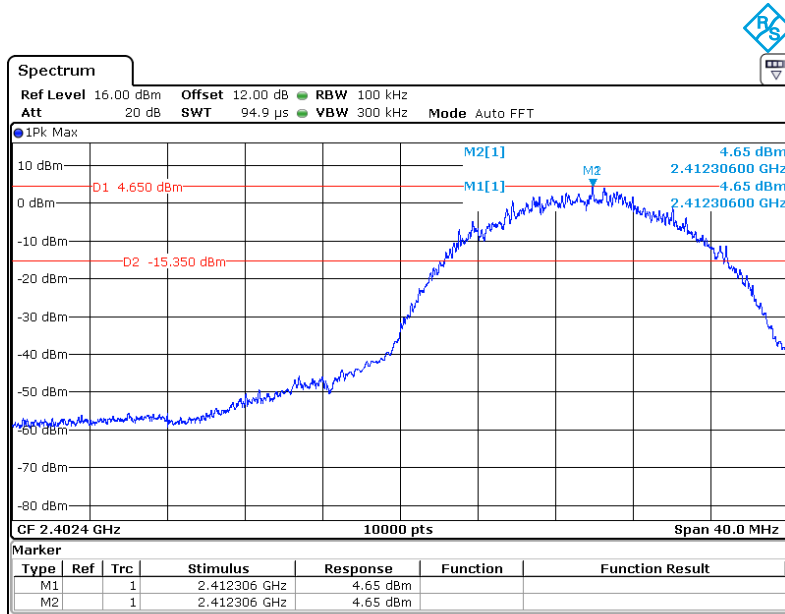

Channel 11: 2.462 GHz

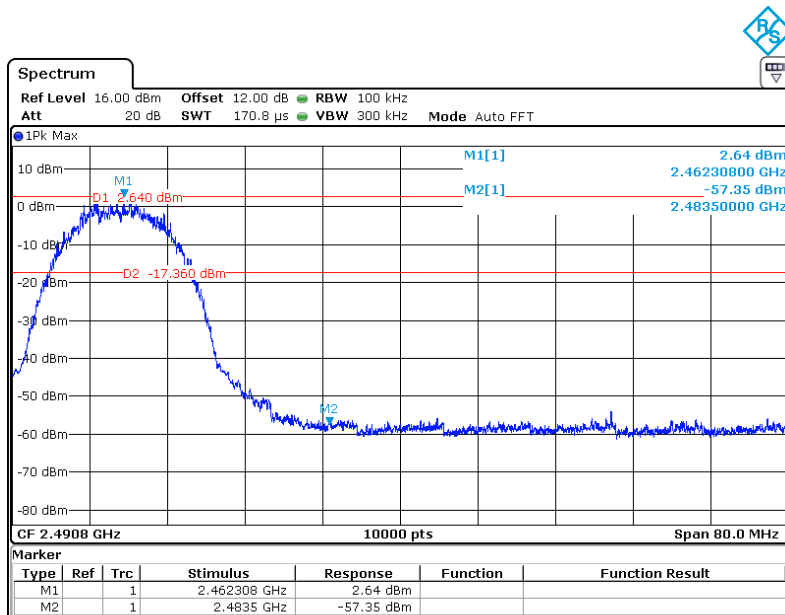

TEST REPORT

802.11g mode with 6 Mbps data rate

Channel1: 2.412 GHz

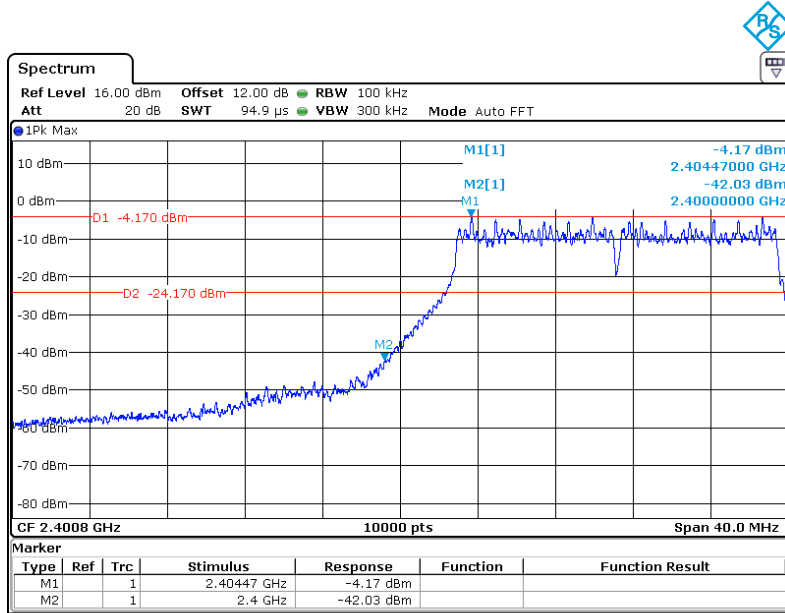

Channel 11: 2.462 GHz

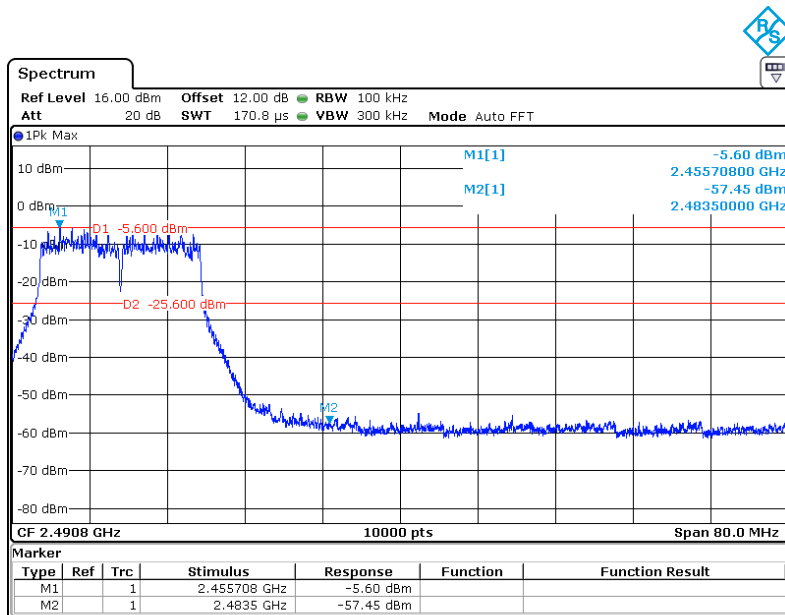

TEST REPORT

802.11n(HT20) mode with 6.5Mbps data rate

Channel 1: 2.412 GHz

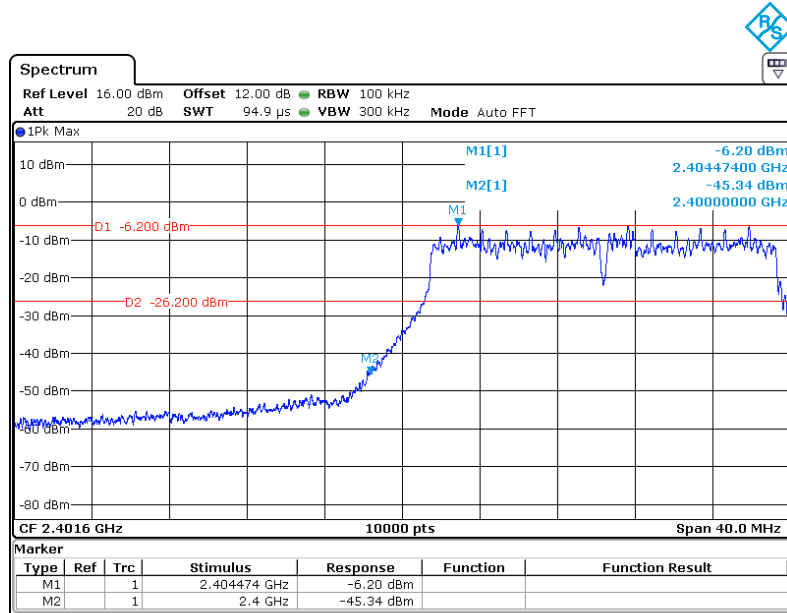

Channel 11: 2.462 GHz

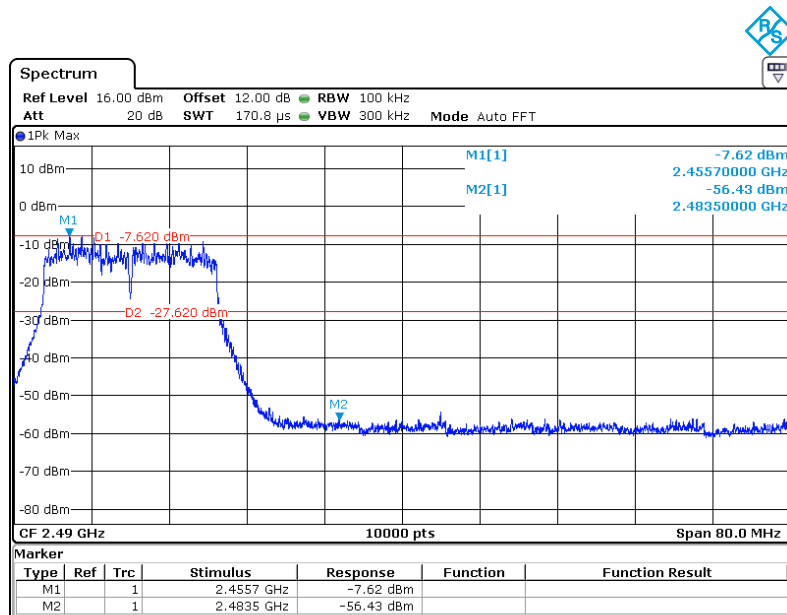

TEST REPORT

802.11n(HT40) mode with 13.5Mbps data rate

Channel 3: 2.422 GHz

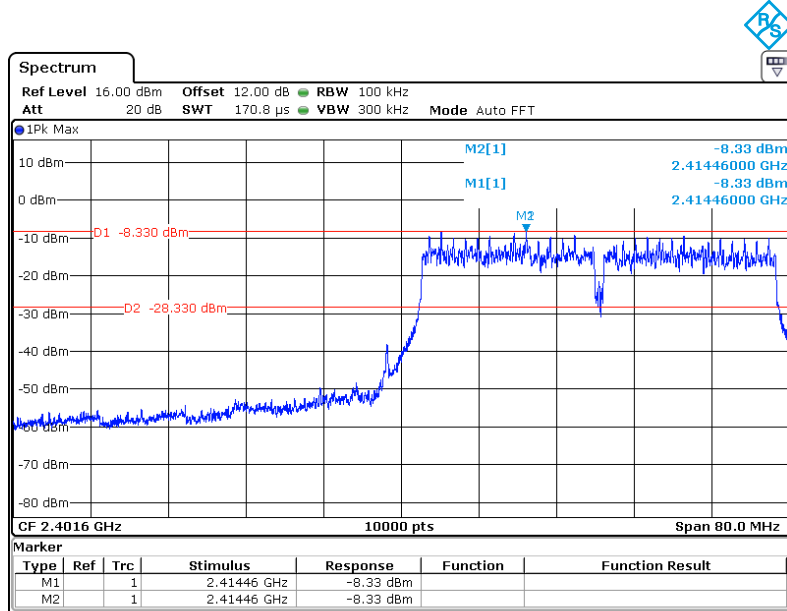

Channel 9: 2.452 GHz

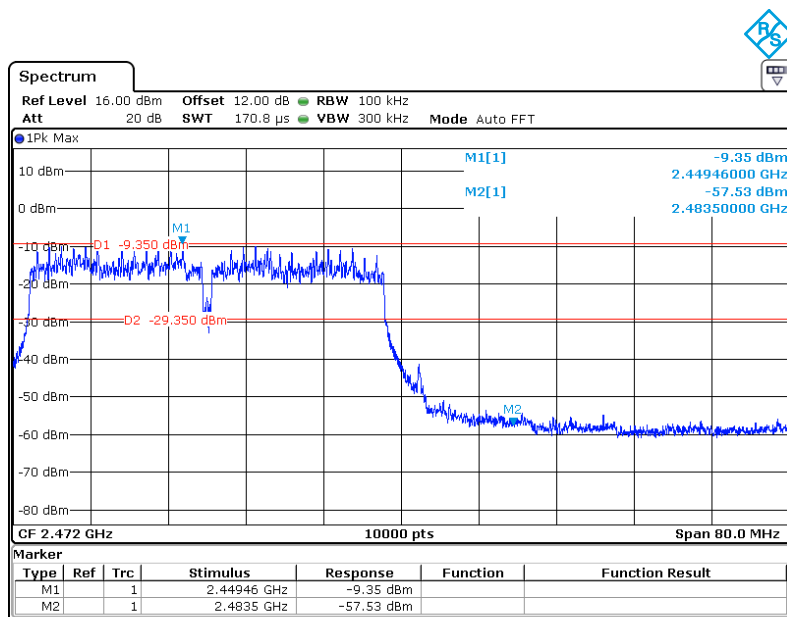

TEST REPORT

4.9 Conducted Emission Test

Test Configuration:

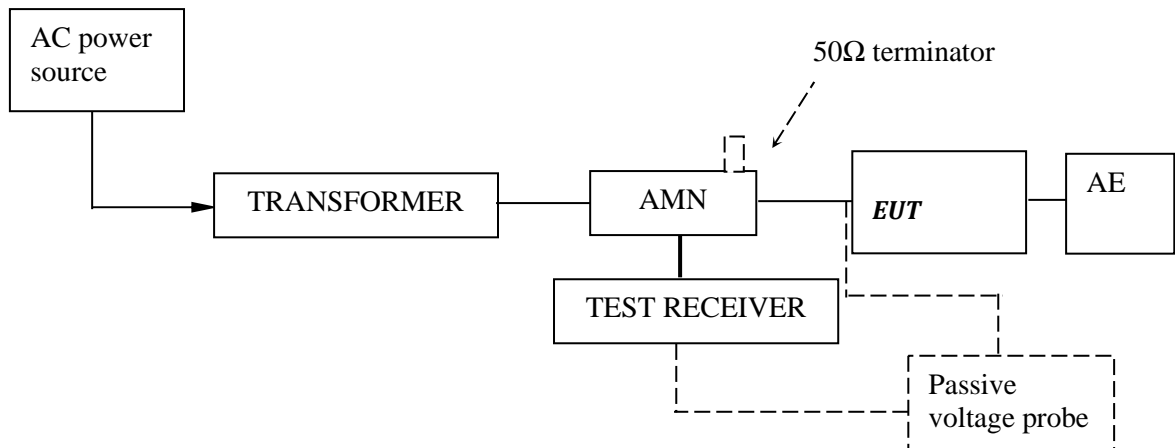

Test Setup and Procedure:

Test was performed according to ANSI C63.10 Clause 6.2. The EUT was set to achieve the maximum emission level. The mains terminal disturbance voltage was measured with the EUT in a shielded room. The EUT was connected to AC power source through an Artificial Mains Network which provides a 50Ω linear impedance Artificial hand is used if appropriate (for handheld apparatus). The load/control terminal disturbance voltage was measured with passive voltage probe if appropriate.

The table-top EUT was placed on a 0.8m high non-metallic table above earthed ground plane (Ground Reference Plane). And for floor standing EUT, was placed on a 10mm high non-metallic supported on GRP. The EUT keeps a distance of at least 0.8m from any other of the metallic surface. The Artificial Mains Network is situated at a distance of 0.8m from the EUT.

During the test, mains lead of EUT excess 0.8m was folded back and forth parallel to the lead so as to form a horizontal bundle with a length between 0.3m and 0.4m

The bandwidth of test receiver was set at 9 kHz. The frequency range from 150 kHz to 30MHz was checked.

Remark: Pre-test has been conducted to determine the worst-case mode from all possible combinations between available modulations, and record the worst-case as b mode (2412MHz) with 1Mbps data rate

TEST REPORT

Test Data and Curve

At main terminal: Pass

Tested Wire: Live

Operation Mode: transmitting mode

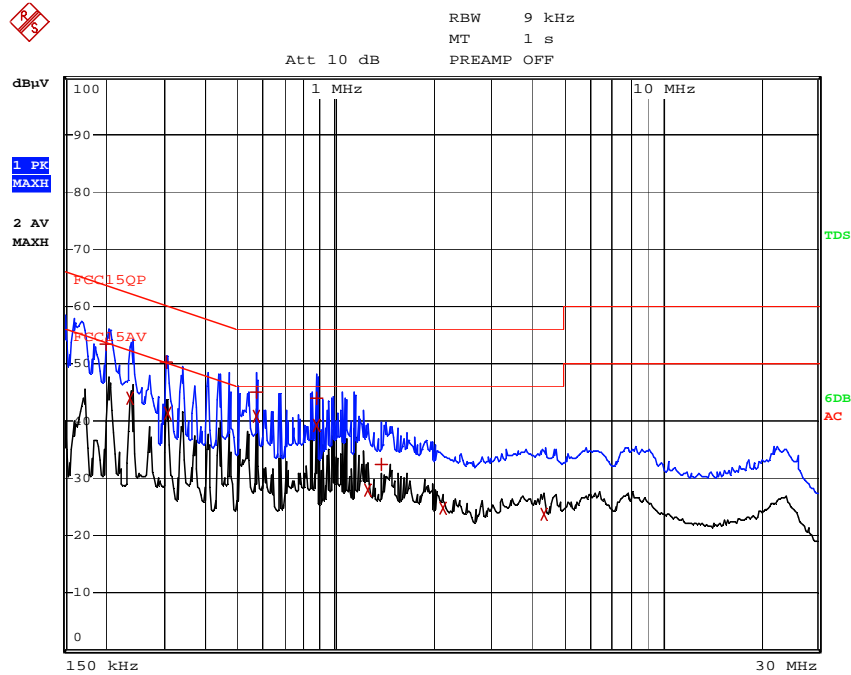

| EDIT PEAK LIST (Final Measurement Results) | | | | | |
|--|------------|-----------|------------|--|----------------|
| TRACE | | FREQUENCY | LEVEL dBµV | | DELTA LIMIT dB |
| Trace1: | FCC15QP | | | | |
| Trace2: | FCC15AV | | | | |
| Trace3: | --- | | | | |
| 1 | Quasi Peak | 202 kHz | 53.42 L1 | | -10.10 |
| 2 | Average | 238 kHz | 44.01 L1 | | -8.15 |
| 1 | Quasi Peak | 302 kHz | 50.33 L1 | | -9.85 |
| 2 | Average | 306 kHz | 41.43 L1 | | -8.64 |
| 1 | Quasi Peak | 574 kHz | 44.95 L1 | | -11.04 |
| 2 | Average | 574 kHz | 40.75 L1 | | -5.24 |
| 1 | Quasi Peak | 878 kHz | 43.86 L1 | | -12.13 |
| 2 | Average | 878 kHz | 39.34 L1 | | -6.65 |
| 2 | Average | 1.254 MHz | 27.91 L1 | | -18.08 |
| 1 | Quasi Peak | 1.39 MHz | 32.45 L1 | | -23.54 |
| 2 | Average | 2.13 MHz | 24.79 L1 | | -21.20 |
| 2 | Average | 4.366 MHz | 23.76 L1 | | -22.23 |

Remark:

1. Corr. (dB) = LISN Factor (dB) + Cable Loss (dB)
2. Level (dBµV) = Corr. (dB) + Read Level (dBµV)
3. Delta Limit (dB) = Level (dBµV)-Limit (dBµV)

TEST REPORT

Tested Wire: Neutral

Operation Mode: transmitting mode

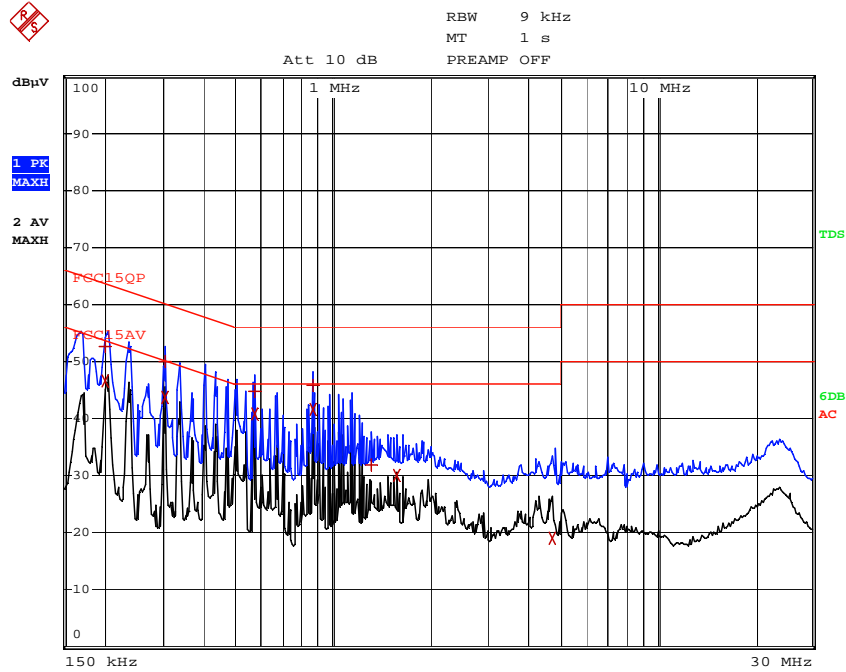

| EDIT PEAK LIST (Final Measurement Results) | | | | | |
|--|------------|-----------|-------|------|-------------|
| TRACE | | FREQUENCY | LEVEL | dBµV | DELTA LIMIT |
| Trace1: | | FCC15QP | | | |
| Trace2: | | FCC15AV | | | |
| Trace3: | | --- | | | |
| TRACE | | FREQUENCY | LEVEL | dBµV | DELTA LIMIT |
| 1 | Quasi Peak | 202 kHz | 52.53 | L1 | -10.99 |
| 2 | Average | 202 kHz | 46.57 | L1 | -6.95 |
| 1 | Quasi Peak | 302 kHz | 50.08 | L1 | -10.10 |
| 2 | Average | 302 kHz | 43.77 | L1 | -6.41 |
| 1 | Quasi Peak | 570 kHz | 44.83 | L1 | -11.16 |
| 2 | Average | 570 kHz | 40.72 | L1 | -5.27 |
| 1 | Quasi Peak | 870 kHz | 45.92 | L1 | -10.07 |
| 2 | Average | 870 kHz | 41.55 | L1 | -4.44 |
| 1 | Quasi Peak | 1.306 MHz | 31.98 | L1 | -24.01 |
| 2 | Average | 1.57 MHz | 30.06 | L1 | -15.93 |
| 2 | Average | 4.718 MHz | 19.09 | L1 | -26.90 |

Remark:

1. Corr. (dB) = LISN Factor (dB) + Cable Loss (dB)
2. Level (dBµV) = Corr. (dB) + Read Level (dBµV)
3. Delta Limit (dB) = Level (dBµV)-Limit (dBµV)

TEST REPORT

5.0 Test Equipment List

| Radiated Emission/Radio | | | | | |
|--|---|----------------------|---------------------|---------------------------------------|---------------------------------|
| Equipment No. | Equipment | Model | Manufacturer | Cal. Due date (YYYY-MM-DD) | Calibration Interval |
| EM030-04 | 3m Semi-Anechoic Chamber | 9×6×6 m ³ | ETS•LINDGREN | 4/10/2021 | 1Y |
| EM031-02 | EMI Test Receiver (9 kHz~7 GHz) | R&S ESR7 | R&S | 10/22/2020 | 1Y |
| EM031-03 | Signal and Spectrum Analyzer (10 Hz~40 GHz) | R&S FSV40 | R&S | 9/8/2020 | 1Y |
| EM011-04 | Loop antenna (9 kHz-30 MHz) | HFH2-Z2 | R&S | 6/24/2020 | 1Y |
| EM061-03 | TRILOG Super Broadband test Antenna (30 MHz-1.5 GHz) (TX) | VULB 9161 | SCHWARZBECK | 6/22/2020 | 1Y |
| EM033-01 | TRILOG Super Broadband test Antenna(30 MHz-3 GHz) (RX) | VULB 9163 | SCHWARZBECK | 9/19/2020 | 1Y |
| EM033-02 | Bouble-Ridged Waveguide Horn Antenna (800 MHz-18 GHz)(RX) | R&S HF907 | R&S | 6/22/2020 | 1Y |
| EM033-03 | High Frequency Antenna & preamplifier(18 GHz~26.5 GHz) (RX) | R&S SCU-26 | R&S | 4/24/2021 | 1Y |
| EM033-04 | High Frequency Antenna & preamplifier (26 GHz-40 GHz) | R&S SCU-40 | R&S | 4/24/2021 | 1Y |
| EM031-02-01 | Coaxial cable(9 kHz-1 GHz) | N/A | R&S | 4/12/2021 | 1Y |
| EM033-02-02 | Coaxial cable(1 GHz-18 GHz) | N/A | R&S | 4/12/2021 | 1Y |
| EM033-04-02 | Coaxial cable(18 GHz~40 GHz) | N/A | R&S | 4/24/2021 | 1Y |
| EM031-01 | Signal Generator (9 kHz~6 GHz) | SMB100A | R&S | 7/18/2020 | 1Y |
| EM040-01 | Band Reject/Notch Filter | WRHFV | Wainwright | N/A | 1Y |
| EM040-02 | Band Reject/Notch Filter | WRCGV | Wainwright | N/A | 1Y |
| EM040-03 | Band Reject/Notch Filter | WRCGV | Wainwright | N/A | 1Y |
| EM022-03 | 2.45 GHz Filter | BRM50702 | Micro-Tronics | 5/10/2021 | 1Y |
| SA016-16 | Programmable Temperature & Humidity Test Chamber | MHU-800LJ | TERCHY | 10/13/2020 | 1Y |
| SA016-22 | Climatic Test Chamber | C7-1500 | Vötsch | 11/10/2020 | 1Y |
| SA012-74 | Digital Multimeter | FLUKE175 | FLUKE | 10/13/2020 | 1Y |
| EM010-01 | Regulated DC Power supply | PAB-3003A | GUANHUA | N/A | 1Y |
| SA040-22 | Regulated DC Power supply | IT6721 | ITECH | 9/8/2020 | 1Y |
| EM084-06 | Audio Analyzer | 8903B | HP | 4/15/2021 | 1Y |
| EM045-01-01 | EMC32 software (RE/RS) | V10.01.00 | R&S | N/A | N/A |
| EM045-01-09 | EMC32 software (328/893) | V9.26.01 | R&S | N/A | N/A |
| Conducted emission at the mains terminals | | | | | |
| Equipment No. | Equipment | Model | Manufacturer | Cal. Due date (YYYY-MM-DD) | Calibration Interval |
| EM080-05 | EMI receiver | ESCI | R&S | 7/17/2020 | 1Y |
| EM006-05 | LISN | ENV216 | R&S | 6/16/2020 | 1Y |
| EM006-06 | LISN | ENV216 | R&S | 9/8/2020 | 1Y |
| EM006-06-01 | Coaxial cable | / | R&S | 4/12/2021 | 1Y |
| EM004-04 | EMC shield Room | 8m×3m×3m | Zhongyu | 1/5/2021 | 1Y |

*****End of the test report*****