

**Shenzhen Global Test Service Co.,Ltd.**

No.7-101 and 8A-104, Building 7 and 8, DCC Cultural and Creative Garden, No.98, Pingxin North Road, Shangmugu Community, Pinghu Street, Longgang District, Shenzhen, Guangdong

FCC PART 15 SUBPART C TEST REPORT**FCC PART 15.247****Report Reference No.....: GTS20191021009-1-2-2****FCC ID..... : 2AT75-NOVO-022**Compiled by
(position+printed name+signature)..: File administrators Jimmy WangSupervised by
(position+printed name+signature)..: Test Engineer Aaron TanApproved by
(position+printed name+signature)..: Manager Jason Hu

Date of issue.....: Oct.28, 2019

Representative Laboratory Name.: Shenzhen Global Test Service Co., Ltd.

Address.....: No.7-101 and 8A-104, Building 7 and 8, DCC Cultural and Creative Garden, No.98, Pingxin North Road, Shangmugu Community, Pinghu Street, Longgang District, Shenzhen, Guangdong

Applicant's name.....: Hangzhou Dfire Technology Co., Ltd.

Address: Room 218, 2nd Floor, Building 10, Gongshu District, Hangzhou City, Zhejiang Province, China

Test specificationStandard **FCC Part 15.247**

TRF Originator Shenzhen Global Test Service Co.,Ltd.

Shenzhen Global Test Service Co.,Ltd. All rights reserved.

This publication may be reproduced in whole or in part for non-commercial purposes as long as the Shenzhen Global Test Service Co.,Ltd. is acknowledged as copyright owner and source of the material. Shenzhen Global Test Service Co.,Ltd. takes no responsibility for and will not assume liability for damages resulting from the reader's interpretation of the reproduced material due to its placement and context.

Test item description The Cash Register

Trade Mark N/A

Manufacturer Hangzhou Dfire Technology Co., Ltd. .

Model/Type reference.....: NOVO-02

Listed Models N/A

Modulation Type GFSK, $\pi/4$ DQPSK, 8DPSK

Operation Frequency.....: From 2402MHz to 2480MHz

Rating DC 12V From Adapter

Result.....: **PASS**

T E S T R E P O R T

Test Report No. :	GTS20191021009-1-2-2	Oct.28, 2019 Date of issue
--------------------------	-----------------------------	-------------------------------

Equipment under Test : The Cash Register

Model /Type : NOVO-02

Listed Models : N/A

Applicant : **Hangzhou Dfire Technology Co., Ltd.**

Address : Room 218, 2nd Floor, Building 10, Gongshu District, Hangzhou City, Zhejiang Province, China

Manufacturer : **Hangzhou Dfire Technology Co., Ltd.**

Address : Room 218, 2nd Floor, Building 10, Gongshu District, Hangzhou City, Zhejiang Province, China

Test Result:	PASS
---------------------	-------------

The test report merely corresponds to the test sample.
It is not permitted to copy extracts of these test result without the written permission of the test laboratory.

Contents

<u>1</u>	<u>TEST STANDARDS</u>	<u>4</u>
<u>2</u>	<u>SUMMARY</u>	<u>5</u>
2.1	General Remarks	5
2.2	Product Description	5
2.3	Equipment Under Test	5
2.4	Short description of the Equipment under Test (EUT)	5
2.5	EUT operation mode	6
2.6	Block Diagram of Test Setup	6
2.7	Related Submittal(s) / Grant (s)	6
2.8	EUT configuration	6
2.9	Modifications	6
<u>3</u>	<u>TEST ENVIRONMENT</u>	<u>7</u>
3.1	Address of the test laboratory	7
3.2	Test Facility	7
3.3	Environmental conditions	7
3.4	Summary of measurement results	8
3.5	Statement of the measurement uncertainty	8
3.6	Equipments Used during the Test	9
<u>4</u>	<u>TEST CONDITIONS AND RESULTS</u>	<u>10</u>
4.1	AC Power Conducted Emission	10
4.2	Radiated Emission	13
4.3	Maximum Peak Output Power	19
4.4	20dB Bandwidth	20
4.5	Frequency Separation	24
4.6	Number of hopping frequency	26
4.7	Time of Occupancy (Dwell Time)	28
4.8	Out-of-band Emissions	32
4.9	Pseudorandom Frequency Hopping Sequence	40
4.10	Antenna Requirement	41
<u>5</u>	<u>TEST SETUP PHOTOS OF THE EUT</u>	<u>42</u>

1 TEST STANDARDS

The tests were performed according to following standards:

[FCC Rules Part 15.247](#): Frequency Hopping, Direct Spread Spectrum and Hybrid Systems that are in operation within the bands of 902-928 MHz, 2400-2483.5 MHz, and 5725-5850 MHz.

[ANSI C63.10-2013](#): American National Standard for Testing Unlicensed Wireless Devices

[KDB558074 D01 v05r02](#): Guidance for Compliance Measurements on Digital Transmission Systems (DTS) ,Frequency Hopping Spread Spectrum System(HFSS), and Hybrid System Devices Operating Under §15.247 of The FCC rules.

2 SUMMARY

2.1 General Remarks

Date of receipt of test sample	:	Oct.08, 2019
Testing commenced on	:	Oct.08, 2019
Testing concluded on	:	Oct.28, 2019

2.2 Product Description

Product Name:	The Cash Register
Model/Type reference:	NOVO-02
Power supply:	DC12V From Adapter
Adapter information :	Model: ADP-48D12 Input: 100-240V~, 50/60Hz 1.5A Output: 12VDC, 5A
Bluetooth :	
Supported Type:	Bluetooth BR/EDR
Modulation:	GFSK, $\pi/4$ DQPSK, 8DPSK
Operation frequency:	2402MHz~2480MHz
Channel number:	79
Channel separation:	1MHz
Antenna type:	FPC antenna
Antenna gain:	1.00dBi

2.3 Equipment Under Test

Power supply system utilised

Power supply voltage	:	<input type="radio"/> 230V / 50 Hz	<input type="radio"/> 120V / 60Hz
		<input checked="" type="radio"/> 12 V DC	<input type="radio"/> 24 V DC
		<input type="radio"/> Other (specified in blank below)	

DC 12V from Adapter

2.4 Short description of the Equipment under Test (EUT)

This is a The Cash Register .

For more details, refer to the user's manual of the EUT.

2.5 EUT operation mode

The Applicant provides communication tools software to control the EUT for staying in continuous transmitting (Duty Cycle more than 98%) and receiving mode for testing .There are 79 channels provided to the EUT and Channel 00/39/78 were selected to test.

Operation Frequency:

Channel	Frequency (MHz)
00	2402
01	2403
⋮	⋮
38	2440
39	2441
40	2442
⋮	⋮
77	2479
78	2480

2.6 Block Diagram of Test Setup

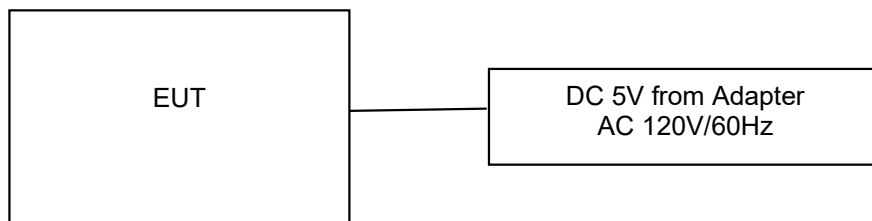

2.7 Related Submittal(s) / Grant (s)

This submittal(s) (test report) is intended for the device filing to comply with Section 15.247 of the FCC Part 15, Subpart C Rules.

2.8 EUT configuration

The following peripheral devices and interface cables were connected during the measurement:

- supplied by the manufacturer
- Supplied by the lab

<input type="radio"/>	ADAPTER	M/N:	
<input type="radio"/>		Manufacturer:	

2.9 Modifications

No modifications were implemented to meet testing criteria.

3 TEST ENVIRONMENT

3.1 Address of the test laboratory

Shenzhen Global Test Service Co.,Ltd.

No.7-101 and 8A-104, Building 7 and 8, DCC Cultural and Creative Garden, No.98, Pingxin North Road, Shangmugu Community, Pinghu Street, Longgang District, Shenzhen, Guangdong

The 3m-Semi anechoic test site fulfils CISPR 16-1-4 according to ANSI C63.4:2014 and CISPR 16-1-4:2010 SVSWR requirement for radiated emission above 1GHz.

3.2 Test Facility

The test facility is recognized, certified, or accredited by the following organizations:

FCC-Registration No.: 165725

Shenzhen Global Test Service Co.,Ltd EMC Laboratory has been registered and fully described in a report filed with the (FCC) Federal Communications Commission. The acceptance letter from the FCC is maintained in our files.

A2LA-Lab Cert. No.: 4758.01

Shenzhen Global Test Service Co.,Ltd. EMC Laboratory has been accredited by A2LA for technical competence in the field of electrical testing, and proved to be in compliance with ISO/IEC 17025: 2005 General Requirements for the Competence of Testing and Calibration Laboratories and any additional program requirements in the identified field of testing.

CNAS-Lab Code: L8169

Shenzhen Global Test Service Co.,Ltd. has been assessed and proved to be in compliance with CNAS-CL01 Accreditation Criteria for Testing and Calibration Laboratories (identical to ISO/IEC 17025: 2005 General Requirements) for the Competence of Testing and Calibration Laboratories. Date of Registration: Dec. 11, 2015. Valid time is until Dec. 10, 2024.

3.3 Environmental conditions

During the measurement the environmental conditions were within the listed ranges:

Temperature:	15-35 ° C
Humidity:	30-60 %
Atmospheric pressure:	950-1050mbar

3.4 Summary of measurement results

Test Specification clause	Test case	Test Mode	Test Channel	Recorded In Report		Pass	Fail	NA	NP	Remark
§15.247(a)(1)	Carrier Frequency separation	GFSK π/4DQPSK 8DPSK	<input checked="" type="checkbox"/> Lowest <input checked="" type="checkbox"/> Middle <input checked="" type="checkbox"/> Highest	GFSK π/4DQPSK 8DPSK	<input checked="" type="checkbox"/> Middle	<input checked="" type="checkbox"/>	<input type="checkbox"/>	<input type="checkbox"/>	<input type="checkbox"/>	complies
§15.247(a)(1)	Number of Hopping channels	GFSK π/4DQPSK 8DPSK	<input checked="" type="checkbox"/> Full	GFSK 8DPSK	<input checked="" type="checkbox"/> Full	<input checked="" type="checkbox"/>	<input type="checkbox"/>	<input type="checkbox"/>	<input type="checkbox"/>	complies
§15.247(a)(1)	Time of Occupancy (dwell time)	GFSK π/4DQPSK 8DPSK	<input checked="" type="checkbox"/> Lowest <input checked="" type="checkbox"/> Middle <input checked="" type="checkbox"/> Highest	GFSK π/4DQPSK 8DPSK	<input checked="" type="checkbox"/> Middle	<input checked="" type="checkbox"/>	<input type="checkbox"/>	<input type="checkbox"/>	<input type="checkbox"/>	complies
§15.247(a)(1)	Spectrum bandwidth of a FHSS system 20dB bandwidth	GFSK π/4DQPSK 8DPSK	<input checked="" type="checkbox"/> Lowest <input checked="" type="checkbox"/> Middle <input checked="" type="checkbox"/> Highest	GFSK π/4DQPSK 8DPSK	<input checked="" type="checkbox"/> Lowest <input checked="" type="checkbox"/> Middle <input checked="" type="checkbox"/> Highest	<input checked="" type="checkbox"/>	<input type="checkbox"/>	<input type="checkbox"/>	<input type="checkbox"/>	complies
§15.247(b)(1)	Maximum output power	GFSK π/4DQPSK 8DPSK	<input checked="" type="checkbox"/> Lowest <input checked="" type="checkbox"/> Middle <input checked="" type="checkbox"/> Highest	GFSK π/4DQPSK 8DPSK	<input checked="" type="checkbox"/> Lowest <input checked="" type="checkbox"/> Middle <input checked="" type="checkbox"/> Highest	<input checked="" type="checkbox"/>	<input type="checkbox"/>	<input type="checkbox"/>	<input type="checkbox"/>	complies
§15.247(d)	Band edge compliance conducted	GFSK π/4DQPSK 8DPSK	<input checked="" type="checkbox"/> Lowest <input checked="" type="checkbox"/> Highest	GFSK π/4DQPSK 8DPSK	<input checked="" type="checkbox"/> Lowest <input checked="" type="checkbox"/> Highest	<input checked="" type="checkbox"/>	<input type="checkbox"/>	<input type="checkbox"/>	<input type="checkbox"/>	complies
§15.205	Band edge compliance radiated	GFSK π/4DQPSK 8DPSK	<input checked="" type="checkbox"/> Lowest <input checked="" type="checkbox"/> Highest	GFSK	<input checked="" type="checkbox"/> Lowest <input checked="" type="checkbox"/> Highest	<input checked="" type="checkbox"/>	<input type="checkbox"/>	<input type="checkbox"/>	<input type="checkbox"/>	complies
§15.247(d)	TX spurious emissions conducted	GFSK π/4DQPSK 8DPSK	<input checked="" type="checkbox"/> Lowest <input checked="" type="checkbox"/> Middle <input checked="" type="checkbox"/> Highest	GFSK π/4DQPSK 8DPSK	<input checked="" type="checkbox"/> Lowest <input checked="" type="checkbox"/> Middle <input checked="" type="checkbox"/> Highest	<input checked="" type="checkbox"/>	<input type="checkbox"/>	<input type="checkbox"/>	<input type="checkbox"/>	complies
§15.247(d)	TX spurious emissions radiated	GFSK π/4DQPSK 8DPSK	<input checked="" type="checkbox"/> Lowest <input checked="" type="checkbox"/> Middle <input checked="" type="checkbox"/> Highest	GFSK	<input checked="" type="checkbox"/> Lowest <input checked="" type="checkbox"/> Middle <input checked="" type="checkbox"/> Highest	<input checked="" type="checkbox"/>	<input type="checkbox"/>	<input type="checkbox"/>	<input type="checkbox"/>	complies
§15.209(a)	TX spurious Emissions radiated Below 1GHz	GFSK π/4DQPSK 8DPSK	<input checked="" type="checkbox"/> Lowest <input checked="" type="checkbox"/> Middle <input checked="" type="checkbox"/> Highest	GFSK	<input checked="" type="checkbox"/> Middle	<input checked="" type="checkbox"/>	<input type="checkbox"/>	<input type="checkbox"/>	<input type="checkbox"/>	complies
§15.107(a) §15.207	Conducted Emissions 9KHz-30 MHz	GFSK π/4DQPSK 8DPSK	<input checked="" type="checkbox"/> Lowest <input checked="" type="checkbox"/> Middle <input checked="" type="checkbox"/> Highest	GFSK	<input checked="" type="checkbox"/> Middle	<input checked="" type="checkbox"/>	<input type="checkbox"/>	<input type="checkbox"/>	<input type="checkbox"/>	complies

Remark:

1. The measurement uncertainty is not included in the test result.
2. NA = Not Applicable; NP = Not Performed
3. We tested all test mode and recorded worst case in report

3.5 Statement of the measurement uncertainty

The data and results referenced in this document are true and accurate. The reader is cautioned that there may be errors within the calibration limits of the equipment and facilities. The measurement uncertainty was calculated for all measurements listed in this test report acc. to CISPR 16 - 4 „Specification for radio disturbance and immunity measuring apparatus and methods – Part 4: Uncertainty in EMC Measurements“ and is documented in the Shenzhen Global Test Service Co.,Ltd quality system acc. to DIN EN ISO/IEC 17025. Furthermore, component and process variability of devices similar to that tested may result in additional deviation. The manufacturer has the sole responsibility of continued compliance of the device.

Hereafter the best measurement capability for Shenzhen GTS laboratory is reported:

Test	Range	Measurement Uncertainty	Notes
Radiated Emission	30~1000MHz	4.10 dB	(1)
Radiated Emission	1~18GHz	4.32 dB	(1)
Radiated Emission	18-40GHz	5.54 dB	(1)
Conducted Disturbance	0.15~30MHz	3.12 dB	(1)

- (1) This uncertainty represents an expanded uncertainty expressed at approximately the 95% confidence level using a coverage factor of k=2.

3.6 Equipments Used during the Test

Test Equipment	Manufacturer	Model No.	Serial No.	Calibration Date	Calibration Due Date
LISN	R&S	ENV216	3560.6550.08	2019/09/20	2020/09/19
LISN	R&S	ESH2-Z5	893606/008	2019/09/20	2020/09/19
Bilog Antenna	Schwarzbeck	VULB9163	976	2019/09/20	2020/09/19
EMI Test Receiver	R&S	ESCI7	101102	2019/09/20	2020/09/19
Spectrum Analyzer	Agilent	N9020A	MY48010425	2019/09/20	2020/09/19
Spectrum Analyzer	R&S	FSP40	100019	2019/09/20	2020/09/19
Controller	EM Electronics	Controller EM 1000	N/A	N/A	N/A
Horn Antenna	Schwarzbeck	BBHA 9120D	01622	2019/09/20	2020/09/19
Active Loop Antenna	SCHWARZBECK	FMZB1519	1519-037	2019/09/20	2020/09/19
Broadband Horn Antenna	SCHWARZBECK	BBHA 9170	971	2019/09/20	2020/09/19
Amplifier	Schwarzbeck	BBV 9743	#202	2019/09/20	2020/09/19
Amplifier	EMCI	EMC051845B	980355	2019/09/20	2020/09/19
Temperature/Humidity Meter	Gangxing	CTH-608	02	2019/09/20	2020/09/19
High-Pass Filter	K&L	9SH10-2700/X12750-O/O	KL142031	2019/09/20	2020/09/19
High-Pass Filter	K&L	41H10-1375/U12750-O/O	KL142032	2019/09/20	2020/09/19
RF Cable(below 1GHz)	HUBER+SUHNER	RG214	RE01	2019/09/20	2020/09/19
RF Cable(above 1GHz)	HUBER+SUHNER	RG214	RE02	2019/09/20	2020/09/19
Data acquisition card	Agilent	U2531A	TW53323507	2019/09/20	2020/09/19
Power Sensor	Agilent	U2021XA	MY5365004	2019/09/20	2020/09/19
EMI Test Software	R&S	ES-K1	V1.7.1	2019/09/20	2020/09/19
EMI Test Software	JS Tonscend	JS32-RE	2.0.1.5	2019/09/20	2020/09/19
EMI Test Software	Audix	E3	2..1.1	2019/09/20	2020/09/19

Note: The Cal.Interval was one year.

4 TEST CONDITIONS AND RESULTS

4.1 AC Power Conducted Emission

TEST CONFIGURATION

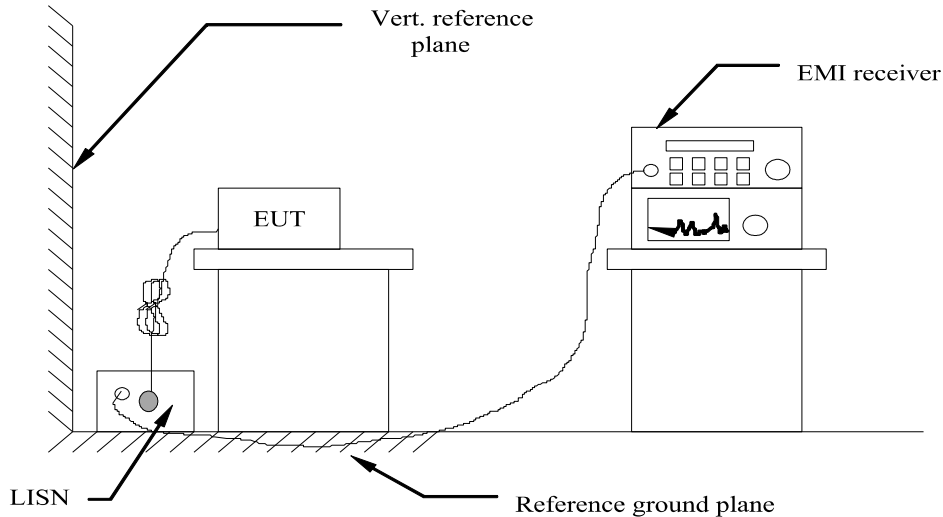

TEST PROCEDURE

- 1 The equipment was set up as per the test configuration to simulate typical actual usage per the user's manual. The EUT is a tabletop system, a wooden table with a height of 0.8 meters is used and is placed on the ground plane as per ANSI C63.10-2013.
- 2 Support equipment, if needed, was placed as per ANSI C63.10-2013
- 3 All I/O cables were positioned to simulate typical actual usage as per ANSI C63.10-2013
- 4 The EUT received DC 12V power from adapter, the adapter received AC120V/60Hz and AC 240V/60Hz power through a Line Impedance Stabilization Network (LISN) which supplied power source and was grounded to the ground plane.
- 5 All support equipments received AC power from a second LISN, if any.
- 6 The EUT test program was started. Emissions were measured on each current carrying line of the EUT using a spectrum Analyzer / Receiver connected to the LISN powering the EUT. The LISN has two monitoring points: Line 1 (Hot Side) and Line 2 (Neutral Side). Two scans were taken: one with Line 1 connected to Analyzer / Receiver and Line 2 connected to a 50 ohm load; the second scan had Line 1 connected to a 50 ohm load and Line 2 connected to the Analyzer / Receiver.
- 7 Analyzer / Receiver scanned from 150 KHz to 30MHz for emissions in each of the test modes.
- 8 During the above scans, the emissions were maximized by cable manipulation.

AC Power Conducted Emission Limit

For intentional device, according to § 15.207(a) AC Power Conducted Emission Limits is as following :

Frequency range (MHz)	Limit (dBuV)	
	Quasi-peak	Average
0.15-0.5	66 to 56*	56 to 46*
0.5-5	56	46
5-30	60	50

* Decreases with the logarithm of the frequency.

TEST RESULTS

Remark:

1. All modes of GFSK, Pi/4 DQPSK, and 8DPSK were test at Low, Middle, and High channel; only the worst result of GFSK Middle Channel was reported as below:
2. Both 120 VAC, 50/60 Hz and 240 VAC, 50/60 Hz power supply have been tested, only the worst result of 120 VAC, 60 Hz was reported as below:

Power supply:	DC 5V from Adapter AC 120V/60Hz	Polarization	L
---------------	------------------------------------	--------------	---

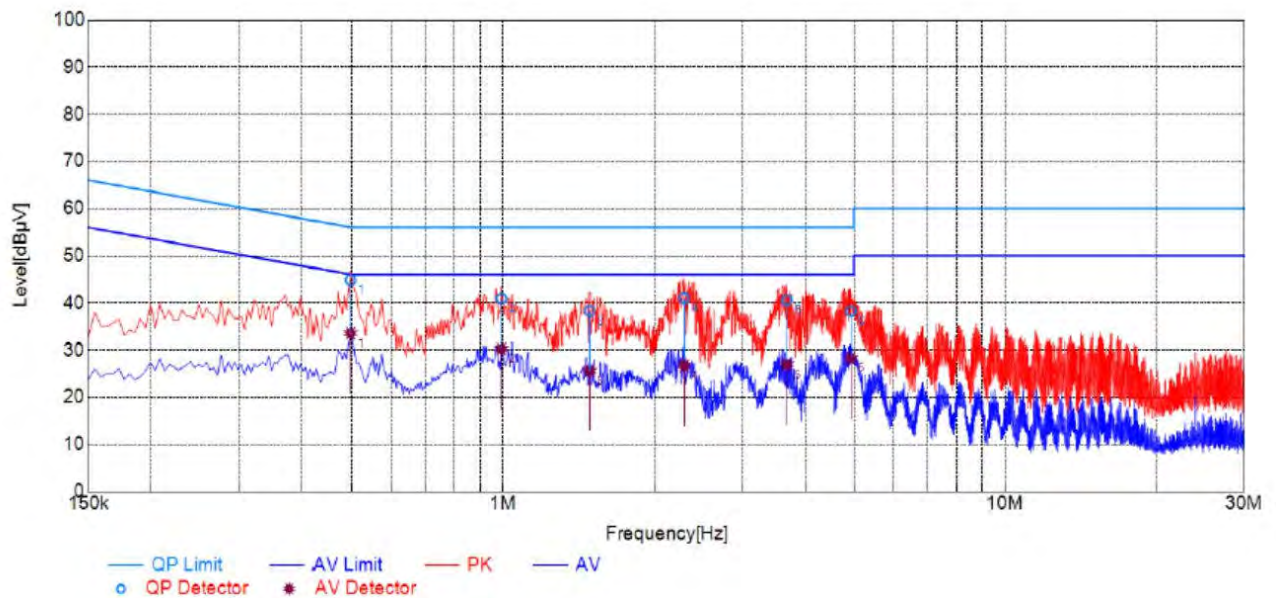

Final Data List												
NO.	Frequency [MHz]	QP Reading [dBµV]	AVG. Reading [dBµV]	Factor [dB]	QP Result [dBµV]	AVG. Result [dBµV]	QP Limit [dBµV]	AVG. Limit [dBµV]	QP Margin [dB]	AVG. Margin [dB]	Line	Remark
1	0.4964	34.57	23.34	10.26	44.83	33.60	56.06	46.06	11.23	12.46	L1	PASS
2	0.9924	30.75	20.08	10.19	40.94	30.27	56.00	46.00	15.06	15.73	L1	PASS
3	1.4867	28.09	15.42	10.23	38.32	25.65	56.00	46.00	17.68	20.35	L1	PASS
4	2.2958	30.75	16.42	10.29	41.04	26.71	56.00	46.00	14.96	19.29	L1	PASS
5	3.6780	30.27	16.63	10.36	40.63	26.99	56.00	46.00	15.37	19.01	L1	PASS
6	4.9324	27.90	17.97	10.34	38.24	28.31	56.00	46.00	17.76	17.69	L1	PASS

Power supply:	DC 5V from Adapter AC 120V/60Hz	Polarization	N
---------------	------------------------------------	--------------	---

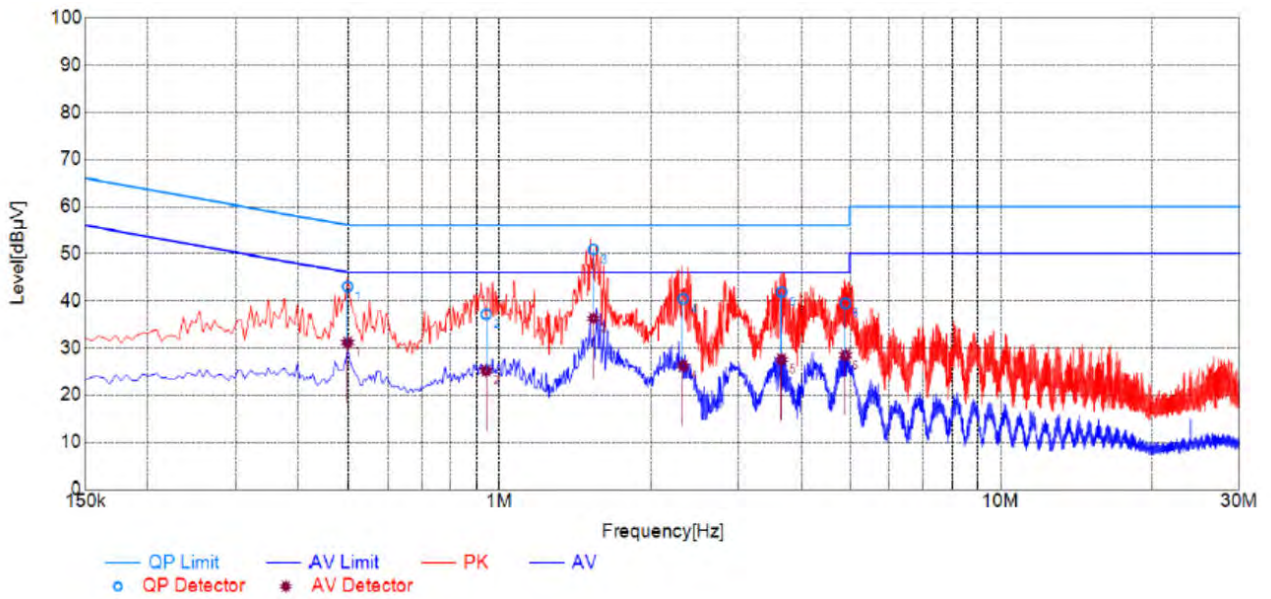

Final Data List

NO.	Frequency [MHz]	QP Reading [dBµV]	AVG. Reading [dBµV]	Factor [dB]	QP Result [dBµV]	AVG. Result [dBµV]	QP Limit [dBµV]	AVG. Limit [dBµV]	QP Margin [dB]	AVG. Margin [dB]	Line	Remark
1	0.4975	32.77	20.91	10.25	43.02	31.16	56.04	46.04	13.02	14.88	N	PASS
2	0.9400	26.92	14.93	10.21	37.13	25.14	56.00	46.00	18.87	20.86	N	PASS
3	1.5400	40.66	26.01	10.24	50.90	36.25	56.00	46.00	5.10	9.75	N	PASS
4	2.3258	30.10	15.89	10.30	40.40	26.19	56.00	46.00	15.60	19.81	N	PASS
5	3.6587	31.49	17.19	10.36	41.85	27.55	56.00	46.00	14.15	18.45	N	PASS
6	4.9022	29.09	18.09	10.35	39.44	28.44	56.00	46.00	16.56	17.56	N	PASS

4.2 Radiated Emission

TEST CONFIGURATION

Frequency range 9 KHz – 30MHz

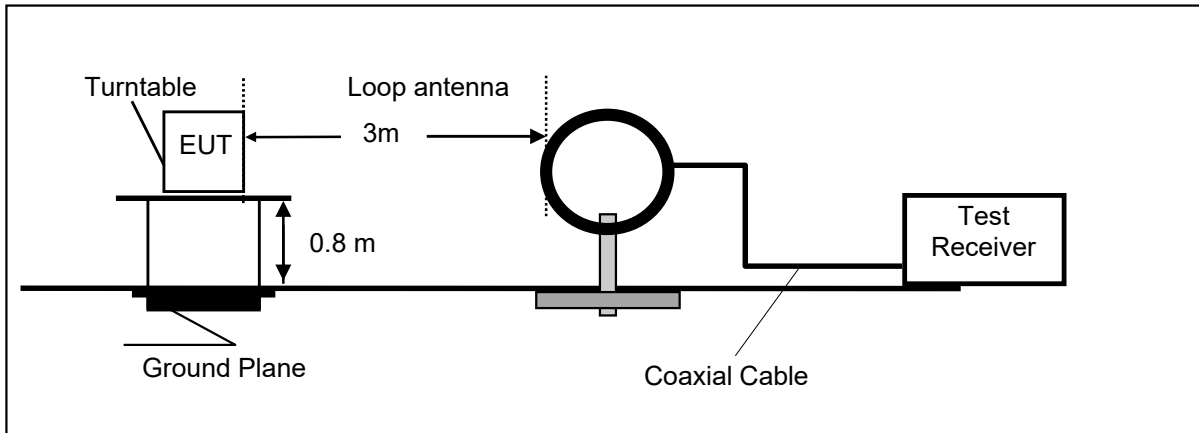

Frequency range 30MHz – 1000MHz

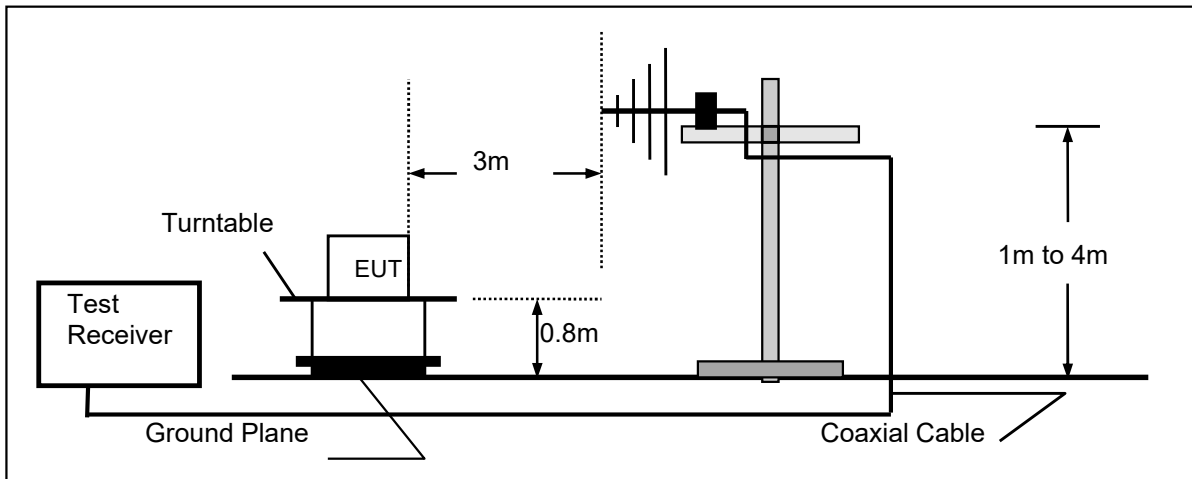

Frequency range above 1GHz-25GHz

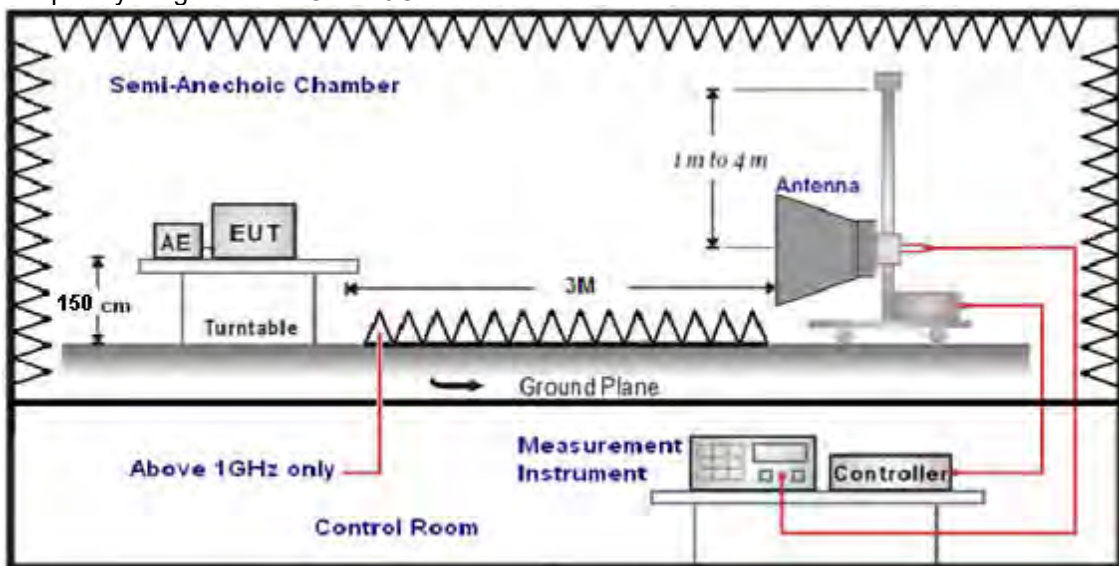

TEST PROCEDURE

1. The EUT was placed on a turn table which is 0.8m above ground plane when testing frequency range 9 KHz –1GHz;the EUT was placed on a turn table which is 1.5m above ground plane when testing frequency range 1GHz – 25GHz.
2. Maximum procedure was performed by raising the receiving antenna from 1m to 4m and rotating the turn table from 0° to 360° to acquire the highest emissions from EUT .
3. And also, each emission was to be maximized by changing the polarization of receiving antenna both horizontal and vertical.
4. Repeat above procedures until all frequency measurements have been completed.
5. Radiated emission test frequency band from 9KHz to 25GHz.
6. The distance between test antenna and EUT as following table states:

Test Frequency range	Test Antenna Type	Test Distance
9KHz-30MHz	Active Loop Antenna	3
30MHz-1GHz	Ultra-Broadband Antenna	3
1GHz-18GHz	Double Ridged Horn Antenna	3
18GHz-25GHz	Horn Antenna	1

7. Setting test receiver/spectrum as following table states:

Test Frequency range	Test Receiver/Spectrum Setting	Detector
9KHz-150KHz	RBW=200Hz/VBW=3KHz, Sweep time=Auto	QP
150KHz-30MHz	RBW=9KHz/VBW=100KHz, Sweep time=Auto	QP
30MHz-1GHz	RBW=120KHz/VBW=1000KHz, Sweep time=Auto	QP
1GHz-40GHz	Peak Value: RBW=1MHz/VBW=3MHz, Sweep time=Auto Average Value: RBW=1MHz/VBW=10Hz, Sweep time=Auto	Peak

Field Strength Calculation

The field strength is calculated by adding the Antenna Factor and Cable Factor and subtracting the Amplifier Gain and Duty Cycle Correction Factor(if any) from the measured reading. The basic equation with a sample calculation is as follows:

FS = RA + AF + CL - AG

Where FS = Field Strength	CL = Cable Attenuation Factor (Cable Loss)
RA = Reading Amplitude	AG = Amplifier Gain
AF = Antenna Factor	

Transd=AF +CL-AG

RADIATION LIMIT

For intentional device, according to § 15.209(a), the general requirement of field strength of radiated emission from intentional radiators at a distance of 3 meters shall not exceed the following table. According to § 15.247(d), in any 100kHz bandwidth outside the frequency band in which the EUT is operating, the radio frequency power that is produced by the intentional radiator shall be at least 20dB below that in the100kHz bandwidth within the band that contains the highest level of desired power.

The pre-test have done for the EUT in three axes and found the worst emission at position shown in test setup photos.

Frequency (MHz)	Distance (Meters)	Radiated (dBµV/m)	Radiated (µV/m)
0.009-0.49	3	20log(2400/F(KHz))+40log(300/3)	2400/F(KHz)
0.49-1.705	3	20log(24000/F(KHz))+ 40log(30/3)	24000/F(KHz)
1.705-30	3	20log(30)+ 40log(30/3)	30
30-88	3	40.0	100
88-216	3	43.5	150
216-960	3	46.0	200
Above 960	3	54.0	500

TEST RESULTS

Remark:

1. We measured Radiated Emission at GFSK, $\pi/4$ DQPSK and 8DPSK mode from 9 KHz to 25GHz and recorded worst case at GFSK DH5 mode.
2. For below 1GHz testing recorded worst at GFSK DH5 middle channel.
3. Radiated emission test from 9 KHz to 10th harmonic of fundamental was verified, and no emission found except system noise floor in 9 KHz to 30MHz and not recorded in this report.

For 30MHz-1GHz

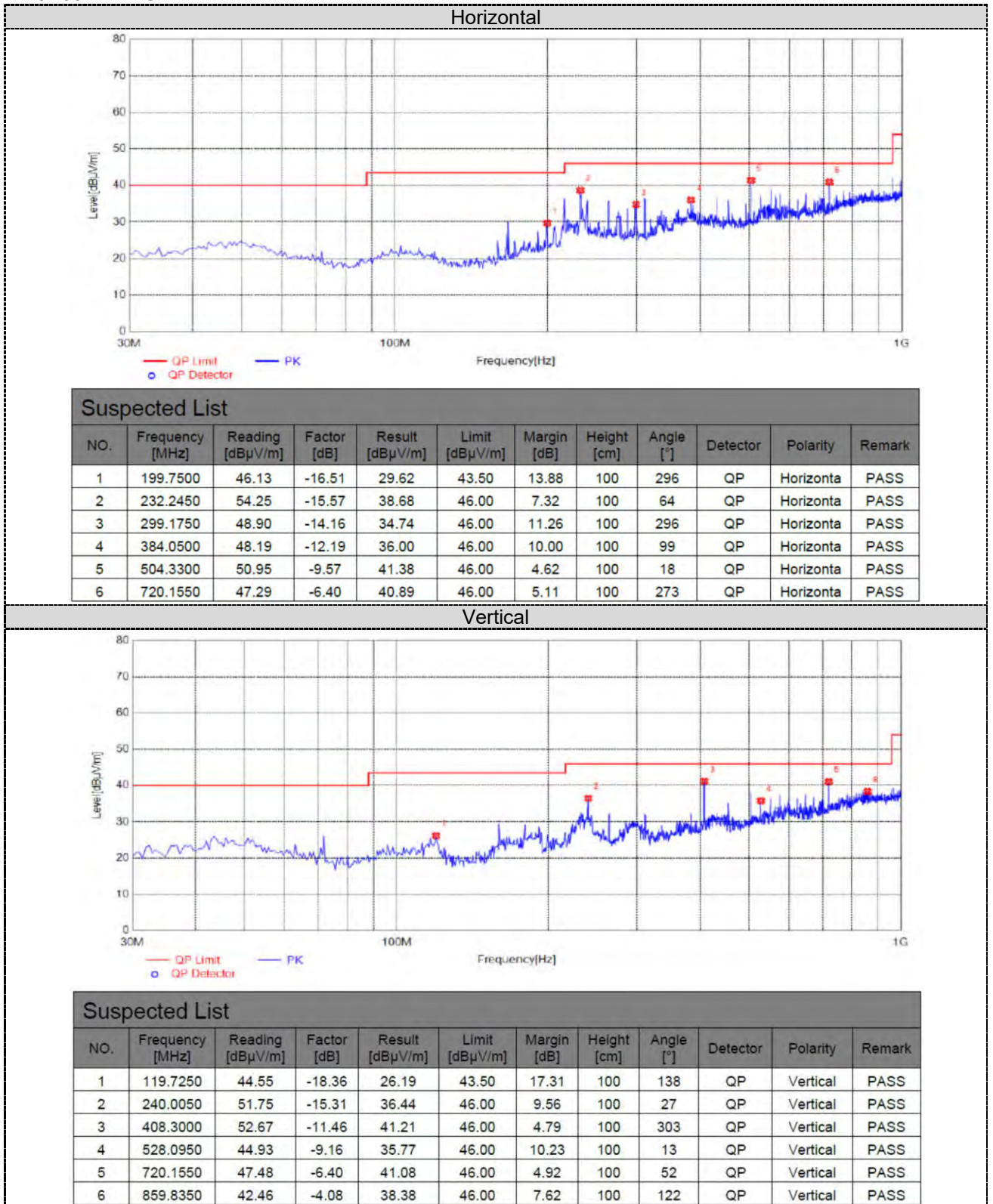

For 1GHz to 25GHz

Note: GFSK, Pi/4 DQPSK and 8DPSK all have been tested, only worse case GFSK is reported.

GFSK (above 1GHz)

Frequency(MHz):			2402		Polarity:		HORIZONTAL		
Frequency (MHz)	Emission Level (dBuV/m)		Limit (dBuV/m)	Margin (dB)	Raw Value (dBuV)	Antenna Factor (dB/m)	Cable Factor (dB)	Pre-amplifier (dB)	Correction Factor (dB/m)
4804.00	54.28	PK	74	19.72	52.38	31.42	6.98	36.5	1.90
4804.00	--	AV	54	--	--	--	--	--	--
7206.00	46.96	PK	74	27.04	36.36	37.03	8.87	35.3	10.60
7206.00	--	AV	54	--	--	--	--	--	--

Frequency(MHz):			2402		Polarity:		VERTICAL		
Frequency (MHz)	Emission Level (dBuV/m)		Limit (dBuV/m)	Margin (dB)	Raw Value (dBuV)	Antenna Factor (dB/m)	Cable Factor (dB)	Pre-amplifier (dB)	Correction Factor (dB/m)
4804.00	55.36	PK	74	18.64	53.46	50.27	6.98	36.5	1.90
4804.00	--	AV	54	--	--	--	--	--	--
7206.00	47.29	PK	74	26.71	36.69	34.02	8.87	35.3	10.60
7206.00	--	AV	54	--	--	--	--	--	--

Frequency(MHz):			2441		Polarity:		HORIZONTAL		
Frequency (MHz)	Emission Level (dBuV/m)		Limit (dBuV/m)	Margin (dB)	Raw Value (dBuV)	Antenna Factor (dB/m)	Cable Factor (dB)	Pre-amplifier (dB)	Correction Factor (dB/m)
4882.00	53.46	PK	74	20.54	51.40	30.98	7.58	36.5	2.06
4882.00	--	AV	54	--	--	--	--	--	--
7323.00	46.19	PK	74	27.81	35.27	37.66	8.56	35.3	10.92
7323.00	--	AV	54	--	--	--	--	--	--

Frequency(MHz):			2441		Polarity:		VERTICAL		
Frequency (MHz)	Emission Level (dBuV/m)		Limit (dBuV/m)	Margin (dB)	Raw Value (dBuV)	Antenna Factor (dB/m)	Cable Factor (dB)	Pre-amplifier (dB)	Correction Factor (dB/m)
4882.00	54.50	PK	74	19.5	52.44	30.98	7.58	36.5	2.06
4882.00	--	AV	54	--	--	--	--	--	--
7323.00	46.84	PK	74	27.16	35.92	37.66	8.56	35.3	10.92
7323.00	--	AV	54	--	--	--	--	--	--

Frequency(MHz):			2480		Polarity:		HORIZONTAL		
Frequency (MHz)	Emission Level (dBuV/m)		Limit (dBuV/m)	Margin (dB)	Raw Value (dBuV)	Antenna Factor (dB/m)	Cable Factor (dB)	Pre-amplifier (dB)	Correction Factor (dB/m)
4960.00	54.25	PK	74	19.75	51.18	49.26	7.8	36.2	3.07
4960.00	--	AV	54	--	--	--	--	--	--
7440.00	47.41	PK	74	26.59	35.67	34.02	8.72	35.3	11.74
7440.00	--	AV	54	--	--	--	--	--	--

Frequency(MHz):			2480		Polarity:		VERTICAL		
Frequency (MHz)	Emission Level (dBuV/m)		Limit (dBuV/m)	Margin (dB)	Raw Value (dBuV)	Antenna Factor (dB/m)	Cable Factor (dB)	Pre-amplifier (dB)	Correction Factor (dB/m)
4960.00	55.71	PK	74	18.29	52.64	31.47	7.8	36.2	3.07
4960.00	--	AV	54	--	--	--	--	--	--
7440.00	48.11	PK	74	25.89	36.37	38.32	8.72	35.3	11.74
7440.00	--	AV	54	--	--	--	--	--	--

REMARKS:

1. Emission level (dBuV/m) = Raw Value (dBuV) + Correction Factor (dB/m)
2. Correction Factor (dB/m) = Antenna Factor (dB/m) + Cable Factor (dB) - Pre-amplifier
3. Margin value = Limit value - Emission level.
4. -- Mean the PK detector measured value is below average limit.
5. The other emission levels were very low against the limit.

Results of Band Edges Test (Radiated)

Note: GFSK, Pi/4 DQPSK and 8DPSK all have been tested, only worse case GFSK is reported.

GFSK

Frequency(MHz):			2402		Polarity:		HORIZONTAL		
Frequency (MHz)	Emission Level (dBuV/m)		Limit (dBuV/m)	Margin (dB)	Raw Value (dBuV)	Antenna Factor (dB/m)	Cable Factor (dB)	Pre-amplifier (dB)	Correction Factor (dB/m)
2390.00	48.23	PK	74	25.77	53.64	27.49	3.32	36.22	-5.41
2390.00		AV	54	--		--	--	--	--
Frequency(MHz):			2402		Polarity:		VERTICAL		
Frequency (MHz)	Emission Level (dBuV/m)		Limit (dBuV/m)	Margin (dB)	Raw Value (dBuV)	Antenna Factor (dB/m)	Cable Factor (dB)	Pre-amplifier (dB)	Correction Factor (dB/m)
2390.00	49.19	PK	74	24.81	54.60	27.49	3.32	36.22	-5.41
2390.00		AV	54	--	--	--	--	--	--
Frequency(MHz):			2480		Polarity:		HORIZONTAL		
Frequency (MHz)	Emission Level (dBuV/m)		Limit (dBuV/m)	Margin (dB)	Raw Value (dBuV)	Antenna Factor (dB/m)	Cable Factor (dB)	Pre-amplifier (dB)	Correction Factor (dB/m)
2483.50	46.92	PK	74	27.08	52.43	27.45	3.38	36.34	-5.51
2483.50		AV	54	--		--	--	--	--
Frequency(MHz):			2480		Polarity:		VERTICAL		
Frequency (MHz)	Emission Level (dBuV/m)		Limit (dBuV/m)	Margin (dB)	Raw Value (dBuV)	Antenna Factor (dB/m)	Cable Factor (dB)	Pre-amplifier (dB)	Correction Factor (dB/m)
2483.50	47.97	PK	74	26.03	53.48	27.45	3.38	36.34	-5.51
2483.50		AV	54	--		--	--	--	--

REMARKS:

1. Emission level (dBuV/m) = Raw Value (dBuV) + Correction Factor (dB/m)
2. Correction Factor (dB/m) = Antenna Factor (dB/m) + Cable Factor (dB) - Pre-amplifier
3. Margin value = Limit value - Emission level.
4. -- Mean the PK detector measured value is below average limit.

4.3 Maximum Peak Output Power

Limit

The Maximum Peak Output Power Measurement is 125mW (20.97).

Test Procedure

Remove the antenna from the EUT and then connect a low loss RF cable from the antenna port to the powersensor.

Test Configuration

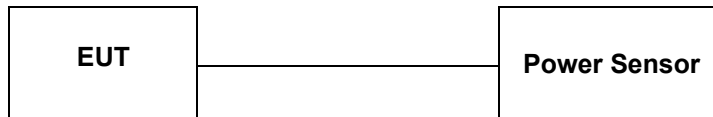

Test Results

Type	Channel	Output power (dBm)	Limit (dBm)	Result
GFSK	00	4.736	20.97	Pass
	39	4.909		
	78	5.071		
π/4DQPSK	00	3.965	20.97	Pass
	39	4.150		
	78	4.229		
8DPSK	00	4.128	20.97	Pass
	39	4.328		
	78	4.416		

Note: 1.The test results including the cable lose.

4.4 20dB Bandwidth

Limit

For frequency hopping systems operating in the 2400MHz-2483.5MHz no limit for 20dB bandwidth.

Test Procedure

The transmitter output was connected to the spectrum analyzer through an attenuator. The bandwidth of the fundamental frequency was measured by spectrum analyzer with 30 KHz RBW and 100 KHz VBW.

The 20dB bandwidth is defined as the total spectrum the power of which is higher than peak power minus 20dB.

Test Configuration

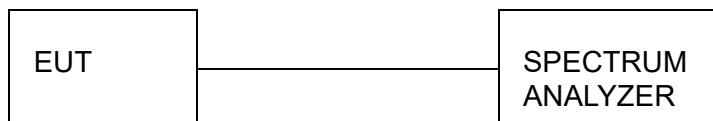

Test Results

Modulation	Channel	20dB bandwidth (MHz)	99% OBW (MHz)	Result
GFSK	CH00	0.9653	0.88870	Pass
	CH39	0.9671	0.89084	
	CH78	0.9660	0.89196	
π/4DQPSK	CH00	1.289	1.1809	
	CH39	1.291	1.1799	
	CH78	1.289	1.1740	
8DPSK	CH00	1.298	1.1958	
	CH39	1.295	1.1919	
	CH78	1.295	1.1861	

Test plot as follows:

GFSK Modulation



CH00



CH39



CH78

$\pi/4$ DQPSK Modulation

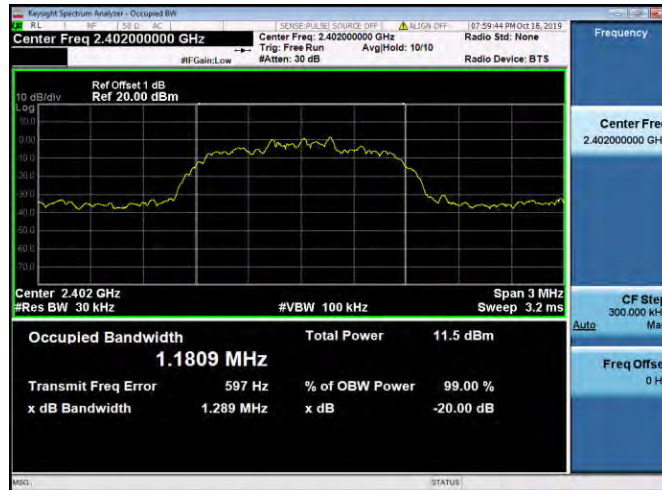

CH00

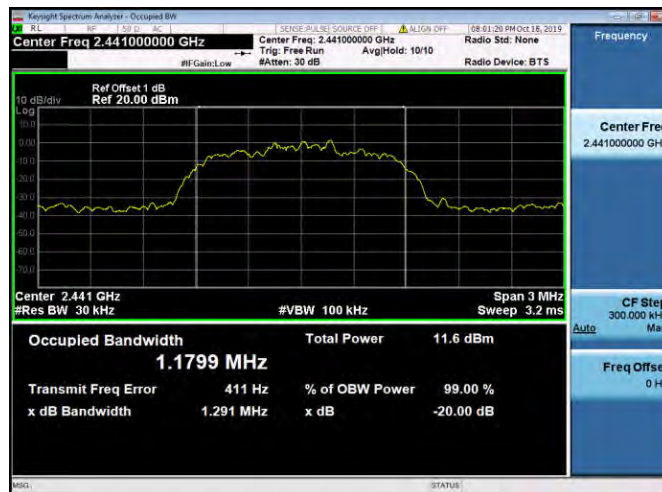

CH39

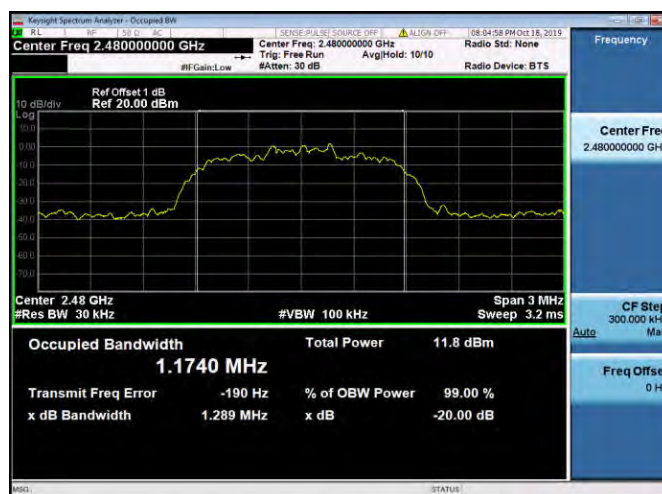

CH78

8DPSK Modulation

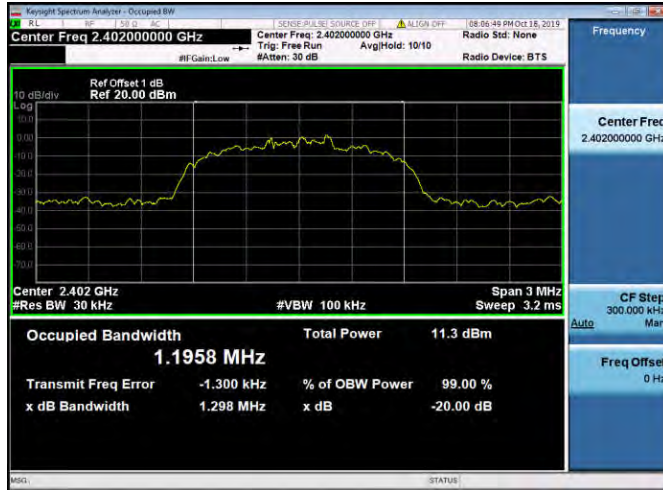

CH00

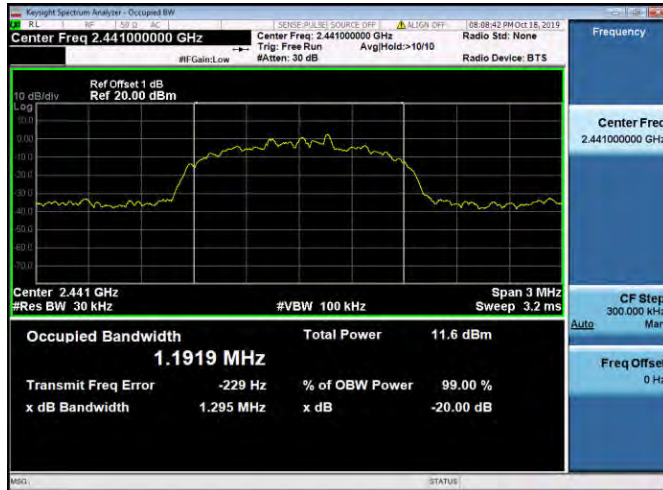

CH39

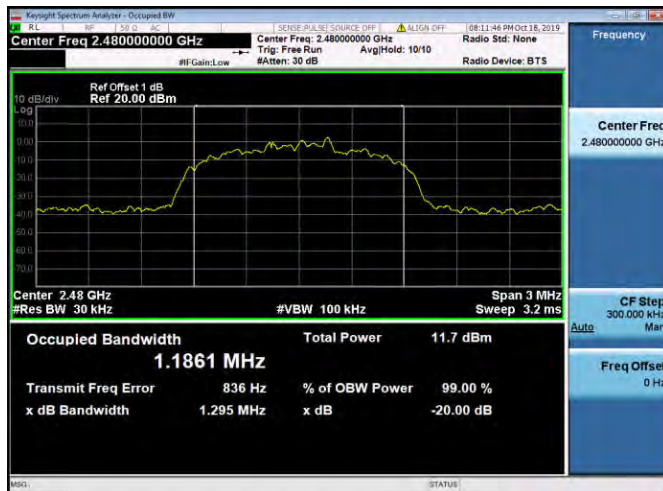

CH78

4.5 Frequency Separation

LIMIT

According to 15.247(a)(1), frequency hopping systems shall have hopping channel carrier frequencies separated by minimum of 25KHz or the $2/3 \cdot 20\text{dB}$ bandwidth of the hopping channel, whichever is greater.

TEST PROCEDURE

The transmitter output was connected to the spectrum analyzer through an attenuator. The bandwidth of the fundamental frequency was measured by spectrum analyzer with 100 KHz RBW and 300 KHz VBW.

TEST CONFIGURATION

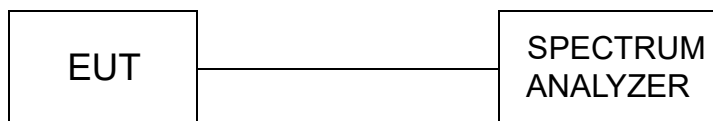

TEST RESULTS

Modulation	Channel	Channel Separation (MHz)	Limit(MHz)	Result
GFSK	CH39	1.161	25KHz or $2/3 \cdot 20\text{dB}$ bandwidth	Pass
	CH40			
$\pi/4$ DQPSK	CH39	1.208	25KHz or $2/3 \cdot 20\text{dB}$ bandwidth	Pass
	CH40			
8DPSK	CH39	1.186	25KHz or $2/3 \cdot 20\text{dB}$ bandwidth	Pass
	CH40			

Note:

We have tested all mode at high, middle and low channel, and recorded worst case at middle

Test plot as follows:

GFSK Modulation



$\pi/4$ DQPSK Modulation

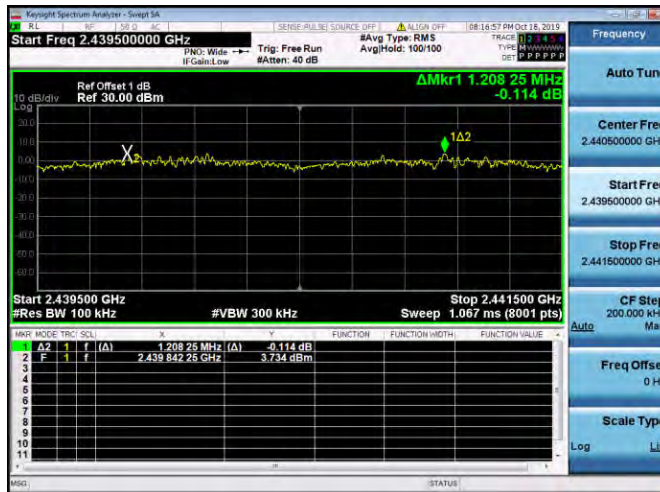

8DPSK Modulation

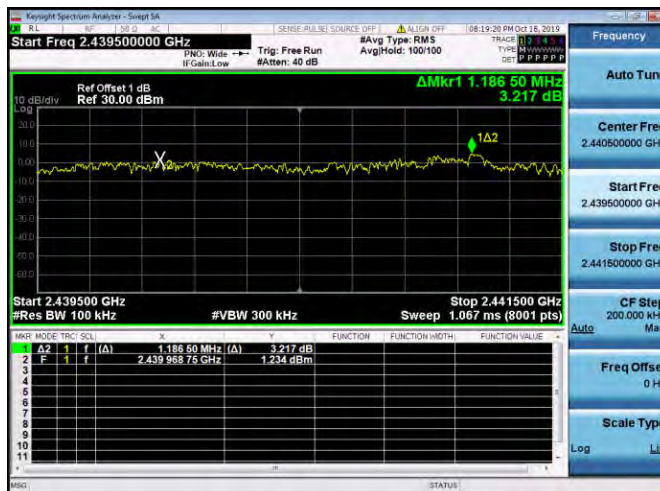

4.6 Number of hopping frequency

Limit

Frequency hopping systems in the 2400–2483.5 MHz band shall use at least 15 channels.

Test Procedure

The transmitter output was connected to the spectrum analyzer through an attenuator. Set spectrum analyzer start 2400MHz to 2483.5MHz with 100 KHz RBW and 300 KHz VBW.

Test Configuration

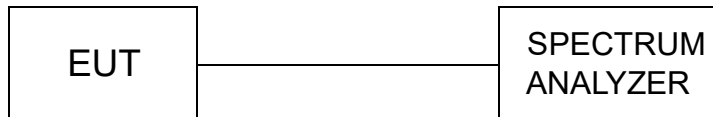

Test Results

Modulation	Number of Hopping Channel	Limit	Result
GFSK	79	≥15	Pass
$\pi/4$ DQPSK	79		
8DPSK	79		

Test plot as follows:

GFSK Modulation

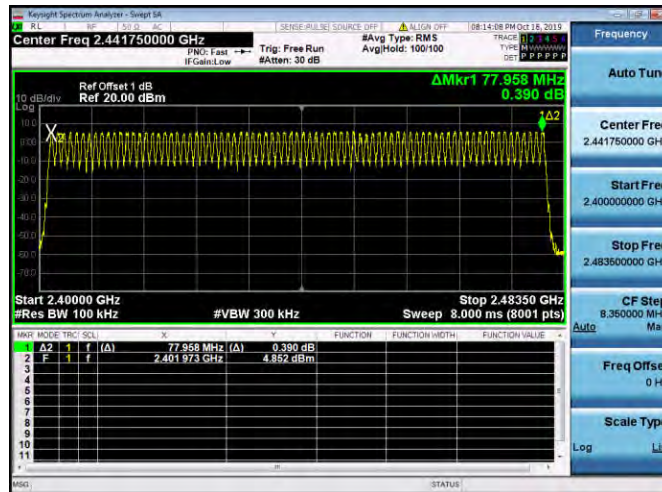

$\pi/4$ DQPSK Modulation

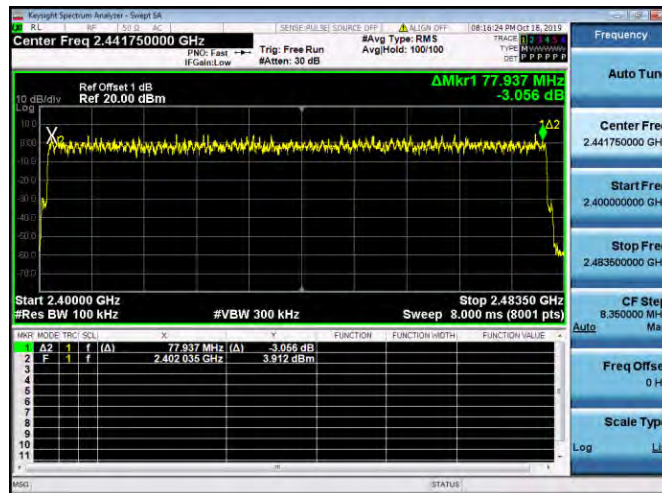

8DPSK Modulation

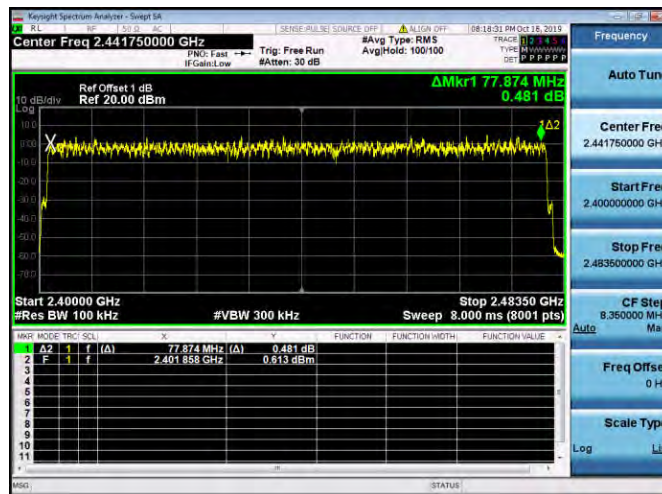

4.7 Time of Occupancy (Dwell Time)

Limit

The average time of occupancy on any channel shall not be greater than 0.4 seconds within a period of 0.4 seconds multiplied by the number of hopping channels employed.

Test Procedure

The transmitter output was connected to the spectrum analyzer through an attenuator. Set center frequency of spectrum analyzer=operating frequency with 1MHz RBW and 1MHz VBW, Span 0Hz.

Test Configuration

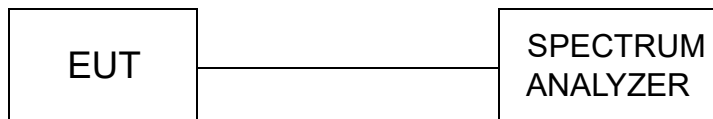

Test Results

Modulation	Packet	Pulse time (ms)	Dwell time (s)	Limit (s)	Result
GFSK	DH1	0.370	0.118	0.40	Pass
	DH3	1.626	0.260		
	DH5	2.873	0.306		
$\pi/4$ DQPSK	2-DH1	0.378	0.121	0.40	Pass
	2-DH3	1.629	0.261		
	2-DH5	2.876	0.307		
8DPSK	3-DH1	0.380	0.122	0.40	Pass
	3-DH3	1.575	0.252		
	3-DH5	2.879	0.307		

Note:

- We have tested all mode at high,middle and low channel,and recoreded worst case at middle channel.
- Dwell time=Pulse time (ms) \times (1600 \div 2 \div 79) \times 31.6 Second for DH1, 2-DH1, 3-DH1
Dwell time=Pulse time (ms) \times (1600 \div 4 \div 79) \times 31.6 Second for DH3, 2-DH3, 3-DH3
Dwell time=Pulse time (ms) \times (1600 \div 6 \div 79) \times 31.6 Second for DH5, 2-DH5, 3-DH5

Test plot as follows:

GFSK Modulation

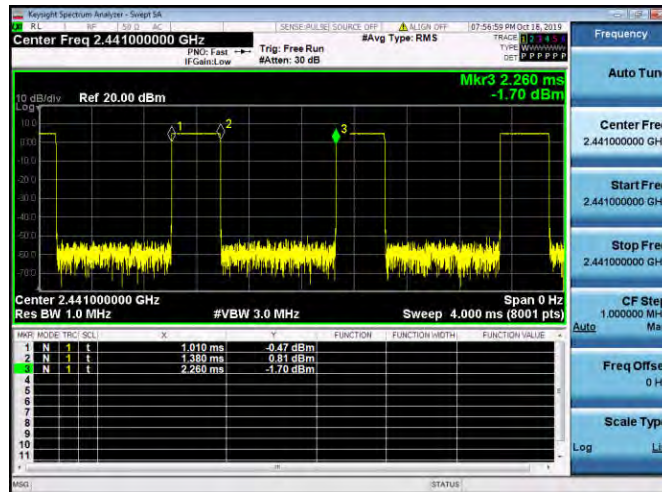

DH1

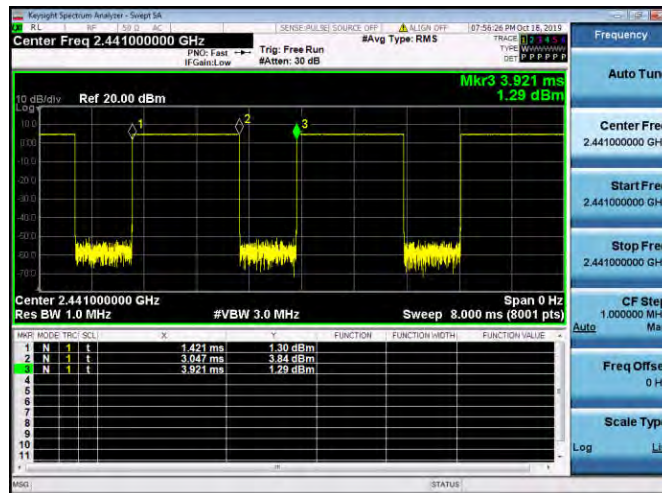

DH3

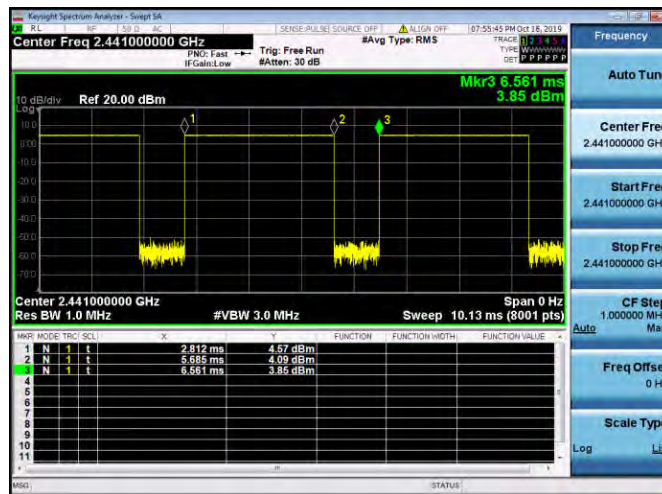

DH5

$\pi/4$ DQPSK Modulation

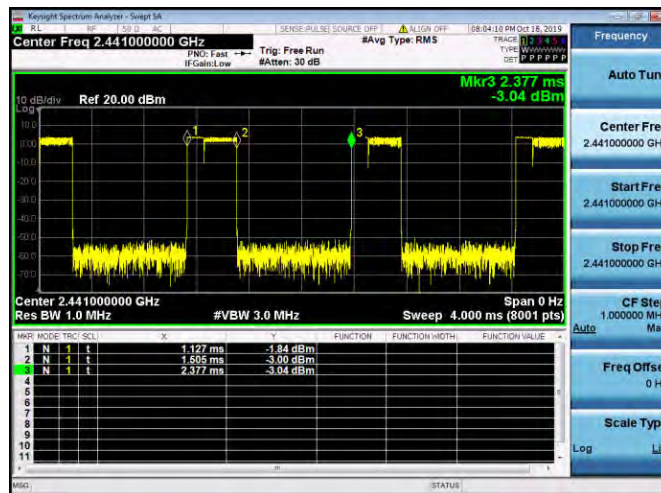

2-DH1

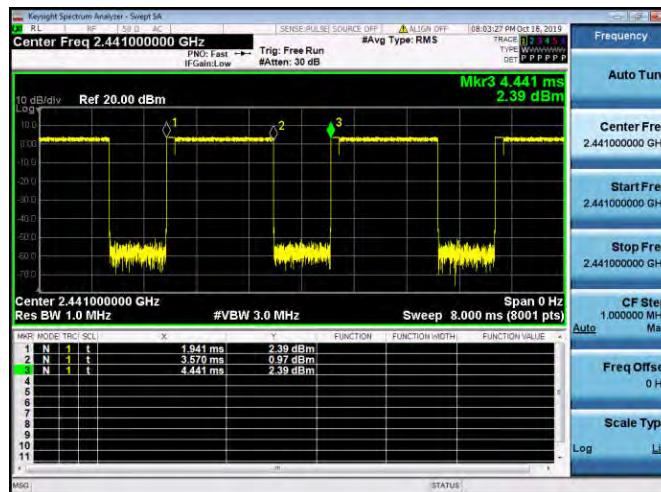

2-DH3

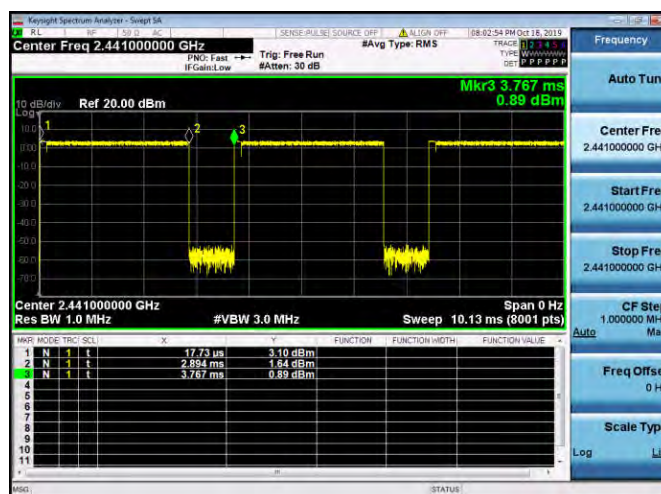

2-DH5

8DPSK Modulation

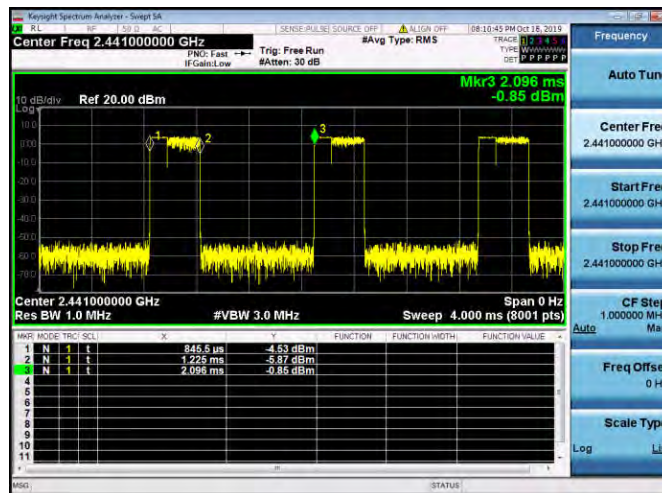

3-DH1

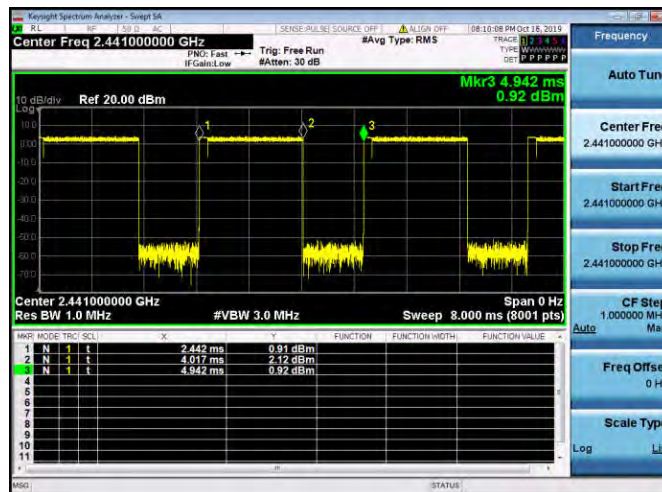

3-DH3

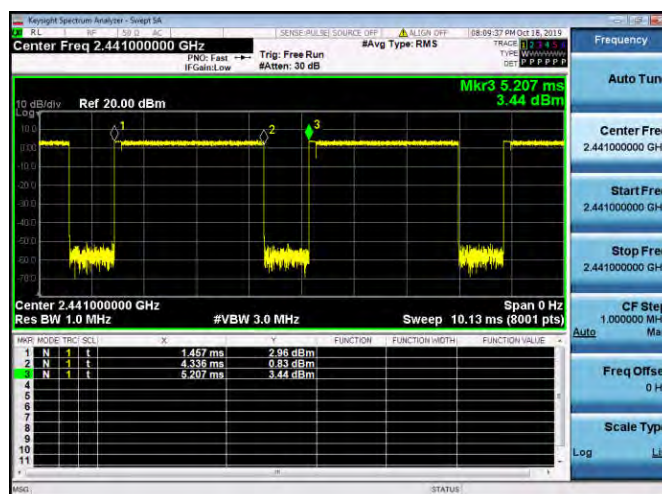

3-DH5

4.8 Out-of-band Emissions

Limit

In any 100 kHz bandwidth outside the frequency band in which the spread spectrum or digitally modulated intentional radiator is operating, the radio frequency power that is produced by the intentional radiator shall be at least 20 dB below that in the 100 kHz bandwidth within the band that contains the highest level of the desired power, based on either an RF conducted or a radiated measurement, provided the transmitter demonstrates compliance with the peak conducted power limits. If the transmitter complies with the conducted power limits based on the use of RMS averaging over a time interval, as permitted under paragraph (b)(3) of this section, the attenuation required under this paragraph shall be 30 dB instead of 20 dB. Attenuation below the general limits specified in §15.209(a) is not required.

Test Procedure

Connect the transmitter output to spectrum analyzer using a low loss RF cable, and set the spectrum analyzer to RBW=100 kHz, VBW= 300 kHz, peak detector, and max hold. Measurements utilizing these settings are made of the in-band reference level, band-edge and out-of-band emissions.

Test Configuration

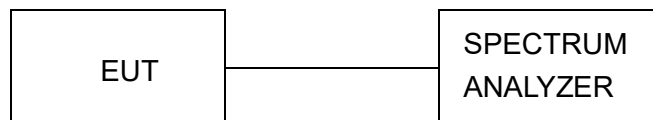

Test Results

Remark: The measurement frequency range is from 30MHz to the 10th harmonic of the fundamental frequency. The lowest, middle and highest channels are tested to verify the spurious emissions and band-edge measurement data.

We measured all conditions (DH1, DH3, DH5) and recorded worst case at DH5

Test plot as follows:

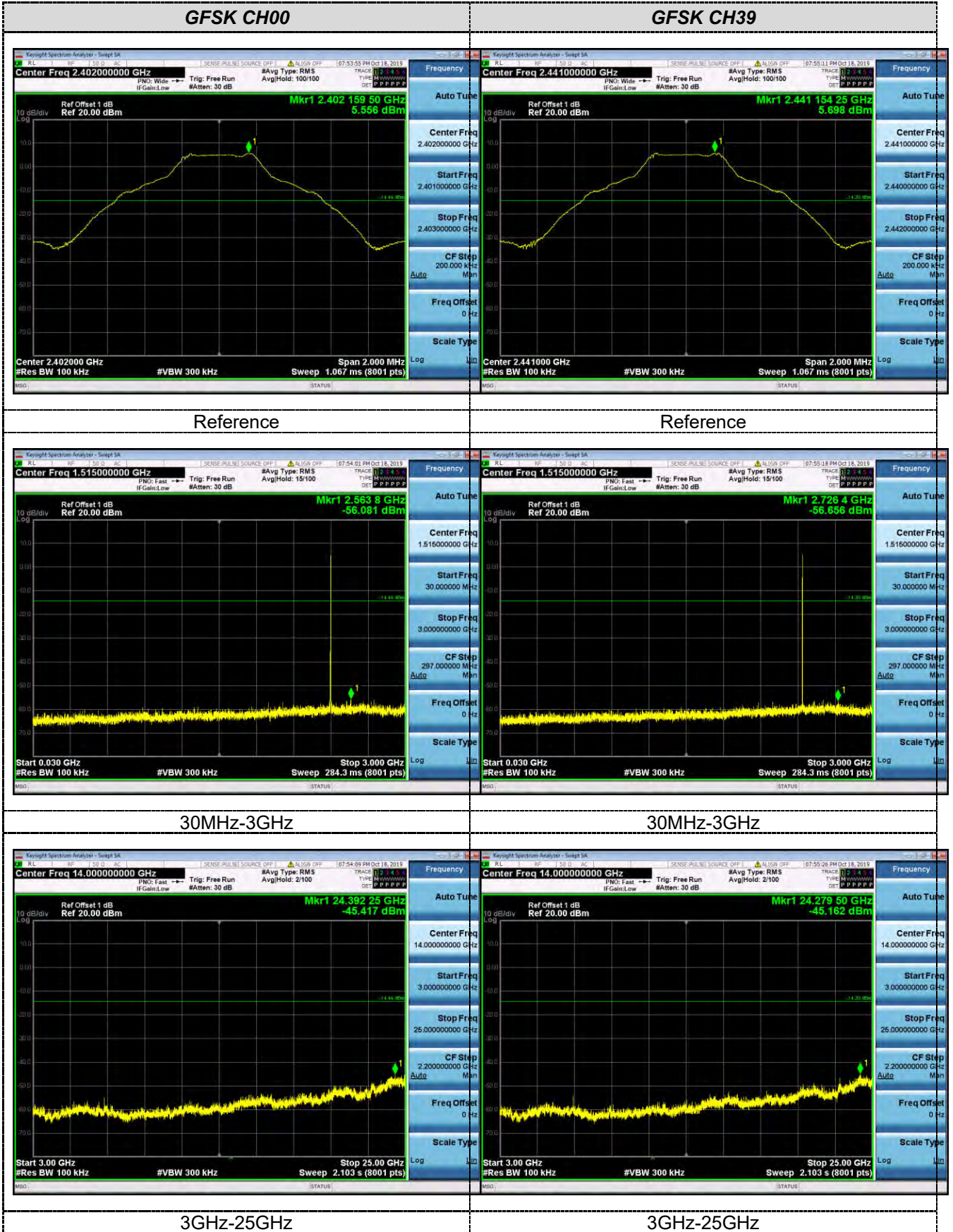

GFSK CH78

π /4DQPSK CH00

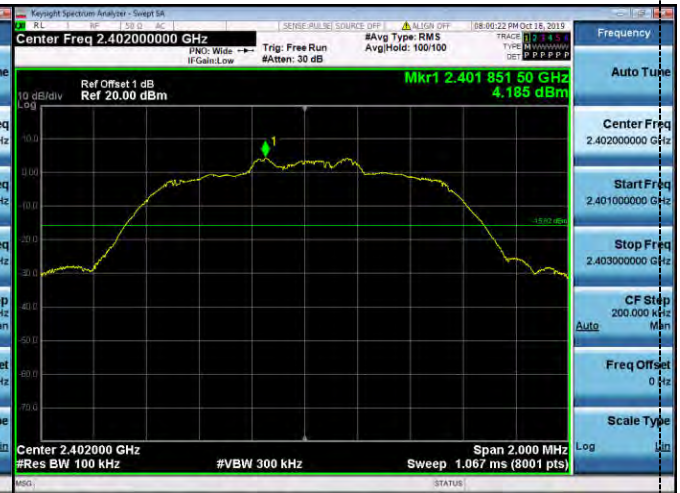

Reference

Reference

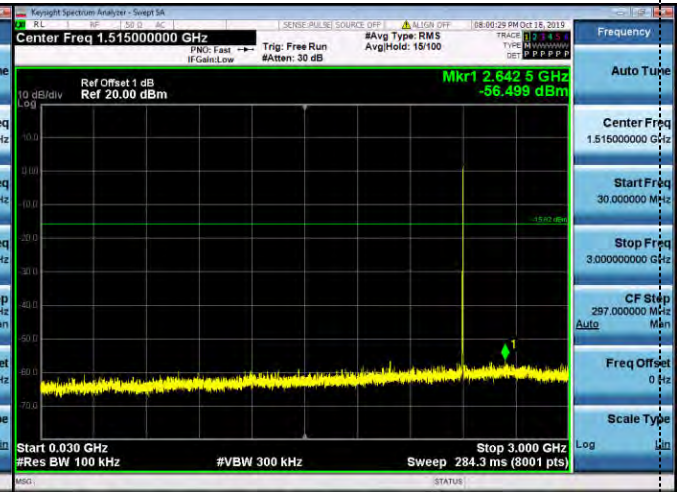
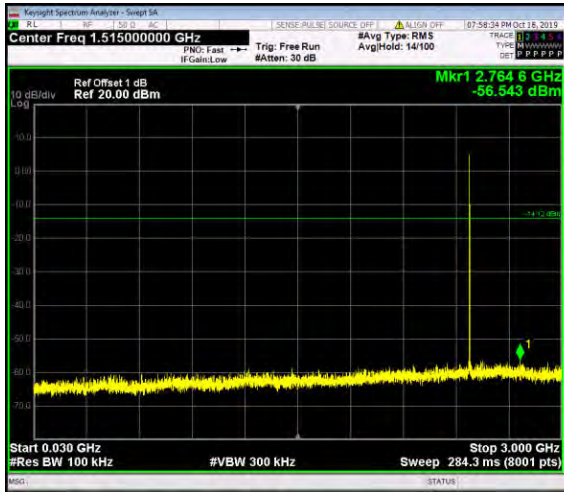

30MHz-3GHz

30MHz-3GHz

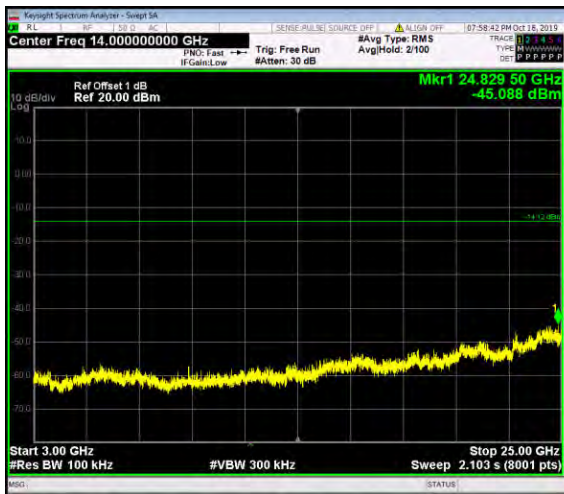

3GHz-25GHz

3GHz-25GHz



Reference

Reference

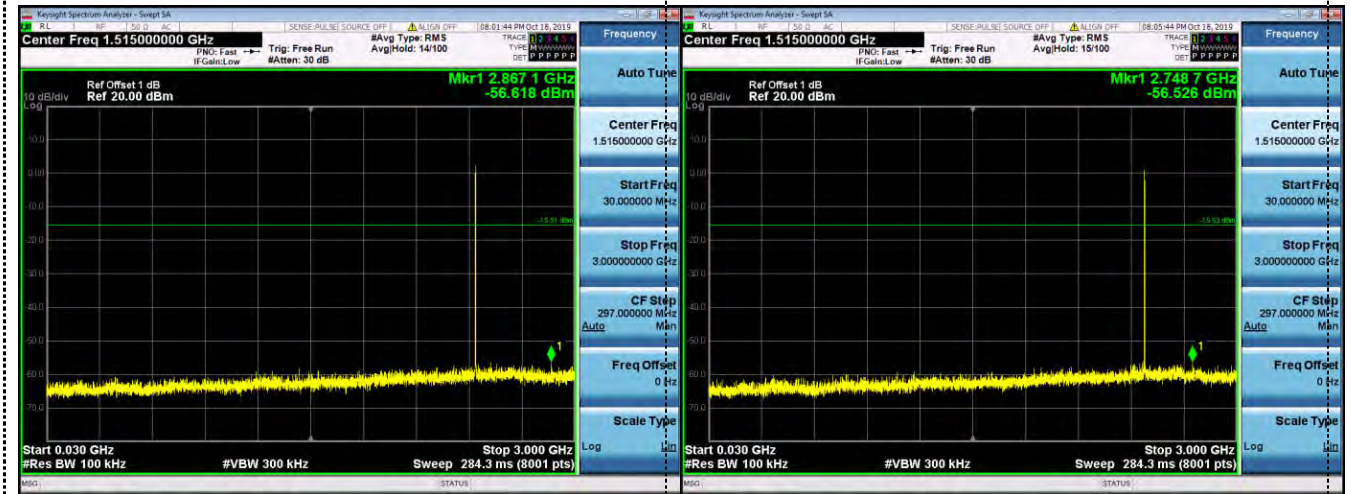

30MHz-3GHz

30MHz-3GHz

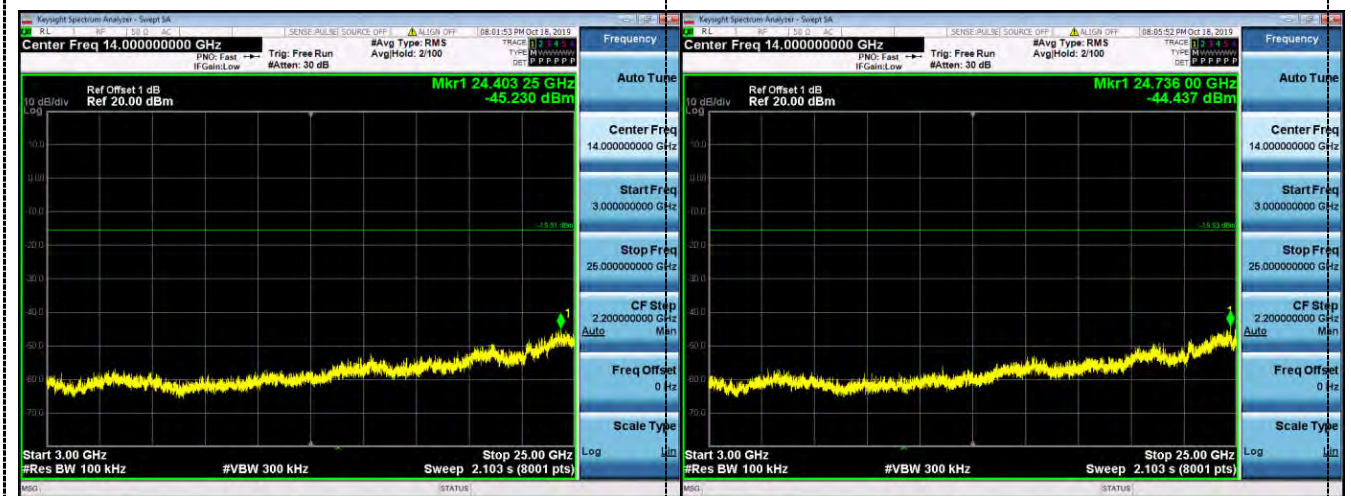

3GHz-25GHz

3GHz-25GHz

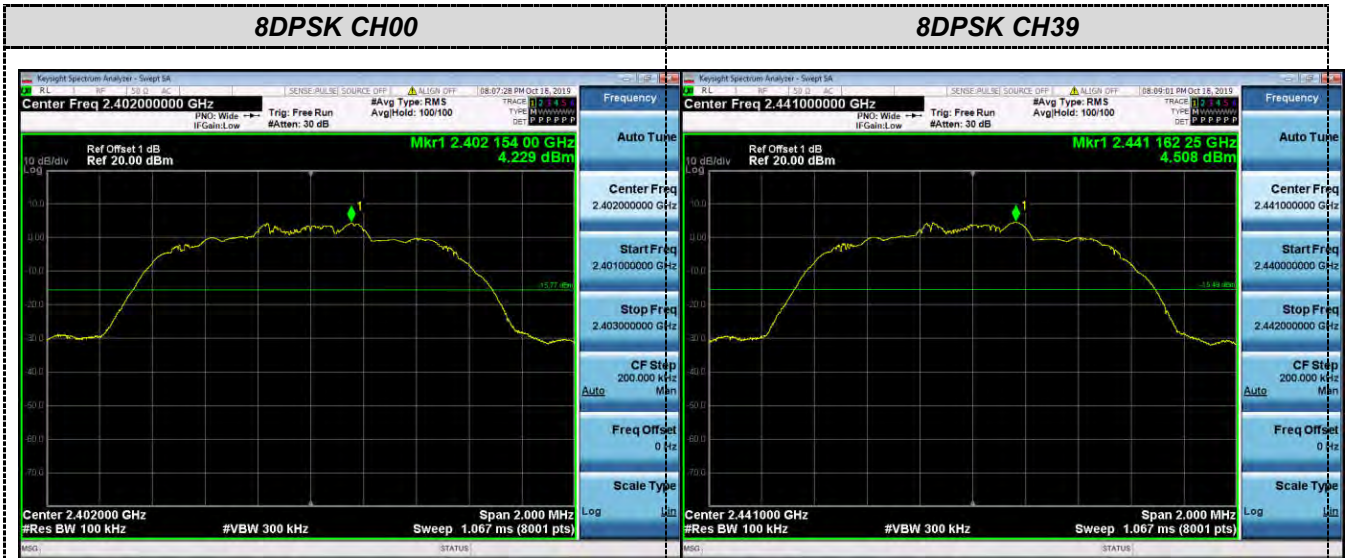

Reference

Reference

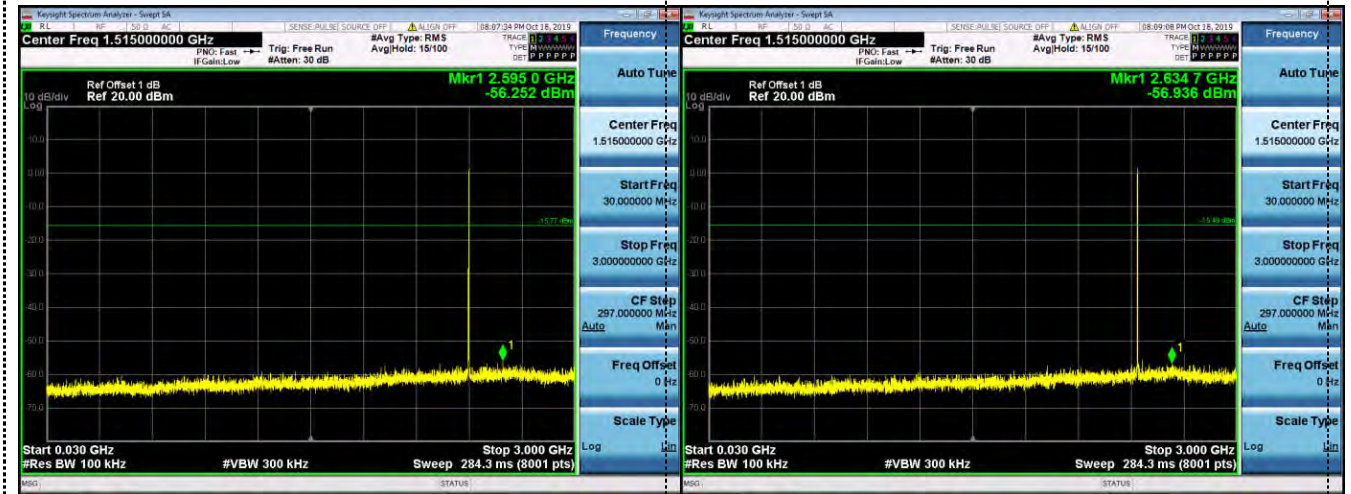

30MHz-3GHz

30MHz-3GHz

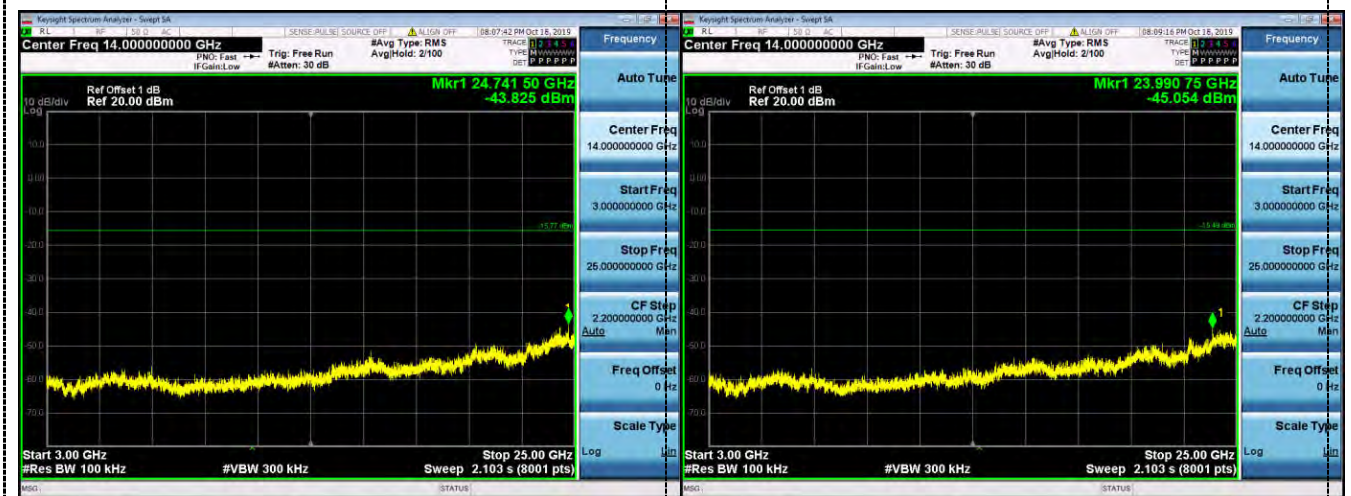

3GHz-25GHz

3GHz-25GHz

8DPSK CH78

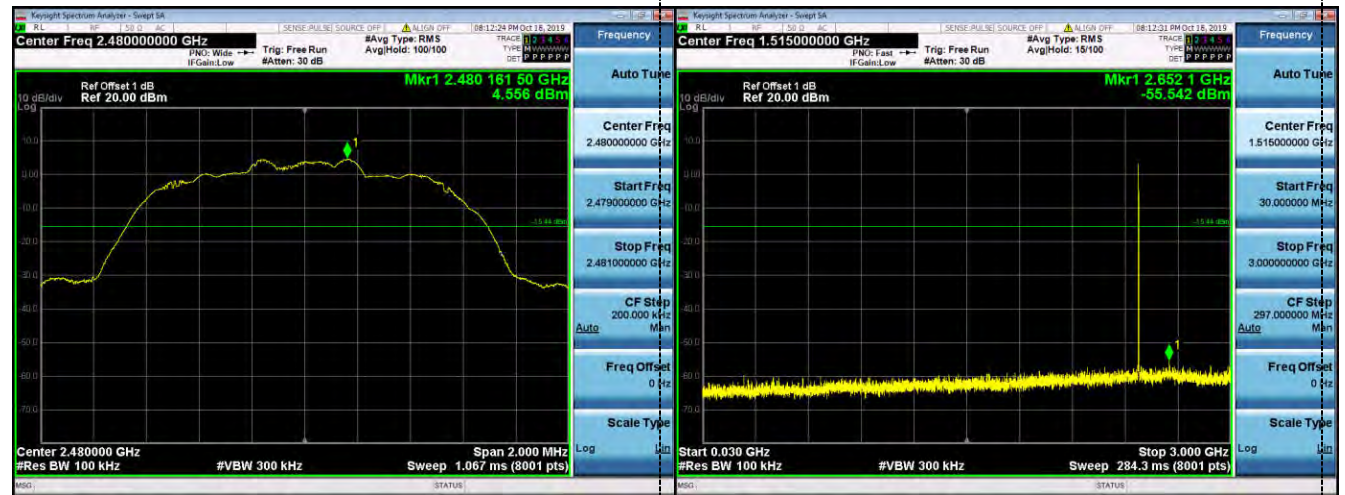

Reference

30MHz-3GHz

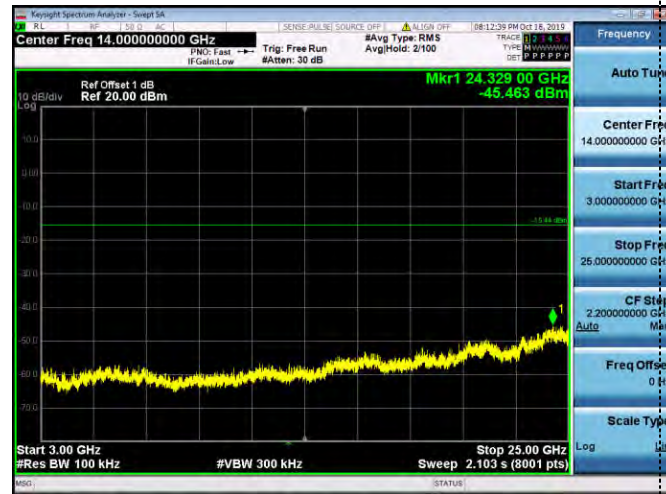

3GHz-25GHz

Band-edge Measurements for RF Conducted Emissions:

GFSK

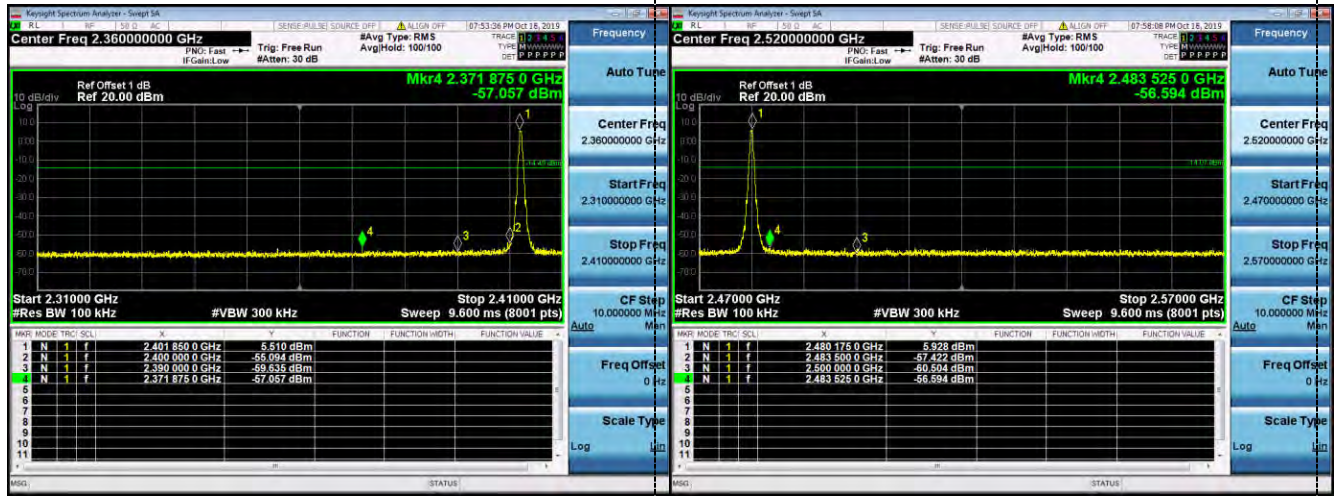

Left Band edge hopping off

Right Band edge hopping off



Left Band edge hopping on

Right Band edge hopping on

$\pi/4$ DQPSK

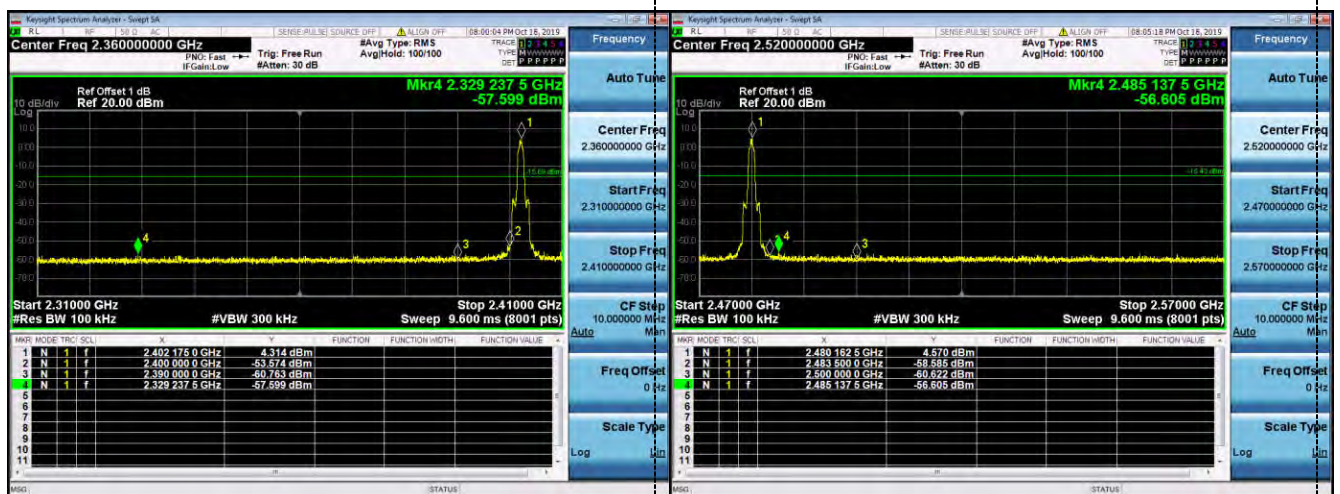

Left Band edge hopping off

Right Band edge hopping off

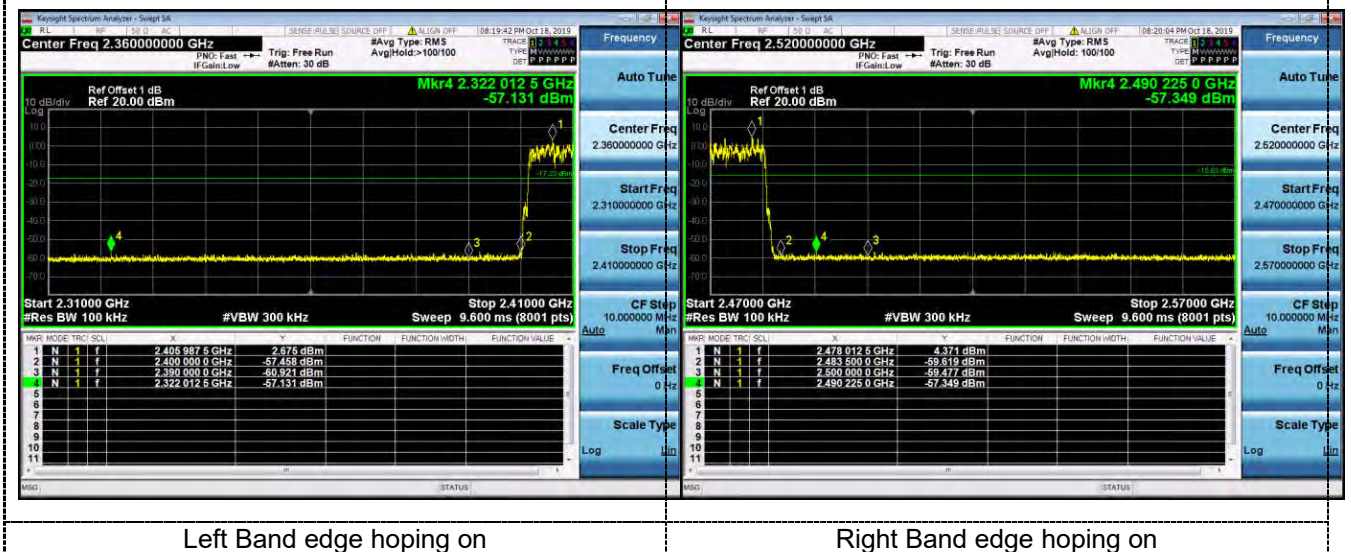
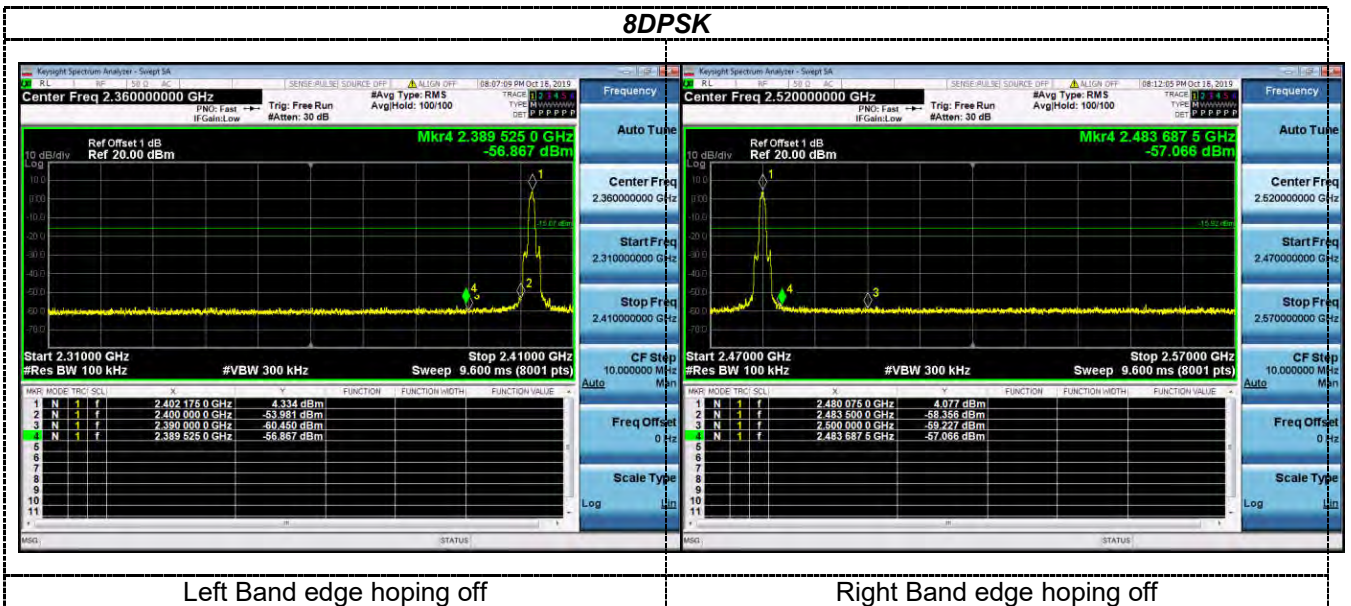
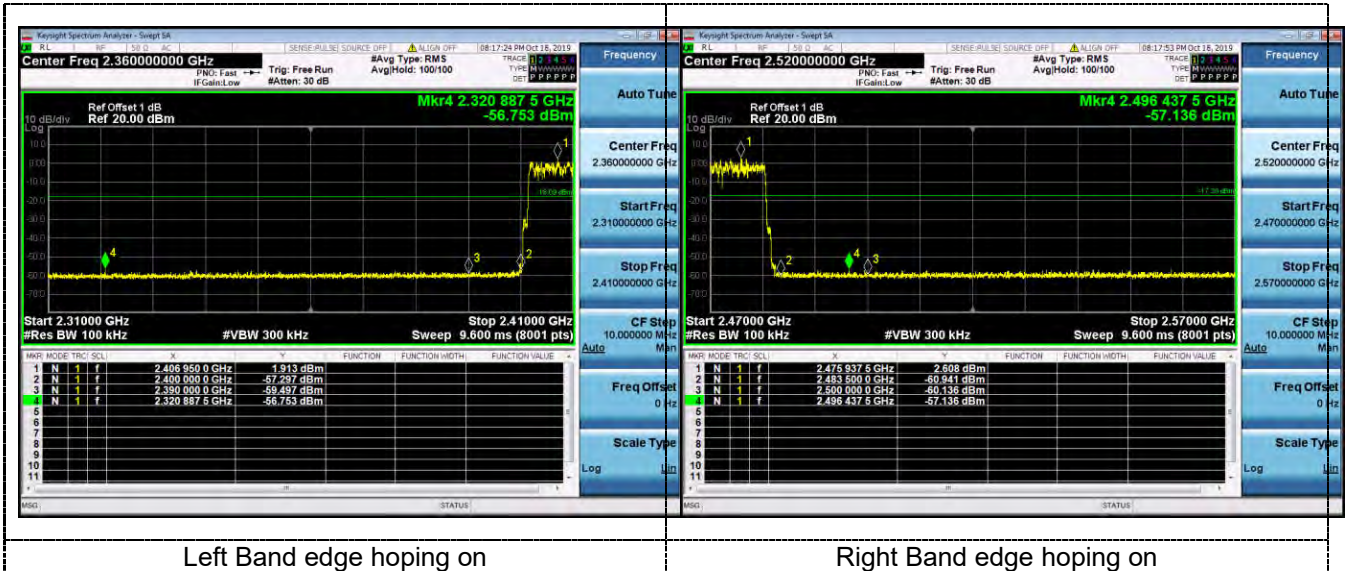

4.9 Pseudorandom Frequency Hopping Sequence

TEST APPLICABLE

For 47 CFR Part 15C section 15.247 (a) (1) requirement:

Frequency hopping systems shall have hopping channel carrier frequencies separated by a minimum of 25 kHz or the 20 dB bandwidth of the hop-ping channel, whichever is greater. Alternatively, frequency hopping systems operating in the 2400–2483.5 MHz band may have hopping channel carrier frequencies that are separated by 25 kHz or two-thirds of the 20 dB bandwidth of the hopping channel, whichever is greater, provided the systems operate with an output power no greater than 125 mW. The system shall hop to channel frequencies that are selected at the system hopping rate from a pseudo randomly ordered list of hopping frequencies. Each frequency must be used equally on the average by each transmitter. The system receivers shall have input bandwidths that match the hop-ping channel bandwidths of their corresponding transmitters and shall shift frequencies in synchronization with the transmitted signals.

EUT Pseudorandom Frequency Hopping Sequence Requirement

The pseudorandom frequency hopping sequence may be generated in a nine-stage shift register whose 5th and 9th stage outputs are added in a modulo-two addition stage. And the result is fed back to the input of the first stage. The sequence begins with the first one of 9 consecutive ones, for example: the shift register is initialized with nine ones.

- Number of shift register stages:9
- Length of pseudo-random sequence:29-1=511 bits
- Longest sequence of zeros:8(non-inverted signal)

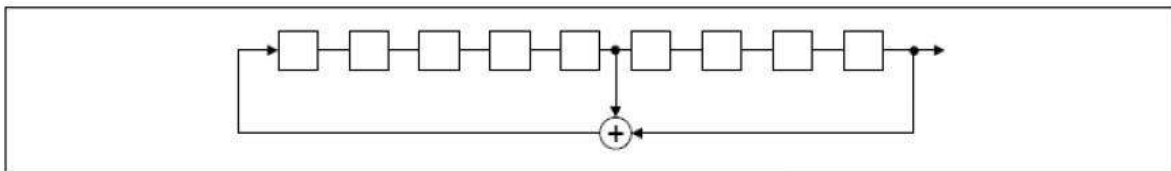

Linear Feedback Shift Register for Generation of the PRBS sequence

An example of pseudorandom frequency hopping sequence as follows:

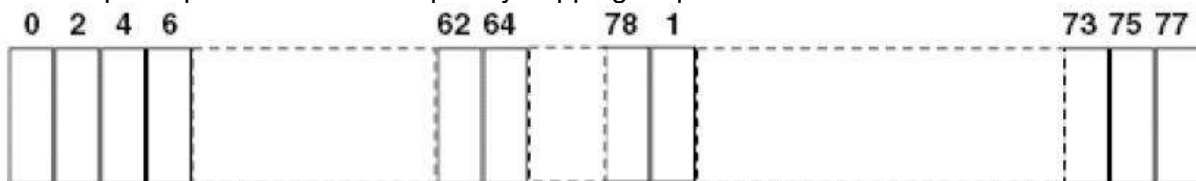

Each frequency used equally one the average by each transmitter.

The system receiver have input bandwidths that match the hopping channel bandwidths of their corresponding transmitter and shift frequencies in synchronization with the transmitted signals.

4.10 Antenna Requirement

Standard Applicable

For intentional device, according to FCC 47 CFR Section 15.203, an intentional radiator shall be designed to ensure that no antenna other than that furnished by the responsible party shall be used with the device.

And according to FCC 47 CFR Section 15.247 (c), if transmitting antennas of directional gain greater than 6dBi are used, the power shall be reduced by the amount in dB that the directional gain of the antenna exceeds 6dBi.

Refer to statement below for compliance

The manufacturer may design the unit so that the user can replace a broken antenna, but the use of a standard antenna jack or electrical connector is prohibited. Further, this requirement does not apply to intentional radiators that must be professionally installed.

Antenna Connected Construction

The maximum gain of antenna was 1.00dBi.

5 Test Setup Photos of the EUT



***** End of Report *****