



# Cetus X

FPV KIT

—— Cetus Flight Controller Version ——

## User Manual

Version No.1 2023-02-09



# Contents

<b>1.Product List</b> .....	3
<b>2.Preflight Checks</b> .....	4
<b>3.Quick Start Guide</b> .....	5
3.1 Quick Start .....	5
3.2 Flight Operations .....	7
3.3 First Person View (FPV) .....	9
3.4 On Screen Display (OSD) .....	9
3.5 Flight Modes .....	10
3.6 Battery Charging .....	11
<b>4.Remote Control Radio Transmitter</b> .....	13
4.1 Switch Functions .....	14
4.2 Joystick Functions .....	15
4.3 Button Functions .....	16
4.4 Charging the Remote Control Radio Transmitter .....	17
<b>5.FPV Goggles</b> .....	18
5.1 Button Operation .....	18
5.2 Frequency Selection .....	20
5.3 DVR Function .....	21
5.4 Charging the FPV Goggles .....	24
<b>6.Quadcopter OSD Menu Operation</b> .....	25
6.1 How to Access / Operate OSD Setting Menu .....	25
6.2 VTX Frequency and Power Switching .....	27

<b>7.LED Light / Beep Status Codes</b> .....	28
7.1 Quadcopter LED Light .....	28
7.2 Remote Control Radio Transmitter LED Light & Beep Status Codes .....	30
7.3 FPV Goggles LED Light Status Codes .....	31
<b>8.Advanced Settings</b> .....	32
8.1 Turtle Mode .....	32
8.2 Re-Bind for Quadcopter .....	33
8.3 Remote Control Radio Transmitter Calibration .....	34
8.4 Quadcopter Level Calibration .....	35
8.5 Turn OFF/ON the Optical Flow Positioning Function .....	36
8.6 Turn OFF/ON Laser Altitude Determination .....	37
8.7 Changing Video Transmitter Output Power .....	38
<b>9.Supplement</b> .....	39
9.1 Warning & Security .....	39
9.2 Precautions for Battery Use and Charging .....	39
9.3 After-Sale Service .....	40
<b>10.FAQ</b> .....	41
10.1 How to Replace Propellers .....	41
10.2 How to Fix Quadcopter Drift .....	41
10.3 How to Use FPV Simulator .....	43
10.4 How to Stop After A Collision .....	45

# 1. Product List

- 1 x Cetus X Brushless Quadcopter (Cetus Series Flight Controller, Frsky D8 Receiver)
- 1 x LiteRadio 3 Transmitter (Frsky D8)
- 1 x BEATFPV VR03 FPV Goggles

## Box Contents:

- 4 x BT2.0 450 mAh 1S Lipo Battery
- 1 x BT2.0 Battery Charger and Voltage Tester
- 1 x USB Charging Cable (Type-C)
- 1 x Type-C to FC Adapter
- 1 x Prop Removal Tool
- 4 x Gemfan 2020 4-Blades Prop (Spare Set)
- 1 x Portable Storage Bag

## 2. Preflight Checks

1. Check all parts are included according to product list. Ensure all parts are intact and the frame undamaged.
2. Ensure that propellers and motors are installed correctly and stably.
3. Ensure that propellers do not scratch against frame ducts and motors spin smoothly.
4. Ensure batteries (of quadcopter, remote control radio transmitter, and FPV goggles) are fully charged.
5. Be sure pilot is familiar with all flight controls. (Refer "Remote Control Radio Transmitter").
6. Always keep a safe distance in all directions around the quadcopter (1 meter or more) when having a test-flight. Operate the quadcopter carefully in open space.

## 3. Quick Start Guide

### 3.1 Quick Start

Before flying, verify that the remote control radio transmitter is successfully connected with the quadcopter, all basic controls are functional, and the quadcopter can be taken off normally.

Step 1: Take out the remote control radio transmitter and set the throttle joystick and two switches SB and SC on the top to the lowest position while ensuring that switches SA and SD are pop-up. Hold the power button on the remote control radio transmitter for 5 seconds until it beeps three times, and then release. When the remote control radio transmitter power indicator turns from flash red to solid blue, it means the transmitter has been successfully powered on.

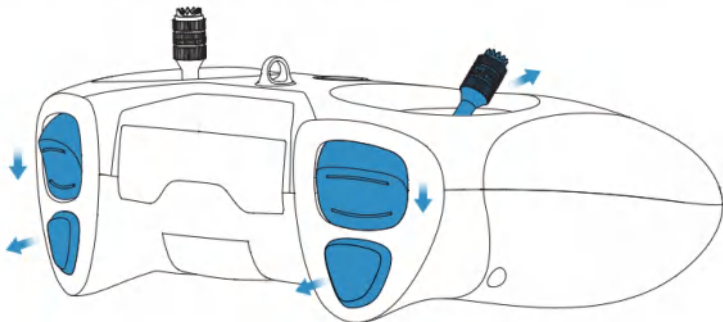

Set the Throttle, SB and SC to the Lowest Position and Ensure That Switches SA and SD Are Pushed Up

- Step 2: Install two batteries into the battery mounting slot under the quadcopter. Connect the quadcopter with the battery, and then place the quadcopter on a horizontal surface. Wait 3-5 seconds until its status LED lights to change from flashing blue to solid blue. This indicates that the initialization of the quadcopter is complete and the quadcopter is connected successfully with the remote control radio transmitter.

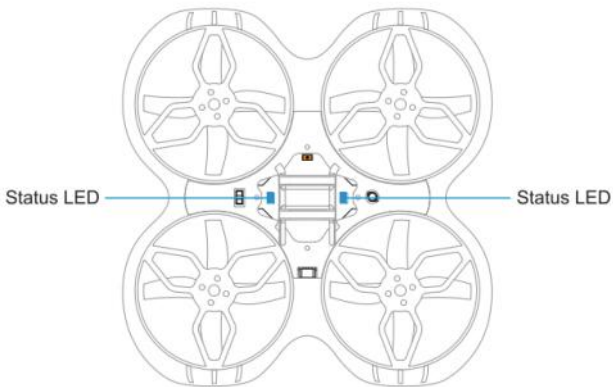

- Step 3: Press switch SA to arm the quadcopter. The throttle joystick must be at the lowest position or the quadcopter will not be armed. After being armed, the motors will spin slowly. Pressing SA again and making it push up will help disarm the quadcopter and motors.

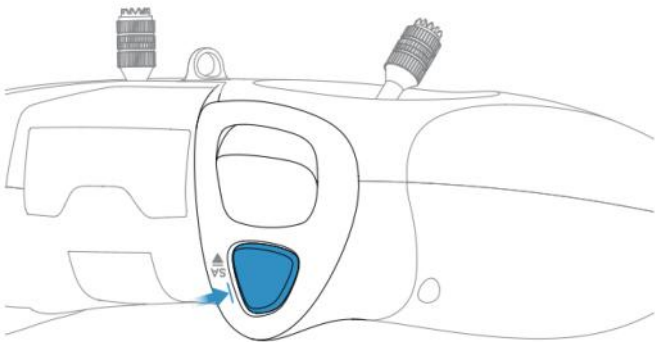

Press the Switch SA to Arm the Quadcopter

Complete above three steps to ensure that the quadcopter and the remote control radio transmitter can work normally. Then, the following flight operations can be continued.



## 3.2 Flight Operations

- Step 4: Re-arm quadcopter (step 3). Motors will spin at a low speed.

Throttle (left) Joystick:

Up/down controls the rate of ascent/ descent.

Left/Right controls counterclockwise/ clockwise rotation.



Joystick Up/Down

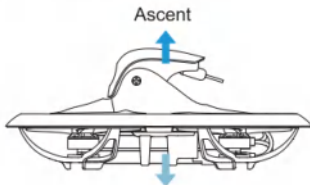

Decent

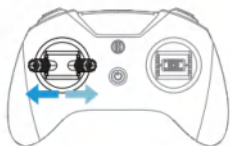

Joystick Left/Right



Direction (right) Joystick:

Up/down controls forward/ backward tilt (pitch).

Left/right controls left/ right tilt (roll).



Jotstick Up/Down

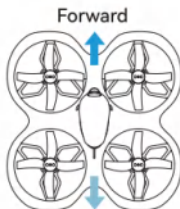

Backward

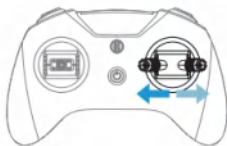

Joystick Left/Right

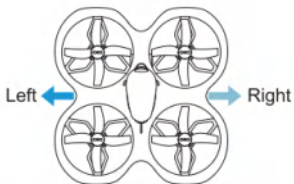

Before flying with goggles, it is recommended to practice and get familiar with the sensitivity of joysticks by following the above-mentioned operation steps.

*Caution:*

1. Find a suitable open place for the first flight.
2. Give a slow push to the joysticks, especially the throttle joystick.
3. If the quadcopter becomes out of control or collides with objects, press switch SA immediately to disarm, and motors will stop spinning.

• Step 5: Land quadcopter steadily and press switch SA to make it push up, which is shown as below:

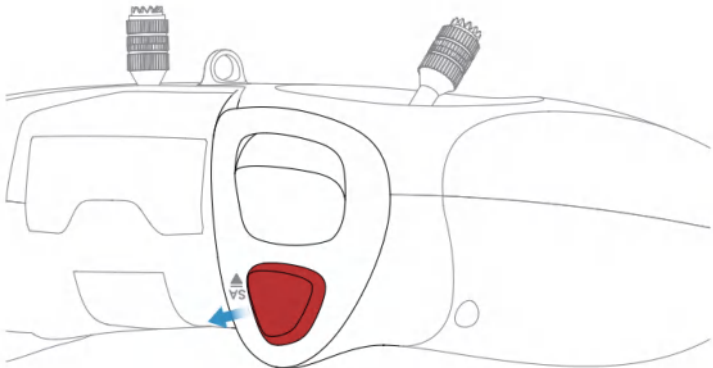

Press switch SA to pop-up status to disarm the drone

• Step 6: Disconnect the batteries with the quadcopter through removing it from the mounting slot. Holding the power button on the remote control radio transmitter and the remote control radio transmitter will stop work after three beeps.

### 3.3 First Person View (FPV)

First-person view (FPV) is to operate the quadcopter through the real-time image transmitted by FPV goggles' camera. Operations for starting goggles are shown as below:

- Take out the goggles and install the headband; Rotate the antenna to be vertical;
- Slide the power switch to the right. The screen lights up and the VR03 goggles are turned on;
- Long press the "S" button for 2-3 seconds to turn on the fast frequency search function. After 3 seconds, a beep will sound and the corresponding FPV cross-machine screen is displayed in the goggles, indicating that the frequency search is complete.

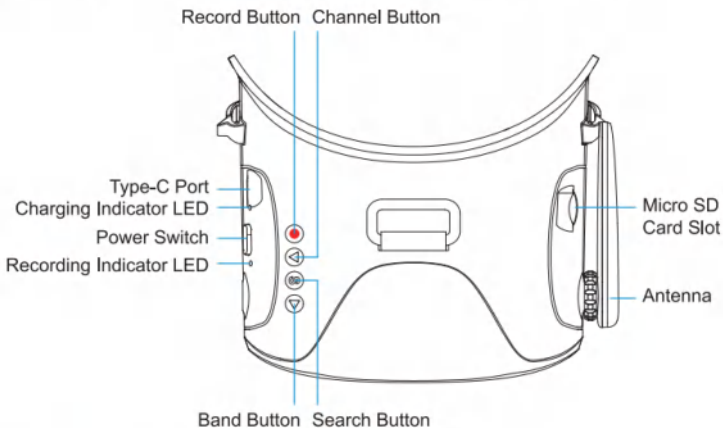

### 3.4 On Screen Display (OSD)

After the frequency search, flight information and FPV camera images will be shown on the display. This information is called On Screen Display (OSD), which is shown as below:

Status: Disarm

DISARM

V3.89  
00.00

S MODE  
SLOW

Flight Time

Quad Battery Voltage

Flight Mode

Speed Threshold

About OSD information:

- The flight status of the quadcopter is displayed in the center. DISARM indicates locked status. TURTLE indicates that the Turtle Mode is activated; LOW VOL indicates that the battery voltage of the quadcopter is low. RX LOSS indicates that the quadcopter has been disconnected with the remote control radio transmitter.
- Status of the quadcopter is displayed in the bottom of the screen, including the receiver protocol, quad battery voltage, flight time, flight mode, and speed threshold.

## 3.5 Flight Modes

The flight mode is displayed in the lower right corner of the flight screen, corresponding to the flight mode of quadcopter. Pilot can choose different flight modes according to different flight environments and their flight control skills.

1. Normal Mode: When the quadcopter ascends, center the two joysticks at the same time, and the quadcopter will maintain at a fixed point in a horizontal attitude. The position of the direction joystick controls the tilt direction and tilt angle of the quadcopter. The quadcopter has an auxiliary flight function that can assist in adjusting

the altitude and horizontal position, which makes it easier for pilot to control. N MODE is displayed in the OSD.

2. Sport Mode: When the quadcopter ascends, pilot needs to operate the throttle joystick to control and adjust the altitude of the quadcopter. The position of the direction joystick controls the tilt direction and tilt angle of the quadcopter. When the direction joystick is moved back to the center, the quadcopter will return to a horizontal attitude. The quadcopter has no auxiliary flight function, which makes the operation relatively difficult for pilot. S MODE is displayed in the OSD.

3. Manual Mode: When the quadcopter ascends, pilot needs to operate the throttle joystick to control and adjust the flight altitude. Position of the direction joystick controls the roll direction and the roll speed of the quadcopter. The quadcopter will maintain its current attitude when the direction joystick is moved to the center. The quadcopter has no auxiliary flight function, and the flight attitude and altitude are completely dependent on the pilot to control the quadcopter by the remote control radio transmitter, which makes the operation very difficult for pilot. M MODE is displayed in the OSD.

4. Turtle Mode: If the quadcopter crashes into the ground and the fuselage is flip, the turtle mode can be activated to reverse the motor and turn the quadcopter back to the front. When in use, the direction joystick is used to control the rotation of the motor to drive the blades to rotate in the reverse direction, thereby realizing the reverse rotation of the fuselage. TURTLE is displayed in the center of the OSD. For more details, please refer to the chapter "Advanced Settings-Turtle Mode".

The flight mode is selected by a switch on the remote control radio transmitter. For more details, please refer to the chapter "Remote Control Radio Transmitter-Switch Functions".

## 3.6 Battery Charging

Each battery provides 4-5 minutes of smooth flight. When LOW VOL is displayed in the OSD flight interface, which indicates that the battery is too low and needs to be charged.

Charging steps are shown as below:

- Plug the charger into the Type-C port through USB cable;
- Connect one or two batteries to the port on the right of the charger and the charger's LED will turn solid red while charging;
- When the charger's LED turns solid green, charging is complete.

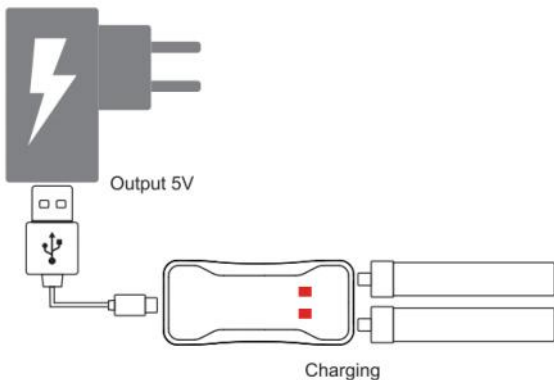

Two batteries can be charged at the same time. Charging a fully discharged battery takes approximately 20 minutes. When the battery is inserted into the TEST port and the charger is not plugged in via USB cable, the current battery level will be displayed. The number of 4.25-4.35 represents a fully charged battery while 3.30 or lower indicates a low battery.

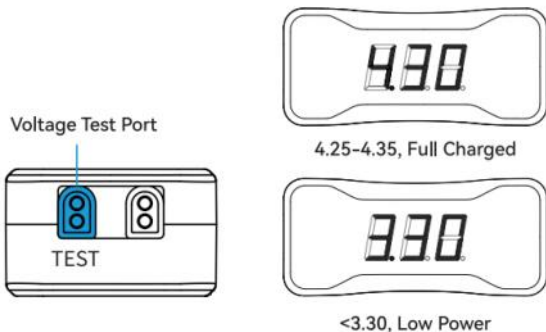

## 4. Remote Control Radio Transmitter

The remote control radio transmitter included in this kit is the LiteRadio 3 (Frsky D8). Indication of functions of button and switches is shown as below.

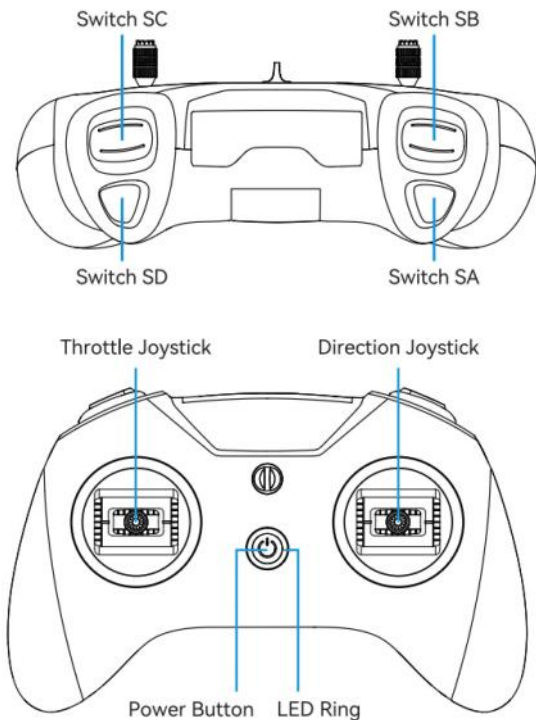

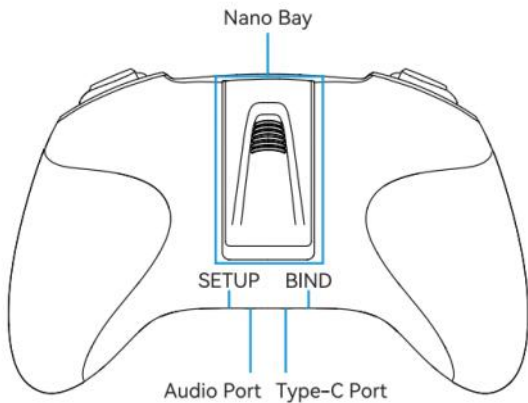

## 4.1 Switch Functions

Four switches are provided on the front of the remote control radio transmitter: switch SA, switch SB, switch SC, and switch SD, as shown below. Pilot can change different modes and parameters of the quadcopter with these switches. Please take notice that these switch can only work after the remote control radio transmitter is successfully connected to the quadcopter.

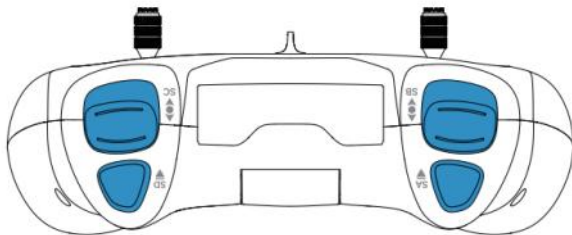

Switch SA: Arm/Disarm Quadcopter

- Quadcopter will be disarmed if switch SA is up.
- Quadcopter will be armed if switch SA is pressed.



Switch SB: Flight Mode of Quadcopter

- The flight mode is "Normal Mode" if switch SB is down (N MODE).
- The flight mode is "Sport mode" if switch SB is in the middle (S MODE).
- The flight mode is "Manual mode" if switch SB is up (M MODE).

Switch SC: Speed Threshold of Quadcopter

- It is low gear if switch SC is down (SLOW).
- It is middle gear if switch SC is in the middle (MID).
- It is high gear if switch SC is up (FAST).

*Note: When quadcopter is at "Manual Mode", only MID and Fast speed threshold options are available.*

Switch SD: Change Video Transmitter (VTX) frequency

Each time the switch SD is toggled, the quadcopter's video transmitter (VTX) frequency will switch to the next one. 8 frequencies are available. After switching to the last frequency(5866), frequency will cycle to the first one(5733) and start again.

*The factory default frequencies are 5733/5752/5771/5790/5809/5828/5847/5866 in sequence.*

Switch SD (Quadcopter in Flip State): Turtle Mode of Quadcopter

- Turtle Mode is on when Switch SD is pressed.
- Turtle Mode is off when Switch SD is up after the quadcopter is reverse back to the normal position.

## 4.2 Joystick Functions

Two joysticks (throttle&direction joysticks) on the front of the remote control radio transmitter control the quadcopter as following: Ascent/descent (throttle), forward/backward tilt (pitch), left/right tilt (roll), and rotation of flight direction(yaw).

Throttle (left) Joystick - Ascent/descent (throttle) and rotation of flight direction (yaw).



Joystick Up/Down

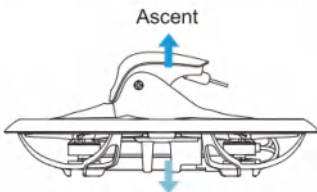

Decent

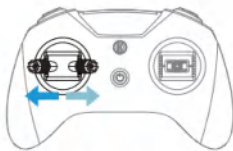

Joystick Left/Right



Counterclockwise  
Rotation

Clockwise  
Rotation

Direction (right) Joystick - forward/backward tilt (pitch) and left/right tilt (roll).



Joystick Up/Down

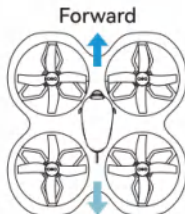

Forward

Backward

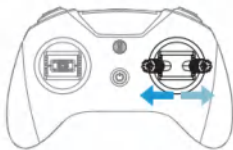

Joystick Left/Right

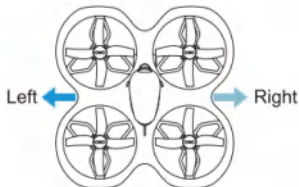

Left

Right

## 4.3 Button Functions

There are three buttons on the remote control radio transmitter.

- Power button: Turns the remote control radio transmitter on/off with a long press.
- BIND button: Enter binding mode with a short press when the remote control radio transmitter is powered on.
- SETUP button: Enter joystick calibration mode with a short press after the remote control radio transmitter is powered on.

Refer to “Advanced Settings” for more information on binding or joystick calibration.

## 4.4 Charging the Remote Control Radio Transmitter

The remote control radio transmitter has a built-in 2000mAh battery. External battery is not required. If LED ring breathes in red and beeps twice, it indicates that the battery is low and needs to be recharged. Steps to charge the remote control radio transmitter battery:

- Turn off the remote control radio transmitter;
- Connect remote control radio transmitter and adapter with the Type-C cable. (5V output adapter is allowed, such as mobile phone charger);
- The LED ring breathes in red means charging, while in green means fully charged.

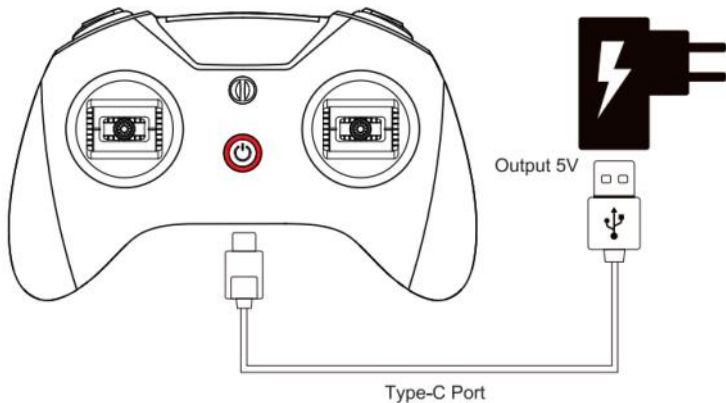

Note: Fast charging protocol is not supported. So radio transmitter can not be quickly charged.

# 5. FPV Goggles

The FPV goggles used in the kit is named model VR03. VR03 FPV goggles uses the external antenna and supports DVR recording.

## 5.1 Quadcopter LED Light

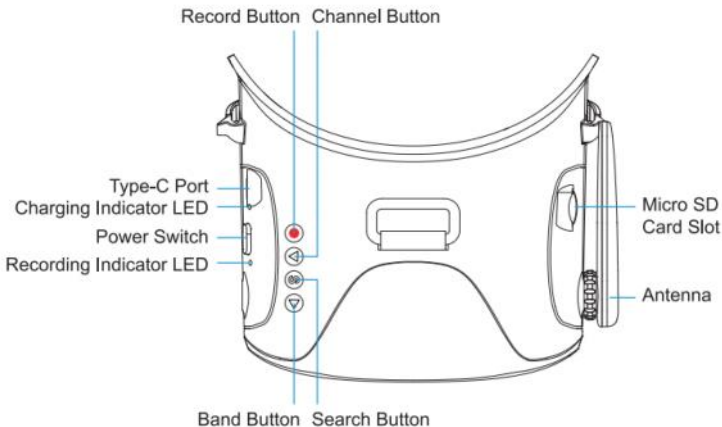

- **Power switch**

Turn the power switch left and right to turn the goggles off or on. When facing the switch, the left position is powered off, right position is powered on.

- **Search button (S)**

**Quick frequency search:** Press and hold the frequency search button for 2-3 seconds to activate frequency search. There will be a beep after 3 seconds, and the best available frequency will be selected. Quick frequency search is completed.

**Frequency scan:** Short press the frequency search key once to enter frequency scan interface.

Frequency Position Frequency RSSI Display Bar RSSI  
Coordinate

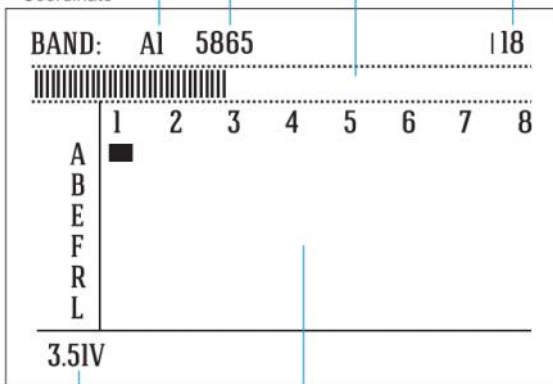

Goggles Voltage Frequency Scanning Results Table

Press and hold for 2-3 seconds to activate frequency scan, result will be displayed after 3 seconds. The different colors in the screen indicate the current status of each frequency as follows:

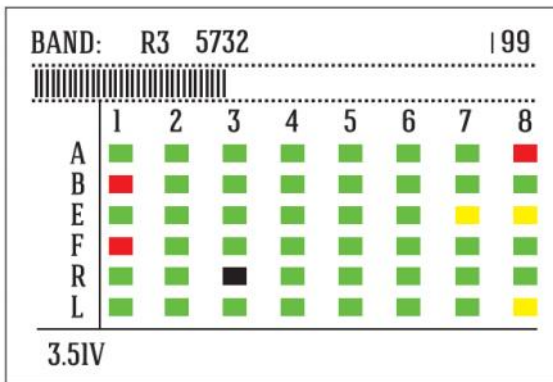

Green	0<RSSI<20 Frequency is available
Yellow	20<RSSI<70 Frequency has moderate interference from another transmitter
Red	70<RSSI<90 Frequency is completely in use by a transmitter
White	The strongest signal which the goggles received in this scan

- Band Key and Channel Key

In the frequency scan interface, the Band Key can be cycled down to select different bands, and the Channel Key can be cycled to the right to select different channels.

Pilot can select the goggles frequency by pressing the Band Key and Channel Key.

For example, select a band and channel with green status since these frequencies are not occupied and signal interference is relatively weak. Then, set the quadcopter to the corresponding frequency and adjust the goggles to match.

## 5.2 Frequency Selection

The FPV goggles can receive 48 frequency points in the 5.8GHz spectrum, distributed across 6 bands (A, B, E, F, R, and L) of 8 channels (CH-1, ....., CH-8), as shown below:

*The stock quadcopter included in this kit only uses 8 frequency points of band B, which is the second row in the table below:*

	CH 1 (MHZ)	CH 2 (MHZ)	CH 3 (MHZ)	CH 4 (MHZ)	CH 5 (MHZ)	CH 6 (MHZ)	CH 7 (MHZ)	CH 8 (MHZ)
A	5865	5845	5825	5805	5785	5765	5745	5725
B	5733	5752	5771	5790	5809	5828	5847	5866
E	5705	5685	5665	5645	5885	5905	5925	5945
F	5740	5760	5780	5800	5820	5840	5860	5880
R	5658	5695	5732	5769	5806	5843	5880	5917
L	5362	5399	5436	5473	5510	5547	5584	5621

Press and hold the Search Key for 1 second to automatically search for the frequency point with the strongest signal strength in the space to obtain the FPV picture of the quadcopter.

We can also shortly press the Band Key to switch to the designated band and use the Channel Key to switch to the designated channel so that the FPV goggles can work on the designated frequency point.

## 5.3 DVR Function

VR03 FPV goggles support video recording function, short press the record button to start or stop video recording.

- Insert the micro SD card into the micro SD card slot, FAT32 format only and maximum 64G;
- After short pressing the record button, a red dot will appear in the upper left corner, and there will be a "beep-beep" sound from FPV goggles;
- Wait for 8 seconds and the red dot will start flashing. At the same time, a line of red numbers appears and the timer starts running, the recording indicator LED starts flashing, indicating the start of recording;
- Short press the record button. After 2-3 seconds the red dot on the upper left corner stop flashing together with the timer being vanished, and the red record LED indicator also turns off. This indicates the goggles has stopped recording.

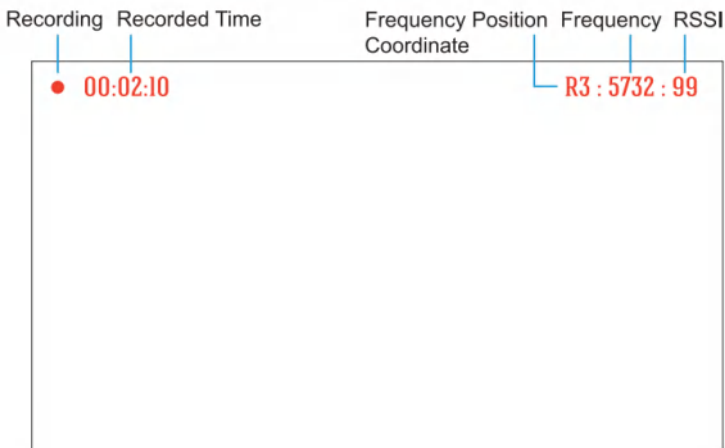

*Note: After pressing the record button, the DVR recording function will take about 8-10 seconds to be activated, please wait in patience.*

*Note: The maximum duration of each recording is 10 minutes. When a recording exceeds 10 minutes, a new recording file will be created automatically.*

FPV goggles supports DVR replay function, operating steps are listed as follows:

- Ensure Micro SD card has been inserted into the slot, with recording files in the card;
- Long press the record button for 2-3 seconds and there user will hear three beeping sounds. "LOADING DVR..." will appear on the screen;
- Wait about 8-10 seconds depending on the file size to finish loading and enter the DVR interface;
- After entering the DVR interface, button functions are redefined and explained by image shown below;
- Long press the record button for 2-3 seconds in the DVR interface again to exit.

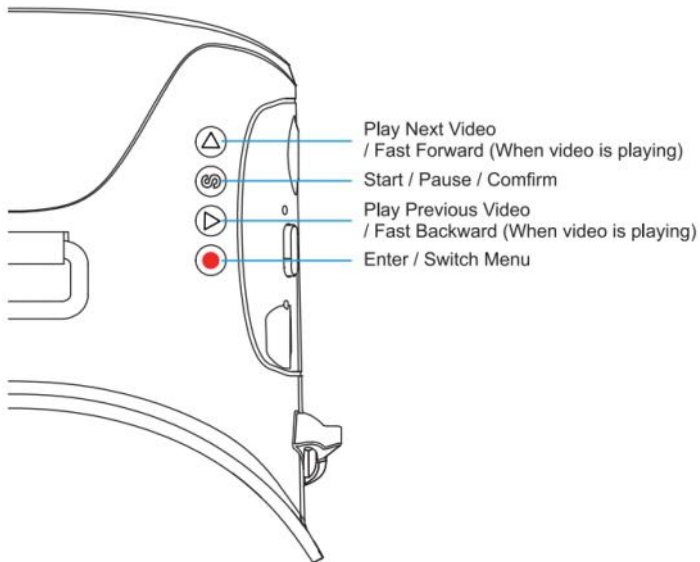



Use the above buttons on the goggles to perform switching videos, Play or Pause, Fast Forward or Fast Backward, etc.

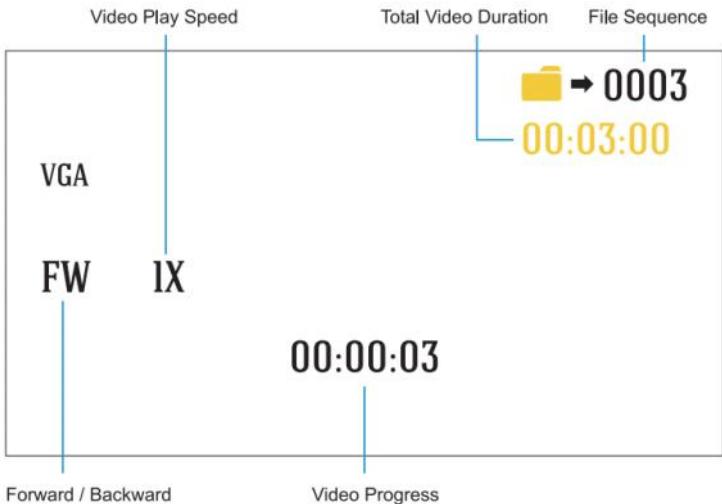

*Note: After pressing the record button, the DVR recording function will take about 8-10 seconds to be activated(Entering DVR interface), please wait in patience.*

## 5.4 Charging the FPV Goggles

The FPV goggles have a built-in 2000mAh battery and no external battery is required. When voltage is below 3.4V, there will be a beep every 10s and this indicates the battery needs to be recharged. User can also press the S button to check the voltage. Steps to charge the goggles battery is as follows:

- Switch off the FPV goggles;
- Connect FPV goggles and adapter with the Type-C cable (5V output adapter is allowed, such as mobile phone charger);
- The power light will be blue when charging and lights out when fully charged.

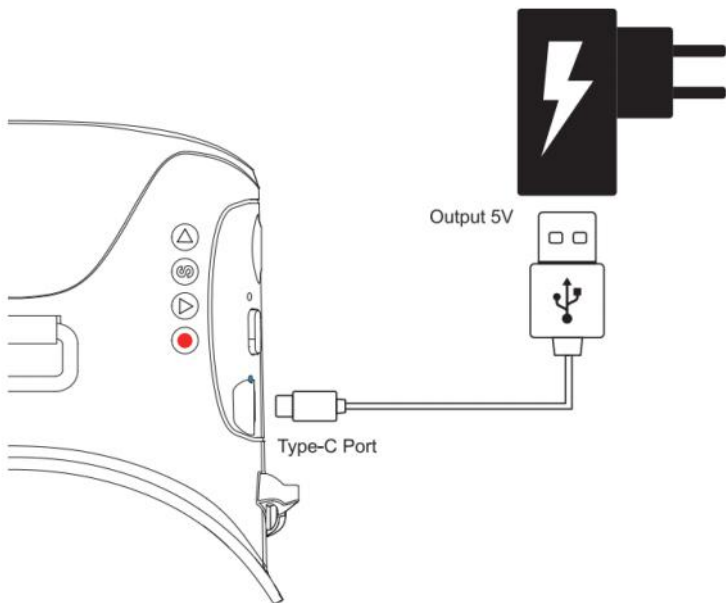

*Note: Fast charging protocol is not supported. So FPV goggles can not be quickly charged.*

## 6. Quadcopter OSD Menu Operation

The OSD menu is a set of operation interfaces designed to modify the configuration of the quadcopter. It's most used functions are switching the VTX frequency and output power .

### 6.1 How to Access/Operate OSD Setting Menu

The position of joysticks to access the OSD setting menu is as shown below. The throttle joystick is moved to the left-center and the direction joystick towards the upward center.

*Caution: Make sure the quadcopter is disarmed before accessing the OSD menu.*

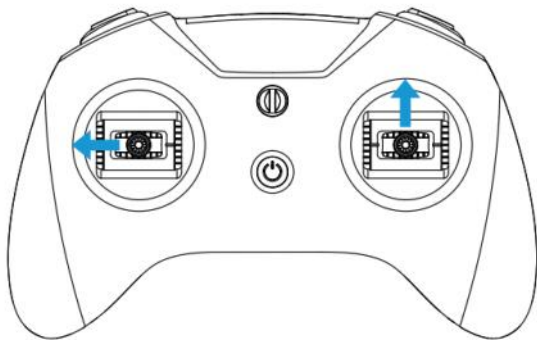

← Throttle Joystick Left

↑ Direction Joystick Up

After accessing the OSD menu, pilot will see the following menu interface on the FPV screen.

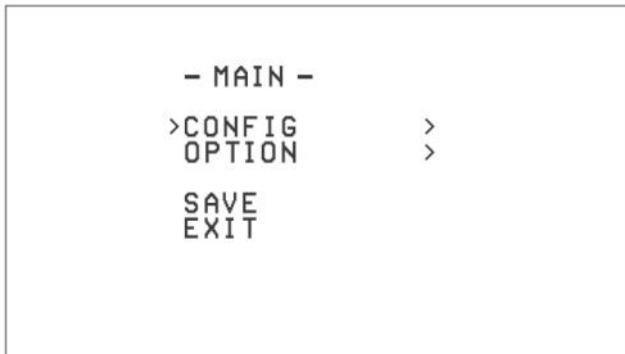

The OSD menu cursor can be controlled by the right joystick to operate in OSD interface:

- Up: move the cursor up
- Down: move the cursor down
- Right: confirm/modify selection

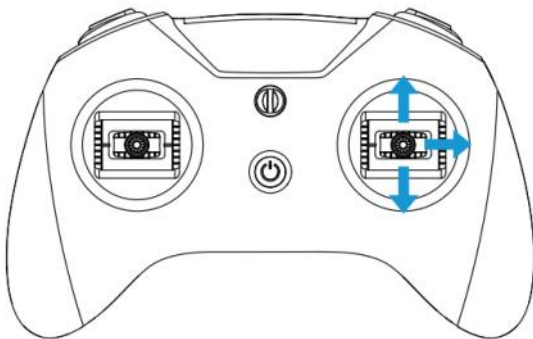

↑ Joystick Up:  
Cursor Move Up

↓ Joystick Down:  
Cursor Move Down

→ Joystick Right:  
Modification/Confirmation

## 6.2 Turn Quadcopter RGB LED ON/OFF

The quadcopter status LED light is normally solid blue when flying. This can be changed to color cycling:

- In the MAIN menu, select CONFIG and enter the CONFIG menu, as shown below;
- Select LED, select OFF (for solid blue) or ON (for RGB color cycling effect);
- Select BACK to exit CONFIG sub-menu;
- Select SAVE in the MAIN menu to save changes and exit the OSD.

- CONFIG -

TOF	OFF
OPF	ON
>LED	OFF
CALI	OK
VTX	FCC
POWER	350MW
BACK	

# 7. LED Light / Beep Status Codes

## 7.1 Quadcopter LED Light

There is a blue LED light and a green LED light on the flight controller. It is used to indicate whether the quadcopter is powered on normally and various status of the quadcopter.

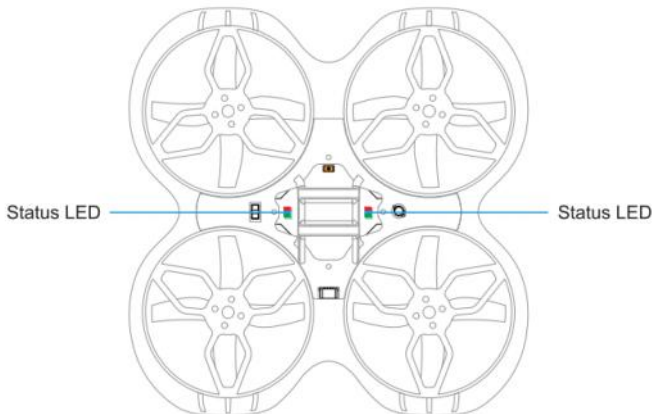

Status LED color	Status	State description	Solution
—	Off	The power on the quadcopter is abnormal or off	Replace the battery and power on again
Red	Flashing slowly	Quadcopter battery is low	Replace the battery
Blue	Solid	The quadcopter is connected with the remote control radio transmitter	
Blue	Flashing fast	Quadcopter is horizontal calibrating	Place the quadcopter on a horizontal surface and wait for a while
Purple	Solid	Quadcopter accessed the OSD menu	
Green	Flashing fast	Quadcopter is in binding mode	
White	Flashing fast	Arming failed, because the throttle joystick was not at the lowest position when arming	Disarm, and place the throttle joystick at the lowest position
Brown	Flashing slowly	Loss of remote control radio transmitter signal	Re-establish the connection with the remote control radio transmitter

## 7.2 Remote Control Radio Transmitter LED Light & Beep Status Codes

There is a blue & red LED indicator light around the power button which indicates the status of the remote control radio transmitter.



Indicator LED color	Status	State description	Solution
Red	Solid	Throttle joystick is not at the lowest position when starting	Move throttle joystick to the lowest position
Red	Flashing fast	Remote control radio transmitter is in binding mode	Wait for binding
Red	Flashing slowly	Battery voltage is too low	Charge remote control radio transmitter

There is a built-in beeper, pilot can recognize the working status of the remote control radio transmitter by its sound.

Beep	State description
The buzzer alarms twice: di-di	Low battery



## 7.3 FPV Goggles LED Light Status Codes

The FPV Goggles have a blue LED which indicates battery charging status, and a red LED which indicates DVR recording status.

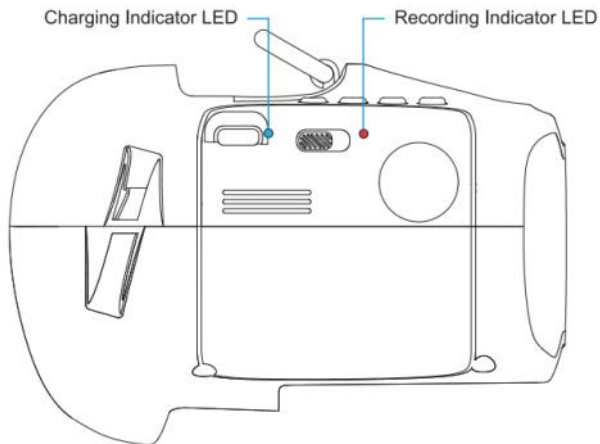

The status codes of the blue charging indicator LED are as follows:

Status	State description
Solid On	Charging
Off	Not charging or charging is complete

The status codes of the red recording indicator LED are as follows:

Status	State description
Flashing	Recording
Solid	DVR recording does not start

## 8. Advanced Settings

Additional advanced settings are available in case of special operations.

### 8.1 Turtle Mode

When the quadcopter falls to the ground and is facing down, we can activate turtle mode with the remote control radio transmitter to turn it over. To activate turtle mode:

- Toggle switch SD pressed to activate turtle mode. TURTLE is displayed in the OSD, as shown below;
- Move the direction joystick towards either direction. The motor will spin, and the quadcopter will reverse;
- Toggle switch SD pop up to turn off turtle mode;
- Arm the quadcopter and operate normally.

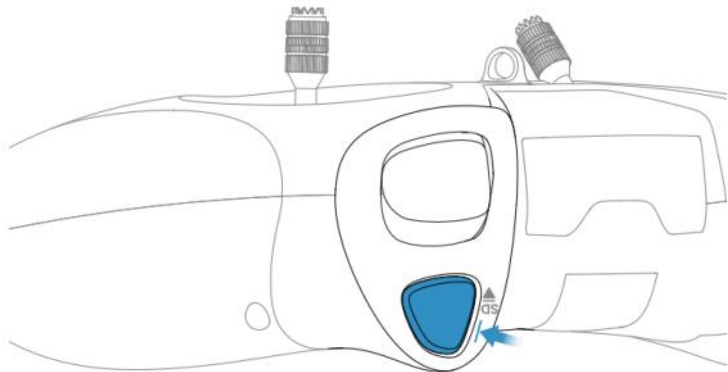

Toggle the Switch SD Pressed to Activate the Turtle Mode

*Note: Turtle mode is suitable for flat ground and it's not recommended to activate this mode on grass or fabrics as the motor may be obstructed, resulting in damage of the motors and ESC.*

## 8.2 Re-Bind for Quadcopter

If quadcopter and remote control radio transmitter cannot be connected successfully, the pilot may need to re-bind. This can happen when replacing new electronic parts of the quadcopter during maintenance or upgrading the remote control radio transmitter. The steps are as follows:

- Power on the quadcopter and wait for its system to load completely;
- Use a screwdriver to lightly press the button on the quadcopter and the status light on the quadcopter turns green and starts to flash;
- Power on the remote control radio transmitter and wait for its system to load completely;
- Lightly press the BIND button on the back of the remote control radio transmitter with a screwdriver. The power indicator will flash red;
- If re-bind is successful, quadcopter status light will change to blue.

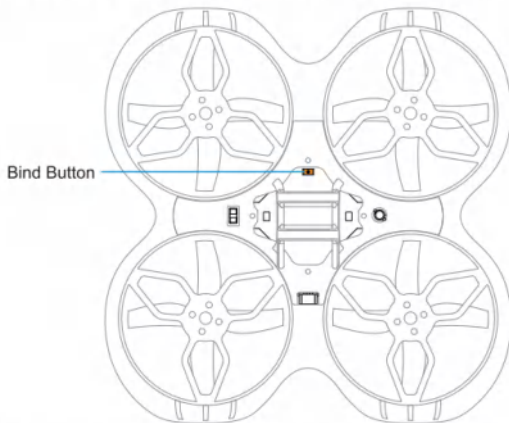

*Note: The re-binding of the remote control radio transmitter and the quadcopter may not be successful after pressing the BIND button of the remote control radio transmitter once. In this situation, pilot needs to press the BIND button a second time to complete the binding.*

## 8.3 Remote Control Radio Transmitter Calibration

After repeated use or if the remote control radio transmitter is subjected to physical impact, the joysticks may no longer read correctly and require recalibration. Calibrating the joystick value can ensure that its joystick value is in the neutral position.

- After powering on, press the SETUP button on the back of the remote control radio transmitter which will beep twice, and red LED flashing fastly(twice at a time). The remote control radio transmitter has entered calibration mode.
- Move throttle joystick and direction joystick to middle position. Press SETUP button again and wait until the remote control radio transmitter beeps three times. The red LED flashing fastly(twice at a time). This indicates joysticks center data has been acquired and enter boundary data calibration.
- Toggle the joystick to move to the top, bottom, left, and right joystick boundaries respectively (do not press too hard, the joystick just needs to touch the boundary) and keep the position for 1-2S, then press the SETUP button one more time, we can hear a long beeping sound (about 3 seconds) from the buzzer again, and the red LED light stops flashing, indicating that the calibration of the joystick is completed.

## 8.4 Quadcopter Level Calibration

After the quadcopter has taken off and landed several times, the quadcopter gyroscope may become offset. This will cause the quadcopter to always tilt in the same direction during a flight. To fix up it, the quadcopter gyroscope can be recalibrated. The steps are as follows:

- Turn on the quadcopter and the remote control radio transmitter, and ensure that the connection is successful;
- Place the quadcopter on a horizontal plane;
- Enter the quadcopter's OSD menu (Refer "OSD Menu Operation");
- In the MAIN menu, select CONFIG, then CALI;
- Push the direction joystick to the right to enter level calibration mode. Quadcopter's LED flashes blue;
- When the OK prompt appears and the LED returns to solid blue, the calibration is complete. Pilot can exit the OSD menu.

```

- CONFIG -
TOF                OFF
OPF                ON
LED                OFF
>CALI              OK
VTX                FCC
POWER              350MW
BACK
```

*Note: For more information about how to access and operate OSD menu, please refer to the Chapter "OSD Menu Operation".*

## 8.5 Turn OFF/ON the Optical Flow Positioning Function

In Normal Mode, the optical flow positioning function of Cetus X quadcopter is turned on by default, which provides an auxiliary function for horizontal flight. It will bring a better flying experience in an environment with more obvious ground features and sufficient light.

The steps to turn off/on the optical flow positioning function are as follows:

- Operate the remote control radio transmitter to access the OSD setting menu;
- In the MAIN menu, select CONFIG and access the CONFIG menu, as shown below;
- Select OPF and change it to OFF (turn off positioning)/ON (turn on positioning), and then select BACK to exit the CONFIG sub-menu;
- Select SAVE in the MAIN menu to exit the OSD setting interface.

- CONFIG -

TOF	OFF
>OPF	ON
LED	OFF
CALI	OK
VTX	FCC
POWER	350MW
BACK	

## 8.6 Turn OFF/ON Laser Altitude Determination

In Normal Mode, the laser altitude determination function is turned off by default. Turning on this function can make the hovering of the quadcopter more accurate and the quadcopter can maintain a fixed relative height with ground objects to achieve autonomous obstacle avoidance and lifting. The steps to turn off/on the laser altitude determination are as follows:

- Operate the remote control radio transmitter to access the OSD setting menu;
- In the MAIN menu, select CONFIG and access the CONFIG menu, as shown below;
- Select TOF and change it to OFF (turn off function)/ON (turn on function), and then select BACK to exit the CONFIG sub-menu;
- Select SAVE in the MAIN menu to exit the OSD setting interface.

- CONFIG -

>TOF	OFF
OPF	ON
LED	OFF
CALI	OK
VTX	FCC
POWER	350MW
BACK	

## 8.7 Changing Video Transmitter Output Power

The video transmitter power output is highest 350mW option available. It does not support changing to different power output using button, please change it in the OSD menu. Steps to change the video transmitter output power is as follows:

- Use the radio to enter OSD menu interface. (Please refer to "How to Access/Operate OSD Setting Menu")
- In MAIN interface menu, select CONFIG to enter CONFIG interface, as shown in diagram above;
- Select POWER, there are 5 output power options available:  
PIT/25mW/100mW/200mW/350mW.
- After selecting the desired power output option, select BACK to exit CONFIG sub-menu and press SAVE in the MAIN menu to exit OSD menu interface.

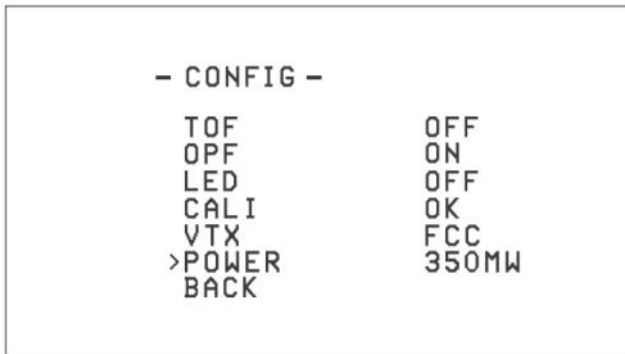

*Note: The valid distance is under 40cm in the PIT mode.*



# 9. Supplement

## 9.1 Warning & Security

- Move the throttle joystick as gently as possible to avoid the quadcopter ascending and descending too suddenly.
- Press switch SA on the remote control radio transmitter immediately if the quadcopter collides with any object.
- Please try to keep motors perpendicular to the body. Otherwise, flight performance will be degraded.
- Learn to control the quadcopter proficiently before flying in a large outdoor area or with the wind.
- Battery life can be significantly reduced if pilot continues to fly after the low voltage warning is shown.
- Do not fly in rain. Humidity may cause unstable flight or loss of control.
- Keep the battery away from water. If the flight controller touches water, a short circuit may occur and the flight controller may burn out.
- Do not fly in inclement weather with thunderstorms or lightning.
- Do not fly in areas that are not permitted by local law.

## 9.2 Precautions for Battery Use and Charging

- Do not immerse the battery in water. Store in a dry area if not used for a long time.
- Keep away from children. If swallowed, seek medical attention immediately.
- Do not use or store the battery near heat sources, microwave ovens, or open flames.
- Only use a battery charger that meets the specifications when charging.
- Do not throw the battery into fire or heat the battery.
- Do not use or store the battery in an extremely hot environment, such as in a car under direct sunlight or hot weather. Overheating affects the performance of the battery and shortens the service life of the battery. Overheated batteries can catch fire.
- If the battery has a peculiar smell, temperature, deformation, discoloration, or any other abnormal phenomenon, stop using the battery. Recycle and replace the battery.
- If the battery connector gets dirty, please wipe it with a dry cloth before use. Avoid getting battery contacts dirty, which can cause energy loss or failure to charge.
- Disposing of the battery randomly may cause a fire. Please fully discharge the battery and use insulating tape to dispose of the battery output connector before disposing of

the battery. Refer to local regulations before disposing or recycling a battery.

## 9.3 After-Sale Service

- **Warranty:** All defective merchandise, unless otherwise indicated, may be returned for a replacement within 30 days from the date of goods received. We cannot provide refunds or replacements beyond 30 days.
- If the product is confirmed to have a quality problem (product design or quality issues), we will cover it with replacing or refund.
- All warranty replacements are required to have photos or videos and a detailed description. The warranty does not cover physically damaged merchandise. We are willing to figure out the best solutions, as always.
- For after-sale service, please reach out via e-mail: [support@betafpv.com](mailto:support@betafpv.com)

*This clause only applies to the products manufactured by BETAFPV and sold by BETAFPV authorized dealers.*

*The specific interpretation rights of this clause belong to BETAFPV.*

# 10. FAQ

## 10.1 How to Replace Propellers

Propellers can be deformed or fall off when a quadcopter collides with an object. Bent or missing propellers need to be replaced.

Use the included propeller removal tool to remove propellers from the motor. Please hold the motor instead of the frame duct with your hand when removing propellers to protect the frame from being deformed by overexertion.

4pcs spare propellers are included; 2pcs clockwise (CW) and 2pcs counterclockwise (CCW). Install as in the diagram below.

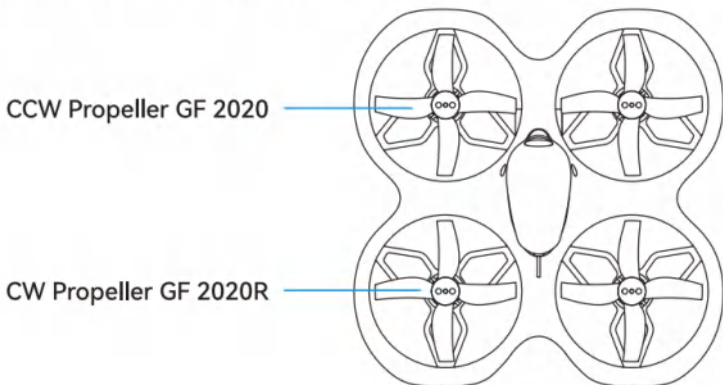

## 10.2 How to Fix Quadcopter Drift

In Normal Mode, the optical flow positioning function of Cetus X quadcopter is turned on by default. When the drone starts to drift, here is a checklist you should look for to understand why your drone drift sideways and how to fix them.

1. Check motor obstructs, uneven weight distribution, and loose or damaged propellers.
2. Try to avoid an unsatisfactory environment of which ground features are difficult to

identify. Otherwise, the quadcopter may drift or become difficult to control. The following are common unsatisfactory environments:

- Dimly-lit;
- Above the water surface;
- Above smooth tiles or single-color smooth ground.

If the quadcopter needs to fly in an unsatisfactory environment, the optical flow positioning function can be turned off and the quadcopter will lose the auxiliary function of horizontal flight. This requires pilot's better skills.

For the steps to turn off/on the positioning function or laser altitude determination function, please refer to the chapter of "Advanced Functions".

3. Recalibrate the drone manually in the OSD menu. The process of calibrating the drone means correcting errors because some sensors are not giving accurate data to the drone and difficulty performing the task. In the OSD menu, enter CONFIG page, select CALI and enter the calibrating status. The blue LED will flash quickly first and be solid on when calibration finished. Make sure the drone is level status when calibrating.

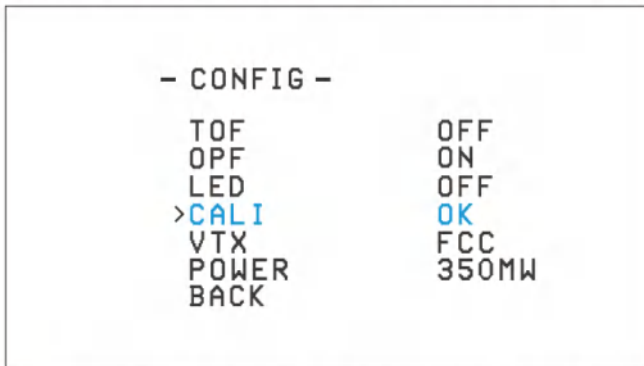

For the steps to calibrate the drone sensor, please refer to the chapter of "Advanced Functions".

4. Please make sure that the bottom of the sensor is not blocked by foreign objects, and the surface of the sensor is free of dirt and dust that will affect its accuracy. When the flight auxiliary function is abnormal, the sensor should be wiped clean before continuing to use.

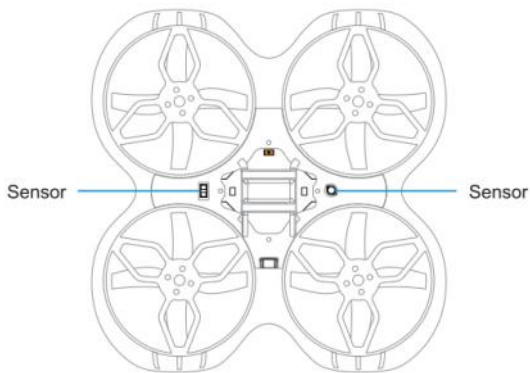

## 10.3 How to Use FPV Simulator

The safest and quickest method to get started is to use an FPV simulator. The LiteRadio 3 remote control radio transmitter supports most FPV simulators on the market with a comprehensive configuration.

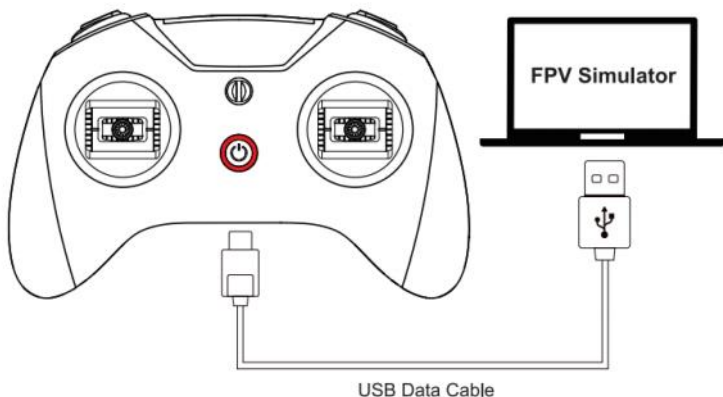

Operation steps below:

- Turn off the radio transmitter.
- Connect the transmitter to computer via a USB cable. Wait for the LED ring breathes in red or green.
- Install driver from PC automatically, prompt box pops up after successful installation. Then, radio transmitter works as a joystick human interface device (AKA HID device) normally.

#### Setting up a device

We're setting up 'BETAFPV JoyStick' 

### Bluetooth & other devices

Other devices

 BETAFPV JoyStick

User needs to manually install driver if PC doesn't install automatically or is installed incorrectly.

*Caution: Do not power on the transmitter and connect it to the PC. The USB port is invalid in this situation.*

## 10.3 How to Stop After A Collision

- Press switch SA on the remote control radio transmitter immediately once the quadcopter collides with an object. When the switch SA pop up, all motors will immediately stop.
- If the flying altitude is too high and it is difficult to control, please press switch SA immediately to stop the motor.

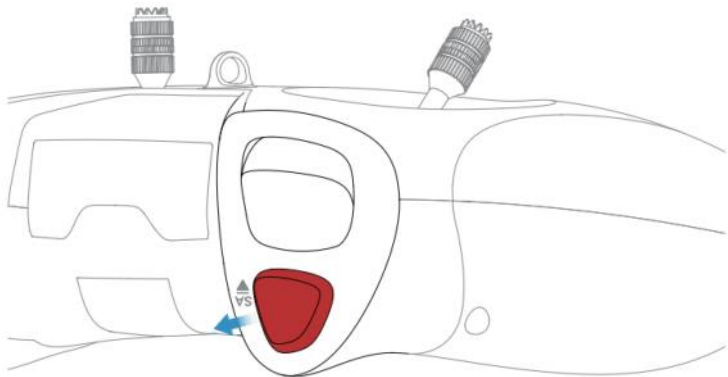

**Press switch SA to pop-up status to disarm the drone**

*Caution: Press switch SA immediately when the quadcopter is hit or the propellers scratch against the frame duct.*



[betafpv.com](http://betafpv.com)





# 免责声明与安全操作指南

## Disclaimer and Safety Guidelines

第 1 版 2023-10-17

# 免责声明与警告

## 免责声明

本产品并非玩具，需要有一定的基础知识才能控制，所以要循序渐进。在开始使用前，请特别留意其中的注意与警告，深圳市哈鸣科技有限公司 (BETAFPV) 保留更新本《免责声明与安全操作指南》的权利。

本产品为多旋翼飞行器，配备了动力强劲的电机和锋利的螺旋桨，具有极快的飞行速度，同时具有一定的危险性，操作时需谨慎使用，在电源正常工作及各部件未损坏的情况下将提供优异的飞行体验。

务必在使用产品之前仔细阅读本文档，了解您的合法权益、责任和安全说明，否则，可能带来财产损失、安全事故和人身安全隐患。一旦使用本产品，即视为您已理解、认可和接受本文档全部条款和内容。使用者承诺对自己的行为及因此而产生的所有后果负责。使用者承诺仅出于正当目的使用本产品，并且同意本条款及 BETAFPV 可能制定的任何相关政策或者准则。

本产品的文档如有更新，恕不另行通知。请访问 <https://betafpv.com/> 了解最新信息。

## 警告

请务必熟悉产品的功能之后再进行操作。如果没有正确操作本产品可能会对自身或他人造成严重伤害，或者导致产品损坏和财产损失。本产品较为复杂，需要经过一段时间熟悉后才能安全使用，并且需要具备一些基本常识后才能进行操作。本产品不适合儿童使用。切勿使用非 BETAFPV 提供或建议的部件，必须严格遵守 BETAFPV 的指南安装和使用产品。本指南文档包含安全，操作和维护等说明。在进行组装，设置和使用之前务必仔细阅读用户手册中的所有说明和警告。

# 出口管制

## 遵守出口管制法律

本产品的出口、再出口或转移受中国的出口管制法律及其他适用的出口管制法律管控。除非适用的出口管制法律允许，或者获得相关出口管制主管机构的许可，您对本产品的使用、销售、转让、出租或者其他行为需要确保：

1. 不违反适用出口管制法律的禁运政策。
2. 不与适用出口管制法律禁止的最终用户进行交易。
3. 仅用作民用用途，禁止直接或间接将 BETAFPV 产品用于以下内容或与其有关的 (1) 任何军事战斗目的或军事战斗相关用途；(2) 恐怖主义活动；(3) 其他刑事犯罪行为。采购方也应要求其客户或最终用户遵守前述要求。

## 出口合规免责声明

您需要遵守适用中国及其他国家或地区适用的出口或进口管制法律。任何由于您使用、销售、转让、出租本产品或其他行为导致违反前述适用的出口或进口管制法律的情形下，您将独立承担相应法律责任。BETAFPV 在任何情况下均不对您违反适用的出口或进口管制法律的行为负责，并且您还应保障 BETAFPV 及其附属机构、管理人员、员工、代理商、代表人不因您的前述行为而遭受任何法律责任和损害。如发生前述情况，您将承担相关费用，包括但不限于赔偿款、诉讼费，律师费、差旅费等。

# 使用须知

## 遥控器

1. 每次飞行前，确保遥控器电量充足。
2. 如更换遥控器，需要重新对频。
3. 切勿遮挡或覆盖遥控器内置天线，以获得最佳的信号效果。

## 飞行器

1. 每次飞行前，确保飞行器电量充足。
2. 螺旋桨是否正确、稳固安装。
3. 电池是否安装并连接稳固。

## 电池

1. 充电时必须使用符合规格的充电器。
2. 请勿在无人看顾的情况下充电。
3. 请勿过充。
4. 请勿短路(正负极接反)。
5. 请在0-45°C范围内充电。
6. 充电时，请注意充电的桌面或平台可耐热耐高温，充电时，有条件地选择在水泥地上或者装满泥沙的花盆中充电。
7. 在任何时候，都不能让电池电芯过热。电芯在温度高达60°C后，会存在安全隐患，甚至是燃烧。
8. 在充电时，电池不可接近或者直接放置在易燃物品如：纸张、塑料、地毯、乙烯、皮革、木材，或者直接放在设备中充电。
9. 请勿过放（每片电芯放完电的电压不低于3.3V），过放易损伤电池，如鼓胀。
10. 请勿将电池液溅到眼睛或者皮肤，如不慎溅到，请立即用清水清洗，严重者请立即就医。
11. 请勿任意拆开电池重组或者改变接线，请勿直接接触有漏液现象的电池。
12. 请勿私自组装电池，将旧电池电芯拆开重组，或者将拆开后的某一片电芯与另外一组电池重组的行为都是危险的(无专用的组装仪器易引起短路燃烧)。
13. 如在使用中发生碰撞，请将电池取出，请仔细检测电池以及连接器是否正常，以防万一。

注意：电池有可能高温烫手!

## 飞行警告

1. 恶劣天气下请勿飞行，如大风、下雪、下雨、有雾天气等。
2. 选择开阔、周围无高大建筑物的场所作为飞行场地。大量使用钢筋的建筑物会影响信号工作，干扰飞行，建议飞行器与建筑物、电线杆、障碍物等保持10m以上距离。
3. 飞行时，请保持在视线内控制，远离障碍物、人群、水面等，避免在人员密集处飞行。
4. 请勿在有高压线、通讯基站或发射塔等区域飞行，以免受到干扰。
5. 请勿在移动的物体表面起飞(例如行进中的汽车、船只)。
6. 请勿在易燃易爆的环境中使用飞行器。
7. 切勿接触工作中的螺旋桨，否则可能受到严重人身财产损害。

# 法律规范

## 警告

为避免违法行为，可能的伤害和损失，务必遵守以下各项：

1. 禁止将飞行器进行任何改装或用于其他非法用途。
2. 切勿在载人飞机附近飞行，必要时立即降落。
3. 禁止在大型活动现场使用飞行器。这些场地包括但不限于：体育比赛场馆、演唱会。
4. 切勿在当地法律禁止的区域飞行。
5. 确保飞行器飞行时不会对航线上的大型载人飞行器造成影响，时刻保持警惕，并躲避其他飞行器。

## 小心

为避免违法行为，可能的伤害和损失，务必遵守以下各项：

1. 禁止操控飞行器进入法律法规规定的禁飞区，禁飞区包括但不限于：机场、边境线以及主要城市和临时举行活动区域。
2. 禁止在超过限定高度的空域飞行。
3. 确保飞行器在您的视距范围内飞行，若有必要可安排观察员帮助您监控飞行器位置。
4. 禁止使用飞行器搭载任何违法危险物器。

## 注意

1. 确保您已清楚了解飞行活动的类别（例如：娱乐、公务或商务），在飞行前务必获取相关部门颁发的许可证。如有必要，可向当地政府主管部门咨询飞行活动类别的详细定义说明。请注意，在某些地区和国家禁止使用飞行器进行任何形式的商业行为。
2. 禁止在敏感建筑设施，例如：发电站、水电站、监狱、交通要道、政府大楼以及军事设施附近使用飞行器。

### 深圳市哈鸣科技有限公司

网址：[betafpv.com](http://betafpv.com)

邮箱：[support@betafpv.com](mailto:support@betafpv.com)

地址：广东省深圳市龙岗区坂田街道岗头社区天安云谷产业园二期（02-08地块）11栋2007

# Disclaimer and Warning

## Disclaimer

This product is a multi-rotor aircraft, equipped with powerful motors and sharp propellers, has fast flight speed, but also has a certain hazard when operating, need to be used with caution.

This product is not a toy and requires some basic knowledge to control, so please pay special attention to the warnings and cautions before you start using it. BETAFPV reserves the right to update this Disclaimer.

By using this product, you are deemed to have understood, acknowledged and accepted all of the terms and conditions of this document and you undertake to be responsible for your own actions and all consequences arising therefrom. You undertake to use this product only for legitimate purposes and agree to all of the terms and conditions of this document and any related policies or guidelines that BETAFPV may establish.

BETAFPV reserves the right to update this disclaimer and the safety guidelines. Visit <https://betafpv.com/> for the latest version.

## Individual Parts

### Remote Controller

1. Make sure remote controller batteries are fully charged before flight.
2. It is necessary to be re-bind if the remote controller has been replaced.
3. DO NOT block or cover the built-in antenna of the remote control for a strong antenna reception.

### Aircraft

1. Make sure aircraft batteries are fully charged before flight.
2. Make sure propellers are in good condition and mounted onto the motors correctly and securely.
3. Make sure the battery is mounted securely.

### Battery

1. Only use a battery charger that meets the specifications when charging.
2. Never leave while battery is in charging process. Do not charge the battery unattended.
3. Do not over charge the battery.
4. Do not short circuit the battery. Make sure the wire connection polarity is correct.
5. Do not charge/discharge battery at of recommended temperature range (Charge: 0 to 45°C).
6. Always place the battery in a fire resistant surface or fire safety container alone when charging/discharging. The middle of a cement driveway is a good example of a safe location.
7. Do not allow LiPo cells to overheat at any time. Cells which reach greater than 60°C will usually become damaged and will catch fire.
8. Do not charge/discharge battery inside house, garage, vehicle, building and away from any combustible material.
9. Do not over discharge the battery. Do not discharge a battery pack to a level below 3.3V per cell.
10. Do not allow the electrolyte to get into eyes or on skin. Wash affected areas immediately if they come into contact with electrolyte. Do not alter or modify connectors or wires of a LiPo battery pack. Do not have contact with a leaky/damaged battery directly.
11. Do not assemble LiPo cells or pre-assembled packs together with other LiPo cells or packs.
12. Inspect batteries if crash, battery should be placed in a safe area for observation for at least 30 minutes after crash.

**Caution:** The battery may be in high temperature!

## Flight Condition Requirements

1. Do not fly in severe weather conditions including strong wind, snow, rain, fog, etc.
2. Only fly in open areas without tall buildings and large metal structures around. Buildings with a large number of concrete irons will affect the signal and interfere with the flight. It is recommended to fly at least 10m away from buildings, poles, obstacles, etc.
3. When flying, please keep control within sight and away from obstacles, crowds, water, etc.
4. Please do not fly in areas with high voltage lines, communication base stations or transmission towers to avoid interference.
5. Do not take off from moving objects, such as cars and ships.
6. Do not use the aircraft in an environment at risk of a fire or explosion.
7. To avoid injury, stay away from rotating propellers or motors.

## Regulations

### WARNING

To avoid non-compliant behavior, serious injury, and property damage, observe the following rules:

1. DO NOT modify the aircraft or use the aircraft for other illegal purposes.
2. DO NOT operate in the vicinity of manned aircraft, regardless of altitude. If necessary, land immediately.
3. DO NOT fly the aircraft in areas where the large events are being held, including but not limited to sporting events and concerts.
4. DO NOT fly the aircraft in areas prohibited by local laws.
5. Remain well clear of and DO NOT interfere with manned aircraft operations. Be aware of and avoid other aircraft and obstacles at all times.

### CAUTION

To avoid non-compliant behavior, serious injury, and property damage, observe the following rules:

1. DO NOT fly the aircraft near or inside restricted zones specified by local laws and regulations. Restricted zones include, but are not limited to, airports, borders between two sovereign countries or regions, major cities, and areas where temporary events or activities are being held.
2. DO NOT fly the aircraft above the authorized altitude.
3. Make sure to keep your aircraft within VLOS, and use an observer to assist if needed.
4. DO NOT use the aircraft to carry illegal or dangerous payloads.

### NOTICE

1. Make sure you understand the nature of your flight operation (such as for recreation, for public use, or for commercial use) and have obtained corresponding approval and clearance from the related government agencies before flight. Consult with your local regulators for comprehensive definitions and specific requirements. Note that remote controlled aircraft may be banned from conducting commercial activities in certain countries and regions.
2. DO NOT fly around sensitive infrastructure or property such as power stations, water treatment facilities, correctional facilities, heavily traveled roadways, government facilities, and military zones.

# Export Controls

## Comply with Applicable Export Control Laws

You are advised that export, re-export, and transfer of the Products are subjected to Chinese export control law and other applicable export control laws and sanctions (hereafter collectively referred to as "Export Control Laws"). Prior to your use, sale, transfer, rental, or other conduct related to the Products, unless permitted by the Export Control Laws or with the license issued by competent authorities, you shall in particular check and guarantee by appropriate measures that:

1. There will be no infringement of an embargo imposed by the Export Control Laws;
2. The Products will not be provided to the entities, persons, and organizations listed in all applicable sanctioned party lists;
3. It is only for civilian use, and it is forbidden to directly or indirectly use BETAFPV products for or related to the following content (1) any military combat purpose or military combat-related purposes; (2) terrorist activities; (3) other criminal acts. The purchaser shall also require its customers or users to comply with the aforementioned requirements.

## Export Compliance, Disclaimer & Indemnity

You acknowledge it is your responsibility to comply with Chinese export control law and any other applicable export control laws. You shall solely be responsible for the legal responsibility if any of your use, sale, transfer, rental or other conduct related to the Products fail to comply with the applicable export control laws, BETAFPV shall, in no circumstances, be responsible for your violation of any applicable export control laws. Furthermore, you shall indemnify, defend, and hold harmless BETAFPV, its affiliates, directors, officers, employees, agents, and representatives, from and against any and all claims, demands, suits, causes of action, expenses (including reasonable attorneys' fee), damages, losses, or liabilities of any nature whatsoever, arising from, or allegedly arising from, or related to, your failure to comply with applicable export control laws.

# Compliance Information

## FCC STATEMENT

This equipment complies with part 15 of the FCC Rules. Operation is subject to the following two conditions:

1. This device may not cause harmful interference, and
2. This device must accept any interference received, including interference interference that may cause undesired operation.

Warning: Changes or modifications not expressly approved by the party responsible for compliance could void the user's authority to operate the equipment.

NOTE: This equipment has been tested and found to comply with the limits for a Class B digital device, pursuant to Part 15 of the FCC Rules. These limits are designed to provide reasonable protection against harmful interference in a residential installation. This equipment generates uses and can radiated radio frequency energy and, if not installed and used in accordance with the instructions, may cause harmful interference to radio communications. However, there is no guarantee that interference will not occur in a particular installation. If this equipment does cause harmful interference to radio or television reception, which can be determined by turning the equipment off and on, the user is encouraged to try to correct the interference by one or more of the following measures:

- Reorient or relocate the receiving antenna.
- Increase the separation between the equipment and receiver.
- Connect the equipment into an outlet on a circuit different from that to which the receiver is connected.
- Consult the dealer or an experienced radio/TV technician for help.

## FCC Radiation Exposure Statement

This equipment complies with FCC radiation exposure limits set forth for an uncontrolled environment. This equipment should be installed and operated with minimum distance 20cm between the radiator & your body.

### **Shenzhen Baida Moxing Co., Ltd.**

Web: [betafpv.com](http://betafpv.com)

E-mail: [support@betafpv.com](mailto:support@betafpv.com)

Address: B1702A, Block ABCD, Building 3, Phase 1, Tian'an Cloud Park, Gangtuo Community, Bantian Street, Longgang District, Shenzhen, Guangdong, China