

EVALUATION REPORT ***for Certification***

Manufacturer: Summit Technology
130, Digital-ro, Namsung Plaza suite 611,
Geumcheon-gu, Seoul, South Korea
Attn: Mr. Yong-seong Park / Senior Director

Date of Issue: Mar. 08, 2023
Order Number: GETEC-C1-23-142
Test Report Number: GETEC-E3-23-006
Test Site: GUMI UNIVERSITY EMC CENTER
CAB Designation Number: KR0033

RESPONSIBLE PARTY	: Summit Technology
ADDRESS	: 130, Digital-ro, Namsung Plaza suite 611, Geumcheon-gu, Seoul, South Korea
CONTACT PERSON	: Mr. Yong-seong Park / Senior Director

Rule Part(s)	: FCC Part 15 Subpart C-Intentional Radiator § 15.231
Test Method	: ANSI C63.10 (2013)
Equipment Class	: Part 15 Remote Control/Security Device Transceiver(DSR)
EUT Type	: Touch Screen Controller
Type of Authority	: Certification
Model Name	: MX-4000

This equipment has been shown to be in compliance with the applicable technical standards as indicated in the measurement report and was tested in accordance with the measurement procedures specified in ANSI C63.10 (2013)

I attest to the accuracy of data. All measurements reported herein were performed by me or were made under my supervision and are correct to the vest of my knowledge and belief. I assume full responsibility for the completeness of these measurements and vouch for the qualifications of all persons taking them.

Tested by,



Jong-Wook Park / Senior Engineer
GUMI UNIVERSITY EMC CENTER

Reviewed by,



Hyun Kim / Technical Manager
GUMI UNIVERSITY EMC CENTER



Version

Test Report No.	Date	Description
GETEC-E3-23-006	Mar. 08, 2023	- First Approval Report





CONTENTS

1. GENERAL INFORMATION	4
2. INTRODUCTION	5
3. PRODUCT INFORMATION	6
3.1 DESCRIPTION OF EUT.....	6
3.2 DEFINITION OF MODELS.....	6
3.3 SUPPORT EQUIPMENT / CABLES USED	7
3.4 MODIFICATION ITEM(S).....	7
4. ANTENNA REQUIREMENT - §15.203	8
4.1 DESCRIPTION OF ANTENNA.....	8
5. DESCRIPTION OF TESTS.....	8
5.1 TEST CONDITION.....	8
6. REFERENCES STANDARDS	8
7. SUMMARY OF TEST RESULTS	9
8. AUTOMATICALLY DEACIVATE.....	10
8.1 OPERATING ENVIRONMENT.....	10
8.2 TEST SET-UP (LAYOUT)	10
8.3 LIMIT	10
8.4 TEST EQUIPMENT USED.....	10
8.5 TEST TEST PROCEDURE	10
8.6 TEST RESULT	11
9. RADIATED SPURIOUS EMISSIONS	12
9.1 OPERATING ENVIRONMENT.....	13
9.2 TEST SET-UP.....	13
9.3 MEASUREMENT UNCERTAINTY	13
9.4 LIMIT	14
9.5 TEST EQUIPMENT USED.....	14
9.6 TEST DATA FOR RADIATED SPURIOUS EMISSION.....	15
10. 20 DB BANDWIDTH	16
10.1 OPERATING ENVIRONMENT	16
10.2 TEST SET-UP (LAYOUT)	16
10.3 LIMIT	16
10.4 TEST EQUIPMENT USED.....	16
10.5 TEST TEST PROCEDURE	16
10.6 TEST RESULT.....	17
11. SAMPLE CALCULATIONS	18
11.1 EXAMPLE 1 :	18
11.2 EXAMPLE 2 :	18
12. RECOMMENDATION & CONCLUSION.....	19



Scope: Measurement and determination of electromagnetic emissions (EME) of radio frequency devices including intentional and / or unintentional radiators for compliance with technical rules and regulations of the Federal Communications Commission.

1. General Information

Applicant: Summit Technology

Applicant Address: 130, Digital-ro, Namsung Plaza suite 611, Geumcheon-gu, Seoul, South Korea

Manufacturer: Summit Technology

Manufacturer Address: 130, Digital-ro, Namsung Plaza suite 611, Geumcheon-gu, Seoul, South Korea

Contact Person: Mr. Yong-seong Park / Senior Director

Telephone Number: +82-2-6929-3161

- **FCC ID.** 2AT6QMX4000
- **Equipment Class** Part 15 Remote Control/Security Device Transceiver (DSR)
- **EUT Type** Touch Screen Controller
- **Model Name** MX-4000
- **Rule Part(s)** FCC Part 15 Subpart C-Intentional Radiator § 15.231
- **Test Method** ANSI C63.10 (2013)
- **Type of Authority** Certification
- **Test Procedure(s)** ANSI C63.10 (2013)
- **Dates of Test** Feb. 20, 2023 ~ Feb. 28, 2023
- **Place of Test** **GUMI UNIVERSITY EMC CENTER** (FCC Test firm Registration No.: 269701)
37 Yaeun-ro, Gumi-si, Gyeongsangbuk-do, 730-711, Republic of Korea
- **Test Report Number** GETEC-E3-23-006
- **Dates of Issue** Mar. 08, 2023



2. Introduction

The measurement procedure described in American National Standard for Methods of Measurement of Radio-Nose Emissions From Low-Voltage Electrical and Electronic Equipment in the Range of 9 kHz to 40 GHz (ANSI C63.4-2009) was used in determining radiated and conducted emissions emanating from **Summit Technology Touch Screen Controller (Model name: MX-4000)**.

These measurement tests were conducted at **GUMI UNIVERSITY EMC CENTER**.

The site address is 37 Yaeun-ro, Gumi-si, Gyeongsangbuk-do, 730-711, Republic of Korea

This test site is one of the highest point of GUMI UNIVERSITY at about 200 kilometers away from Seoul city and 40 kilometers away from Daegu city. It is located in the valley surrounded by mountains in all directions where ambient radio signal conditions are quiet and a favorable area to measure the radio frequency interference on open field test site for the computing and ISM devices manufactures. The detailed description of the measurement facility was found to be in compliance with the requirements of §2.948 according to ANSI C63.10 (2013)

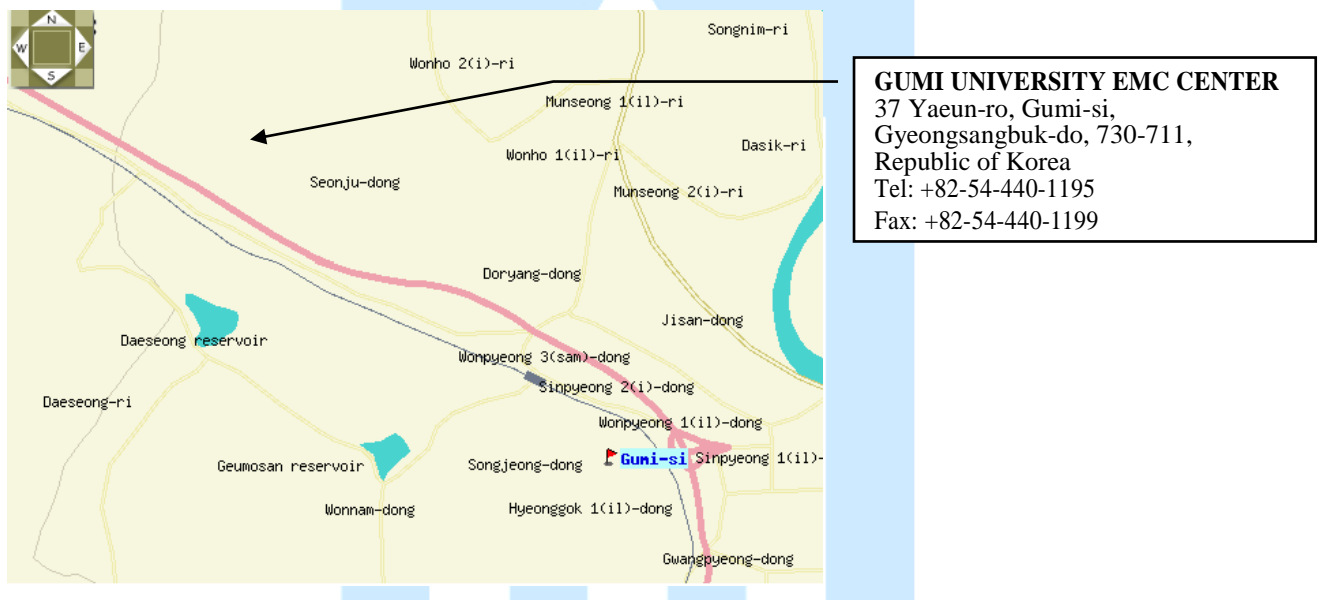

Fig 1. The map above shows the Gumi University in vicinity area.



3. Product Information

3.1 Description of EUT

The Equipment under Test (EUT) is the **Summit Technology Touch Screen Controller (Model Name: MX-4000)**
FCC ID.: 2AT6QMX4000

- . Equipment	: Touch Screen Controller
- . Model name	: MX-4000
- . Serial number	: Proto type
- . Electrical Rating	: DC 3.7 V
- . Manufacturer	: Summit Technology
- . Frequency Range	: 418 MHz
- . Modulation	: ASK
- . Antenna Specification	: Antenna type : PCB antenna Gain : -26.60 dBi

3.2 Definition of models

- None.



3.3 Support Equipment / Cables used

3.3.1 Used Support Equipment

Description	Manufacturer	Model Name	S/N & FCC ID.
-	-	-	-

3.3.2 System configuration

Description	Manufacturer	Model Name	S/N & FCC ID.
-	-	-	-

3.3.3 Used Cable(s)

Cable Name	Condition	Description
-	-	-

3.4 Modification Item(s)

- None



4. Antenna Requirement - §15.203

An intentional radiator antenna shall be designed to ensure that no antenna other than that furnished by the applicant can be used with the device. The use of permanently attached antenna or of an antenna that uses a unique coupling to the intentional radiator shall be considered sufficient to comply with this requirement.

4.1 Description of Antenna

The **Summit Technology Touch Screen Controller**, comply with the requirement of §15.203 with a PCB antenna permanently attached to the transmitter.

5. Description of tests

5.1 Test Condition

The EUT was installed, arranged and operated in a manner that is most representative of equipment as typically used. The measurements were carried out while varying operating modes and cable positions within typically arrangement to determine maximum emission level.

The representative and worst test mode(s) were noted in the test report.

- Test Voltage / Frequency: 3.7 V / DC
- Operating condition during the test(s) :
 - . Continuous RF transmitting mode with nominal maximum RF output power.
 - . Operating channel frequency and modulation technology

Mode	Available channel	Frequency	Modulation Technology
418 MHz	1	418 MHz	ASK

- . EUT set condition (Test Software)

Test Software	-
Test Software version	-

6. References Standards

- FCC Part 15 (2009) Subpart C-Intentional Radiator §15.231
- ANSI C 63.10 (2013): American National Standard for Testing Unlicensed Wireless Devices



7. SUMMARY OF TEST RESULTS

FCC Part Section(s)	Test Description	Test Result
§15.207(a)	AC Power line Conducted Emissions	N/A ¹⁾
§15.231(a)(1)	Automatically Deactivate	Pass
§15.205, 15.209, §15.231(b)	Radiated Spurious Emissions	Pass
§15.231(c)	20 dB Bandwidth	Pass

1) The EUT is operating by DC battery, Therefore the test was not applicable.



8.6 Test result

- Test Date : Feb. 23, 2023
- Reference Standard : Part 15 Subpart C, Sec. 15.231(a)(1)
- Test Procedure(s) : ANSI C63.10 (2013)
- Operating Condition : RF transmitting mode (418 MHz)
- Power Source : DC 3.7 V

Frequency (MHz)	Operating Time (ms)	Limit (s)	Result
418	166.72	5	Complies

Test Plot on Configuration :

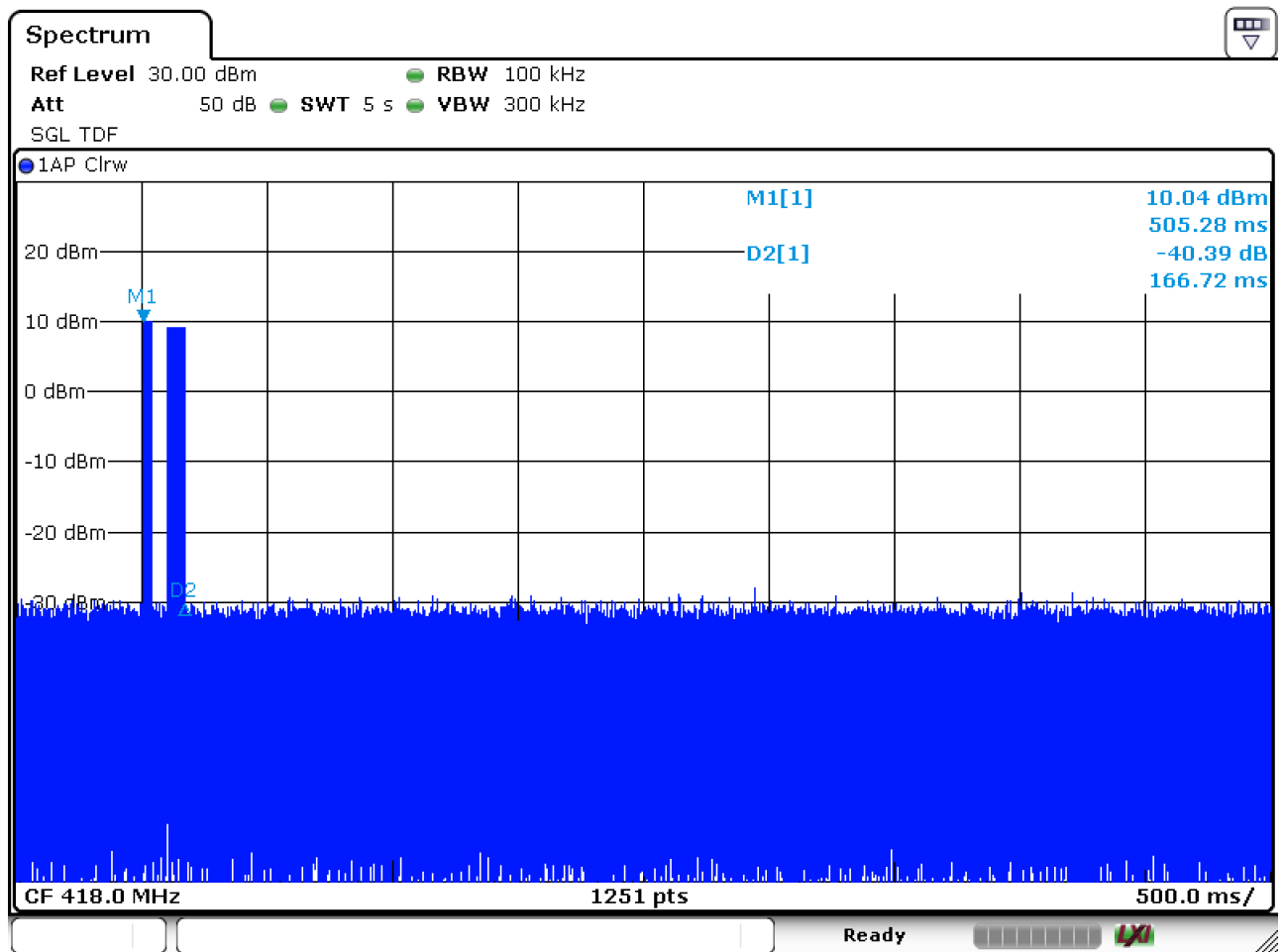

Date: 23.FEB.2023 15:07:19



9. Radiated Spurious Emissions

Exploratory Radiated measurements were conducted at the 3m semi anechoic chamber in order to identify the highest emission by operating the EUT in a range of typical modes of operation, cable positions, system configuration and arrangement.

Based on exploratory measurements, the final measurements were conducted at the worst test conditions.

Final measurements of below 1GHz were made at 3m or 10 m Chamber that complies with CISPR 16/ANSI C63.10. Above 1GHz final measurements were conducted at the 3m Chamber only.

For measurements above 1GHz, the bottom side of 3m chamber was installed with absorbers in order to meet SVSWR Limit.

Exploratory measurements were scanned using Peak mode of EMI Test receiver and final measurements were measured with Quasi-Peak mode (Below 1GHz) and Peak & Average mode (Above 1GHz).

The measurements were performed by rotating the EUT 360° and adjusting the receive antenna height from 1.0 m to 4.0 m. All frequencies were investigated in both horizontal and vertical antenna polarity.

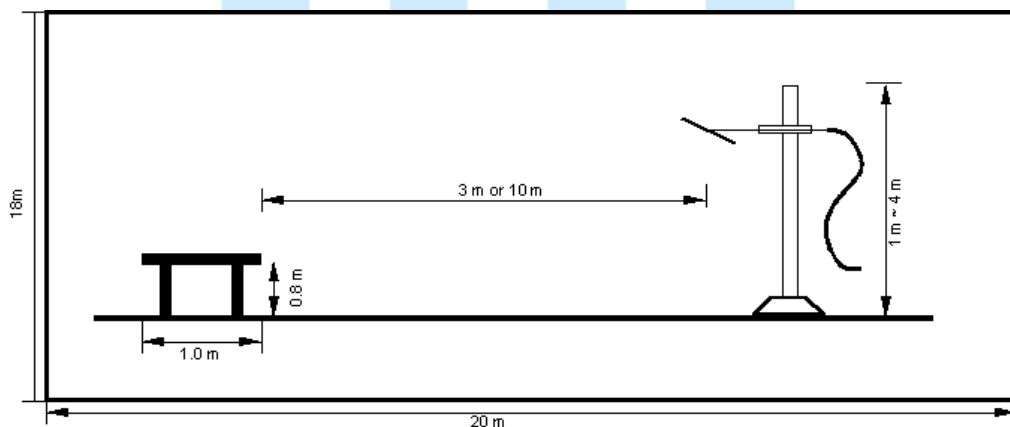

Fig 3. Dimensions of test site (Below 1GHz)

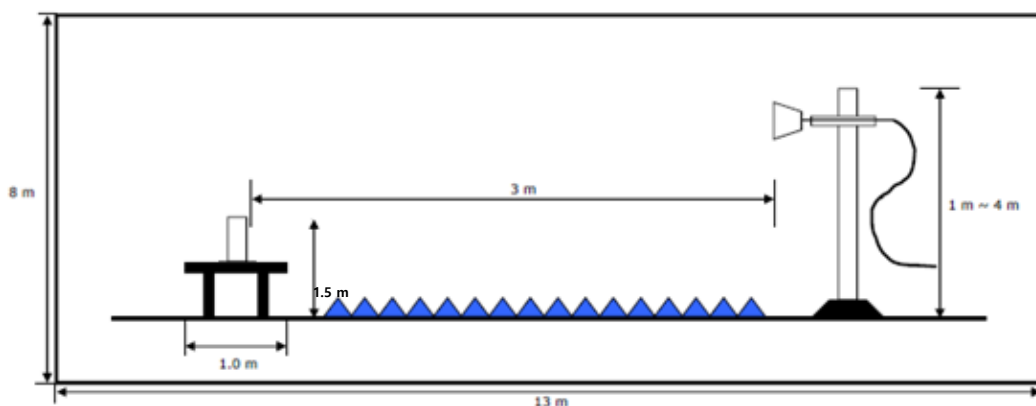

Fig 4. Dimensions of test site (Above 1GHz)



9.1 Operating environment

Temperature : 20.3 °C
Relative humidity : 38.8 % R.H.

9.2 Test set-up

A preliminary and final measurement was at 3 m anechoic chamber.

The EUT was placed on a non-conducting table.

For emissions testing at or below 1 GHz, the table height is 80 cm above the reference ground plane.

For emission measurements above 1 GHz, the table height is 1.5 m above the reference ground plane.

The turntable with EUT was rotated 360°, and the antenna was varied in height between 1.0 m and 4.0 m in order to determine the maximum emission levels.

This procedure was performed for both horizontal and vertical polarization of the receiving antenna.

9.3 Measurement uncertainty

The measurement uncertainty was calculated in accordance with ISO “Guide to the expression of uncertainty in measurement”.

The measurement uncertainty was given with a confidence of 95 %.

Test items(Anechoic Chamber)	Uncertainty	Remark
Radiated emission (30 MHz ~ 300 MHz, 3 m, Vertical)	4.78 dB	Confidence level of approximately 95 % ($k = 2$)
Radiated emission (30 MHz ~ 300 MHz, 3 m, Horizontal)	4.77 dB	Confidence level of approximately 95 % ($k = 2$)
Radiated emission (300 MHz ~ 1 000 MHz, 3 m, Vertical)	6.20 dB	Confidence level of approximately 95 % ($k = 2$)
Radiated emission (300 MHz ~ 1 000 MHz, 3 m, Horizontal)	5.12 dB	Confidence level of approximately 95 % ($k = 2$)
Radiated emission (1 000 MHz ~ 6 000 MHz, 3 m, V/H)	5.77 dB	Confidence level of approximately 95 % ($k = 2$)
Radiated emission (6 000 MHz ~ 18 000 MHz, 3 m, V/H)	4.88 dB	Confidence level of approximately 95 % ($k = 2$)
Radiated emission (18 000 MHz ~ 26 000 MHz, 3 m, V/H)	5.03 dB	Confidence level of approximately 95 % ($k = 2$)

Where relevant, the following measurement uncertainty levels have been estimated for tests performed on the EUT as specified in CISPR 16-4-2.

The listed uncertainties are the worst case uncertainty for the entire range of measurement. please note that the uncertainty values are provided for informational purposes only are not used in determining the PASS/FAIL results



9.4 Limit

20 dB in any 100 kHz bandwidth outside the operating frequency band. In case the emission fall within the restricted band specified on 15.205(a) limit in the table below has to be followed.

Frequencies (MHz)	Field Strength (microvolt/meter)	Measurement Distance (meters)
0.009 ~ 0.490	2 400/F (kHz)	300
0.490 ~ 1.705	2 400/F (kHz)	30
1.705 ~ 30.0	30	30
30 ~ 88	100	3
88 ~ 216	150	3
216 ~ 960	200	3
Above 960	500	3

In addition to the provisions of §15.205, the field strength of emissions from intentional radiators operated under this section shall not exceed the following:

Fundamental Frequencies (MHz)	Field Strength of fundamental (microvolt/meter)	Field Strength of spurious emissions (microvolt/meter)
40.66 – 40.70	2 250	225
70 – 130	1 250	125
130 – 174	1 250 to 3 750	125 to 375
174 – 260	3 750	375
260 – 470	3 750 to 12 500	375 to 1 250
Above 470	12 500	1 250

9.5 Test Equipment used

Model Name	Manufacturer	Description	Serial Number	Due to Calibration
■ - ESU40	Rohde & Schwarz	EMI Test Receiver	100266	Apr. 06, 2023
■ - HFH2-Z2	Rohde & Schwarz	Loop Antenna	100041	Apr. 14, 2023
■ - VULB9160	Schwarzbeck	Broadband Test Antenna	3313	Apr. 05, 2023
■ - HF907	Rohde & Schwarz	Horn Antenna	100538	Jan. 25, 2024
■ - MCU066	maturo GmbH	Position Controller	1390306	N/A
■ - TT2.5SI	maturo GmbH	Turntable	1390307	N/A
■ - CO3000	Innco system GmbH	Position Controller	CO3000/1804/4 2760218/P	N/A
■ - MA4640-XP-ET	Innco system GmbH	Antenna Mast	5580916	N/A
■ - TK-PA18H	TESTEK	Low Noise Amplifier	180001-L	Apr. 06, 2023
■ - WHKS600C9/40SS	WAINWRIGHT INSTRUMENTS	High pass filter	SN1	Apr. 07, 2023
■- EMC 32	Rohde & Schwarz	Testing Software	VER10.50.10	N/A



9.6 Test data for Radiated Spurious Emission

- Test Date : Feb. 20 ~ 28, 2023
- Reference Standard : Part 15 Subpart C, Sec. 15.205, 15.209, 15.231(b)
- Measuring Distance : 3 m
- Resolution Bandwidth : 200 Hz, 9 kHz(Below 30 MHz) / 120 kHz(30 MHz ~ 1GHz) / 1 MHz(Above 1GHz)
- Detector mode : Quasi Peak detector mode / Peak detector mode / Average detector mode
- Power Source : DC 3.7 V
- Note : Through three orthogonal axes were investigated and the worst case is report

Radiated Fundamental (418 MHz)

Frequency [MHz]	Pol.	Frequency Component	Reading [dBuV]	Transducer Factor [dB]	Test Result [dBuV/m]	Limits [dBuV/m]	Margin [dB]	Detector Type
418.00	H	Fundamental	58.11	21.20	79.31	100.28	20.97	PK
418.00	H	Fundamental	29.31	21.20	50.97	80.28	29.31	AV

Radiated Spurious Emission (9 kHz to 1 000 MHz)

Frequency [MHz]	Pol.	Frequency Component	Reading [dBuV]	Transducer Factor [dB]	Test Result [dBuV/m]	Limits [dBuV/m]	Margin [dB]	Detector Type
835.98	V	2nd Harmonics	31.33	29.80	61.13	80.28	19.15	PK

Radiated Spurious Emission (1 GHz to 5 GHz)

Frequency [MHz]	Pol.	Frequency Component	Reading [dBuV]	Transducer Factor [dB]	Test Result [dBuV/m]	Limits [dBuV/m]	Margin [dB]	Detector Type
N/A								

Note 1)

If the maximized peak measured value complies with the average limit, then it is unnecessary to perform an average measurement.

Note 2)

Test Result = Reading + Transducer Factor

Where, Transducer Factor = ACF + CL

ACF = Antenna Collection Factor

CL = Cable loss + Preamplifier gain + High Pass Filter

Pol.: H(Horizontal), V(Vertical)



10. 20 dB Bandwidth

10.1 Operating environment

Temperature : 22.5 °C
 Relative Humidity : 35.1 % R.H.

10.2 Test Set-up (Layout)

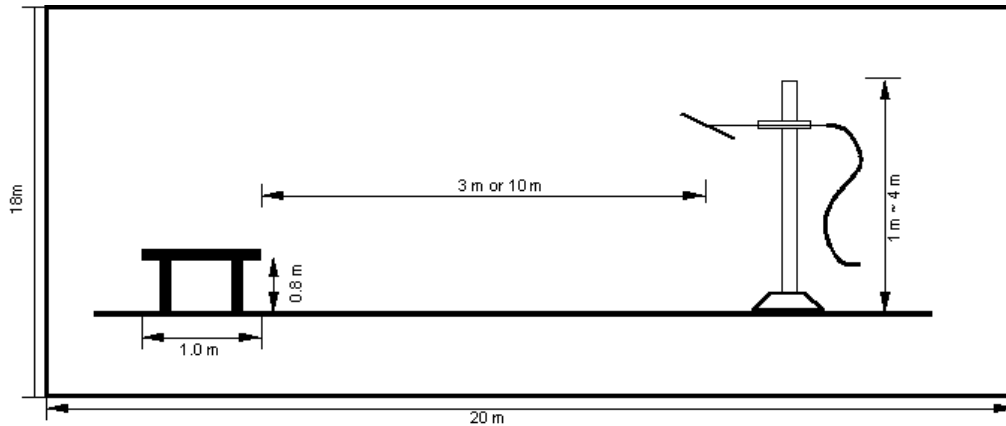

10.3 Limit

The bandwidth of the emission shall be no wider than 0.25% of the center frequency for devices operating above 70 MHz and below 900 MHz.

10.4 Test Equipment used

Model Name	Manufacturer	Description	Serial Number	Due to Calibration
■ - ESU40	Rohde & Schwarz	EMI Test Receiver	100266	Apr. 06, 2023
■ - VULB9160	Schwarzbeck	Broadband Test Antenna	3313	Apr. 05, 2023
■ - MCU066	maturo GmbH	Position Controller	1390306	N/A
■ - TT2.5SI	maturo GmbH	Turntable	1390307	N/A
■ - CO3000	Innco system GmbH	Position Controller	CO3000/1804/4 2760218/P	N/A
■ - MA4640-XP-ET	Innco system GmbH	Antenna Mast	5580916	N/A

10.5 Test Test Procedure

- Set RBW = 10 kHz.
- Set the video bandwidth (VBW) $\geq 3 \times$ RBW.
- Detector = Peak.
- Trace mode = max hold.
- Sweep = auto couple.
- Allow the trace to stabilize.
- Measure the maximum width of the emission that is constrained by the frequencies associated with the two outermost amplitude points (upper and lower frequencies) that are attenuated by 20 dB relative to the maximum level measured in the fundamental emission.



10.6 Test result

- Test Date : Feb. 23, 2023
- Reference Standard : Part 15 Subpart C, Sec. 15.231(c)
- Test Procedure(s) : ANSI C63.10 (2013)
- Operating Condition : RF transmitting mode (418 MHz)
- Power Source : DC 3.7 V

Frequency (MHz)	20 dB Bandwidth (MHz)	Band Edge Left (MHz)	Band Edge Right (MHz)	Limit (MHz)	Result
418	0.69	417.68	418.37	1.045	Complies

20 dB Bandwidth Plot on Configuration : 418 MHz

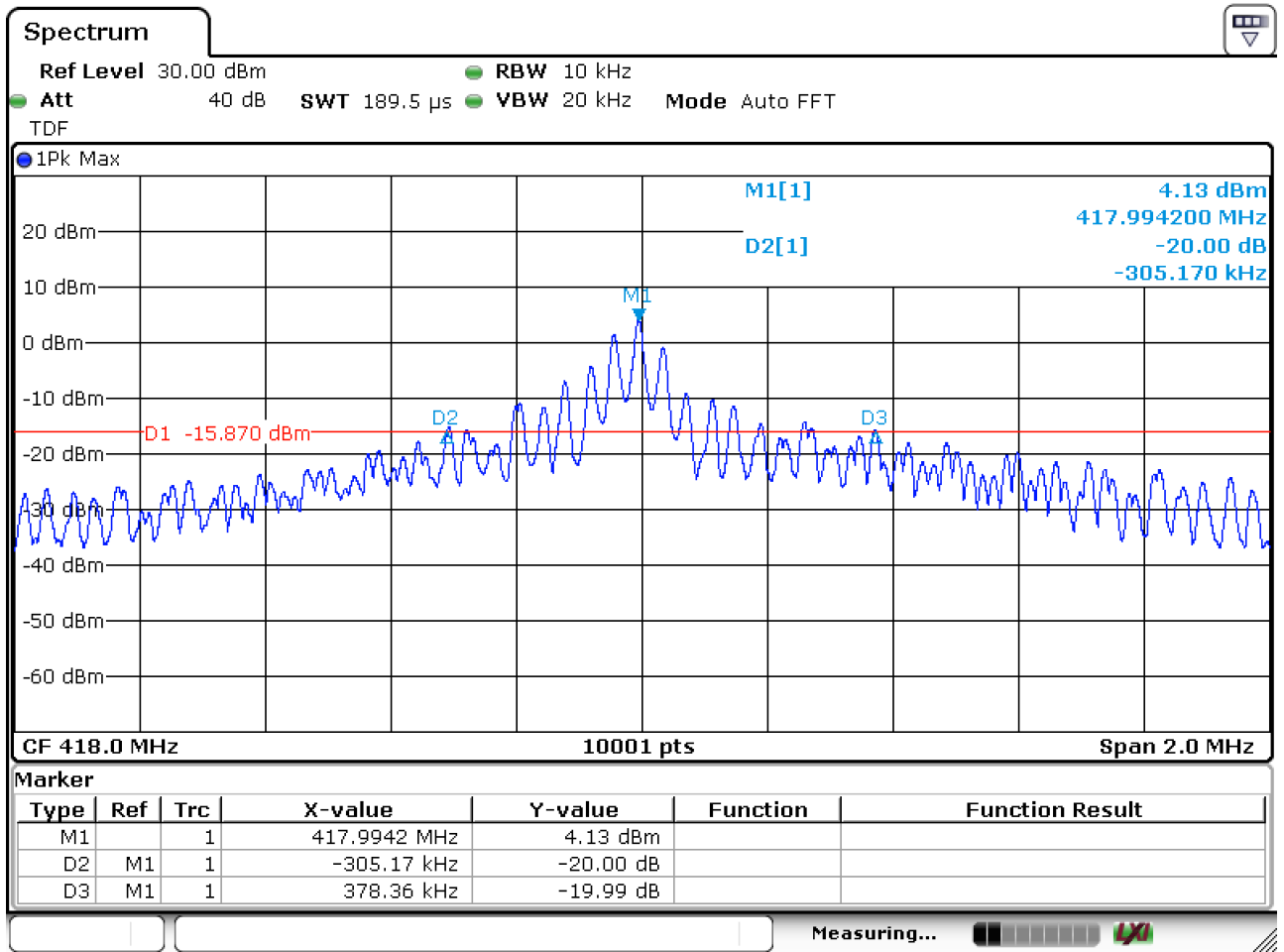

Date: 23.FEB.2023 15:14:50



11. Sample Calculations

$$\begin{aligned} \text{dB}\mu\text{V} &= 20 \text{ Log}_{10}(\mu\text{V}/\text{m}) \\ \text{dB}\mu\text{V} &= \text{dBm} + 107 \\ \mu\text{V} &= 10^{(\text{dB}\mu\text{V}/20)} \end{aligned}$$

11.1 Example 1 :

■ 20.3 MHz

Class B Limit = 250 μV = 48 $\text{dB}\mu\text{V}$

Reading = 39.2 $\text{dB}\mu\text{V}$

$10^{(39.2\text{dB}\mu\text{V}/20)}$ = 91.2 μV

Margin = 48 $\text{dB}\mu\text{V}$ - 39.2 $\text{dB}\mu\text{V}$
 = 8.8 dB

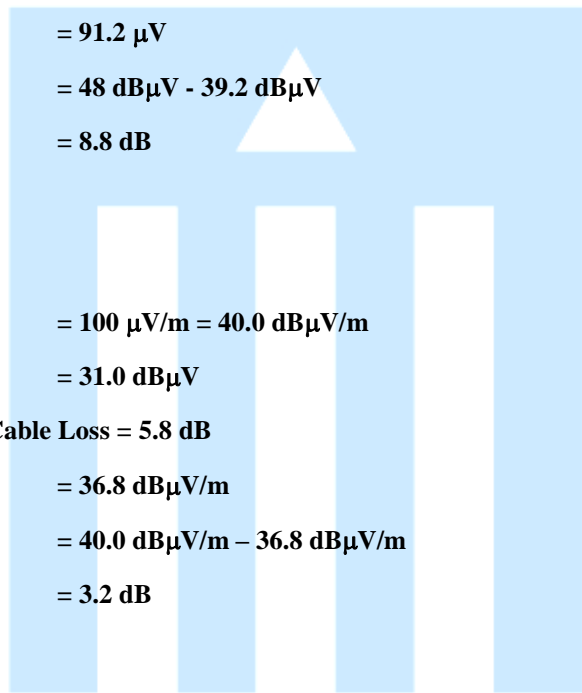

11.2 Example 2 :

■ 66.7 MHz

Class B Limit = 100 $\mu\text{V}/\text{m}$ = 40.0 $\text{dB}\mu\text{V}/\text{m}$

Reading = 31.0 $\text{dB}\mu\text{V}$

Antenna Factor + Cable Loss = 5.8 dB

Total = 36.8 $\text{dB}\mu\text{V}/\text{m}$

Margin = 40.0 $\text{dB}\mu\text{V}/\text{m}$ - 36.8 $\text{dB}\mu\text{V}/\text{m}$
 = 3.2 dB



12. Recommendation & Conclusion

The data collected shows that the **Summit Technology. Touch Screen Controller (Model Name: MX-4000)** was complies with §15.231 of the FCC Rules.

- The end -

