

EVALUATION REPORT ***for Certification***

Manufacturer: Summit Technology
130, Digital-ro, Namsung Plaza suite 611,
Geumcheon-gu, Seoul, South Korea
Attn: Mr. Yong-seong Park / Senior Director

Date of Issue: Mar . 08, 2023
Order Number: GETEC-C1-23-142
Test Report Number: GETEC-E3-23-008
Test Site: GUMI UNIVERSITY EMC CENTER
CAB Designation Number: KR0033

RESPONSIBLE PARTY	: Summit Technology
ADDRESS	: 130, Digital-ro, Namsung Plaza suite 611, Geumcheon-gu, Seoul, South Korea
CONTACT PERSON	: Mr. Yong-seong Park / Senior Director

Rule Part(s)	: FCC Part 15 Subpart E-UNII Devices § 15.407
Test Method	: KDB905462 D02 DFS Compliance Procedures New Rules v02
Equipment Class	: Unlicensed National Information Infrastructure(NII)
EUT Type	: Touch Screen Controller
Type of Authority	: Certification
Model Name	: MX-4000

This equipment has been shown to be in compliance with the applicable technical standards as indicated in the measurement report and was tested in accordance with the measurement procedures specified in KDB905462 D02 DFS Compliance Procedures New Rules v02

I attest to the accuracy of data. All measurements reported herein were performed by me or were made under my supervision and are correct to the vest of my knowledge and belief. I assume full responsibility for the completeness of these measurements and vouch for the qualifications of all persons taking them.

Tested by,



Jong-Wook Park, Senior Engineer
GUMI UNIVERSITY EMC CENTER

Reviewed by,



Hyun Kim, Technical Manager
GUMI UNIVERSITY EMC CENTER



Version

Test Report No.	Date	Description
GETEC-E3-23-008	Mar. 08, 2023	- First Approval Report





CONTENTS

1. GENERAL INFORMATION	4
2. INTRODUCTION	5
3. PRODUCT INFORMATION	6
3.1 DESCRIPTION OF EUT.....	6
3.2 DEFINITION OF MODELS.....	6
3.3 SUPPORT EQUIPMENT / CABLES USED	7
3.4 MODIFICATION ITEM(S).....	7
4. ANTENNA REQUIREMENT - §15.203	8
4.1 DESCRIPTION OF ANTENNA.....	8
5. DESCRIPTION OF TESTS.....	8
5.1 TEST CONDITION.....	8
6. REFERENCES STANDARDS	8
7. SUMMARY OF TEST RESULTS	9
8. CHANNEL MOVE TIME & CHANNEL CLOSING TRANSMISSION TIME & NON-OCCUPANCY PERIOD.....	10
8.1 OPERATING ENVIRONMENT.....	10
8.2 TEST SET-UP (LAYOUT)	10
8.3 LIMIT	10
8.4 TEST EQUIPMENT USED.....	10
8.5 TEST TEST PROCEDURE.....	11
8.6 TEST RESULT	12
9. RECOMMENDATION & CONCLUSION.....	16





Scope: Measurement and determination of electromagnetic emissions (EME) of radio frequency devices including intentional and / or unintentional radiators for compliance with technical rules and regulations of the Federal Communications Commission.

1. General Information

Applicant: Summit Technology

Applicant Address: 130, Digital-ro, Namsung Plaza suite 611, Geumcheon-gu, Seoul, South Korea

Manufacturer: Summit Technology

Manufacturer Address: 130, Digital-ro, Namsung Plaza suite 611, Geumcheon-gu, Seoul, South Korea

Contact Person: Mr. Yong-seong Park / Senior Director

Telephone Number: +82-2-6929-3161

- **FCC ID.** 2AT6QMX4000
- **Equipment Class** Unlicensed National Information Infrastructure(NII)
- **EUT Type** Touch Screen Controller
- **Model Name** MX-4000
- **Rule Part(s)** FCC Part 15 Subpart E-UNII Devices § 15.407
- **Test Method** KDB905462 D02 DFS Compliance Procedures New Rules v02(April 8,2016)
- **Type of Authority** Certification
- **Test Procedure(s)** KDB905462 D02 DFS Compliance Procedures New Rules v02(April 8,2016)
- **Dates of Test** Feb. 24, 2023
- **Place of Test** **GUMI UNIVERSITY EMC CENTER** (FCC Test firm Registration No.: 269701)
37 Yaeun-ro, Gumi-si, Gyeongsangbuk-do, 730-711, Republic of Korea
- **Test Report Number** GETEC-E3-23-008
- **Dates of Issue** Mar. 08, 2023



2. Introduction

The measurement procedure described in American National Standard for Methods of Measurement of Radio-Nose Emissions From Low-Voltage Electrical and Electronic Equipment in the Range of 9 kHz to 40 GHz (ANSI C63.4-2009) was used in determining radiated and conducted emissions emanating from **Summit Technology Touch Screen Controller (Model name: MX-4000)**

These measurement tests were conducted at **GUMI UNIVERSITY EMC CENTER**.

The site address is 37 Yaeun-ro, Gumi-si, Gyeongsangbuk-do, 730-711, Republic of Korea

This test site is one of the highest point of GUMI UNIVERSITY at about 200 kilometers away from Seoul city and 40 kilometers away from Daegu city. It is located in the valley surrounded by mountains in all directions where ambient radio signal conditions are quiet and a favorable area to measure the radio frequency interference on open field test site for the computing and ISM devices manufactures. The detailed description of the measurement facility was found to be in compliance with the requirements of §2.948 according to KDB905462 D02 DFS Compliance Procedures New Rules v02(April 8,2016)

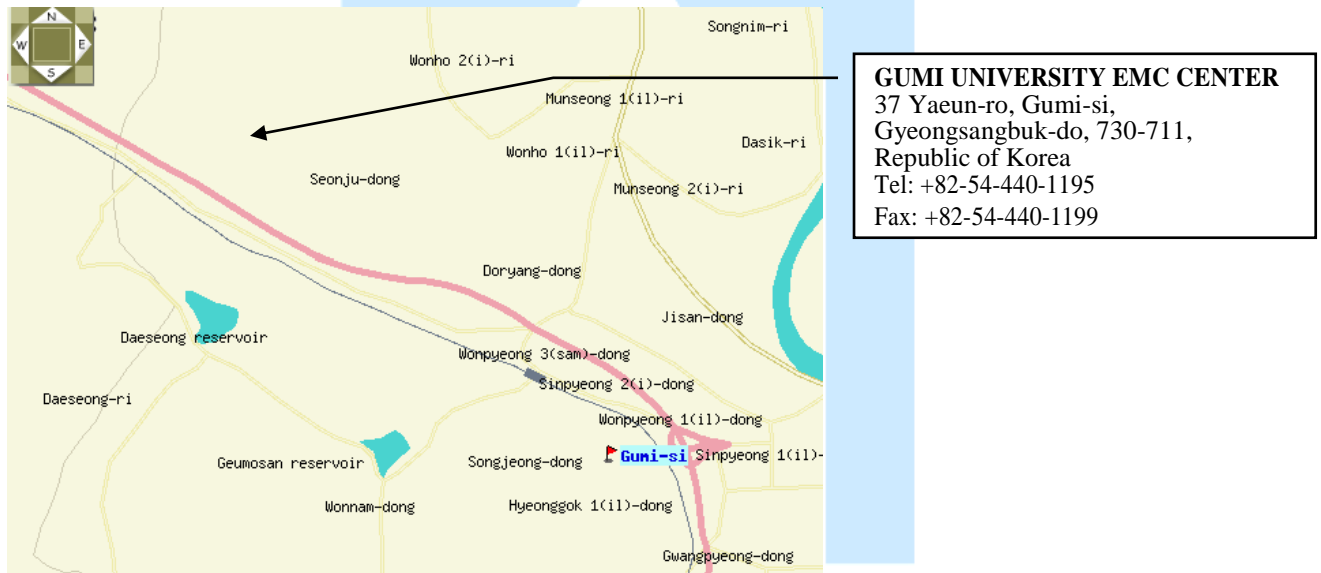

Fig 1. The map above shows the Gumi University in vicinity area.



3. Product Information

3.1 Description of EUT

The Equipment under Test (EUT) is the **Summit Technology Touch Screen Controller (Model Name: MX-4000)**
FCC ID.: 2AT6QMX4000

- Equipment	: Touch Screen Controller						
- Model name	: MX-4000						
- Serial number	: Proto type						
- Electrical Rating	: DC 3.7 V (Lithium-polymer battery)						
- Manufacturer	: Summit Technology						
- Frequency Range (DTS band)	TX 20 MHz BW:	2412 MHz - 2462 MHz					
	40 MHz BW:	2422 MHz - 2462 MHz					
	RX 20 MHz BW:	2412 MHz - 2462 MHz					
	40 MHz BW:	2422 MHz - 2462 MHz					
- Frequency Range (UNII band)	TX 20 MHz BW:	5180 MHz - 5240 MHz (UNII 1) / 5260 MHz - 5320 MHz (UNII 2A) / 5500 MHz - 5720 MHz (UNII 2C) / 5745 MHz - 5825 MHz (UNII 3)					
	40 MHz BW:	5190 MHz - 5230 MHz (UNII 1) / 5270 MHz - 5310 MHz (UNII 2A) / 5510 MHz - 5710 MHz (UNII 2C) / 5755 MHz - 5795 MHz (UNII 3)					
	80 MHz BW:	5210 MHz (UNII 1) / 5290 MHz (UNII 2A) / 5530 MHz - 5690 MHz (UNII 2C) / 5775 MHz (UNII 3)					
	RX 20 MHz BW:	5180 MHz - 5240 MHz (UNII 1) / 5260 MHz - 5320 MHz (UNII 2A) / 5500 MHz - 5720 MHz (UNII 2C) / 5745 MHz - 5825 MHz (UNII 3)					
	40 MHz BW:	5190 MHz - 5230 MHz (UNII 1) / 5270 MHz - 5310 MHz (UNII 2A) / 5510 MHz - 5710 MHz (UNII 2C) / 5755 MHz - 5795 MHz (UNII 3)					
	80 MHz BW:	5210 MHz (UNII 1) / 5290 MHz (UNII 2A) / 5530 MHz - 5690 MHz (UNII 2C) / 5775 MHz (UNII 3)					
- Modulation	: BPSK, QPSK, QAM, CCK, OFDM						
- Antenna Specification	: Antenna type : FPCB antenna						
	Gain :						
	Freq. (MHz)	2400	2420	2440	2460	2480	2500
	Gain (dBi)	3.29	3.44	3.50	3.69	3.55	3.56
Freq. (MHz)	5150	5250	5350	5490	5725	5825	
Gain (dBi)	3.11	3.36	3.67	3.70	3.06	3.33	
- Type (DFS)	: Client (without radar detection)						

3.2 Definition of models

-None.





3.3 Support Equipment / Cables used

3.3.1 Used Support Equipment

Description	Manufacturer	Model Name	S/N & FCC ID.
Notebook Computer ¹⁾	SAMSUNG	NT500R3W	S/N: 0Q2V91JJ100096T FCC ID.: N/A

Note)

1) The Support Equipment use only setting to the test mode.

3.3.2 System configuration

Description	Manufacturer	Model Name	S/N & FCC ID.
-	-	-	-

3.3.3 Used Cable(s)

Cable Name	Condition	Description
-	-	-

3.4 Modification Item(s)

-. None



4. Antenna Requirement - §15.203

An intentional radiator antenna shall be designed to ensure that no antenna other than that furnished by the applicant can be used with the device. The use of permanently attached antenna or of an antenna that uses a unique coupling to the intentional radiator shall be considered sufficient to comply with this requirement.

4.1 Description of Antenna

The **Summit Technology Touch Screen Controller**, comply with the requirement of §15.203 with a FPCB antenna permanently attached to the transmitter.

5. Description of tests

5.1 Test Condition

The EUT was installed, arranged and operated in a manner that is most representative of equipment as typically used. The measurements were carried out while varying operating modes and cable positions within typically arrangement to determine maximum emission level.

The representative and worst test mode(s) were noted in the test report.

- Test Voltage / Frequency: 3.7 V / DC
- Operating condition during the test(s) :
 - . Continuous RF transmitting mode with nominal maximum RF output power.
 - . Operating channel frequency and modulation technology

Mode	Available channel	Frequency	Modulation Technology
NII	802.11ac	36 ~ 165	OFDM

- . EUT set condition (Test Software)

Test Software	Android Debug Bridge
Test Software version	N/A

6. References Standards

- FCC Part 15 (2009) Subpart E-UNII Devices §15.407
- KDB 905462 D02 UNII DFS Compliance Procedures New Rules v02 (April 8, 2016): Compliance measurement procedures for unlicensed-National information infrastructure devices operating in the 5250-5350 MHz and 5470-5725 MHz bands incorporating dynamic frequency selection





7. SUMMARY OF TEST RESULTS

FCC Part Section(s)	Test Description	Test Result
§15.407(h)	Channel Closing Transmission Time	Pass
§15.407(h)	Channel Move Time	Pass
§15.407(h)	Non-occupancy Period	Pass

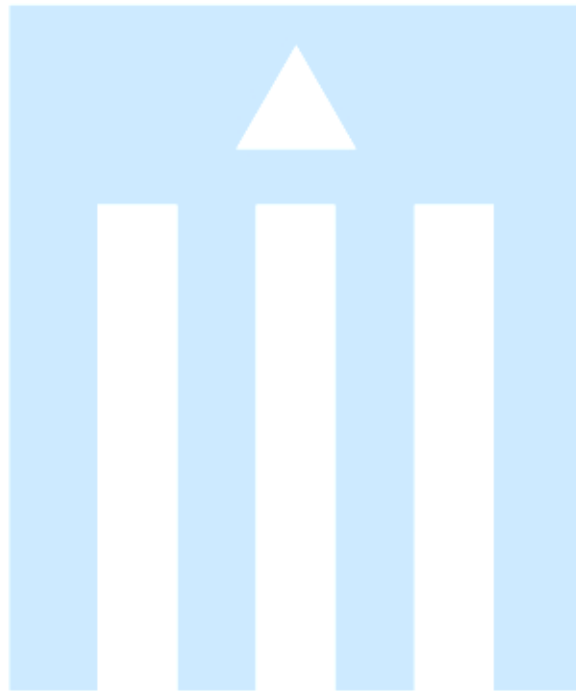



8. Channel Move Time & Channel Closing Transmission Time & Non-occupancy Period

8.1 Operating environment

Temperature : 21.5 °C
 Relative Humidity : 48.2 % R.H.

8.2 Test Set-up (Layout)

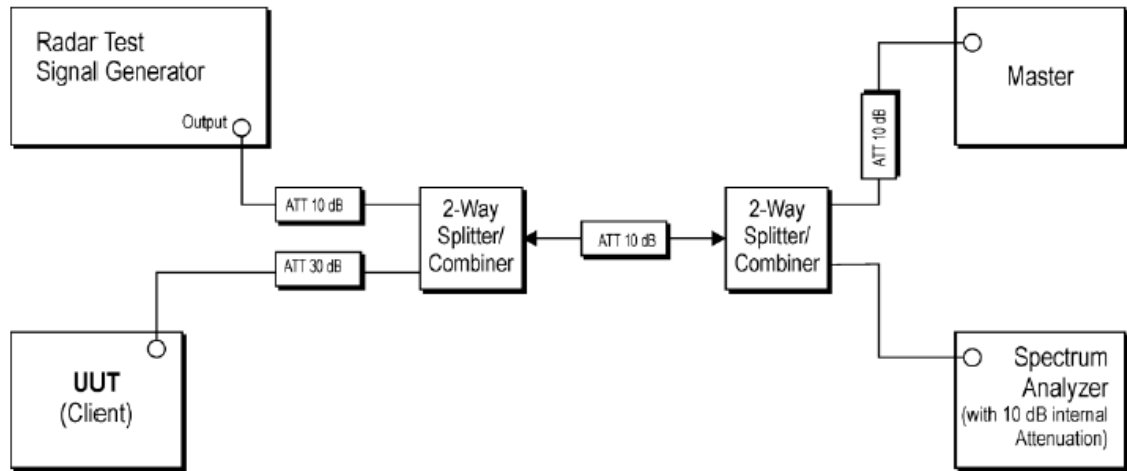

8.3 Limit

- Channel Move Time: 10 seconds
- Channel Closing Transmission Time: 200 ms + aggregate of 60 ms over remaining 10 seconds period
- Non-occupancy Period: 30 minutes

8.4 Test Equipment used

Model Name	Manufacturer	Description	Serial Number	Due to Calibration
■ - FSV	Rohde & Schwarz	Spectrum Analyzer	101552	Apr. 06, 2023
■ - SMB100A	Rohde & Schwarz	Signal Generator	178013	Apr. 06, 2023
■ - SMBV100A	Rohde & Schwarz	Vector Signal Generator	260857	Apr. 06, 2023
■ - OSP120	Rohde & Schwarz	Open Switch and control platform	101327	Jan. 09. 2023
■ - WMS 32	Rohde & Schwarz	Testing Software	VER10.60.20	N/A



8.5 Test Test Procedure

- a) The radar pulse generator is setup to provide a pulse at the frequency that the Master and Client are operating. A Type 0 radar pulse with a 1 μ s pulse width and a 1428 μ s PRI is used for the testing.
- b) The vector signal generator is adjusted to provide the radar burst (18 pulses) at a level of approximately -62 dBm at the antenna of the Master device.
- c) The Client Device (EUT) is set up per the diagram in figure (test set-up) and communications between the Master device and the Client is established.
- d) Software to ping the client is permitted to simulate data transfer but must have random ping intervals.

We used 'windows ping test' software.

- e) The spectrum analyzer is set to record about 20 sec window to any transmissions occurring up to and after 10 sec.
- f) The system is again setup and the monitoring time is shortened in order to capture the Channel Closing Transmission Time. This time is measured to insure that the Client ceases transmission within 200 ms and the aggregate of emissions occurring after 200 ms up to 10 sec do not exceed 60 ms.
(Note: the channel may be different since the Master and Client have changed channels due to the detection of the initial radar pulse.)
- g) After the initial radar burst the channel is monitored for 30 minutes to insure no transmissions or beacons occur. A second monitoring setup is used to verify that the Master and Client have both moved to different channels.



8.6 Test result

- Test Date : Feb. 24, 2023
- Reference Standard : Part 15 Subpart E, Sec. 15.407(h)
- Test Procedure(s) : KDB905462 D02 UNII DFS Compliance Procedures New Rules v02(April 8,2016)
- Operating Condition : RF transmitting mode (802.11ac:VHT20)
- Power Source : DC 3.7 V

802.11ac:VHT20 (UNII 2A:52ch)

Frequency (MHz)	Radar Type No.	Channel Move Time (s)	Limit (s)	Result
5260	0	2.136	10.000	Complies

Frequency (MHz)	Radar Type No.	CCTT ¹⁾ Type of Value	CCTT No. of Pulses found	CCTT (s)	Limit (s)	Result
5260	0	first 200 ms	2	0.884	200.000	Complies
5260	0	remaining 10.0 seconds period	19	8.532	60.000	Complies

1) Channel Closing Transmission Time

Frequency (MHz)	Radar Type No.	Non-occupancy period No. of Pulses found	Limit	Result
5260	0	0	0	Complies

Radar level verification

Description	Value	Unit
Configured DUT EIRP	10.00	mW
Configured DUT PSD	-3.01	dBm/MHz
Requirement of the Detection threshold value for this given values acc. to FCC clause 5.2 / Table 3	-62	dBm
Vector Generator level setting	-1.00	dBm
Configured overall pathloss from Vector Generator RF out to DUT connector of 'DUT to OSP'-cable	33.13	dB
Given additional level added to the amplitude of the waveform to account for variations in measurement equipment acc. to FCC clause 5.2 / Table 3 / Note 2	1.00	dB
This results in the following radar signal level at the DUT	-34.13	dBm





Test Plot

Channel Move Time

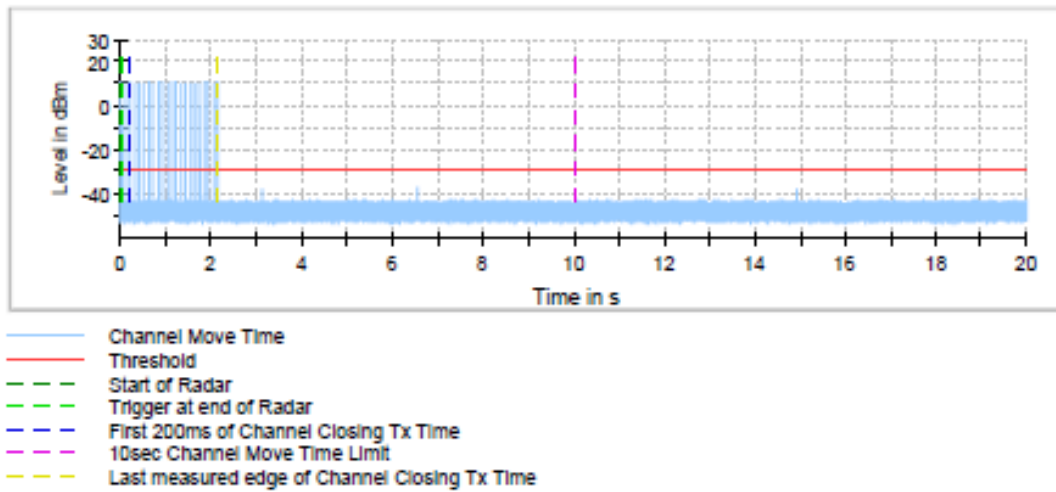

Channel Move Time first 200 ms

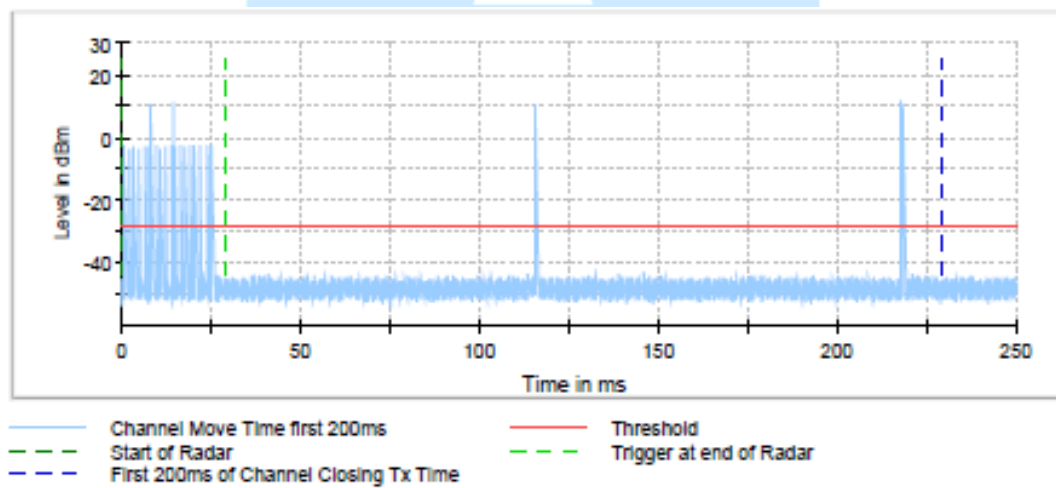

Non-occupancy Period

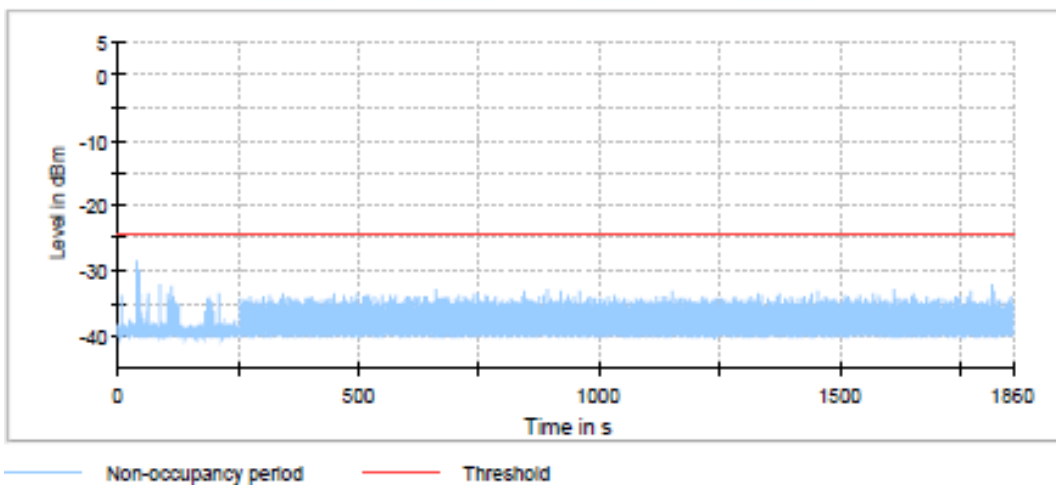



802.11ac:VHT20 (UNII 2C:104ch)

Frequency (MHz)	Radar Type No.	Channel Move Time (s)	Limit (s)	Result
5520	0	0	10.000	Complies

Frequency (MHz)	Radar Type No.	CCTT ¹⁾ Type of Value	CCTT No. of Pulses found	CCTT (s)	Limit (s)	Result
5520	0	first 200 ms	0	0.904	200.000	Complies
5520	0	remaining 10.0 seconds period	0	8.828	60.000	Complies

1) Channel Closing Transmission Time

Frequency (MHz)	Radar Type No.	Non-occupancy period No. of Pulses found	Limit	Result
5520	0	0	0	Complies

Radar level verification

Description	Value	Unit
Configured DUT EIRP	10.00	mW
Configured DUT PSD	-3.01	dBm/MHz
Requirement of the Detection threshold value for this given values acc. to FCC clause 5.2 / Table 3	-62	dBm
Vector Generator level setting	-0.74	dBm
Configured overall pathloss from Vector Generator RF out to DUT connector of 'DUT to OSP'-cable	33.80	dB
Given additional level added to the amplitude of the waveform to account for variations in measurement equipment acc. to FCC clause 5.2 / Table 3 / Note 2	1.00	dB
This results in the following radar signal level at the DUT	-34.54	dBm





Test Plot

Channel Move Time

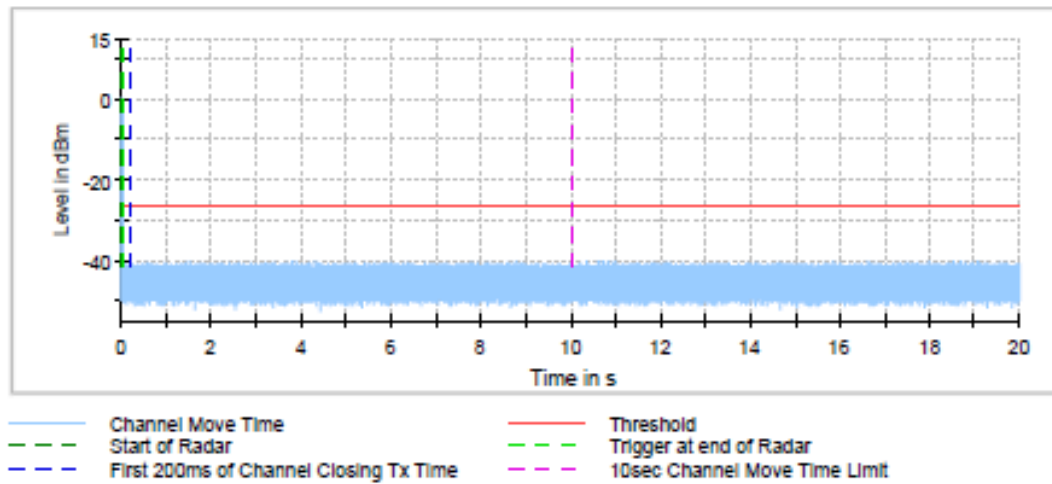

Channel Move Time first 200 ms

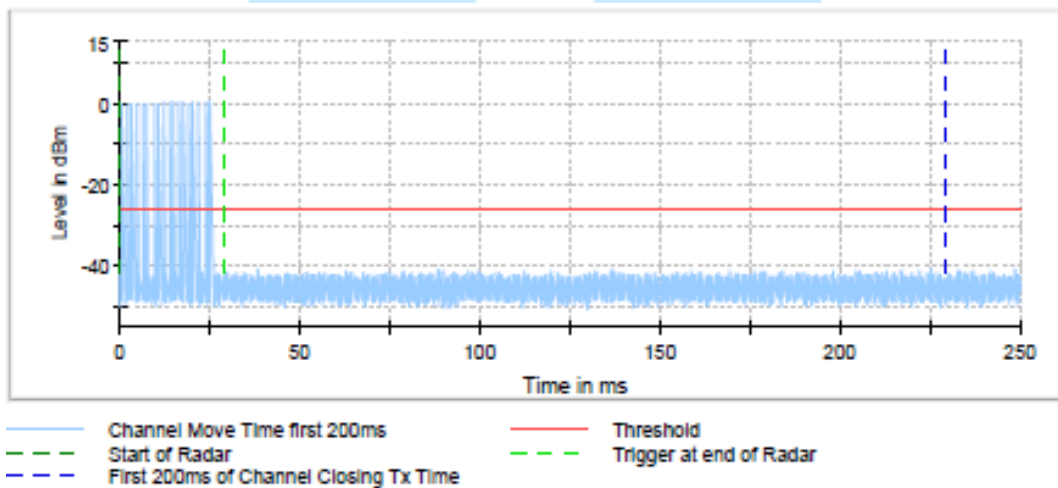

Non-occupancy Period

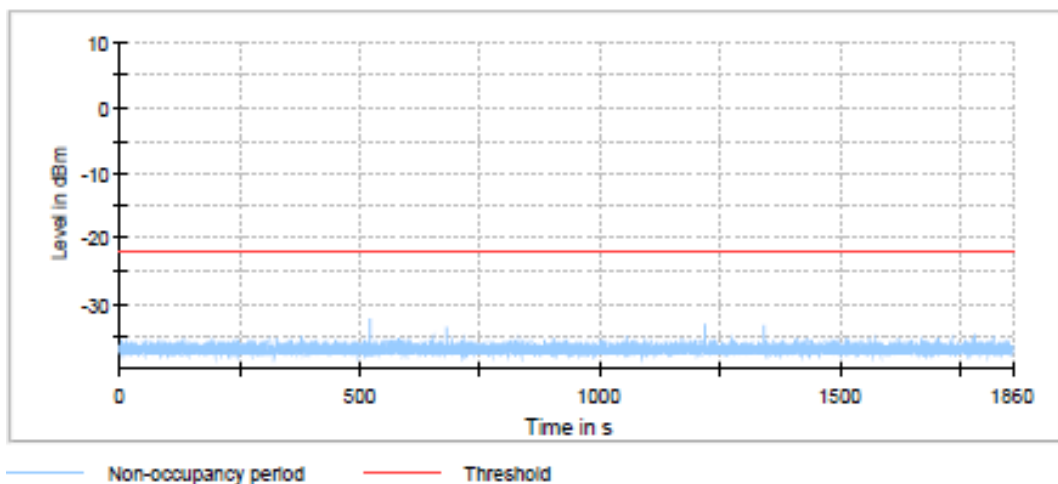



9. Recommendation & Conclusion

The data collected shows that the **Summit Technology Touch Screen Controller (Model Name: MX-4000)** was complies with §15.407 of the FCC Rules.

- The end -

