



FCC TEST REPORT

Test report
On Behalf of
QIANKUN TOYS FACTORY
For

Remote control car series

**Model No.: 11625, PT1932, MT1332, 11808, 11809, 11810,
11811, 11812, 11813, 11814, 11815, 112408, 112409, 112410,
112411, 112412, 112413, 112415, 112416, 112417, 112418,
112419, 112420, 11610, 11611, 11612, 11613, 11615, 11616,
11617, 11618, 11619, 11620, 11621, 11622, 11623, 11626,
11627, 11628, 11629, 11630**

FCC ID: 2AT4G-11625

Prepared For : QIANKUN TOYS FACTORY
CHENG HAI DISTRICT Shantou Guangdong, 515800 China

Prepared By : Shenzhen HUAK Testing Technology Co., Ltd.
1F, B2 Building, Junfeng Zhongcheng Zhizao Innovation Park, Fuhai Street,
Bao'an District, Shenzhen, China

Date of Test: Apr. 14, 2021 ~ May. 21, 2021

Date of Report: May. 21, 2021

Report Number: HK2104141112-E



TEST RESULT CERTIFICATION

Applicant's name: QIANKUN TOYS FACTORY
Address: CHENG HAI DISTRICT Shantou Guangdong, 515800 China
Manufacture's Name.....: QIANKUN TOYS FACTORY
Address: CHENG HAI DISTRICT Shantou Guangdong, 515800 China

Product description

Trade Mark: N/A
Product name.....: Remote control car series
Model and/or type reference ..: 11625, PT1932, MT1332, 11808, 11809, 11810, 11811, 11812, 11813, 11814, 11815, 112408, 112409, 112410, 112411, 112412, 112413, 112415, 112416, 112417, 112418, 112419, 112420, 11610, 11611, 11612, 11613, 11615, 11616, 11617, 11618, 11619, 11620, 11621, 11622, 11623, 11626, 11627, 11628, 11629, 11630

Standards: 47 CFR Part15, Subpart C 15.227

This publication may be reproduced in whole or in part for non-commercial purposes as long as the Shenzhen HUAK Testing Technology Co., Ltd. is acknowledged as copyright owner and source of the material. Shenzhen HUAK Testing Technology Co., Ltd. takes no responsibility for and will not assume liability for damages resulting from the reader's interpretation of the reproduced material due to its placement and context.

Date of Test:
Date (s) of performance of tests: Apr. 14, 2021 ~ May. 21, 2021
Date of Issue.....: May. 21, 2021
Test Result.....: **Pass**

Testing Engineer : *Gary Qian*

 (Gary Qian)

Technical Manager : *Eden Hu*

Authorized Signatory : 

 (Jason Zhou)



TABLE OF CONTENTS

1. TEST RESULT SUMMARY	5
1.1. TEST FACILITY	5
1.2. MEASUREMENT UNCERTAINTY	5
2. EUT DESCRIPTION	6
3. GENERA INFORMATION	7
3.1. TEST ENVIRONMENT AND MODE	7
3.2. DESCRIPTION OF SUPPORT UNITS	7
4. TEST RESULTS AND MEASUREMENT DATA	8
4.1. ANTENNA REQUIREMENT	8
4.2. CONDUCTED EMISSION	9
4.3. RADIATED EMISSION MEASUREMENT	11
4.4. OCCUPIED BANDWIDTH	17
5. Appendix A: PHOTOGRAPHS OF TEST SETUP	19
6. Appendix B: PHOTOS OF THE EUT	20



**** Modified History ****

Revision	Description	Issued Data	Remark
Revision 1.0	Initial Test Report Release	May. 21, 2021	Jason Zhou



1. TEST RESULT SUMMARY

Requirement	CFR 47 Section	Result
Conduction Emission, 0.15MHz to 30MHz	§15.207	N/A
Radiation Emission	§15.227, §15.205, §15.209	PASS
Occupied Bandwidth	§15.215	PASS
Antenna requirement	§15.203	PASS

Note:

1. PASS: Test item meets the requirement.
2. Fail: Test item does not meet the requirement.
3. N/A: Test case does not apply to the test object.
4. The test result judgment is decided by the limit of test standard.

1.1. TEST FACILITY

Test Firm : Shenzhen HUAKE Testing Technology Co., Ltd.

Address : 1F, B2 Building, Junfeng Zhongcheng Zhizao Innovation Park,
Fuhai Street, Bao'an District, Shenzhen, China

FCC designation number : CN1229

test firm registration number : 616276

1.2. MEASUREMENT UNCERTAINTY

Measurement Uncertainty

Conducted Emission Expanded Uncertainty = 2.71dB, k=2

Radiated emission expanded uncertainty(9kHz-30MHz) = 3.90dB, k=2

Radiated emission expanded uncertainty(30MHz-1000MHz) = 3.90dB, k=2

Radiated emission expanded uncertainty(Above 1GHz) = 4.28dB, k=2



2. EUT DESCRIPTION

Equipment :	Remote control car series
Model Name:	11625
Serial No:	PT1932, MT1332, 11808, 11809, 11810, 11811, 11812, 11813, 11814, 11815, 112408, 112409, 112410, 112411, 112412, 112413, 112415, 112416, 112417, 112418, 112419, 112420, 11610, 11611, 11612, 11613, 11615, 11616, 11617, 11618, 11619, 11620, 11621, 11622, 11623, 11626, 11627, 11628, 11629, 11630
Model Difference:	All model's the function, software and electric circuit are the same, only with a product color, appearance, model named different for commercial purpose. Test sample model:11625.
FCC ID:	2AT4G-11625
Antenna Type:	External Antenna
Antenna Gain:	1dBi
Operation frequency:	27.145MHz
Modulation Type:	ASK
Power Source:	DC 3V from Battery
Power Rating:	DC 3V from Battery



3. GENERA INFORMATION

3.1. TEST ENVIRONMENT AND MODE

Operating Environment:	
Temperature:	24.0 °C
Humidity:	54 % RH
Atmospheric Pressure:	1010 mbar
Test Mode:	
Operation mode:	Keep the EUT in continuous transmitting with modulation
<p>The sample was placed (0.8m below 1GHz) above the ground plane of 3m chamber. Measurements in both horizontal and vertical polarities were performed. During the test, each emission was maximized by: having the EUT continuously working, investigated all operating modes, rotated about all 3 axis (X, Y & Z) and considered typical configuration to obtain worst position, manipulating interconnecting cables, rotating the turntable, varying antenna height from 1m to 4m in both horizontal and vertical polarizations. The emissions worst-case are shown in Test Results of the following pages.</p>	

Per-test mode.			
We have verified the construction and function in typical operation, The EUT was placed on three different polar directions; i.e. X axis, Y axis, Z axis. which was shown in this test report and defined as follows:			
Axis	X	Y	Z
Field Strength(dBuV/m)	62.47	65.62	62.59
Final Test Mode:			
According to ANSI C63.10 standards, the test results are both the “worst case” and “worst setup”: Y axis (see the test setup photo)			

3.2. DESCRIPTION OF SUPPORT UNITS

The EUT has been tested as an independent unit together with other necessary accessories or support units. The following support units or accessories were used to form a representative test configuration during the tests.

Equipment	Model No.	Serial No.	FCC ID	Trade Name
/	/	/	/	/

Note:

1. All the equipment/cables were placed in the worst-case configuration to maximize the emission during the test.
2. Grounding was established in accordance with the manufacturer's requirements and conditions for the intended use.

4. TEST RESULTS AND MEASUREMENT DATA

4.1. ANTENNA REQUIREMENT

Standard requirement:	FCC Part15 C Section 15.203
15.203 requirement: An intentional radiator shall be designed to ensure that no antenna other than that furnished by the responsible party shall be used with the device. The use of a permanently attached antenna or of an antenna that uses a unique coupling to the intentional radiator, the manufacturer may design the unit so that a broken antenna can be replaced by the user, but the use of a standard antenna jack or electrical connector is prohibited.	
E.U.T Antenna:	External Antenna
The antenna used in this product is a External Antenna, It conforms to the standard requirements.The directional gains of antenna used for transmitting is 1dBi.	
A photograph showing the internal components of a device, including a printed circuit board (PCB) with various electronic components and a thin, yellow antenna. The device is placed on a blue surface next to a black ruler for scale. A red box with a white border and an arrow points to the antenna, with the text "27.145MHz ANT." written inside in red. The ruler shows measurements in millimeters and centimeters.	



4.2. CONDUCTED EMISSION

4.2.1. Conducted Power Line Emission Limit

For unintentional device, according to § 15.107(a) Line Conducted Emission Limits is as following.

Frequency (MHz)	Maximum RF Line Voltage (dB μ V)			
	CLASS A		CLASS B	
	Q.P.	Ave.	Q.P.	Ave.
0.15 - 0.50	79	66	66-56*	56-46*
0.50 - 5.00	73	60	56	46
5.00 - 30.0	73	60	60	50

* Decreasing linearly with the logarithm of the frequency

For intentional device, according to §15.207(a) Line Conducted Emission Limit is same as above table.

4.2.2. Test Setup

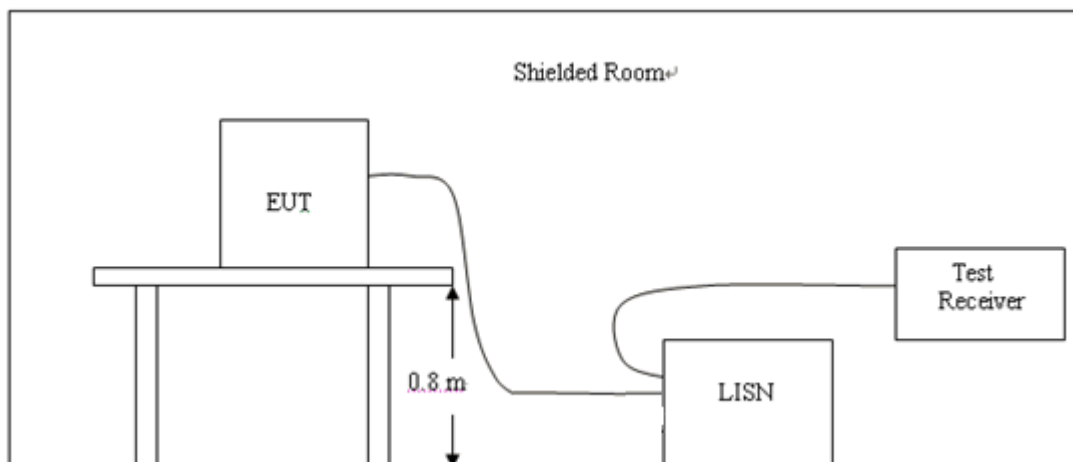

4.2.3. Test Procedure

1. The equipment was set up as per the test configuration to simulate typical actual usage per the user's manual. The EUT is a tabletop system, a wooden table with a height of 0.8 meters is used and is placed on the ground plane as per ANSI C63.10.
2. Support equipment, if needed, was placed as per ANSI C63.10.
3. All I/O cables were positioned to simulate typical actual usage as per ANSI C63.10.
4. If a EUT received DC power from the USB Port of Notebook PC, the PC's adapter received AC120V/60Hz power through a Line Impedance Stabilization Network (LISN) which supplied power source and was grounded to the ground plane.
5. All support equipments received AC power from a second LISN, if any.
6. The EUT test program was started. Emissions were measured on each current carrying line of the EUT using a spectrum Analyzer / Receiver connected to the LISN powering the EUT. The LISN has two monitoring points: Line 1 (Hot Side) and Line 2 (Neutral Side). Two scans were taken: one with Line 1 connected to Analyzer / Receiver and Line 2 connected to a 50 ohm load; the second scan had Line 1 connected to a 50 ohm load and Line 2 connected to the Analyzer / Receiver.
7. Analyzer / Receiver scanned from 150 KHz to 30MHz for emissions in each of the test modes.



4.2.4. Test Result

Not applicable

Note: EUT power supply by DC Power, so this test item not applicable.



4.3. RADIATED EMISSION MEASUREMENT

4.3.1. Test Specification

Test Requirement:	FCC Part15 C Section 15.227 and 15.209				
Test Method:	ANSI C63.10:2013				
Frequency Range:	9 kHz to 1 GHz				
Measurement Distance:	3 m				
Antenna Polarization:	Horizontal & Vertical				
Receiver Setup:	Frequency	Detector	RBW	VBW	Remark
	9kHz- 150kHz	Quasi-peak	200Hz	1kHz	Quasi-peak Value
	150kHz- 30MHz	Quasi-peak	9kHz	30kHz	Quasi-peak Value
	30MHz-1GHz	Quasi-peak	120KHz	300KHz	Quasi-peak Value
	<ol style="list-style-type: none"> 1. The EUT was placed on the top of a rotating table 0.8 meters above the ground at a 3 meter camber in below 1GHz. The table was rotated 360 degrees to determine the position of the highest radiation. 2. The EUT was set 3 meters away from the interference-receiving antenna, which was mounted on the top of a variable-height antenna tower. 3. The antenna height is varied from one meter to four meters above the ground to determine the maximum value of the field strength. Both horizontal and vertical polarizations of the antenna are set to make the measurement. 4. For each suspected emission, the EUT was arranged to its worst case and then the antenna was tuned to heights from 1 meter to 4 meters and the rotatable table was turned from 0 degrees to 360 degrees to find the maximum reading. 5. The test-receiver system was set to Peak Detect Function and Specified Bandwidth with Maximum Hold Mode. 6. If the emission level of the EUT in peak mode was 10dB lower than the limit specified, then testing could be stopped and the peak values of the EUT would be reported. Otherwise the emissions that did not have 10dB margin would be re-tested one by one using peak, quasi-peak or average method as specified and then reported in a data sheet. 				

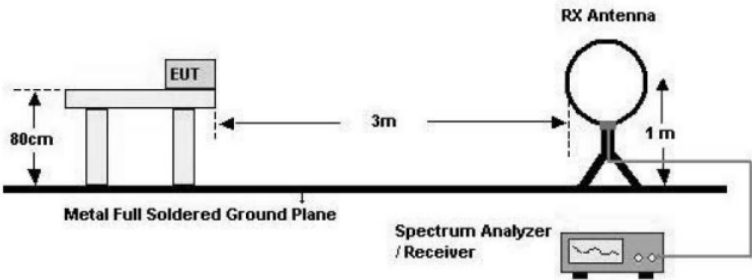
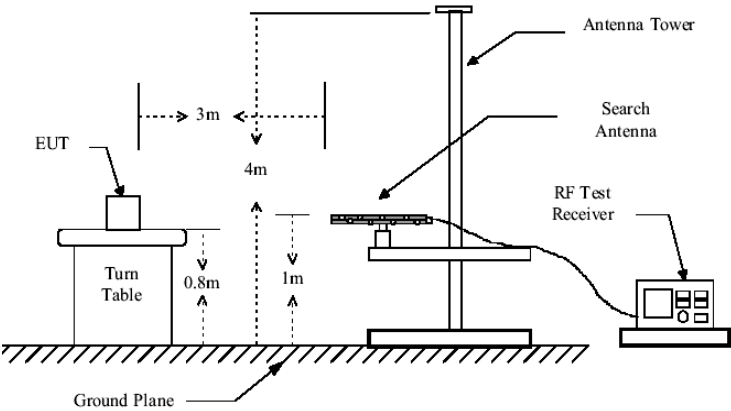
<p>Test setup:</p>	<p>For radiated emissions</p> <p>Below 30 MHz</p>  <p>30MHz to 1GHz</p> 
	<p>Test Mode: Transmitting Mode</p> <p>Test results: PASS</p>

4.3.2. Limit

(a) The field strength of any emission within this band shall not exceed 10,000 microvolts/meter at 3 meters. The emission limit in this paragraph is based on measurement instrumentation employing an average detector. The provisions in §15.35 for limiting peak emissions apply.

(b) The field strength of any emissions which appear outside of this band shall not exceed the general radiated emission limits in §15.209.



4.3.3. Frequencies in restricted band are complied to limit on Paragraph 15.209

Frequency Range (MHz)	Distance (m)	Field strength (dB μ V/m)	Field strength (microvolts/meter)
0.009-0.490	300	20log 2400/F (kHz)	2400/F (kHz)
0.490-1.705	30	20log 24000/F (kHz)	24000/F (kHz)
1.705-30	30	20log 30	30
30-88	3	40.0	100**
88-216	3	43.5	150**
216-960	3	46.0	200**
Above 960	3	54.0	500

NOTE:

**Except as provided in paragraph (g), fundamental emissions from intentional radiators operating under this section shall not be located in the frequency bands 54-72 MHz, 76-88 MHz, 174-216 MHz or 470-806 MHz. However, operation within these frequency bands is permitted under other sections of this part, e.g., S 15.231 and 15.241.

4.3.4. Test Instruments

Radiated Emission Test Site (966)				
Name of Equipment	Manufacturer	Model	Serial Number	Calibration Due
ESPI Test Receiver	ROHDE&SCHWARZ	ESVD	100008	Jun. 17, 2021
Spectrum Analyzer	ROHDE&SCHWARZ	FSEM	848597/001	Jun. 17, 2021
Pre-amplifier	EM Electronics Corporation CO.,LTD	EM30265	07032613	Jun. 17, 2021
Pre-amplifier	HP	8447D	2727A05017	Jun. 17, 2021
Loop antenna	ZHINAN	ZN30900A	12024	Jun. 17, 2021
Broadband Antenna	Schwarzbeck	VULB9163	340	Jun. 17, 2021
Horn Antenna	Schwarzbeck	BBHA 9120D	631	Jun. 17, 2021
Coax cable	HUAK	N/A	N/A	Jun. 17, 2021
Coax cable	HUAK	N/A	N/A	Jun. 17, 2021
Coax cable	HUAK	N/A	N/A	Jun. 17, 2021
Coax cable	HUAK	N/A	N/A	Jun. 17, 2021
EMI Test Software	Shurple Technology	EZ-EMC	N/A	N/A

Note: The calibration interval of the above test instruments is 12 months and the calibrations are traceable to international system unit (SI).



4.3.5. Test Data

PASS

Note: this EUT was tested for all models and the worst case model (DC3V) data was reported.

Field Strength of Fundamental

Frequency (MHz)	Reading (dBuV/m)	Correction Factor(dB/m)	Result (dBuV/m)	Limit (dBuV/m)	Margin (dB)	Detector
27.145	53.64	12.33	65.97	80	-14.03	Peak
27.145	52.43	12.33	64.76	80	-15.24	Peak

Remark: Margin = Result - Limit

Result = Reading +Correction Factor

Correction Factor = Antenna Factor + Cable Factor

The Peak test value has met the Ave limit, so the default Ave value meets the requirements.

Spurious Emissions

Frequency Range (9kHz-30MHz)

Frequency (MHz)	Level@3m (dB μ V/m)	Limit@3m (dB μ V/m)
--	--	--
--	--	--
--	--	--
--	--	--

Note: 1. Emission Level=Reading+ Cable loss+ Antenna factor-Amp factor.

2. The emission levels are 20 dB below the limit value, which are not reported. It is deemed to comply with the requirement.



About 30MHz-1GHz

Note: this EUT was tested, the worst case position data was reported.

Horizontal



Suspected List									
NO.	Freq. [MHz]	Factor [dB]	Reading [dBµV/m]	Level [dBµV/m]	Limit [dBµV/m]	Margin [dB]	Height [cm]	Angle [°]	Polarity
1	45.5355	-13.65	49.08	35.43	40.00	4.57	100	197	Horizontal
2	173.7037	-17.14	52.52	35.38	43.50	8.12	100	191	Horizontal
3	264.9750	-13.59	52.38	38.79	46.00	7.21	100	188	Horizontal
4	306.7267	-12.65	54.02	41.37	46.00	4.63	100	5	Horizontal
5	669.8699	-4.57	45.10	40.53	46.00	5.47	100	306	Horizontal
6	798.0380	-3.15	45.70	42.55	46.00	3.45	100	123	Horizontal

Remark: Factor = Cable loss + Antenna factor – Preamplifier; Level = Reading + Factor; Margin = Limit – Level



Vertical

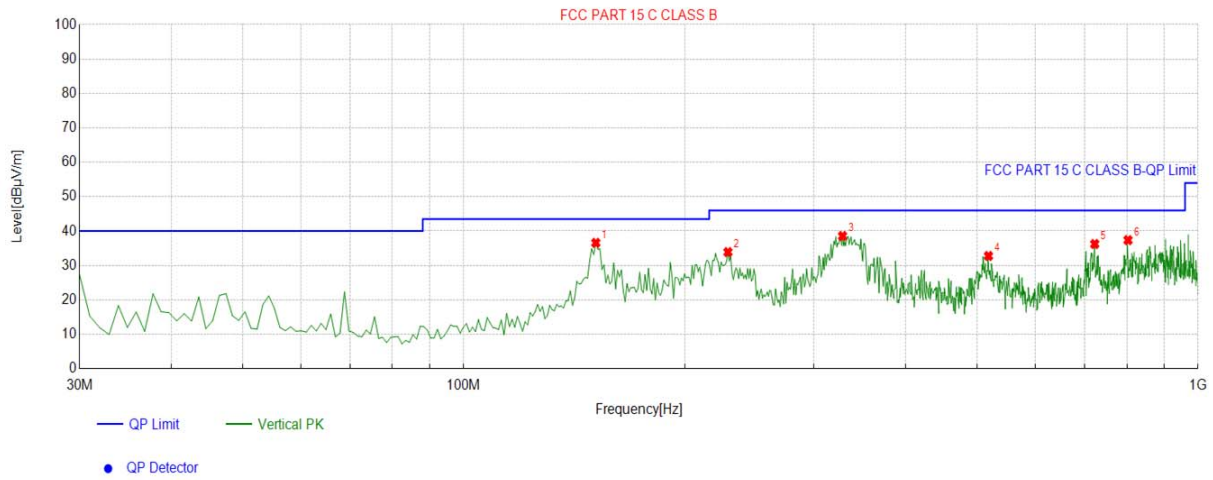

Suspected List									
NO.	Freq. [MHz]	Factor [dB]	Reading [dBµV/m]	Level [dBµV/m]	Limit [dBµV/m]	Margin [dB]	Height [cm]	Angle [°]	Polarity
1	151.3714	-18.84	55.42	36.58	43.50	6.92	100	56	Vertical
2	229.0490	-14.34	48.23	33.89	46.00	12.11	100	299	Vertical
3	328.0881	-11.69	50.24	38.55	46.00	7.45	100	250	Vertical
4	518.3984	-7.77	40.53	32.76	46.00	13.24	100	12	Vertical
5	723.2733	-4.65	40.90	36.25	46.00	9.75	100	12	Vertical
6	802.8929	-3.07	40.45	37.38	46.00	8.62	100	164	Vertical

Remark: Factor = Cable loss + Antenna factor – Preamplifier; Level = Reading + Factor; Margin = Limit – Level



4.4. OCCUPIED BANDWIDTH

4.4.1. Test Specification

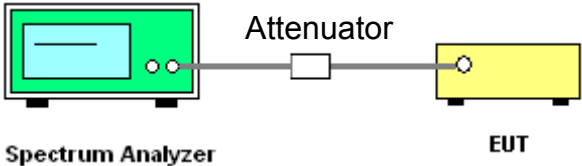
Test Requirement:	FCC Part15 C Section 15.215
Test Method:	ANSI C63.10: 2013
Limit:	N/A
	<ol style="list-style-type: none"> 1. According to the follow Test-setup, keep the relative position between the artificial antenna and the EUT. 2. Set to the maximum power setting and enable the EUT transmit continuously. 3. Use the following spectrum analyzer settings for 20dB Bandwidth measurement. Span = approximately 2 to 3 times the 20 dB bandwidth, centered on a hopping channel; RBW=1% to 5% of the occupied bandwidth; VBW=3RBW; Sweep = auto; Detector function = peak; Trace = max hold. 4. Measure and record the results in the test report.
Test setup:	 <p>The diagram illustrates the test setup. On the left is a Spectrum Analyzer (green box). A cable connects it to an Attenuator (white box). Another cable connects the Attenuator to the EUT (yellow box). Labels 'Spectrum Analyzer', 'Attenuator', and 'EUT' are placed below their respective components.</p>
Test Mode:	Transmitting Mode
Test results:	PASS

4.4.2. Test Instruments

RF Test Room				
Equipment	Manufacturer	Model	Serial Number	Calibration Due
Spectrum Analyzer	Agilent	N9020A	MY49100060	Jun. 17, 2021

Note: The calibration interval of the above test instruments is 12 months and the calibrations are traceable to international system unit (SI).



4.4.3. Test data

Test Channel (MHz)	20dB Occupy Bandwidth (kHz)	Limit (kHz)	Conclusion
27.145	6.204	N/A	PASS

Test plots as follows:

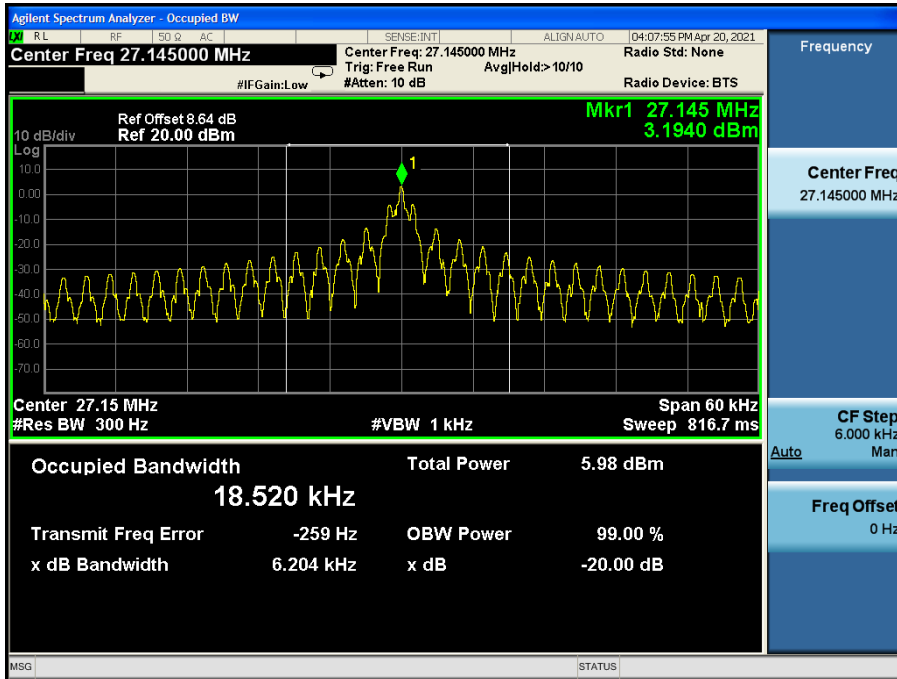



5. Appendix A: PHOTOGRAPHS OF TEST SETUP

Radiated Emission

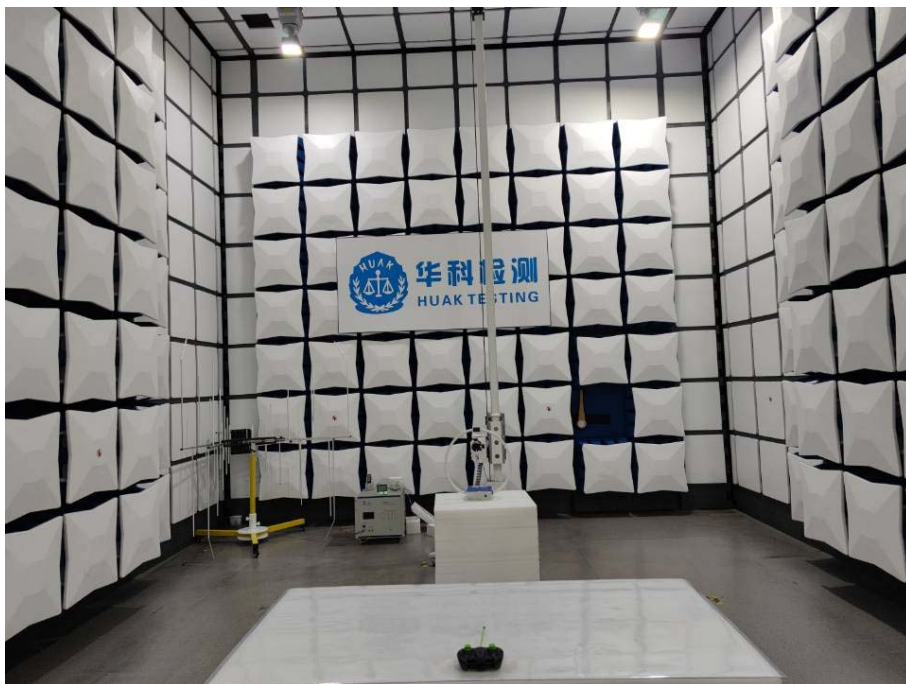
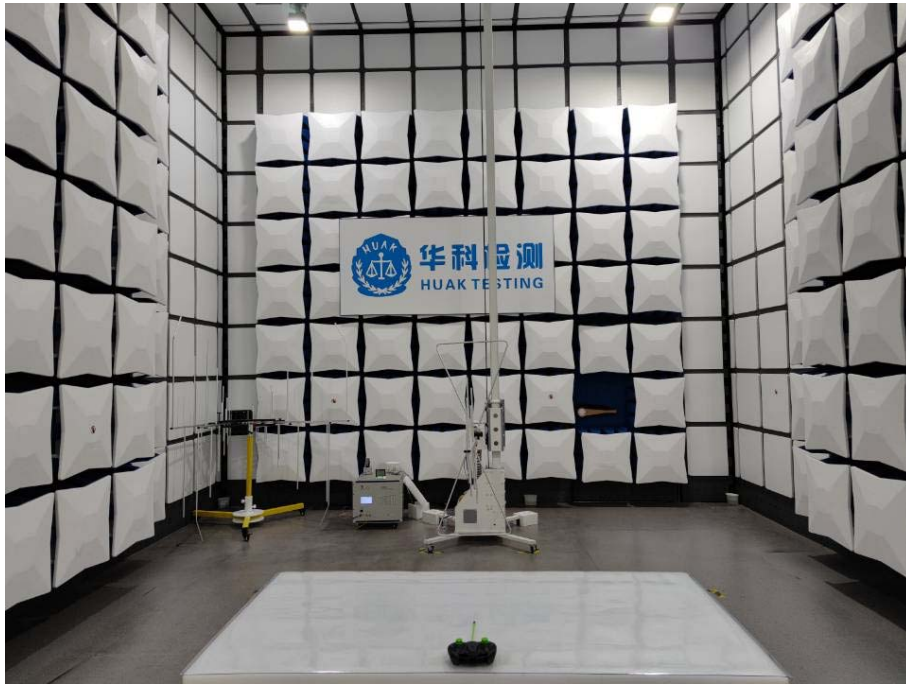



6. Appendix B: PHOTOS OF THE EUT

Reference to the report: ANNEX A of external photos and ANNEX B of internal photos.

*******END OF REPORT*******