



RF TEST REPORT

Applicant SAGETEL (HONG KONG) CO. LIMITED
FCC ID 2AT2L-HINTO-LITE
Product 4G Feature Phone
Brand altice; Sagetel
Model altice F4; Sagetel Hinto lite
Report No. R2205A0384-R3
Issue Date June 1, 2022

TA Technology (Shanghai) Co., Ltd. tested the above equipment in accordance with the requirements in **FCC CFR47 Part 2 (2021)/ FCC CFR47 Part 27C (2021)**. The test results show that the equipment tested is capable of demonstrating compliance with the requirements as documented in this report.

Prepared by: Peng Tao

Approved by: Kai Xu

TA Technology (Shanghai) Co., Ltd.

No.145, Jintang Rd, Tangzhen Industry Park, Pudong Shanghai, China

TEL: +86-021-50791141/2/3

FAX: +86-021-50791141/2/3-8000



TABLE OF CONTENT

1	Test Laboratory	4
1.1	Notes of the Test Report	4
1.2.	Test facility	4
1.3	Testing Location	4
2	General Description of Equipment under Test	5
2.1	Applicant and Manufacturer Information	5
2.2	General information	5
3	Applied Standards	6
4	Test Configuration	7
5	Test Case	8
5.1	RF Power Output and Effective Isotropic Radiated Power	8
5.2	Occupied Bandwidth	9
5.3	Band Edge Compliance	10
5.4	Peak-to-Average Power Ratio (PAPR)	11
5.5	Frequency Stability	12
5.6	Spurious Emissions at Antenna Terminals	13
5.7	Radiates Spurious Emission	15
6	Test Results	18
6.1	RF Power Output and Effective Isotropic Radiated Power	18
6.2	Occupied Bandwidth	21
6.3	Band Edge Compliance	28
6.4	Peak-to-Average Power Ratio (PAPR)	36
6.5	Frequency Stability	37
6.6	Spurious Emissions at Antenna Terminals	40
6.7	Radiates Spurious Emission	44
7	Main Test Instruments	46
	ANNEX A: The EUT Appearance	47
	ANNEX B: Test Setup Photos	48



Summary of Measurement Results

Number	Test Case	Clause in FCC rules	Verdict
1	RF Power Output and Effective Isotropic Radiated Power	2.1046 27.50(d)(4)	PASS
2	Occupied Bandwidth	2.1049	PASS
3	Band Edge Compliance	27.53(h)	PASS
4	Peak-to-Average Power Ratio	27.50(d)/KDB971168 D01(5.7)	PASS
5	Frequency Stability	2.1055 / 27.54	PASS
6	Spurious Emissions at Antenna Terminals	2.1051 27.53(h)	PASS
7	Radiates Spurious Emission	2.1053 27.53(h)	PASS

Date of Testing: May 9, 2022 ~ May 13, 2022 and May 22, 2022
Date of Sample Received: May 5, 2022

Note: PASS: The EUT complies with the essential requirements in the standard.
FAIL: The EUT does not comply with the essential requirements in the standard.
All indications of Pass/Fail in this report are opinions expressed by TA Technology (Shanghai) Co., Ltd. based on interpretations and/or observations of test results. Measurement Uncertainties were not taken into account and are published for informational purposes only.



1 Test Laboratory

1.1 Notes of the Test Report

This report shall not be reproduced in full or partial, without the written approval of **TA technology (shanghai) co., Ltd.** The results documented in this report apply only to the tested sample, under the conditions and modes of operation as described herein .Measurement Uncertainties were not taken into account and are published for informational purposes only. This report is written to support regulatory compliance of the applicable standards stated above.

1.2. Test facility

FCC (Designation number: CN1179, Test Firm Registration Number: 446626)

TA Technology (Shanghai) Co., Ltd. has been listed on the US Federal Communications Commission list of test facilities recognized to perform measurements.

A2LA (Certificate Number: 3857.01)

TA Technology (Shanghai) Co., Ltd. has been listed by American Association for Laboratory Accreditation to perform measurement.

1.3 Testing Location

Company: TA Technology (Shanghai) Co., Ltd.
Address: No.145, Jintang Rd, Tangzhen Industry Park, Pudong Shanghai, China
City: Shanghai
Post code: 201201
Country: P. R. China
Contact: Xu Kai
Telephone: +86-021-50791141/2/3
Fax: +86-021-50791141/2/3-8000
Website: <http://www.ta-shanghai.com>
E-mail: xukai@ta-shanghai.com

2 General Description of Equipment under Test

2.1 Applicant and Manufacturer Information

Applicant	SAGETEL (HONG KONG) CO. LIMITED
Applicant address	FLAT D39. 8/F WAH LOK IND CTR PHASE 2, 31-35 SHAN MEI ST FO TAN SHATIN NT
Manufacturer	SAGETEL (HONG KONG) CO. LIMITED
Manufacturer address	FLAT D39. 8/F WAH LOK IND CTR PHASE 2, 31-35 SHAN MEI ST FO TAN SHATIN NT

2.2 General information

EUT Description			
Model	altice F4; Sagetel Hinto lite		
IMEI	352847500227382		
Hardware Version	V01E		
Software Version	ALTICE_GX2421L_SS_L_V01_FCC_220428		
Power Supply	Battery / AC adapter		
Antenna Type	PIFA Antenna		
Antenna Gain	-1.5dBi		
Test Mode(s)	LTE Band 4;		
Test Modulation	(LTE)QPSK, 16QAM;		
LTE Category	4		
Maximum E.I.R.P./ E.R.P.	LTE Band 4:	19.87dBm	
Rated Power Supply Voltage	3.8V		
Operating Voltage	Minimum: 3.6V Maximum: 4.2V		
Operating Temperature	Lowest: -10°C Highest: +55°C		
Testing Temperature	Lowest: -30°C Highest: +50°C		
Operating Frequency Range(s)	Mode	Tx (MHz)	Rx (MHz)
	LTE Band 4	1710 ~ 1755	2110 ~ 2155
EUT Accessory			
Adapter	Manufacturer: DongGuan AoHai Power Technology Co.Ltd. Model: A31A-050055U-US1		
Battery	Manufacturer: Shenzhen Aerospace Electronic.Co.Ltd Model: 178245411		
Earphone	Manufacturer: Baoshan Dahuahaihan Technology Co.,Ltd. Model: 3.5_balck_stereophony without mic_HTC		
<p>Note: 1. The EUT is sent from the applicant to TA and the information of the EUT is declared by the applicant.</p> <p>2. The customer claims that altice F4 and Sagetel Hinto lite are only different in model, and the others are the same.</p>			



3 Applied Standards

According to the specifications of the manufacturer, it must comply with the requirements of the following standards:

Test standards:

FCC CFR47 Part 27C (2021)

FCC CFR47 Part 2 (2021)

Reference standard:

ANSI C63.26-2015

KDB 971168 D01 Power Meas License Digital Systems v03r01

4 Test Configuration

Radiated measurements are performed by rotating the EUT in three different orthogonal test planes. EUT stand-up position (Z axis), lie-down position (X, Y axis). Receiver antenna polarization (horizontal and vertical), the worst emission was found in position (X axis, vertical polarization) and the worst case was recorded.

All mode and data rates and positions and RB size and modulations were investigated. Subsequently, only the worst case emissions are reported.

The following testing in LTE is set based on the maximum RF Output Power.

The following testing in different Bandwidth is set to detail in the following table:

Test modes are chosen to be reported as the worst case configuration below:

Test modes are chosen to be reported as the worst case configuration below for LTE Band 4:

Test items	Modes	Bandwidth (MHz)						Modulation		RB			Test Channel		
		1.4	3	5	10	15	20	QPSK	16QAM	1	50%	100%	L	M	H
RF Power Output and Effective Isotropic Radiated Power	LTE 4	O	O	O	O	O	O	O	O	O	O	O	O	O	O
Occupied Bandwidth	LTE 4	O	O	O	O	O	O	O	O	-	-	O	O	O	O
Band Edge Compliance	LTE 4	O	O	O	O	O	O	O	O	O	-	O	O	-	O
Peak-to-Average Power Ratio	LTE 4	O	O	O	O	O	O	O	O	-	-	O	O	O	O
Frequency Stability	LTE 4	O	O	O	O	O	O	O	O	O	-	-	-	O	-
Spurious Emissions at Antenna Terminals	LTE 4	O	O	O	O	O	O	O	-	O	-	-	O	O	O
Radiates Spurious Emission	LTE 4	O	-	O	-	-	O	O	-	O	-	-	-	O	-
Note	1. The mark "O" means that this configuration is chosen for testing. 2. The mark "-" means that this configuration is not testing.														

5 Test Case

5.1 RF Power Output and Effective Isotropic Radiated Power

Ambient condition

Temperature	Relative humidity	Pressure
23°C ~25°C	45%~50%	101.5kPa

Methods of Measurement

During the process of the testing, The EUT was connected to the Base Station Simulator with a known loss. The EUT is controlled by the Base Station Simulator test set to ensure max power transmission with proper modulation.

ERP can then be calculated as follows:

$$\text{EIRP (dBm)} = \text{Output Power (dBm)} - \text{Losses (dB)} + \text{Antenna Gain (dBi)}$$

where:dBd refers to gain relative to an ideal dipole.

$$\text{EIRP (dBm)} = \text{ERP (dBm)} + 2.15 \text{ (dB.)}$$

Test Setup

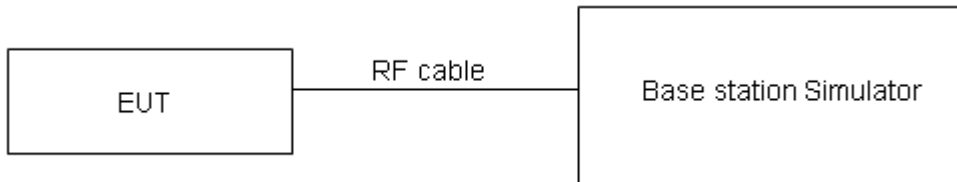

Limits

No specific RF power output requirements in part 2.1046.

Rule Part 27.50(d) (4) specifies that “Fixed, mobile and portable (hand-held) stations operating in the 1710–1755 MHz band are limited to 1 watt EIRP”

Part 27.50(d)(4)Limit	$\leq 1 \text{ W (30 dBm)}$
-----------------------	-----------------------------

Measurement Uncertainty

The assessed measurement uncertainty to ensure 95% confidence level for the normal distribution is with the coverage factor $k = 2$, $U=0.4 \text{ dB}$ for RF power output, $k = 2$, $U= 1.19 \text{ dB}$ for ERP/EIRP.

Test Results

Refer to the section 6.1 of this report for test data.

5.2 Occupied Bandwidth

Ambient condition

Temperature	Relative humidity	Pressure
23°C ~25°C	45%~50%	101.5kPa

Method of Measurement

The EUT was connected to Spectrum Analyzer and Base Station Simulator via power Splitter. The occupied bandwidth is measured using spectrum analyzer.

RBW is set to $\geq 1\%EBW$, VBW is set to 3x RBW.

99% power and -26dBc occupied bandwidths are recorded. Spectrum analyzer plots are included on the following pages.

Test Setup

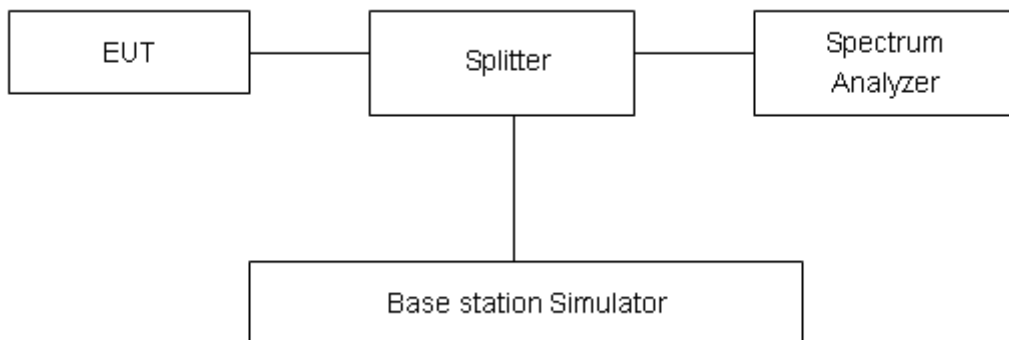

Limits

No specific occupied bandwidth requirements in part 2.1049.

Measurement Uncertainty

The assessed measurement uncertainty to ensure 95% confidence level for the normal distribution is with the coverage factor $k = 2$, $U=624\text{Hz}$.

Test Results

Refer to the section 6.2 of this report for test data.

5.3 Band Edge Compliance

Ambient condition

Temperature	Relative humidity	Pressure
23°C ~25°C	45%~50%	101.5kPa

Method of Measurement

The EUT was connected to Spectrum Analyzer and Base Station Simulator via power Splitter. The band edge of the lowest and highest channels were measured.

The testing follows KDB 971168 D01 v03r01 Section 6.0

The EUT was connected to spectrum analyzer and system simulator via a power divider.

The band edges of low and high channels for the highest RF powers were measured.

RBW is set to $\geq 1\%EBW$, VBW is set to 3x RBW.

on spectrum analyzer.

Set spectrum analyzer with RMS detector.

The RF fundamental frequency should be excluded against the limit line in the operating frequency band.

Checked that all the results comply with the emission limit line.

Test Setup

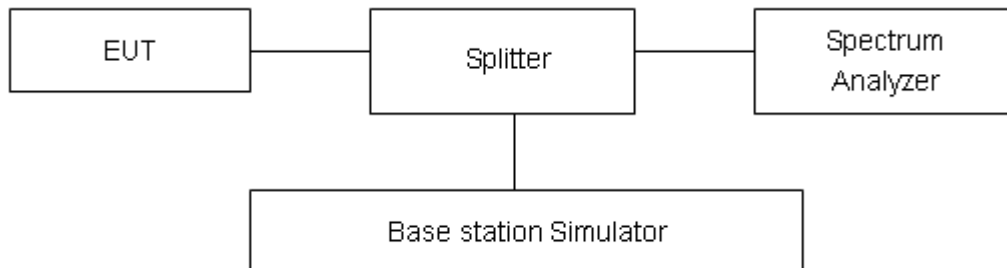

Limits

Rule Part 27.53(h) specifies that “ for operations in the 1695-1710 MHz, 1710-1755 MHz, 1755-1780 MHz, 1915-1920 MHz, 1995-2000 MHz, 2000-2020 MHz, 2110-2155 MHz, 2155-2180 MHz, and 2180-2200 bands, the power of any emission outside a licensee's frequency block shall be attenuated below the transmitter power (P) in watts by at least $43 + 10 \log_{10} (P)$ dB”

Measurement Uncertainty

The assessed measurement uncertainty to ensure 95% confidence level for the normal distribution is with the coverage factor $k = 1.96$, $U=0.684dB$.

Test Results

Refer to the section 6.3 of this report for test data.

5.4 Peak-to-Average Power Ratio (PAPR)

Ambient condition

Temperature	Relative humidity	Pressure
23°C ~25°C	45%~50%	101.5kPa

Methods of Measurement

Measure the total peak power and record as Ppk. And measure the total average power and record as PAvg. Both the peak and average power levels must be expressed in the same logarithmic units (e.g., dBm). Determine the PAPR from:

$$PAPR (dB) = Ppk (dBm) - PAvg (dBm).$$

Test Setup

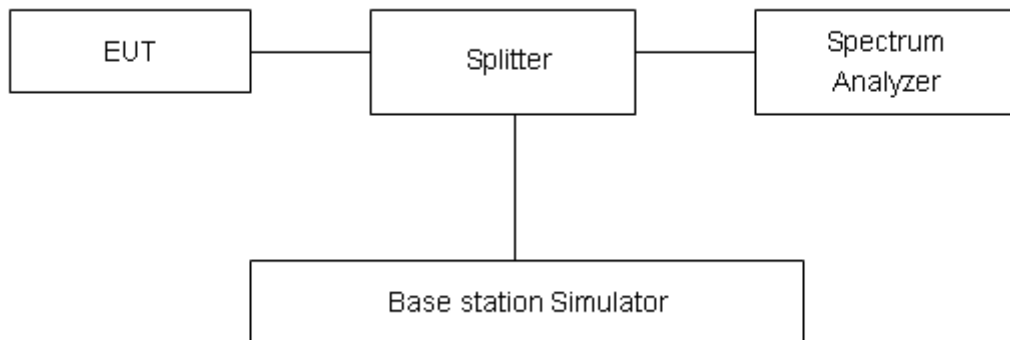

Limits

Rule Part 27.50(d)(5) Equipment employed must be authorized in accordance with the provisions of 24.51. Power measurements for transmissions by stations authorized under this section may be made either in accordance with a Commission-approved average power technique or in compliance with paragraph (d)(6) of this section. In measuring transmissions in this band using an average power technique, the peak-to-average ratio (PAR) of the transmission may not exceed 13 dB.

Measurement Uncertainty

The assessed measurement uncertainty to ensure 95% confidence level for the normal distribution is with the coverage factor $k = 2$, $U = 0.4$ dB.

Test Results

Refer to the section 6.4 of this report for test data.

5.5 Frequency Stability

Ambient condition

Temperature	Relative humidity	Pressure
23°C ~25°C	45%~50%	101.5kPa

Method of Measurement

Frequency Stability (Temperature Variation)

The temperature inside the climate chamber is varied from -30°C to +50°C in 10°C step size.

(1)With all power removed, the temperature was decreased to -10°C and permitted to stabilize for three hours.

(2)Measure the carrier frequency with the test equipment in a “call mode”. These measurements should be made within 1 minute of powering up the mobile station, to prevent significant self warming.

(3) Repeat the above measurements at 10°C increments from -30°C to +50°C. Allow at least 1.5 hours at each temperature, un-powered, before making measurements.

Frequency Stability (Voltage Variation)

The frequency stability shall be measured with variation of primary supply voltage as follows:

Primary Supply Voltage: The primary supply voltage is varied from 85% to 115% of the nominal value for non hand-carried battery and AC powered equipment. For hand-carried, battery-powered equipment, primary supply voltage is reduced to the battery operating end point which shall be specified by the manufacturer.

This transceiver is specified to operate with an input voltage of between 3.6 V and 4.2V, with a nominal voltage of 3.8V.

Test setup

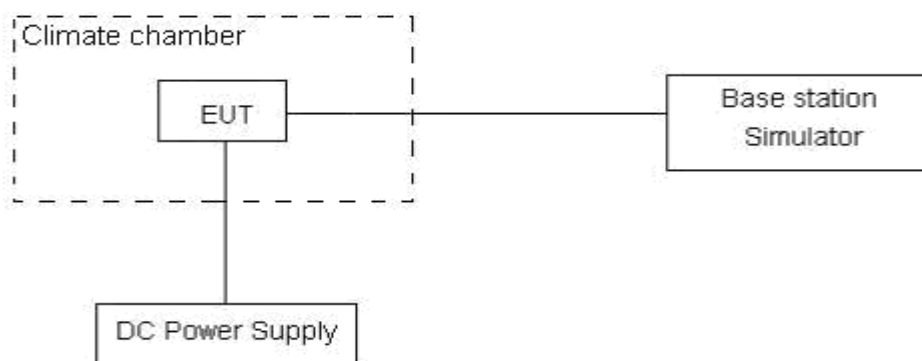

Limits

The frequency stability shall be sufficient to ensure that the fundamental emissions stay within the authorized bands of operation.

Measurement Uncertainty

The assessed measurement uncertainty to ensure 99.75% confidence level for the normal distribution is with the coverage factor $k = 3, U=0.01\text{ppm}$.

Test Results

Refer to the section 6.5 of this report for test data.

5.6 Spurious Emissions at Antenna Terminals

Ambient condition

Temperature	Relative humidity	Pressure
23°C ~25°C	45%~50%	101.5kPa

Method of Measurement

The EUT was connected to Spectrum Analyzer and Base Station Simulator via power Splitter. The measurement is carried out using a spectrum analyzer. The spectrum analyzer scans from 9kHz to the 10th harmonic of the carrier. The peak detector is used.

RBW is set to 100kHz, VBW is set to 300kHz for 30MHz~1GHz

RBW is set to 1MHz, VBW is set to 3MHz for above 1GHz, Sweep is set to ATUO.

RBW is set to 1 kHz (0.009MHz~ 0.15 MHz),

RBW is set to 10 kHz (0.15 MHz~ 30 MHz)

RBW is set to 100 kHz (30MHz~1000 MHz)

RBW is set to 1000 kHz (above 1000MHz)

Of those disturbances below (limit – 20 dB), the mark is not required for the EUT.

The modulation mode and RB allocation refer to section 5.1, using the maximum output power configuration.

Test setup

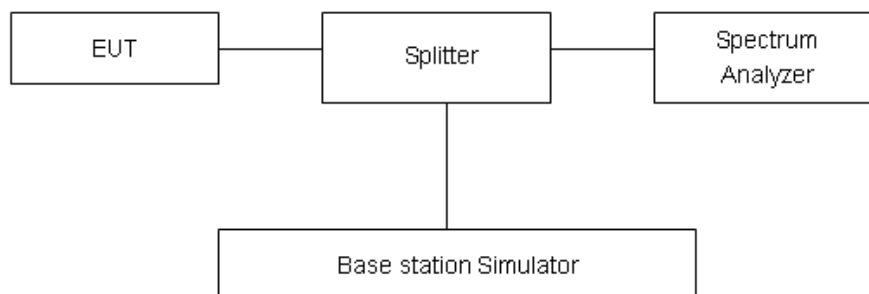

Limits

Rule Part 27.53(h) specifies that “for operations in the 1695-1710 MHz, 1710-1755 MHz, 1755-1780 MHz, 1915-1920 MHz, 1995-2000 MHz, 2000-2020 MHz, 2110-2155 MHz, 2155-2180 MHz, and 2180-2200 bands, the power of any emission outside a licensee's frequency block shall be attenuated below the transmitter power (P) in watts by at least $43 + 10 \log_{10}(P)$ dB..”

Part 27.53(h) Limit	-13 dBm
---------------------	---------

Measurement Uncertainty

The assessed measurement uncertainty to ensure 99.75% confidence level for the normal



distribution is with the coverage factor $k = 1.96$.

Frequency	Uncertainty
9kHz-1GHz	0.684 dB
1GHz-27GHz	1.407 dB

Test Results

Refer to the section 6.6 of this report for test data.

5.7 Radiates Spurious Emission

Ambient condition

Temperature	Relative humidity	Pressure
23°C ~25°C	45%~50%	101.5kPa

Method of Measurement

- The testing follows FCC KDB 971168 D01 v03r01 Section 5.8 and ANSI C63.26 (2015).
- Below 1GHz: The EUT is placed on a turntable 0.8 meters above the ground in the chamber, 3 meter away from the antenna. The maximal emission value is acquired by adjusting the antenna height, polarisation and turntable azimuth. Normally, the height range of antenna is 1 m to 4 m, the azimuth range of turntable is 0° to 360°, and the receive antenna has two polarizations Vertical (V) and Horizontal (H). Above 1GHz: (Note: the FCC's permission to use 1.5m as an alternative per TCBC Conf call of Dec. 2, 2014.) The EUT is placed on a turntable 1.5 meters above the ground in the chamber, 3 meter away from the antenna. The maximal emission value is acquired by adjusting the antenna height, polarisation and turntable azimuth. Normally, the height range of antenna is 1 m to 4 m, the azimuth range of turntable is 0° to 360°, and the receive antenna has two polarizations Vertical (V) and Horizontal (H).
- A loop antenna, A log-periodic antenna or horn antenna shall be substituted in place of the EUT. The log-periodic antenna will be driven by a signal generator and the level will be adjusted till the same power value on the spectrum analyzer or receiver. The level of the spurious emissions can be calculated through the level of the signal generator, cable loss, the gain of the substitution antenna and the reading of the spectrum analyzer or receiver.
- The EUT is then put into continuously transmitting mode at its maximum power level during the test. Set Test Receiver or Spectrum RBW=100kHz, VBW=300kHz for 30MHz to 1GHz and RBW=1MHz, VBW=3MHz for above 1GHz, and the maximum value of the receiver should be recorded as (Pr).
- The EUT shall be replaced by a substitution antenna. In the chamber, an substitution antenna for the frequency band of interest is placed at the reference point of the chamber. An RF Signal source for the frequency band of interest is connected to the substitution antenna with a cable that has been constructed to not interfere with the radiation pattern of the antenna. A power (PMea) is applied to the input of the substitution antenna, and adjust the level of the signal generator output until the value of the receiver reach the previously recorded (Pr). The power of signal source (PMea) is recorded. The test should be performed by rotating the test item and adjusting the receiving antenna polarization.
- A amplifier should be connected to the Signal Source output port. And the cable should be connect between the Amplifier and the Substitution Antenna. The cable loss (Pcl) ,the Substitution Antenna Gain (Ga) and the Amplifier Gain (PAg) should be recorded after test.
- The measurement results are obtained as described below:

$$\text{Power(EIRP)} = \text{PMea} - \text{PAg} - \text{Pcl} + \text{Ga}$$
 The measurement results are amend as described below:

$$\text{Power(EIRP)} = \text{PMea} - \text{Pcl} + \text{Ga}$$
- This value is EIRP since the measurement is calibrated using an antenna of known gain (2.15 dB) and known input power. ERP can be calculated from EIRP by subtracting the gain of the dipole, $\text{ERP} = \text{EIRP} - 2.15\text{dB}$.

The modulation mode and RB allocation refer to section 5.1, using the maximum output power configuration.

Test setup

9KHz ~ 30MHz

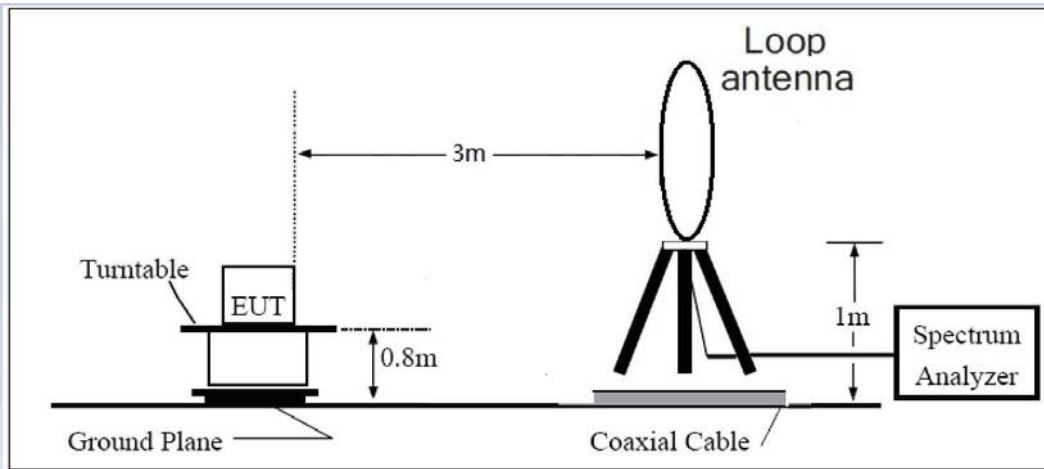

30MHz ~ 1GHz

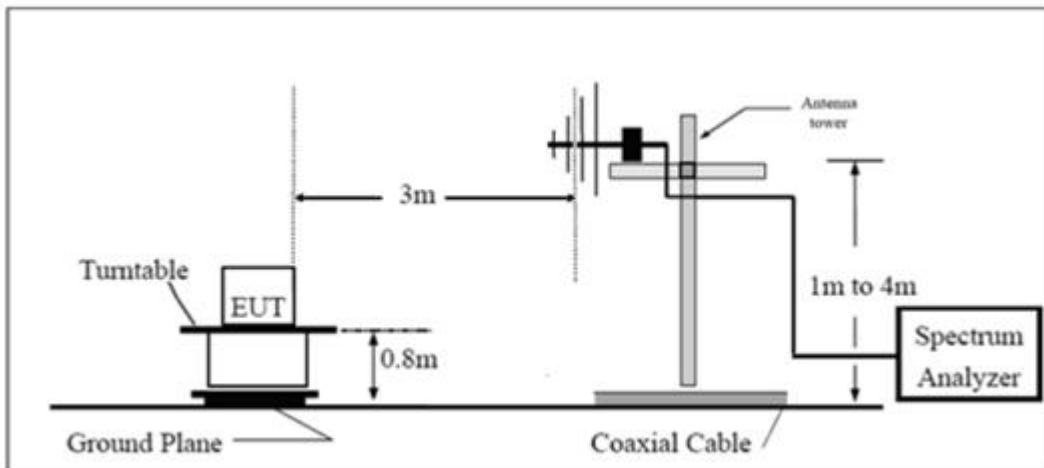

Above 1GHz

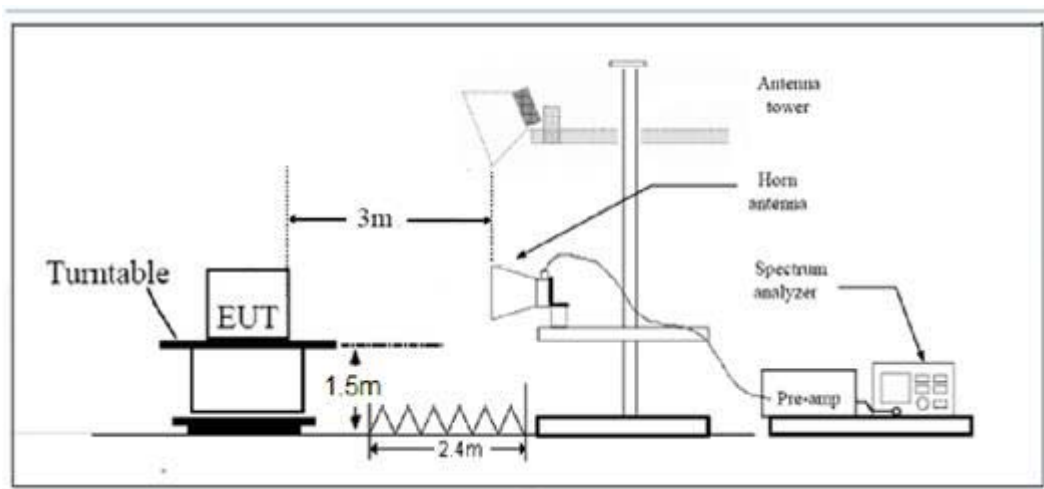

Note: Area side:2.4mX3.6m



Limits

Rule Part 27.53(h) specifies that “for operations in the 1695-1710 MHz, 1710-1755 MHz, 1755-1780 MHz, 1915-1920 MHz, 1995-2000 MHz, 2000-2020 MHz, 2110-2155 MHz, 2155-2180 MHz, and 2180-2200 bands, the power of any emission outside a licensee's frequency block shall be attenuated below the transmitter power (P) in watts by at least $43 + 10 \log_{10} (P)$ dB.”

Part 27.53(h) Limit	-13 dBm
---------------------	---------

Measurement Uncertainty

The assessed measurement uncertainty to ensure 95% confidence level for the normal distribution is with the coverage factor $k = \pm 1.96$, $U = \pm 3.55$ dB.

Test Results

Refer to the section 6.7 of this report for test data.

6 Test Results

6.1 RF Power Output and Effective Isotropic Radiated Power

LTE Band 4				Maximum Output Power(dBm)			EIRP (dBm)		
BW	Modulation	RB size	RB offset	Channel/Frequency(MHz)					
				19957/1710.7	20175/1732.5	20393/1754.3	19957/1710.7	20175/1732.5	20393/1754.3
1.4MHz	QPSK	1	0	21.37	21.37	21.20	19.87	19.87	19.70
		1	2	21.36	21.23	21.08	19.86	19.73	19.58
		1	5	21.28	21.11	21.22	19.78	19.61	19.72
		3	0	21.09	21.21	21.15	19.59	19.71	19.65
		3	2	21.03	21.00	21.13	19.53	19.50	19.63
		3	3	20.89	20.97	21.14	19.39	19.47	19.64
	16QAM	6	0	20.12	20.14	20.27	18.62	18.64	18.77
		1	0	20.00	20.14	19.93	18.50	18.64	18.43
		1	2	19.82	19.83	20.04	18.32	18.33	18.54
		1	5	19.70	19.70	19.68	18.20	18.20	18.18
		3	0	20.09	20.15	20.03	18.59	18.65	18.53
		3	2	20.18	20.25	20.00	18.68	18.75	18.50
	3MHz	QPSK	3	3	20.03	20.12	19.83	18.53	18.62
6			0	19.23	19.34	19.23	17.73	17.84	17.73
1			0	21.37	21.36	21.20	19.87	19.86	19.70
1			7	21.33	21.26	21.10	19.83	19.76	19.60
1			14	21.27	21.10	21.21	19.77	19.60	19.71
8			0	20.17	20.29	20.25	18.67	18.79	18.75
8			4	20.13	20.06	20.20	18.63	18.56	18.70
16QAM		8	7	19.96	20.07	20.21	18.46	18.57	18.71
		15	0	20.14	20.15	20.27	18.64	18.65	18.77
		1	0	20.02	20.13	19.93	18.52	18.63	18.43
		1	7	19.84	19.82	20.06	18.34	18.32	18.56
		1	14	19.70	19.70	19.67	18.20	18.20	18.17



BW	Modulation	RB size	RB offset	Channel/Frequency(MHz)					
				19975/ 1712.5	20175/ 1732.5	20375/ 1752.5	19975/ 1712.5	20175/ 1732.5	20375/ 1752.5
		8	0	19.18	19.27	19.13	17.68	17.77	17.63
		8	4	19.25	19.32	19.07	17.75	17.82	17.57
		8	7	19.11	19.20	18.93	17.61	17.70	17.43
		15	0	19.24	19.34	19.21	17.74	17.84	17.71
5MHz	QPSK	1	0	21.34	21.32	21.17	19.84	19.82	19.67
		1	13	21.32	21.22	21.08	19.82	19.72	19.58
		1	24	21.25	21.09	21.18	19.75	19.59	19.68
		12	0	20.14	20.24	20.21	18.64	18.74	18.71
		12	6	20.11	20.02	20.17	18.61	18.52	18.67
		12	13	19.93	20.02	20.17	18.43	18.52	18.67
		25	0	20.11	20.10	20.23	18.61	18.60	18.73
	16QAM	1	0	19.99	20.09	19.88	18.49	18.59	18.38
		1	13	19.81	19.80	20.02	18.31	18.30	18.52
		1	24	19.67	19.67	19.65	18.17	18.17	18.15
		12	0	19.15	19.23	19.10	17.65	17.73	17.60
		12	6	19.22	19.30	19.04	17.72	17.80	17.54
		12	13	19.08	19.15	18.89	17.58	17.65	17.39
		25	0	19.22	19.30	19.18	17.72	17.80	17.68
BW	Modulation	RB size	RB offset	Channel/Frequency(MHz)					
				20000/ 1715	20175/ 1732.5	20350/ 1750	20000/ 1715	20175/ 1732.5	20350/ 1750
10MHz	QPSK	1	0	21.31	21.30	21.13	19.81	19.80	19.63
		1	25	21.30	21.18	21.05	19.80	19.68	19.55
		1	49	21.22	21.04	21.14	19.72	19.54	19.64
		25	0	20.11	20.19	20.17	18.61	18.69	18.67
		25	13	20.09	19.98	20.12	18.59	18.48	18.62
		25	25	19.91	20.00	20.13	18.41	18.50	18.63
		50	0	20.11	20.09	20.21	18.61	18.59	18.71
	16QAM	1	0	19.99	20.05	19.85	18.49	18.55	18.35
		1	25	19.81	19.78	19.99	18.31	18.28	18.49
		1	49	19.64	19.65	19.61	18.14	18.15	18.11
		25	0	19.13	19.19	19.07	17.63	17.69	17.57
		25	13	19.19	19.25	19.00	17.69	17.75	17.50
		25	25	19.05	19.10	18.85	17.55	17.60	17.35



BW	Modulation	RB size	RB offset	Channel/Frequency(MHz)					
				20025/ 1717.5	20175/ 1732.5	20325/ 1747.5	20025/ 1717.5	20175/ 1732.5	20325/ 1747.5
				50	0	19.20	19.26	19.13	17.70
15MHz	QPSK	1	0	21.32	21.27	21.14	19.82	19.77	19.64
		1	38	21.31	21.22	21.06	19.81	19.72	19.56
		1	74	21.21	21.03	21.13	19.71	19.53	19.63
		36	0	20.12	20.20	20.18	18.62	18.70	18.68
		36	18	20.09	19.98	20.12	18.59	18.48	18.62
		36	39	19.90	20.01	20.14	18.40	18.51	18.64
		75	0	20.13	20.07	20.20	18.63	18.57	18.70
	16QAM	1	0	20.01	20.06	19.85	18.51	18.56	18.35
		1	38	19.83	19.79	20.00	18.33	18.29	18.50
		1	74	19.65	19.63	19.61	18.15	18.13	18.11
		36	0	19.13	19.22	19.08	17.63	17.72	17.58
		36	18	19.18	19.24	18.99	17.68	17.74	17.49
		36	39	19.06	19.11	18.86	17.56	17.61	17.36
		75	0	19.20	19.26	19.13	17.70	17.76	17.63
BW	Modulation	RB size	RB offset	Channel/Frequency(MHz)					
				20050/ 1720	20175/ 1732.5	20300/ 1745	20050/ 1720	20175/ 1732.5	20300/ 1745
				1	0	21.29	21.23	21.11	19.79
20MHz	QPSK	1	50	21.30	21.18	21.04	19.80	19.68	19.54
		1	99	21.19	21.02	21.10	19.69	19.52	19.60
		50	0	20.09	20.15	20.14	18.59	18.65	18.64
		50	25	20.07	19.94	20.09	18.57	18.44	18.59
		50	50	19.87	19.96	20.10	18.37	18.46	18.60
		100	0	20.10	20.02	20.16	18.60	18.52	18.66
		16QAM	1	0	19.98	20.02	19.80	18.48	18.52
	1		50	19.80	19.77	19.96	18.30	18.27	18.46
	1		99	19.62	19.60	19.59	18.12	18.10	18.09
	50		0	19.10	19.18	19.05	17.60	17.68	17.55
	50		25	19.15	19.22	18.96	17.65	17.72	17.46
	50		50	19.03	19.06	18.82	17.53	17.56	17.32
	100		0	19.18	19.22	19.10	17.68	17.72	17.60



6.2 Occupied Bandwidth

LTE Band 4							
RB	Modulation	Bandwidth (MHz)	Channel	Frequency (MHz)	99% Power Bandwidth(MHz)	-26dBc Bandwidth(MHz)	
100%	QPSK	1.4	19957	1710.7	1.102	1.242	
			20175	1732.5	1.090	1.245	
			20393	1754.3	1.093	1.247	
		3	19965	1711.5	2.707	3.063	
			20175	1732.5	2.710	3.034	
			20385	1753.5	2.710	3.040	
		5	19975	1712.5	4.508	4.939	
			20175	1732.5	4.507	4.990	
			20375	1752.5	4.515	4.950	
		10	20000	1715	9.010	9.823	
			20175	1732.5	8.992	9.806	
			20350	1750	8.983	9.850	
		15	20025	1717.5	13.468	14.792	
			20175	1732.5	13.492	14.771	
			20325	1747.5	13.458	14.753	
		20	20050	1720	18.002	19.752	
			20175	1732.5	18.005	19.544	
			20300	1745	17.986	19.596	
		16QAM	1.4	19957	1710.7	1.096	1.244
				20175	1732.5	1.104	1.254
				20393	1754.3	1.092	1.243
			3	19965	1711.5	2.713	3.029
				20175	1732.5	2.705	3.036
				20385	1753.5	2.704	3.005
	5		19975	1712.5	4.502	4.983	
			20175	1732.5	4.511	4.952	
			20375	1752.5	4.524	4.947	
	10		20000	1715	8.962	9.745	
			20175	1732.5	9.017	9.781	
			20350	1750	8.997	9.870	
15	20025		1717.5	13.505	14.804		
	20175		1732.5	13.513	15.129		
	20325		1747.5	13.467	14.781		
20	20050		1720	18.010	19.555		
	20175	1732.5	18.127	19.809			
	20300	1745	17.931	19.449			



LTE Band 4 QPSK 1.4MHz CH-Low

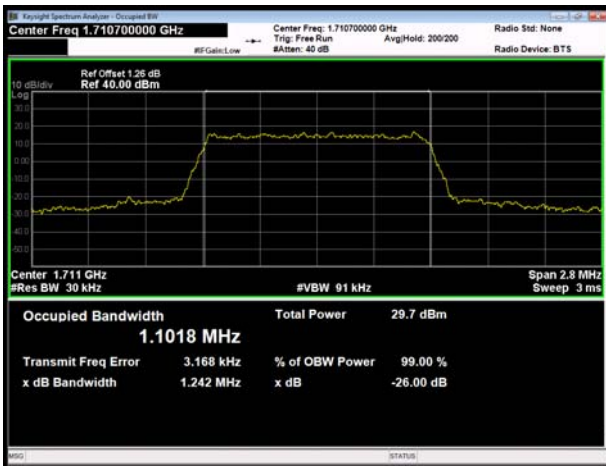

LTE Band 4 QPSK 3MHz CH-Low

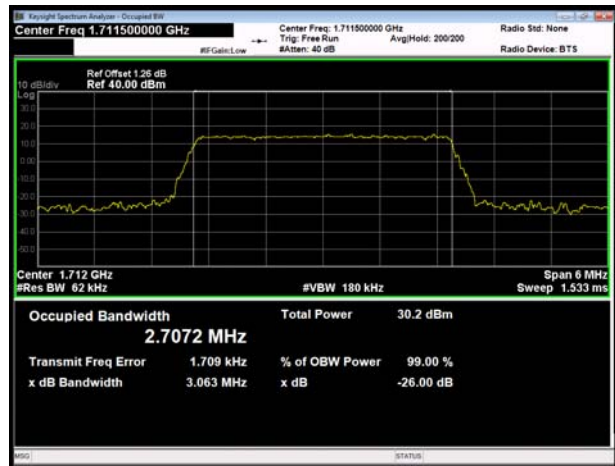

LTE Band 4 QPSK 1.4MHz CH-Middle



LTE Band 4 QPSK 3MHz CH-Middle

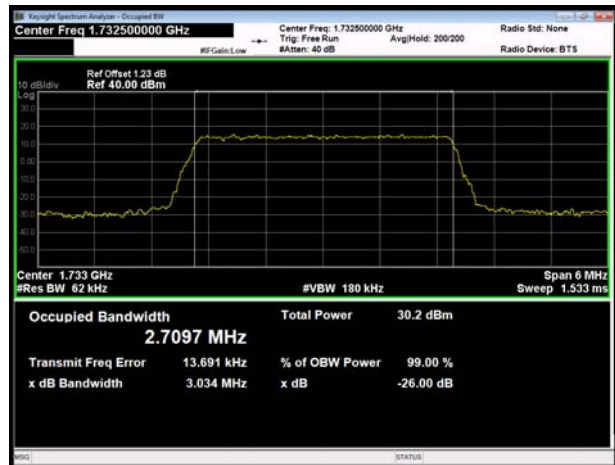

LTE Band 4 QPSK 1.4MHz CH-High

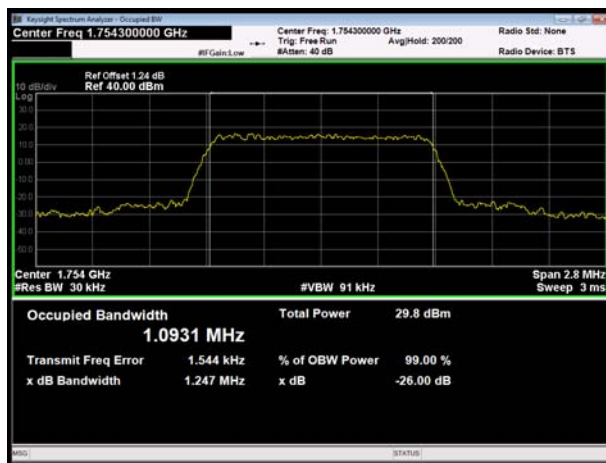

LTE Band 4 QPSK 3MHz CH-High

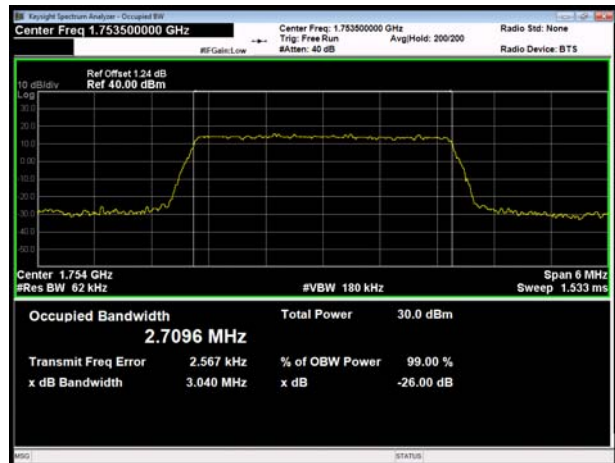



LTE Band 4 QPSK 5MHz CH-Low

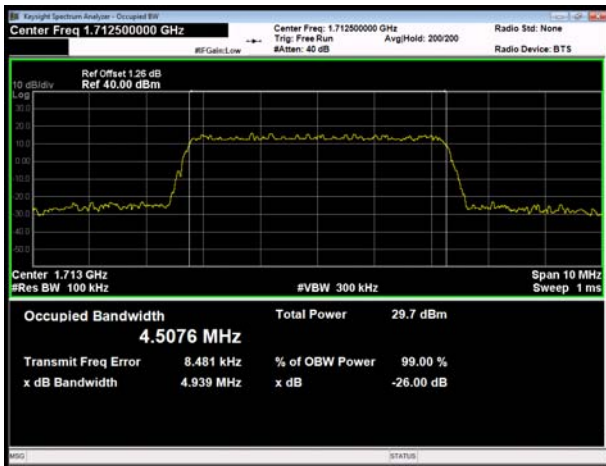

LTE Band 4 QPSK 10MHz CH-Low

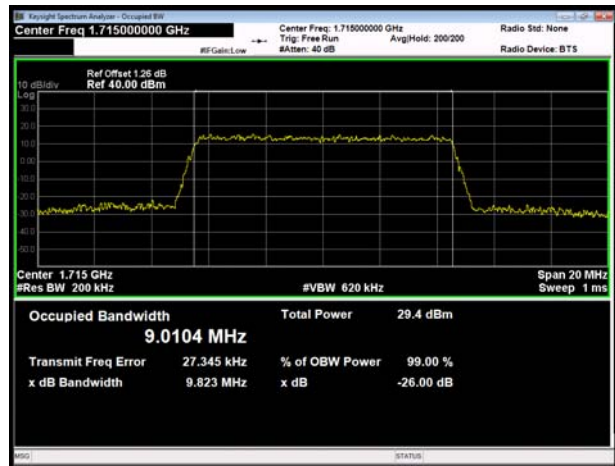

LTE Band 4 QPSK 5MHz CH-Middle

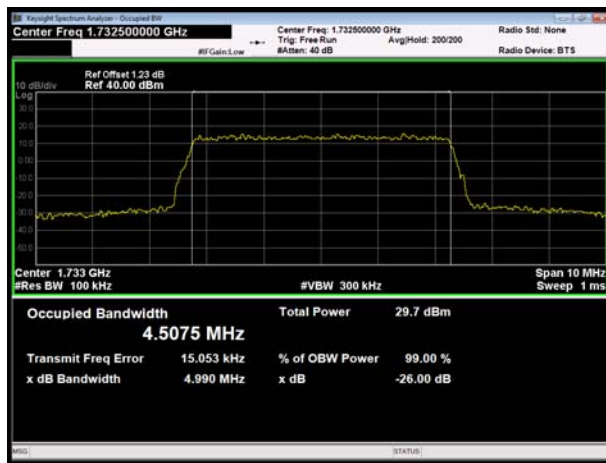

LTE Band 4 QPSK 10MHz CH-Middle

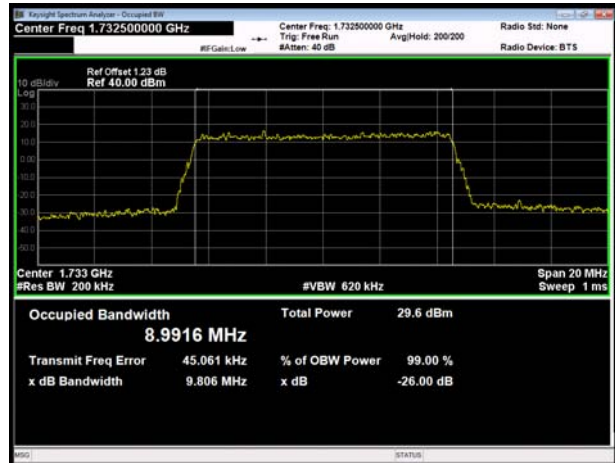

LTE Band 4 QPSK 5MHz CH-High

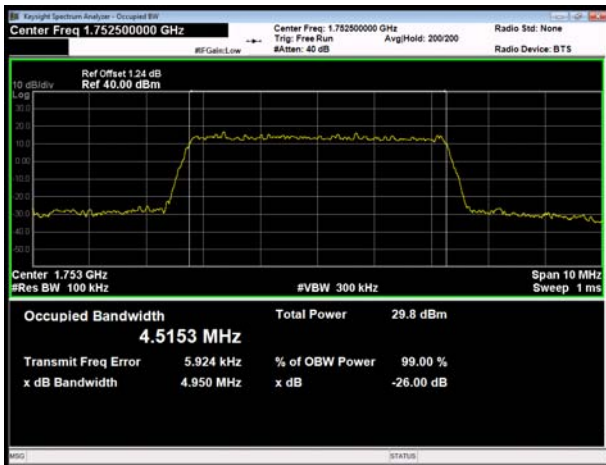

LTE Band 4 QPSK 10MHz CH-High





LTE Band 4 QPSK 15MHz CH-Low

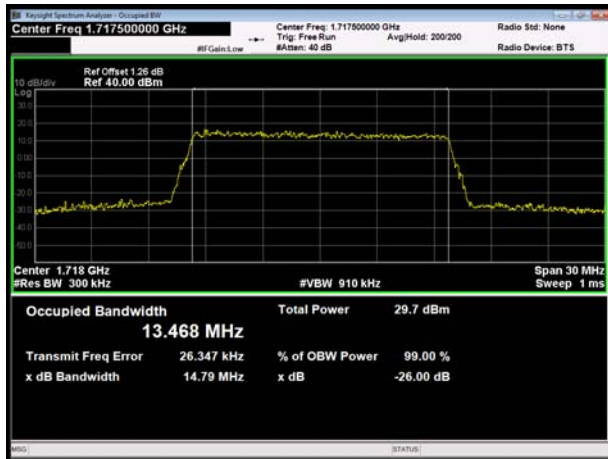

LTE Band 4 QPSK 20MHz CH-Low

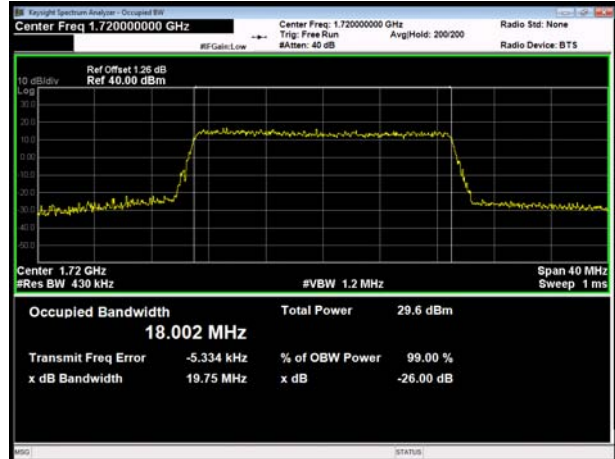

LTE Band 4 QPSK 15MHz CH-Middle

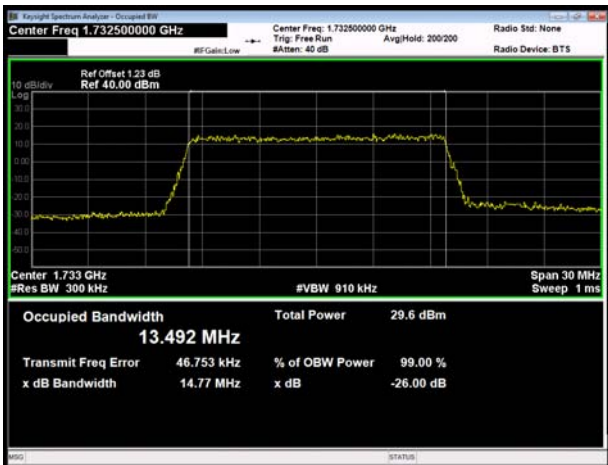

LTE Band 4 QPSK 20MHz CH-Middle

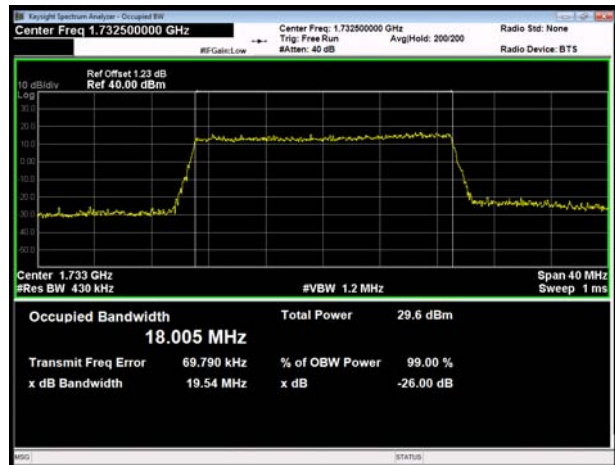

LTE Band 4 QPSK 15MHz CH-High

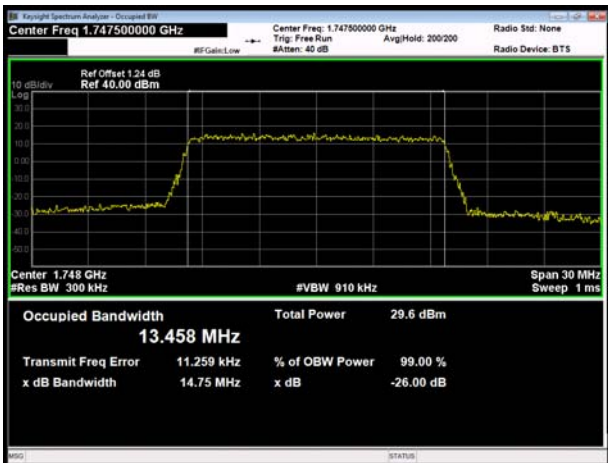

LTE Band 4 QPSK 20MHz CH-High

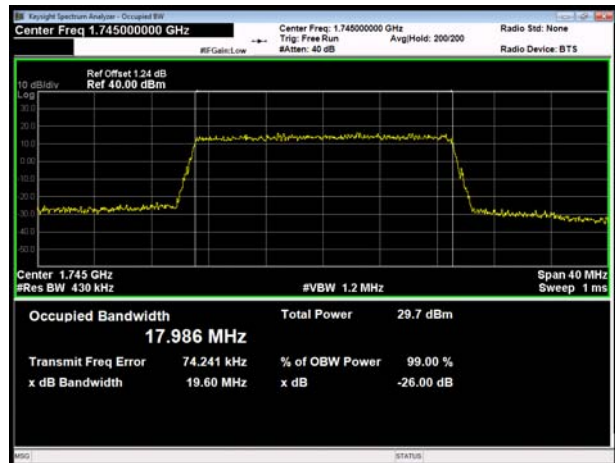



LTE Band 4 16QAM 1.4MHz CH-Low

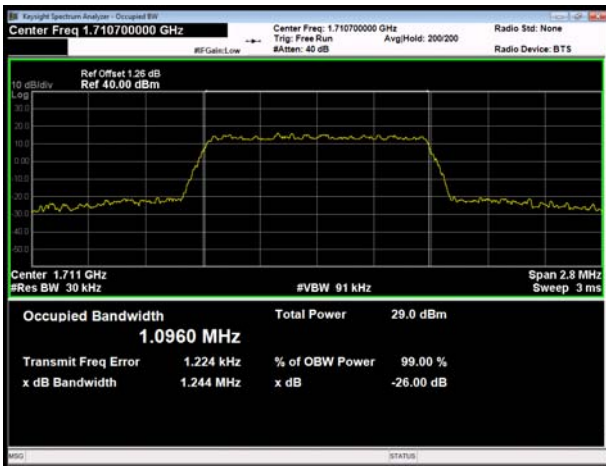

LTE Band 4 16QAM 3MHz CH-Low

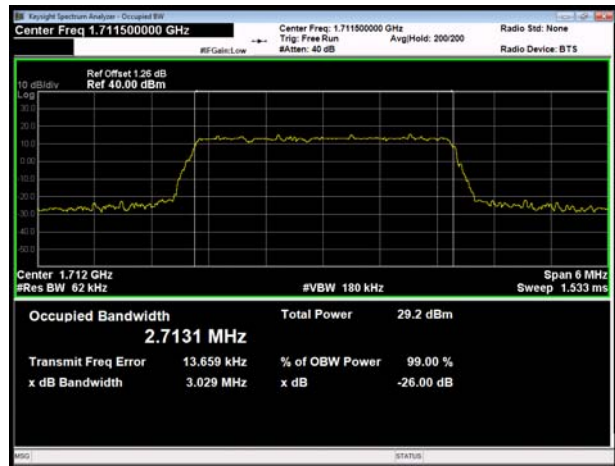

LTE Band 4 16QAM 1.4MHz CH-Middle

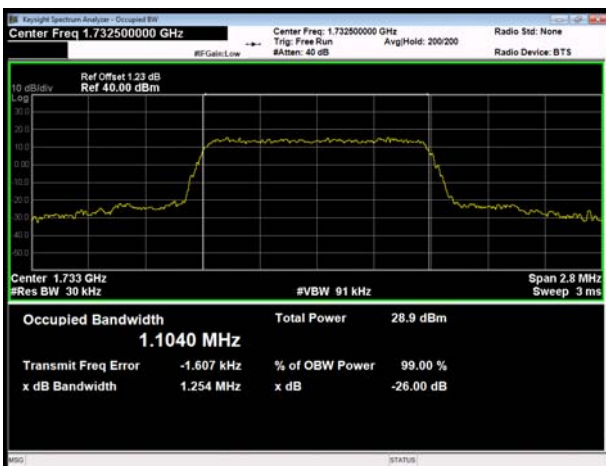

LTE Band 4 16QAM 3MHz CH-Middle

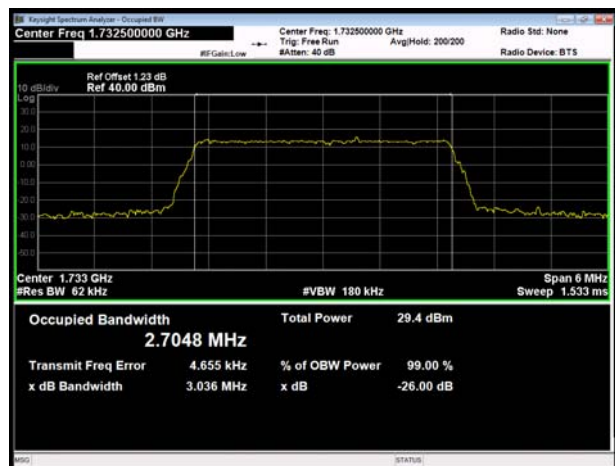

LTE Band 4 16QAM 1.4MHz CH-High

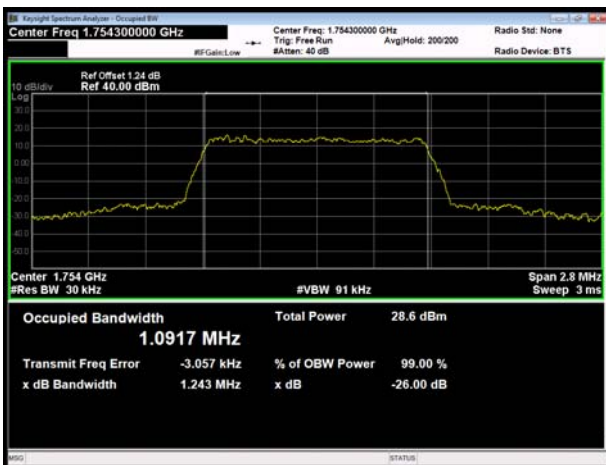

LTE Band 4 16QAM 3MHz CH-High

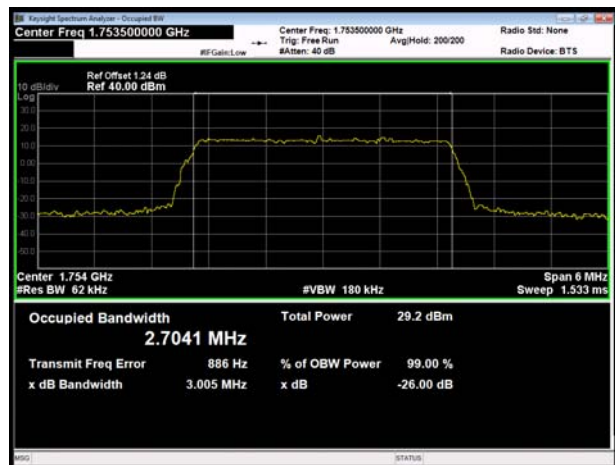



LTE Band 4 16QAM 5MHz CH-Low

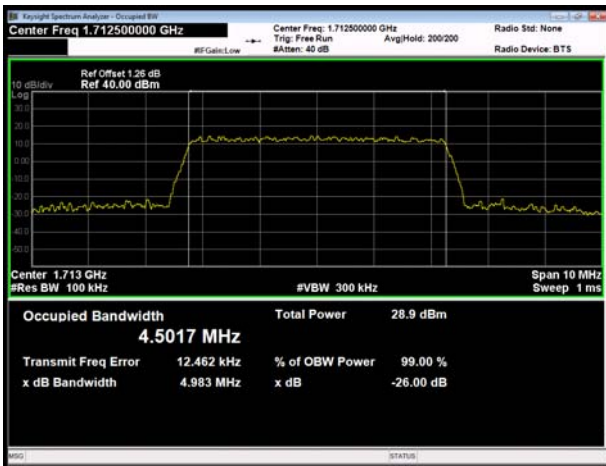

LTE Band 4 16QAM 10MHz CH-Low

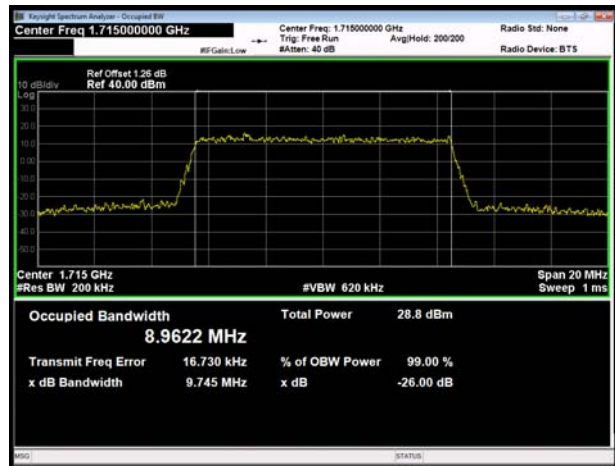

LTE Band 4 16QAM 5MHz CH-Middle

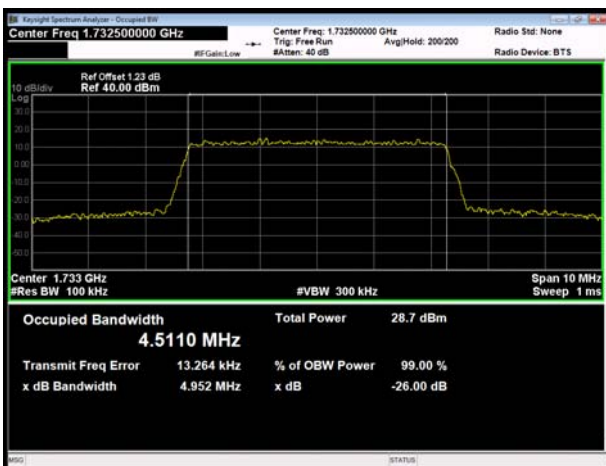

LTE Band 4 16QAM 10MHz CH-Middle

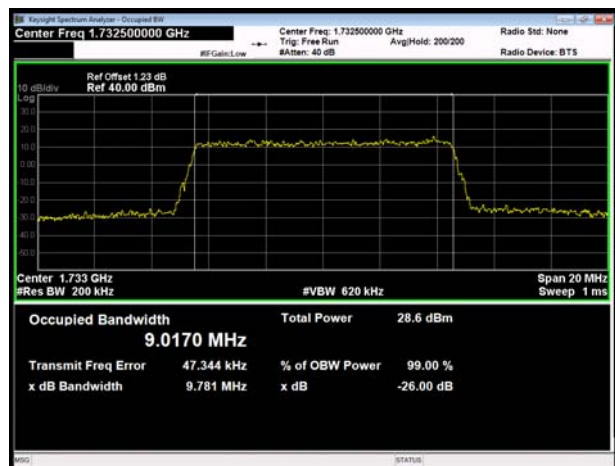

LTE Band 4 16QAM 5MHz CH-High

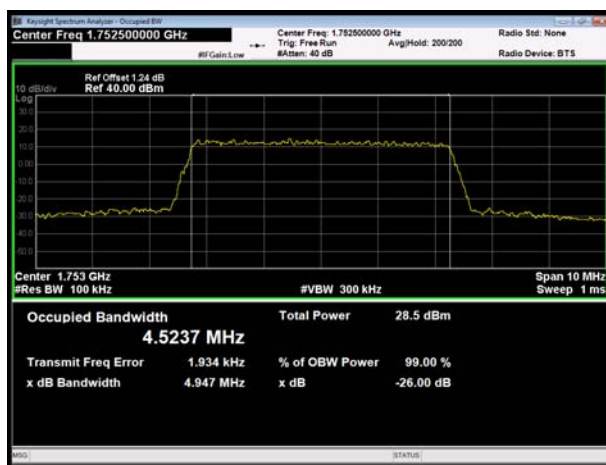

LTE Band 4 16QAM 10MHz CH-High

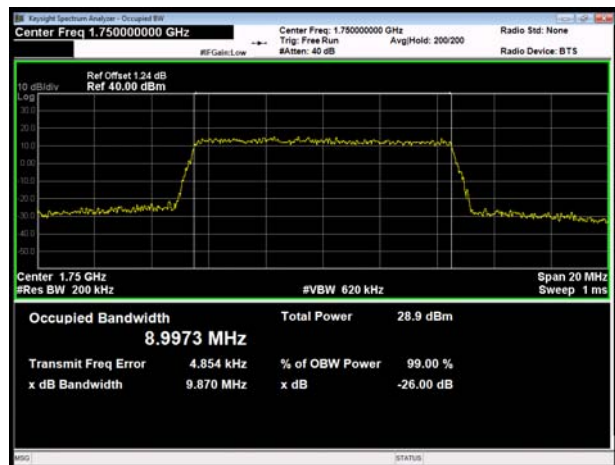



LTE Band 4 16QAM 15MHz CH-Low



LTE Band 4 16QAM 20MHz CH-Low

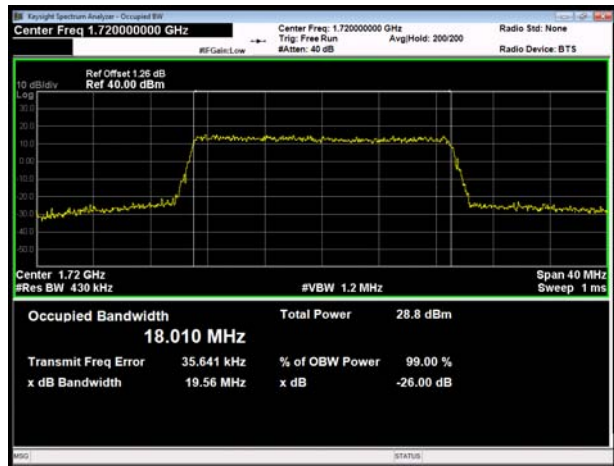

LTE Band 4 16QAM 15MHz CH-Middle

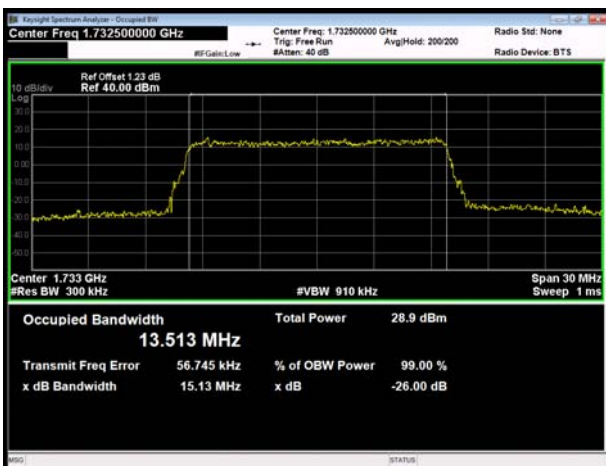

LTE Band 4 16QAM 20MHz CH-Middle

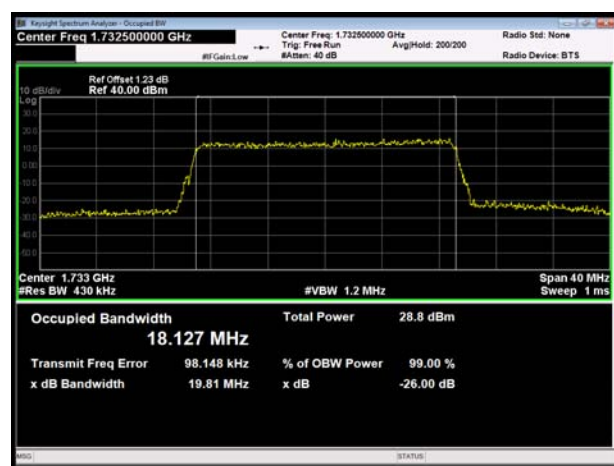

LTE Band 4 16QAM 15MHz CH-High

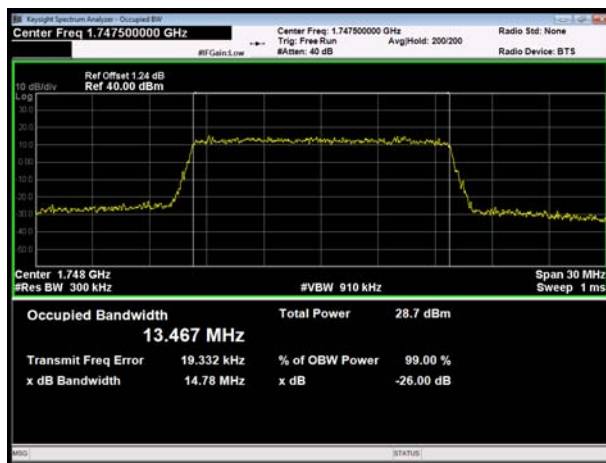

LTE Band 4 16QAM 20MHz CH-High

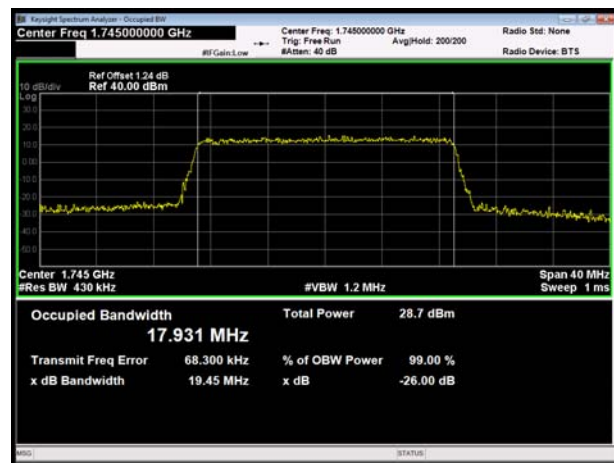



6.3 Band Edge Compliance

All the test traces in the plots shows the test results clearly.

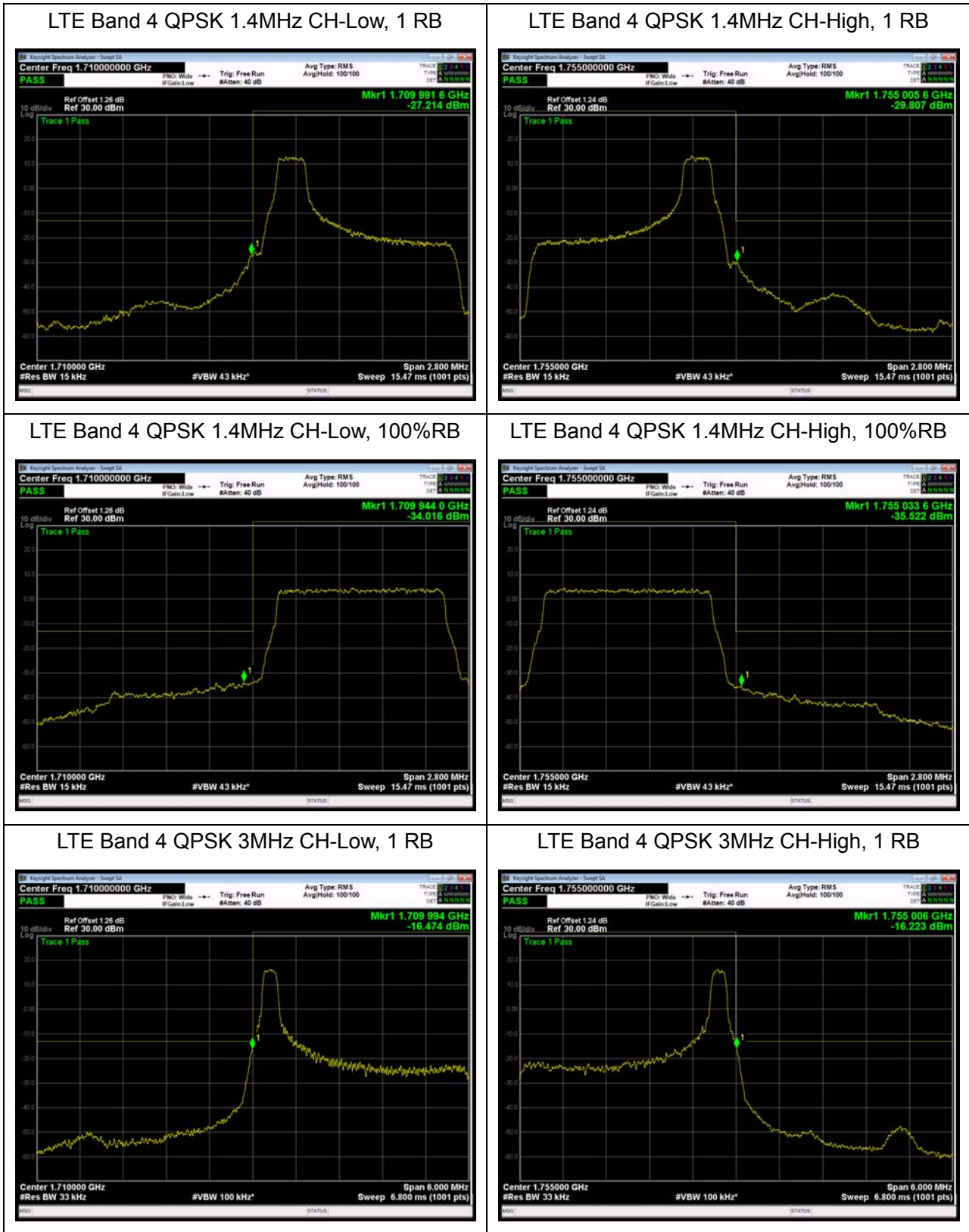



LTE Band 4 QPSK 3MHz CH-Low, 100%RB

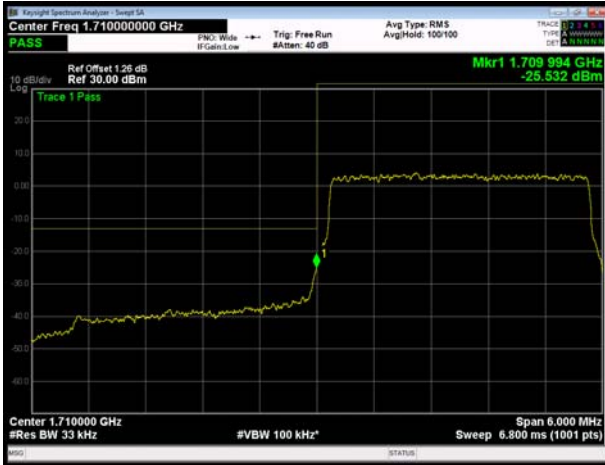

LTE Band 4 QPSK 3MHz CH-High, 100%RB

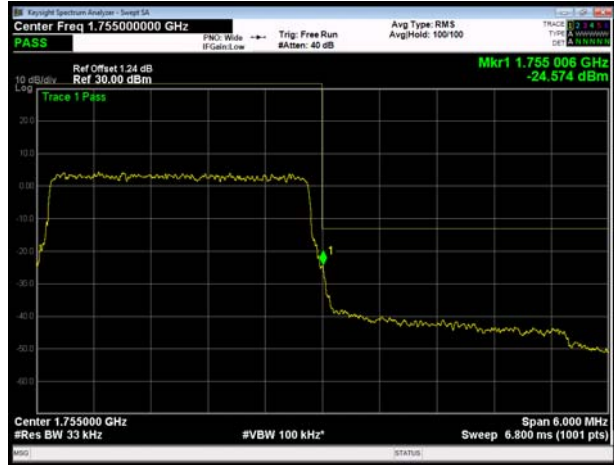

LTE Band 4 QPSK 5MHz CH-Low, 1 RB

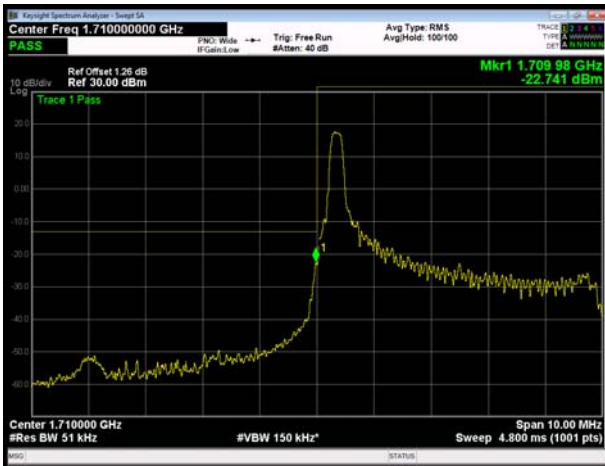

LTE Band 4 QPSK 5MHz CH-High, 1 RB

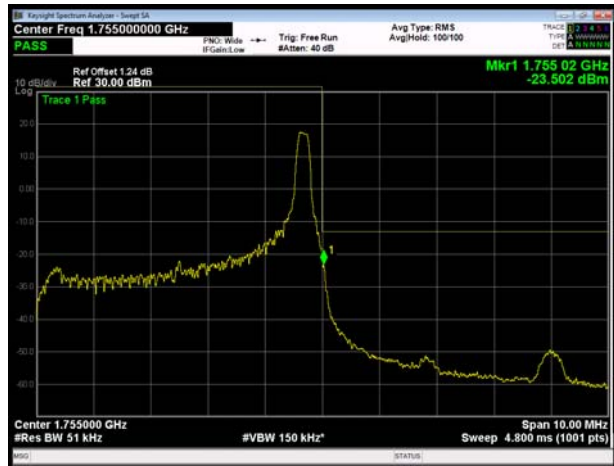

LTE Band 4 QPSK 5MHz CH-Low, 100%RB

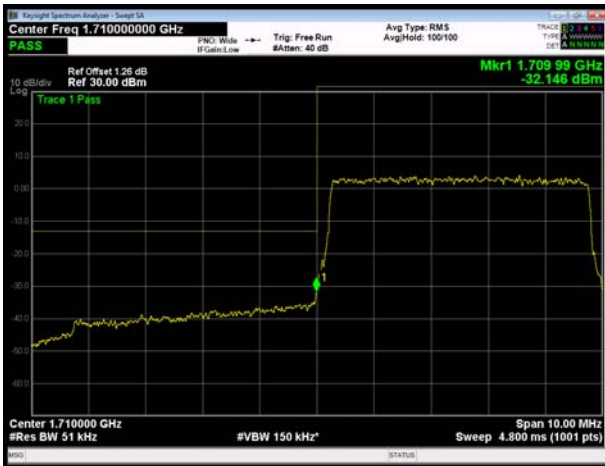

LTE Band 4 QPSK 5MHz CH-High, 100%RB





LTE Band 4 QPSK 10MHz CH-Low, 1 RB

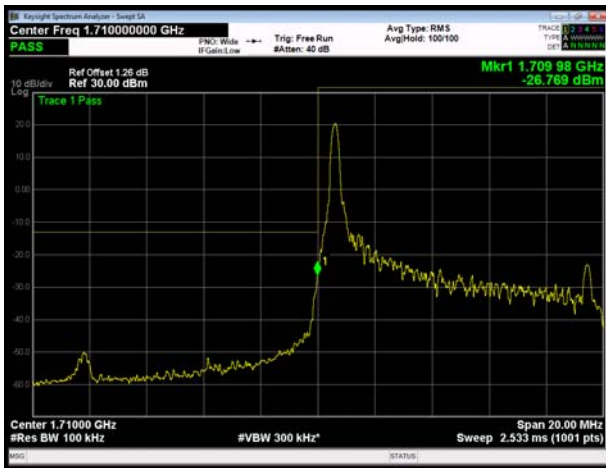

LTE Band 4 QPSK 10MHz CH-High, 1 RB

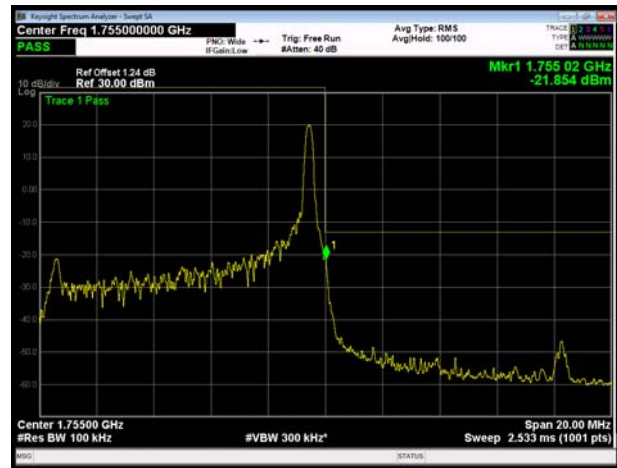

LTE Band 4 QPSK 10MHz CH-Low, 100%RB



LTE Band 4 QPSK 10MHz CH-High, 100%RB



LTE Band 4 QPSK 15MHz CH-Low, 1 RB

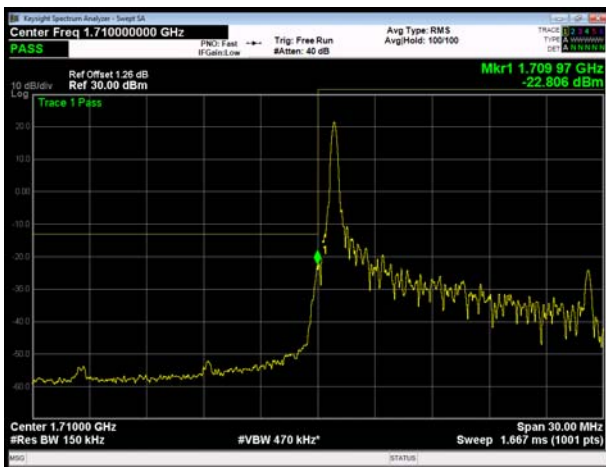

LTE Band 4 QPSK 15MHz CH-High, 1 RB

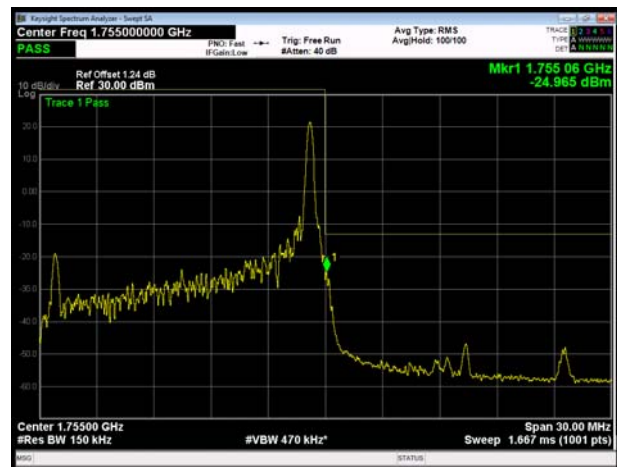



LTE Band 4 QPSK 15MHz CH-Low, 100%RB

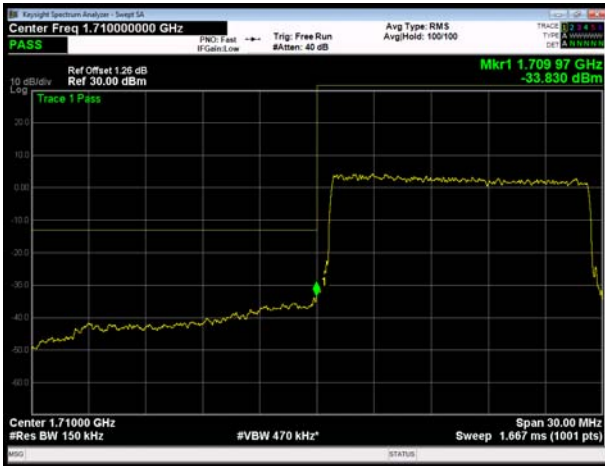

LTE Band 4 QPSK 15MHz CH-High, 100%RB



LTE Band 4 QPSK 20MHz CH-Low, 1 RB

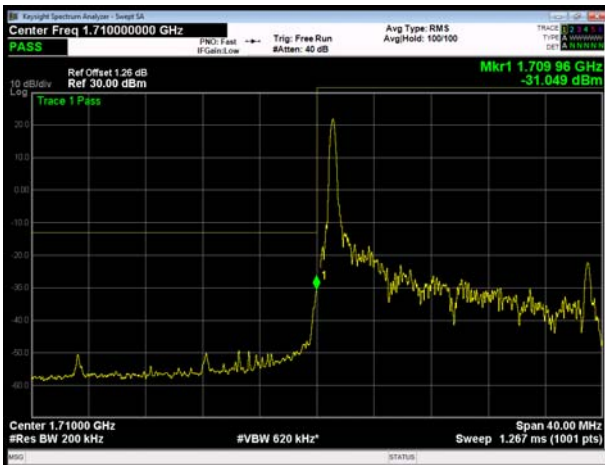

LTE Band 4 QPSK 20MHz CH-High, 1 RB

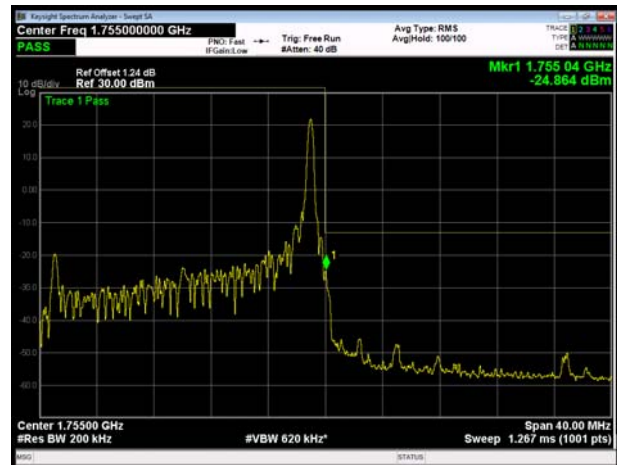

LTE Band 4 QPSK 20MHz CH-Low, 100%RB

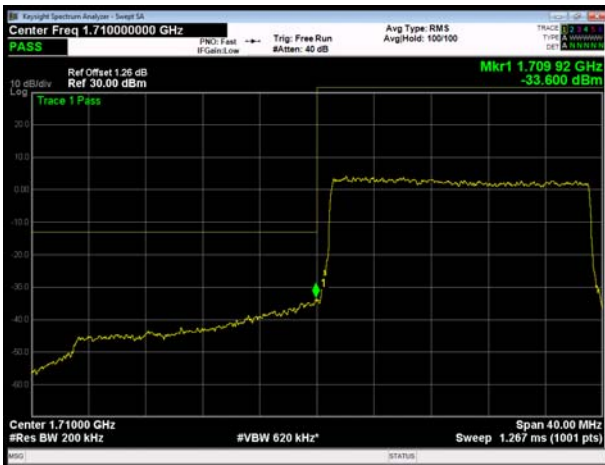

LTE Band 4 QPSK 20MHz CH-High, 100%RB

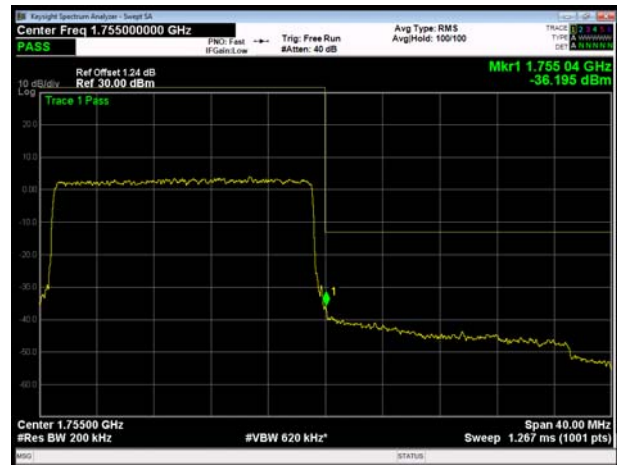



LTE Band 4 16QAM 1.4MHz CH-Low, 1 RB

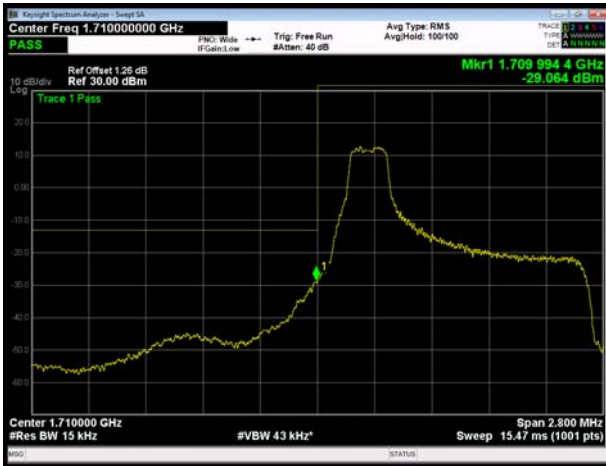

LTE Band 4 16QAM 1.4MHz CH-High, 1 RB



LTE Band 4 16QAM 1.4MHz CH-Low, 100%RB

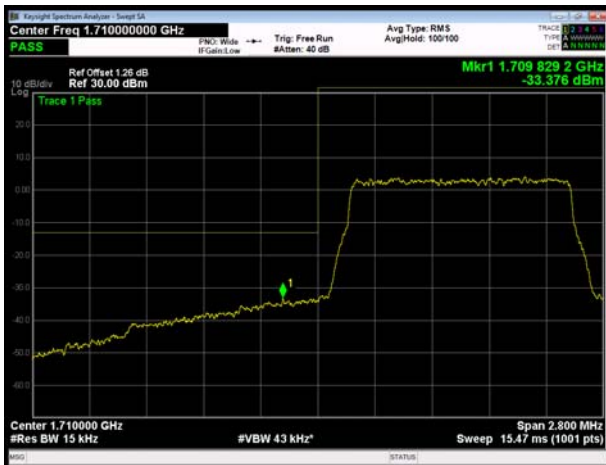

LTE Band 4 16QAM 1.4MHz CH-High, 100%RB



LTE Band 4 16QAM 3MHz CH-Low, 1 RB

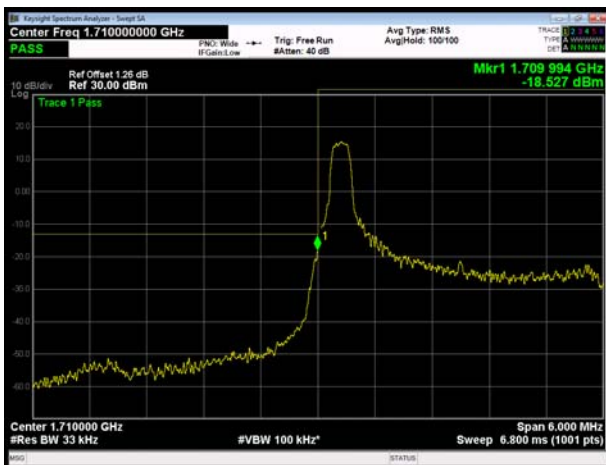

LTE Band 4 16QAM 3MHz CH-High, 1 RB

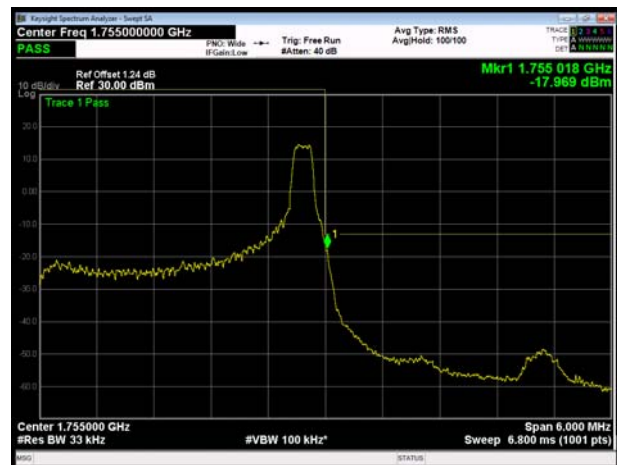



LTE Band 4 16QAM 3MHz CH-Low, 100%RB

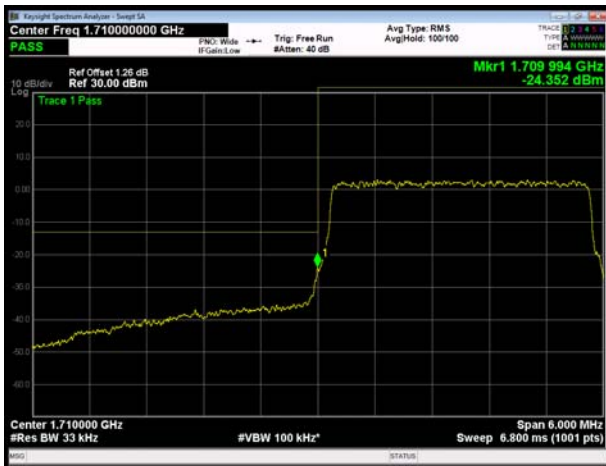

LTE Band 4 16QAM 3MHz CH-High, 100%RB

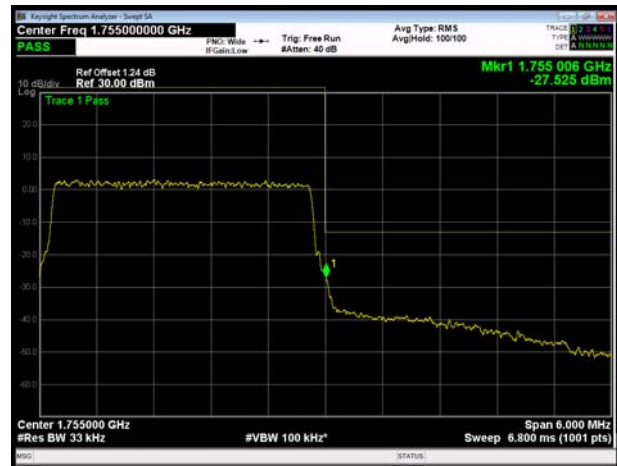

LTE Band 4 16QAM 5MHz CH-Low, 1 RB

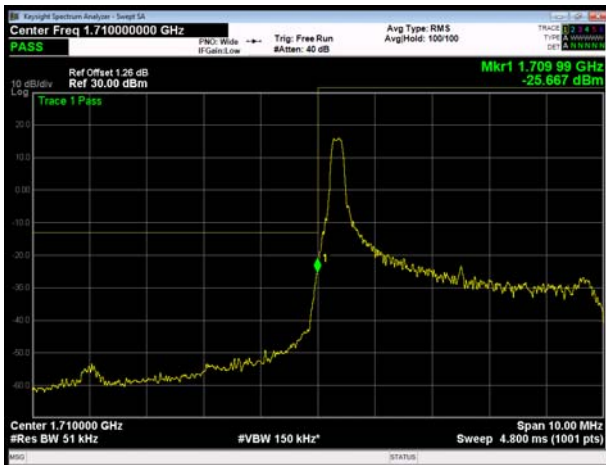

LTE Band 4 16QAM 5MHz CH-High, 1 RB

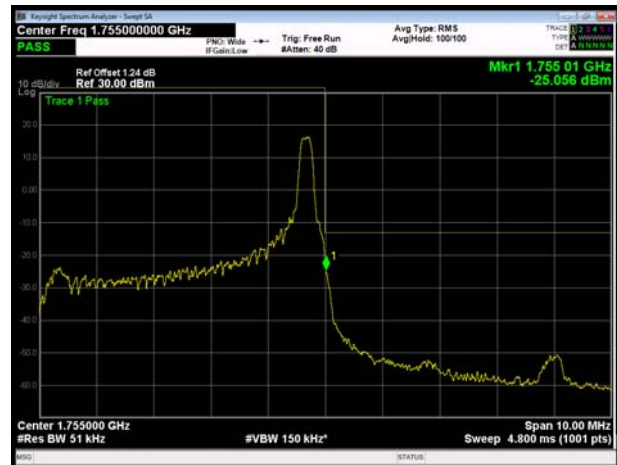

LTE Band 4 16QAM 5MHz CH-Low, 100%RB

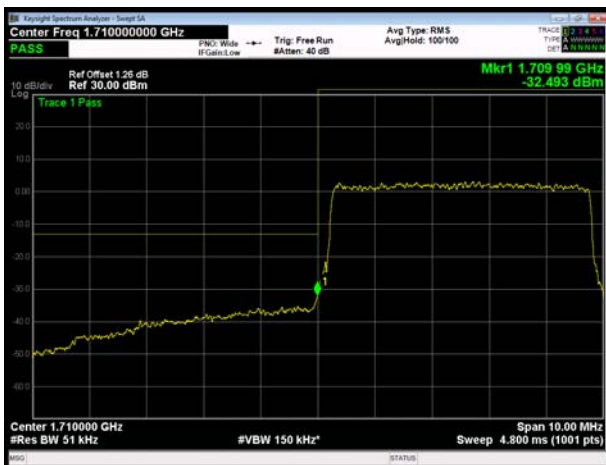

LTE Band 4 16QAM 5MHz CH-High, 100%RB

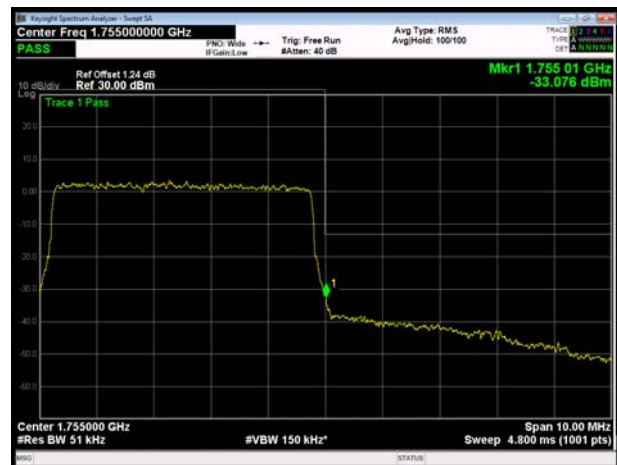



LTE Band 4 16QAM 10MHz CH-Low, 1 RB

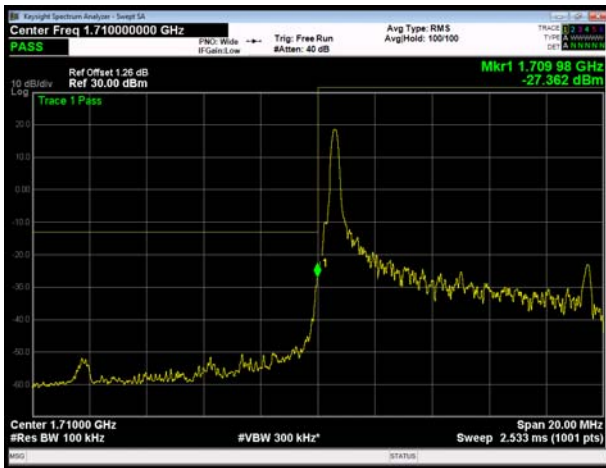

LTE Band 4 16QAM 10MHz CH-High, 1 RB

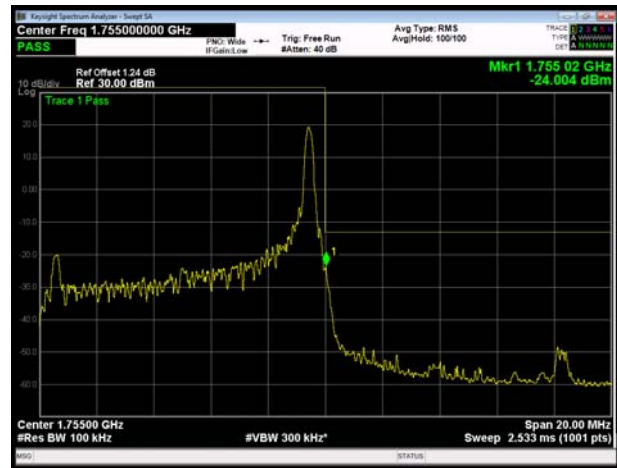

LTE Band 4 16QAM 10MHz CH-Low, 100%RB

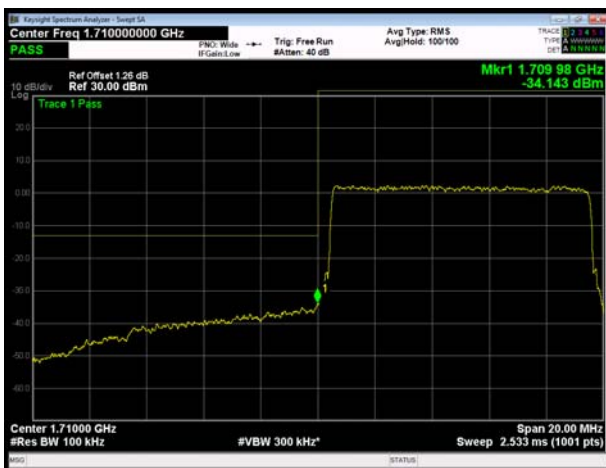

LTE Band 4 16QAM 10MHz CH-High, 100%RB

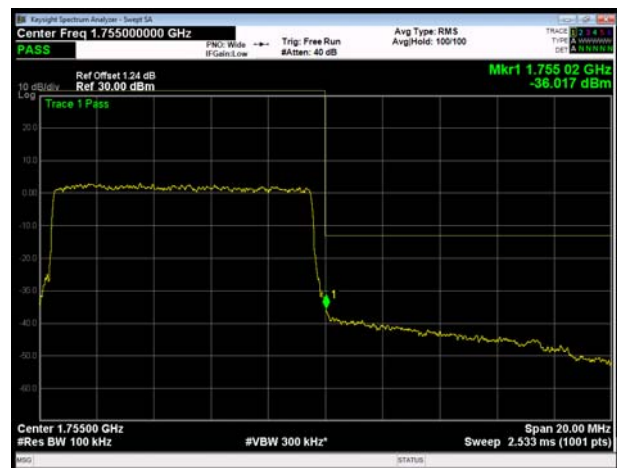

LTE Band 4 16QAM 15MHz CH-Low, 1 RB

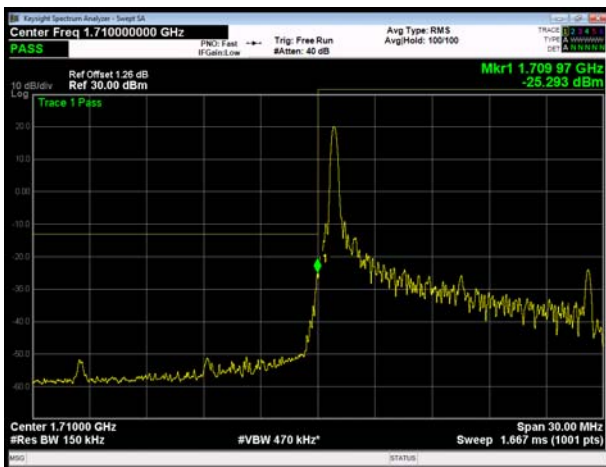

LTE Band 4 16QAM 15MHz CH-High, 1 RB

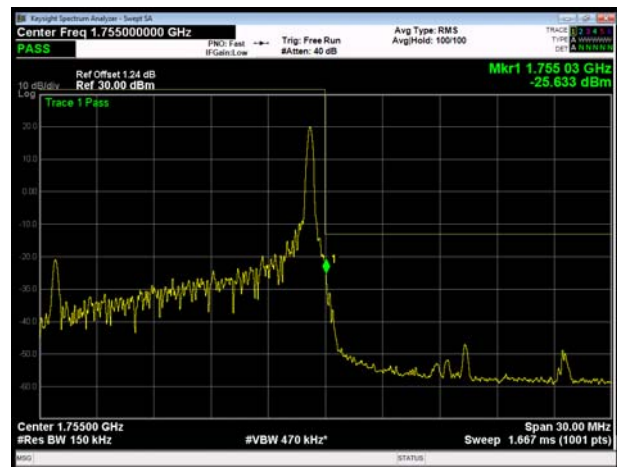



LTE Band 4 16QAM 15MHz CH-Low, 100%RB

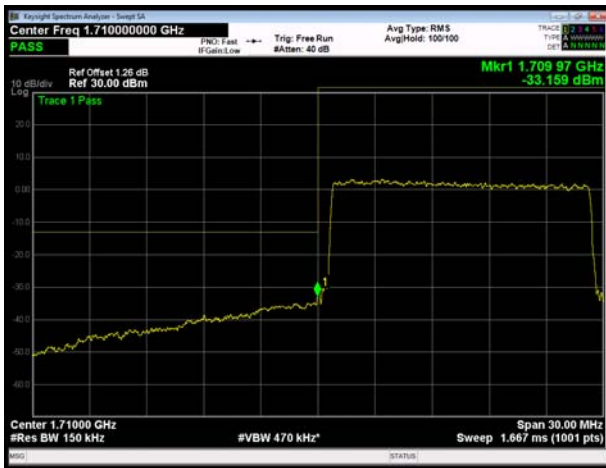

LTE Band 4 16QAM 15MHz CH-High, 100%RB



LTE Band 4 16QAM 20MHz CH-Low, 1 RB

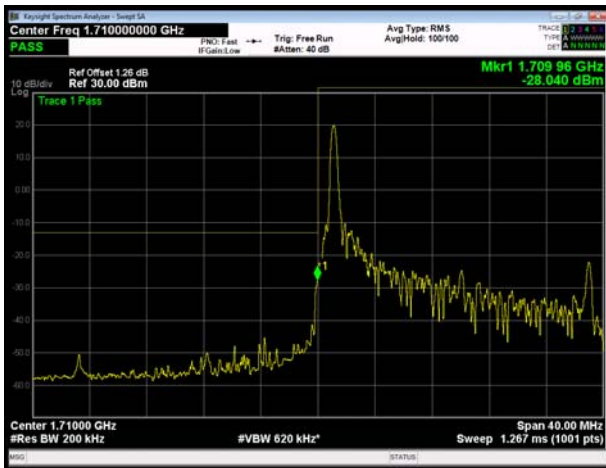

LTE Band 4 16QAM 20MHz CH-High, 1 RB

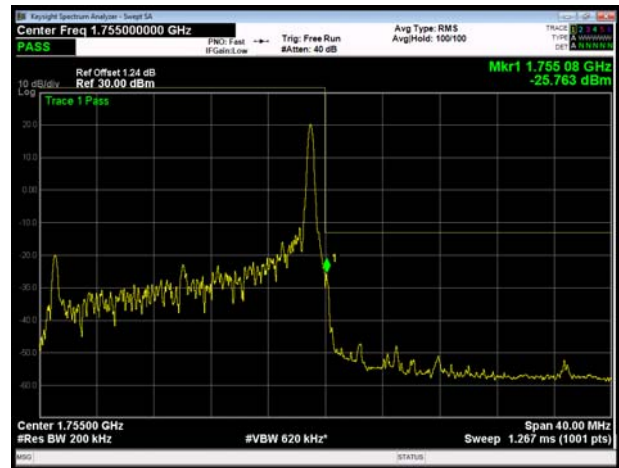

LTE Band 4 16QAM 20MHz CH-Low, 100%RB

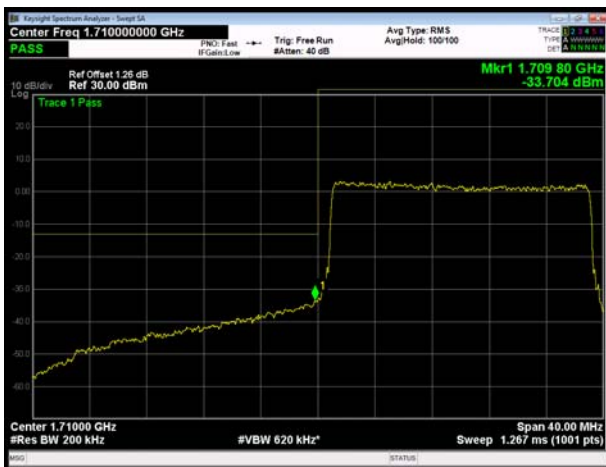

LTE Band 4 16QAM 20MHz CH-High, 100%RB

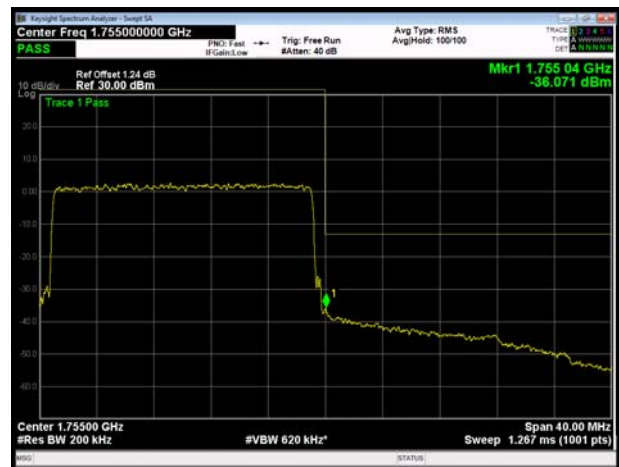



6.4 Peak-to-Average Power Ratio (PAPR)

LTE Band 4								
Modulation	Bandwidth (MHz)	Channel	Frequency (MHz)	Peak (dBm)	Avg (dBm)	PAPR (dB)	Limit (dB)	Conclusion
QPSK	1.4	19957	1710.7	26.85	21.64	5.21	≤13	PASS
		20175	1732.5	27.49	21.71	5.78	≤13	PASS
		20393	1754.3	27.02	21.60	5.42	≤13	PASS
	3	19965	1711.5	26.87	21.69	5.18	≤13	PASS
		20175	1732.5	27.41	21.72	5.69	≤13	PASS
		20385	1753.5	27.15	21.63	5.52	≤13	PASS
	5	19975	1712.5	26.89	21.76	5.13	≤13	PASS
		20175	1732.5	27.44	21.69	5.75	≤13	PASS
		20375	1752.5	27.11	21.68	5.43	≤13	PASS
	10	20000	1715	27.14	21.75	5.39	≤13	PASS
		20175	1732.5	27.53	21.71	5.82	≤13	PASS
		20350	1750	27.16	21.81	5.35	≤13	PASS
	15	20025	1717.5	27.58	21.78	5.80	≤13	PASS
		20175	1732.5	27.81	21.71	6.10	≤13	PASS
		20325	1747.5	27.42	21.78	5.64	≤13	PASS
20	20050	1720	27.48	21.75	5.73	≤13	PASS	
	20175	1732.5	27.54	21.69	5.85	≤13	PASS	
	20300	1745	27.33	21.78	5.55	≤13	PASS	
16QAM	1.4	19957	1710.7	26.82	20.95	5.87	≤13	PASS
		20175	1732.5	27.28	20.77	6.51	≤13	PASS
		20393	1754.3	27.07	20.81	6.26	≤13	PASS
	3	19965	1711.5	27.76	21.72	6.04	≤13	PASS
		20175	1732.5	27.43	20.86	6.57	≤13	PASS
		20385	1753.5	27.04	20.72	6.32	≤13	PASS
	5	19975	1712.5	26.70	20.58	6.12	≤13	PASS
		20175	1732.5	27.29	20.82	6.47	≤13	PASS
		20375	1752.5	27.04	20.79	6.25	≤13	PASS
	10	20000	1715	26.92	20.75	6.17	≤13	PASS
		20175	1732.5	27.42	20.80	6.62	≤13	PASS
		20350	1750	27.06	20.90	6.16	≤13	PASS
	15	20025	1717.5	27.18	20.79	6.39	≤13	PASS
		20175	1732.5	27.47	20.86	6.61	≤13	PASS
		20325	1747.5	27.05	20.85	6.20	≤13	PASS
20	20050	1720	27.26	20.80	6.46	≤13	PASS	
	20175	1732.5	27.25	20.69	6.56	≤13	PASS	
	20300	1745	27.14	20.88	6.26	≤13	PASS	

6.5 Frequency Stability

LTE Bnad 4						
Condition		Freq.Error (Hz)	Freq.Error (Hz)	Frequency Stability (ppm)	Frequency Stability (ppm)	Verdict
BANDWIDTH	1.4MHz					
Temperature	Voltage	16QAM	QPSK	16QAM	QPSK	
Normal (25°C)	Normal	12.72	5.31	0.00734	0.00307	PASS
Extreme (50°C)		11.49	4.99	0.00663	0.00288	PASS
Extreme (40°C)		16.89	15.33	0.00975	0.00885	PASS
Extreme (30°C)		2.88	7.04	0.00166	0.00406	PASS
Extreme (20°C)		13.30	12.95	0.00768	0.00748	PASS
Extreme (10°C)		15.18	12.57	0.00876	0.00726	PASS
Extreme (0°C)		12.48	11.21	0.00720	0.00647	PASS
Extreme (-10°C)		9.76	7.17	0.00563	0.00414	PASS
Extreme (-20°C)		17.65	13.80	0.01019	0.00796	PASS
Extreme (-30°C)		6.00	12.79	0.00346	0.00739	PASS
25°C	LV	7.39	16.41	0.00426	0.00947	PASS
	HV	9.54	6.72	0.00551	0.00388	PASS
Condition		Freq.Error (Hz)	Freq.Error (Hz)	Frequency Stability (ppm)	Frequency Stability (ppm)	Verdict
BANDWIDTH	3MHz					
Temperature	Voltage	16QAM	QPSK	16QAM	QPSK	
Normal (25°C)	Normal	4.73	5.49	0.00273	0.00317	PASS
Extreme (50°C)		1.16	10.83	0.00067	0.00625	PASS
Extreme (40°C)		8.98	1.07	0.00518	0.00062	PASS
Extreme (30°C)		6.67	6.41	0.00385	0.00370	PASS
Extreme (20°C)		8.28	16.33	0.00478	0.00943	PASS
Extreme (10°C)		9.90	9.89	0.00572	0.00571	PASS
Extreme (0°C)		5.56	13.71	0.00321	0.00792	PASS
Extreme (-10°C)		6.58	17.90	0.00380	0.01033	PASS
Extreme (-20°C)		9.52	5.09	0.00549	0.00294	PASS
Extreme (-30°C)		11.86	12.13	0.00685	0.00700	PASS
25°C	LV	3.20	2.17	0.00185	0.00125	PASS
	HV	4.74	17.81	0.00274	0.01028	PASS
Condition		Freq.Error (Hz)	Freq.Error (Hz)	Frequency Stability (ppm)	Frequency Stability (ppm)	Verdict
BANDWIDTH	5MHz					
Temperature	Voltage	16QAM	QPSK	16QAM	QPSK	
Normal (25°C)	Normal	15.93	3.26	0.00919	0.00188	PASS



Extreme (50°C)		15.66	7.13	0.00904	0.00411	PASS
Extreme (40°C)		5.53	17.28	0.00319	0.00997	PASS
Extreme (30°C)		7.97	9.54	0.00460	0.00550	PASS
Extreme (20°C)		10.82	10.03	0.00624	0.00579	PASS
Extreme (10°C)		14.53	14.48	0.00839	0.00836	PASS
Extreme (0°C)		5.03	17.31	0.00290	0.00999	PASS
Extreme (-10°C)		7.97	5.40	0.00460	0.00312	PASS
Extreme (-20°C)		5.60	1.23	0.00323	0.00071	PASS
Extreme (-30°C)		10.18	5.32	0.00588	0.00307	PASS
25°C	LV	14.38	9.12	0.00830	0.00527	PASS
	HV	5.66	13.20	0.00327	0.00762	PASS
Condition		Freq.Error (Hz)	Freq.Error (Hz)	Frequency Stability (ppm)	Frequency Stability (ppm)	Verdict
BANDWIDTH	10MHz					
Temperature	Voltage	16QAM	QPSK	16QAM	QPSK	
Normal (25°C)	Normal	17.00	9.56	0.00981	0.00552	PASS
Extreme (50°C)		17.13	13.35	0.00989	0.00771	PASS
Extreme (40°C)		7.79	14.97	0.00450	0.00864	PASS
Extreme (30°C)		4.81	15.50	0.00278	0.00894	PASS
Extreme (20°C)		9.53	16.30	0.00550	0.00941	PASS
Extreme (10°C)		5.73	2.60	0.00331	0.00150	PASS
Extreme (0°C)		10.96	1.23	0.00632	0.00071	PASS
Extreme (-10°C)		8.59	15.70	0.00496	0.00906	PASS
Extreme (-20°C)		16.32	14.05	0.00942	0.00811	PASS
Extreme (-30°C)		12.88	13.35	0.00743	0.00771	PASS
25°C	LV	14.68	2.41	0.00847	0.00139	PASS
	HV	7.43	11.65	0.00429	0.00673	PASS
Condition		Freq.Error (Hz)	Freq.Error (Hz)	Frequency Stability (ppm)	Frequency Stability (ppm)	Verdict
BANDWIDTH	15MHz					
Temperature	Voltage	16QAM	QPSK	16QAM	QPSK	
Normal (25°C)	Normal	14.82	6.91	0.00855	0.00399	PASS
Extreme (50°C)		14.88	9.51	0.00859	0.00549	PASS
Extreme (40°C)		16.27	1.42	0.00939	0.00082	PASS
Extreme (30°C)		1.53	16.68	0.00088	0.00963	PASS
Extreme (20°C)		13.64	11.04	0.00787	0.00637	PASS
Extreme (10°C)		6.27	10.35	0.00362	0.00598	PASS
Extreme (0°C)		16.63	17.83	0.00960	0.01029	PASS
Extreme (-10°C)		4.14	16.21	0.00239	0.00936	PASS
Extreme (-20°C)		5.87	2.82	0.00339	0.00163	PASS
Extreme (-30°C)		14.47	10.05	0.00835	0.00580	PASS



Condition		Freq.Error (Hz)	Freq.Error (Hz)	Frequency Stability (ppm)	Frequency Stability (ppm)	Verdict
BANDWIDTH	20MHz					
25°C	LV	13.33	12.51	0.00769	0.00722	PASS
	HV	6.96	1.18	0.00402	0.00068	PASS
Temperature	Voltage	16QAM	QPSK	16QAM	QPSK	
Normal (25°C)	Normal	1.71	5.79	0.00099	0.00334	PASS
Extreme (50°C)		17.19	5.15	0.00992	0.00297	PASS
Extreme (40°C)		8.38	1.63	0.00484	0.00094	PASS
Extreme (30°C)		2.33	11.30	0.00134	0.00652	PASS
Extreme (20°C)		6.97	12.74	0.00402	0.00735	PASS
Extreme (10°C)		5.20	15.59	0.00300	0.00900	PASS
Extreme (0°C)		6.85	5.99	0.00396	0.00346	PASS
Extreme (-10°C)		13.71	6.57	0.00792	0.00379	PASS
Extreme (-20°C)		11.09	4.55	0.00640	0.00263	PASS
Extreme (-30°C)		10.74	13.83	0.00620	0.00799	PASS
25°C	LV	16.51	15.45	0.00953	0.00892	PASS
	HV	10.30	17.97	0.00594	0.01037	PASS

6.6 Spurious Emissions at Antenna Terminals

Sweep the whole frequency band through the range from 9kHz to the 10th harmonic of the carrier, the emissions more than 20 dB below the limit are not reported. The signal beyond the limit is carrier.

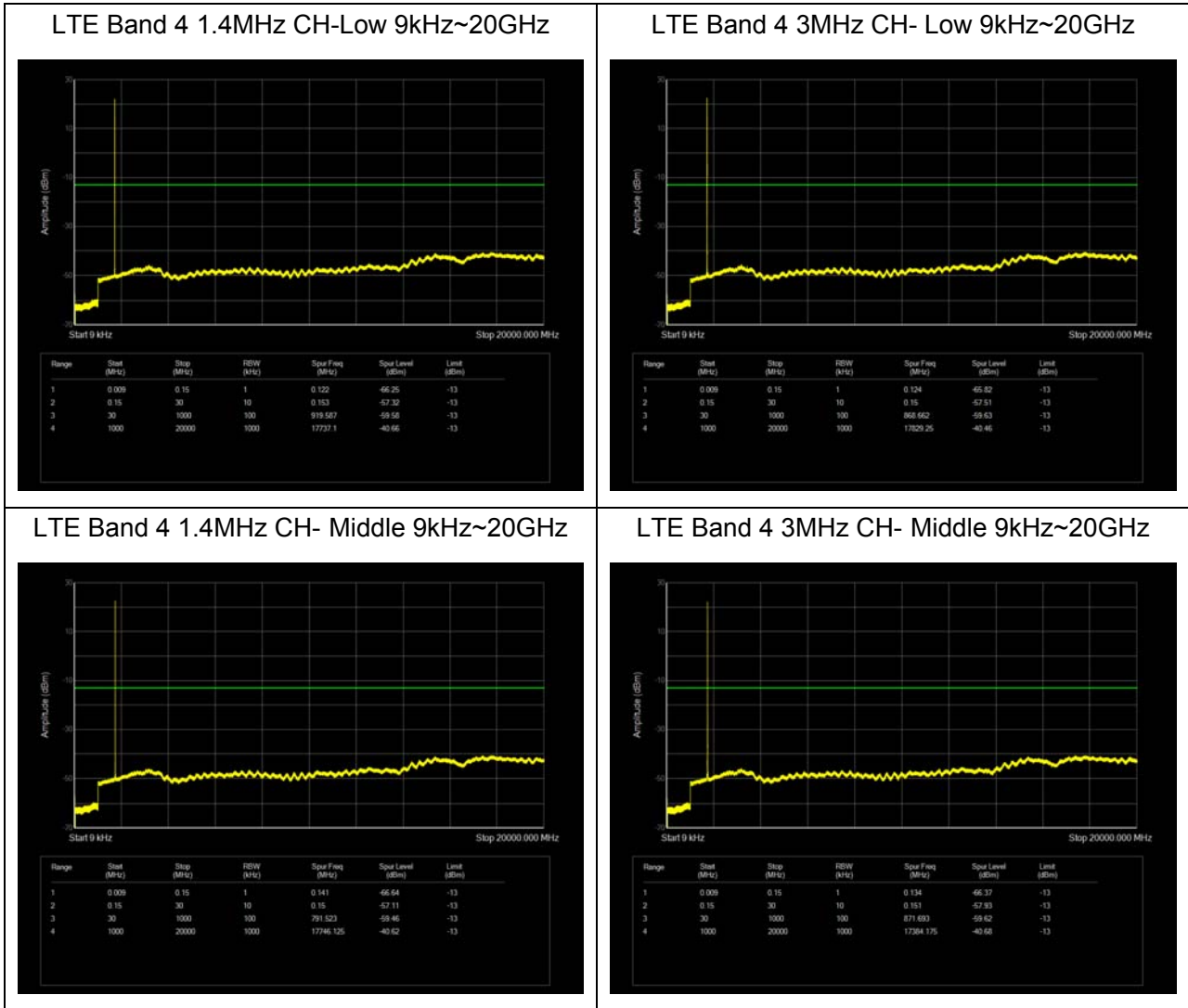



LTE Band 4 1.4MHz CH- High 9kHz~20GHz

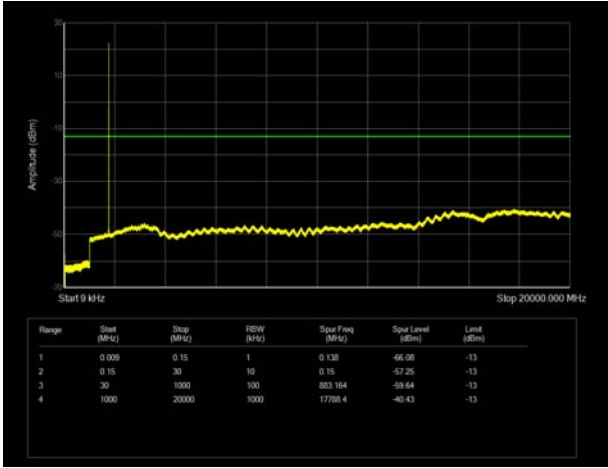

LTE Band 4 3MHz CH-High 9kHz~20GHz

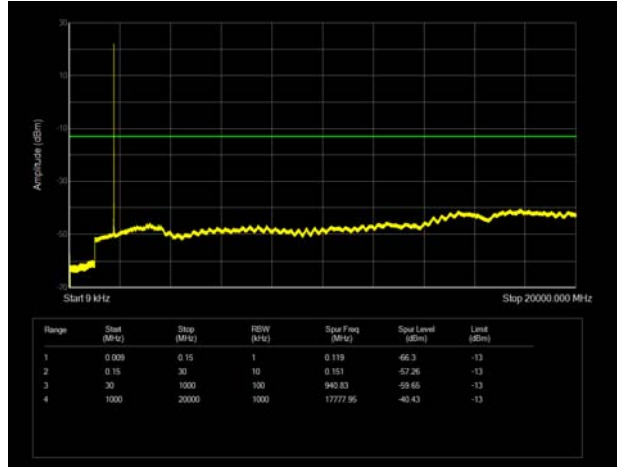

LTE Band 4 5MHz CH- Low 9kHz~20GHz

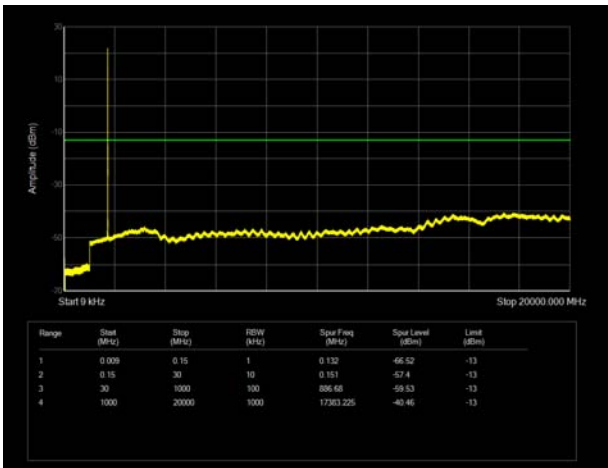

LTE Band 4 10MHz CH-Low 9kHz~20GHz

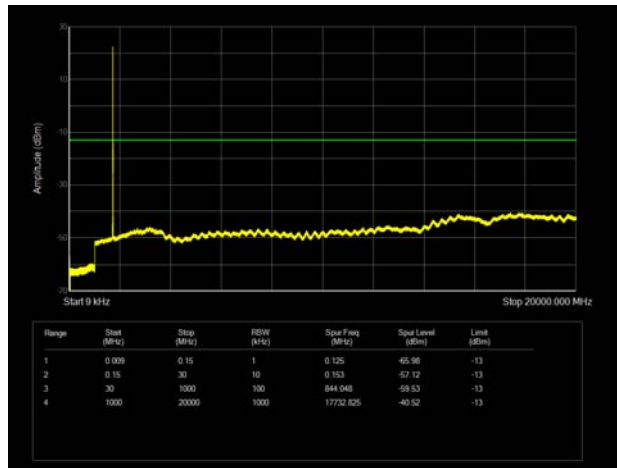

LTE Band 4 5MHz CH- Middle 9kHz~20GHz

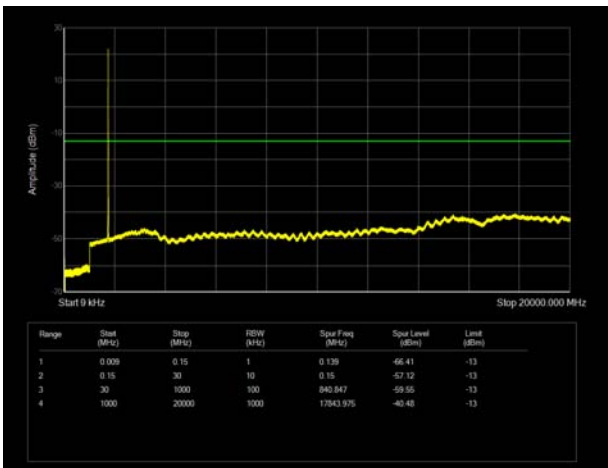

LTE Band 4 10MHz CH- Middle 9kHz~20GHz

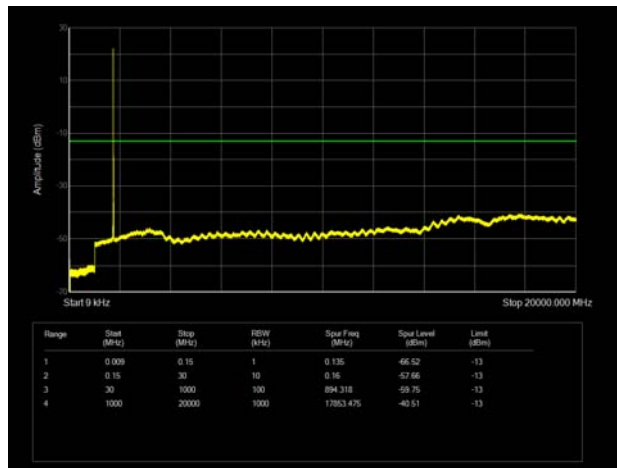

LTE Band 4 5MHz CH-High 9kHz~20GHz

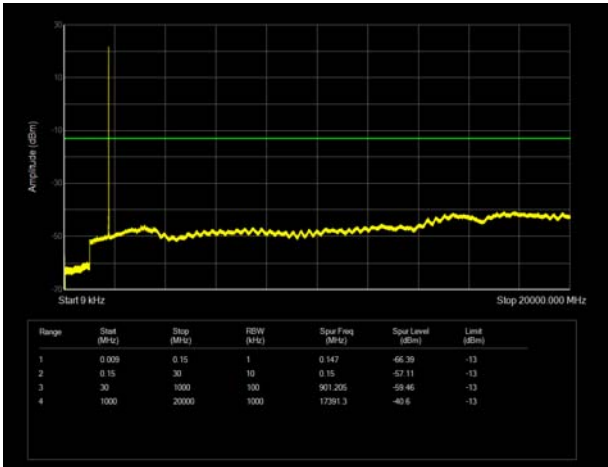

LTE Band 4 10MHz CH- High 9kHz~20GHz

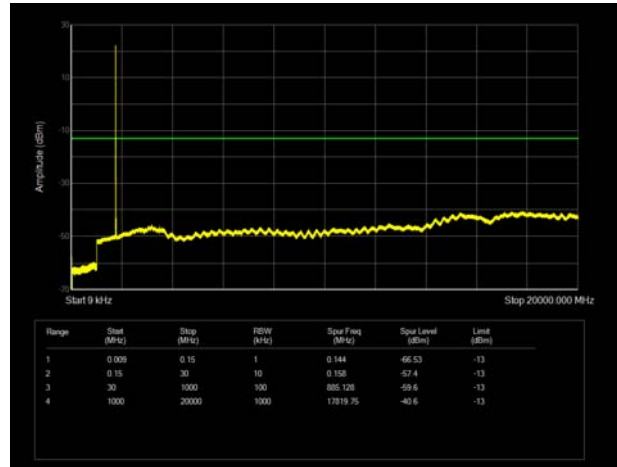

LTE Band 4 15MHz CH- Low 9kHz~20GHz

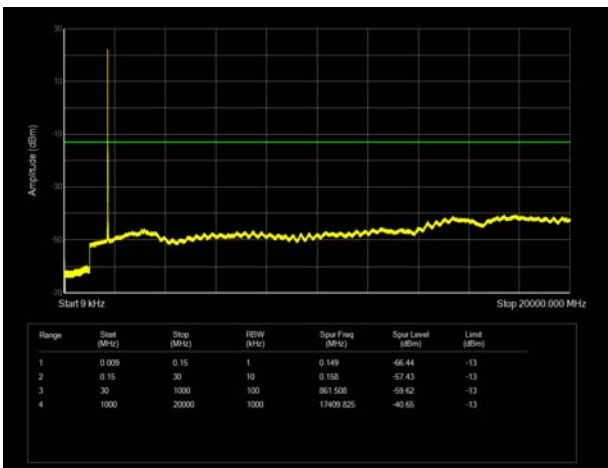

LTE Band 4 20MHz CH-Low 9kHz~20GHz

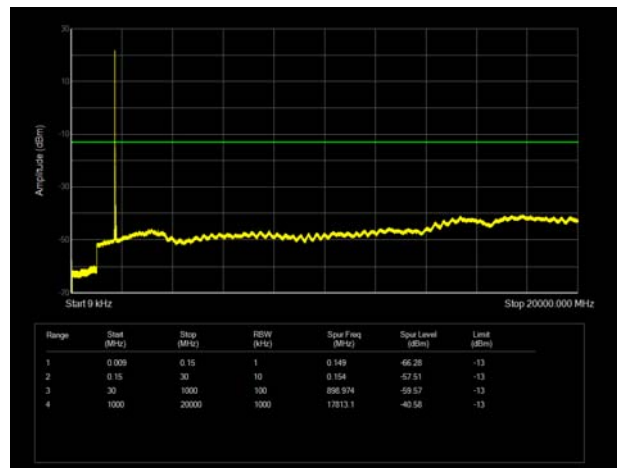

LTE Band 4 15MHz CH- Middle 9kHz~20GHz

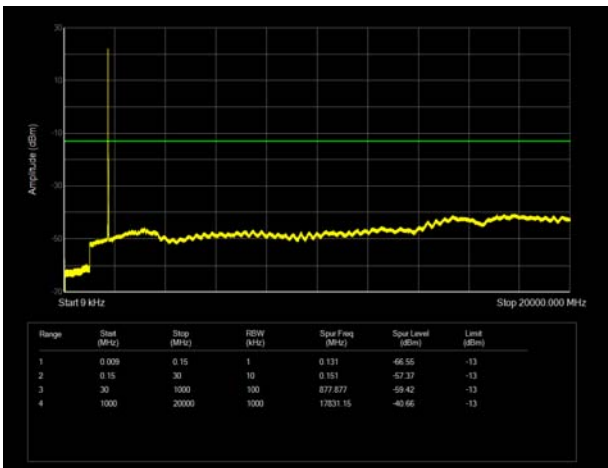

LTE Band 4 20MHz CH- Middle 9kHz~20GHz

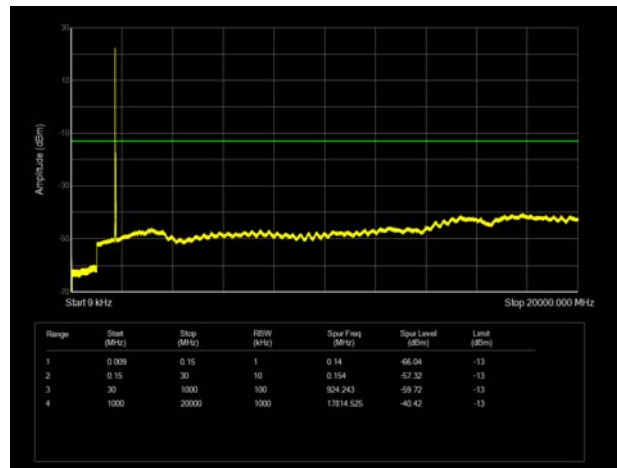



LTE Band 4 15MHz CH-High 9kHz~20GHz

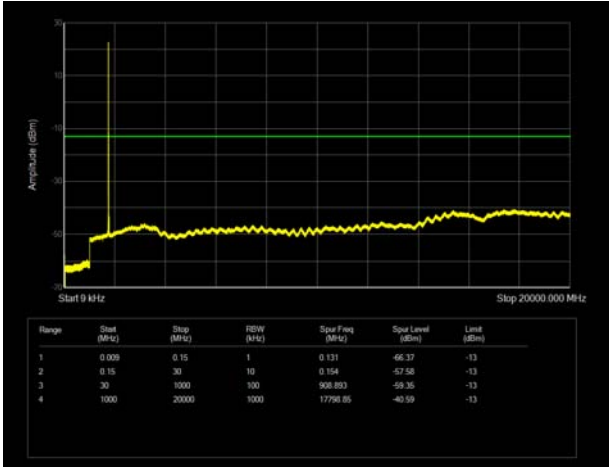

LTE Band 4 20MHz CH- High 9kHz~20GHz

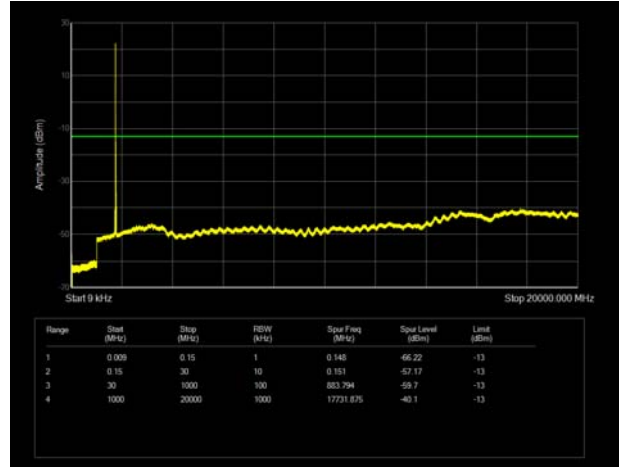

6.7 Radiates Spurious Emission

Sweep the whole frequency band through the range from 9kHz to the 10th harmonic of the carrier, the emissions below the noise floor will not be recorded in the report.

LTE Band 4 QPSK 1.4MHz CH-Middle, RB 1

Harmonic	Frequency (MHz)	SG (dBm)	Cable Loss (dB)	Gain (dBi)	Antenna Polarization	EIRP Level (dBm)	Limit (dBm)	Margin (dB)	Azimuth (deg)
2	3464.25	-56.56	2.70	12.70	Vertical	-46.56	-13.00	33.56	0
3	5197.50	-61.33	3.20	12.50	Vertical	-52.03	-13.00	39.03	45
4	6930.00	-55.47	4.20	11.80	Vertical	-47.87	-13.00	34.87	90
5	8662.50	-51.64	4.40	12.50	Vertical	-43.54	-13.00	30.54	0
6	10395.00	-47.16	4.70	11.30	Vertical	-40.56	-13.00	27.56	45
7	12127.50	-49.65	5.20	13.80	Vertical	-41.05	-13.00	28.05	0
8	13860.00	-50.20	5.70	11.30	Vertical	-44.60	-13.00	31.60	0
9	15592.50	-57.02	6.10	16.80	Vertical	-46.32	-13.00	33.32	0
10	17325.00	-51.47	6.10	14.20	Vertical	-43.37	-13.00	30.37	45

Note: 1. The other Spurious RF Radiated emissions level is no more than noise floor.
 2. The worst emission was found in the antenna is Vertical position.

LTE Band 4 QPSK 5MHz CH-Middle, RB 1

Harmonic	Frequency (MHz)	SG (dBm)	Cable Loss (dB)	Gain (dBi)	Antenna Polarization	EIRP Level (dBm)	Limit (dBm)	Margin (dB)	Azimuth (deg)
2	3460.50	-55.01	2.70	12.70	Vertical	-45.01	-13.00	32.01	90
3	5191.50	-60.72	3.20	12.50	Vertical	-51.42	-13.00	38.42	90
4	6930.00	-55.89	4.20	11.80	Vertical	-48.29	-13.00	35.29	45
5	8662.50	-51.93	4.40	12.50	Vertical	-43.83	-13.00	30.83	0
6	10395.00	-48.15	4.70	11.30	Vertical	-41.55	-13.00	28.55	0
7	12127.50	-51.93	5.20	13.80	Vertical	-43.33	-13.00	30.33	135
8	13860.00	-51.14	5.70	11.30	Vertical	-45.54	-13.00	32.54	90
9	15592.50	-58.69	6.10	16.80	Vertical	-47.99	-13.00	34.99	0
10	17325.00	-52.39	6.10	14.20	Vertical	-44.29	-13.00	31.29	0

Note: 1. The other Spurious RF Radiated emissions level is no more than noise floor.
 2. The worst emission was found in the antenna is Vertical position.



LTE Band 4 QPSK 20MHz CH-Middle, RB 1

Harmonic	Frequency (MHz)	SG (dBm)	Cable Loss (dB)	Gain (dBi)	Antenna Polarization	EIRP Level (dBm)	Limit (dBm)	Margin (dB)	Azimuth (deg)
2	3447.75	-57.19	2.70	12.70	Vertical	-47.19	-13.00	34.19	0
3	5170.88	-54.97	3.20	12.50	Vertical	-45.67	-13.00	32.67	45
4	6930.00	-50.84	4.20	11.80	Vertical	-43.24	-13.00	30.24	90
5	8662.50	-50.47	4.40	12.50	Vertical	-42.37	-13.00	29.37	90
6	10395.00	-48.68	4.70	11.30	Vertical	-42.08	-13.00	29.08	45
7	12127.50	-55.69	5.20	13.80	Vertical	-47.09	-13.00	34.09	0
8	13860.00	-50.06	5.70	11.30	Vertical	-44.46	-13.00	31.46	135
9	15592.50	-57.93	6.10	16.80	Vertical	-47.23	-13.00	34.23	90
10	17325.00	-51.42	6.10	14.20	Vertical	-43.32	-13.00	30.32	0

Note: 1. The other Spurious RF Radiated emissions level is no more than noise floor.
2. The worst emission was found in the antenna is Vertical position.



7 Main Test Instruments

Date of Testing: May 9, 2022 ~ May 13, 2022

Name	Manufacturer	Type	Serial Number	Calibration Date	Expiration Date
Wireless Communication Tester	Anritsu	MT8000A	6261844783	2021-05-15	2022-05-14
Wireless Communication Tester	Anritsu	MT8821C	6201538758	2021-05-15	2022-05-14
Climate Chamber	WEISS	VT 4002	58226119450010	2021-05-15	2022-05-14
Universal Radio Communication Tester	R&S	CMW500	150415	2021-05-15	2022-05-14
Spectrum Analyzer	Keysight	N9020A	MY52330084	2021-05-15	2022-05-14
Universal Radio Communication Tester	Agilent	E5515C	GB44400275	2021-05-15	2022-05-14
Universal Radio Communication Tester	StarPoint	SP9500	SP9500-20440	2021-05-15	2022-05-14
Spectrum Analyzer	R&S	FSV3030	101411	2021-12-12	2022-12-11
Spectrum Analyzer	R&S	FSV30	104028	2021-12-12	2022-12-11

Date of Testing: May 22, 2022

Name	Manufacturer	Type	Serial Number	Calibration Date	Expiration Date
Radiates Spurious Emission					
TRILOG Broadband Antenna	Schwarzbeck	VULB 9163	01111	2019-09-12	2022-09-11
Loop Antenna	R&S	HM020E	101140	2021-06-07	2024-06-06
Horn Antenna	Schwarzbeck	BBHA 9120D	1594	2020-12-17	2023-12-16
Software	R&S	EMC32	10.35.10	/	/

*****END OF REPORT *****



ANNEX A: The EUT Appearance

The EUT Appearance are submitted separately.



ANNEX B: Test Setup Photos

The Test Setup Photos are submitted separately.