

# Suvie™

## Multi-Zone Cooking and Refrigeration

**Model No. S020M Suvie Kitchen Robot User Manual**

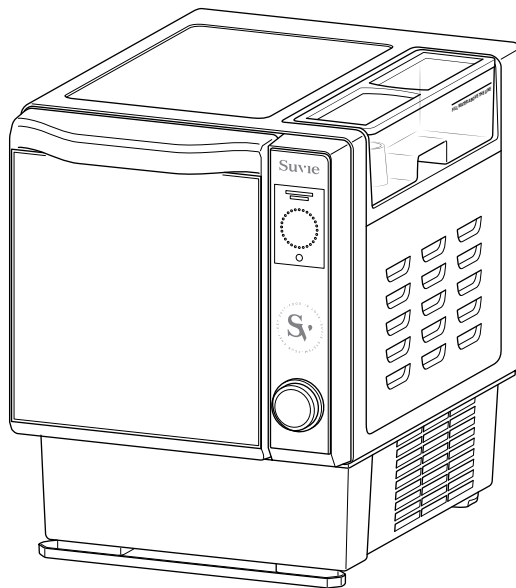

This product is intended for HOUSEHOLD USE ONLY

# IMPORTANT SAFETY INSTRUCTIONS



To reduce the risk of burns, electric shock, fire, or injury to persons when using your Suvie, be sure to follow the basic safety precautions in this section.

When using electrical appliances, ALWAYS follow basic safety precautions including all of the following:

1. Read all instructions.
2. Do not touch hot surfaces directly; use handles or knobs.
3. To protect against electrical shock do not immerse cord or plugs in water or other liquid.
4. Close supervision is necessary when any appliance is used by or near children.
5. Unplug from outlet before cleaning. Allow to cool before inserting or removing parts.
6. Do not operate any appliance with a damaged cord or plug or after the appliance malfunctions or has been damaged in any manner. Contact help@suvie.com for examination, repair, or adjustment.
7. The use of accessory attachments not recommended by the appliance manufacturer may cause injuries.
8. Do not use outdoors.
9. Do not let the cord hang over the edge of a table or counter, or to touch hot surfaces.
10. Do not place on or near a hot gas or electric burner, or in a heated oven.
11. Extreme caution must be used when moving an appliance containing hot oil or other hot liquids.
12. Always attach plug to appliance first, then plug cord into the wall outlet. To disconnect, turn any control to "off", then remove plug from the wall outlet.
13. Do not use appliance for anything other than its intended use.
14. Use extreme caution when removing trays or disposing of hot water or grease.
15. Do not clean with metal scouring pads. Pieces can break off the pad and touch electrical parts, creating a risk of electric shock.
16. Intended for countertop use only.

## ⚠ WARNING

*Spilled food can cause serious burns. Keep the appliance and cord away from children. Never drape the cord over the edge of a counter, never use an outlet below the counter, and never use an extension cord with this appliance.*

# SAVE THESE INSTRUCTIONS

# FCC (Federal Communications Commission)

The users manual for an intentional or unintentional radiator shall caution the user that changes or modifications not expressly approved by the party responsible for compliance could void the user's authority to operate the equipment. In cases where the manual is provided only in a form other than paper, such as on a computer disk or over the Internet, the information required by this section may be included in the manual in that alternative form, provided the user can reasonably be expected to have the capability to access information in that form.

**Note:** *This equipment has been tested and found to comply with the limits for a Class B digital device, pursuant to part 15 of the FCC Rules. These limits are designed to provide reasonable protection against harmful interference in a residential installation. This equipment generates uses and can radiate radio frequency energy and, if not installed and used in accordance with the instructions, may cause harmful interference to radio communications. However, there is no guarantee that interference will not occur in a particular installation. If this equipment does cause harmful interference to radio or television reception, which can be determined by turning the equipment off and on, the user is encouraged to try to correct the interference by one or more of the following measures:*

- *Reorient or relocate the receiving antenna.*
- *Increase the separation between the equipment and receiver.*
- *Connect the equipment into an outlet on a circuit different from that to which the receiver is connected.*
- *Consult the dealer or an experienced radio/TV technician for help. This device should be installed and operated with minimum 20 cm between the radiator and your body.*

## ⚠ WARNING

This equipment may generate or use radio frequency energy. Changes or modifications to this equipment may cause harmful interference unless the modifications are expressly approved in the instruction manual. The user could lose the authority to operate this equipment if an unauthorized change or modification is made.

- Changes or modifications not expressly approved by the party responsible for compliance could void the user's authority to operate the equipment.
- This device should be installed and operated with minimum 20 cm between the radiator and your body.

This device complies with part 15 of the FCC's Rules. Operation is subject to the following two conditions:

1. This device may not cause harmful interference.
2. This device must accept any interference received, including interference that may cause undesirable operation.

## Safety Symbols



These safety alert symbols can be found throughout the guide, alerting you to potential hazards. It's important to comply with these directives to avoid possible injury or death.



**DANGER**

Indicates a hazardous situation which you must prevent to avoid death or injury.



**WARNING**

Indicates a hazardous situation which you should prevent to avoid possible death or injury.



**CAUTION**

Indicates a hazardous situation which you must prevent to avoid injury.

**NOTICE**

Specifies a good practice or conveys important information.

## How To Contact Suvie

Contact us with questions or concerns.

Email: [help@suvie.com](mailto:help@suvie.com)

## Before Using Your Suvie



**DANGER**

Do not operate Suvie if the cord or plug becomes damaged, if the appliance malfunctions, or if the Suvie is dropped or damaged in any manner. Contact Suvie immediately for examination, repair, or electrical or mechanical adjustment.



**WARNING**

- Place Suvie on a clean, solid, even surface to help prevent it from slipping. An anti-tip bracket may be attached to the back of the appliance and the wall behind it for extra stability, especially if there are young children in the house.
- Never use the Suvie in combination with parts or equipment from older generations of Suvie. Never use your Suvie with damaged accessories.
- The use of attachments or items not recommended or sold by Suvie may cause fire, electric shock, or injury.
- The Suvie can generate a constant flow of steam while cooking. Keep away from any hot steam that escapes the appliance during operation. Steam may also leave traces of moisture on your countertop. Be mindful of objects that sit near your appliance.
- Scalding due to food that has overheated may occur if attempting to use quantities of food in excess of a tray's capacity. If overheating occurs, unplug the appliance and allow it to cool. Use care when removing all components as they may stay hot for some time.
- To avoid scalding, burn injury, and laceration hazard, do not attempt to open the Suvie door by force. Only open the door when the program is complete.
- Fire hazard: Keep Suvie away from outside heat sources to avoid risk of fire.
- Trays will be hot: Always use an oven mitt when removing trays after cooking as they may be extremely hot.
- Not intended for use by children: Close supervision is necessary when the Suvie is used by or near children.
- You may get burned or scalded by escaping hot food or steam or by touching hot surfaces.
- Remove all trays carefully to prevent contents from spilling or splashing.

**⚠ CAUTION**

- Damaged accessories may cause injury. If any Suvie accessories are damaged during food preparation, discard food. Contact [help@suvie.com](mailto:help@suvie.com) for a replacement accessory.
- Never remove the reservoir or add more water during a cook.
- Do not modify your Suvie or any accessories.
- Never leave Suvie unattended while it is in Broil, Bake, Roast, or Rapid Cook mode.
- Keep your Suvie away from the edge of your counter to help prevent it from falling off. Specific set up instructions are on Page 11 of this manual.

**NOTICE**

- Never overload trays beyond their top or, with the starch pan, their recommended fill level.
- Be sure to keep the Broiler element clean of any food after use.
- Unplug the Suvie from outlet before cleaning.
- Do not put the Suvie appliance in water or other liquid.
- Suvie recommends using only distilled water in the appliance.

## SAVE THESE INSTRUCTIONS

Welcome to

# Suvie™

BEFORE OPERATING THIS PRODUCT, IT IS IMPORTANT TO READ,  
UNDERSTAND, AND FOLLOW THESE INSTRUCTIONS.

PLEASE SAVE THIS BOOKLET FOR FUTURE REFERENCE.

# Contents of this Manual

IMPORTANT SAFETY INSTRUCTIONS .....	1
FCC (FEDERAL COMMUNICATIONS COMMISSION) .....	2
SAFETY SYMBOLS .....	3
HOW TO CONTACT SUVIE .....	3
BEFORE USING YOUR SUVIE .....	4
TECHNICAL DATA .....	9
GETTING TO KNOW YOUR NEW PERSONAL CHEF .....	10
COUNTERTOP PLACEMENT .....	11
GROUNDING INSTRUCTIONS .....	12
QUICK ON-SCREEN SETUP .....	13
YOUR SUVIE ACCOUNT .....	15
FILLING THE WATER RESERVOIR .....	15
Water Level & Placement .....	15
Water Bubbling When In Use .....	16
REFRIGERATION INFORMATION .....	17
COOLING AFTER COMPLETING A COOK .....	17
Safely Cool To Prepare Your Next Meal .....	17
TAKING YOUR FOOD FROM COOL-TO-COOK .....	17
How Suvie Calculates Cook Time .....	18
YOUR SUVIE PANS .....	18
HOW IT WORKS .....	19
Simple Preparation Steps for Multi-Zone Cooking .....	19
Cooking Zone Function Capabilities .....	23
Sous Vide Time & Temp Chart .....	24
Vegetable Roasting Recommendations .....	24
Protein Roasting Chart .....	25
COOKING FUNCTIONS .....	25
Suvie Core Functions: .....	25
Cool to Cook .....	25
Waiting for the chart .....	25

Cool-to-Cook Refrigerating vs Scheduling when Using Bake, Roast, Broil, and Rapid Cook Functions: .....	26
Frozen to Cook .....	26
Sous Vide .....	27
Slow Cook .....	27
Roast .....	28
Bake .....	28
Broil .....	29
Warm & Reheat .....	29
Steam .....	30
Egg Mode .....	30
Suvie Starch Cooker Expanded Functions: .....	31
Rice .....	31
Pasta .....	31
Healthy Grains .....	31
COOK SETTINGS FOR SUVIE SMART MEALS .....	32
The Tap Zone .....	32
Safe Packaging with Suvie Smart Meals .....	32
MODIFYING COOK SETTINGS OR CANCELLING YOUR MEAL .....	34
Easily Make Changes to Your Meal or Cancel It Entirely .....	34
SCHEDULING SUVIE FROM YOUR PHONE .....	35
Suvie Automatically Updates the Mobile App .....	36
When Dinner Will Finish .....	36
Monitor the Status of Your Suvie .....	36
WHEN COOKING IS COMPLETE .....	37
SUVIE CONTROL PANEL AND FEATURES .....	37
CLEANUP AND MAINTENANCE .....	41
EXPAND YOUR MEAL WITH THE SUVIE STARCH COOKER .....	41
DESCALE YOUR SUVIE .....	42
Keep Your Suvie Looking Brand New .....	42
Descaling Your Machine .....	42
Cleaning Your Reservoir .....	43

## Technical Data

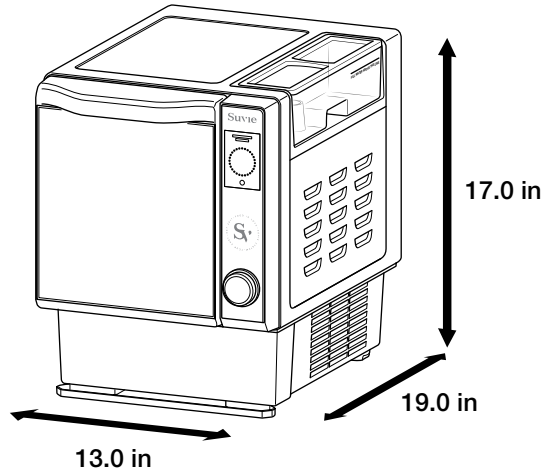

Certification Marks	Submitted to UL for U.S. Approval
Heating System	1,400 W power consumption with protection against overheating
Power	110-120 VAC 50/60Hz Maximum power consumption 1,400W (110V / 15A) Detachable power cord, 30 inches in length
Dimensions	Height: 17.0 inches Width: 13.0 inches Depth: 19.0 inches
Weight	55.0 pounds
Suvie Pan Volume	1.75 L x 2 Pans
Control Panel	3.5" Color LCD Screen, Resolution 480 x 320 with push-button rotary dial

## Getting To Know Your New Personal Chef

The Suvie appliance uses water with two zones of temperature control to independently cook your ingredients. Please be aware that some cooking functions require the reservoir to be filled with water prior to cooking. Suvie will prompt you to fill the reservoir when needed.

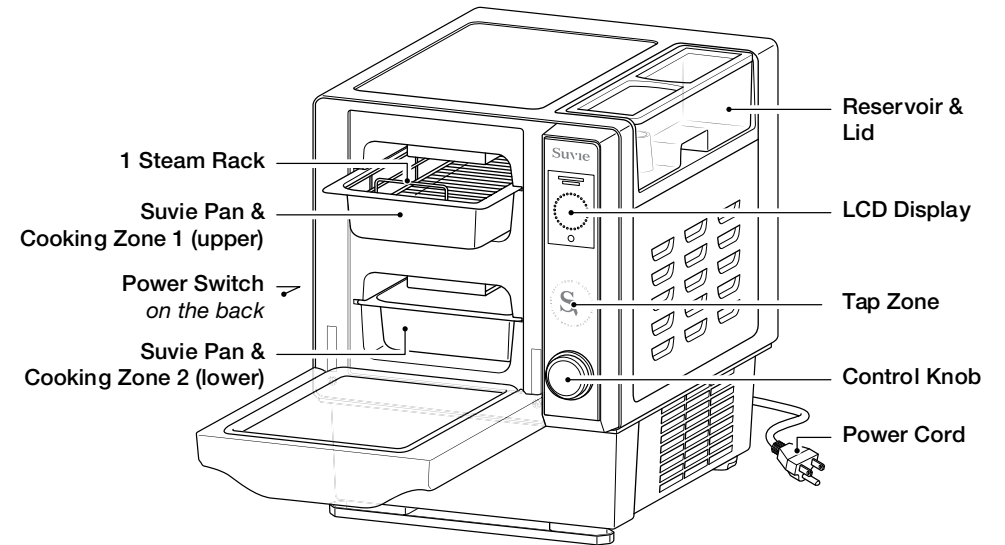

Once you've loaded your Wi-Fi connected Suvie appliance, recipes will automatically download, and you may use the Tap Zone with your Smart Meals to confirm what will be cooked. Refrigeration will then begin if you choose to schedule your meal at a later time.

If using your own ingredients, you will have the option to choose your desired cooking function, and set the appropriate cooking temperatures/times manually using one of the My Cook functions. See page 36 for instructions when cooking using your own ingredients).

You can also use your phone to schedule or reschedule your meal when away from the unit (see instructions on page 33).

## Countertop Placement

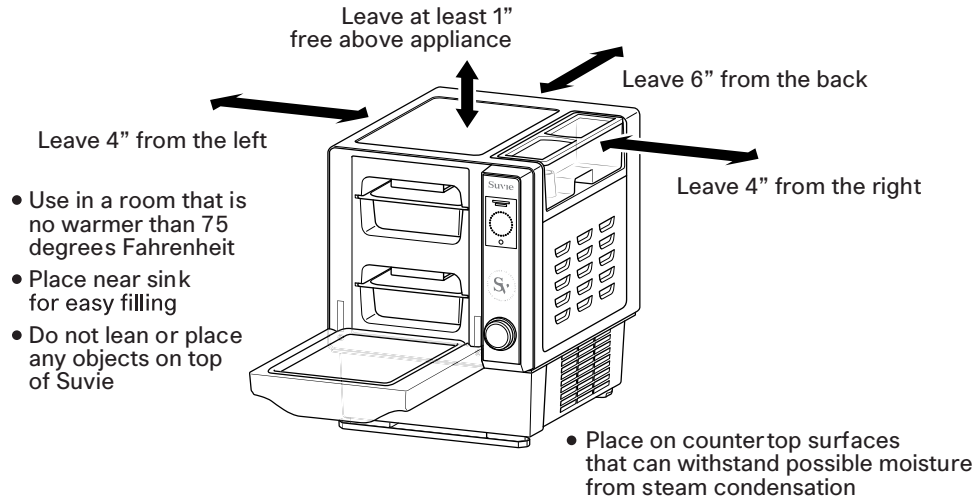

Leave Suvie upright for 24 hours prior to refrigerating or scheduling to allow coolant to settle.

### ⚠ WARNING

- A child or adult can tip the appliance causing serious injury or death. An anti-tip bracket should be installed at the back of the appliance and attached to the wall behind it for extra stability and protection.
- Do not install your Suvie over a range cooktop or other appliance that produces heat. Installation of your Suvie near a heat source can adversely affect the operation and possibly cause damage.
- Never use an extension cord with Suvie.

### ⚠ CAUTION

- Remove all packing materials and accessories. Examine your Suvie for any damage such as dents or broken components.
- Remove any protective film on the oven or component surfaces.
- To prevent damage, do not block any inlet or outlet openings.

## Grounding Instructions

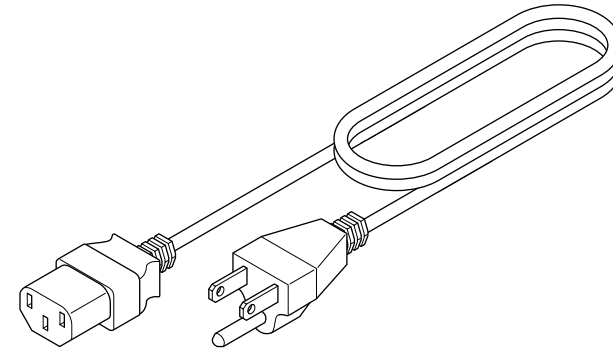

The Suvie appliance must be grounded while in use to protect the operator from electrical shock. Suvie is equipped with a 3-conductor cord and a 3-prong grounding-type plug to fit the proper grounding-type receptacle. The appliance has a plug similar to the figure above.

The grounding tab which extends from the adapter must connect to the permanent ground in the outlet box. Plug your Suvie into a GFCI (Ground Fault Circuit Interrupter) if within 6 feet from a sink.

# Quick On-Screen Setup

The first time you plug in your Suvie, the on-screen instructions will guide you through a simple setup process.

This setup includes: setting the date & time, connecting to WiFi, and downloading the latest Smart Meal recipes.

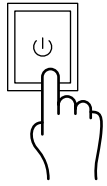

**Turn On:** Turn on using the power switch on back

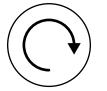

**Turn the control knob** to see options.



**Push the control knob** to select an option.

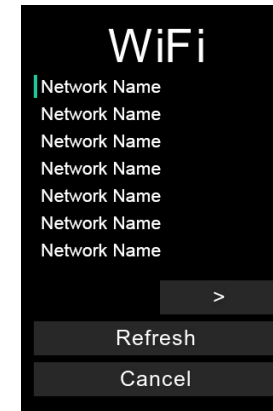
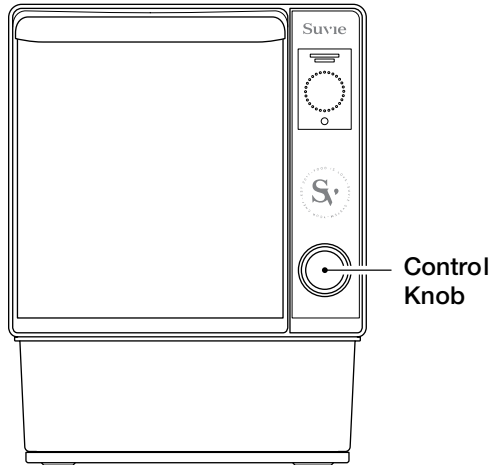

A list of detectable Wi-Fi networks will appear. Rotate the dial to select the network Suvie will use to connect to the Internet.

Press the control knob to make your selection.

Enter your password by rotating the dial and pressing on each character.

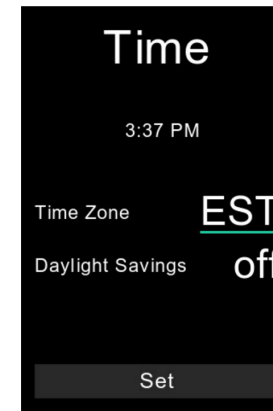

Date and time will then be set automatically. You may adjust the time zone, and there is an option for daylight savings.

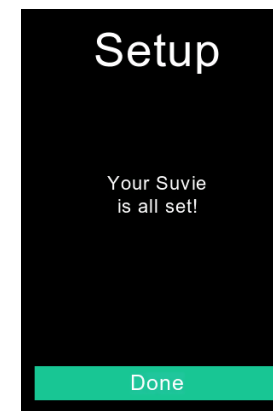

Once all settings have been confirmed, Suvie will download updates automatically, and then will reboot. Please be patient as this process may take several minutes to complete. Once the setup has finished, Suvie will show you a complete screen and your appliance is now ready to use.



## Your Suvie Account

Your Suvie will automatically register once it has been connected to WiFi.

To login to your Suvie account go to: <https://app.suvie.com>

Your Suvie account can be used to:

- Order Suvie Smart Meals
- Update shipping address
- Update billing information
- Update account name and phone number

Looking for Suvie recipes? Visit <https://blog.suvie.com>

## Filling the Water Reservoir

### Water Level & Placement

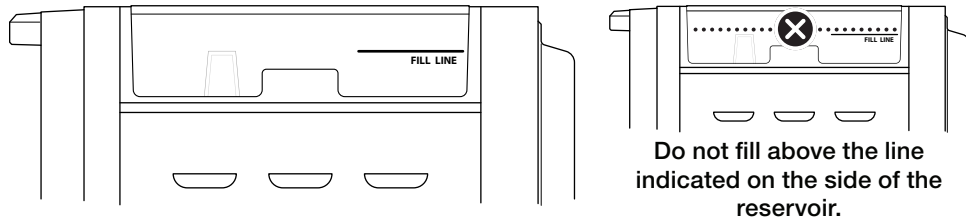

#### ONLY FILL RESERVOIR WHEN PROMPTED ON DISPLAY

Not all cooking functions require the the water reservoir to be filled prior to use.

#### ONLY FILL THE RESERVOIR WITH WATER WHEN PROMPTED.

The water in the unit is used for refrigeration as well as cooking for some functions. For functions that require water, Suvie will prompt you to fill the reservoir with water when needed. Do not add water to the reservoir unless prompted on the LCD display.

Please be aware that Suvie will not use all of the water in the reservoir while cooking or cooling. Suvie will only use the exact amount of water needed and this water will evaporate over time, without needing to drain.

There are two methods to fill the water reservoir:

1. Pull up to remove the reservoir from the appliance and fill it to the fill line indicated in your nearby sink. When replacing the reservoir, be sure to push down firmly to ensure proper placement; then cover with lid.
2. Fill a pitcher with water and pour directly into the reservoir placed in the unit until the water level reaches the fill line indicated.

#### ⚠ WARNING

- Never remove the reservoir while Suvie is cooking or refrigerating.

#### NOTICE

- Do not add additional water to the reservoir once the unit begins cooking or refrigerating.

#### ⚠ CAUTION

- The reservoir will steam and get hot while cooking. Do not touch the reservoir while it is in use.

#### ⚠ WARNING

- We recommend using distilled water in your Suvie. Never use anything in the reservoir other than water or cleaning solution as indicated by Suvie.

## Water Bubbling When In Use

#### ⚠ CAUTION

- Water inside your reservoir will boil and bubble while cooking. Do not touch the water reservoir when in use, as it may be hot.

This bubbling and noise is completely normal and is expected behavior.

## Refrigeration Information

Suvie uses a water-based cooling method (refrigerant type R513a) similar to that of your household refrigerator to keep your ingredients cold until they are ready to be cooked. Suvie is designed to keep your food under 41°F as per FDA safe storage guidelines. For best refrigeration performance, please make sure to follow our counter-top placement guidelines on page 11.

By refrigerating your vegetables and proteins, Suvie allows you the convenience of being able to load ingredients either in the morning before work or in the evening before bed, so you have a perfectly cooked meal that is ready to enjoy when you want it. Suvie is designed to refrigerate a meal up to one day prior to cooking and not longer.

## Cooling After Completing a Cook

### Safely Cool To Prepare Your Next Meal

Loading your meal into Suvie the night before is a great way to save time. For best refrigeration performance, please allow Suvie to rest with the door open for at least 2 hours after cooking before scheduling your next meal.

## Taking Your Food From Cool-to-Cook

Simply tell Suvie when you want to eat, and Suvie performs meticulous calculations to ensure a perfectly prepared and timed meal.

Start times vary in each of the different cooking zones based on the method of cooking.

After you've filled the reservoir, a typical Suvie cool-to-cook process is generally as follows:

- Your Suvie is rapidly cooled to create a safe environment for your ingredients.
- When ready to begin cooking, Suvie stops cooling and begins to heat the water surrounding the cooking zones until it reaches the desired temperature and cook time.
- The broiler finishes your vegetables and proteins.
- Your meal is ready to plate and serve.

## How Suvie Calculates Cook Time

### Enter Component Time & Temperature Settings

Loading your meal into Suvie the night before is a great way to save time. For best refrigeration performance, please allow Suvie to rest for at least 2 hours if you have just used your Suvie to cook.

The Time & Temperature chart can also be found online at: [suvie.com/cook-time-temp](http://suvie.com/cook-time-temp)

Cooking frozen proteins? No need to thaw, simply select “frozen” once prompted on the display while setting up your meal. Suvie will automatically adjust the cook settings to account for your frozen proteins. If cooking using the Rapid Cook function, be sure to load only frozen ingredients. Suvie will automatically thaw your food when using this function.

### How Long Will My Meal Take To Cook?

Similar to a standard oven, Suvie requires time to preheat, which can vary from 30-60 minutes. Slow cook meals take between 3-10 hours to complete. Suvie will automatically calculate this pre-heat time. We recommend using the schedule function for maximum convenience.

For more information regarding how Suvie calculates cooking times, please visit: <http://blog.suvie.com/cook-times>

## Your Suvie Pans

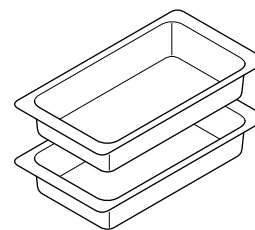

The two Suvie pans included with your appliance can be used interchangeably between both cooking zones. These pans are dishwasher safe.

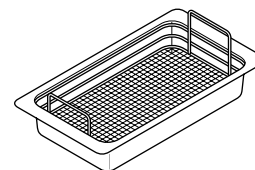

A steam rack is also included with your Suvie appliance and is dishwasher safe.

# How It Works

## Simple Preparation Steps for Multi-Zone Cooking

Your Suvie can make between 1-8+ servings depending on which cook function is used. Please follow the instructions below to begin cooking. Be aware that certain functions are limited in each zone, based on which cooking method is used. Please review the instructions and function chart below.



- Never overfill or use any ingredients that extend beyond the capacity of the pans.

### STEP 1: ONLY FILL THE WATER RESERVOIR WHEN PROMPTED ON DISPLAY

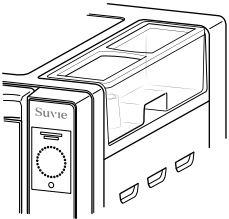

**NOT ALL FUNCTIONS REQUIRE WATER!** Only fill the water reservoir if you are scheduling your meal, or when Suvie prompts you on the display.

Fill the removable reservoir with water to the fill line indicated on the side of the reservoir, approximately 1/4 inch below the top of the reservoir. This water is used for both refrigerating and cooking your meal. Never add water during cooling or cooking.

### STEP 2: CHOOSE YOUR BOTTOM ZONE FUNCTION

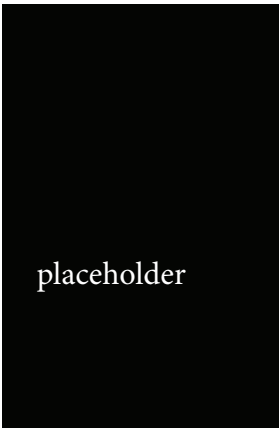

If you are using our Smart Meal service, simply hold the meal card on the Tap Zone above the control knob and your Suvie will automatically set the appropriate cook functions for your meal. Follow the on-screen instructions.

If you are cooking using your own ingredients, next navigate to My Cook and select your desired bottom-zone function from the list of available options. Next, enter the desired cooking times/temperatures. For a list of recommended cook times/temps, please reference the chart on page 28.

### STEP 3: ADD YOUR BOTTOM ZONE INGREDIENTS

Next, add your bottom-zone ingredients.

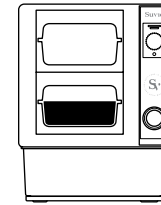

#### Using the Sous Vide Function?

If you are cooking your proteins using the sous vide function, place your vacuum-sealed, pre-seasoned protein into the removable Suvie pan and fill it with water until the protein are submerged. If using a Suvie-provided Smart Meal, these packages are ready out-of-the-box.

#### For All Other Cook Functions:

Remove proteins from packaging before cooking.

A sous-vide compatible bag is any plastic bag that is food safe, rated for high-temp cooking, and can be sealed securely so that the water surrounding it does not touch the protein itself. You may use a vacuum sealer or a store-bought sealable bag.

### STEP 4: CHOOSE YOUR TOP ZONE FUNCTION

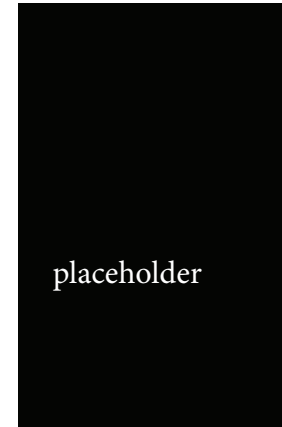

If you are using our Smart Meal service, Suvie will automatically detect the appropriate cooking function after the meal card has been scanned.

If you are cooking using your own ingredients, choose a top-zone cooking function from the list of available options. Please be aware that the top-zone functions available are limited based on the function used in the bottom-zone. For more information on cooking zone combinations please reference page 27.

**STEP 5: ADD YOUR TOP ZONE INGREDIENTS**

Next, add your top-zone ingredients.

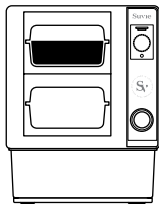
**Using the Sous Vide Function?**

If you are cooking your proteins using the sous vide function, place your vacuum-sealed, pre-seasoned protein into the removable Suvie pan and fill it with water until the protein are submerged. If using a Suvie-provided Smart Meal, these packages are ready out-of-the-box.

**For All Other Cook Functions:**

Remove proteins from packaging before cooking.

A sous-vide compatible bag is any plastic bag that is food safe, rated for high-temp cooking, and can be sealed securely so that the water surrounding it does not touch the protein itself. You may use a vacuum sealer or a store-bought sealable bag.

**STEP 6: (OPTIONAL) CHOOSE YOUR STARCH COOKER FUNCTION**

If you have the Suvie Starch Cooker attachment, choose your starch cook function, enter the desired cooking time, and load your dry starches directly into the starch cooker.

**STEP 7: SCHEDULE YOUR MEAL OR COOK NOW**

Lastly, choose: schedule, refrigerate, or cook now.

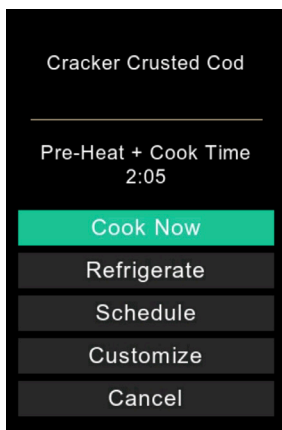
**Schedule:**

This function allows you to enter the time you'd like your meal to be completed. When using the sous vide or slow cook function, Suvie will automatically refrigerate your ingredients until it begins cooking to complete your meal at the time entered. When using either the bake, roast, or broil function, Suvie will continue to refrigerate your meal until you initiate the cooking process.

**Refrigerate:**

This function will refrigerate your ingredients until you initiate the cook process, either on the mobile app or the unit itself.

**Cook Now:**

This function will begin the cooking process right away.

**STEP 8: (OPTIONAL) FINISH BY BROILING**

After your Suvie has finished cooking your meal, you will have the option to broil your proteins and vegetables to achieve a desired finish. Please be aware that due to safety regulations when using the broiler, you must be present to initiate the broil stage. The maximum broil time is 10 mins. If you need additional time, simply start the broil again.

**CAUTION**

- Proteins **MUST** be removed from any plastic packaging before broiling.

## Cooking Zone Function Capabilities

Both the top and bottom cooking zone can perform all cooking functions, however some may not be used in combination with another. Please reference the chart below for zone-function combinations.

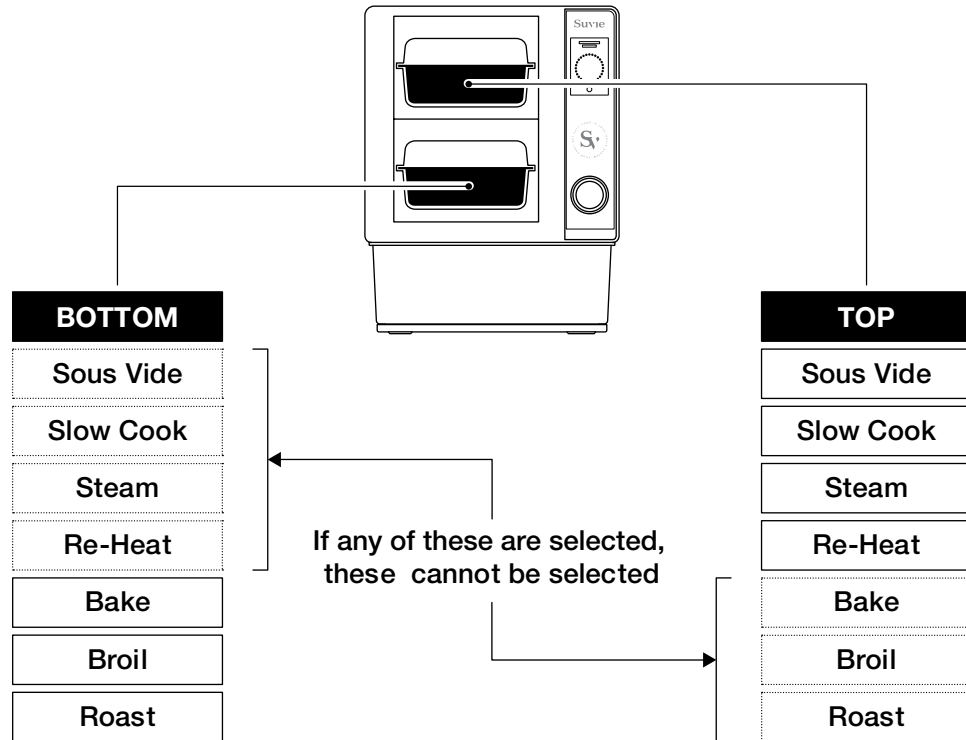

## Sous Vide Time & Temp Chart

Protein Type	Time	Rare	Med	Well
Fish	30 mins	—	130°	135°
Shellfish	30 mins	—	130°	135°
Steak, Lamb, Duck	60 mins	130°	135°	145°
Pork	60 mins	135°	140°	150°
Ground Beef or Pork	60 mins	145°	150°	155°
Chicken Breast	60 mins	—	155°	160°
Chicken Thigh	60 mins	—	160°	165°
Ground Poultry	60 mins	—	165°	170°

*\*Cook for 30 mins, per 1 inch of thickness*

## Vegetable Roasting Recommendations

Vegetable Type	Time
Asparagus	6 mins
Broccoli Florets*	6 mins
Brussel Sprouts*	9 mins
Butternut Squash**	45 mins
Carrots	20 mins
Cauliflower Florets*	8 mins
Green Beans	7 mins
Leafy Greens	5 mins
Shredded/Noodle Cut	4 mins
Summer Squash	9 mins
Sweet Potato**	45 mins

*\* Cut in half*

*\*\* Cut into 1 inch cubes*

### Food Safe Temperature Disclaimer

Consuming raw or undercooked meats, poultry, seafood, shellfish, or eggs may increase your risk of foodborne illness.

## Protein Roasting Chart

Protein Type	Time	Rare	Med	Well
Fish				135°
Shellfish				135°
Steak, Lamb				145°
Pork				150°
Ground Beef				155°
Chicken Breast				160°
Chicken Thigh				165°
Ground Poultry	60 mins	—	165°	170°



*\*Cook for 30 mins, per 1 inch of thickness*

## Cooking Functions

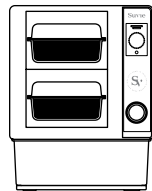

Suvie is capable of performing 11 cooking functions independently and 15 total functions when paired with the optional Suvie Starch Cooker add-on. Please review the details of each function and cooking instructions below:

### Suvie Core Functions:

#### Cool to Cook

Suvie is the only smart countertop appliance that automatically refrigerates then cooks your food.

##### How to Schedule Your Meal:

Please note only certain functions are able to be scheduled in advance. Those functions where cool-to-cook is allowed will be indicated below.

Simply fill the water reservoir when prompted, then select “schedule” after loading your ingredients.

##### Technical Specifications:

Temp Range: 37°F - 210°F  
 Time Range: 4 hours - 24 hours  
 Cold Source: Compressor  
 Heat Source: Bottom Heaters

### Cool-to-Cook Refrigerating vs Scheduling when Using Bake, Roast, Broil, and Rapid Cook Functions:

Suvie uses a powerful quartz broiler when the Roast, Bake, Broil and Rapid Cook functions are used. Due to these high temperatures, and for your safety, you must be present during these phases of cooking.

When using these functions, Suvie can still refrigerate your meal, however, you must manually start the cooking process by clicking the start button on the display. Because of this requirement, you cannot schedule meals to begin cooking automatically.

### Frozen to Cook

Go from frozen to fully cooked in as little as 25 minutes with fast cooking speeds and a radiating heat element.

##### How to Cook from Frozen:

Simply scan the meal card from one of our Rapid Cook Smart Meals.

If using your own ingredients, select the “from frozen” setting when prompted on the display.

##### Technical Specifications:

Temp Range: 37°F - 210°F  
 Time Range: 20 minutes - 24 hours  
 Cold Source: Compressor  
 Heat Source: Bottom Heaters + Broiling Elements

## Sous Vide

Water-based cooking for perfect proteins cooked at a low temperature for a long duration of time.

### How to Sous Vide:

1. When using the sous vide function, ingredients **MUST** be vacuum-sealed.
2. Cover ingredients with water. Suvie will **not** automatically fill the Suvie pan.
3. Fill the water reservoir with water to the fill line indicated.
4. Select the sous vide function and enter your desired cooking time & temperature settings.

Please refer to the time & temperature chart located on page 28

#### Technical Specifications:

Temp Range: 125°F - 180°F

Time Range: 30 min - 4 hours

Heat Source: Bottom Heaters + Water Circulation



Scheduling Allowed



Requires Water

## Slow Cook

Low, slow, and hands-off cooking for soups, stews, and short ribs.

### How to Slow Cook:

1. Remove ingredients from packaging and place in Suvie pan.
2. Fill the water reservoir with water to the fill line indicated.
3. Select the slow cook function and enter your desired HIGH (205°F) or LOW (185°F) temperature and cook time settings (up to 12 hours).

#### Technical Specifications:

Temp Range: 185°F - 205°F

Time Range: 30 min - 12 hours

Heat Source: Bottom Heaters + Water Circulation



Scheduling Allowed



Requires Water

## Roast

High temp roasting is ideal for crispy vegetables and perfect meats, fish and other proteins.

### How to Roast:

1. Remove ingredients from packaging and place in Suvie pan.
2. Select the roast function and enter your desired roasting temperature and cook time
3. Please refer to the FDA safe cooking temperatures on page 29.

#### Technical Specifications:

Temp Range: 350°F - 450°F

Time Range: 1 min - 1 hour

Heat Source: Broiling Elements + Bottom Heaters

## Bake

Uses more even heat for cakes and gentler cooking, perfect for your favorite desserts.

### How to Bake:

1. Remove ingredients from packaging and place in Suvie pan.
2. Select the bake function and enter your desired baking temperature and cook time
3. Please refer to the FDA safe cooking temperatures on page 29.

#### Technical Specifications:

Temp Range: 250°F - 350°F

Time Range: 1 min - 1 hour

Heat Source: Broiling Elements + Bottom Heaters

## Broil

Crisping function adds a gorgeous finish to your meal using the top broiler heating elements.

### How to Broil:

1. Remove ingredients from packaging and place in Suvie pan.
2. Select the broil function and enter your desired broil time.
3. Please refer to the FDA safe cooking temperatures on page 28.

**TIP:** For best results, pat protein dry with a paper towel before broiling. When broiling vegetables, strain out excess water from the pan and drizzle olive oil on top.

### Technical Specifications:

Temp Range: 480°F+

Time Range: 1 min - 1 hour

Heat Source: Broiling Elements

## Warm & Reheat

Suvie uses it's gentle pan heaters to reheat your food and hold it at a temperature of up to 140F for up to 4 hours.

### How to Warm & Reheat:

1. Remove ingredients from packaging and place in Suvie pan.
2. Fill the water reservoir with water to the fill line indicated.
3. Select the reheat function and enter your desired reheat time

### Technical Specifications:

Temp Range: 200°F

Time Range: 1 min - 4 hours

Heat Source: Bottom Heaters



Scheduling Allowed



Requires Water

## Steam

Gently cook fish, prepare veggies without oil, or steam dumplings.

### How to Steam:

1. Insert steam rack into Suvie pan.
2. Remove ingredients from packaging and place them in Suvie pan.
3. Add ½ cup of water in each Suvie pan to be steamed
4. Select the steam function and enter your desired steam time.

Please refer to the steam time & temperature chart located on page 28

**TIP:** For best results, cut up vegetables to be steamed into 1" pieces.

### Technical Specifications:

Temp Range: 150°F - 200°F (steam)

Time Range: 1 min - 1 hour

Heat Source: Bottom Heaters



Scheduling Allowed



Requires Water



## Egg Mode

With the optional egg tray, cook your most creative egg breakfast options.

### How to Cook Eggs:

1. Insert the egg tray directly into a Suvie pan.
2. Crack open eggs and place into the egg tray.
3. Fill the pan with water surrounding the egg tray before placing it into Suvie.
4. Fill the water reservoir with water to the fill line indicated.
5. Select the egg cooker function and enter your desired cook time.

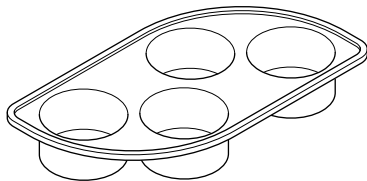

### Technical Specifications:

Temp Range: 150°F - 200°F

Time Range: 1 min - 4 hours

Heat Source: Bottom Heaters



Scheduling Allowed



Requires Water

## Cooking from Frozen?

No need to thaw your ingredients prior to loading. When prompted on the display, simply select 'yes' when Suvie asks if you are cooking frozen ingredients.

Suvie will then automatically defrost and will adjust the cook settings as required.

## Cook Settings for Suvie Smart Meals

Every Suvie Smart Meal comes in Suvie smart packaging that tells your Suvie appliance how, when, and for how long to cook the meal.

### The Tap Zone

Your meal card contains a NFC chip allowing Suvie to easily auto-detect each recipe and cooking instructions. Simply hold the logo on the meal card to the logo on the Suvie, located above the control dial. Once successful, you will hear a beep sound, and the display will indicate the recipe selected.

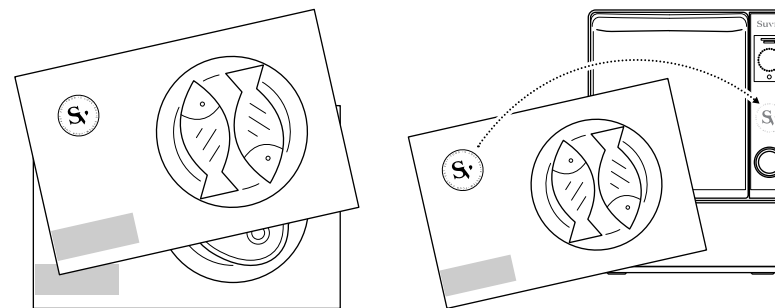

## Safe Packaging with Suvie Smart Meals

With Suvie Smart Meals, all component packaging is safe for food preparation and cooking.

**STEP 1:** Locate the meal card provided and follow the simple loading instructions.

**STEP 2:** Hold the meal card directly on the Tap Zone to load the recipe onto your Suvie. When successful, you will hear a beep and see the recipe name appear on the display.

### Easily Adjust Cook Times To Your Preferences

With our Suvie Smart Meals, you can always customize the cook settings for each of your meal components. To do so, after scanning the meal card, simply click the "Customize" button. Next, you may adjust the times and temperatures for your desired doneness.

For example, when cooking using the sous vide function, if you prefer your steak to be cooked well done, adjust the protein temperature to 145 °F.

Cooking from Frozen? Simply click the “from frozen” option when prompted, no thawing required.

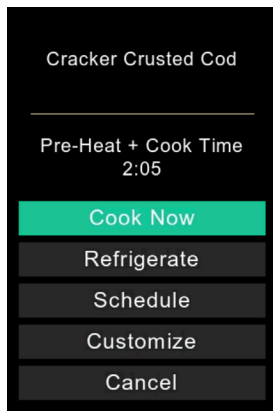

**IMPORTANT:** If you are cooking a different vegetable than what is listed on the meal card, you must scan the card first; then you may enter the appropriate vegetable cook time for what you are using.

For more information on time/temp settings, please see the Quick Reference Card or visit: <http://blog.suvie.com/cook-times>

**STEP 3:** When prompted, fill the water reservoir to the fill line indicated.

**STEP 4:** Select Cook Now to begin cooking right away, or schedule it to finish at a later time.

**TIP:** If cooking your meal right away, Suvie may require an additional pre-heat time depending on the recipe.

**STEP 5:** Once your meal finishes cooking, you may choose to broil it for added quality and appearance.

**IMPORTANT:** Be sure to remove proteins from their packaging before broiling.

## Modifying Cook Settings or Cancelling Your Meal

### Easily Make Changes to Your Meal or Cancel It Entirely

After your Suvie begins cooking, you can adjust the cook settings within 10 mins of starting the cook. If your Suvie is still refrigerating, you can adjust the settings anytime. To make changes, turn the control dial and select the “Modify” button, then make your changes and select “Update”.

You can also cancel a cook after it has started by using the control dial to scroll to and select the “End Cook” button.

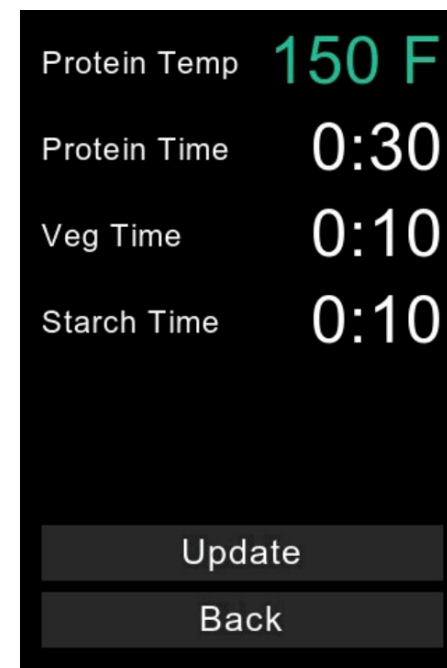
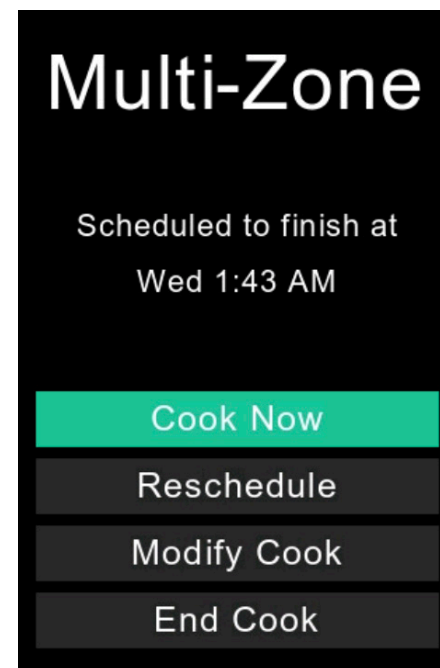

## Scheduling Suvie From Your Phone

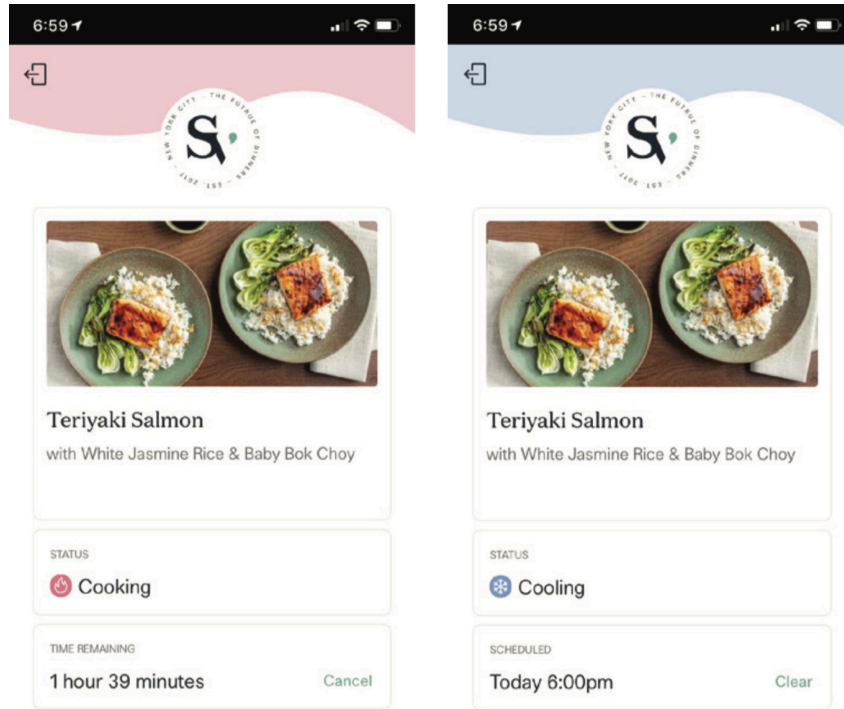

You control scheduling with the Suvie mobile app anytime and from anywhere throughout your day.

With the app, you'll always know what is cooling or cooking, and you can update the time you want to eat right up to the moment Suvie starts to cook.

Visit [www.suvie.com/app](http://www.suvie.com/app) for links to download your iOS or Google Play app today.

## Suvie Automatically Updates the Mobile App

Whether you are using Suvie Smart Meals or your own ingredients and recipes, Suvie relays the programming information to your Suvie mobile app for easy remote control by phone or tablet — you can easily specify the meal completion time you want, and Suvie will take care of the rest.

## When Dinner Will Finish

If your plans change and your arrival time will be later than the already set meal completion time, it's easy to make a change in the Suvie mobile app. If the meal is already cooked, simply tell Suvie to keep your meal warm until you arrive.

## Monitor the Status of Your Suvie

The mobile app always informs you on the progress of your meal. You can see if the food has begun cooking, the time remaining, and know exactly the moment it's ready.

## When Cooking Is Complete

When cooking is complete, the Control Panel will read “Done” and it will provide timing information for your Broil, if you wish to use this feature.

### ⚠ CAUTION

- Do NOT open the Suvie door until the display indicates that cooking is done. The interior of Suvie will be extremely hot and steam will be in use.

### ⚠ CAUTION

- The pans will be extremely hot when cooking is complete. Be sure to always use oven mitts.

## Suvie Control Panel and Features

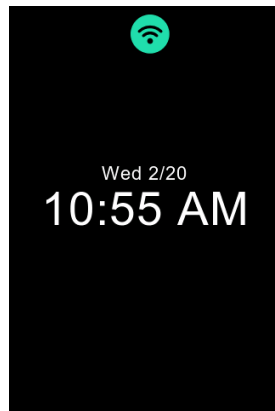

This is the standby screen with the current date and time. The appliance's Wi-Fi connection is also indicated here.

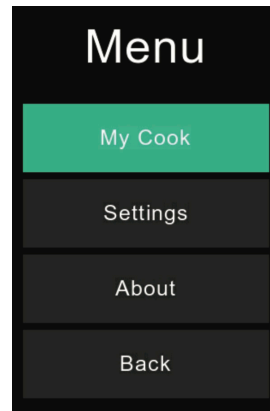

Rotate the dial to move among menu items, then press the dial to make your selection.

## Multi-Zone

Pre-Heat + Cook Time  
2:01

Cook Now

Refrigerate

Schedule

Customize

Cancel

After putting your ingredients into your Suvie for a standard My Cook cycle (rather than a Slow Cook cycle), the screen will present the options for setting the temperature in each zone.

After setting the zone temperatures, select one of the following: Cook Now, Refrigerate, Schedule, or Cancel.

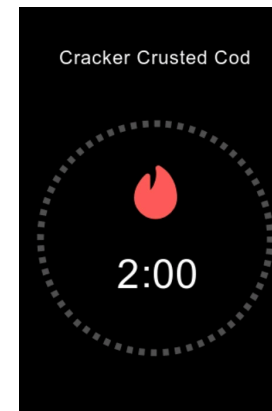

When using Suvie Smart Meals and the Tap Zone, your Suvie automatically detects the recipe.

When your cook cycle is complete, the screen will indicate the recommended amount of time for broiling. You may choose to start the broil or skip this step.

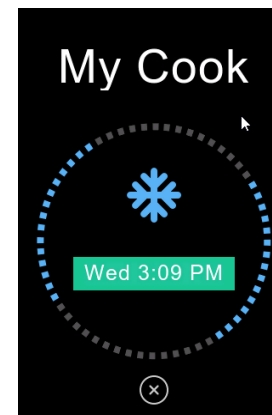

If you are using your own ingredients and recipes, the screen indicates the total time remaining until cooking is complete.

In this figure, the blue snowflake icon indicates that your Suvie is in Refrigerate mode.

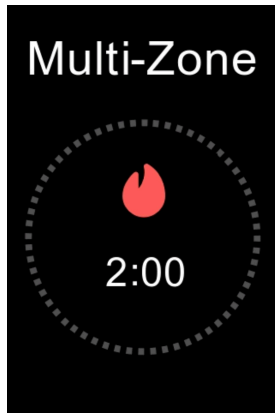

A red flame icon indicates that cooking is taking place.

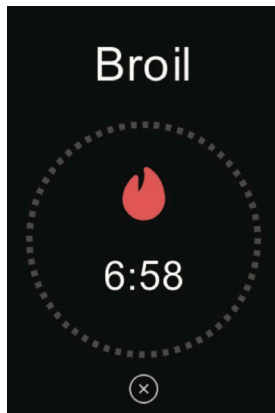

If you choose to broil, the screen will indicate the time remaining with the cook symbol. To cancel while broiling, simply click the control knob.

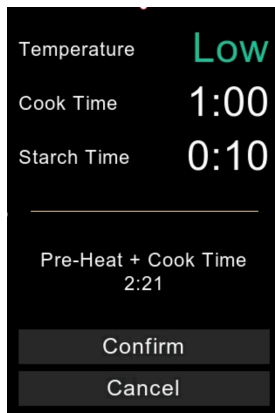

When using the Slow Cook function, choose either Low (195 °F) or High (205 °F) temperature setting; then enter your desired cooking time in increments of 15 mins.

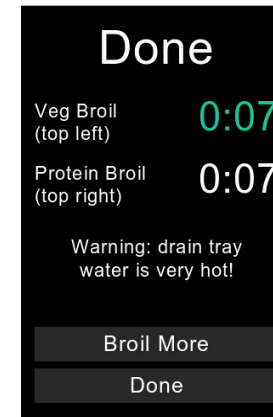

When your broiling step is complete, the screen will indicate that, and if you'd like more browning, you can either broil again if needed or select Done to finish.



Before you begin your cook, Suvie will detect if enough water has been added to the reservoir. If more water is needed, the screen will prompt you to add more. Suvie will automatically start when the appropriate amount of water has been added.

## Cleanup and Maintenance

Since Suvie uses steam while cooking, this process helps to keep your appliance clean.

To spot-clean Suvie, use a damp, non-abrasive cloth or sponge. Every time you use your appliance, Suvie automatically steams the broiler lines inside to clean them out. We recommend running a quick rinse cycle weekly. To do so, go to Settings > Rinse > Quick Rinse and follow the on-screen instructions.

### **⚠ WARNING**

- Only clean your Suvie after it has cooled down.
- Never spray cleaning products directly on or in the appliance.
- Do not use alkaline-based cleaners like bleach.

**⚠ CAUTION**

- Before and after a cook, be sure to clean off any food on the broiler element.
- Before and after a cook, make sure that the heater pad below the starch pan is always clean.

## Expand Your Meal With the Suvie Starch Cooker

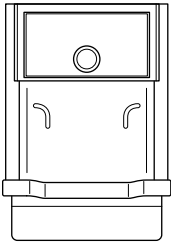

Unlock even more cooking functions with the Suvie Starch Cooker. When paired with Suvie, you can now cook a complete meal, including starches, all on your schedule.

- Pasta Cooker
- Perfect Rice
- Healthy Grains

To order, please visit: [store.suvie.com](https://store.suvie.com)

### Suvie Starch Cooker Expanded Functions:

The following functions are enabled when you pair your Suvie with the optional Starch Cooker add-on.

#### Rice

Want perfect rice with your dinner? Just pour white rice, brown rice, short or long grain into the included Rice Pot. No more pans of impossible to clean burnt on rice. Suvie Starch Cooker automatically adds water to your rice and gently cooks it to perfection. Whether you're using brown, wild, jasmine, or sushi rice Suvie can cook them all. The Starch Cooker can coordinate with your Suvie 2.0 to make sure your rice is cooked right on time for your meal.

#### Pasta

Want perfect al dente pasta with your meal? Using Suvie's patent technology, the Starch Cooker will automatically pre-heat, fill, cook and drain your pasta to al dente perfection. If you're scheduling a meal in advance the Starch Cooker keeps your pasta dry until it's time to start cooking and automatically adds the correct amount of water to cook.

#### Healthy Grains

Easily prepare healthy ancient grains that have longer cooking times. Cook gluten-free grains like quinoa, millet, and buckwheat, or whole grains like farro and barley.

## Descal Your Suvie as a placeholder

### Keep Your Suvie Looking Brand New

Household tap water contains minerals that are naturally occurring, the amount depends on where you live and it ultimately affects whether your water is "hard" or not. All appliances that use heated water -- including Suvie's reservoir -- can see buildup of these minerals over time.

Running a cleaning process to remove these minerals is called "descaling," and you can descale your Suvie just like you descale a coffee or espresso maker. We suggest using a simple citric acid solution which is a very common food additive typically used to make things sour or taste like lemon. Citric acid can be purchased at most grocery stores or online in powder form. If you follow our two-step descaling process on the following pages, it will not impact your machine performance or the taste of your food.

### Descaling Your Machine

You Will Need:

- 1 Tablespoon (12 grams) of powdered, food grade citric acid
- Suvie Starch Pan
- Drain Tray

Instructions:

1. Place only the Starch Pan in the lower right slot of your Suvie (leave the other pans out of the appliance), and insert the drain tray.
2. Go to Settings > Rinse > Descal and follow the on-screen instructions
3. Place 1 Tbsp (12 g.) of citric acid in powdered form into the water reservoir
4. Fill the water reservoir with water until the fill line indicated. Your Suvie will begin the first of four rinse cycles automatically.
5. Suvie will guide you through a series of 4 rinsing steps. Please fill the reservoir or empty the drain tray/ starch pan as instructed on screen.
6. Descal complete. You can now continue cooking with your Suvie.

Rinse

Descal

Purge

Quick Rinse

Back

## Cleaning Your Reservoir

With regular use, it's important to keep your water reservoir clean. If you notice that your appliance's reservoir has mineral scale (similar to a white powder), you can clean it safely with a citric acid solution. Follow the instructions below to descale your water reservoir.

### You Will Need:

- 12 grams (or approximately 1 tablespoon) of food grade citric acid
- Paper towels or a clean, dry cloth
- (Optional) Chopstick or dowel, or a brush

### Instructions:

1. Fill your reservoir halfway with water, mix in 1 tablespoon (12 grams) of citric acid until it is dissolved; then fill the rest of your reservoir to as close to the top as possible. Pour half of the citric acid into the fill tube and half outside the fill tube.
2. Place your reservoir in your sink and allow it to sit for 30 minutes. This will allow the citric acid to break down the scale layer.
3. After 30 minutes, discard the water, and wipe the insides of the reservoir with a damp paper towel. If the layer of powder does not come off with light scrubbing, you may need to repeat the above steps with more citric acid and more soaking.
4. To clean the fill tube, you can use a bottle brush. If you do not have a bottle brush, we suggest wrapping a paper towel around a chopstick or dowel, and using that to push the paper towel into the fill tube. Make sure you do not push it in all the way and that you are able to pull it out. Keep doing this until the fill tube is clean.

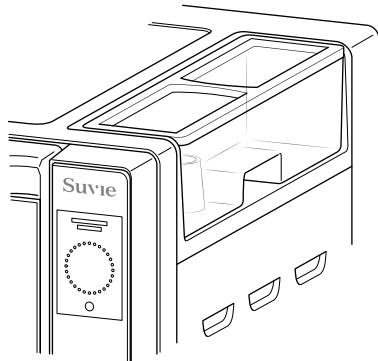

## Troubleshooting as a placeholder

### **When attempting to connect to WiFi, the screen is stuck on 'initializing Wi-Fi' what should I do?**

Please unplug your Suvie, wait 15 seconds, then re-plug the appliance and try again. If this does not resolve the issue, perform a factory reset by going to Settings > System > Factory Reset. Please contact Suvie Support at [help@suvie.com](mailto:help@suvie.com) for further assistance.

### **Suvie can't find my WiFi network (5 GHz network).**

If your Suvie cannot find your WiFi network, please try clicking the reload button to refresh the list. If your network is still not listed, next please unplug your Suvie, wait 15 seconds, then re-plug the appliance and try again. If you are using a 5 GHz network, your Suvie will not be able to locate this network. We recommend connecting to a 2.4 GHz network.

### **I am located 5,000 ft+ above sea level, how do I turn on high-altitude mode?**

To enable high-altitude mode go to: Settings > System. Next, check the box labeled "high altitude mode" then click Save.

### **Suvie is making loud popping or gurgling noises.**

Popping or gurgling noises coming from your Suvie are very normal and are nothing to be concerned about. As Suvie cooks your food using water in different states, occasionally boiling water and steam may cause these noises to occur. If you have any questions about the noises coming from your Suvie, please contact Suvie support.

### **Suvie is loud when refrigerating.**

As Suvie contains a compressor used for refrigerating, the appliance does make some noise during this stage, and this is normal. Be sure to follow the countertop placement guidelines for best noise optimization.

### **Proteins have a white substance on them after a cook has finished.**

You may find a white, egg-like substance on your proteins after you cook them using the sous vide function. This is a perfectly safe, water soluble protein called albumin that's effectively the same protein that makes egg whites. When cooking protein in a traditional pan, this substance falls off more easily than it does when cooking using the sous vide method. You can wipe off this substance and then finish the protein by broiling it in Suvie for enhanced taste and appearance.

### **My vegetables did not brown after the broil finished.**

To enhance browning on your vegetables, we recommend first removing excess water and patting them dry. Next, add a drizzle of olive oil, salt, and pepper before broiling. Be sure to mix your veggies so the oil is evenly coated.



**My Smart Meal card will not scan / receiving an error message.**

For Suvie to recognize the Smart Meal tag, Suvie needs to be connected to WiFi to download recipes. For best results, please hold the meal card directly on the tap zone, and wait a moment until you hear a beep. If you are receiving an error message, or no message at all, first make sure your Suvie is connected to WiFi, then restart your Suvie. This will allow your Suvie to download the latest recipe update.

If your meal card is still not scanning, we recommend performing a factory reset. To do this, please go to Settings > System > Factory Reset. Please contact Suvie support if the problem continues: [help@suvie.com](mailto:help@suvie.com)

**My cook did not finish on time / my cook finished late.**

We're sorry to hear that your meal did not finish on time; predicting the cooking time is often a complicated matter, and we are consistently working to improve this. Some fluctuation in cook time is expected, however, if your meal is 15 mins late or earlier than you have scheduled, please contact Suvie Support at [help@suvie.com](mailto:help@suvie.com) to investigate this issue further.

**I have a question or an issue that is not listed here.**

You can view additional articles by visiting our support website at [support.suvie.com](http://support.suvie.com) or simply contact our customer success team at [help@suvie.com](mailto:help@suvie.com).

**My Suvie has indicated there is an issue with refrigeration. What should I do now?**

Safety is our top priority and Suvie is continually monitoring the cooling performance of your appliance.

If Suvie detects there is an issue with the refrigeration system, an alert will be displayed informing you of the problem. Please email [help@suvie.com](mailto:help@suvie.com) as soon as possible and our support team will be happy to assist.

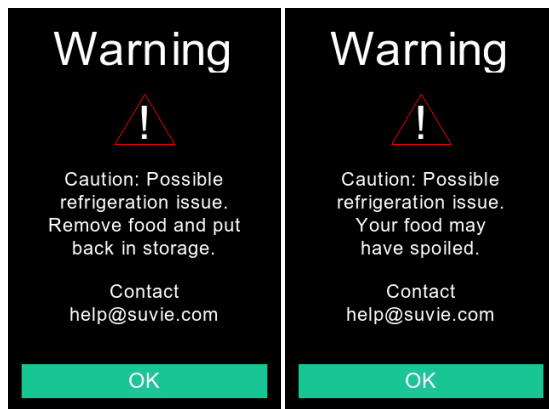

# Service and Support

For the latest information on troubleshooting, recipe suggestions, and all things related to using your Suvie, visit: [support.suvie.com](http://support.suvie.com) or contact our customer support team via email: [help@suvie.com](mailto:help@suvie.com)



