





Over-the-Air (OTA) Test Report

Engineering Test Report	2402531-01
DUT Name	Quarter-wave Monopole Antenna
DUT Type	Antenna and PCB
Manufacturer Name	Multitech
Manufacturer Address	2205 Woodale Drive, Mounds View, MN 55112
Requested By	Jason Panjikaran
PO Number	11231
Test Dates	10/28/2024
Test Facility	Elite Electronic Engineering, Inc. 1516 Centre Circle Downers Grove, IL 60515
Signature	
Tested by	John Peters Senior Wireless Test Engineer
Signature	
Approved by	Raymond J. Klouda, Registered Professional Engineer of Illinois – 44894

This report is for your exclusive use. Any copying or replication of this report to or for any other person or entity, or use of our name or trademark, is permitted only with our prior written permission. This report sets forth our findings solely with respect to the test samples identified herein. The results set forth in this report are not indicative or representative of the quality or characteristics of the lot from which a test sample was taken or any similar or identical product unless specifically and expressly noted. Our report includes all of the tests requested by you and the results thereof based upon the information that you provided to us. You have 60 days from date of issuance of this report to notify us of any material error or omission caused by our negligence, provided, however, that such notice shall be in writing and shall specifically address the issue you wish to raise. A failure to raise such issue within the prescribed time shall constitute your unqualified acceptance of the completeness of this report, the tests conducted and the correctness of the report contents.

This report shall not be reproduced, except in full, without the written approval of Elite Electronic Engineering Inc.

Elite Electronic Engineering Incorporated certifies that the information contained in this report was obtained under conditions which meet or exceed those specified in the test specification(s). The data presented in this test report pertains to the DUT on the test date(s) specified. Any electrical or mechanical modifications made to the DUT subsequent to the specified test date will serve to invalidate the data and void this certification.



1. REPORT REVISION HISTORY

Revision	Date	Description
-	01/01/2024	Initial release

2. TABLE OF CONTENTS

TABLE OF CONTENTS

DESCRIPTION OF CONTENTS	PAGE NO.
1. REPORT REVISION HISTORY	2
2. TABLE OF CONTENTS	3
3. DESCRIPTION OF DEVICE UNDER TEST (DUT)	4
3.1. PRODUCT DESCRIPTION	4
3.2. DUT SETUP PHOTOGRAPHS	7
4. LIST OF TEST EQUIPMENT:	9
5. MEASUREMENT UNCERTAINTY BUDGET:.....	9
6. TEST METHOD.....	10
6.1. PASSIVE ANTENNA PATTERN TESTS USING VECTOR NETWORK ANALYZER (VNA)	10
7. SUMMARY OF TEST RESULTS	11
7.1. ENVIRONMENTAL CONDITIONS:.....	11
7.2. RETURN LOSS	11
7.3. MEASUREMENT RESULTS	12
8. ANTENNA PLOTS.....	13
8.1. 2D MAIN CUTS	14
8.2. 3D PLOTS	16

3. DESCRIPTION OF DEVICE UNDER TEST (DUT)

3.1. PRODUCT DESCRIPTION

Product Description		
DUT Description	Antenna soldered to PCB containing backplane	
Antenna Description	1/4 wave monopole antenna, Part# ANT-B001-0001F-001	
Measurements Notes	Insertion Loss of approximately 100mm RG178 feed cable was accounted for in this measurement. Calculated insertion loss table below.	
DUT Quantity	1	
DUT Dimensions	Approximately 33mm long, 2mm dia.	
Mechanical Mode	Freespace, Normal operation is PCB horizontal orientation	
Frequency Evaluation Span	2400-2500MHz	
Input Power	Internal	N/A
	External	N/A

COAXIAL CABLE LOSSES (calculated)

Frequency (GHz)	RG178 Coaxial Pathloss (dB/100m)	Frequency (GHz)	RG178 Coaxial Pathloss (dB/.1m)
0.1	45.31	2.402	0.2
0.4	91.21	2.44	0.2
1	145.7	2.48	0.2
3	257.22		



DUT

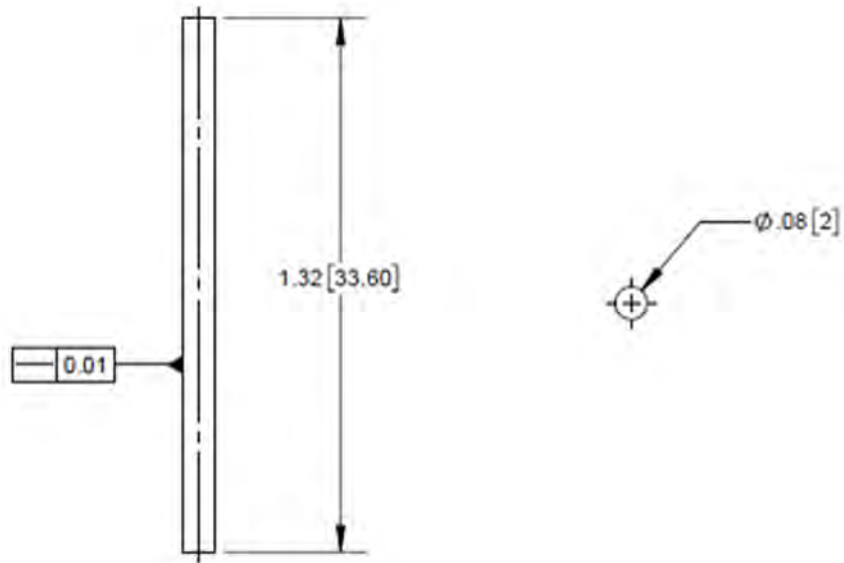

DUT (Dimensions)

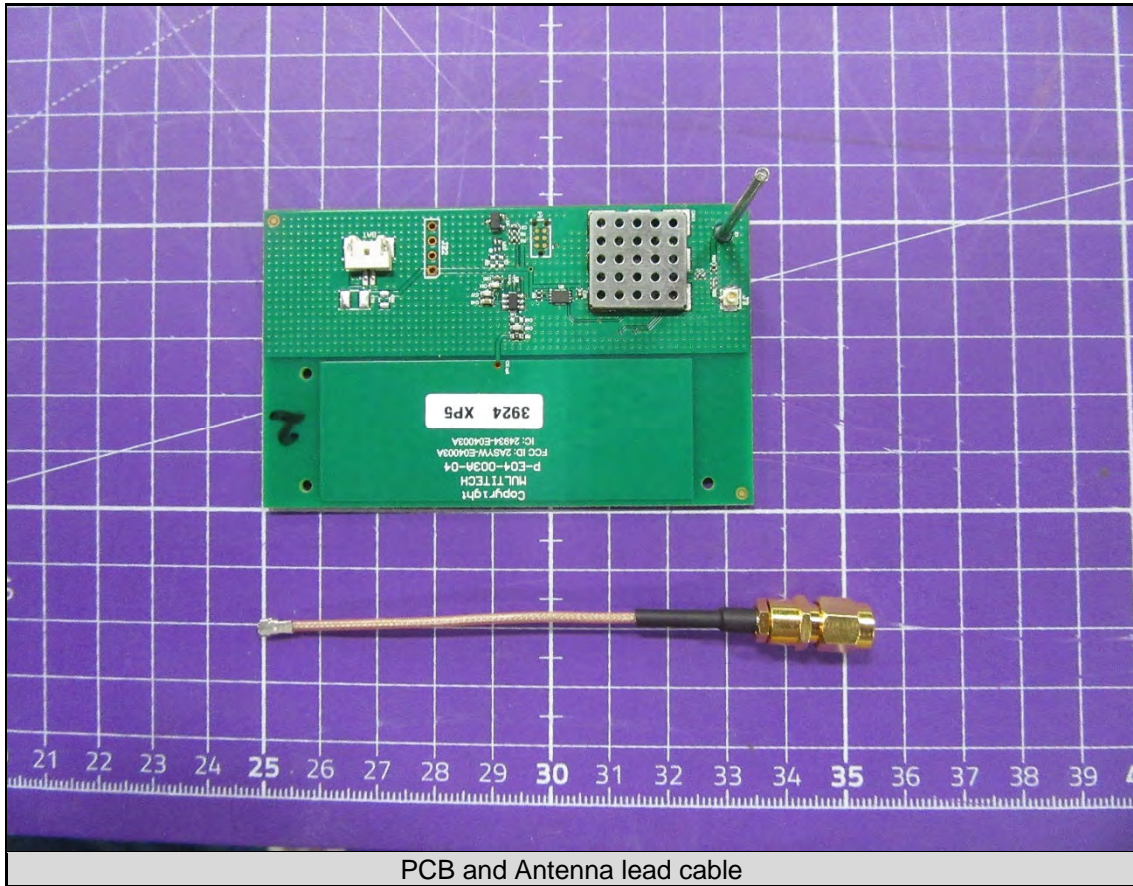

PCB and Antenna lead cable

3.2. DUT SETUP PHOTOGRAPHS

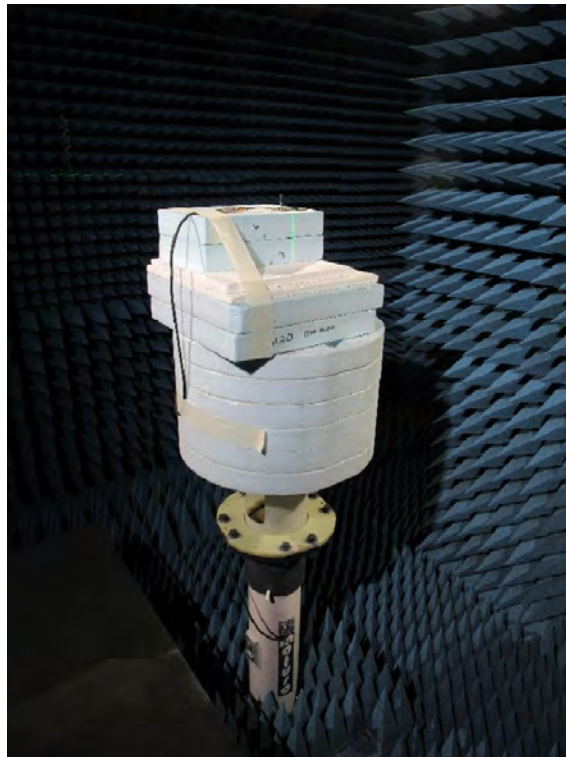

DUT Support

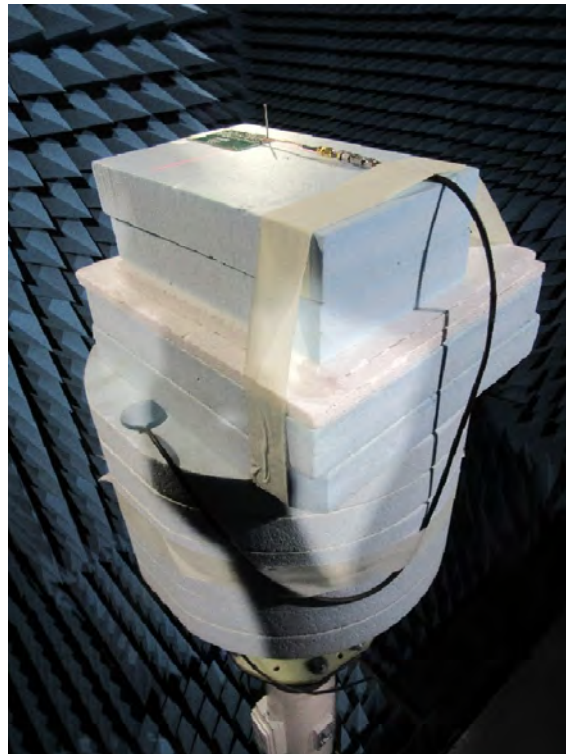

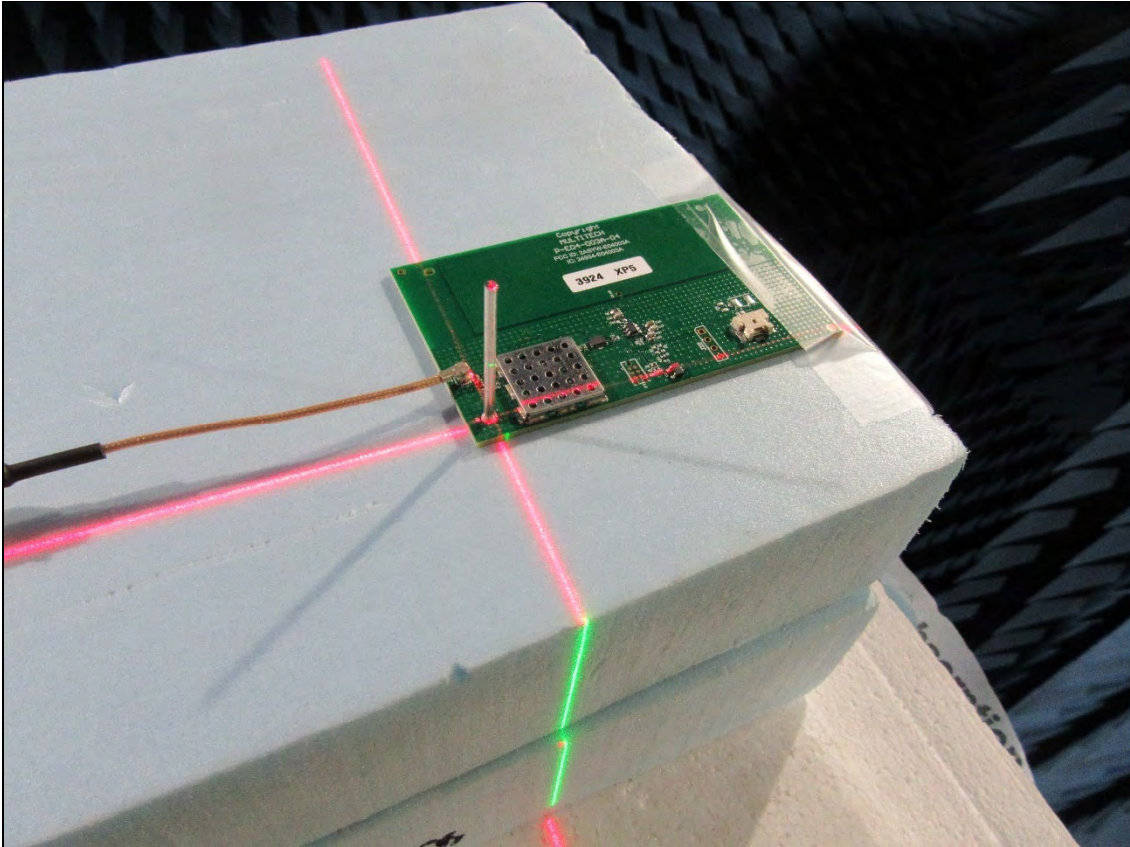

DUT Laser Alignment

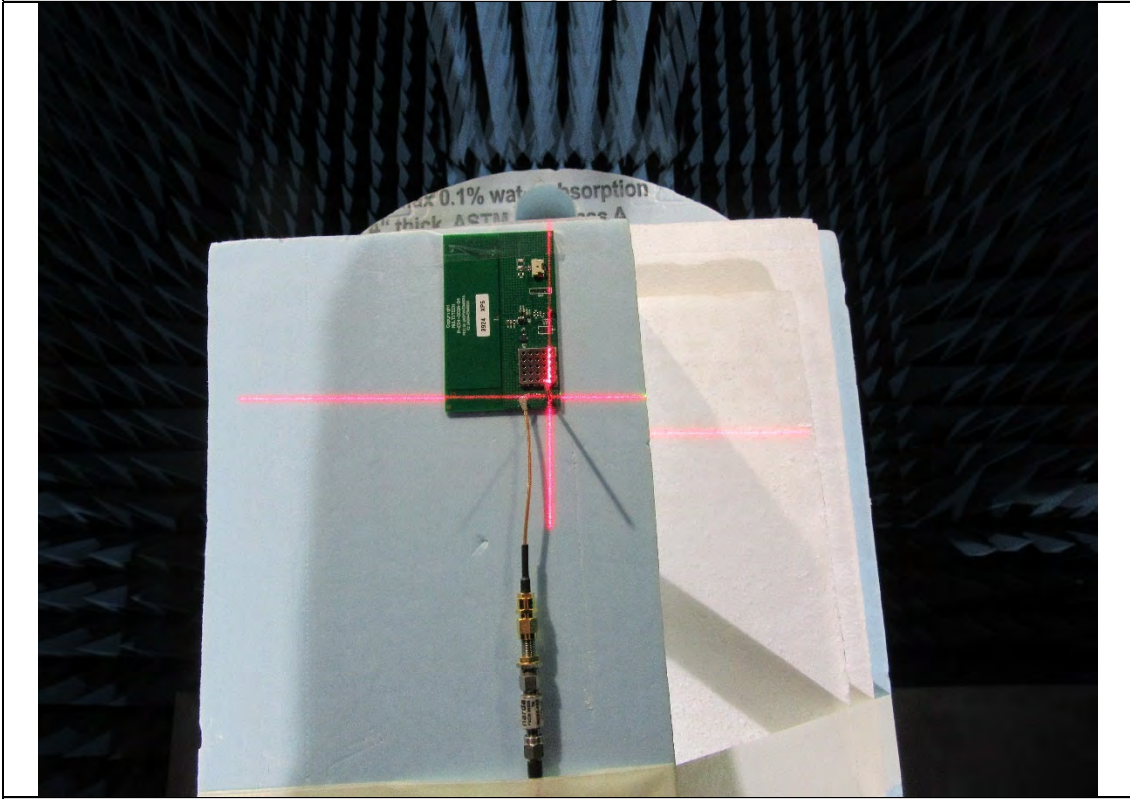

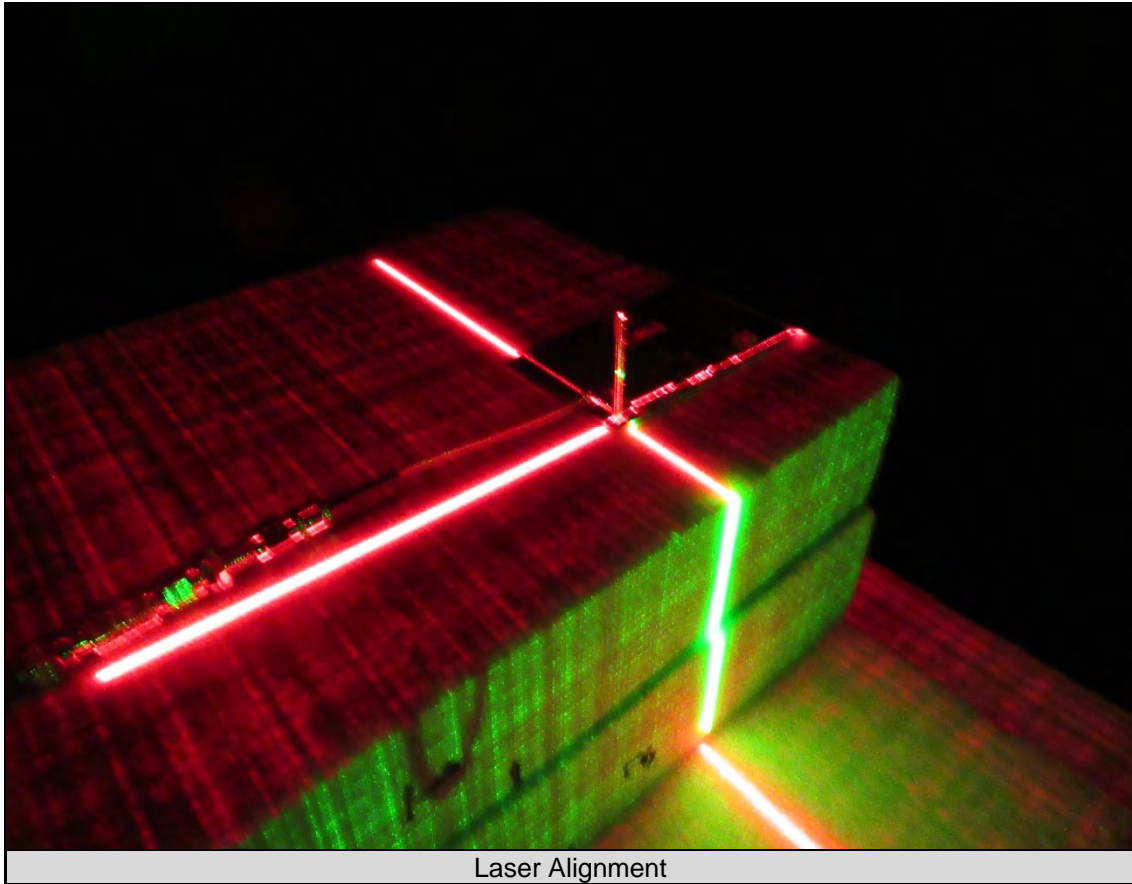

4. LIST OF TEST EQUIPMENT:

Equipment Description	Manufacturer	Model No.	Serial No.	Cal Date	Due Date
VECTOR NETWORK ANALYZER	Rohde & Schwarz	ZND	101137	5/8/2024	5/8/2025
RF SWITCH BOX	Rohde & Schwarz	OSP130	101195	Included in range calibration	
RF SWITCH BOX	Rohde & Schwarz	OSP150	101024		

5. MEASUREMENT UNCERTAINTY BUDGET:

Measurement Uncertainty (k=2, 95% Confidence Interval)											
Frequency (MHz)	617-698	699-798	814-894	1574-1606	1695-1780	1850-2020	2110-2180	2300-2800	3300-3800	2400-2500	5150-5825
FREE SPACE (50cm) Passive (dB)	1.36	1.36	1.36	1.36	1.36	1.36	1.36	1.36	1.36	1.36	1.36

6. TEST METHOD

6.1. PASSIVE ANTENNA PATTERN TESTS USING VECTOR NETWORK ANALYZER (VNA)

The radiation pattern was measured with a VNA every 15 degrees in azimuth (0 - 360°) and every 15 degrees in elevation (0 - 165°) using dual-linear polarized test antenna to capture two principal polarizations, Theta (vertical), and Phi (horizontal).

Measuring with a VNA allows the radiation pattern to be tested sweeping multiple frequencies at each test coordinate/polarization so multiple test frequency patterns can be generated from one antenna scan. The DUT is driven through VNA (Port 1). Port 1 is connected to an RF cable that is run through a bulkhead in the chamber shielding, to the chamber turntable, through a RF rotary joint, and through a RF cable that terminates with a 10dB attenuator (used to help with standing wave effects in the cables). The measurement port (Port 2) of the VNA is connected to the dual-linear polarized probe antenna.

Antenna patterns are found in Section 8. The antenna pattern was characterized with a R&S ZND8 Vector Network Analyzer.

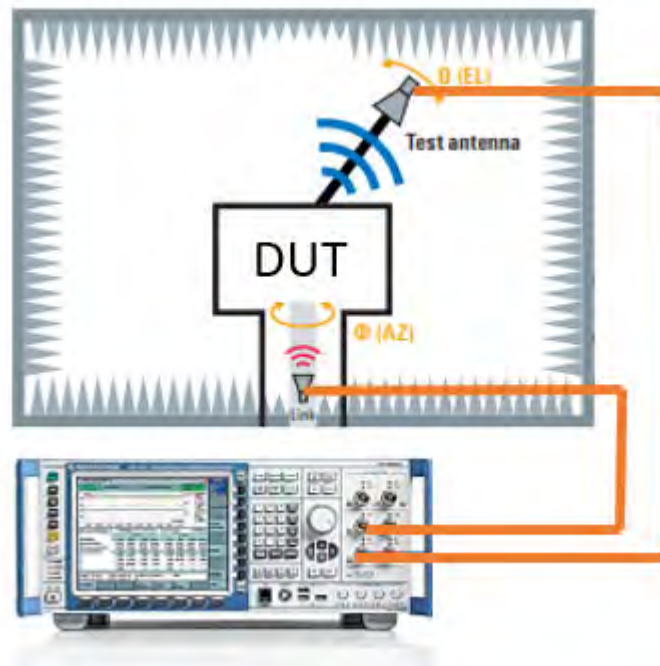

7. SUMMARY OF TEST RESULTS

7.1. ENVIRONMENTAL CONDITIONS:

The temperature at the time of the test was 23°C and the relative humidity was 32%.

7.2. RETURN LOSS

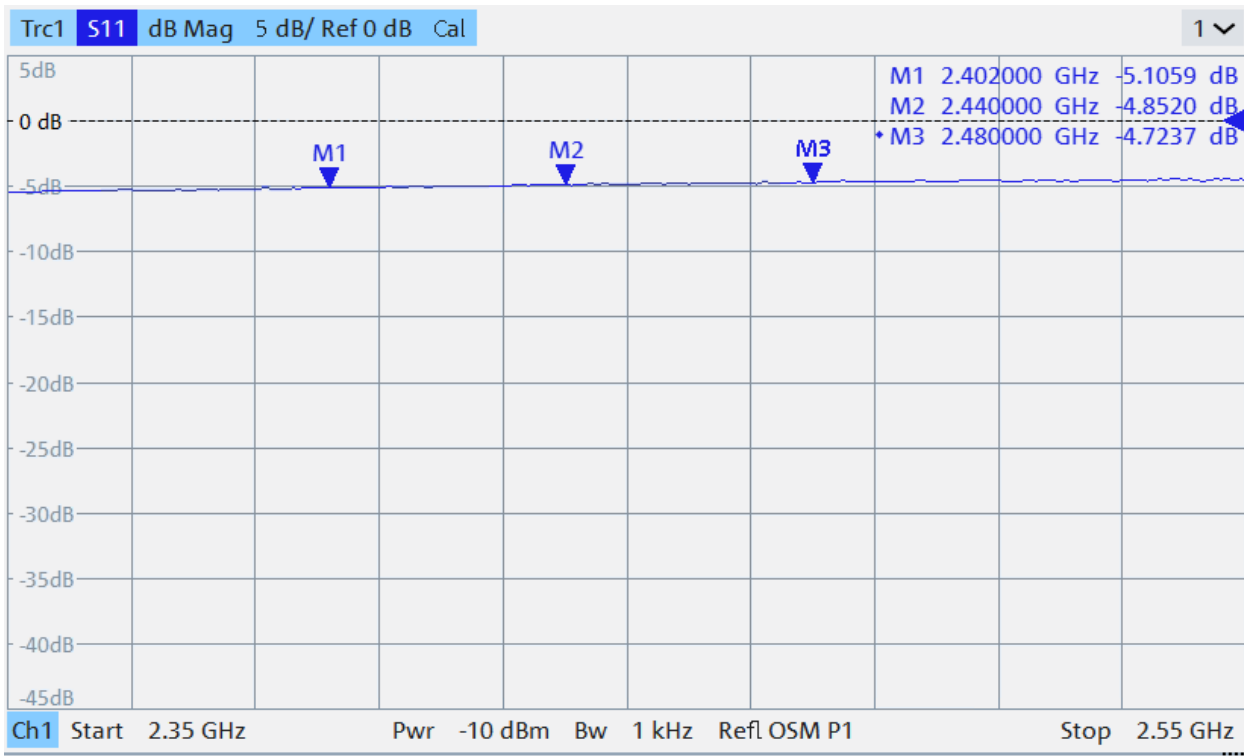

7.3. MEASUREMENT RESULTS

Frequency (MHz)	Gain	Directivity	Total Radiated Power	Total Efficiency
	(dBi)	(dBi)	(dBm)	(%)
2402MHz	1.37	4.37	-3.00	50.08
2440MHz	1.44	4.45	-3.01	49.98
2480MHz	1.45	4.70	-3.25	47.31

EXPANDED TABLE												
Frequency (MHz)	2400	2402	2410	2420	2430	2440	2450	2460	2470	2480	2490	2500
Total Rad. Power (dBm)	-2.95	-3.00	-3.02	-3.01	-3.01	-3.01	-3.04	-3.09	-3.17	-3.25	-3.32	-3.32
Peak EIRP (dBm)	1.45	1.37	1.32	1.38	1.49	1.44	1.46	1.49	1.42	1.45	1.39	1.37
Directivity (dBi)	4.40	4.37	4.34	4.39	4.50	4.45	4.50	4.58	4.59	4.70	4.71	4.70
Efficiency (dB)	-2.95	-3.00	-3.02	-3.01	-3.01	-3.01	-3.04	-3.09	-3.17	-3.25	-3.32	-3.32
Efficiency (%)	50.73	50.08	49.93	50.02	50.01	49.98	49.69	49.08	48.17	47.31	46.57	46.53
Gain (dBi)	1.45	1.37	1.32	1.38	1.49	1.44	1.46	1.49	1.42	1.45	1.39	1.37

ANTENNA GAIN AND EFFICIENCY

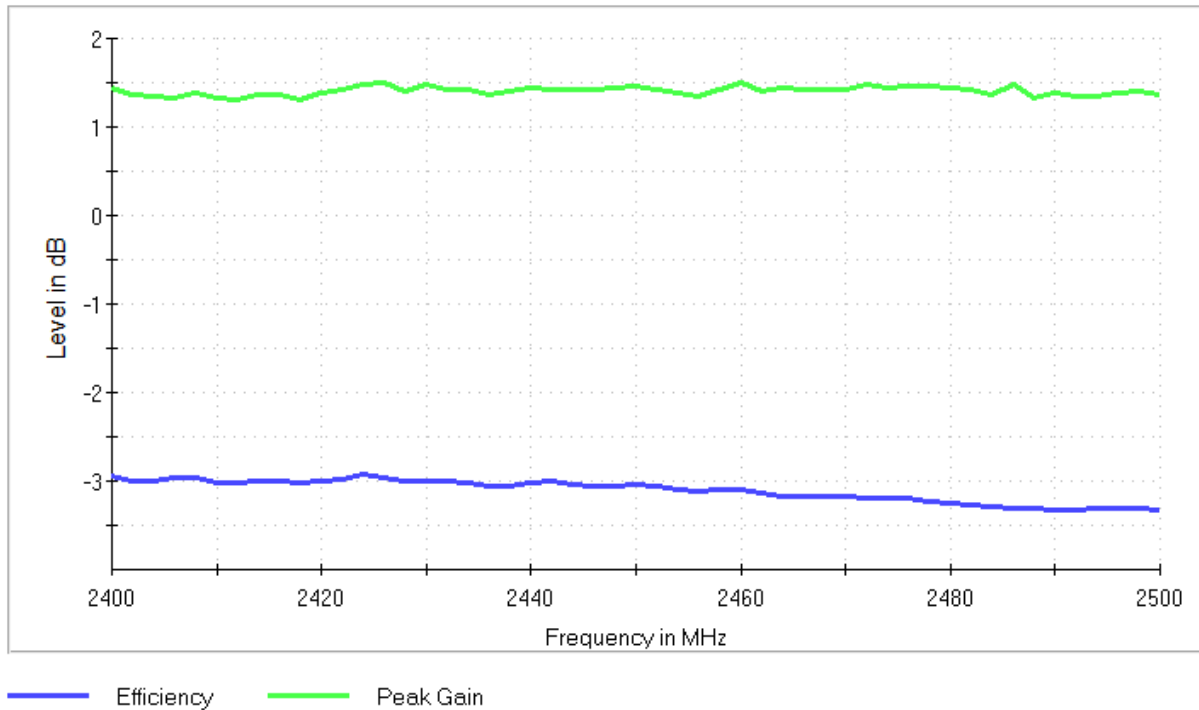

8. ANTENNA PLOTS

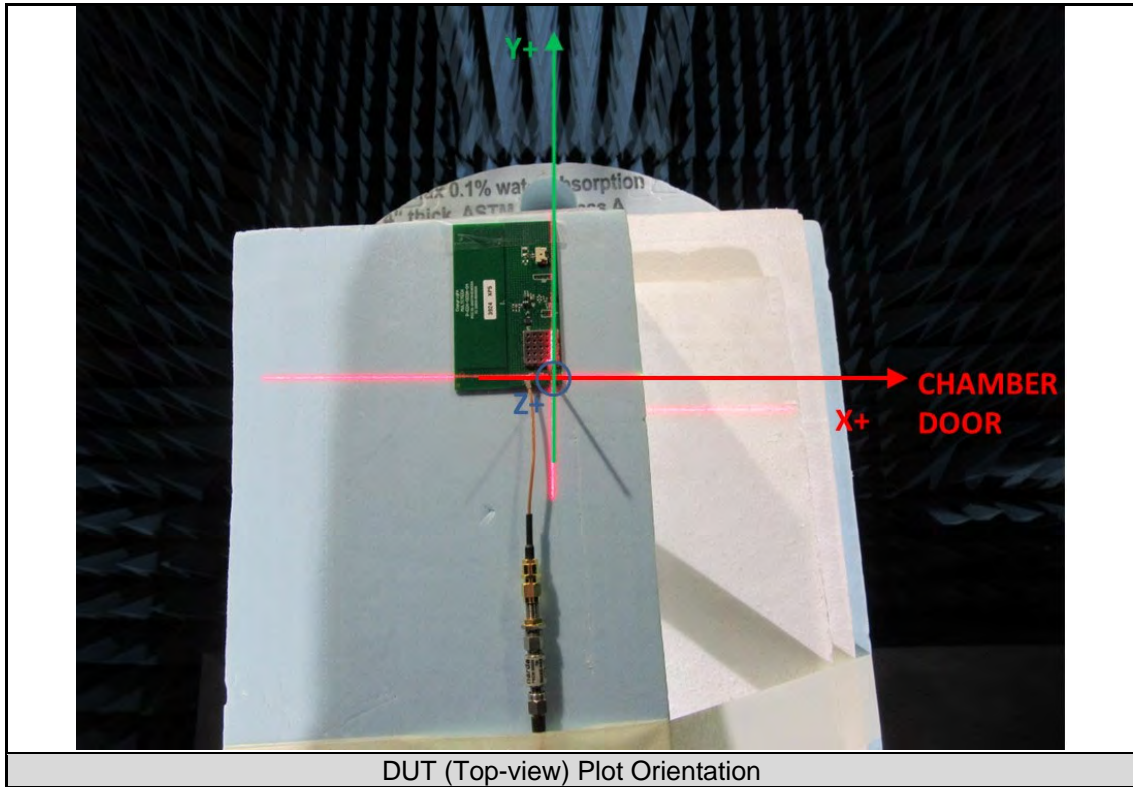

8.1. 2D MAIN CUTS

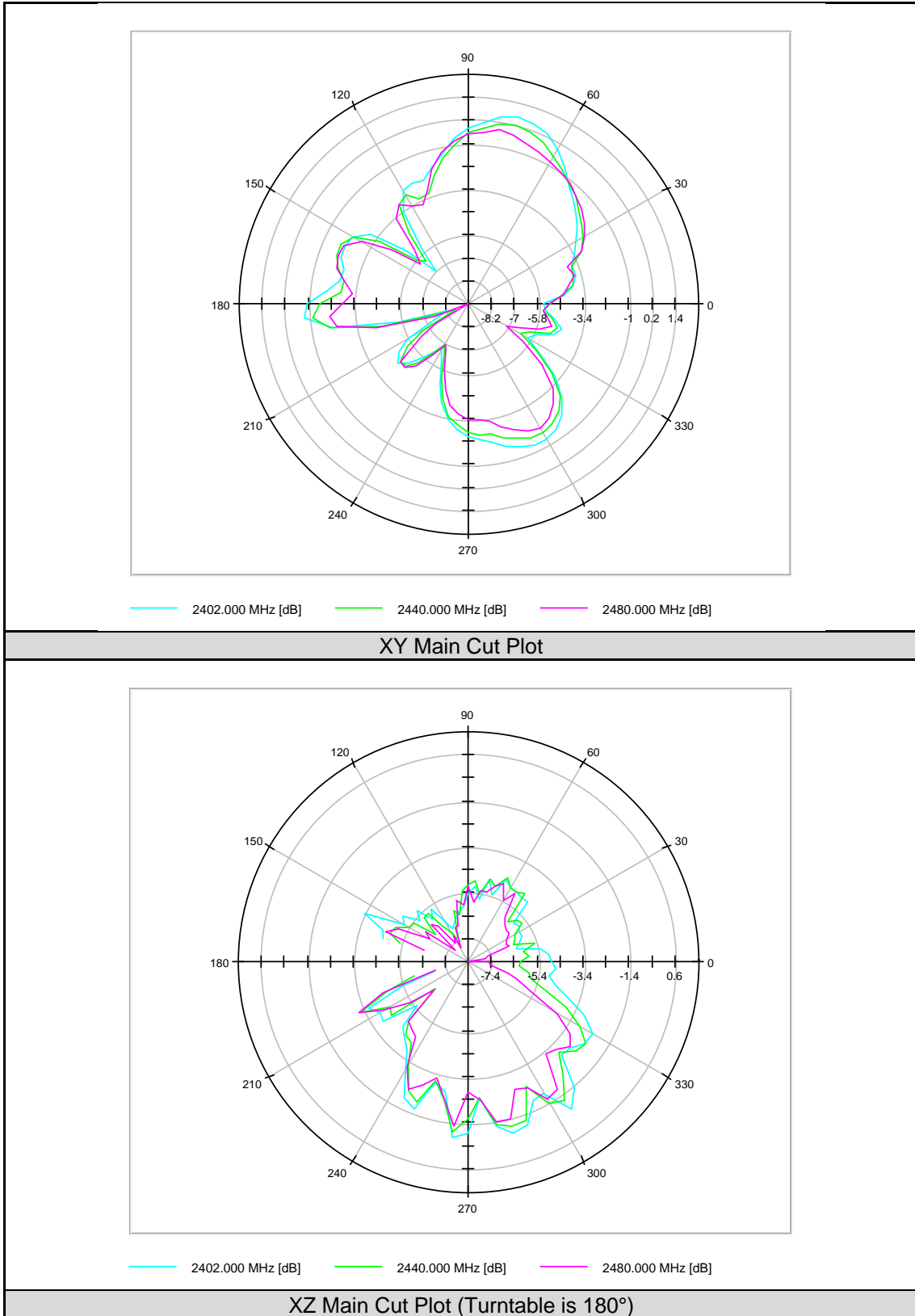

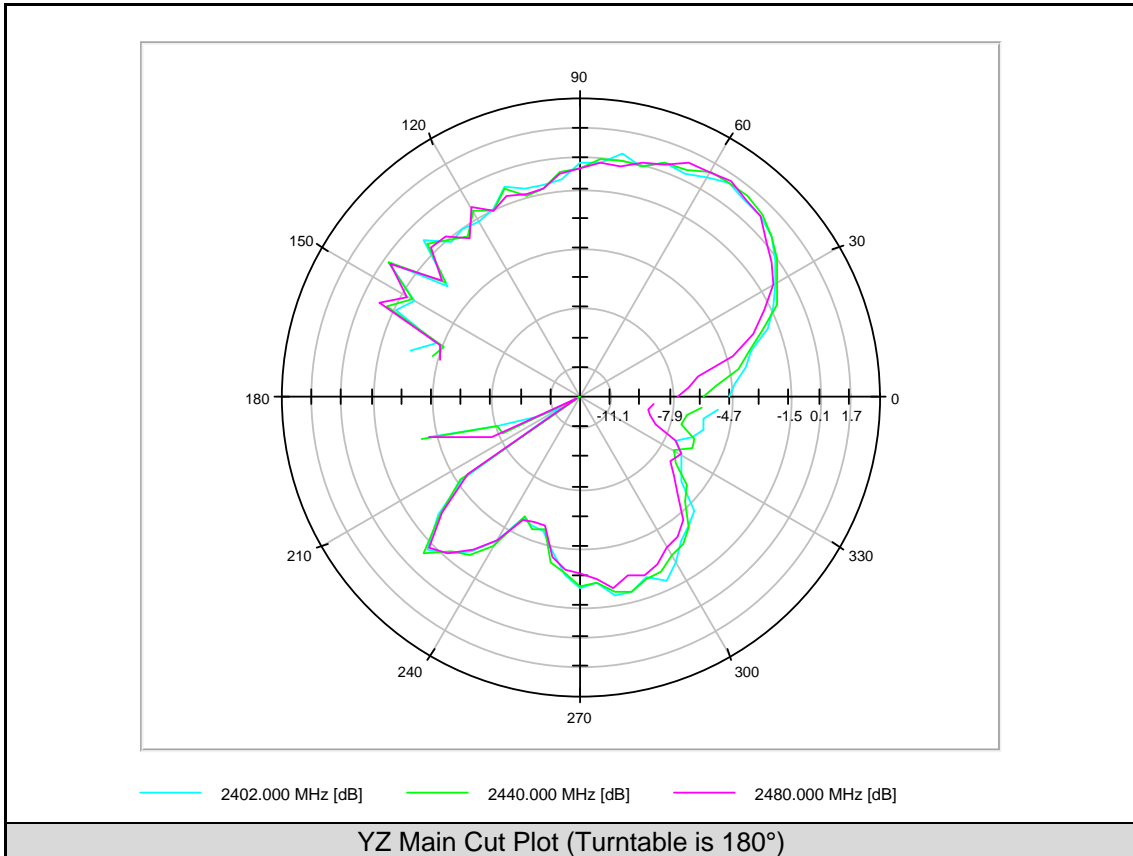

8.2. 3D PLOTS

2402MHz

Theta = 0, Phi = 0

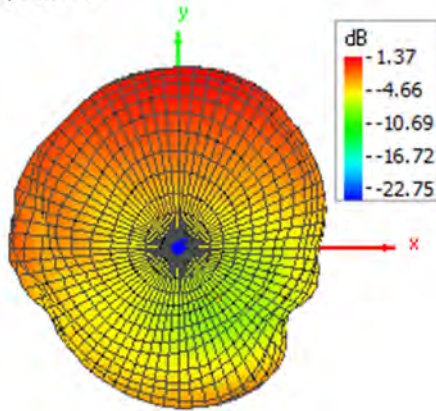

Theta = 180, Phi = 0

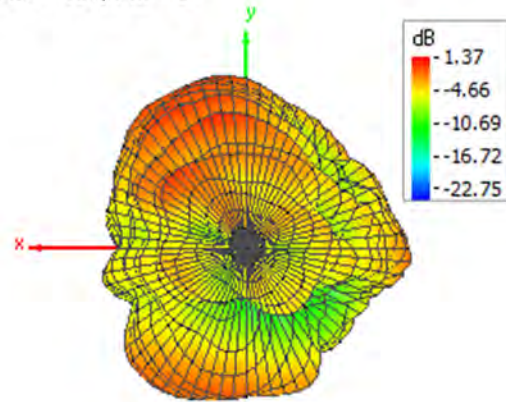

Theta = 90, Phi = 0

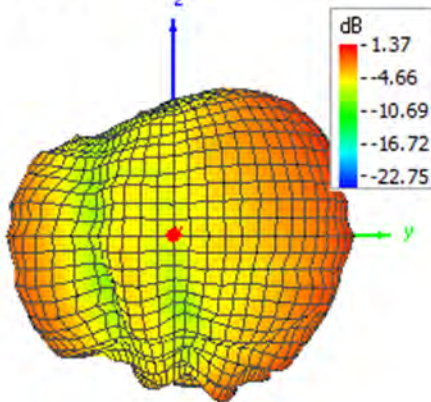

Theta = 90, Phi = 180

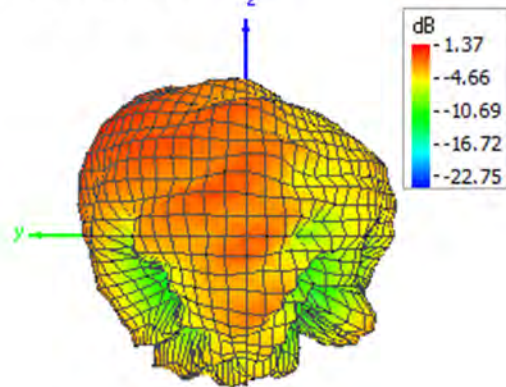

Theta = 90, Phi = 270

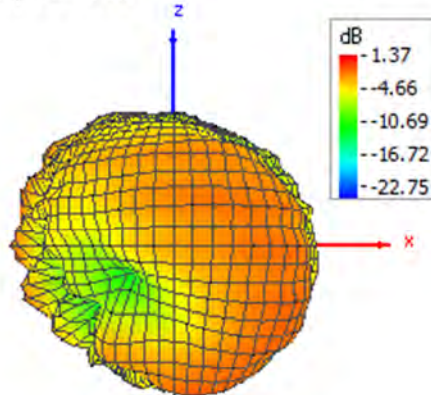

Theta = 90, Phi = 90

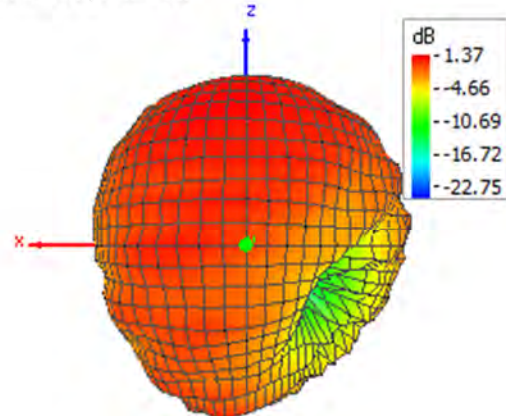

2440MHz

Theta = 0, Phi = 0

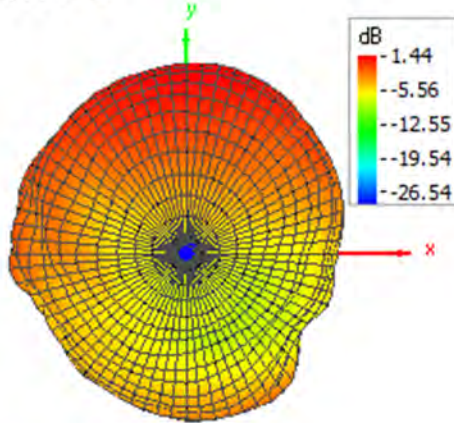

Theta = 180, Phi = 0

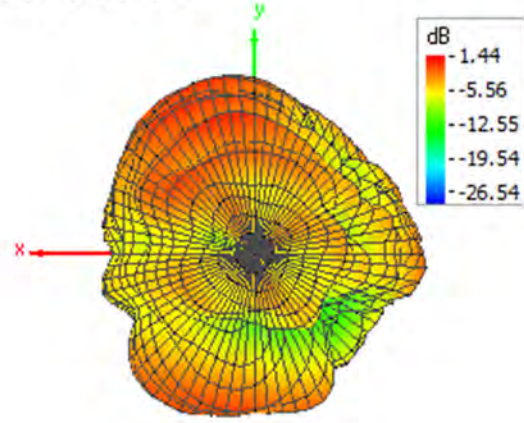

Theta = 90, Phi = 0

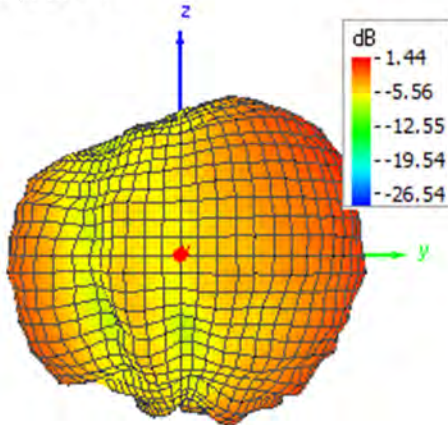

Theta = 90, Phi = 180

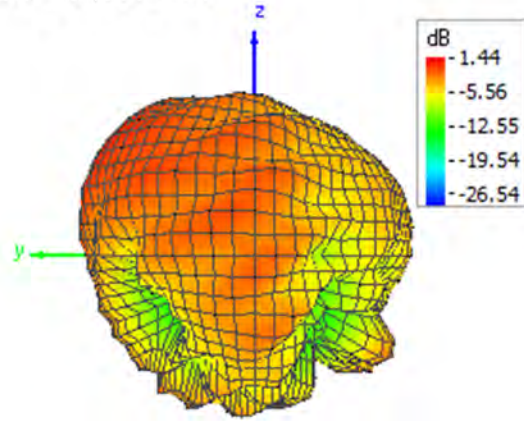

Theta = 90, Phi = 270

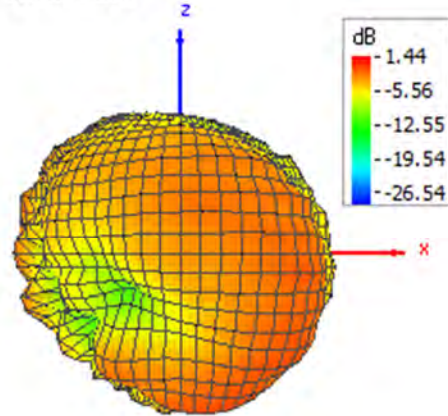

Theta = 90, Phi = 90

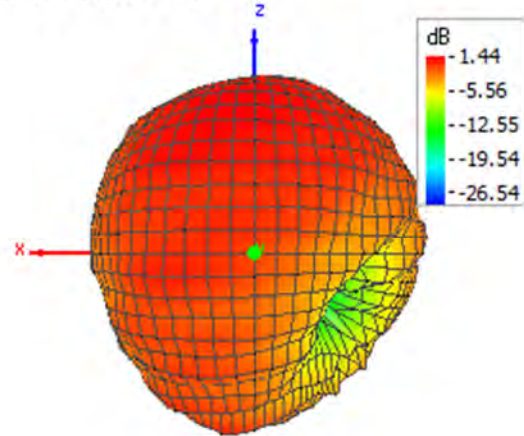

2480MHz

Theta = 0, Phi = 0

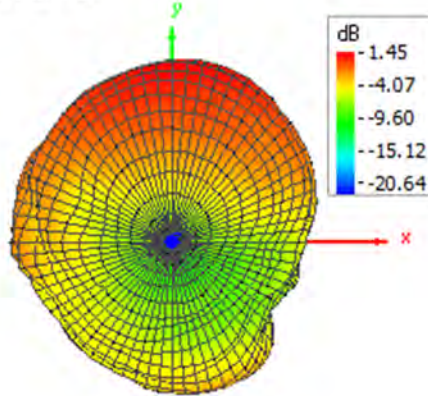

Theta = 180, Phi = 0

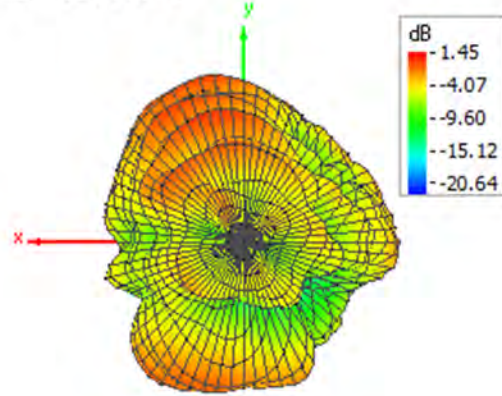

Theta = 90, Phi = 0

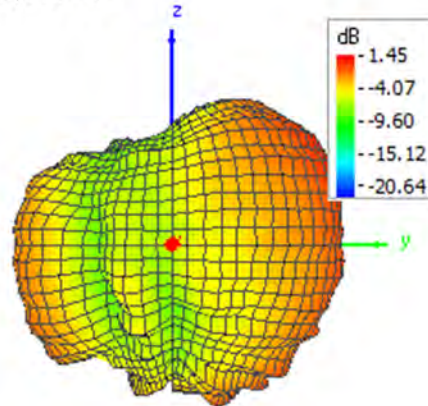

Theta = 90, Phi = 180

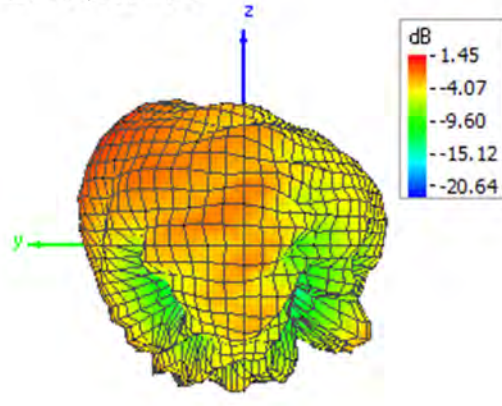

Theta = 90, Phi = 270

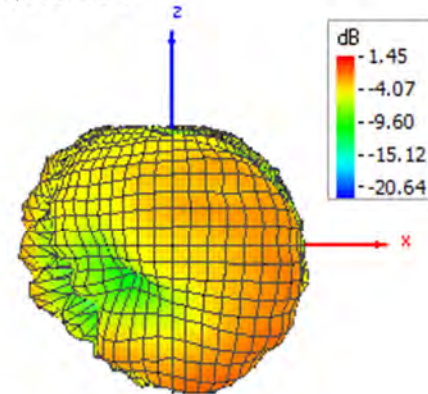

Theta = 90, Phi = 90

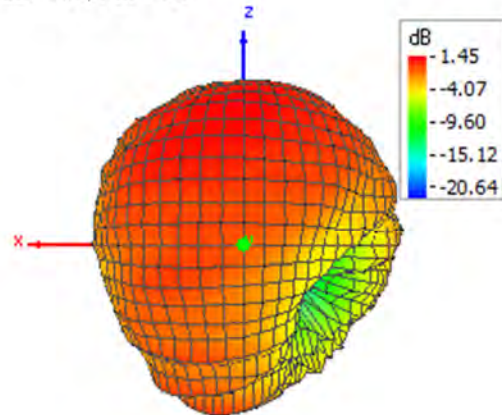

END OF REPORT