

TEST REPORT

Test report no.: 1-5906/18-02-02-B



BNetzA-CAB-02/21-102

Testing laboratory

CTC advanced GmbH

Untertuerkheimer Strasse 6 – 10
66117 Saarbruecken / Germany

Phone: + 49 681 5 98 - 0

Fax: + 49 681 5 98 - 9075

Internet: <http://www.ctcadvanced.com>

e-mail: mail@ctcadvanced.com

Accredited Testing Laboratory:

The testing laboratory (area of testing) is accredited according to DIN EN ISO/IEC 17025 (2005) by the Deutsche Akkreditierungsstelle GmbH (DAkkS)

The accreditation is valid for the scope of testing procedures as stated in the accreditation certificate with the registration number: D-PL-12076-01-03

Applicant

RFbeam Microwave GmbH

Schuppisstrasse 7
9016 St. Gallen / SWITZERLAND

Phone: +41 7 12 45 33 80

Contact: Léon Audergon

e-mail: audergon@rfbeam.ch

Phone: +41 7 12 45 33 80

Manufacturer

RFbeam Microwave GmbH

Schuppisstrasse 7
9016 St. Gallen / SWITZERLAND

Test standard/s

CFR 47 Part 95,
Subpart M

The 76-81 GHz Band Radar Service

For further applied test standards please refer to section 3 of this test report.

Test Item

Kind of test item: Automotive Radar

Model name: WDR77-VES

FCC ID: 2ASYV-WDR77-VES

Frequency: 76.0 GHz – 77 GHz

Antenna: Integrated patch antenna

Power supply: 9.5 V to 14.5 V DC by external power supply

Temperature range: -40°C to +85°C



This test report is electronically signed and valid without handwritten signature. For verification of the electronic signatures, the public keys can be requested at the testing laboratory.

Test report authorized:

Meheza Walla
Lab Manager
Radio Communications & EMC

Test performed:

Thomas Kautenburger
Testing Manager
Radio Communications & EMC

1 Table of contents

1	Table of contents	2
2	General information	3
2.1	Notes and disclaimer	3
2.2	Application details	3
2.3	Test laboratories sub-contracted	3
3	Test standard/s and references	4
4	Test environment.....	4
5	Test item	5
5.1	General description	5
5.2	Additional information	5
6	Description of the test setup	6
6.1	Shielded semi anechoic chamber	7
6.2	Shielded fully anechoic chamber	9
6.3	Radiated measurements > 18 GHz.....	10
6.4	Radiated measurements > 50/85 GHz.....	10
7	Sequence of testing	12
7.1	Sequence of testing radiated spurious 9 kHz to 30 MHz.....	12
7.2	Sequence of testing radiated spurious 30 MHz to 1 GHz.....	13
7.3	Sequence of testing radiated spurious 1 GHz to 18 GHz	14
7.4	Sequence of testing radiated spurious above 18 GHz	15
7.5	Sequence of testing radiated spurious above 50/85 GHz with external mixers	16
8	Measurement uncertainty	17
9	Summary of measurement results	18
10	Measurement results	19
10.1	Radiated power	19
10.2	Modulation characteristics	21
10.3	Occupied bandwidth.....	22
10.4	Band edge compliance.....	24
10.5	Field strength of spurious emissions.....	26
10.6	Frequency stability	36
11	Observations	43
12	Glossary.....	43
13	Document history	44
14	Accreditation Certificate	44

2 General information

2.1 Notes and disclaimer

The test results of this test report relate exclusively to the test item specified in this test report. CTC advanced GmbH does not assume responsibility for any conclusions and generalizations drawn from the test results with regard to other specimens or samples of the type of the equipment represented by the test item.

The test report may only be reproduced or published in full. Reproduction or publication of extracts from the report requires the prior written approval of CTC advanced GmbH.

The testing service provided by CTC advanced GmbH has been rendered under the current "General Terms and Conditions for CTC advanced GmbH".

CTC advanced GmbH will not be liable for any loss or damage resulting from false, inaccurate, inappropriate or incomplete product information provided by the customer.

Under no circumstances does the CTC advanced GmbH test report include any endorsement or warranty regarding the functionality, quality or performance of any other product or service provided.

Under no circumstances does the CTC advanced GmbH test report include or imply any product or service warranties from CTC advanced GmbH, including, without limitation, any implied warranties of merchantability, fitness for purpose, or non-infringement, all of which are expressly disclaimed by CTC advanced GmbH.

All rights and remedies regarding vendor's products and services for which CTC advanced GmbH has prepared this test report shall be provided by the party offering such products or services and not by CTC advanced GmbH. In no case this test report can be considered as a Letter of Approval.

This test report is electronically signed and valid without handwritten signature. For verification of the electronic signatures, the public keys can be requested at the testing laboratory.

This test report replaces the test report with the number 1-5906/18-02-02-A and dated 2019-08-07

2.2 Application details

Date of receipt of order:	2019-01-14
Date of receipt of test item:	2019-01-21
Start of test:	2019-01-21
End of test:	2019-03-28
Person(s) present during the test:	Mr. Léon Audergon

2.3 Test laboratories sub-contracted

None

3 Test standard/s and references

Test standard	Date	Description
CFR 47 Part 95, Subpart M	2018-12	The 76-81 GHz Band Radar Service

Guidance	Version	Description
ANSI C63.4-2014	-/-	American national standard for methods of measurement of radio-noise emissions from low-voltage electrical and electronic equipment in the range of 9 kHz to 40 GHz
ANSI C63.10-2013	-/-	American national standard of procedures for compliance testing of unlicensed wireless devices
KDB 653005 D01	V01	Equipment Authorization Guidance for 76-81 GHz Radar Devices

4 Test environment

Temperature	:	T_{nom} +22 °C during room temperature tests T_{max} +85 °C during high temperature tests T_{min} -40 °C during low temperature tests
Relative humidity content	:	55 %
Barometric pressure	:	1021 hpa
Power supply	:	V_{nom} 12.0 V DC by external power supply V_{max} 14.5 V V_{min} 9.5 V

5 Test item

5.1 General description

Kind of test item	:	Automotive Radar
Type identification	:	WDR77-VES
S/N serial number	:	L1808n00001
Hardware status	:	C0
Software status	:	V1.09
Firmware status	:	99
Frequency band	:	76.0 GHz – 77 GHz
Type of modulation	:	FMCW
Number of modes	:	1
Antenna	:	Integrated patch antenna
Power supply	:	9.5 V to 14.5 V DC by external power supply
Temperature range	:	-40°C to +85°C

5.2 Additional information

The content of the following annexes is defined in the QA. It may be that not all of the listed annexes are necessary for this report, thus some values in between may be missing.

Test setup and EUT photos are included in test report:

- 1-5906/18-01-01_AnnexA
- 1-5906/18-01-01_AnnexB
- 1-5906/18-01-01_AnnexD

6 Description of the test setup

Typically, the calibrations of the test apparatus are commissioned to and performed by an accredited calibration laboratory. The calibration intervals are determined in accordance with the DIN EN ISO/IEC 17025. In addition to the external calibrations, the laboratory executes comparison measurements with other calibrated test systems or effective verifications. Weekly chamber inspections and range calibrations are performed. Where possible, RF generating and signaling equipment as well as measuring receivers and analyzers are connected to an external high-precision 10 MHz reference (GPS-based or rubidium frequency standard).

In order to simplify the identification of the equipment used at some special tests, some items of test equipment and ancillaries can be provided with an identifier or number in the equipment list below (Lab/Item).

Agenda: Kind of Calibration

k	calibration / calibrated		EK	limited calibration
ne	not required (k, ev, izw, zw not required)		zw	cyclical maintenance (external cyclical maintenance)
ev	periodic self verification		izw	internal cyclical maintenance
Ve	long-term stability recognized		g	blocked for accredited testing
vkl!	Attention: extended calibration interval			
NK!	Attention: not calibrated		*)	next calibration ordered / currently in progress

6.1 Shielded semi anechoic chamber

The radiated measurements are performed in vertical and horizontal plane in the frequency range from 30 MHz to 1 GHz in semi-anechoic chambers. The EUT is positioned on a non-conductive support with a height of 0.80 m above a conductive ground plane that covers the whole chamber. The receiving antennas are conform to specifications ANSI C63. These antennas can be moved over the height range between 1.0 m and 4.0 m in order to search for maximum field strength emitted from EUT. The measurement distances between EUT and receiving antennas are indicated in the test setups for the various frequency ranges. For each measurement, the EUT is rotated in all three axes until the maximum field strength is received. The wanted and unwanted emissions are received by spectrum analyzers where the detector modes and resolution bandwidths over various frequency ranges are set according to requirement ANSI C63.

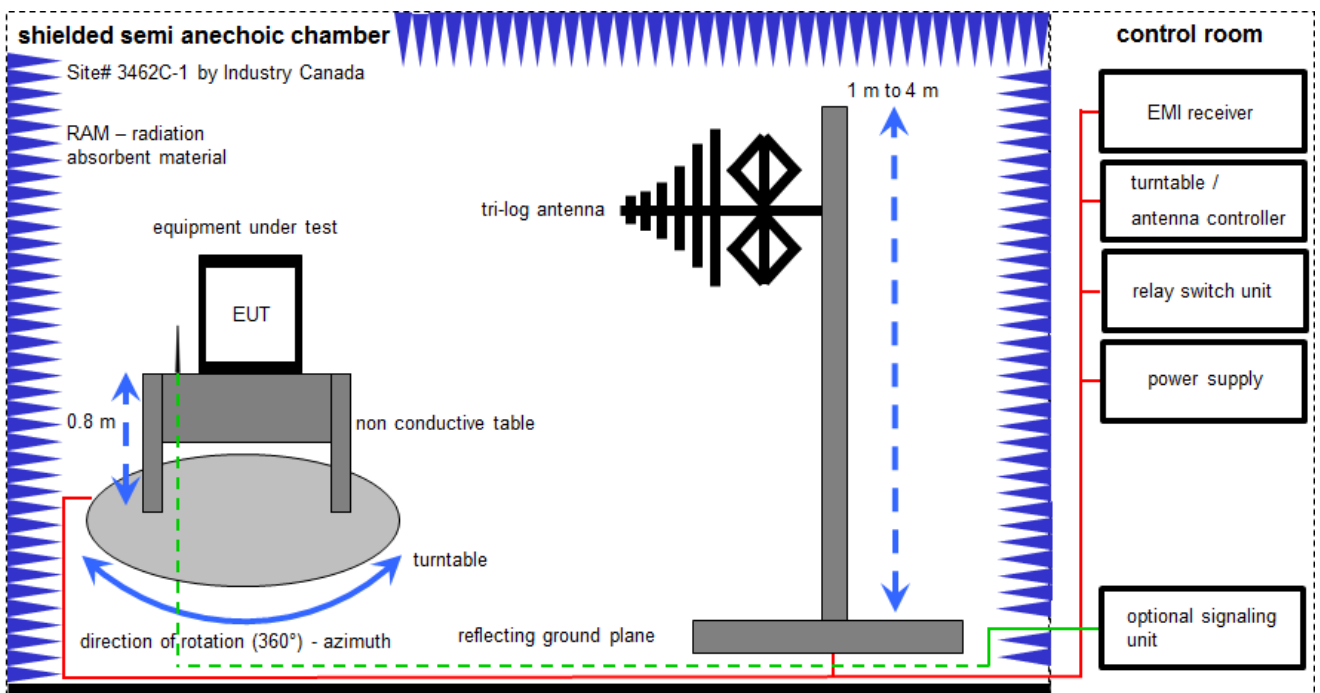

Measurement distance: tri-log antenna 10 meter

$$FS = UR + CL + AF$$

(FS-field strength; UR-voltage at the receiver; CL-loss of the cable; AF-antenna factor)

Example calculation:

$$FS [dB\mu V/m] = 12.35 [dB\mu V/m] + 1.90 [dB] + 16.80 [dB/m] = 31.05 [dB\mu V/m] (35.69 \mu V/m)$$

Equipment table:

No.	Lab / Item	Equipment	Type	Manufacturer	Serial No.	INV. No.	Kind of Calibration	Last Calibration	Next Calibration
1	45	Switch-Unit	3488A	HP	2719A14505	300000368	ev	-/-	-/-
2	50	DC power supply, 60Vdc, 50A, 1200 W	6032A	HP	2920A04466	300000580	ne	-/-	-/-
3	93	Meißkabine 1	HF-Absorberhalle	MWB AG 300023		300000551	ne	-/-	-/-
4	n. a.	EMI Test Receiver	ESCI 3	R&S	100083	300003312	k	12.12.2018	11.12.2019
5	n. a.	Analyzer-Reference-System (Harmonics and Flicker)	ARS 16/1	SPS	A3509 07/0 0205	300003314	vKI!	15.01.2018	14.01.2020
6	n. a.	Antenna Tower	Model 2175	ETS-Lindgren	64762	300003745	izw	-/-	-/-
7	n. a.	Positioning Controller	Model 2090	ETS-Lindgren	64672	300003746	izw	-/-	-/-
8	n. a.	Turntable Interface-Box	Model 105637	ETS-Lindgren	44583	300003747	izw	-/-	-/-
9	n. a.	TRILOG Broadband Test-Antenna 30 MHz - 3 GHz	VULB9163	Schwarzbeck Mess - Elektronik	371	300003854	vKI!	24.11.2017	23.11.2020
10	n. a.	Spectrum-Analyzer	FSU26	R&S	200809	300003874	k	17.12.2018	16.12.2019

6.2 Shielded fully anechoic chamber

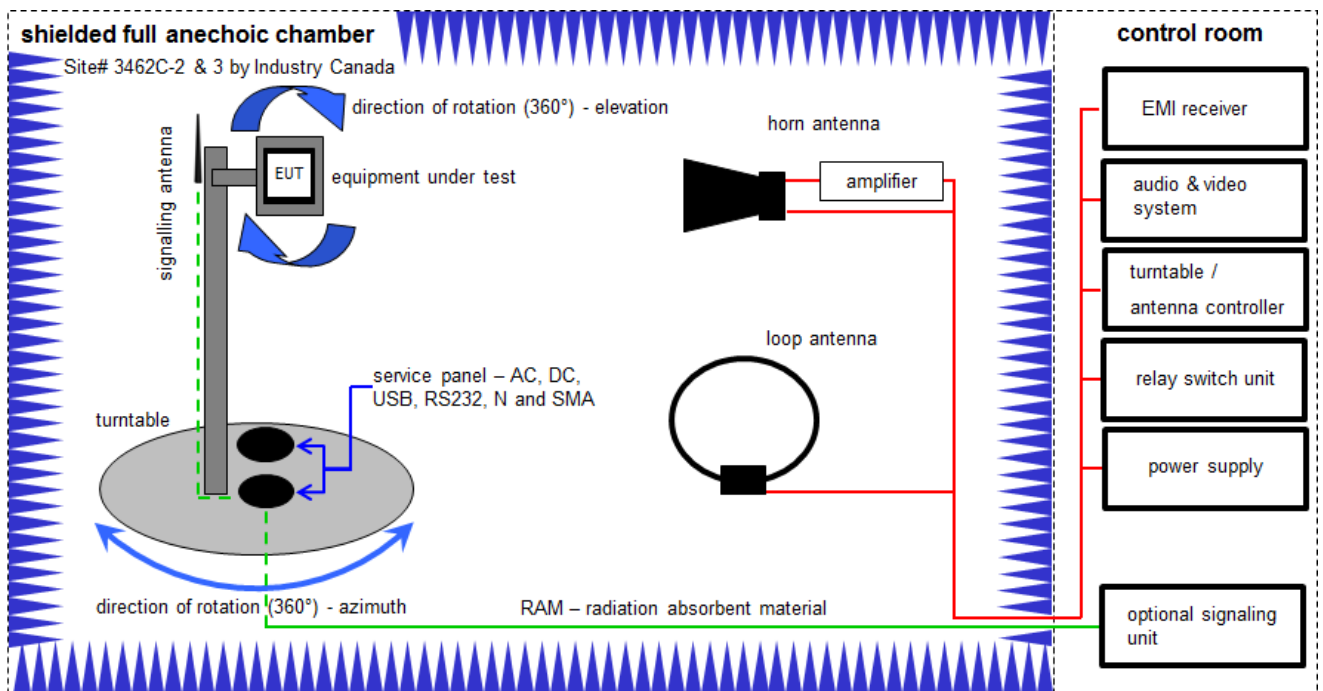

Measurement distance: horn antenna 3 meter; loop antenna 3 meter / 1 meter

$$FS = UR + CA + AF$$

(FS-field strength; UR-voltage at the receiver; CA-loss of the signal path; AF-antenna factor)

Example calculation:

$$FS [dB\mu V/m] = 40.0 [dB\mu V/m] + (-35.8) [dB] + 32.9 [dB/m] = 37.1 [dB\mu V/m] (71.61 \mu V/m)$$

Equipment table:

No.	Lab / Item	Equipment	Type	Manufacturer	Serial No.	INV. No.	Kind of Calibration	Last Calibration	Next Calibration
1	n. a.	DC power supply, 60Vdc, 50A, 1200 W	6032A	HP	2818A03450	300001040	vKI!	12.12.2017	11.12.2020
2	n. a.	Active Loop Antenna 9 kHz to 30 MHz	6502	EMCO	2210	300001015	vKI!	07.07.2017	06.07.2019
3	n. a.	Anechoic chamber	FAC 3/5m	MWB / TDK	87400/02	300000996	ev	-/-	-/-
4	19	Double-Ridged Waveguide Horn Antenna 1-18.0GHz	3115	EMCO	9107-3697	300001605	vKI!	14.02.2017	13.02.2019
5	n. a.	Switch / Control Unit	3488A	HP	*	300000199	ne	-/-	-/-
6	9	Variable isolating transformer	MPL IEC625 Bus Variable isolating transformer	Erfi	91350	300001155	ne	-/-	-/-
7	n. a.	EMI Test Receiver 20Hz- 26,5GHz	ESU26	R&S	100037	300003555	k	14.09.2018	13.12.2019
8	n. a.	Highpass Filter	WHKX7.0/18G-8SS	Wainwright	19	300003790	ne	-/-	-/-
9	n. a.	Broadband Amplifier 0.5-18 GHz	CBLU5184540	CERNEX	22049	300004481	ev	-/-	-/-
10	n. a.	Broadband Amplifier 5-13 GHz	CBLU5135235	CERNEX	22010	300004491	ev	-/-	-/-
11	n. a.	4U RF Switch Platform	L4491A	Agilent Technologies	MY50000037	300004509	ne	-/-	-/-
12	n. a.	NEXIO EMV-Software	BAT EMC V3.16.0.49	EMCO		300004682	ne	-/-	-/-
13	n. a.	PC	ExOne	F+W		300004703	ne	-/-	-/-
14	n. a.	RF-Amplifier	AMF-6F06001800-30-10P-R	NARDA-MITEQ Inc	2011572	300005241	ev	-/-	-/-

6.3 Radiated measurements > 18 GHz

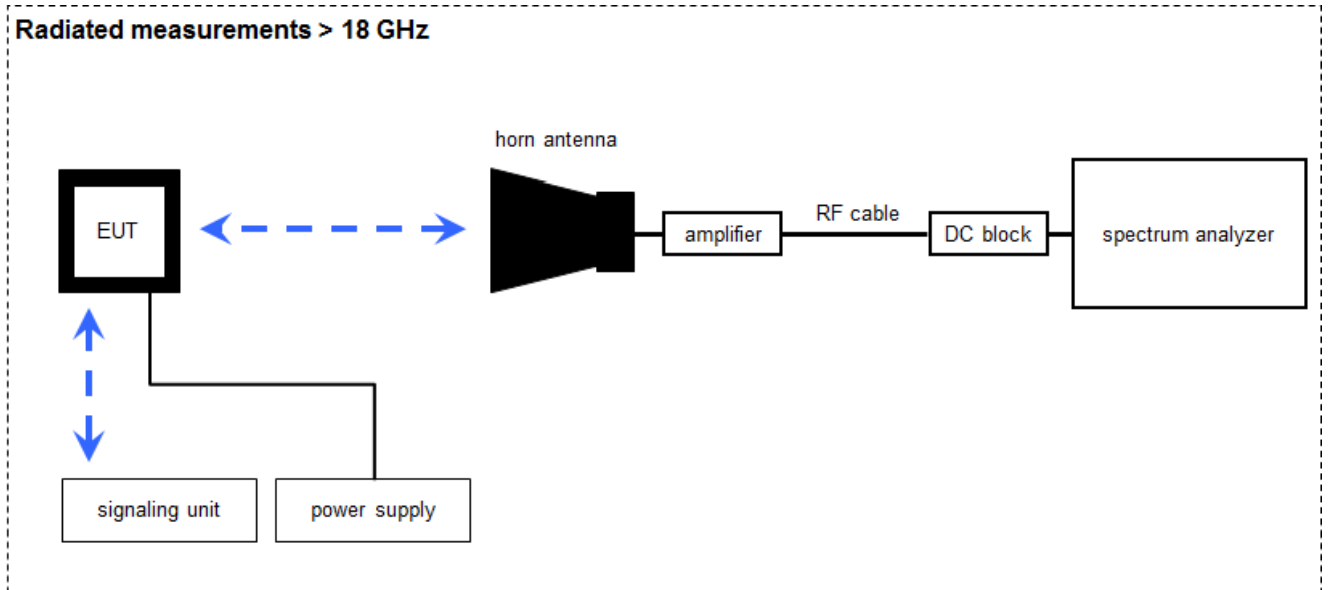

6.4 Radiated measurements > 50/85 GHz

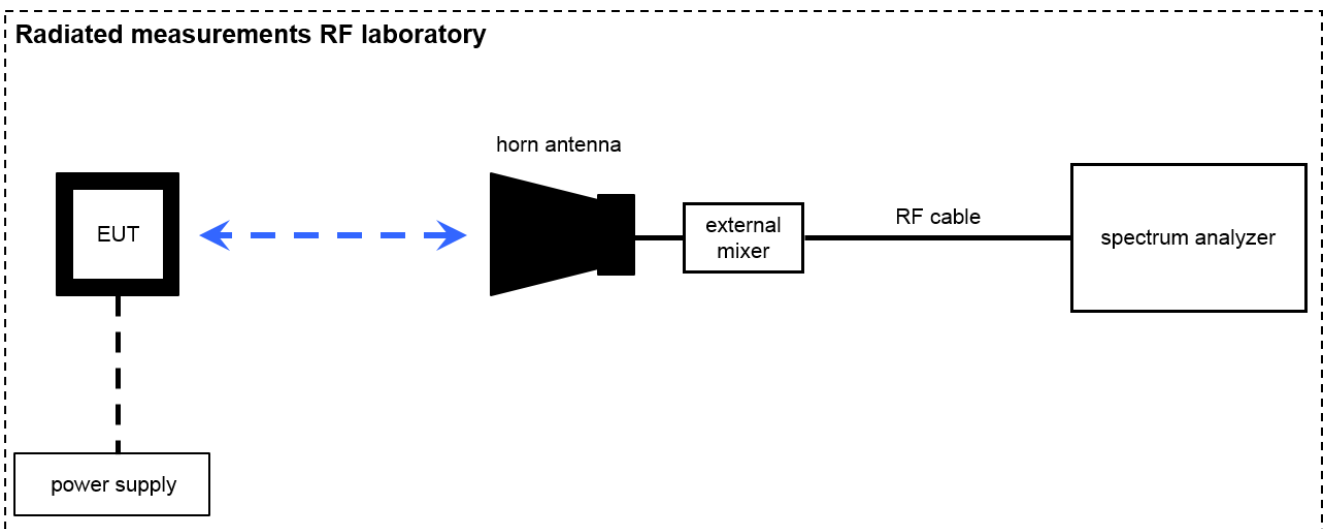

$$OP = AV + D - G$$

(OP-rad. output power; AV-analyzer value; D-free field attenuation of measurement distance; G-antenna gain)

Example calculation:

$$OP \text{ [dBm]} = -54.0 \text{ [dBm]} + 64.0 \text{ [dB]} - 20.0 \text{ [dBi]} = -10 \text{ [dBm]} \text{ (100 } \mu\text{W)}$$

Note: conversion loss of mixer is already included in analyzer value.

Equipment table:

No.	Lab / Item	Equipment	Type	Manufacturer	Serial No.	INV. No.	Kind of Calibration	Last Calibration	Next Calibration
1	CR 79	Std. Gain Horn Antenna 26.5-40.0 GHz	V637	Narda	7911	300001751	ne	-/-	-/-
2	A023	Std. Gain Horn Antenna 39.3-59.7 GHz	2424-20	Flann	75	300001979	ne	-/-	-/-
3	A025	Std. Gain Horn Antenna 49.9-75.8 GHz	2524-20	Flann	*	300001983	ne	-/-	-/-
4	A027	Std. Gain Horn Antenna 73.8-112 GHz	2724-20	Flann	*	300001988	ne	-/-	-/-
5	A032	Std. Gain Horn Antenna 114-173 GHz	2924-20	Flann	*	300001999	ne	-/-	-/-
6	A033	Std. Gain Horn Antenna 145-220 GHz	3024-20	Flann	*	300002000	ne	-/-	-/-
7	A027	Std. Gain Horn Antenna 18.0-26.5 GHz	638	Narda		300000486	vKI!	13.12.2017	12.12.2019
8	n. a.	Harmonic Mixer 3-Port, 110-170 GHz	SAM-170	Radiometer Physics GmbH	100014	300004156	k	15.03.2018	14.03.2019
9	n. a.	Harmonic Mixer 3-Port, 140-220 GHz	SAM-220	Radiometer Physics GmbH	200001	300004157	k	08.08.2018	07.08.2019
10	n. a.	Harmonic Mixer 3-Port, 220-325 GHz	SAM-325	Radiometer Physics GmbH	100002	300004158	k	02.08.2018	01.08.2019
11	n. a.	Std. Gain Horn Antenna 33.0-50.1 GHz	2324-20	Flann	57	400000683	ne	-/-	-/-
12	n. a.	Std. Gain Horn Antenna 60-90 GHz	COR 60_90	Thomson CSF		300000814	ev	-/-	-/-
13	n. a.	Broadband LNA 18-50 GHz	CBL18503070PN	CERNEX	25240	300004948	ev	-/-	-/-
14	n. a.	Std. Gain Horn Antenna 217-330 GHz	32240-20	Flann	233278	300004960	ne	-/-	-/-
15	n. a.	Harmonic Mixer 3-Port, 75-110 GHz	FS-Z110	R&S	101411	300004959	k	23.07.2018	22.07.2019
16	n. a.	Spectrum Analyzer	FSW85	Rohde & Schwarz	101333	300005568	k	29.06.2018	28.06.2019
17	n. a.	Temperature Test Chamber	T-40/50	CTS GmbH	064023	300003540	ev	07.05.2018	06.05.2020

7 Sequence of testing

7.1 Sequence of testing radiated spurious 9 kHz to 30 MHz

Setup

- The equipment is set up to simulate normal operation mode as described in the user manual or defined by the manufacturer.
- If the EUT is a tabletop system, it is placed on a table with 0.8 m height.
- If the EUT is a floor standing device, it is placed directly on the turn table.
- Auxiliary equipment and cables are positioned to simulate normal operation conditions as described in ANSI C 63.4.
- The AC power port of the EUT (if available) is connected to a power outlet below the turntable.
- Measurement distance is 3 m (see ANSI C 63.4) – see test details.
- EUT is set into operation.

Premeasurement*

- The turntable rotates from 0° to 315° using 45° steps.
- The antenna height is 1 m.
- At each turntable position the analyzer sweeps with positive-peak detector to find the maximum of all emissions.

Final measurement

- Identified emissions during the pre-measurement are maximized by the software by rotating the turntable from 0° to 360°.
- Loop antenna is rotated about its vertical axis for maximum response at each azimuth about the EUT. (For certain applications, the loop antenna plane may also need to be positioned horizontally at the specified distance from the EUT)
- The final measurement is done in the position (turntable and elevation) causing the highest emissions with quasi-peak (as described in ANSI C 63.4).
- Final levels, frequency, measuring time, bandwidth, turntable position, correction factor, margin to the limit and limit will be recorded. A plot with the graph of the premeasurement and the limit is stored.

*)Note: The sequence will be repeated three times with different EUT orientations.

7.2 Sequence of testing radiated spurious 30 MHz to 1 GHz

Setup

- The equipment is set up to simulate normal operation mode as described in the user manual or defined by the manufacturer.
- If the EUT is a tabletop system, a table with 0.8 m height is used, which is placed on the ground plane.
- If the EUT is a floor standing device, it is placed on the ground plane with insulation between both.
- Auxiliary equipment and cables are positioned to simulate normal operation conditions as described in ANSI C 63.4.
- The AC power port of the EUT (if available) is connected to a power outlet below the turntable.
- Measurement distance is 10 m or 3 m (see ANSI C 63.4) – see test details.
- EUT is set into operation.

Premeasurement

- The turntable rotates from 0° to 315° using 45° steps.
- The antenna is polarized vertical and horizontal.
- The antenna height changes from 1 m to 3 m.
- At each turntable position, antenna polarization and height the analyzer sweeps three times in peak to find the maximum of all emissions.

Final measurement

- The final measurement is performed for at least six highest peaks according to the requirements of the ANSI C63.4.
- Based on antenna and turntable positions at which the peak values are measured the software maximize the peaks by changing turntable position $\pm 45^\circ$ and antenna height between 1 and 4 m.
- The final measurement is done with quasi-peak detector (as described in ANSI C 63.4).
- Final levels, frequency, measuring time, bandwidth, antenna height, antenna polarization, turntable angle, correction factor, margin to the limit and limit are recorded. A plot with the graph of the premeasurement with marked maximum final results and the limit is stored.

7.3 Sequence of testing radiated spurious 1 GHz to 18 GHz

Setup

- The equipment is set up to simulate normal operation mode as described in the user manual or defined by the manufacturer.
- If the EUT is a tabletop system, a 2-axis positioner with 1.5 m height is used.
- If the EUT is a floor standing device, it is placed directly on the turn table.
- Auxiliary equipment and cables are positioned to simulate normal operation conditions as described in ANSI C 63.4.
- The AC power port of the EUT (if available) is connected to a power outlet below the turntable.
- Measurement distance is 3 m (see ANSI C 63.4) – see test details.
- EUT is set into operation.

Premeasurement

- The turntable rotates from 0° to 315° using 45° steps.
- The antenna is polarized vertical and horizontal.
- The antenna height is 1.5 m.
- At each turntable position and antenna polarization the analyzer sweeps with positive peak detector to find the maximum of all emissions.

Final measurement

- The final measurement is performed for at least six highest peaks according to the requirements of the ANSI C63.4.
- Based on antenna and turntable positions at which the peak values are measured the software maximizes the peaks by rotating the turntable from 0° to 360°. This measurement is repeated for different EUT-table positions (0° to 150° in 30°-steps) and for both antenna polarizations.
- The final measurement is done in the position (turntable, EUT-table and antenna polarization) causing the highest emissions with Peak and RMS detector (as described in ANSI C 63.4).
- Final levels, frequency, measuring time, bandwidth, turntable position, EUT-table position, antenna polarization, correction factor, margin to the limit and limit are recorded. A plot with the graph of the premeasurement with marked maximum final results and the limit is stored.

7.4 Sequence of testing radiated spurious above 18 GHz

Setup

- The equipment is set up to simulate normal operation mode as described in the user manual or defined by the manufacturer.
- Auxiliary equipment and cables are positioned to simulate normal operation conditions as described in ANSI C 63.4.
- The AC power port of the EUT (if available) is connected to a power outlet.
- The measurement distance is as appropriate (e.g. 0.5 m).
- The EUT is set into operation.

Premeasurement

- The test antenna is handheld and moved carefully over the EUT to cover the EUT's whole sphere and different polarizations of the antenna.

Final measurement

- The final measurement is performed at the position and antenna orientation causing the highest emissions with Peak and RMS detector (as described in ANSI C 63.4).
- Final levels, frequency, measuring time, bandwidth, correction factor, margin to the limit and limit are recorded. A plot with the graph of the premeasurement and the limit is stored.

7.5 Sequence of testing radiated spurious above 50/85 GHz with external mixers

Setup

- The equipment is set up to simulate normal operation mode as described in the user manual or defined by the manufacturer.
- Auxiliary equipment and cables are positioned to simulate normal operation conditions as described in ANSI C 63.4.
- The AC power port of the EUT (if available) is connected to a power outlet.
- The measurement distance is as appropriate for far field (e.g. 0.25 m).
- The EUT is set into operation.

Premeasurement

- The test antenna with external mixer is handheld and moved carefully over the EUT to cover the EUT's whole sphere and different polarizations of the antenna.
- Caution is taken to reduce the possible overloading of the external mixer.

Final measurement

- The final measurement is performed at the position and antenna orientation causing the highest emissions with Peak and RMS detector (as described in ANSI C 63.4).
- As external mixers may generate false images care is taken to ensure that any emission measured by the spectrum analyzer does indeed originate in the EUT. Signal identification feature of spectrum analyzer is used to eliminate false mixer images (i.e., it is not the fundamental emission or a harmonic falling precisely at the measured frequency).
- Final levels, frequency, measuring time, bandwidth, correction factor, margin to the limit and limit are recorded. A plot with the graph of the premeasurement and the limit is stored.

8 Measurement uncertainty

Test case	Uncertainty
Equivalent isotropically radiated power (e.i.r.p.)	Conducted value ± 1 dB Radiated value ± 3 dB
Permitted range of operating frequencies	± 100 kHz
Conducted unwanted emissions in the spurious domain (up to 40 GHz)	± 1 dB
Radiated unwanted emissions in the spurious domain (up to 40 GHz)	± 3 dB
Conducted unwanted emissions in the spurious domain (40 to 50 GHz)	± 4 dB
Radiated unwanted emissions in the spurious domain (40 to 50 GHz)	± 4 dB
Conducted unwanted emissions in the spurious domain (50 to 300 GHz)	± 5 dB
Radiated unwanted emissions in the spurious domain (50 to 300 GHz)	± 5 dB
DC and low frequency voltages	± 3 %
Temperature	± 1 °C
Humidity	± 3 %

9 Summary of measurement results

<input checked="" type="checkbox"/>	No deviations from the technical specifications were ascertained
<input type="checkbox"/>	There were deviations from the technical specifications ascertained
<input type="checkbox"/>	This test report is only a partial test report. The content and verdict of the performed test cases are listed below.

TC Identifier	Description	Verdict	Date	Remark
RF-Testing	47 CFR Part 95 Subpart M	see below	2019-08-14	-/-

Test specification clause	Test case	Temperature conditions	Power source voltages	C	NC	NA	NP	Results (max.)
§2.1046 §95.3367 (a) (b)	Radiated power	Nominal	Nominal	<input checked="" type="checkbox"/>	<input type="checkbox"/>	<input type="checkbox"/>	<input type="checkbox"/>	
§2.1047	Modulation characteristics	-/-	-/-	<input checked="" type="checkbox"/>	<input type="checkbox"/>	<input type="checkbox"/>	<input type="checkbox"/>	
§2.1049	Occupied bandwidth (99% bandwidth)	Nominal	Nominal	<input checked="" type="checkbox"/>	<input type="checkbox"/>	<input type="checkbox"/>	<input type="checkbox"/>	
§2.1051	Spurious emissions at antenna terminals	Nominal	Nominal	<input type="checkbox"/>	<input type="checkbox"/>	<input type="checkbox"/>	<input checked="" type="checkbox"/>	see note
§2.1053 §95.3379 (a)(1) §95.3379 (a)(2) §95.3379 (a)(3)	Field strength of emissions (radiated spurious)	Nominal	Nominal	<input checked="" type="checkbox"/>	<input type="checkbox"/>	<input type="checkbox"/>	<input type="checkbox"/>	
§2.1055 §95.3379 (b)	Frequency stability	Nominal and Extreme	Nominal and Extreme	<input checked="" type="checkbox"/>	<input type="checkbox"/>	<input type="checkbox"/>	<input type="checkbox"/>	

Note: C = Compliant; NC = Not compliant; NA = Not applicable; NP = Not performed

See FCC's Millimeter Wave Test Procedures:

I. A radiated method of measurements in order to demonstrate compliance with the various regulatory requirements has been chosen in consideration of test equipment availability and the limitations of many external harmonic mixers. A conducted method of measurement could be employed if EUT and mixer waveguides both are accessible and of the same type (WG number) and if waveguide sections and transitions can be found. Another potential problem is that the peak power output of devices operating under Sections 15.253 and 15.255 may exceed the +20 dBm input power limit of many commercially available mixers. For these reasons a radiated method is preferred.

10 Measurement results

10.1 Radiated power

Description:

The fundamental radiated emission limits within the 76-81 GHz band are expressed in terms of Equivalent Isotropically Radiated Power (EIRP) and are as shown below.

Measurement:

Parameters	
Detector:	RMS / Pos-Peak
Sweep time:	240 s
Resolution bandwidth:	1 MHz
Video bandwidth:	3 MHz
Trace-Mode:	Max Hold
Measurement distance:	1.0 m

Limits:

FCC §95.3367 (a) (b)

Frequency	Measurement distance	Power Density → EIRP
76.0 - 81.0 GHz	3.0 m	88 $\mu\text{W}/\text{cm}^2$ → 50 dBm (Average) 279 $\mu\text{W}/\text{cm}^2$ → 55 dBm (PEAK)

Measurement results:

Mode	Test conditions	Radiated peak power (eirp) [dBm]	Radiated mean power (eirp) / Channel power [dBm]
Normal operation mode	$T_{\text{nom}} / V_{\text{nom}}$	29.8	27.8

Plot 1: Radiated peak power

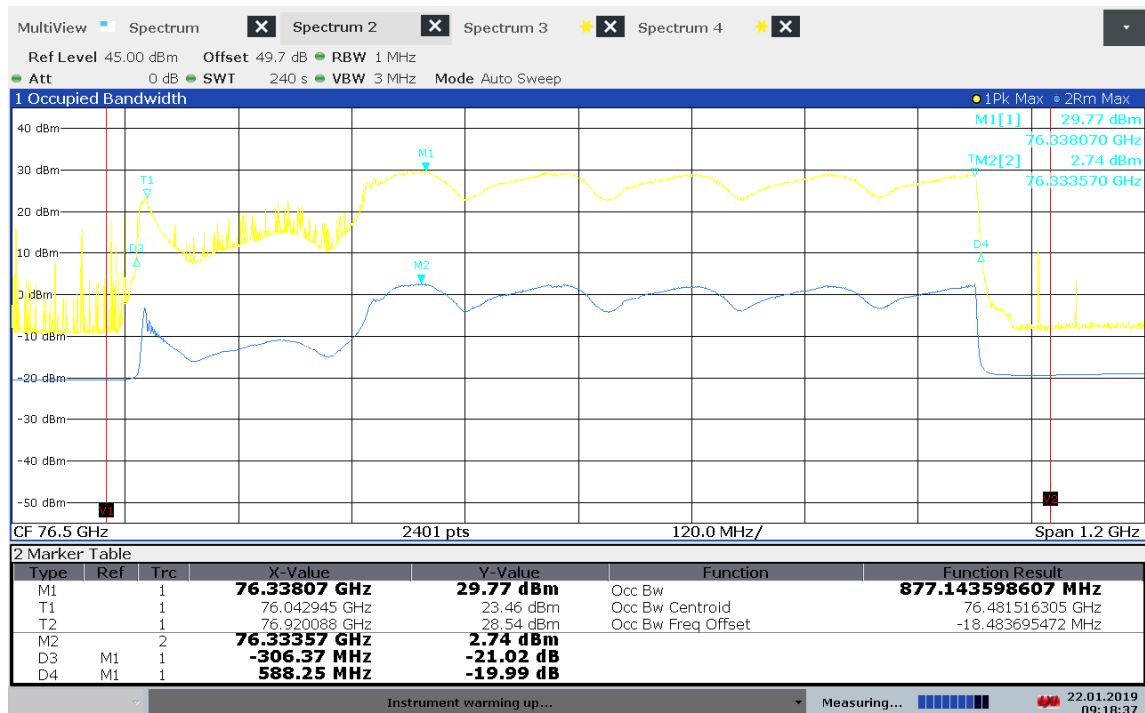

09:18:38 22.01.2019

Plot 2: Radiated mean power

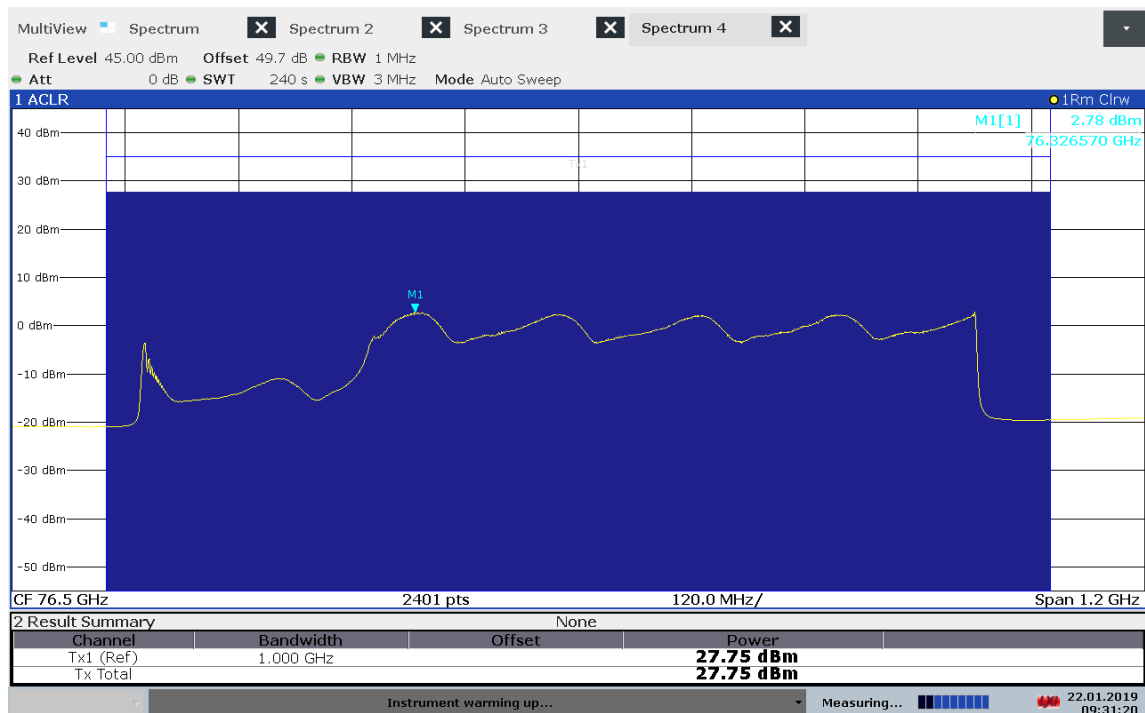

09:31:21 22.01.2019

10.2 Modulation characteristics

Description:

§2.1047 (d) *Other types of equipment.* A curve or equivalent data which shows that the equipment will meet the modulation requirements of the rules under which the equipment is to be licensed.

Comments from manufacturer on modulation characteristics:

Duty Cycle	100 %, Carrier never switched off
Timing	50 ms Frame repetition
Power	30 dBm EIRP
Steepness of Ramps	8.25 MHz/ μ s
Calibration	None

Modulation Type	FMCW
Characteristic	76-77 GHz
Scantype 1	
Sweep Bandwidth	660 MHz
Sweep rate	176.5 μ s
Sweep time	80 μ s

10.3 Occupied bandwidth

Description:

§2.1049 The occupied bandwidth, that is the frequency bandwidth such that, below its lower and above its upper frequency limits, the mean powers radiated are each equal to 0.5 percent of the total mean power radiated by a given emission.

Measurement:

Parameters	
Detector:	Pos-Peak
Sweep time:	240 s
Resolution bandwidth:	1 MHz
Video bandwidth:	3 MHz
Trace-Mode:	Max Hold
Measurement distance:	1.0 m
Measurement uncertainty	Span/1000

Limits:

FCC §95.3379 (b)

Frequency range	f(lowest) > 76.0 GHz	f(highest) < 81.0 GHz
-----------------	----------------------	-----------------------

Measurement results:

Mode	Test conditions	Operating Frequency Range		Bandwidth [MHz]
		f _L [GHz]	f _H [GHz]	
Normal operating mode	T _{nom} / V _{nom}	76.043	76.920	877.1

Plot 3: OBW and 20dB-bandwidth

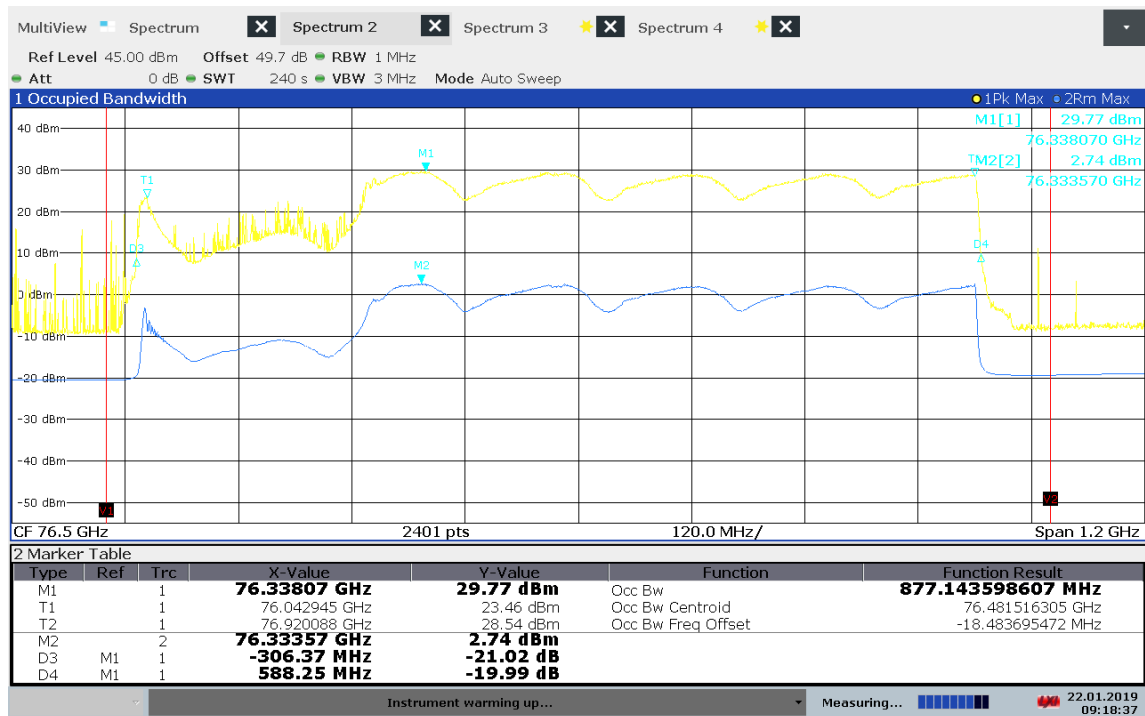

09:18:38 22.01.2019

10.4 Band edge compliance

Description:

Investigation of the emission limits at the band edge.

Measurement:

Parameters	
Detector:	RMS / Pos-Peak
Sweep time:	100 s / 240 s
Resolution bandwidth:	1 MHz
Video bandwidth:	3 MHz
Trace-Mode:	Max Hold
Measurement distance:	1.0 m

Limits:

FCC §95.3379 (a) (2) (i) + (ii) / ANSI C63.10-2013 / 6.10

Frequency Range [GHz]	Measurement distance	Power Density
40 – 200	3.0 m	600 pW/cm ² → -1.7 dBm

Limits:

FCC §95.3379 (b)

Frequency range	f(lowest) > 76.0 GHz	f(highest) < 81.0 GHz
-----------------	----------------------	-----------------------

Measurement results:

See plots below.

Plot 4: Lower BEC

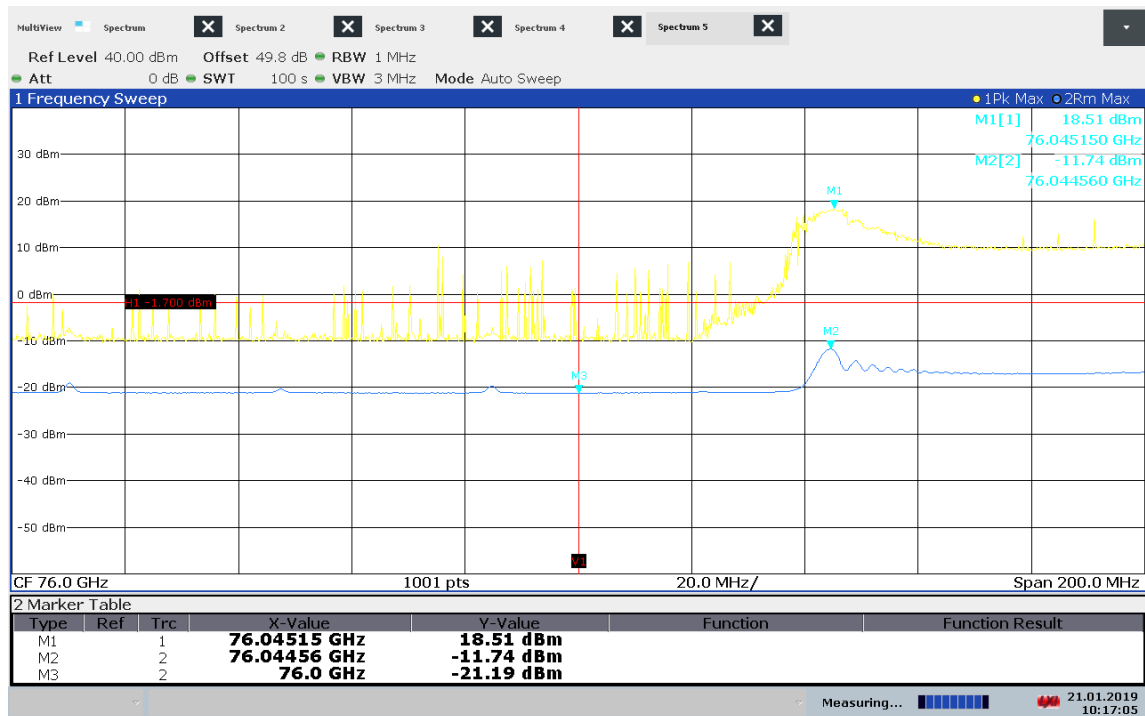

10:17:06 21.01.2019

Plot 5: Upper BEC

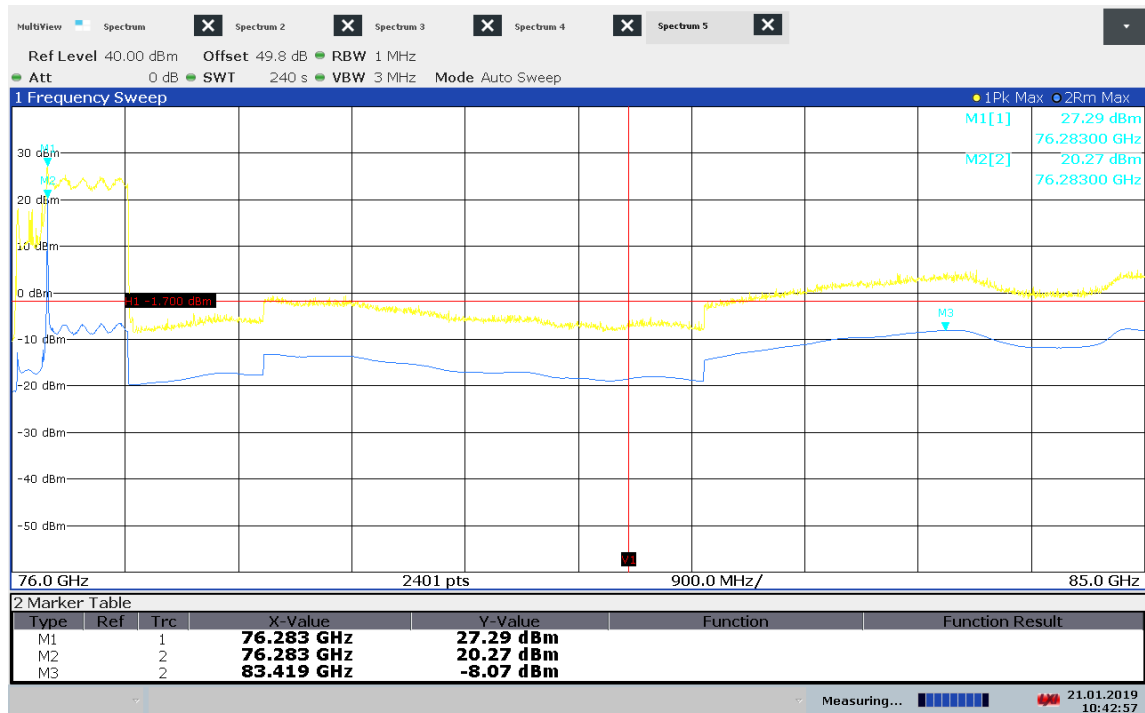

10:42:58 21.01.2019

10.5 Field strength of spurious emissions

Description:

The power density of any emissions outside the 76-81 GHz band shall consist solely of spurious emissions and shall not exceed the following Limits:

Measurement:

Parameters	
Detector:	Pos-Peak / RMS / Quasi-Peak
Sweep time:	Auto
Resolution bandwidth:	1 MHz
Video bandwidth:	3 MHz
Trace-Mode:	Max Hold
Measurement distance:	Auto

Limits:

FCC §95.3379

FCC		
CFR Part 95.3379 (a) (1) / CFR Part 95.3379 (a) (3)		
Radiated Spurious Emissions		
Emissions radiated outside of the specified frequency bands, except for harmonics, shall be attenuated by at least 50 dB below the level of the fundamental or to the general radiated emission limits in § 15.209, whichever is the lesser attenuation.		
Frequency [MHz]	Field Strength [dBµV/m]	Measurement distance
0.009 – 0.490	2400/F[kHz]	300
0.490 – 1.705	24000/F[kHz]	30
1.705 – 30.0	30.0	30
30 – 88	30.0	10
88 – 216	33.5	10
216 – 960	36.0	10
960 – 40 000	54.0	3

Limits:

FCC §95.3379 (a) (2) (i) + (ii)

Frequency Range [GHz]	Measurement distance	Power Density
40 – 200	3.0 m	600 pW/cm ² → -1.7 dBm
200 – 231	3.0 m	1000 pW/cm ² → +0.5 dBm

Measurement results:

F [GHz]	Detector	Level	Limit	Margin [dB]
25.774	Peak	42.9 dB μ V	74.0 dB μ V	31.1
25.791	RMS	30.3 dB μ V	54.0 dB μ V	23.7
38.137	Peak	67.3 dB μ V	74.0 dB μ V	6.7
38.165	RMS	42.8 dB μ V	54.0 dB μ V	11.2
41.893	RMS	-53.2 dBm	-1.7 dBm	51.5
59.635	RMS	-43.2 dBm	-1.7 dBm	41.5
74.301	RMS	-25.6 dBm	-1.7 dBm	23.9
83.419	RMS	-8.1 dBm	-1.7 dBm	6.4
100.347	RMS	-45.7 dBm	-1.7 dBm	44.0
127.158	RMS	-36.5 dBm	-1.7 dBm	34.8
140.040	RMS	-36.6 dBm	-1.7 dBm	34.9
152.781	RMS	-38.7 dBm	-1.7 dBm	37.0
220.346	RMS	-39.3 dBm	-1.7 dBm	37.6

For emissions between 30 MHz and 1 GHz, please refer to plot 8.

Plot 6: 9 kHz – 30 MHz

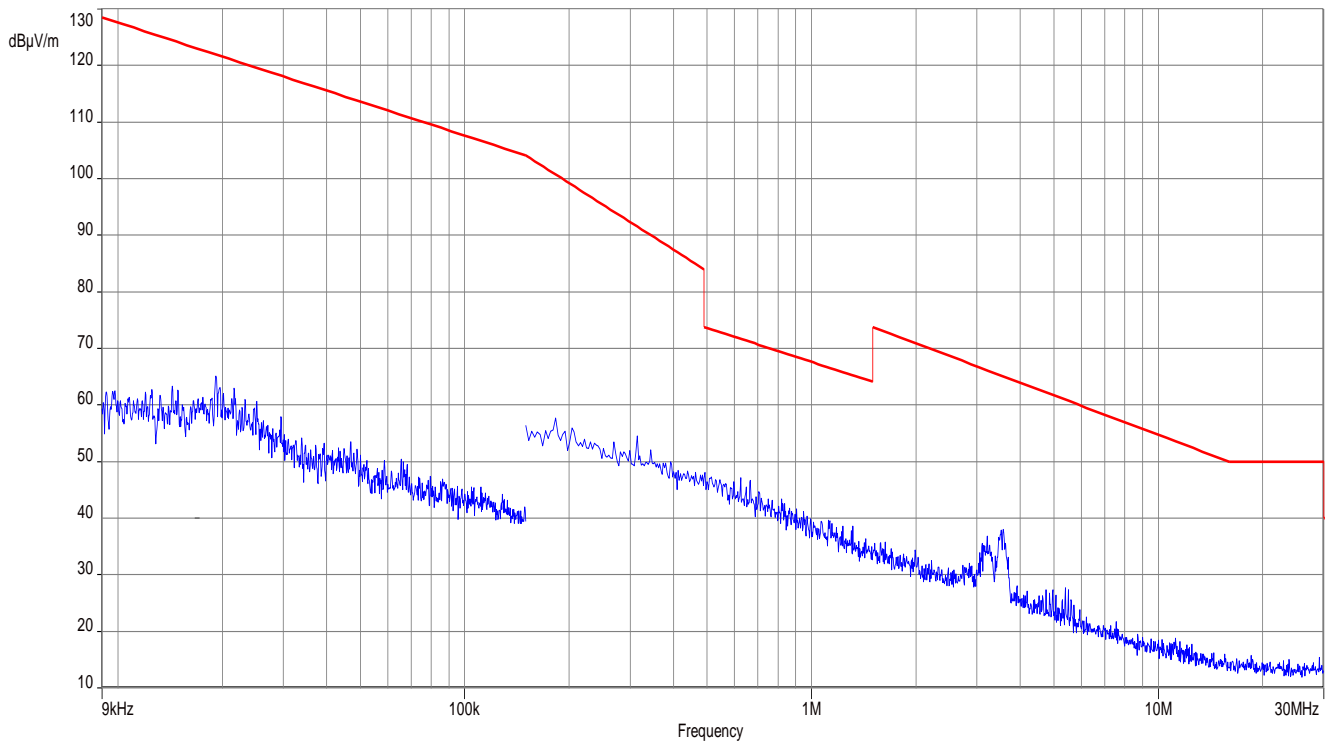

Plot 7: 1 GHz – 18 GHz

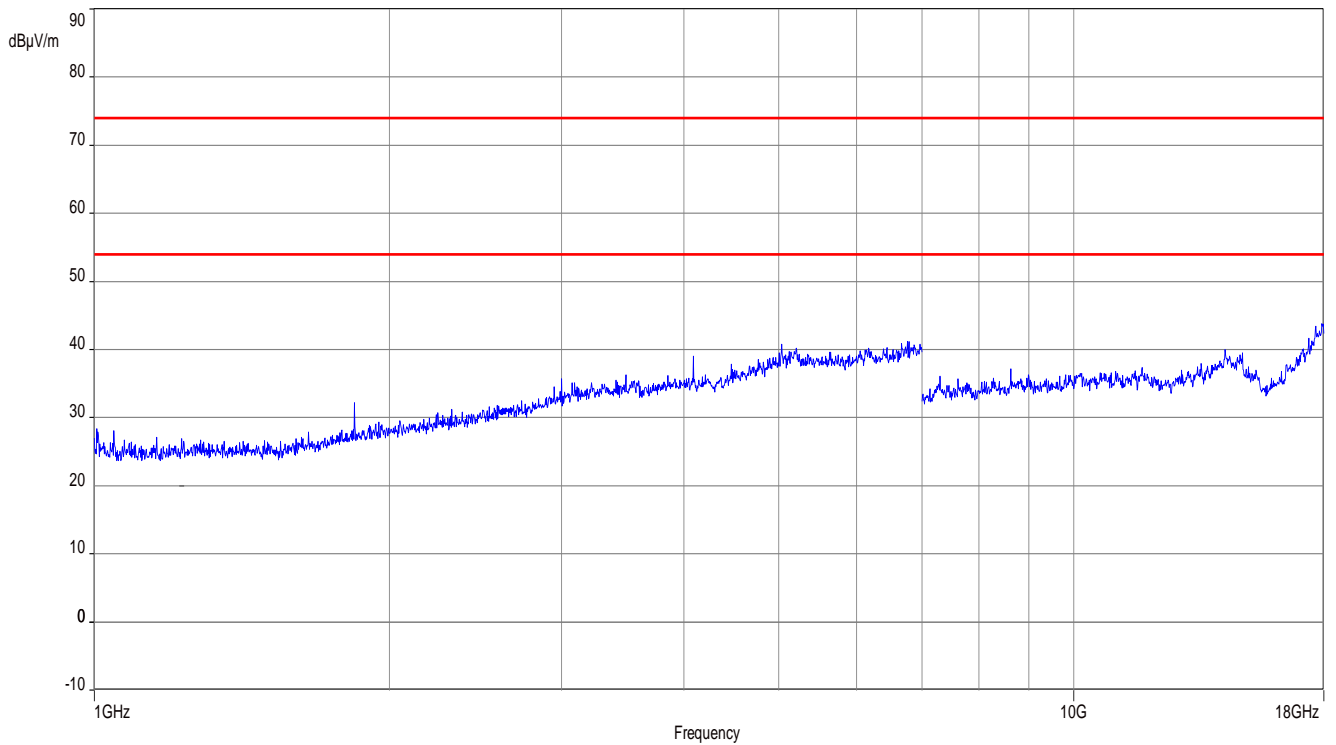

Plot 8: 30 MHz – 1 GHz

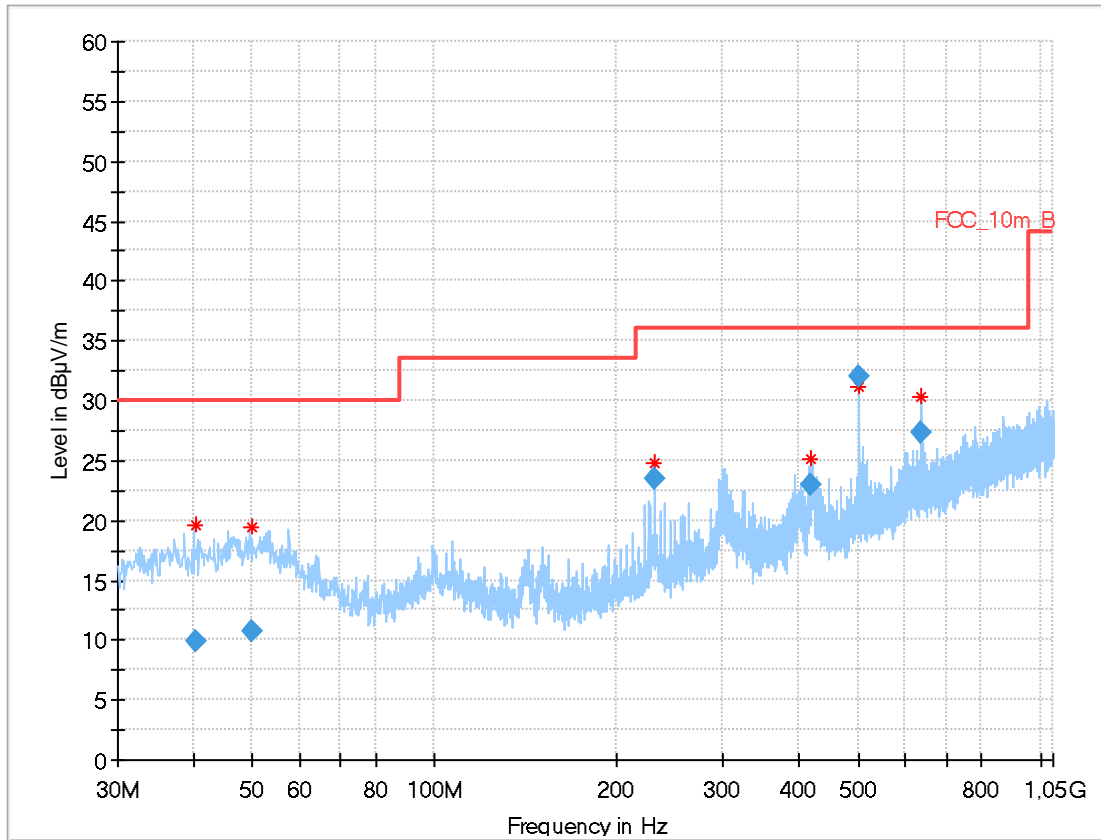

Final_Result

Frequency (MHz)	QuasiPeak (dBµV/m)	Limit (dBµV/m)	Margin (dB)	Meas. Time (ms)	Bandwidth (kHz)	Height (cm)	Pol	Azimuth (deg)	Corr. (dB/m)
40.297	9.90	30.0	20.10	1000	120	172.0	V	90.0	14
50.071	10.68	30.0	19.32	1000	120	200.0	V	20.0	15
231.215	23.43	36.0	12.57	1000	120	400.0	H	225.0	13
418.227	22.93	36.0	13.07	1000	120	100.0	V	1.0	17
499.998	32.07	36.0	3.93	1000	120	100.0	V	25.0	18
636.731	27.35	36.0	8.65	1000	120	271.0	V	252.0	21

Plot 9: 18 GHz – 26.5 GHz

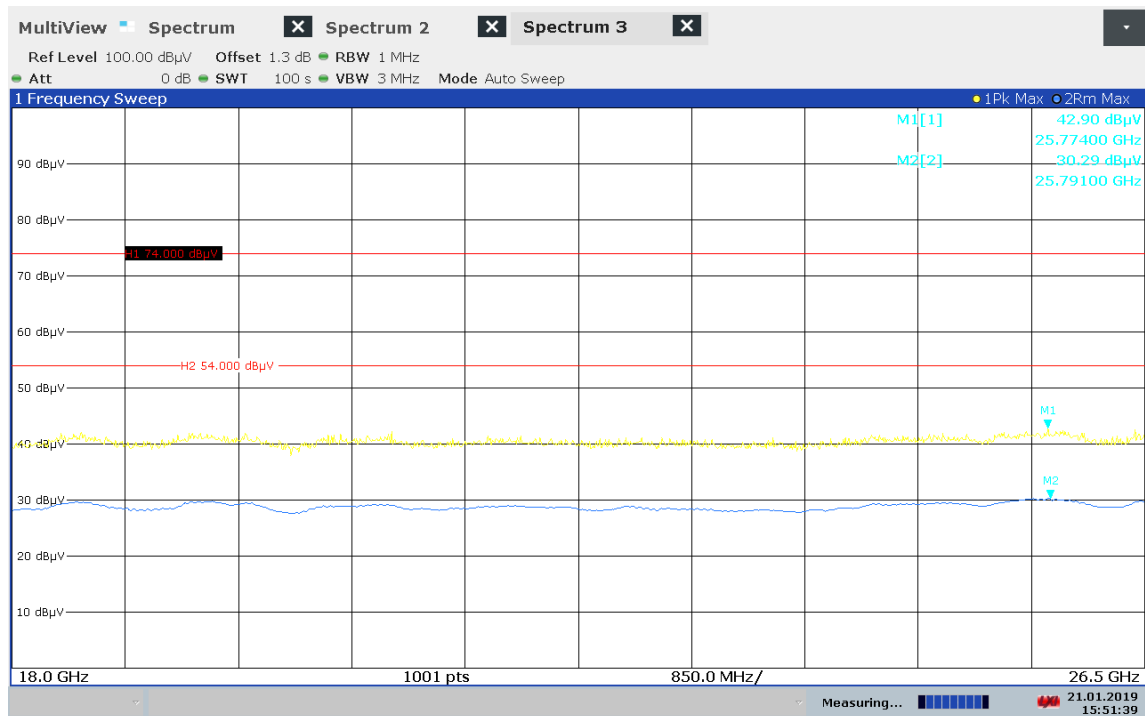

15:51:40 21.01.2019

Plot 10: 26.5 GHz – 40 GHz

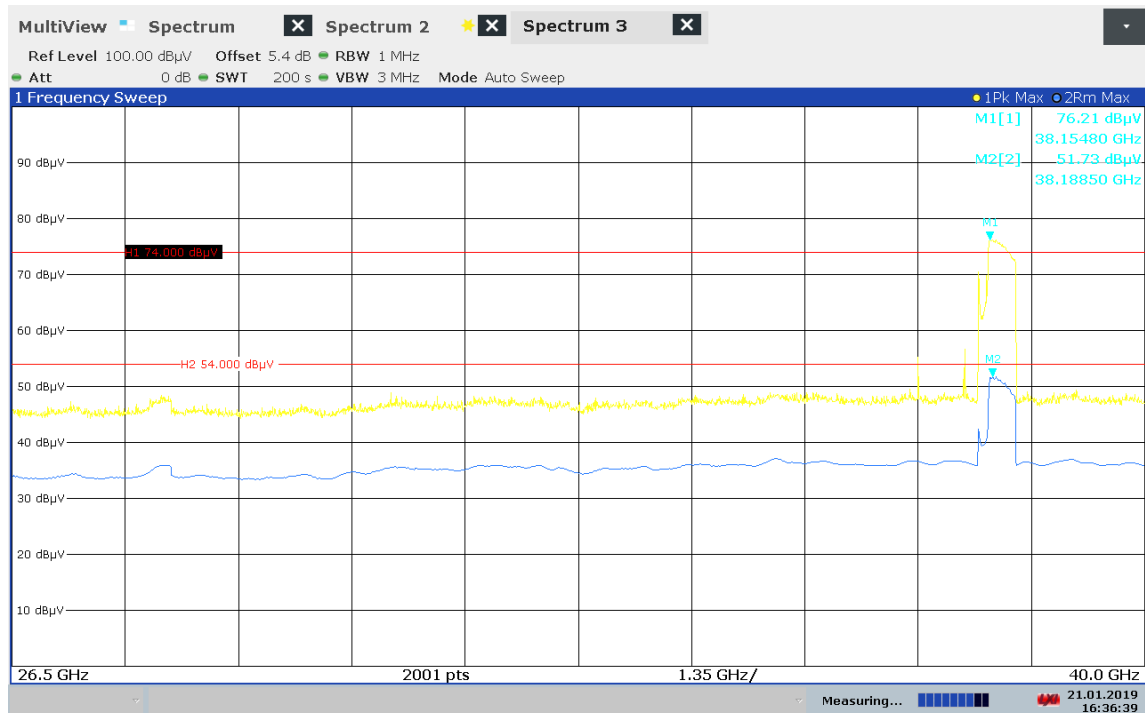

16:36:39 21.01.2019

Plot 11: 40 GHz – 50 GHz

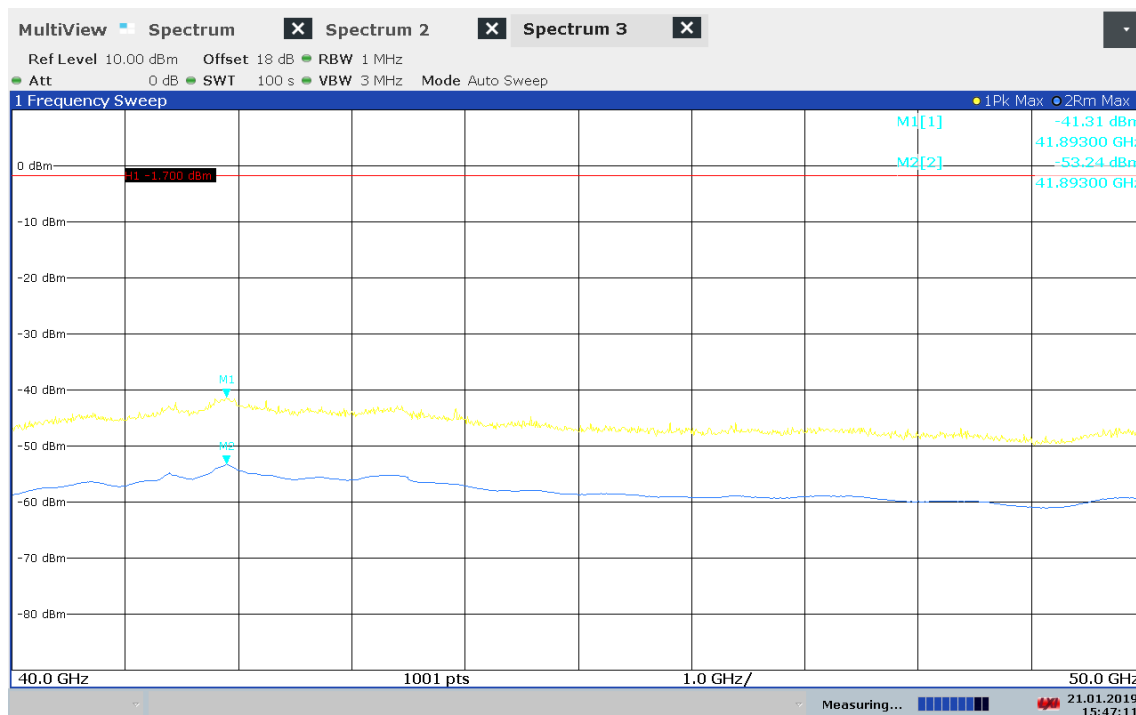

Plot 12: 50 GHz – 60 GHz

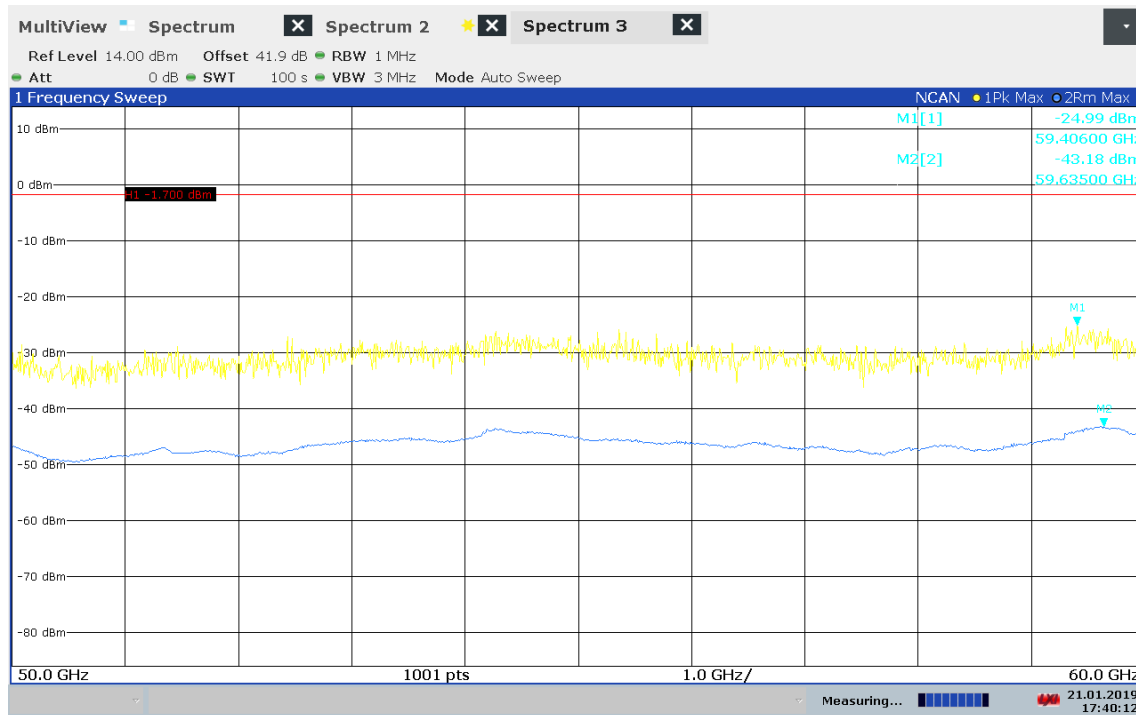

Plot 13: 60 GHz – 76 GHz

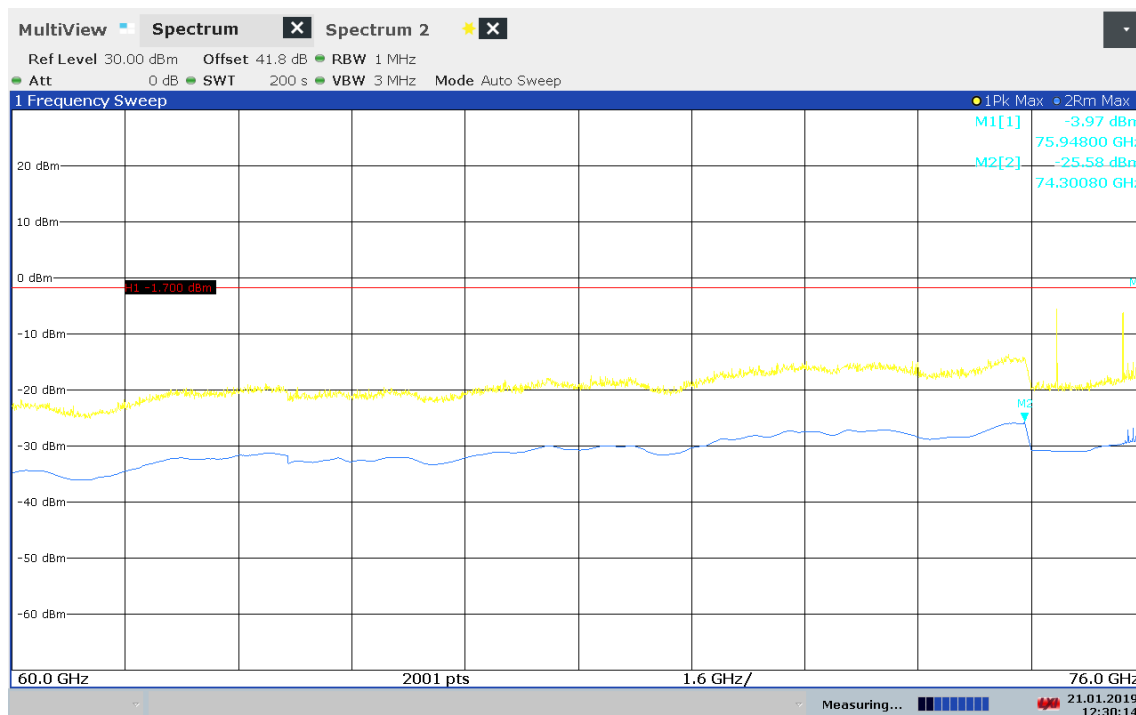

12:30:14 21.01.2019

Plot 14: 76 GHz – 85 GHz

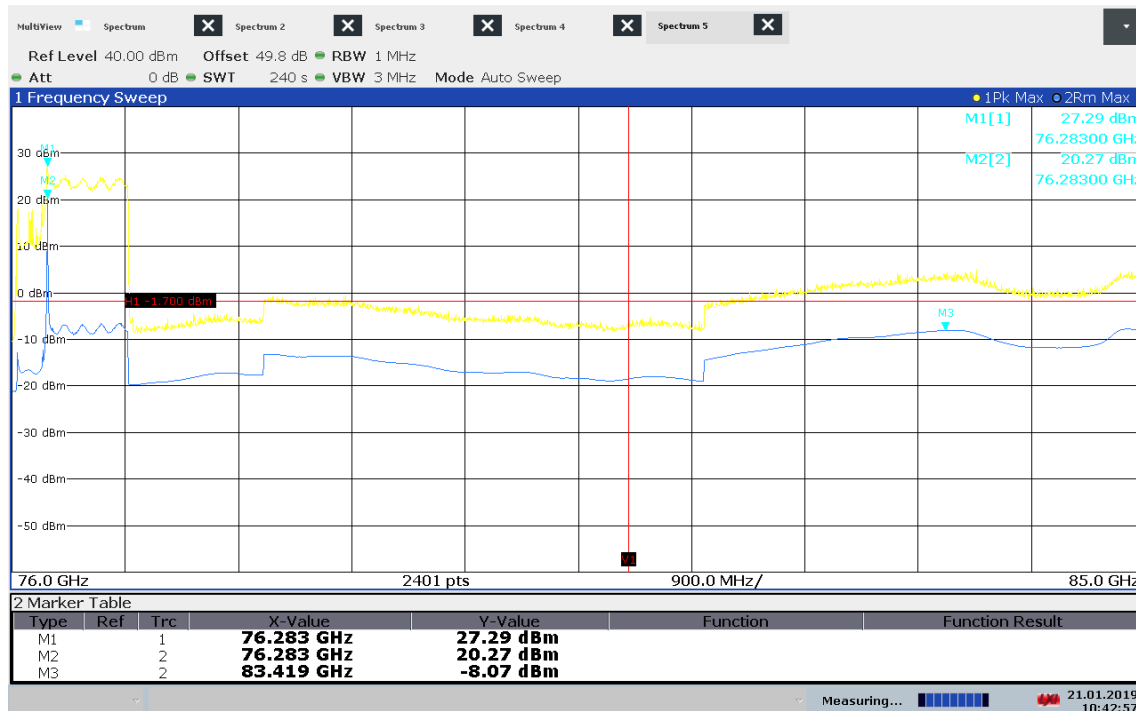

10:42:58 21.01.2019

Plot 15: 85 GHz – 110 GHz

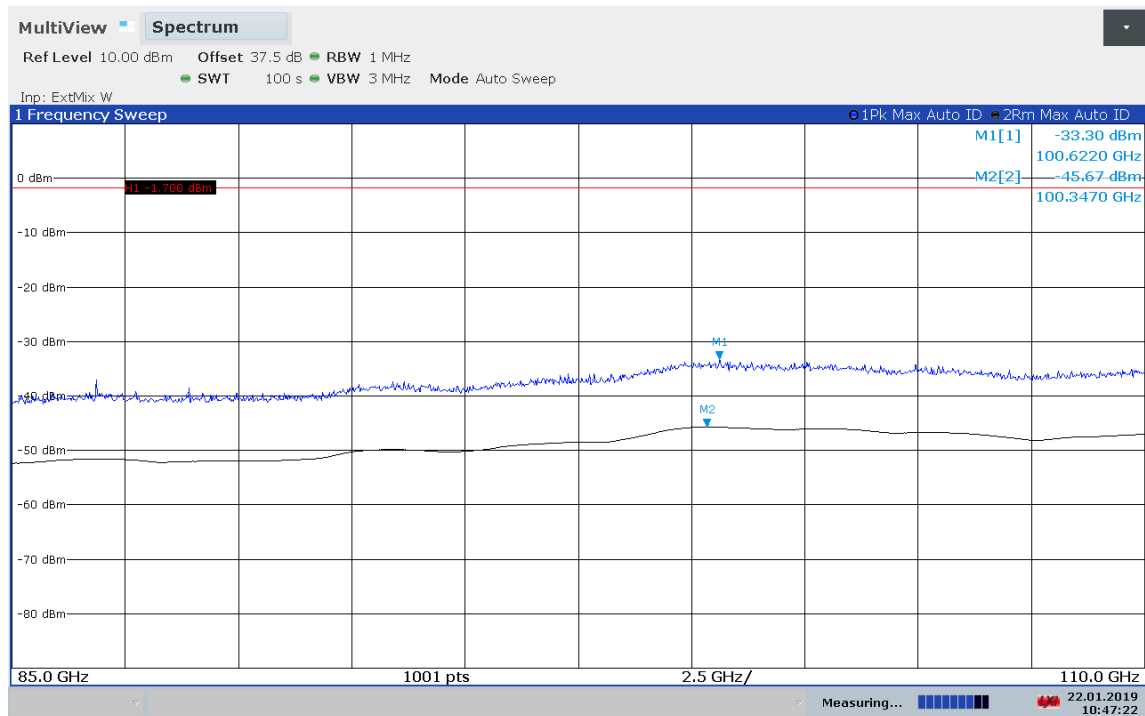

10:47:22 22.01.2019

Plot 16: 110 GHz – 140 GHz

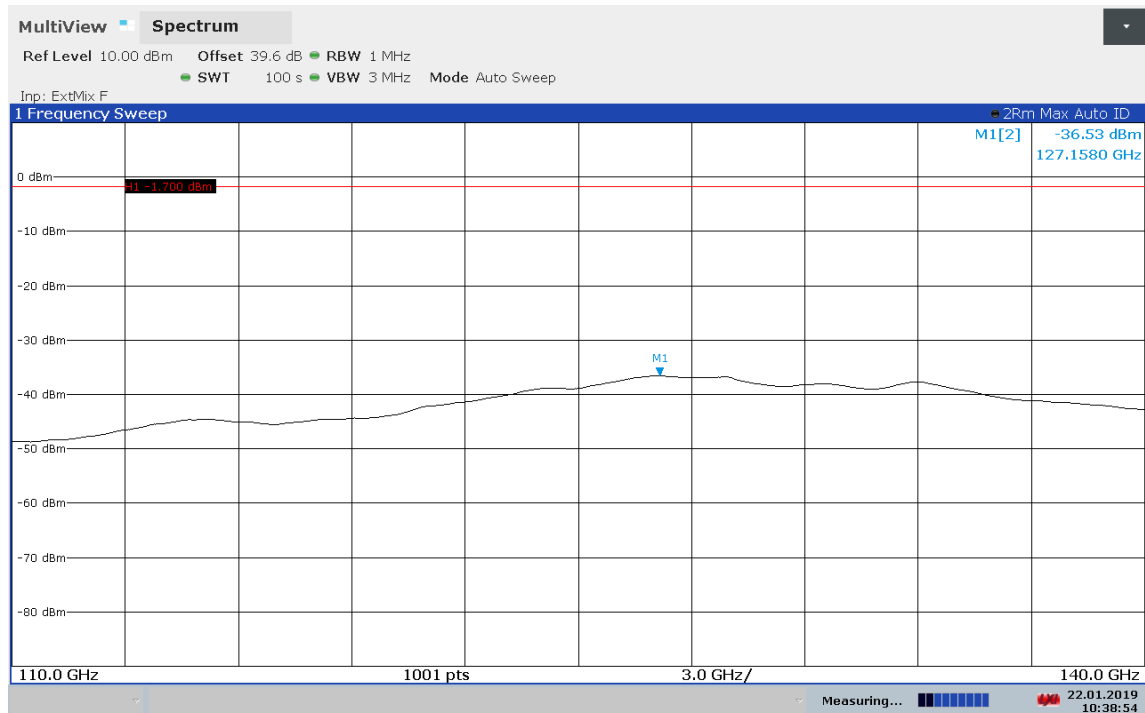

10:38:54 22.01.2019

Plot 17: 140 GHz – 220 GHz

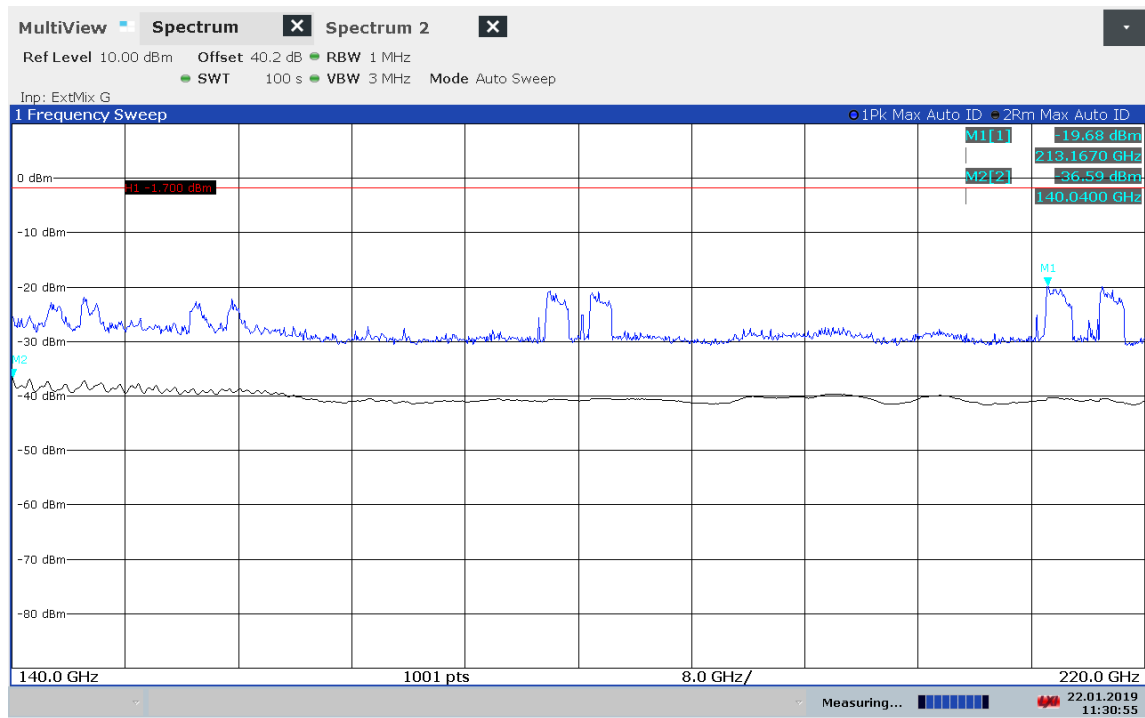

11:30:55 22.01.2019

Note: Plot shows mixing products generated by the harmonic mixer

Plot 18: 220 GHz – 231 GHz

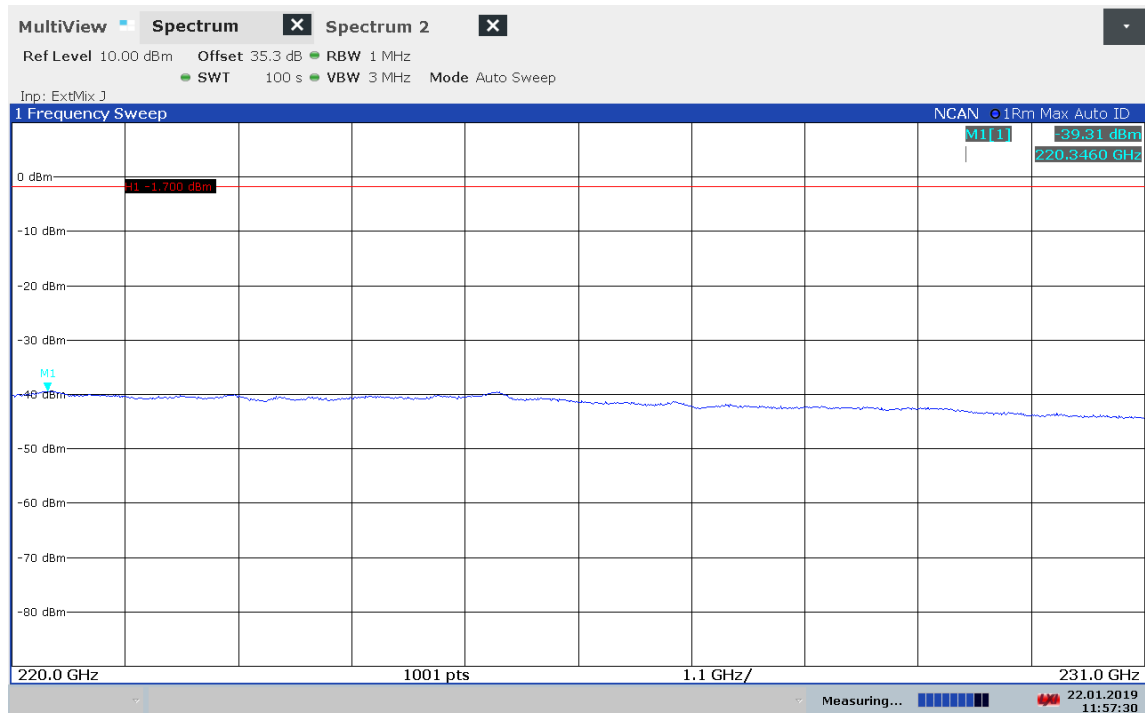

11:57:30 22.01.2019

Plot 19: Final measurement 38.25 GHz

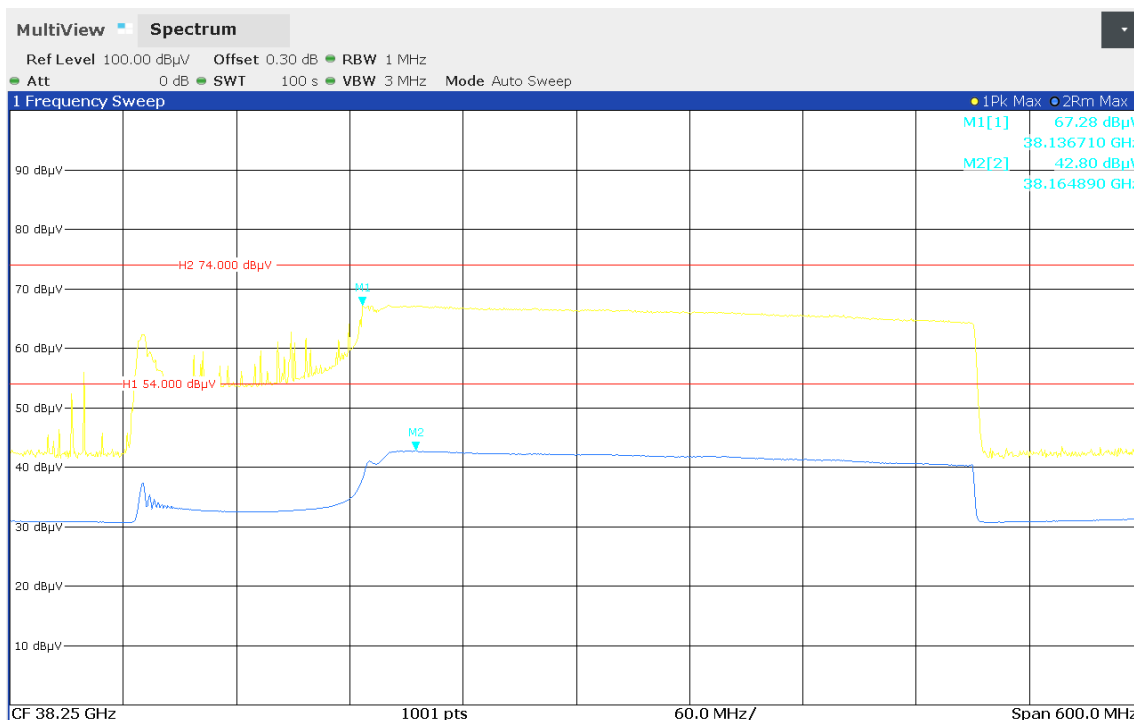

14:28:31 28.03.2019

Plot 20: Final measurement 153.1 GHz

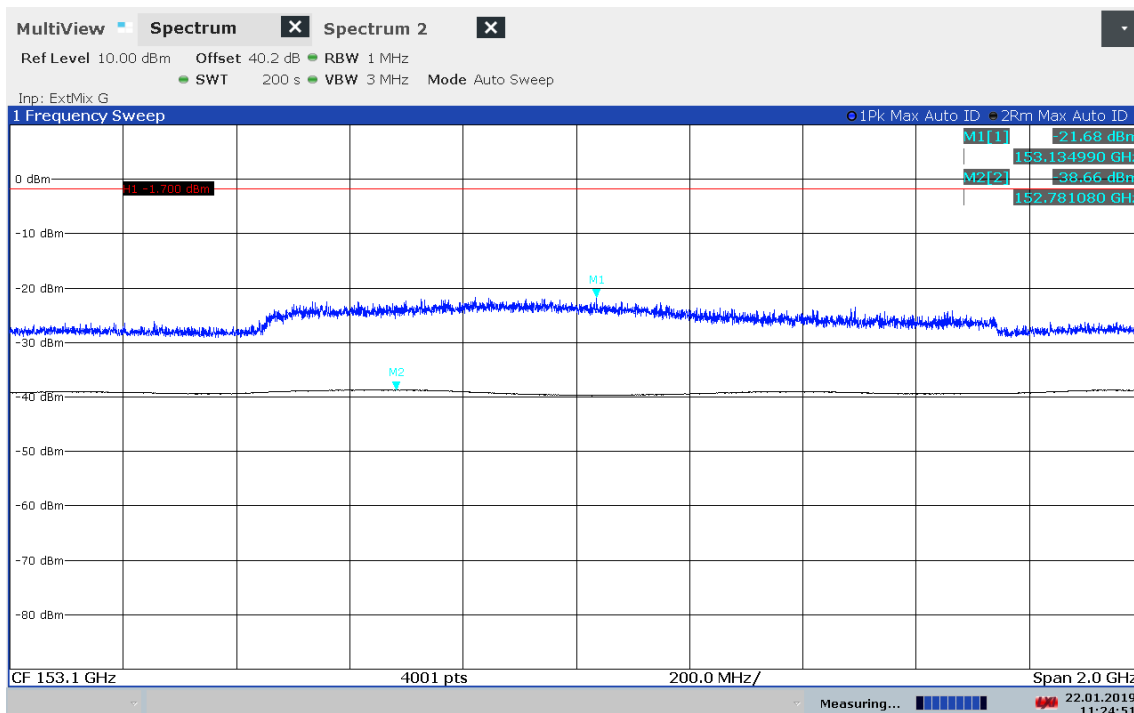

11:24:51 22.01.2019

10.6 Frequency stability

Description:

§95.3379 (b) Fundamental emissions must be contained within the frequency bands specified in this section during all conditions of operation. Equipment is presumed to operate over the temperature range -20 to +50 degrees Celsius with an input voltage variation of 85% to 115% of rated input voltage, unless justification is presented to demonstrate otherwise.

Limits:

FCC §95.3379 (b) / §2.1055

Frequency range	f(lowest) > 76.0 GHz	f(highest) < 81.0 GHz
-----------------	----------------------	-----------------------

Measurement results:

Temperature variation

Mode	Temperature in °C	f _L in GHz	f _H in GHz
Normal operation mode	-40	76.058	76.921
	-30	76.044	76.921
	-20	76.035	76.921
	-10	76.035	76.921
	0	76.038	76.920
	10	76.042	76.919
	20	76.045	76.919
	30	76.047	76.918
	40	76.046	76.918
	50	76.043	76.919
	85	76.046	76.923

Voltage variation

Voltage variation of rated input voltage	f _L in GHz	f _H in GHz
< 85 % of U	Voltage variation does not affect the radiated signal (see plot 27)	
> 115 % of U		

Plot 21: OBW -40 °C

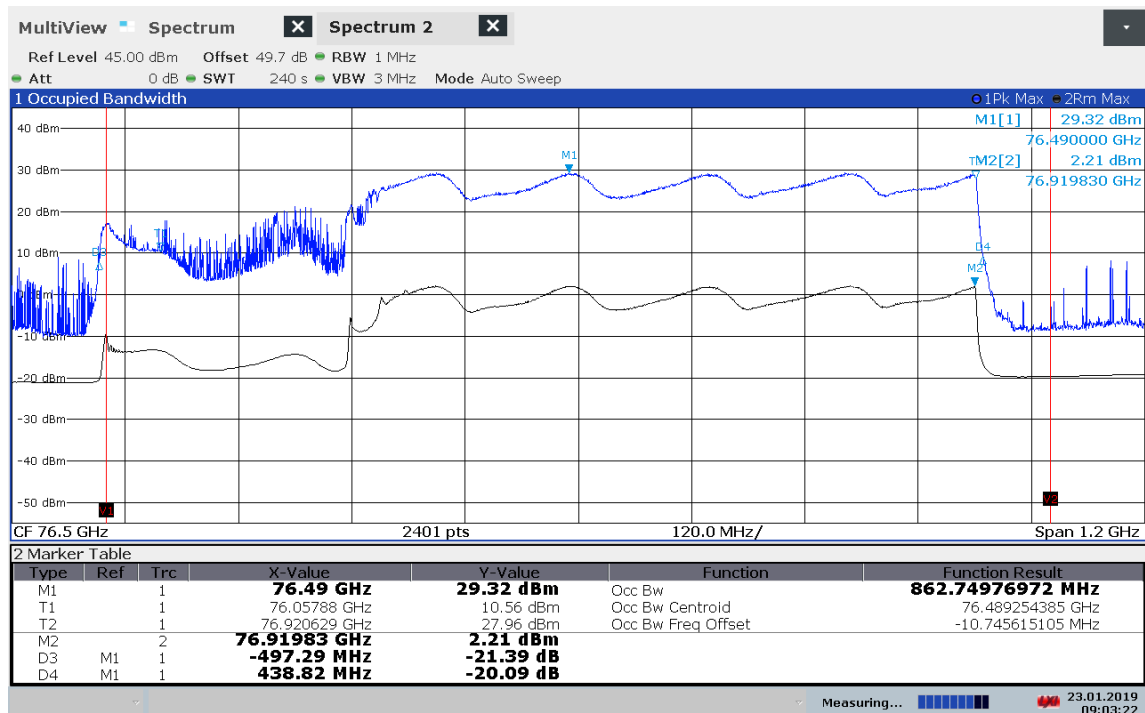

09:03:23 23.01.2019

Plot 22: OBW -30 °C

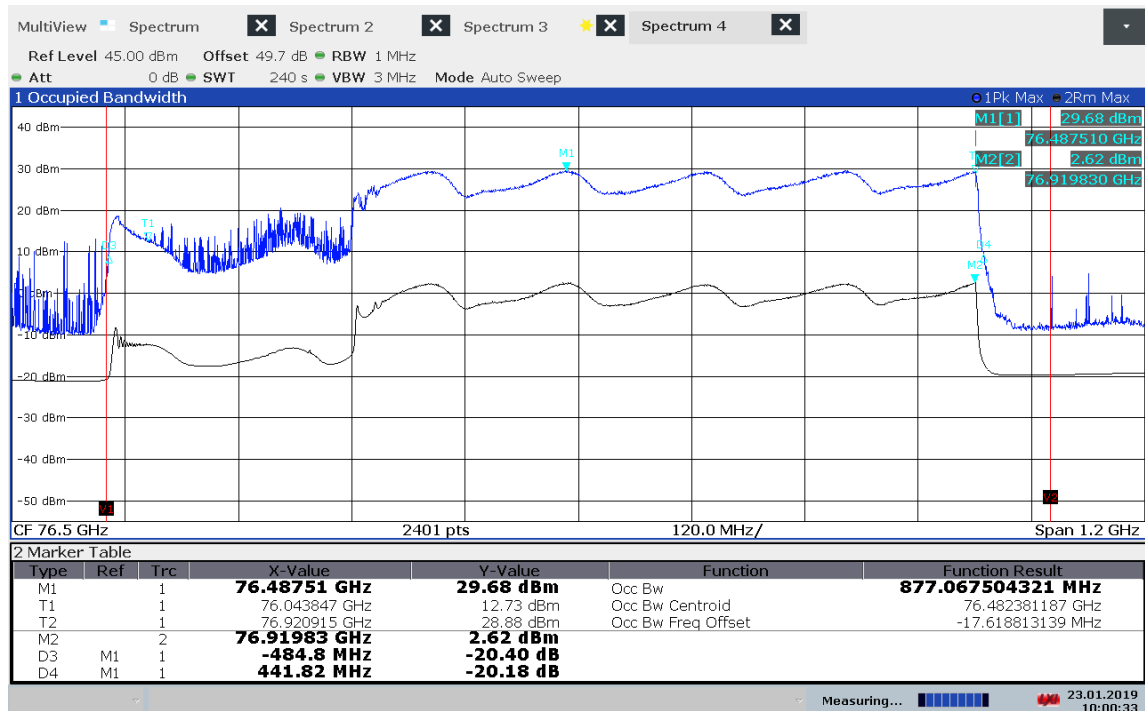

10:00:34 23.01.2019

Plot 23: OBW -20 °C

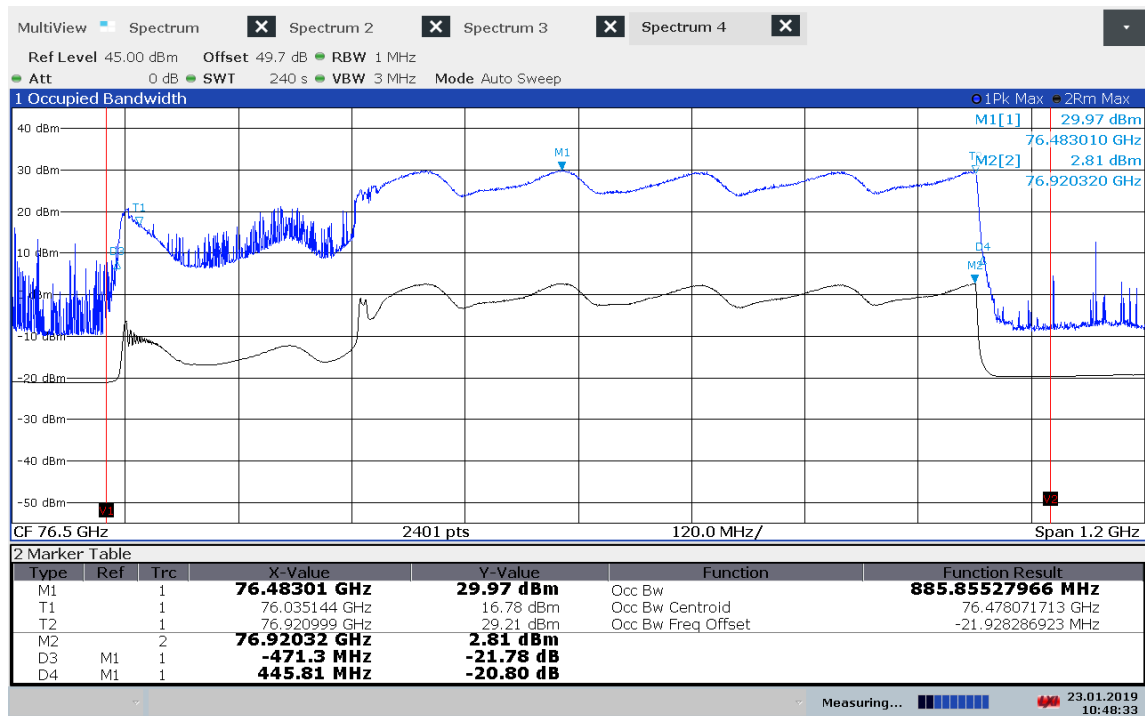

10:48:33 23.01.2019

Plot 24: OBW -10 °C

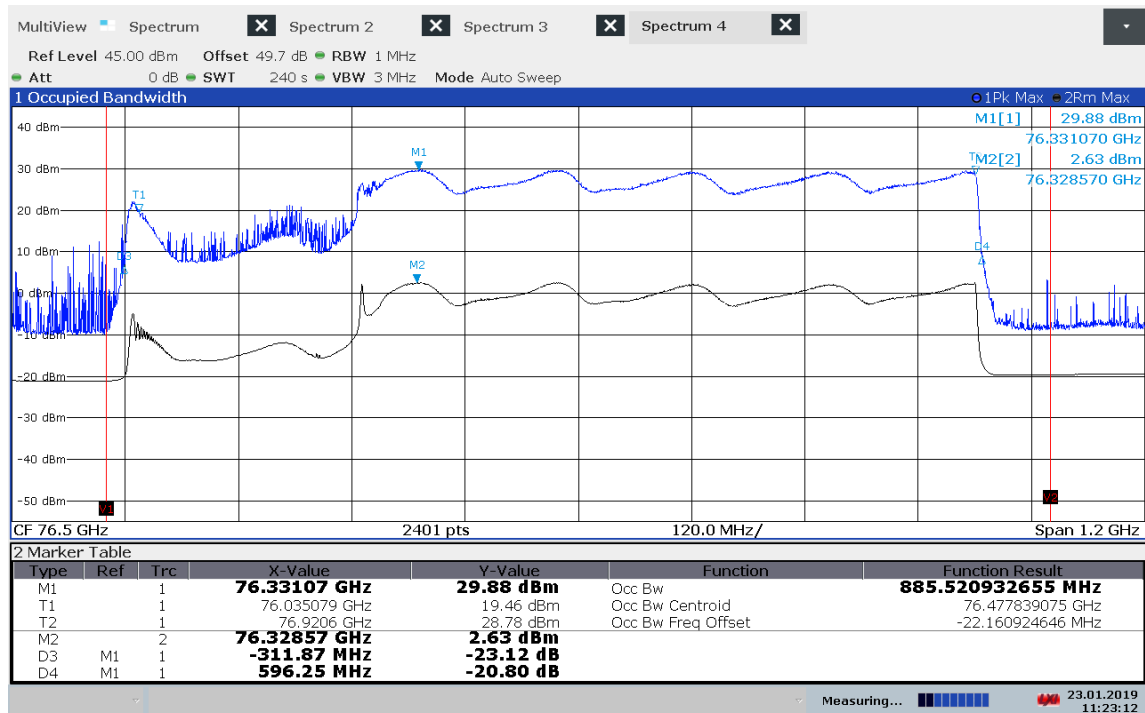

11:23:13 23.01.2019

Plot 25: OBW 0 °C

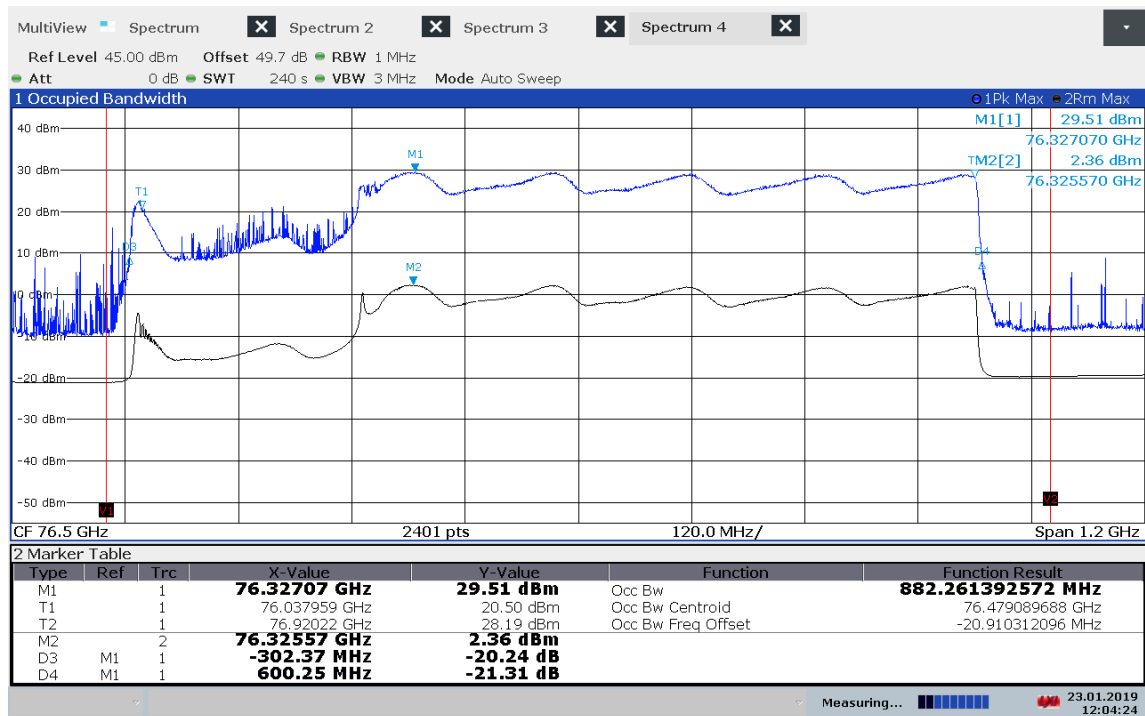

12:04:24 23.01.2019

Plot 26: OBW 10 °C



12:37:11 23.01.2019

Plot 27: OBW 20 °C



14:09:07 23.01.2019

Plot 28: OBW 30 °C

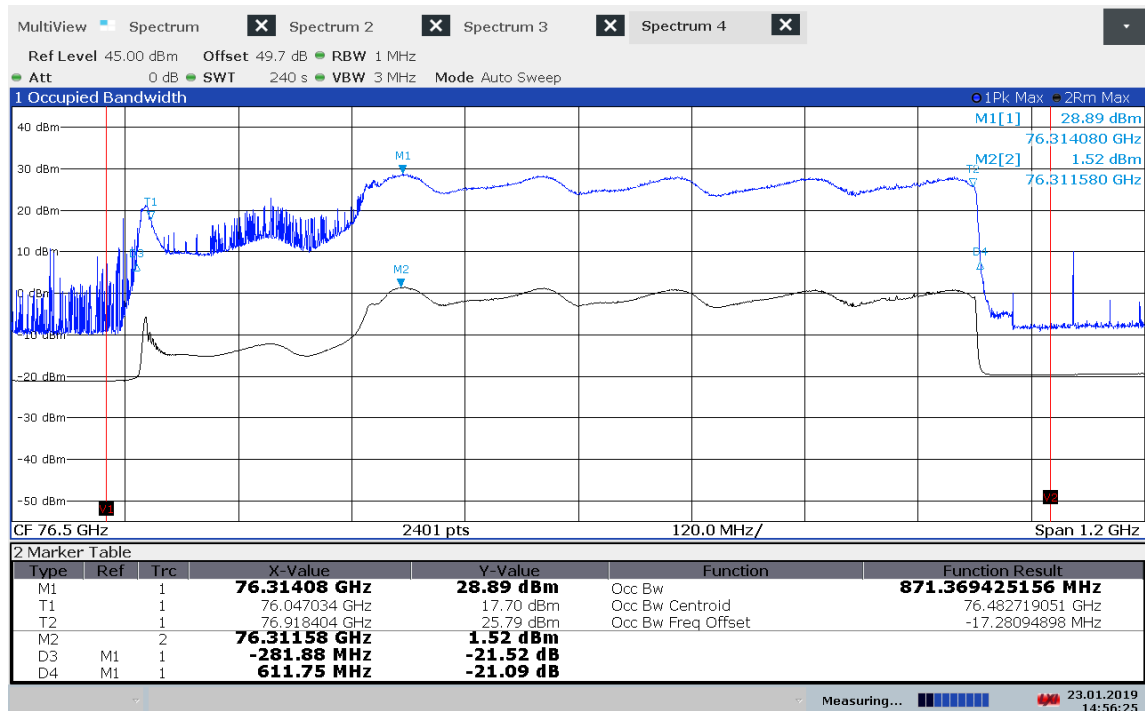

14:56:25 23.01.2019

Plot 29: OBW 40 °C

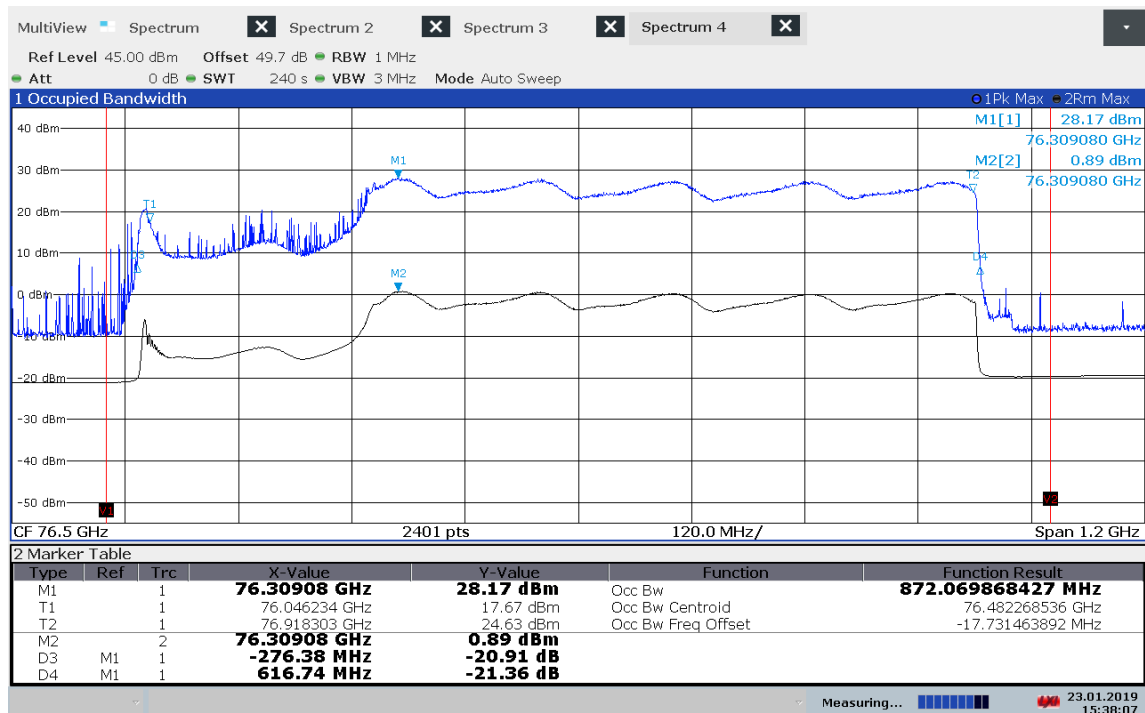

15:38:08 23.01.2019

Plot 30: OBW 50 °C

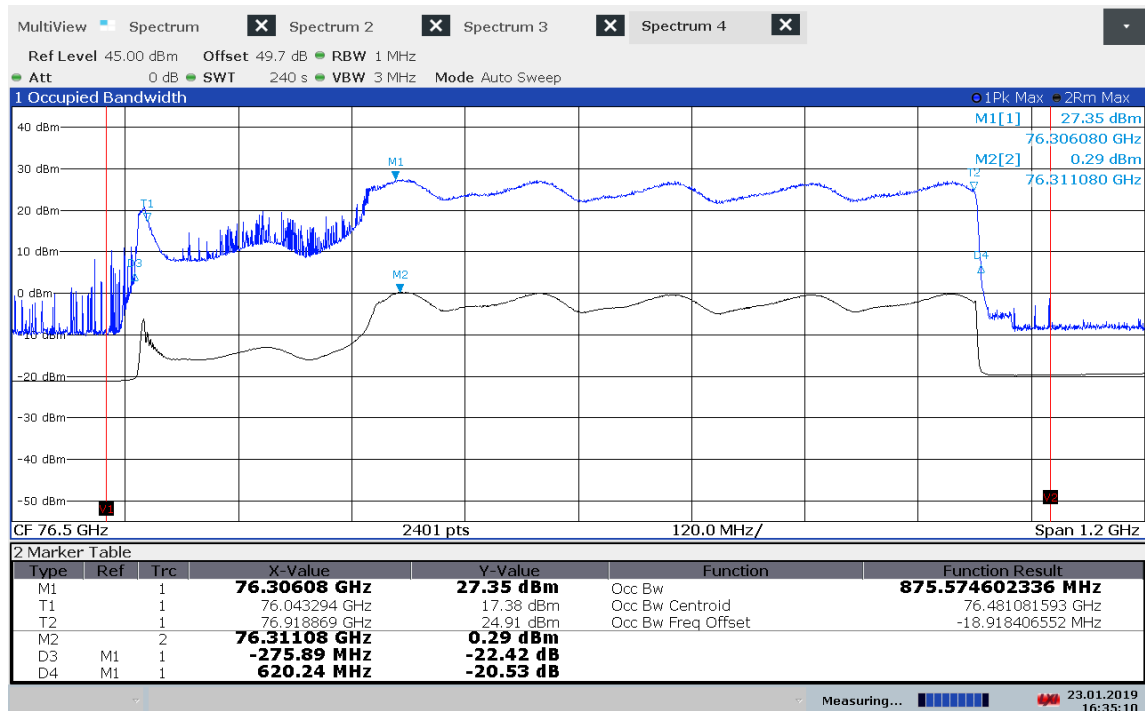

16:35:10 23.01.2019

Plot 31: OBW 85 °C

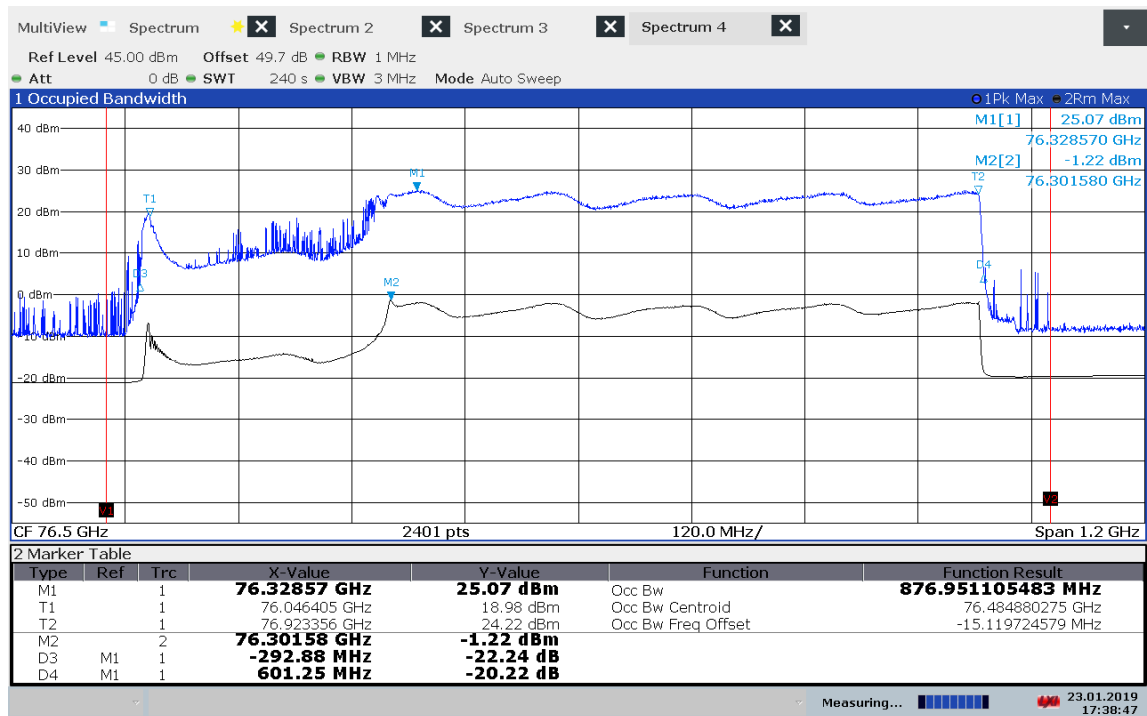

17:38:47 23.01.2019

11 Observations

No observations except those reported with the single test cases have been made.

12 Glossary

EUT	Equipment under test
DUT	Device under test
UUT	Unit under test
GUE	GNSS User Equipment
FCC	Federal Communications Commission
FCC ID	Company Identifier at FCC
IC	Industry Canada
PMN	Product marketing name
HMN	Host marketing name
HVIN	Hardware version identification number
FVIN	Firmware version identification number
EMC	Electromagnetic Compatibility
HW	Hardware
SW	Software
Inv. No.	Inventory number
S/N or SN	Serial number
C	Compliant
NC	Not compliant
NA	Not applicable
NP	Not performed
PP	Positive peak
QP	Quasi peak
AVG	Average
OC	Operating channel
OCW	Operating channel bandwidth
OBW	Occupied bandwidth
OOB	Out of band
DFS	Dynamic frequency selection
CAC	Channel availability check
OP	Occupancy period
NOP	Non occupancy period
DC	Duty cycle
PER	Packet error rate
CW	Clean wave
MC	Modulated carrier
DSSS	Dynamic sequence spread spectrum
OFDM	Orthogonal frequency division multiplexing
FHSS	Frequency hopping spread spectrum
GNSS	Global Navigation Satellite System
C/N₀	Carrier to noise-density ratio, expressed in dB-Hz

13 Document history

Version	Applied changes	Date of release
-/-	Initial release - DRAFT	2019-03-28
-/-	Editorial changes	2019-05-06
-A	Editorial changes / type identification name	2019-08-07
-B	Editorial changes based on TCB's remarks / Replace 20 dB bandwidth with 99 % bandwidth	2019-08-14

14 Accreditation Certificate

first page	last page
 <p>Deutsche Akkreditierungsstelle GmbH</p> <p>Entrusted according to Section 8 subsection 1 AkkStelleG in connection with Section 1 subsection 1 AkkStelleGBV Signatory to the Multilateral Agreements of EA, ILAC and IAF for Mutual Recognition</p> <p>Accreditation </p> <p>The Deutsche Akkreditierungsstelle GmbH attests that the testing laboratory CTC advanced GmbH Untertürkheimer Straße 6-10, 66117 Saarbrücken</p> <p>is competent under the terms of DIN EN ISO/IEC 17025:2005 to carry out tests in the following fields: Telecommunication</p> <p>The accreditation certificate shall only apply in connection with the notice of accreditation of 02.06.2017 with the accreditation number D-PL-12076-01 and is valid until 21.04.2021. It comprises the cover sheet, the reverse side of the cover sheet and the following annex with a total of 43 pages.</p> <p>Registration number of the certificate: D-PL-12076-01-03</p> <p>Frankfurt, 02.06.2017</p> <p> Dipl.-Ing. (FH) Ralf Böker Head of Division</p> <p>See notes cover/af.</p>	<p>Deutsche Akkreditierungsstelle GmbH</p> <p>Office Berlin Spittelmarkt 10 10117 Berlin</p> <p>Office Frankfurt am Main Europa-Allee 52 60327 Frankfurt am Main</p> <p>Office Braunschweig Bundesallee 100 38116 Braunschweig</p> <p>The publication of extracts of the accreditation certificate is subject to the prior written approval by Deutsche Akkreditierungsstelle GmbH (DAkKS). Exempted is the unchanged form of separate disseminations of the cover sheet by the conformity assessment body mentioned overleaf.</p> <p>No impression shall be made that the accreditation also extends to fields beyond the scope of accreditation attested by DAkKS.</p> <p>The accreditation was granted pursuant to the Act on the Accreditation Body (AkkStelleG) of 31 July 2009 (Federal Law Gazette I p. 2625) and the Regulation (EC) No 765/2008 of the European Parliament and of the Council of 9 July 2008 setting out the requirements for accreditation and market surveillance relating to the marketing of products (Official Journal of the European Union L 218 of 9 July 2008, p. 30). DAkKS is a signatory to the Multilateral Agreements for Mutual Recognition of the European co-operation for Accreditation (EA), International Accreditation Forum (IAF) and International Laboratory Accreditation Cooperation (ILAC). The signatories to these agreements recognise each other's accreditations.</p> <p>The up-to-date state of membership can be retrieved from the following websites: EA: www.european-accreditation.org ILAC: www.ilac.org IAF: www.iaf.eu</p>

Note: The current certificate annex is published on the website (link see below) of the Accreditation Body DAkKS or may be received by CTC advanced GmbH on request

<https://www.dakks.de/as/ast/d/D-PL-12076-01-03.pdf>

END OF TEST REPORT