

# DATA SHEET

## K-LD2

radar transceiver

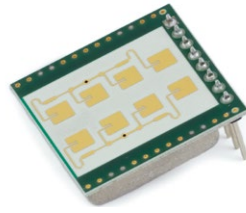

### Features

- Small and low cost digital 24 GHz radar motion detector
- Detection distance up to 15m (human) 30m (cars)
- High immunity against interferences
- Integrated FFT signal processing with digital outputs
- Sensitivity and hold time can be set using analogue inputs
- Advanced detection data read-out over serial interface
- Wide power supply range from 3.2 to 5.5V
- 2 x 4 patch antenna with 80°/34° beam aperture

### Applications

- General movement detection applications
- Door opener
- Illumination of advertising boards
- Touch free switches
- Security systems
- Indoor and outdoor lighting control applications
- Object speed measurement systems
- Industrial sensors

### Description

The K-LD2 is a fully digital and low cost radar movement detector. The digital structure makes it very easy to use in any stand-alone or MCU based application where a movement detection or speed measurement is required.

The sensor includes a 2 x 4 patch radar front-end with an asymmetrical beam and a powerful signal processing unit with two digital outputs for signal detection information. The sensitivity and the hold time are adjustable using analogue inputs with potentiometers. The serial interface features a powerful command set to read-out advanced detection data or to fully customize the detection algorithm.

There is no need to write own signal processing algorithms or handle small and noisy signals. This module contains everything that is necessary to build a simple, yet reliable movement detector.

A very small footprint of 25 x 25 x 6.5 mm gives maximum flexibility in the product development process.

A powerful evaluation kit (K-LD2-EVAL) with signal visualization on a PC is available.

### Block Diagram

**Figure 1: K-LD2 block diagram**

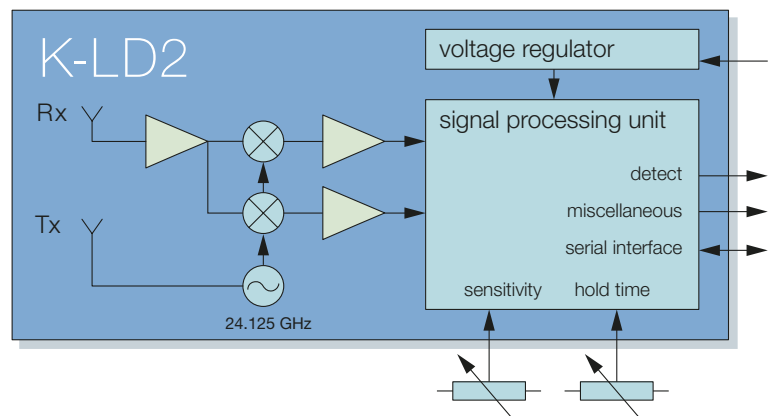

# CHARACTERISTICS

Parameter                      Conditions/Notes                      Symbol    Min    Typ    Max    Unit

## Operating Conditions

Supply voltage		$V_{cc}$	3.2		5.5	V
RMS current		$I_{RMS}$		55		mA
Peak current		$I_{peak}$		65		mA
Operating temperature		$T_{op}$	-20		+85	°C
Storage temperature		$T_{st}$	-20		+105	°C
Relative humidity	Non-condensing, given by design	RH	10		90	%

## Transmitter

Transmitter frequency	$T_{amb} = -20\text{ °C} \dots +85\text{ °C}$	$f_{TX}$	24.050		24.250	GHz
Frequency drift vs temperature	$V_{cc} = 3.3\text{ V}$	$\Delta f_{TX}$		0.06		MHz/°C
Output power	EIRP	$P_{TX}$		+12		dBm
Spurious emission	According to ETSI 300 440	$P_{Spur}$			-30	dBm

## Receiver

LNA gain		$G_{LNA}$		20		dB
Mixer Conversion loss	$f_{IF} = 1\text{ kHz}$	$D_{mixer}$		6		dB
Antenna gain	$f_{TX} = 24.125\text{ GHz}$	$G_{Ant}$		8.6		dBi
Receiver sensitivity	$f_{IF} = 500\text{ Hz}$ , $B = 1\text{ kHz}$ , $S/N = 6\text{ dB}$	$P_{RX}$		-112		dBm
Overall sensitivity	$f_{IF} = 500\text{ Hz}$ , $B = 1\text{ kHz}$ , $S/N = 6\text{ dB}$	$D_{system}$		-127		dBc
Max. Detection distance	$\sigma = 1\text{ m}^2$ (Person )	R			20	m

## Signal Processing

Modulation				none		
Velocity processing				256 point FFT		
Sample rate		$f_{sample}$	1.28		12.8	kHz
Speed range	Depending on sampling frequency	$r_{speed}$	0		143	km/h
Response time	Depending on sampling frequency and FFT average feature	$t_{detect}$	20		400	ms

## Antenna

Horizontal -3dB beamwidth	E-Plane	$W_{\phi}$		80		°
Vertical -3dB beamwidth	H-Plane	$W_{\theta}$		34		°
Horiz. Sidelobe suppression		$D_{\phi}$	-12	-20		dB
Vertical sidelobe suppression		$D_{\theta}$	-12	-20		dB

## Interface

Digital Output high level voltage		$V_{OH}$	2.1	2.6		V
Digital Output low level voltage		$V_{OL}$		0.3	0.64	V
Digital Input high level voltage		$V_{IH}$	2.0		3.3	V
Digital Input low level voltage		$V_{IL}$	-0.3		0.8	V
Digital I/O source/sink current		$I_{OH}, I_{OL}$	-20		20	mA
Analogue Input level		$V_{Ain}$	0		3	V
Analogue Input impedance		$Z_{in}$		200		k $\Omega$

## Body

Outline Dimensions				25 × 25 × 6.5		mm <sup>3</sup>
Weight				6.5		g
Connector				8pin 2.54 mm		

## ESD rating

Electrostatic discharge	Human body model class 1C	$V_{ESD}$		2000		V
-------------------------	---------------------------	-----------	--	------	--	---

---

# TABLE OF CONTENTS

Product Information .....	1
Features .....	1
Applications .....	1
Description .....	1
Block Diagram .....	1
Characteristics .....	2
Antenna Diagram Characteristics .....	5
Pin Configuration and Functions .....	5
Theory of Operation .....	6
Overview .....	6
Sampling and FFT calculation .....	7
Start up time .....	9
Threshold generation .....	9
Detection algorithm .....	10
Reaction Time .....	10
Application Information .....	11
Stand-alone Operation .....	11
Speed measurement .....	11
Host driven Operation .....	11
Speed limitation and ranging .....	12
Micro detection .....	12
FFT filter .....	13
Adjust hold time and sensitivity .....	14
Serial Interface .....	14
Command Set Description .....	15
Command Classes .....	15
Command Format .....	15
Error messages .....	15
Command List .....	16

---

# TABLE OF CONTENTS

Integrators Information.....	21
Installation Instruction.....	21
United States (FCC) and Canada (ISED) .....	22
Europe (CE-RED) .....	23
Outline Dimensions.....	24
Order Information.....	24
Revision History .....	25

# ANTENNA DIAGRAM CHARACTERISTICS

This diagram shows module sensitivity (output voltage) in both azimuth and elevation directions. It incorporates the transmitter and receiver antenna characteristics.

**Figure 2: Antenna characteristics**

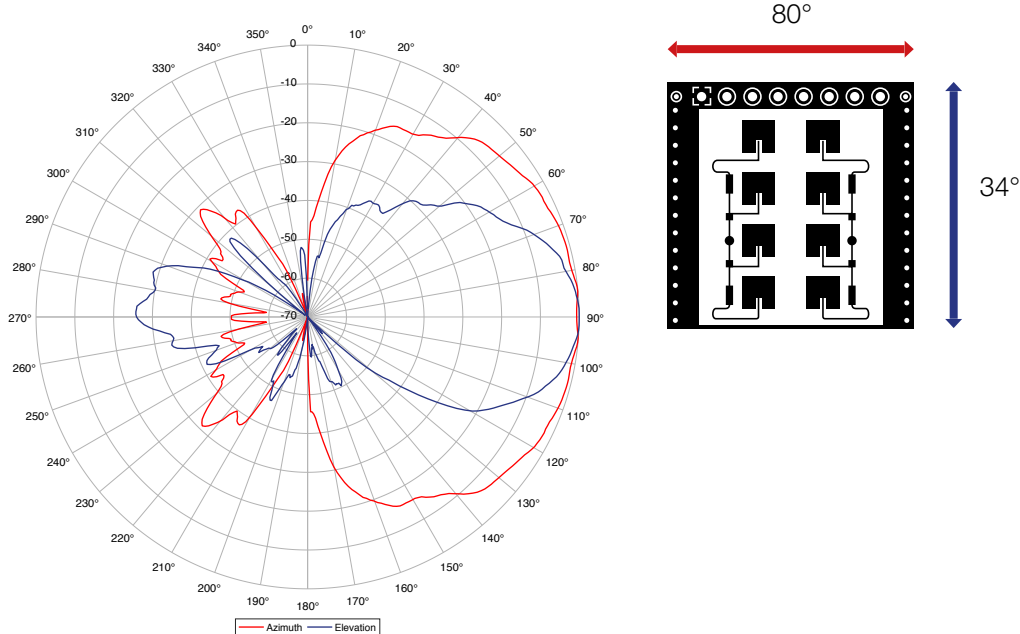

# PIN CONFIGURATION AND FUNCTIONS

**Table 1: Pin function description**

Pin No.	Name	Description
1	GND	Ground pin
2	Detect Out	Digital detection output. Signals a valid detection. Low → no detection High → valid detection
3	VCC	Power supply pin (3.2 to 5.5V)
4	RX	Serial interface RX input
5	TX	Serial interface TX output
6	Hold Time In	Analogue hold time input. Range from 0 to 3V 0V → minimum hold time 3V → maximum hold time
7	Sensitivity In	Analogue sensitivity input. Range from 0 to 3V 0 V → minimum sensitivity 3V → maximum sensitivity
8	Misc. Out	Digital miscellaneous output. The function is programmable over the command set with the parameter S06.  In the factory setting this output signals the direction of a valid detection. Low → backward/receding movement High → forward/approaching movement  <b>!</b> This output is only valid together with a high on pin 2 (valid detection) except if it is configured as micro detection output.

**Figure 3: Pin configuration**

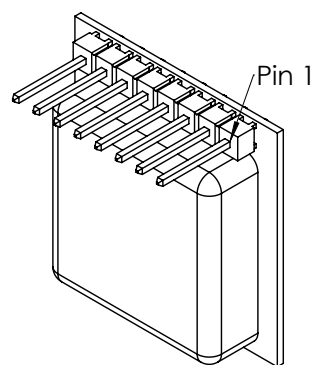

# THEORY OF OPERATION

## Overview

The K-LD2 takes advantage of an internal I/Q doppler signal processing by using a complex FFT (Fast Fourier Transform). The main advantages of this processing compared to standard time domain processing solutions are the following:

- Easy detection of the direction of a movement
- Increased detection range with better SNR due to the FFT processing
- Efficient interference suppression
- Vibration suppression

The signal processing unit samples the analogue I/Q doppler signals of the RF frontend and calculates a complex FFT in real time. In a next step an adaptive noise measurement and interference suppression is done which generates a threshold limit that can be adjusted with the sensitivity setting. Then the detection algorithm looks for a valid detection and latches it to the detection register and the digital outputs for the length of the hold time setting.

**Figure 4: Signal processing and detection workflow**

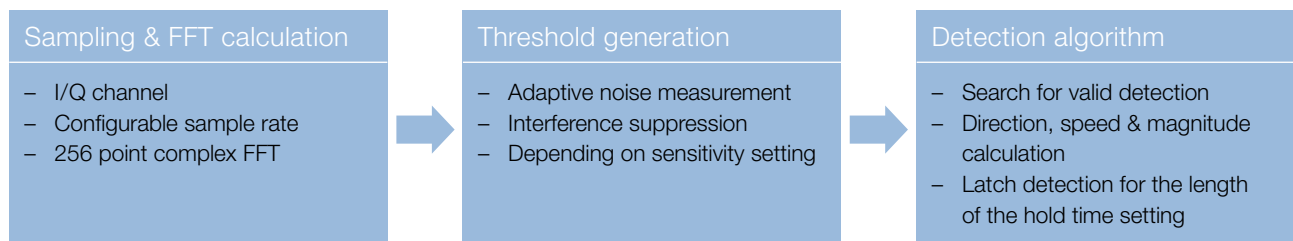

With a powerful command set (See chapter Command Set Description) it is possible to configure the whole signal processing and detection workflow. This allows customisation of the K-LD2 to get the best results in different environments and applications.

## Sampling and FFT calculation

The K-LD2 works with an internal I/Q doppler signal sampling and a computation of a 256 point wide complex FFT. I/Q doppler signals are phase shifted by  $+90^\circ$  or  $-90^\circ$  depending on the direction of a movement in the front of the sensor.

The signal processing unit samples the I/Q data with a configurable sampling rate (see parameter S04)

and computes a complex FFT. The sampling rate is an important parameter of the sensor because it directly estimates the speed resolution, the maximal speed, and the response time of the system. The response time is doubled if the FFT average feature (described below) is used.

**Figure 5: I/Q doppler signals of an approaching movement (left) and a receding movement (right)**

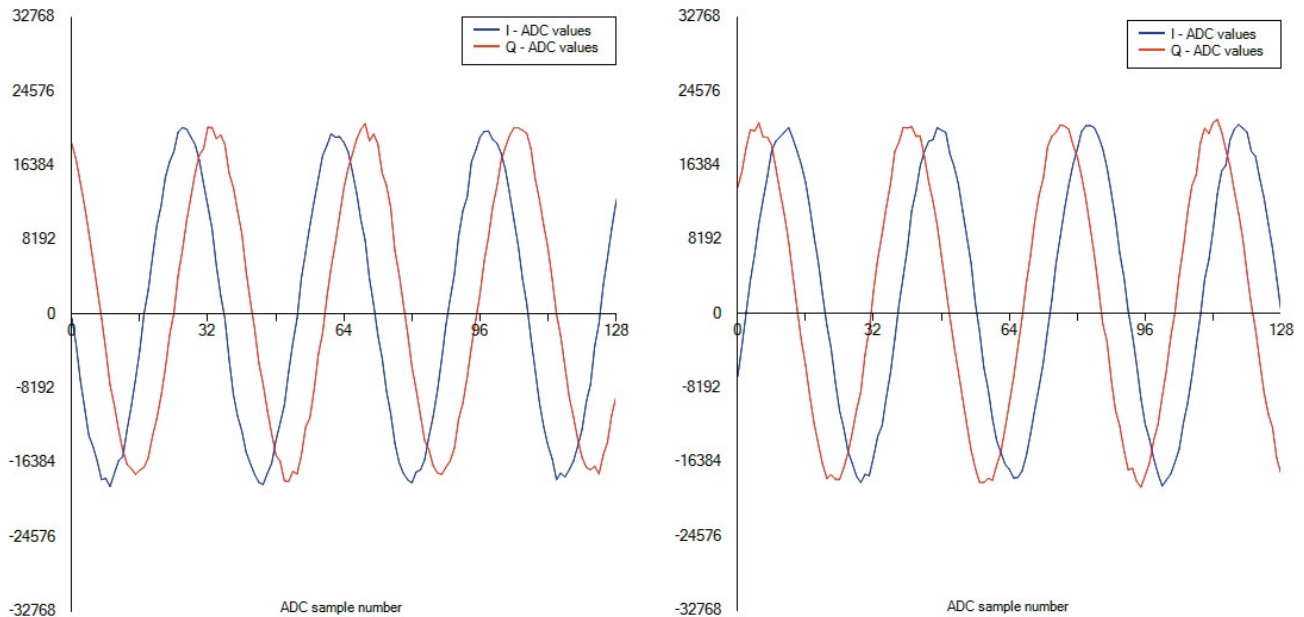

**Table 2: Sampling rate vs. speed resolution vs. maximal speed vs. response time**

Parameter S04	Sample rate [Hz]	Resolution [Hz]	Max. frequency [Hz]	Resolution [km/h]	Max speed [km/h]	Response time [ms]
01	1280	5	640	0.11	14.3	200/400
02	2560	10	1280	0.22	28.6	100/200
03	3840	15	1920	0.34	43.0	67/134
04	5120	20	2560	0.45	57.3	50/100
05	6400	25	3200	0.56	71.6	40/80
06	7680	30	3840	0.67	85.9	33/66
07	8960	35	4480	0.78	100.2	29/58
08	10240	40	5120	0.89	114.5	25/50
09	11520	45	5760	1.01	128.9	22/44
0A	12800	50	6400	1.12	143.2	20/40

The sampled I/Q doppler signals are transformed with a complex FFT into the frequency domain with 256 bins. Those signals appear either in the real (right) plane for an approaching movement or in the imaginary (left) plane for a receding movement. The signal in the centre is the DC offset caused by the amplifier and the analogue to digital conversion.

To reduce random noise, the sensor features a FFT average option (see parameter S0A) which is enabled in the factory settings. It is an average over two FFT frames.

Figure 6: Doppler signals in the frequency domain, approaching

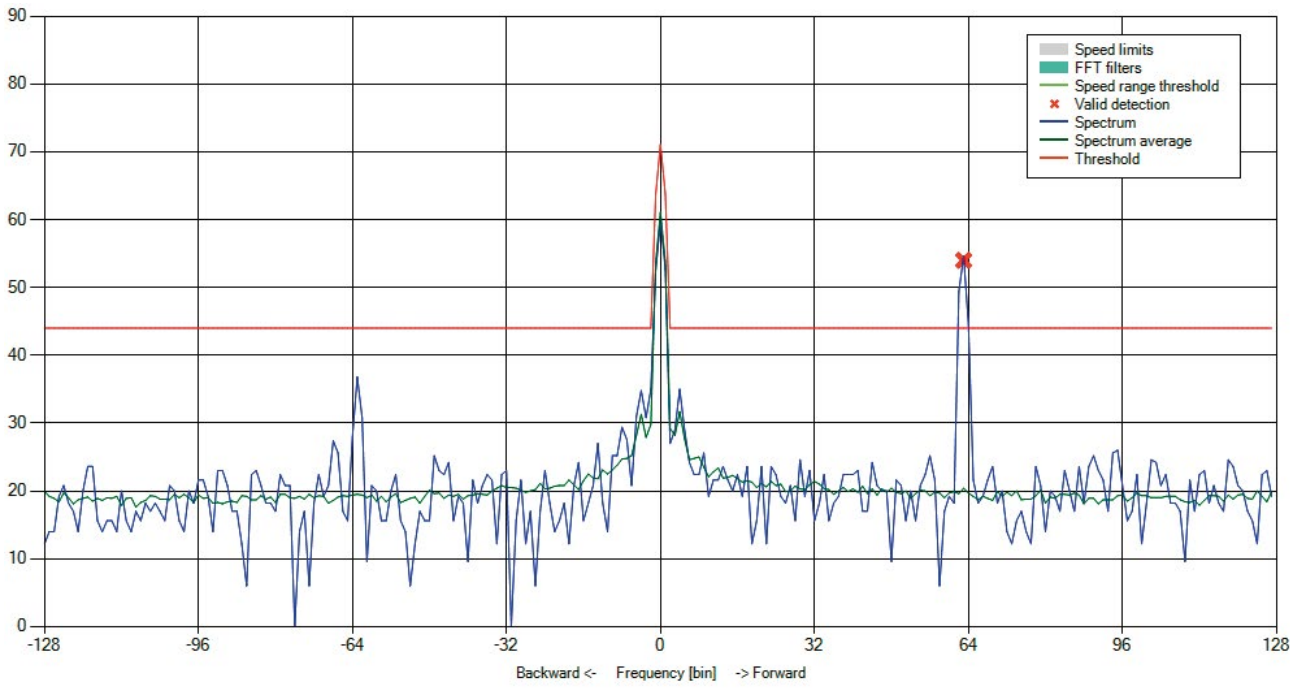
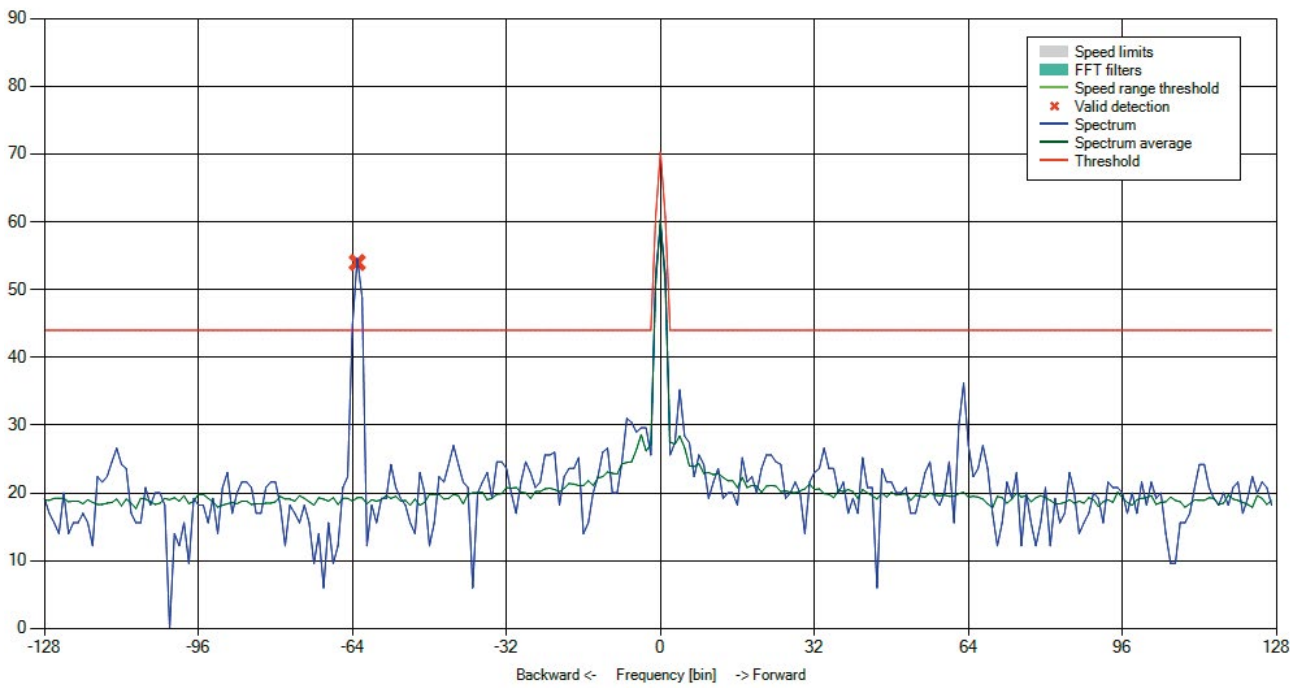

Figure 7: Doppler signals in the frequency domain, receding





## Start up time

During start up, the sensor calculates the mean over the number of FFT frames specified with the parameter start up learn. The start up time of the sensor depends on this parameter, the sampling frequency and the FFT size.

$$t_{Startup} = \frac{N_{FFT} \cdot N_{Value\ of\ S05}}{f_{Sample}} = \frac{256 \cdot N_{Value\ of\ S05}}{f_{Sample}}$$

## Threshold generation

The calculated mean during start up represents the noise floor of the sensor and is stored as spectrum average. During operation the spectrum average is adapted continuously. The speed of this adaption is configurable using the parameter threshold noise adaption speed. This mechanism automatically adapts interferences that are present in both planes of the FFT.

This adaptive spectrum average is used together with the parameter minimum threshold margin to generate the minimum possible threshold level. This means that the threshold level for each bin cannot be smaller than the spectrum average + the minimum threshold margin setting and this is independent of the sensitivity setting. Adapted interferences are thus automatically filtered out in the threshold level and do not generate a detection.

The noise floor of different sensors can vary. The sensitivity setting is referenced to the ground line in order to get an as constant as possible movement detection over different sensors.

The threshold level is defined as an addition of the parameter minimum threshold offset and the set sensitivity setting for each bin (Further information about the adjustment of the sensitivity setting can be found in chapter Adjust Hold Time and Sensitivity).

**Figure 8: Minimum threshold level and interference adaption**

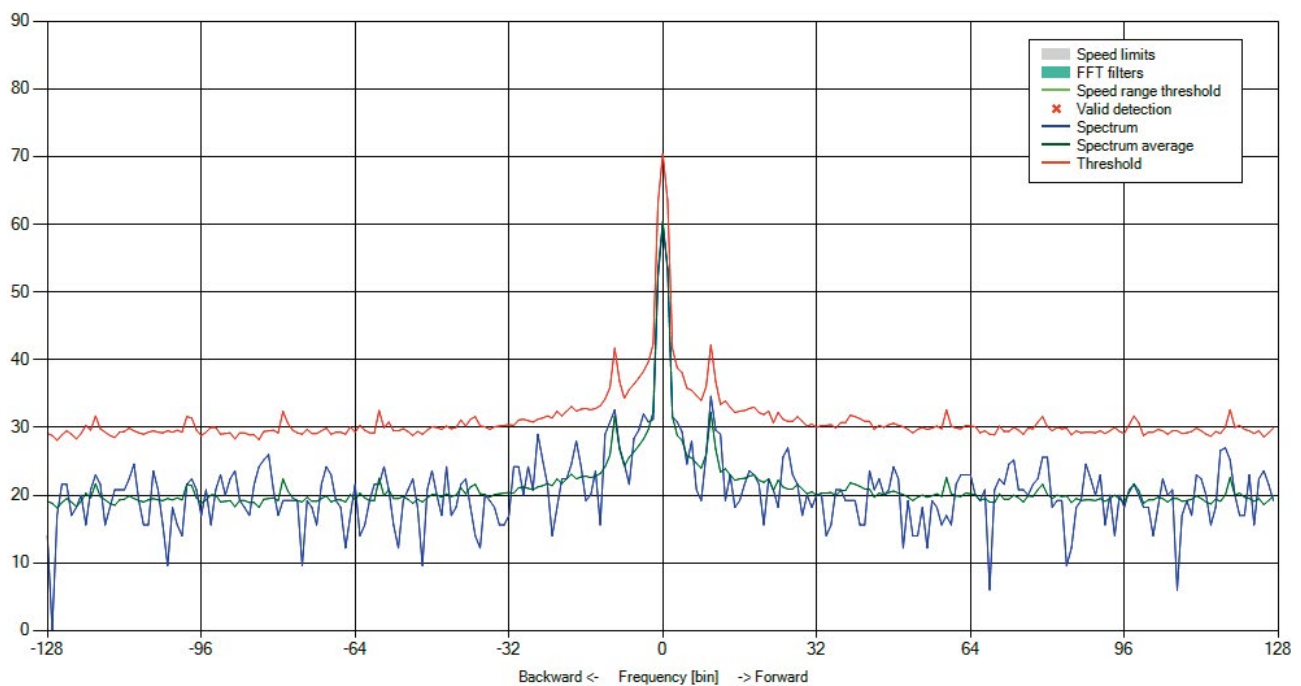

If the addition of the minimum threshold offset and the set sensitivity setting is smaller than the minimum threshold level (defined over the spectrum average and the parameter minimum threshold margin), the threshold is set to its minimum level.

## Detection algorithm

The detection algorithm uses the following steps:

1. Scan the FFT spectrum for peaks with a magnitude higher than the set threshold level and with the direction to detect set with the parameter D03.
2. Check if the peak is a valid movement with the correct direction or if it is an interference.
3. Increase the immunity against interferences by checking if the movement is constant (see parameter Immunity D02).
4. If there is a valid detection, estimate the speed bin and magnitude.
5. Latch all the information to the detection register (see parameters R00, R01 & R02) and to the digital outputs.
6. Decrease the hold time if there is no valid detection.
7. Reset the hold time if there is another valid detection.
8. Reset the detection register and the digital outputs if the hold time has elapsed.



You can find more advanced configuration options for the detection algorithm in the chapters Speed limitation and ranging, FFT filter and Adjust hold time and sensitivity.

## Reaction Time

The reaction time of the sensor depends on different settings and can be calculated with the equation below when the FFT average feature is disabled.

$$t_{Reaction} = \frac{N_{FFT}}{f_{Sample}} \cdot (Immunity + 1) = \frac{256}{f_{Sample}} \cdot (Immunity + 1)$$

With the FFT average feature enabled (see parameter SOA) the equation changes to:

$$t_{Reaction} = \frac{N_{FFT}}{f_{Sample}} \cdot (Immunity + 1) \cdot 2 = \frac{256}{f_{Sample}} \cdot (Immunity + 1) \cdot 2$$

# APPLICATION INFORMATION

## Stand-alone Operation

With the factory settings the sensor starts up and scans the beam for potential movements with a sampling rate of 2560Hz (app. 0.3 to 29.1 km/h). It filters out interferences and looks for movements with a magnitude that is higher than the threshold level set with the sensitivity.

If there is a valid movement the detection output (Pin 2) goes high and the direction is latched to the miscellaneous output (Pin 8) for the length of the set hold time.

The hold time (Pin 6) and the sensitivity (Pin 7) can be set using analogue inputs (for example with external potentiometers) in the following ranges:

- Hold time from 0.2 to 160s
- Sensitivity from 0 to 34dB (app. 2 to 20m for walking humans)

With the factory settings the reaction time of the sensor is approximately 800ms.

 The K-LD2 can also be factory configured with your settings. Contact RFbeam for more information.

## Host driven Operation

With a connection of the serial interface to a host (for example MCU or PC) it is possible to read-out advanced detection data including speed and magnitude of a valid detection or to use some advanced features of the K-LD2 which are described in the next chapters.

The detection output can be used to trigger a serial read-out command over an interrupt. If there is no interrupt input, it is possible to poll the detection state register and then trigger the additional read-out commands.

**Figure 9: MCU or PC connection example**

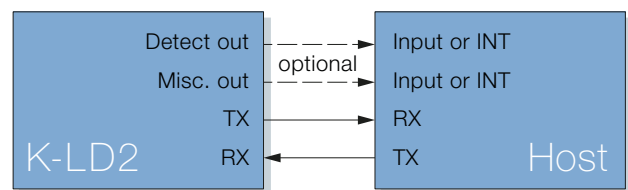

The command set features different parameters to read-out additional detection data.

**Table 3: Useful commands to read-out advanced detection data**

Parameter	Description	Note
R00	Get detection state register	Includes detection, direction, speed range and micro detection information
R01	Get detection speed in bin	Only valid when the detection bit in the detection state register is high.
R02	Get detection magnitude in dB	Only valid when the detection bit in the detection state register is high.
C00	Get detection string	Complete set of data of the parameters R00 to R02

## Speed measurement

The speed of a detected object is returned in bin and can be easily converted into the doppler frequency with the sampling rate and the FFT width. The sample rate is adjustable over the command S04 and the FFT width is fixed to 256.

$$f_{Doppler} = bin \cdot \frac{f_{Sample}}{N_{FFT}} = bin \cdot \frac{f_{Sample}}{256}$$

The measured doppler frequency is proportional to the speed of the object when it is measured frontal to the sensor. An angle between the object and the sensor reduces the doppler frequency. The speed in km/h is easily computable with the equation below based on the doppler effect.

**Figure 10: FFT bin to speed conversion**

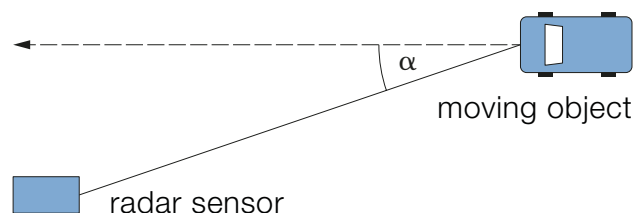

$$v = \frac{f_{Doppler} \cdot km/h}{44.7 Hz \cdot \cos(\alpha)} = \frac{bin \cdot f_{Sample} \cdot km/h}{256 \cdot 44.7 Hz \cdot \cos(\alpha)}$$

## Speed limitation and ranging

The K-LD2 features the possibility to easily filter out slow and fast speeds by setting speed limits with the parameters D04 & D05 over the command set. The limits are independent of each other and can be used stand-alone.

The whole FFT can also be divided into two speed ranges with the parameter D06. When the speed range threshold is set, the detection algorithm decides in which speed range (high or low) the detection was

found and latches it to the detection register or, if it is configured to signal the speed range (see parameter S06), to the miscellaneous output.



The usage of the speed limits and the speed range threshold makes it very easy to divide objects into two speed classes

Figure 11: Speed limitation and ranging overview

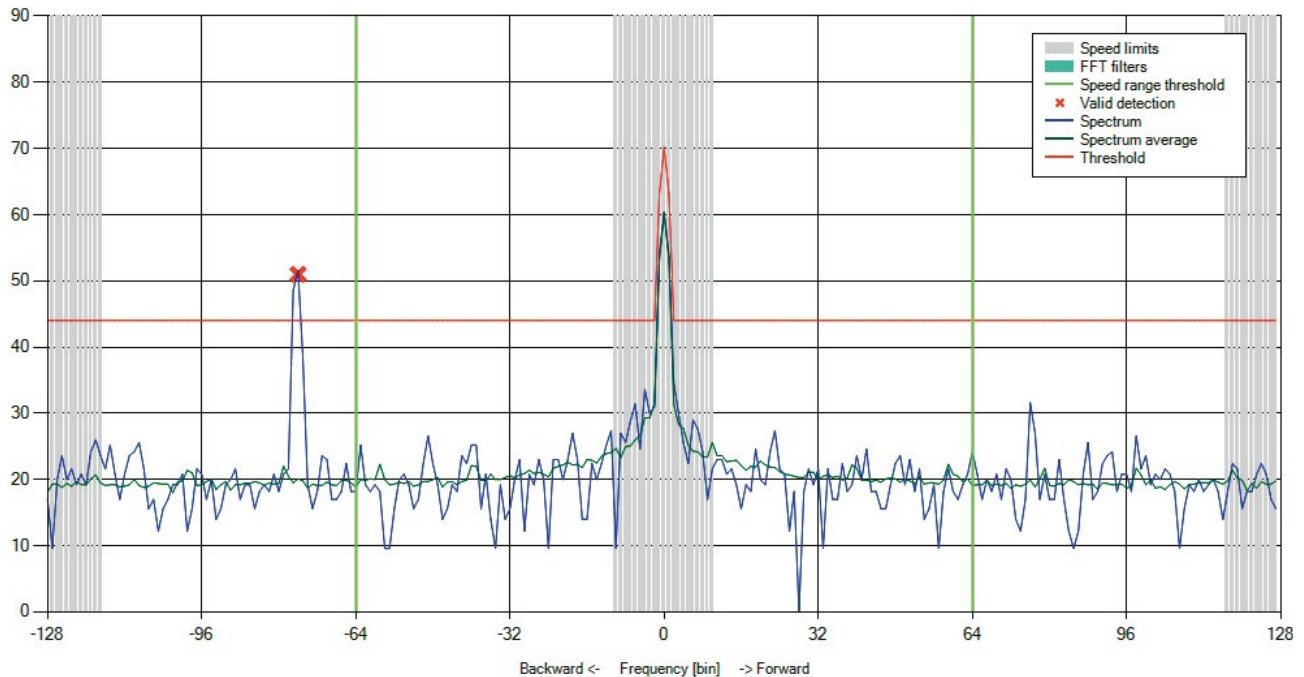

## Micro detection

The micro detection is a feature to detect very slow speeds in short range applications. It takes advantage of an algorithm that analyses the DC bin of the FFT to detect very slow speeds. The micro detection is independent from the normal detection algorithm and always enabled.

If a slow movement generates a signal magnitude that is higher than the adjustable micro detection threshold (see parameter D07) the micro detection flag in the detection register goes to high (see parameter R00).



The algorithm computes the micro detection flag for every sampled frame, independent of the hold time setting.

The miscellaneous output can be configured to signal the micro detection over the parameter S06. This

gives the host the possibility to directly trigger to a valid micro detection.

Furthermore, it is possible to retrigger the detection algorithm over the micro detection feature (see parameter S0D). If this feature is enabled, the detection algorithm first requires a valid detection and then, if there was a valid micro detection, it will retrigger the hold time. If the hold time has elapsed because there was no detection or micro detection, the detection goes to low and needs again a valid detection before the micro detection is used to retrigger the hold time.



The covered speed range that is analysed by the micro detection feature depends on the sampling rate (see parameter S04), because the content of the DC bin changes with the sampling rate.

## FFT filter

The FFT filter feature can be used to filter out specific regions in the FFT spectrum. The FFT filter array (see parameters A20...A27) consists of up to 8 independent FFT filters. Further the  $\pm$  width around these FFT filters can be specified with the parameter D08.

For example: The commands `$A20000A<CR>`, `$A210032<CR>` & `$A220050<CR>` define 3 FFT filters at the bin positions 10, 50 & 80. The command `$D0802<CR>` sets the  $\pm$  width around the filters to 2.



This feature allows easy filtering out of unwanted constant movements like a ventilator. Please note that other movements with the same speed are also filtered out.

Figure 12: FFT filter and FFT filter width example

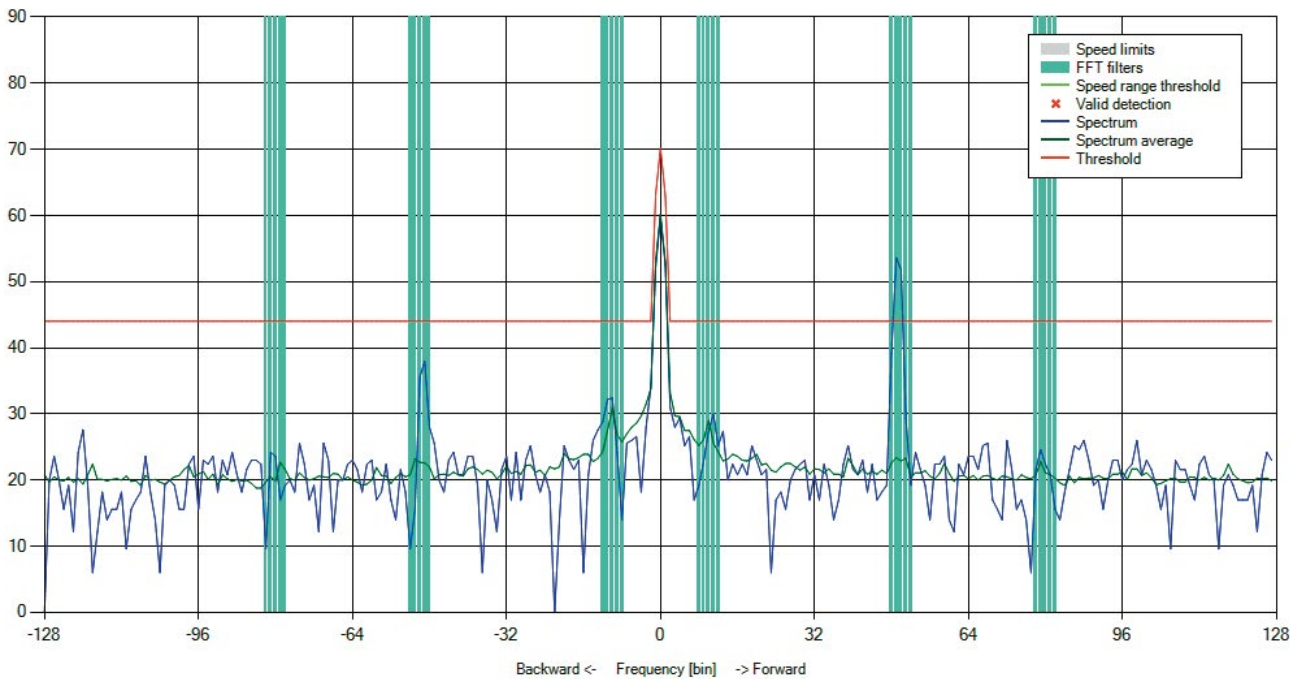

## Adjust hold time and sensitivity

The K-LD2 uses arrays with a width of 10 elements to set the range of hold time and sensitivity (see parameters A00...A09 for hold time and parameters A10...A19 for sensitivity). The used index of the arrays is defined using the parameters D00 and D01 or by the analogue inputs, if these are enabled with the parameters S0B and S0C.

In the factory settings these arrays are filled with default values that will work for the most applications. (See Table Hold time array default values and Table Sensitivity array default values) It is possible to overwrite these arrays to generate your own sensitivity or hold time curves.

**Figure 13: Hold time and sensitivity block diagram**

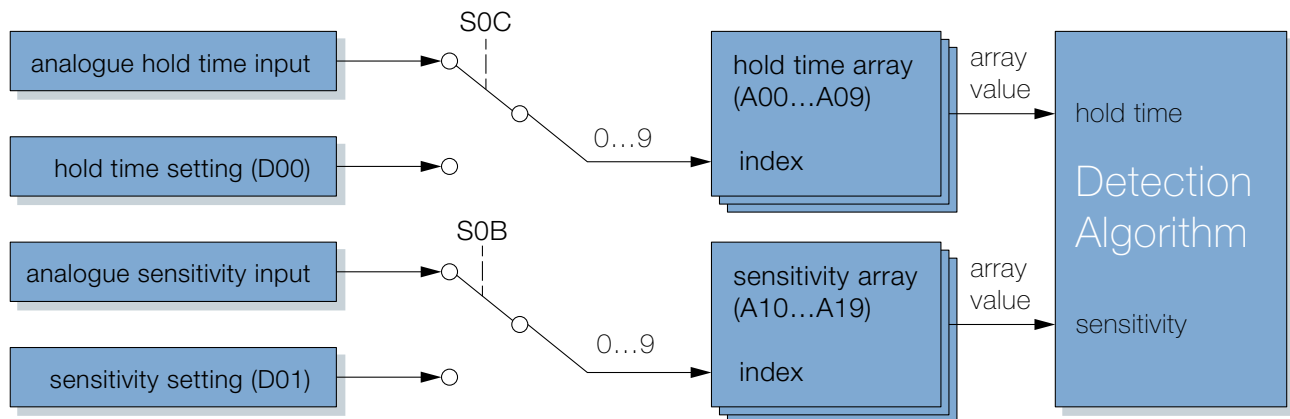

## Serial Interface

The K-LD2 features a serial interface with a command set to configure the sensor and read-out measured data. The interface is an ASCII based 3.3V asynchronous UART with the following settings:

- Baud rate 38400 bps
- 8 data bits
- 1 stop bit
- no parity, no handshake

This interface and the complete command set is supported by the K-LD2 Control Panel, which is included in the K-LD2-EVAL evaluation kit.



It is possible to connect the K-LD2 directly with an USB to UART cable with +3.3V TTL level signals. For example the TTL-232R-3V3 from FTDI can directly be connected to the pins 1 to 6 of the K-LD2 to power it and get access to the serial interface over a standard terminal program.

# COMMAND SET DESCRIPTION

## Command Classes

The command set is divided into different classes. Every class contains a set of parameters.

**Table 4: Command classes**

Parameter Type	Cmd Class	Volatile	Purpose
System parameters	S	Yes	System relevant parameters to configure the sampling and interference suppression
Detection parameters	D	Yes	Specific parameters to configure the detection algorithm
Array parameters	A	Yes	System specific tables
Flash read parameters	F	Yes	Read only parameters
Real-time read parameters	R	No	Real-time system and detection information
Basic write parameters	W	No	Basic write parameters to configure the system
Complex read parameters	C	No	Advanced read-out parameters
Testing parameters	T	No	Parameters to test the hardware

## Command Format

Every command is ASCII coded and needs to be sent over the serial interface by a host CPU or an ASCII terminal program. Every request needs to start with the prefix \$ and ends with a <CR> (0x0D in Hex). The K-LD2 always answers with @ as a prefix excluding the command class C.

**Table 5: Command format**

\$	P	NN	VV[VV]	<CR>
Prefix	Command class	Parameter number (Hex)	Value (Hex) 8 or 16Bit wide	«Enter»

**Table 6: request/response example**

Example request	K-LD2 response	Comment
\$S06<CR>	@S0601<CR><LF>	Get actual value
\$S0602<CR>	@S0602<CR><LF>	Set new value

## Error messages

The K-LD2 responds with a message from the table below if an error has occurred.

**Table 7: Error messages**

Error message	Description
@E01<CR><LF>	Value out of limits
@E02<CR><LF>	Parameter number does not exist
@E03<CR><LF>	Command class does not exist
@E04<CR><LF>	Writing to EEPROM error
@E05<CR><LF>	Command format error
@E06<CR><LF>	UART communication error





All values are in hexadecimal notation unless otherwise noted.

**Table 8: Class S 8-Bit system parameters**

Param.	Default	Min	Max	Name	Description																				
S04	02	01	0A	Sampling rate	Sampling rate = value*1280Hz ⚠ Only valid after reset.																				
S05	10	01	40	Start up learn	Number of FFT blocks that are used to learn the noise threshold average at start up. 01: no average at start up, fastest start up time 40: best average at start up, slowest start up time ⚠ Only valid after reset.																				
S06	01	00	03	Function of miscellaneous output	Configurable functions of the miscellaneous output pin. The functions directly represent the detection register. <table border="1"> <thead> <tr> <th>Value</th> <th>Function</th> <th>Logic Low</th> <th>Logic High</th> </tr> </thead> <tbody> <tr> <td>00</td> <td>Detection</td> <td>No detection</td> <td>Valid detection</td> </tr> <tr> <td>01</td> <td>Direction</td> <td>Backward/receding</td> <td>Forward/approaching</td> </tr> <tr> <td>02</td> <td>Range</td> <td>Low speed range</td> <td>High speed range</td> </tr> <tr> <td>03</td> <td>Micro detection</td> <td>No detection</td> <td>Valid micro detection</td> </tr> </tbody> </table> <p>Detailed information about the functions can be found in the command description of the parameter R00.</p>	Value	Function	Logic Low	Logic High	00	Detection	No detection	Valid detection	01	Direction	Backward/receding	Forward/approaching	02	Range	Low speed range	High speed range	03	Micro detection	No detection	Valid micro detection
Value	Function	Logic Low	Logic High																						
00	Detection	No detection	Valid detection																						
01	Direction	Backward/receding	Forward/approaching																						
02	Range	Low speed range	High speed range																						
03	Micro detection	No detection	Valid micro detection																						
S07	1E	14	50	Minimum threshold offset	Defines the minimum threshold offset in dB with the ground line as reference.																				
S08	0A	01	30	Minimum threshold margin	Defines the minimum margin between the noise average and the threshold curve.																				
S09	0A	00	FF	Threshold noise adaption speed	The speed of the noise average threshold adaption can be set with this parameter. The value defines after how many FFT blocks the noise threshold average is adapted again.																				
S0A	01	00	01	Use FFT average	FFT averaging flag to reduce random noise. 00: averaging off 01: averaging on ⚠ Doubles the response and reaction time if enabled.																				
S0B	01	00	01	Use sensitivity potentiometer	Flag to enable the usage of the analogue input for the sensitivity. 00: use digital sensitivity setting of parameter D01 01: use potentiometer input for sensitivity setting																				
S0C	01	00	01	Use hold time potentiometer	Flag to enable the usage of the analogue input for the hold time. 00: use digital hold time setting of parameter D00 01: use potentiometer input for hold time setting																				
S0D	00	00	01	Use micro detection for retriggering	Flag to enable the usage of the micro detection to retrigger the detection algorithm. 00: micro detection retriggering disabled 01: micro detection retriggering enabled																				



**Table 9: Class D 8-Bit detection parameters**

Param.	Default	Min	Max	Name	Description
D00	01	00	09	Hold time	Index value to select an element of the hold time array defined with the parameters A00...A09.  This value has no effect if the parameter use hold time potentiometer S0C is enabled.
D01	07	00	09	Sensitivity	Index value to select an element of the sensitivity array defined with the parameters A10...A19.  This value has no effect if the parameter use sensitivity potentiometer S0D is enabled.
D02	03	00	10	Immunity	Value to change the immunity against interferences like vibrations. 00: minimum immunity 10: maximum immunity  Immunity increases the reaction time of the sensor.
D03	02	00	02	Direction to detect	Defines which direction is detected in the detection algorithm. 00: only forward (approaching) 01: only backward (receding) 02: both directions
D04	00	00	7F	Low speed limit	Can be used to define a low speed limit in bin for the detection algorithm to filter out slow speeds. 00: inactive 01...7F: All speeds below this bin are filtered out
D05	00	00	7F	High speed limit	Can be used to define a high speed limit in bin for the detection algorithm to filter out fast speeds. 00: inactive 01...7F: All speeds above this bin are filtered out
D06	00	00	7F	Speed range threshold	Function to divide the spectrum in a high and a low speed range. Triggers the range flag in the detection register R00. 00: inactive 01...7F: threshold in bin for the low and high speed range
D07	06	05	09	Micro detection threshold	Function to set the threshold of the micro detection feature. 05: minimum threshold 09: maximum threshold
D08	02	00	0A	FFT filter width	Defines the ± width in bin that is filtered out around a specified filter in the FFT filter array defined with the parameters A20...A27.

**Table 10: Class A 16-Bit array parameters**

Param.	Default	Min	Max	Name	Description
A00... A09	See table below	0000	FFFF	Hold time array	10 elements wide hold time array in 100ms, addressed by parameter D00. 0000: minimum hold time 0002: 2*100ms → 0.2s hold time FFFF: maximum hold time
A10... A19	See table below	0000	00FF	Sensitivity array	10 elements wide sensitivity array in dB, addressed by parameter D01. 0000: maximum sensitivity 000A: 10dB sensitivity 00FF: minimum sensitivity
A20... A27	0	0000	007F	FFT filter array	FFT filter array in bin to define up to 8 different FFT filters with a ± width defined by parameter D08. 0000: FFT filter inactive 0001...007F: FFT filter position in bin

**Table 11: Hold time array default values**

Param.	A00	A01	A02	A03	A04	A05	A06	A07	A08	A08
<b>Value [Hex]</b>	0002	0005	000A	0014	0032	0064	00C8	0190	0320	0640
<b>Value [s]</b>	0.2	0.5	1	2	5	10	20	40	80	160

**Table 12: Sensitivity array default values**

Param.	A10	A11	A12	A13	A14	A15	A16	A17	A18	A19
<b>Value [Hex]</b>	0022	001C	0016	0012	000E	000A	0006	0004	0002	0000
<b>Value [dB]</b>	34	28	22	18	14	10	6	4	2	0

**Table 13: Class F 16-Bit flash read parameters**

Param.	Default	Min	Max	Name	Description
F00	–	0000	FFFF	Get software version	Returns the firmware version of the sensor as a 16-Bit hex value. For example: <code>0F000078&lt;CR&gt;&lt;LF&gt;</code> → 120 → Version 01.20
F01	–	0000	FFFF	Get type of device	Returns the type of the device, that the firmware is running on. 0001: K-LD2

**Table 14: Class R 8-Bit real-time read parameters**

Param.	Default	Min	Max	Name	Description															
R00	–	00	0F	Get detection register	Returns the detection register with the content below. <table border="1" style="width: 100%; border-collapse: collapse;"> <thead> <tr> <th>Bit</th> <th>Name</th> <th>Description</th> </tr> </thead> <tbody> <tr> <td>0</td> <td>Det</td> <td>Signals a valid detection. 0: no detection 1: valid detection</td> </tr> <tr> <td>1</td> <td>Dir</td> <td>Signals the direction of the detection. 0: backward/receding movement detected 1: forward/approaching movement detected  Only valid if Bit 0 is high.</td> </tr> <tr> <td>2</td> <td>Range</td> <td>Signals the speed range of the detection depending on the speed threshold parameter D06. 0: low speed range detected 1: high speed range detected  Only valid if the speed range threshold is &gt; 0 and if Bit 0 is high.</td> </tr> <tr> <td>3</td> <td>Micro</td> <td>Signals a micro detection found in the DC bin of the FFT. 0: no micro detection 1: valid micro detection</td> </tr> </tbody> </table>	Bit	Name	Description	0	Det	Signals a valid detection. 0: no detection 1: valid detection	1	Dir	Signals the direction of the detection. 0: backward/receding movement detected 1: forward/approaching movement detected Only valid if Bit 0 is high.	2	Range	Signals the speed range of the detection depending on the speed threshold parameter D06. 0: low speed range detected 1: high speed range detected Only valid if the speed range threshold is > 0 and if Bit 0 is high.	3	Micro	Signals a micro detection found in the DC bin of the FFT. 0: no micro detection 1: valid micro detection
Bit	Name	Description																		
0	Det	Signals a valid detection. 0: no detection 1: valid detection																		
1	Dir	Signals the direction of the detection. 0: backward/receding movement detected 1: forward/approaching movement detected Only valid if Bit 0 is high.																		
2	Range	Signals the speed range of the detection depending on the speed threshold parameter D06. 0: low speed range detected 1: high speed range detected Only valid if the speed range threshold is > 0 and if Bit 0 is high.																		
3	Micro	Signals a micro detection found in the DC bin of the FFT. 0: no micro detection 1: valid micro detection																		
R01	–	00	FF	Get detection speed	Returns the speed in bin of the last valid detection. Only valid if the bit 0 in the detection register R00 is high.															
R02	–	00	FF	Get detection magnitude	Returns the magnitude in dB of the last valid detection. Only valid if the bit 0 in the detection register R00 is high.															
R03	–	00	FF	Get noise level	Returns the mean noise level value in dB.															
R04	–	00	02	Get operation state	Returns the operation state of the sensor. Can be used at start up to check if the sensor is ready. 00: start up 01: learn 02: run															
R05	–	00	09	Get hold time potentiometer index	Returns the current hold time potentiometer index. 00: 0V at the analogue input 09: 3V at the analogue input															
R06	–	00	09	Get sensitivity potentiometer index	Returns the current sensitivity potentiometer index. 00: 0V at the analogue input 09: 3V at the analogue input															

**Table 15: Class W 8-Bit basic write parameters**

Param.	Default	Min	Max	Name	Description
W00	–	–	–	Reset processor	Generates a software reset. Check the operation state after the reset with the parameter R04.
W01	–	–	–	Restore factory settings	Restores the default factory settings for all parameters. Check the operation state after the restore with the parameter R04.
W02	00	00	01	Set UART baud rate	Sets the baud rate of the serial UART interface. 00: 38400 bps 01: 460800 bps This parameter is not stored. After a reset or restart the baud rate is set to 38400 bps.

**Table 16: Class C variable length complex read parameters**

Param.	Default	Min	Max	Name	Description	Length																																										
C00	-	-	-	Get detection string	Returns the detection register, the detection speed and the detection magnitude as an ASCII string in decimal format. Example response: 001;076;067;	14 bytes																																										
C01	-	-	-	Get target string	Returns an ASCII target list string in decimal format. It returns the speed and magnitude of the dominant movement for the forward and backward plane of the spectrum.  Target string structure: Forward speed in bin + Backward speed in bin + Forward magnitude in dB + Backward magnitude in dB  Example response: 000;000;000;000; → no target found 076;000;045;000; → forward target found 000;076;000;045; → backward target found 020;076;031;045; → two targets found	18 bytes																																										
C02	-	-	-	Get EEPROM hex string	Returns the full 512 EEPROM bytes as an ASCII string in the Intel hex format.	2893 bytes																																										
C03	-	-	-	Get FFT spectrum + threshold level	Returns the FFT spectrum and the threshold level in a binary format.	1024 bytes																																										
					<table border="1"> <thead> <tr> <th>Description</th> <th>Datatype</th> <th>Length</th> </tr> </thead> <tbody> <tr> <td>FFT spectrum</td> <td>UIN16*</td> <td>512 bytes</td> </tr> <tr> <td>Threshold level</td> <td>UIN16*</td> <td>512 bytes</td> </tr> </tbody> </table>	Description	Datatype	Length	FFT spectrum	UIN16*	512 bytes	Threshold level	UIN16*	512 bytes																																		
Description	Datatype	Length																																														
FFT spectrum	UIN16*	512 bytes																																														
Threshold level	UIN16*	512 bytes																																														
C04	-	-	-	Get ADC I/Q data + FFT spectrum + threshold level	Returns the ADC I/Q data, the FFT spectrum and the threshold level in a binary format.	2048 bytes																																										
					<table border="1"> <thead> <tr> <th>Description</th> <th>Datatype</th> <th>Length</th> </tr> </thead> <tbody> <tr> <td>ADC I data</td> <td>INT16*</td> <td>512 bytes</td> </tr> <tr> <td>ADC Q data</td> <td>INT16*</td> <td>512 bytes</td> </tr> <tr> <td>FFT spectrum</td> <td>UIN16*</td> <td>512 bytes</td> </tr> <tr> <td>Threshold level</td> <td>UIN16*</td> <td>512 bytes</td> </tr> </tbody> </table>	Description	Datatype	Length	ADC I data	INT16*	512 bytes	ADC Q data	INT16*	512 bytes	FFT spectrum	UIN16*	512 bytes	Threshold level	UIN16*	512 bytes																												
Description	Datatype	Length																																														
ADC I data	INT16*	512 bytes																																														
ADC Q data	INT16*	512 bytes																																														
FFT spectrum	UIN16*	512 bytes																																														
Threshold level	UIN16*	512 bytes																																														
C05	-	-	-	Get C04 + additional parameters	Returns the values of C04 and additional parameters in a binary format.	2070 bytes																																										
					<table border="1"> <thead> <tr> <th>Description</th> <th>Datatype</th> <th>Length</th> </tr> </thead> <tbody> <tr> <td>ADC I data</td> <td>INT16*</td> <td>512 bytes</td> </tr> <tr> <td>ADC Q data</td> <td>INT16*</td> <td>512 bytes</td> </tr> <tr> <td>FFT spectrum</td> <td>UIN16*</td> <td>512 bytes</td> </tr> <tr> <td>Threshold level</td> <td>UIN16*</td> <td>512 bytes</td> </tr> <tr> <td>Detection register</td> <td>UIN8</td> <td>1 byte</td> </tr> <tr> <td>Detection speed</td> <td>UIN8</td> <td>1 byte</td> </tr> <tr> <td>Detection magnitude</td> <td>UIN8</td> <td>1 byte</td> </tr> <tr> <td>Target string</td> <td>ASCII string</td> <td>15 bytes</td> </tr> <tr> <td>Noise level mean</td> <td>UIN8</td> <td>1 byte</td> </tr> <tr> <td>Operation state</td> <td>UIN8</td> <td>1 byte</td> </tr> <tr> <td>Index of hold time potentiometer</td> <td>UIN8</td> <td>1 byte</td> </tr> <tr> <td>Index of sensitivity potentiometer</td> <td>UIN8</td> <td>1 byte</td> </tr> </tbody> </table>	Description	Datatype	Length	ADC I data	INT16*	512 bytes	ADC Q data	INT16*	512 bytes	FFT spectrum	UIN16*	512 bytes	Threshold level	UIN16*	512 bytes	Detection register	UIN8	1 byte	Detection speed	UIN8	1 byte	Detection magnitude	UIN8	1 byte	Target string	ASCII string	15 bytes	Noise level mean	UIN8	1 byte	Operation state	UIN8	1 byte	Index of hold time potentiometer	UIN8	1 byte	Index of sensitivity potentiometer	UIN8	1 byte				
Description	Datatype	Length																																														
ADC I data	INT16*	512 bytes																																														
ADC Q data	INT16*	512 bytes																																														
FFT spectrum	UIN16*	512 bytes																																														
Threshold level	UIN16*	512 bytes																																														
Detection register	UIN8	1 byte																																														
Detection speed	UIN8	1 byte																																														
Detection magnitude	UIN8	1 byte																																														
Target string	ASCII string	15 bytes																																														
Noise level mean	UIN8	1 byte																																														
Operation state	UIN8	1 byte																																														
Index of hold time potentiometer	UIN8	1 byte																																														
Index of sensitivity potentiometer	UIN8	1 byte																																														
C06	-	-	-	Get C05 + spectrum average	Returns the values of C05 and the spectrum average in a binary format.	2582 bytes																																										
					<table border="1"> <thead> <tr> <th>Description</th> <th>Datatype</th> <th>Length</th> </tr> </thead> <tbody> <tr> <td>ADC I data</td> <td>INT16*</td> <td>512 bytes</td> </tr> <tr> <td>ADC Q data</td> <td>INT16*</td> <td>512 bytes</td> </tr> <tr> <td>FFT spectrum</td> <td>UIN16*</td> <td>512 bytes</td> </tr> <tr> <td>Threshold level</td> <td>UIN16*</td> <td>512 bytes</td> </tr> <tr> <td>Detection register</td> <td>UIN8</td> <td>1 byte</td> </tr> <tr> <td>Detection speed</td> <td>UIN8</td> <td>1 byte</td> </tr> <tr> <td>Detection magnitude</td> <td>UIN8</td> <td>1 byte</td> </tr> <tr> <td>Target string</td> <td>ASCII string</td> <td>15 bytes</td> </tr> <tr> <td>Noise level mean</td> <td>UIN8</td> <td>1 byte</td> </tr> <tr> <td>Operation state</td> <td>UIN8</td> <td>1 byte</td> </tr> <tr> <td>Index of hold time potentiometer</td> <td>UIN8</td> <td>1 byte</td> </tr> <tr> <td>Index of sensitivity potentiometer</td> <td>UIN8</td> <td>1 byte</td> </tr> <tr> <td>Spectrum average</td> <td>UIN16*</td> <td>512 bytes</td> </tr> </tbody> </table>	Description	Datatype	Length	ADC I data	INT16*	512 bytes	ADC Q data	INT16*	512 bytes	FFT spectrum	UIN16*	512 bytes	Threshold level	UIN16*	512 bytes	Detection register	UIN8	1 byte	Detection speed	UIN8	1 byte	Detection magnitude	UIN8	1 byte	Target string	ASCII string	15 bytes	Noise level mean	UIN8	1 byte	Operation state	UIN8	1 byte	Index of hold time potentiometer	UIN8	1 byte	Index of sensitivity potentiometer	UIN8	1 byte	Spectrum average	UIN16*	512 bytes	
Description	Datatype	Length																																														
ADC I data	INT16*	512 bytes																																														
ADC Q data	INT16*	512 bytes																																														
FFT spectrum	UIN16*	512 bytes																																														
Threshold level	UIN16*	512 bytes																																														
Detection register	UIN8	1 byte																																														
Detection speed	UIN8	1 byte																																														
Detection magnitude	UIN8	1 byte																																														
Target string	ASCII string	15 bytes																																														
Noise level mean	UIN8	1 byte																																														
Operation state	UIN8	1 byte																																														
Index of hold time potentiometer	UIN8	1 byte																																														
Index of sensitivity potentiometer	UIN8	1 byte																																														
Spectrum average	UIN16*	512 bytes																																														

\* 16 bit wide datatypes are sent with the high byte first.

**Table 17: Class T 8-Bit testing parameters**

Param.	Default	Min	Max	Name	Description
T00	00	00	01	Activate testing mode	<p>Activates the testing mode.</p> <p>00: Testing mode disabled 01: Testing mode enabled</p> <p> This parameter is not stored. After a reset or restart it is reset to the value 00.</p>
T01	–	00	01	Force detection output	<p>Controls the detection output, if the testing mode T00 is enabled</p> <p>00: force to low 01: force to high</p>
T02	–	00	01	Force miscellaneous output	<p>Controls the miscellaneous output, if the testing mode T00 is enabled</p> <p>00: force to low 01: force to high</p>

---

# INTEGRATORS INFORMATION

## Installation Instruction

### Mechanical enclosure

It is possible to hide the sensor behind a so called radome (short for radar dome) to protect it from environmental influences or to simply integrate it in the case of the end product. A radar sensor can see through different types of plastic and glass of any colour as long as it is not metallized. This allows for a very flexible design of the housing as long as the rules below are observed.

- Cover must not be metallic.
- No plastic coating with colors containing metallic or carbon particles.
- Distance between cover and front of Radar sensor  $\leq 6.2$  mm
- Best cover material is Polycarbonat or ABS
- Best cover thickness is 3–4 mm
- Vibrations of the Radar antenna relatively to the cover should be avoided, because this generates signals that can trigger the output
- The cover material can act as a lens and focus or disperse the transmitted waves. Use a constant material thickness within the area used for transmission to minimize the effect of the radome to the radiated antenna pattern.



Detailed information about the calculation and thickness for different cover materials can be found in the application note “AN-03-Radome”.

## United States (FCC) and Canada (ISED)

This module has been granted modular approval for fixed and/or mobile applications. The modular approval allows the end user to integrate the module into a finished product without obtaining subsequent and separate FCC/ISED approvals for intentional radiation, provided no changes or modifications are made to the module circuitry. Changes or modifications could void the user's authority to operate the equipment. The end user must comply with all of the instructions provided by the Grantee, which indicate installation and/or operating conditions necessary for compliance. The finished product is required to comply with all applicable FCC/ISED equipment authorizations regulations, requirements and equipment functions not associated with the transmitter module portion.



Modification to this product will void the users' authority to operate this equipment.



The OEM integrator is responsible for the final compliance of the end product with this integrated modular approved transmitter module. This includes measurements with the RF module integrated and activated as defined in KDB 996369 and if applicable appropriate equipment authorizations as defined in §15.101.

### Labelling and user information requirements

If the label of the module is not visible from the outside of the end product, it must include the following texts on the label of the host product:

FCC [Contains FCC ID: 2ASYV-K-LD2](#)  
ISED [Contains IC: 24358-KLD2](#)

In addition to marking the product with the appropriate ID's, the end product shall bear the following statement in a conspicuous location on the label or alternatively in the user manual:

This device complies with Part 15 of the FCC Rules and with Industry Canada licence-exempt RSS standard(s). Operation is subject to the following two conditions: (1) this device may not cause harmful interference, and (2) this device must accept any interference received, including interference that may cause undesired operation.

Le présent appareil est conforme aux CNR d'Industrie Canada applicables aux appareils radio exempts de licence. L'exploitation est autorisée aux deux conditions suivantes: (1) l'appareil ne doit pas produire de brouillage, et (2) l'appareil doit accepter tout brouillage radioélectrique subi, même si le brouillage est susceptible d'en compromettre le fonctionnement.

### RF Exposure

This module is approved for installation into fixed and/or mobile host platforms and must not be co-located or operating in conjunction with any other antenna or transmitter except in accordance with FCC/ISED multi-transmitter guidelines. End users must be provided with transmitter operating conditions for satisfying RF Exposure compliance.

## Europe (CE-RED)

This module is a Radio Equipment Directive assessed radio module that is CE complaint and have been manufactured and tested with the intention of being integrated into a final product.

According to the RED every final product that includes a radio module is also a radio product which falls under the scope of the RED. This means that OEM and host manufacturers are ultimately responsible for the compliance of the host and the module. The final product must be reassessed against all of the essential requirements of the RED before it can be placed on the EU market. This includes reassessing the module for compliance against the following RED articles:

- Article 3.1(a): Health and safety
- Article 3.1(b): Electromagnetic compatibility (EMC)
- Article 3.2: Efficient use of radio spectrum (RF)

The RED knows different conformity assessment procedures to show compliance against the essential requirements (See RED Guide, chapter 2.6b). As long as the radio module can show compliance to Article 3.2 by the use of a harmonized standard, which is listed in the official journal of the EU (OJEU), it is not necessary to do an EU type examination for the final radio product by a notified body. In this case it is possible to demonstrate conformity according to the essential requirements of the RED by using Module A (Annex II of the RED), which allows to show conformity by internal production control.



As long as a harmonized standard listed in the OJEU can be used to demonstrate conformity in accordance with Article 3.2 of the RED, it is possible to carry out the CE certification in self-declaration without the involvement of a notified body.

The K-LD2 shows compliance against the Article 3.2 by the use of the standard EN 300 440 which is a harmonized standard listed in the OJEU, what gives the possibility to show conformity by internal production control.

An OEM integrator can show compliance to article 3.1(a) and 3.1(b) for the final product by doing internal or external tests and following the Module A (Annex II of the RED) assessment procedure. To show compliance against article 3.2 it is possible to reuse the assessment of the K-LD2 as long as it is the only radio module in the final product or if the integrator can guarantee that only one radio module is operating at the same time. Test reports of the K-LD2 are available on request.



The ETSI guide EG 203 367 provides detailed guidance on the application of harmonized standards to multi-radio and combined equipment to demonstrate conformity.

### RF Exposure Information (MPE)

This device has been tested and meets applicable limits for Radio Frequency (RF) exposure. A detailed calculation to show compliance to the RED Article 3.1(a) is available on request.

### Simplified DoC Statement

Hereby, RFbeam Microwave GmbH declares that the radio equipment type K-LD2 is in compliance with Directive 2014/53/EU. The declaration of conformity may be consulted at [www.rfbeam.ch](http://www.rfbeam.ch).

# OUTLINE DIMENSIONS

Figure 14: Outline dimensions in millimeter

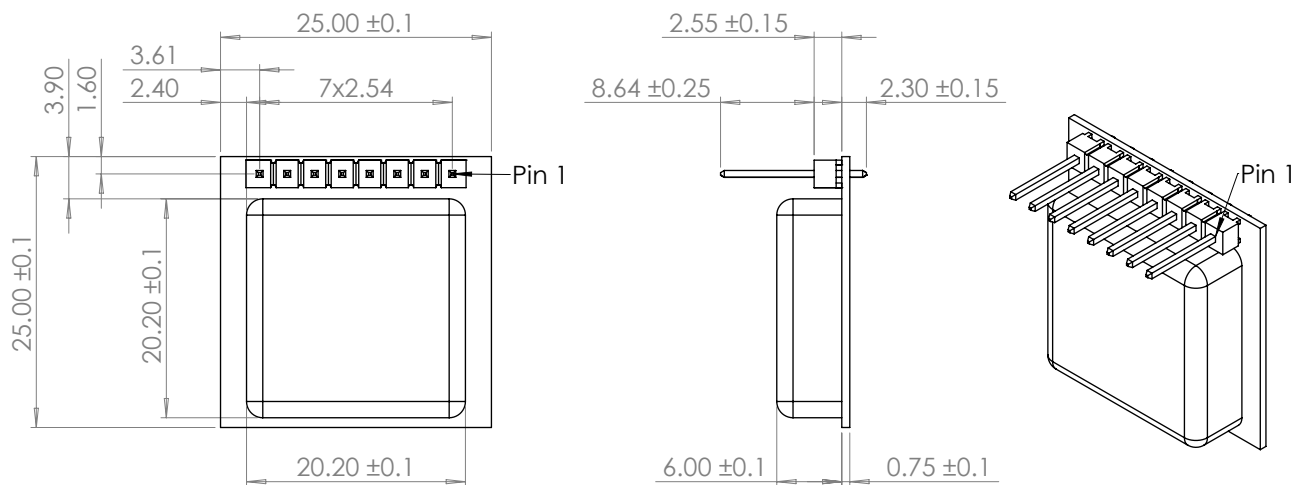

## ORDER INFORMATION

The ordering number consists of different parts with the structure below.

Figure 15: Ordering number structure

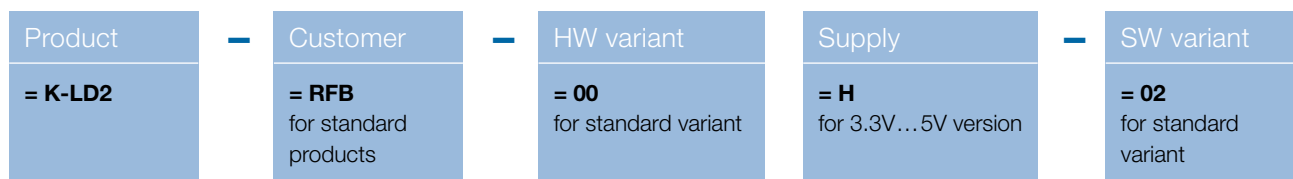

Table 18: Available ordering numbers

Ordering number	Description
K-LD2-RFB-00H-02	Standard K-LD2 with default configuration, without PC software
K-LD2-EVAL-RFB-01H	Standard K-LD2 evaluation kit with powerful PC software



It is possible to order K-LD2 sensors with a preprogrammed custom configuration. Contact RFbeam Microwave for more information.



---

# REVISION HISTORY

06/2017 – Revision A: Initial Version

09/2018 – Revision B: Changes to Figure 2: Antenna characteristic  
Changes to Figure 15: Ordering number structure  
Changes to Table 18: Available ordering numbers  
Added Table of Contents and changed the title format

02/2020 – Revision C: Changed Supply current to RMS and peak current  
Added relative humidity to the operating conditions  
Changed the frequency drift and typical output power  
Added ESD level information  
Added new chapter integrators information

RFbeam does not assume any responsibility for use of any circuitry described, no circuit patent licenses are implied and RFbeam reserves the right at any time without notice to change said circuitry and specifications.