



## Shenzhen Huaxia Testing Technology Co., Ltd

1F., Block A of Tongsheng Technology Building, Huahui Road, Dalang Street, Longhua District, Shenzhen, China

Telephone: +86-755-26648640  
Fax: +86-755-26648637  
Website: [www.cqa-cert.com](http://www.cqa-cert.com)

Report Template Version: V03  
Report Template Revision Date: Mar.1st, 2017

# FCC Test Report

**Report No.:** CQASZ20190400238E-01  
**Applicant:** NINGBO LIANDA WINCH CO.,LTD  
**Address of Applicant:** Yushantou Village,Dongqiao Town,Haishu Dist,Ningbo,China  
**Manufacturer:** NINGBO LIANDA WINCH CO.,LTD  
**Address of Manufacturer:** Yushantou Village,Dongqiao Town,Haishu Dist,Ningbo,China  
**Equipment Under Test (EUT):**  
**Product:** Remote  
**Model No.:** Ld Remote-1  
**Brand Name:** N/A  
**FCC ID:** 2ASYP-LDREMOTE1  
**Standards:** 47 CFR Part 15, Subpart C  
**Date of Test:** 2019-04-11 to 2019-05-07  
**Date of Issue:** 2019-05-07  
**Test Result :** **PASS\***

**Tested By:**

(Daisy Qin)

**Reviewed By:**

(Aaron Ma)

**Approved By:**

  
( Jack Ai)

\* In the configuration tested, the EUT complied with the standards specified above.

The test report is effective only with both signature and specialized stamp, The result(s) shown in this report refer only to the sample(s) tested. Without written approval of CQA, this report can't be reproduced except in full.

## 1 Version

### Revision History Of Report

Report No.	Version	Description	Issue Date
CQASZ20190400238E-01	Rev.01	Initial report	2019-05-07

## 2 Test Summary

Test Item	Test Requirement	Test method	Result
Antenna Requirement	47 CFR Part 15, Subpart C Section 15.203	ANSI C63.10 (2013)	PASS
Field Strength of the Fundamental Signal	47 CFR Part 15, Subpart C Section 15.231 (b)	ANSI C63.10 (2013)	PASS
Spurious Emissions	47 CFR Part 15, Subpart C Section 15.231 (b)/15.209	ANSI C63.10 (2013)	PASS
20dB Bandwidth	47 CFR Part 15, Subpart C Section 15.231 (c)	ANSI C63.10 (2013)	PASS
Dwell Time	47 CFR Part 15, Subpart C Section 15.231 (a)	ANSI C63.10 (2013)	PASS

### 3 Contents

	Page
1 VERSION .....	2
2 TEST SUMMARY .....	3
3 CONTENTS .....	4
4 GENERAL INFORMATION.....	5
4.1 CLIENT INFORMATION .....	5
4.2 GENERAL DESCRIPTION OF EUT .....	5
4.3 TEST ENVIRONMENT AND MODE .....	6
4.4 DESCRIPTION OF SUPPORT UNITS .....	6
4.5 TEST LOCATION .....	6
4.6 TEST FACILITY .....	6
4.7 STATEMENT OF THE MEASUREMENT UNCERTAINTY .....	6
4.8 DEVIATION FROM STANDARDS .....	7
4.9 ABNORMALITIES FROM STANDARD CONDITIONS .....	7
4.10 OTHER INFORMATION REQUESTED BY THE CUSTOMER .....	7
4.11 EQUIPMENT LIST .....	8
5 TEST RESULTS AND MEASUREMENT DATA.....	9
5.1 ANTENNA REQUIREMENT .....	9
5.2 SPURIOUS EMISSIONS .....	10
5.2.1 <i>Duty Cycle</i> .....	10
5.2.2 <i>Spurious Emissions</i> .....	13
5.3 20DB BANDWIDTH .....	21
5.4 DWELL TIME .....	23
6 PHOTOGRAPHS - EUT TEST SETUP .....	25
6.1 RADIATED EMISSION.....	25
7 PHOTOGRAPHS - EUT CONSTRUCTIONAL DETAILS .....	27

## 4 General Information

### 4.1 Client Information

Applicant:	NINGBO LIANDA WINCH CO.,LTD
Address of Applicant:	Yushantou Village,Dongqiao Town,Haishu Dist,Ningbo,China
Manufacturer:	NINGBO LIANDA WINCH CO.,LTD
Address of Manufacturer:	Yushantou Village,Dongqiao Town,Haishu Dist,Ningbo,China

### 4.2 General Description of EUT

Product:	Remote
Model No.:	Ld Remote-1
Trade Mark:	N/A
Hardware Version:	V1.0
Software Version:	V1.0
Sample Type:	Portable production
Operation Frequency:	315MHz
Channel Numbers:	1
Modulation Type:	OOK
Antenna Type:	Printed antenna
Antenna Gain:	0dBi
Power Supply:	lithium battery: DC3.7V 300mA

Note: Using the new battery for testing.

### 4.3 Test Environment and Mode

<b>Operating Environment:</b>	
Temperature:	24.0 °C
Humidity:	52 % RH
Atmospheric Pressure:	1008 mbar
<b>Test mode:</b>	
Transmitting mode:	Keep the EUT in transmitting mode with modulation.

### 4.4 Description of Support Units

The EUT has been tested independent unit.

### 4.5 Test Location

All tests were performed at:

**Shenzhen Huaxia Testing Technology Co., Ltd.,**

1F., Block A of Tongsheng Technology Building, Huahui Road, Dalang Street, Longhua New District, Shenzhen, Guangdong, China

### 4.6 Test Facility

The test facility is recognized, certified, or accredited by the following organizations:

- **CNAS (No. CNAS L5785)**

CNAS has accredited Shenzhen Huaxia Testing Technology Co., Ltd. Shenzhen Branch EMC Lab to ISO/IEC 17025:2005 General Requirements for the Competence of Testing and Calibration Laboratories (CNAS-CL01 Accreditation Criteria for the Competence of Testing and Calibration Laboratories) for the competence in the field of testing.

- **ISED Registration No.: 22984-1**

The 3m Semi-anechoic chamber of Shenzhen Huaxia Testing Technology Co., Ltd. has been registered by Certification and Engineering Bureau of Industry Canada for radio equipment testing

- **A2LA (Certificate No. 4742.01)**

Shenzhen Huaxia Testing Technology Co., Ltd., Shenzhen EMC Laboratory is accredited by the American Association for Laboratory Accreditation(A2LA). Certificate No. 4742.01.

- **FCC Registration No.: 522263**

Shenzhen Huaxia Testing Technology Co., Ltd., Shenzhen EMC Laboratory has been registered and fully described in a report filed with the (FCC) Federal Communications Commission. The acceptance letter from the FCC is maintained in our files. Registration No.:522263

### 4.7 Statement of the measurement uncertainty

The data and results referenced in this document are true and accurate.

The reader is cautioned that there may be errors within the calibration limits of the equipment and facilities.

The measurement uncertainty was calculated for all measurements listed in this test report acc. to CISPR 16 - 4 „Specification for radio disturbance and immunity measuring apparatus and methods – Part 4: Uncertainty in EMC Measurements“ and is documented in the **Shenzhen Huaxia Testing Technology Co., Ltd.** quality system acc. to DIN EN ISO/IEC 17025.

Furthermore, component and process variability of devices similar to that tested may result in additional

deviation. The manufacturer has the sole responsibility of continued compliance of the device.

Hereafter the best measurement capability for CQA laboratory is reported:

Test	Range	Uncertainty	Notes
Radiated Emission	Below 1GHz	$\pm 5.12\text{dB}$	(1)
Radiated Emission	Above 1GHz	$\pm 4.60\text{dB}$	(1)
Conducted Disturbance	0.15~30MHz	$\pm 3.34\text{dB}$	(1)

(1) This uncertainty represents an expanded uncertainty expressed at approximately the 95% confidence level using a coverage factor of  $k=2$ .

#### 4.8 Deviation from Standards

None.

#### 4.9 Abnormalities from Standard Conditions

None.

#### 4.10 Other Information Requested by the Customer

None.

## 4.11 Equipment List

Test Equipment	Manufacturer	Model No.	Instrument No.	Calibration Date	Calibration Due Date
EMI Test Receiver	R&S	ESR7	CQA-005	2018/9/26	2019/9/25
Spectrum analyzer	R&S	FSU26	CQA-038	2018/10/28	2019/10/27
Preamplifier	MITEQ	AFS4-00010300-18-10P-4	CQA-035	2018/9/26	2019/9/25
Preamplifier	MITEQ	AMF-6D-02001800-29-20P	CQA-036	2018/11/2	2019/11/1
Loop antenna	Schwarzbeck	FMZB1516	CQA-087	2018/10/28	2020/10/27
Bilog Antenna	R&S	HL562	CQA-011	2018/9/26	2020/9/25
Horn Antenna	R&S	HF906	CQA-012	2018/9/26	2020/9/25
Horn Antenna	Schwarzbeck	BBHA 9170	CQA-088	2018/9/26	2020/9/25
Coaxial Cable (Above 1GHz)	CQA	N/A	C019	2018/9/26	2019/9/25
Coaxial Cable (Below 1GHz)	CQA	N/A	C020	2018/9/26	2019/9/25
Antenna Connector	CQA	RFC-01	CQA-080	2018/9/26	2019/9/25
RF cable(9KHz~40GHz)	CQA	RF-01	CQA-079	2018/9/26	2019/9/25
Power divider	MIDWEST	PWD-2533-02-SMA-79	CQA-067	2018/9/26	2019/9/25

Note:

The temporary antenna connector is soldered on the PCB board in order to perform conducted tests and this temporary antenna connector is listed in the equipment list.



## 5 Test results and Measurement Data

### 5.1 Antenna Requirement

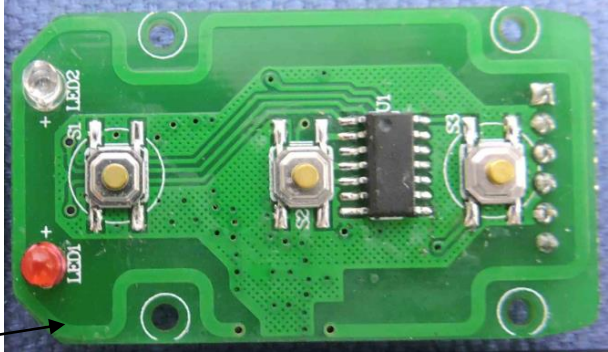
<b>Standard requirement:</b>	47 CFR Part 15C Section 15.203
<p>15.203 requirement:          An intentional radiator shall be designed to ensure that no antenna other than that furnished by the responsible party shall be used with the device. The use of a permanently attached antenna or of an antenna that uses a unique coupling to the intentional radiator, the manufacturer may design the unit so that a broken antenna can be replaced by the user, but the use of a standard antenna jack or electrical connector is prohibited.</p>	
<b>EUT Antenna:</b>	
<p>The antenna is integrated on the main PCB and no consideration of replacement. The best case gain of the antenna is 0dBi.</p>	

## 5.2 Spurious Emissions

### 5.2.1 Duty Cycle

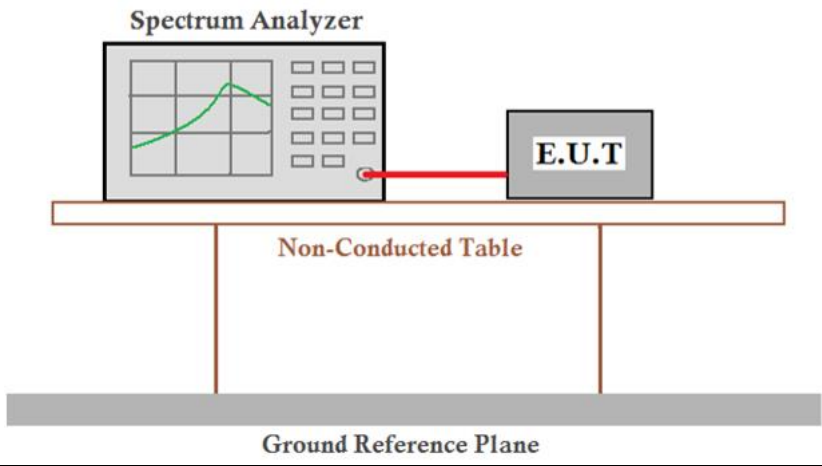
Test Requirement:	47 CFR Part 15C Section 15.35 (c)
Test Method:	ANSI C63.10:2013
Test Setup:	
Limit:	N/A
Test Mode:	Transmitting mode
Instruments Used:	Refer to section 4.11 for details
Test Results:	Pass

Duty cycle numbers	T period (ms)	T on time (ms)	Duty cycle
57	71.955	32.217	0.448

Note:  $T \text{ on time} = 0.481 \times 27 + 0.641 \times 30 = 32.217 \text{ms}$ ,

$\text{Duty cycle} = T \text{ on time} / T \text{ period}$

Test plot as follows:

Duty cycle numbers :

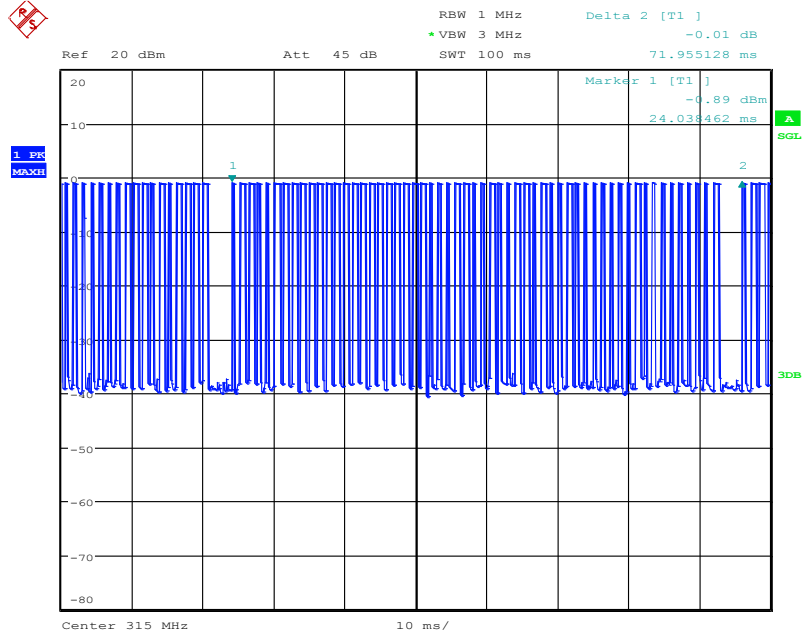

Date: 25.APR.2019 09:29:05

T period:

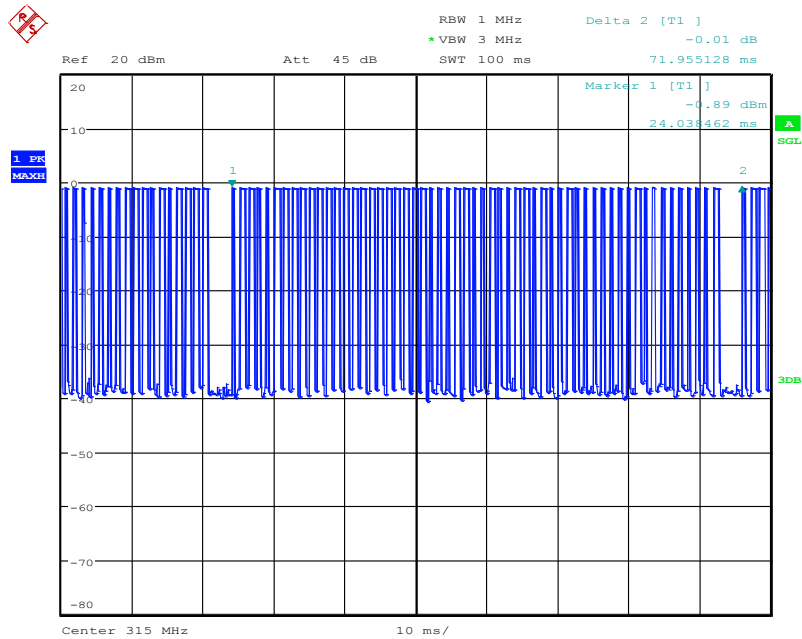

Date: 25.APR.2019 09:29:05

T on time:

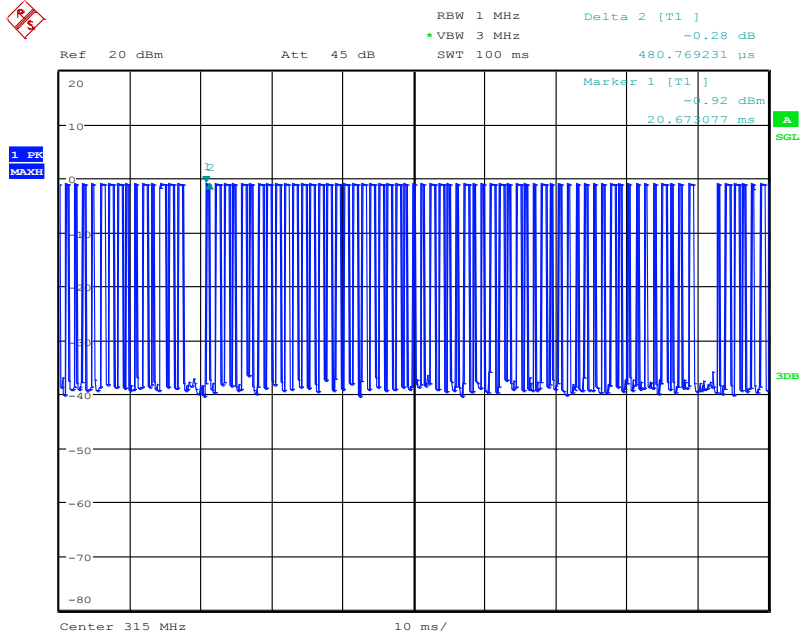

Date: 25.APR.2019 09:33:20

T on time:

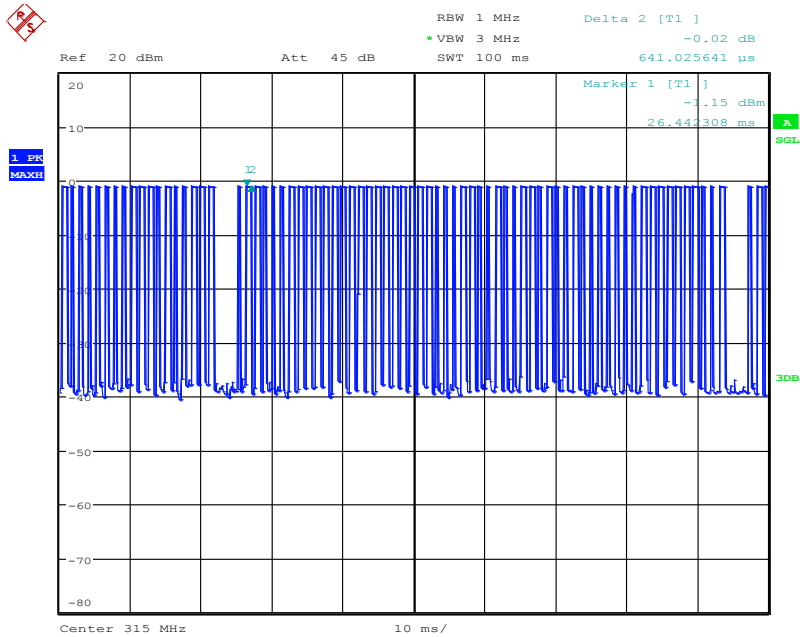

Date: 25.APR.2019 09:34:38

## 5.2.2 Spurious Emissions

Test Requirement:	47 CFR Part 15C Section 15.231(b) and 15.209				
Test Method:	ANSI C63.10: 2013				
Test Site:	Measurement Distance: 3m (Semi-Anechoic Chamber)				
Receiver Setup:	Frequency	Detector	RBW	VBW	Remark
	0.009MHz-0.090MHz	Peak	10kHz	30kHz	Peak
	0.009MHz-0.090MHz	Average	10kHz	30kHz	Average
	0.090MHz-0.110MHz	Quasi-peak	10kHz	30kHz	Quasi-peak
	0.110MHz-0.490MHz	Peak	10kHz	30kHz	Peak
	0.110MHz-0.490MHz	Average	10kHz	30kHz	Average
	0.490MHz -30MHz	Quasi-peak	10kHz	30kHz	Quasi-peak
	30MHz-1GHz	Quasi-peak	100 kHz	300kHz	Quasi-peak
	Above 1GHz	Peak	1MHz	3MHz	Peak
Peak		1MHz	10Hz	Average	
Limit: (Spurious Emissions)	Frequency	Field strength (microvolt/meter)	Limit (dBuV/m)	Remark	Measurement distance (m)
	0.009MHz-0.490MHz	2400/F(kHz)	-	-	300
	0.490MHz-1.705MHz	24000/F(kHz)	-	-	30
	1.705MHz-30MHz	30	-	-	30
	30MHz-88MHz	100	40.0	Quasi-peak	3
	88MHz-216MHz	150	43.5	Quasi-peak	3
	216MHz-960MHz	200	46.0	Quasi-peak	3
	960MHz-1GHz	500	54.0	Quasi-peak	3
	Above 1GHz	500	54.0	Average	3
Note: 15.35(b), Unless otherwise specified, the limit on peak radio frequency emissions is 20dB above the maximum permitted average emission limit applicable to the equipment under test. This peak limit applies to the total peak emission level radiated by the device.					
Limit: (Field strength of the fundamental signal)	Frequency	Limit (dBuV/m @3m)	Remark		
	315MHz	75.6	Average Value		
		95.6	Peak Value		
Test Procedure:	a. 1) Below 1G: The EUT was placed on the top of a rotating table 0.8 meters above the ground at a 3 meter semi-anechoic chamber. The table was rotated 360 degrees to determine the position of the highest radiation. 2) Above 1G: The EUT was placed on the top of a rotating table 1.5 meters above				

	<p>the ground at a 3 meter semi-anechoic chamber. The table was rotated 360 degrees to determine the position of the highest radiation.</p> <p>Note: For the radiated emission test above 1GHz:</p> <p>Place the measurement antenna away from each area of the EUT determined to be a source of emissions at the specified measurement distance, while keeping the measurement antenna aimed at the source of emissions at each frequency of significant emissions, with polarization oriented for maximum response. The measurement antenna may have to be higher or lower than the EUT, depending on the radiation pattern of the emission and staying aimed at the emission source for receiving the maximum signal. The final measurement antenna elevation shall be that which maximizes the emissions. The measurement antenna elevation for maximum emissions shall be restricted to a range of heights of from 1 m to 4 m above the ground or reference ground plane.</p> <ol style="list-style-type: none"> <li>The EUT was set 3 meters away from the interference-receiving antenna, which was mounted on the top of a variable-height antenna tower.</li> <li>The antenna height is varied from one meter to four meters above the ground to determine the maximum value of the field strength. Both horizontal and vertical polarizations of the antenna are set to make the measurement.</li> <li>For each suspected emission, the EUT was arranged to its worst case and then the antenna was tuned to heights from 1 meter to 4 meters (for the test frequency of below 30MHz, the antenna was tuned to heights 1 meter) and the rotatable table was turned from 0 degrees to 360 degrees to find the maximum reading.</li> <li>The test-receiver system was set to Peak Detect Function and Specified Bandwidth with Maximum Hold Mode.</li> <li>If the emission level of the EUT in peak mode was 10dB lower than the limit specified, then testing could be stopped and the peak values of the EUT would be reported. Otherwise the emissions that did not have 10dB margin would be re-tested one by one using peak, quasi-peak or average method as specified and then reported in a data sheet.</li> <li>The radiation measurements are performed in X, Y, Z axis positioning. And found the Z axis positioning which is worse case, Only the test worst case mode is recorded in the report.</li> </ol>
Test Setup:	

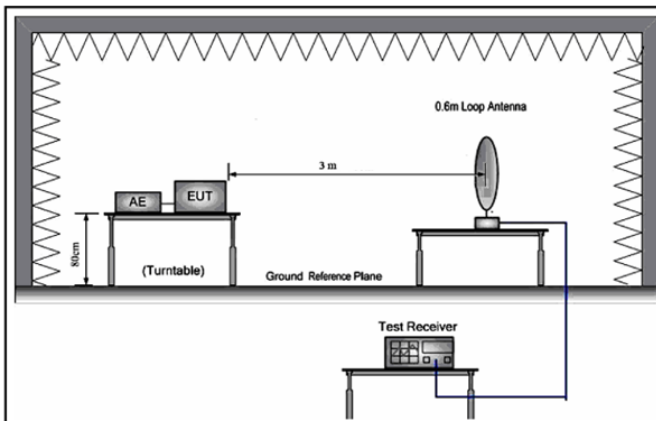

Figure 1. Below 30MHz

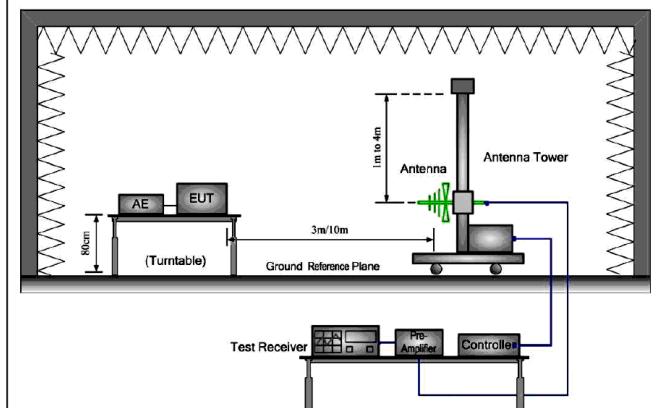

Figure 2. 30MHz to 1GHz

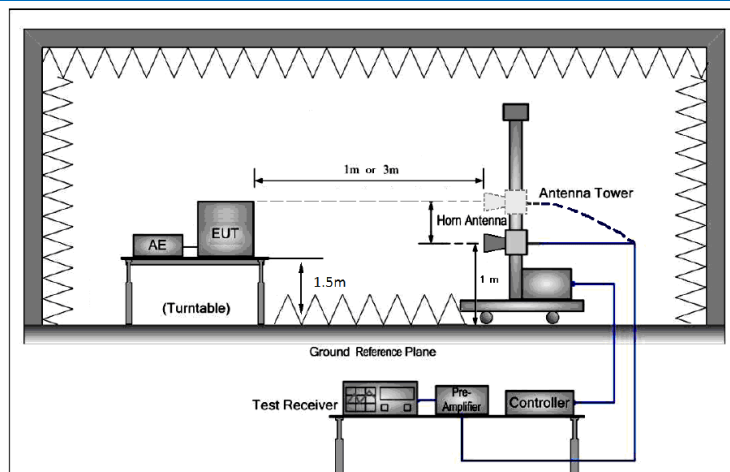

Figure 3. Above 1 GHz

Test Mode:	Transmitting mode
Instruments Used:	Refer to section 4.11 for details
Test Results:	Pass

**Measurement Data**

**5.2.2.1 Field Strength Of The Fundamental Signal**

Average value:	
Calculate Formula:	Average value=Peak value + PDCF
	PDCF=20 log(Duty cycle)
	Duty cycle= T on time / T period
Test data:	T on time =32.217ms
	T period =71.955ms
	PDCF= -6.98

Antenna polarization: Horizontal						
Frequency (MHz)	Read Level (dBuV)	Factor (dB)	Level (dBuV/m)	Limit Line (dBuV/m)	Over Limit (dB)	Polarization
315	52.71	22.02	74.73	95.6	-20.87	Peak
315	-	-	67.75	75.6	-7.85	Average

Antenna polarization: Vertical						
Frequency (MHz)	Read Level (dBuV)	Factor (dB)	Level (dBuV/m)	Limit Line (dBuV/m)	Over Limit (dB)	Polarization
315	46.70	22.02	68.72	95.6	-26.88	Peak
315	-	-	48.74	75.6	-13.86	Average

Remark:

The field strength is calculated by adding the Antenna Factor, Cable Factor & Preamplifier. The basic equation with a sample calculation is as follows:

Final Test Level =Receiver Reading + Antenna Factor + Cable Factor – Preamplifier Factor



5.2.2.2 Spurious Emissions

9KHz-30MHz

9 kHz~30 MHz Field Strength of Unwanted Emissions. Quasi-Peak Measurement

The measurements with active loop antenna were greater than 20dB below the limit, so the test data were not recorded in the test report.

Below 1GHz (30MHz-1GHz)

Horizontal

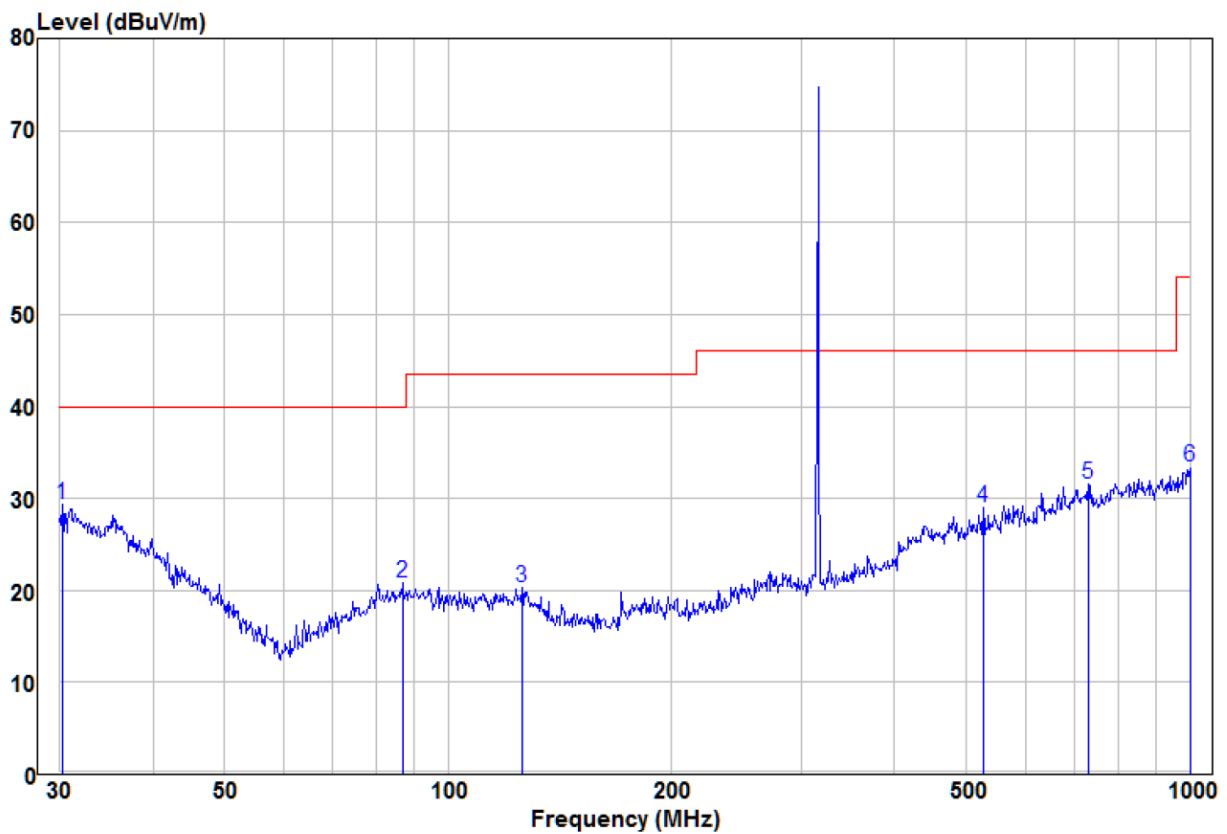

	Read Freq	Read Level	Read Factor	Limit Level	Limit Line	Over Limit	Remark	Pol/Phase	
	MHz	dBuV	dB/m	dBuV/m	dBuV/m	dB			
1	pp	30.21	1.06	28.23	29.29	40.00	-10.71	Peak	HORIZONTAL
2		86.81	1.06	19.84	20.90	40.00	-19.10	Peak	HORIZONTAL
3		125.89	-0.09	20.37	20.28	43.50	-23.22	Peak	HORIZONTAL
4		526.40	1.42	27.51	28.93	46.00	-17.07	Peak	HORIZONTAL
5		729.36	1.29	30.22	31.51	46.00	-14.49	Peak	HORIZONTAL
6		1000.00	0.38	33.08	33.46	54.00	-20.54	Peak	HORIZONTAL

Vertical

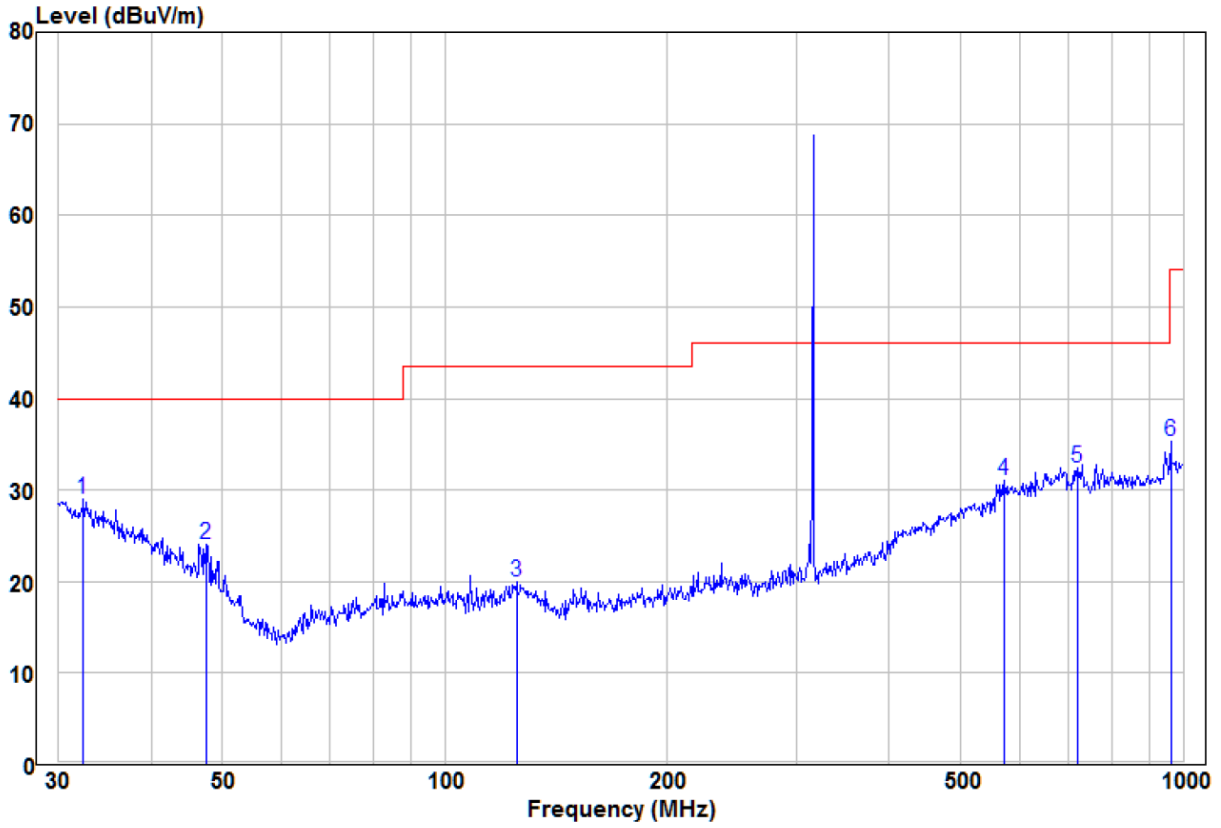

	Read	Limit	Over						
	Freq	Level	Factor	Level	Line	Limit	Remark	Pol/Phase	
	MHz	dBuV	dB/m	dBuV/m	dBuV/m	dB			
1	pp	32.41	1.65	27.44	29.09	40.00	-10.91	Peak	VERTICAL
2		47.49	3.65	20.42	24.07	40.00	-15.93	Peak	VERTICAL
3		125.01	-0.37	20.41	20.04	43.50	-23.46	Peak	VERTICAL
4		572.61	3.02	27.96	30.98	46.00	-15.02	Peak	VERTICAL
5		719.20	2.33	30.15	32.48	46.00	-13.52	Peak	VERTICAL
6		962.16	3.30	32.01	35.31	54.00	-18.69	Peak	VERTICAL

Above 1GHz(1GHz-4GHz)

Horizontal

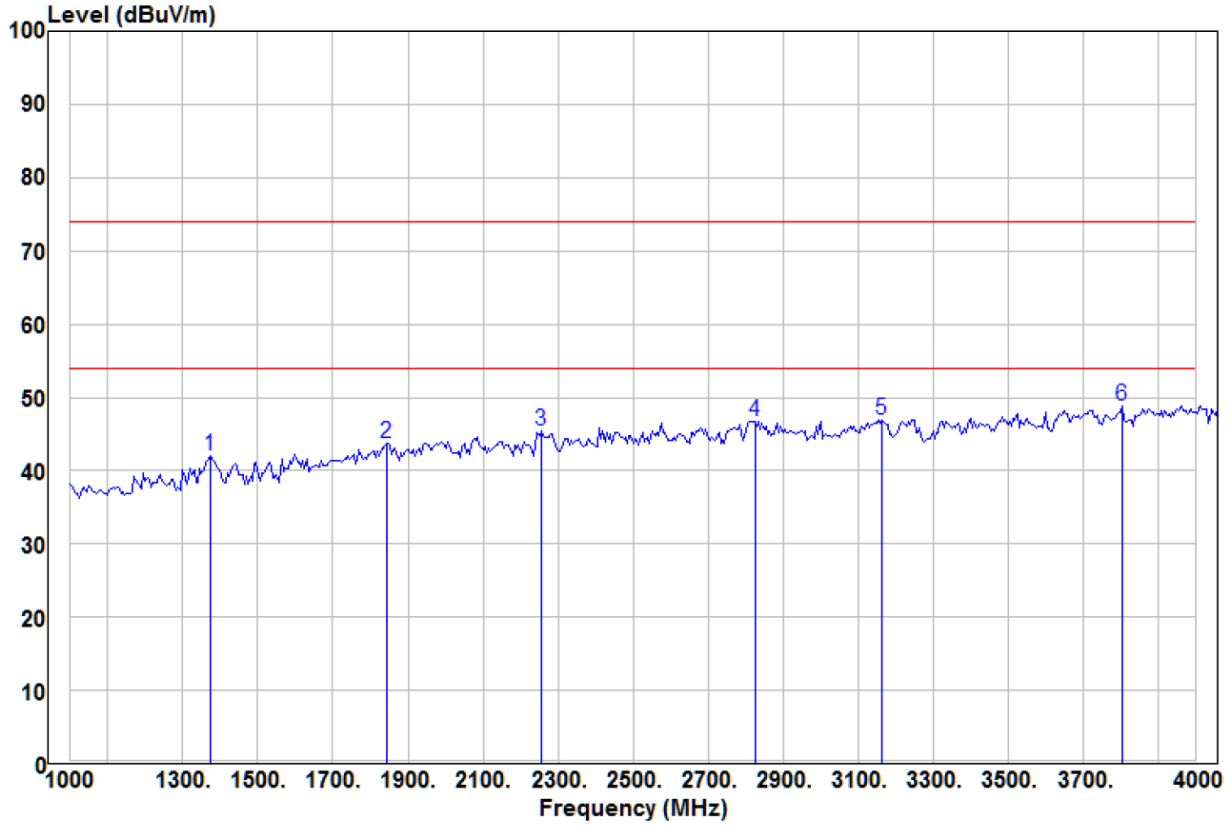

	Read Freq	Read Level	Factor	Level	Limit Line	Over Limit	Remark	Pol/Phase
	MHz	dBuV	dB/m	dBuV/m	dBuV/m	dB		
1	1375.00	56.39	-14.44	41.95	74.00	-32.05	Peak	HORIZONTAL
2	1845.00	52.68	-8.96	43.72	74.00	-30.28	Peak	HORIZONTAL
3	2255.00	55.10	-9.68	45.42	74.00	-28.58	Peak	HORIZONTAL
4	2825.00	54.50	-7.71	46.79	74.00	-27.21	Peak	HORIZONTAL
5	3165.00	52.19	-5.19	47.00	74.00	-27.00	Peak	HORIZONTAL
6 pp	3805.00	51.28	-2.51	48.77	74.00	-25.23	Peak	HORIZONTAL

Vertical:

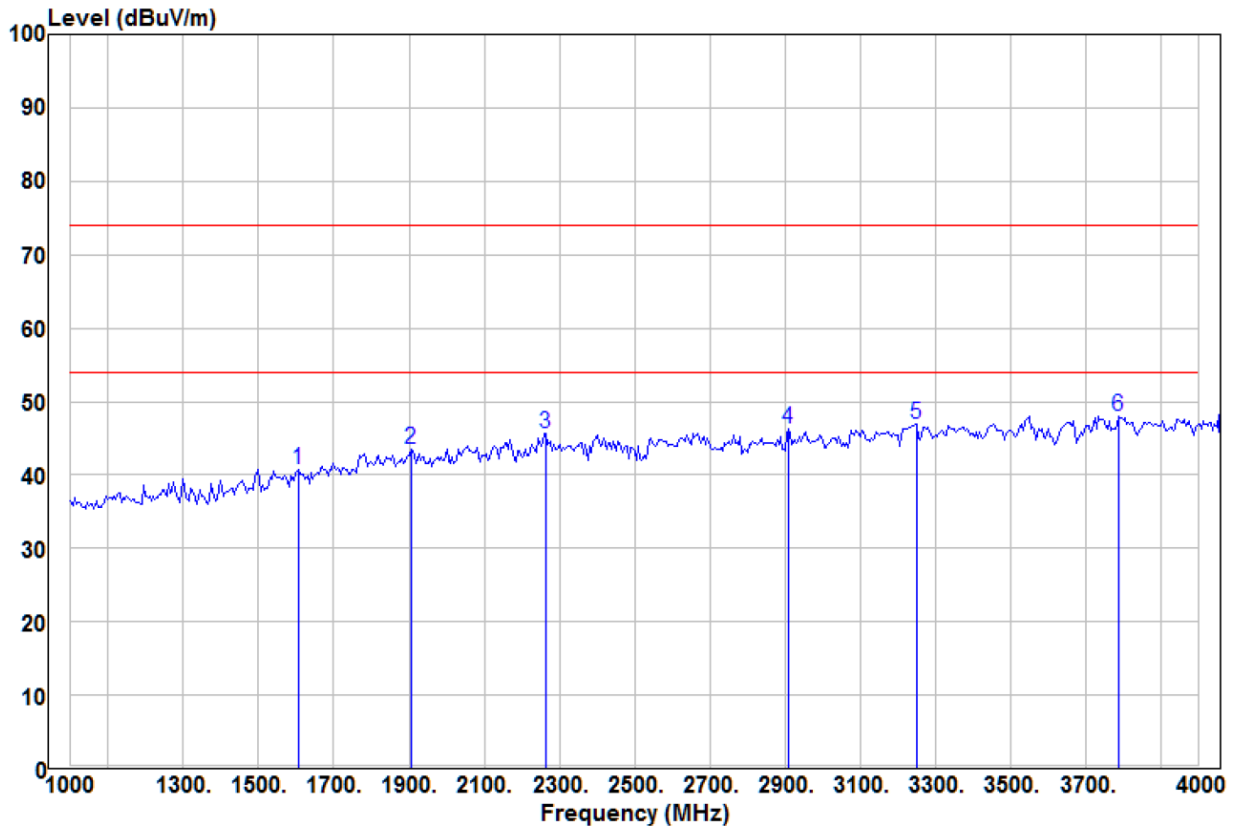

	Read			Limit	Over			
Freq	Level	Factor	Level	Line	Limit	Remark	Pol/Phase	
MHz	dBuV	dB/m	dBuV/m	dBuV/m	dB			
1	1605.00	53.95	-13.13	40.82	74.00	-33.18	Peak	VERTICAL
2	1905.00	51.74	-8.16	43.58	74.00	-30.42	Peak	VERTICAL
3	2265.00	55.26	-9.60	45.66	74.00	-28.34	Peak	VERTICAL
4	2910.00	53.49	-7.28	46.21	74.00	-27.79	Peak	VERTICAL
5	3250.00	51.83	-5.00	46.83	74.00	-27.17	Peak	VERTICAL
6 pp	3790.00	50.58	-2.55	48.03	74.00	-25.97	Peak	VERTICAL

Remark:

- 1) The field strength is calculated by adding the Antenna Factor, Cable Factor & Preamplifier. The basic equation with a sample calculation is as follows:  
Final Test Level = Receiver Reading + Antenna Factor + Cable Factor – Preamplifier Factor
- 2) The disturbance above 5GHz was very low, and the above harmonics were the highest point could be found when testing, so only the above harmonics had been displayed.
- 3) As shown in this section, for frequencies above 1GHz, the field the strength limits are based on average limits. However, the peak field strength of any emission shall not exceed the maximum permitted aver average limits. Specified above by more than 20dB under any condition of modulation. So, only the peak measurements were show in the report.

### 5.3 20dB Bandwidth

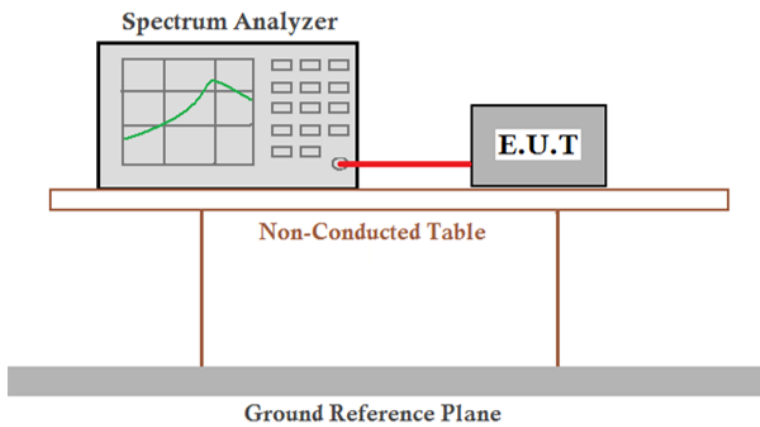
Test Requirement:	47 CFR Part 15C Section 15.231 (c)
Test Method:	ANSI C63.10:2013
Limit:	The bandwidth of the emission shall be no wider than 0.25% of the center frequency for devices operating above 70 MHz and below 900 MHz. For devices operating above 900 MHz, the emission shall be no wider than 0.5% of the center frequency. Bandwidth is determined at the points 20 dB down from the modulated carrier.
Test Setup:	 <p>The diagram illustrates the test setup. A Spectrum Analyzer is connected to an E.U.T. (Equipment Under Test) via a red cable. Both are placed on a Non-Conducted Table, which is supported by a Ground Reference Plane.</p>
Test Mode:	Transmitting mode
Instruments Used:	Refer to section 4.11 for details
Test Results:	Pass

#### Measurement Data

20dB bandwidth (KHz)	Limit (MHz)	Results
8.654	0.7875	PASS

Test plot as follows:

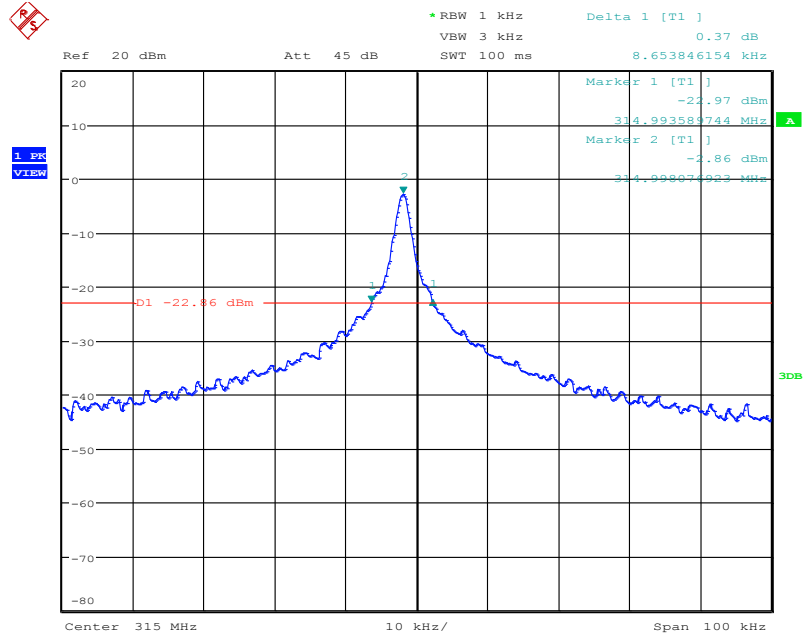

Date: 25.APR.2019 08:53:48

### 5.4 Dwell time

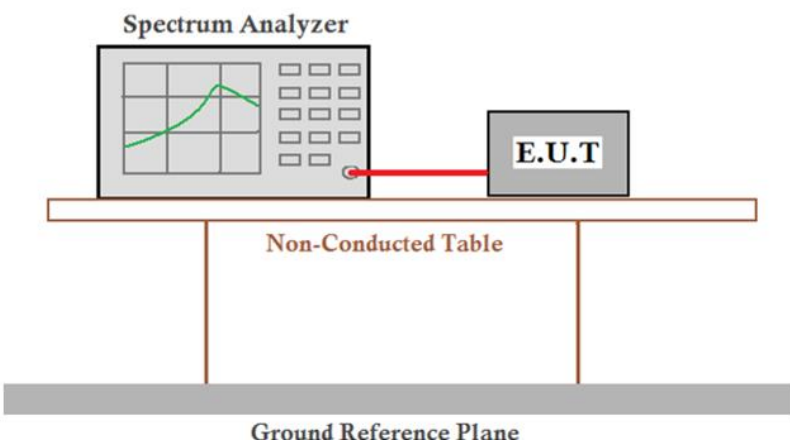
Test Requirement:	47 CFR Part 15C Section 15.231 (a)
Test Method:	ANSI C63.10:2013
Test Setup:	
Test Mode:	Transmitting mode
Instruments Used:	Refer to section 5.11 for details
Test Results:	Pass

**Requirements:**

**1. Regulation 15.231 (a)** The provisions of this Section are restricted to periodic operation within the band 40.66~40.70 MHz and above 70 MHz. Except as shown in paragraph (e) of this Section, the intentional radiator is restricted to the transmission of a control signal such as those used with alarm systems, door openers, remote switches, etc. Radio control of toys is not permitted. Continuous transmissions, such as voice or video, and data transmissions are not permitted. The prohibition against data transmissions does not preclude the use of recognition codes. Those codes are used to identify the sensor that is activated or to identify the particular component as being part of the system.

**Result:**

The EUT is a remote switch without audio or video transmitted.

The EUT meets the requirements of this section.

**2. Regulation 15.231 (a1)** A manually operated transmitter shall employ a switch that will automatically deactivate the transmitter within not more than 5 seconds of being released.

**Result:**

Test item	Limit (MHz)	Results
Transmitting time	≤5S	4.455128S

Test plot as follows:

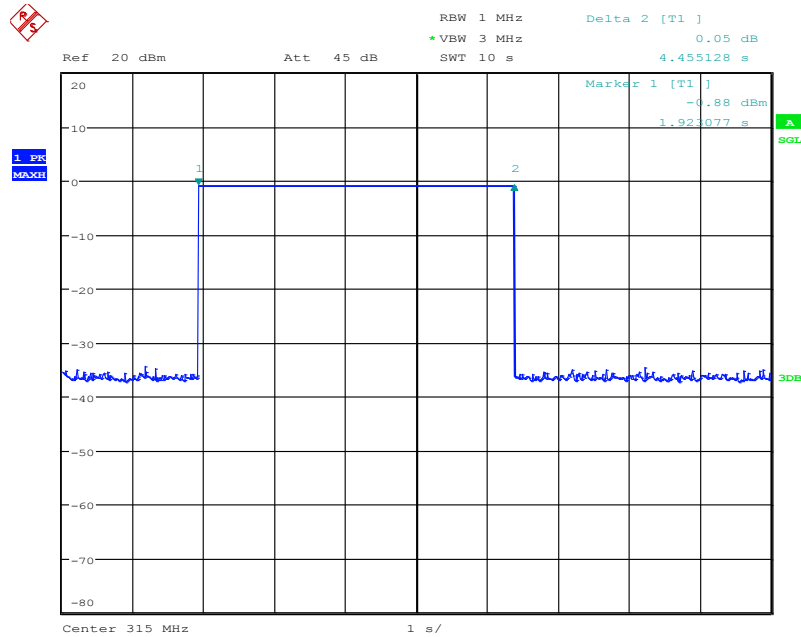

Date: 25.APR.2019 09:26:44

**3. Regulation 15.231 (a2)** A transmitter activated automatically shall cease transmission within 5 seconds after activation.

**Result:**

The EUT does not have automatic transmission.

**4. Regulation 15.231 (a3)** Periodic transmissions at regular predetermined intervals are not permitted. However, polling or supervision transmissions to determine system integrity of transmitters used in security or safety applications are allowed if the periodic rate of transmission does not exceed one transmission of not more than one second duration per hour for each transmitter.

**Result:**

The EUT does not employ periodic transmission.

**5. Regulation 15.231 (a4)** Intentional radiators which are employed for radio control purposes during emergencies involving fire, security, and safety of life, when activated to signal an alarm, may operate during the pendency of the alarm condition.

**Result:**

This section is not applicable to the EUT.



## 6 Photographs - EUT Test Setup

### 6.1 Radiated Emission

9kHz~30MHz:



30MHz~1GHz:

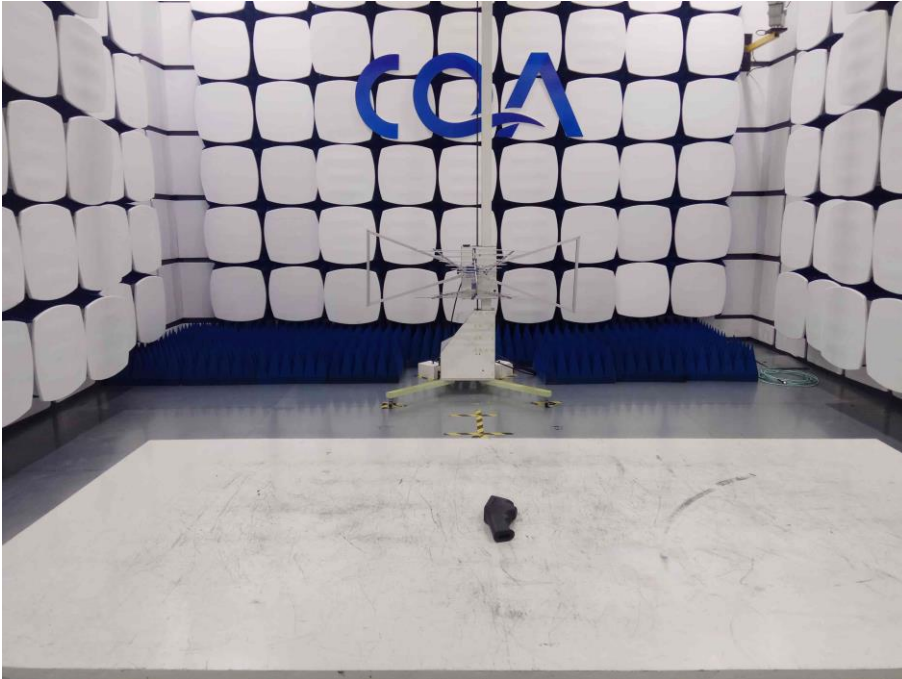

Above 1GHz:

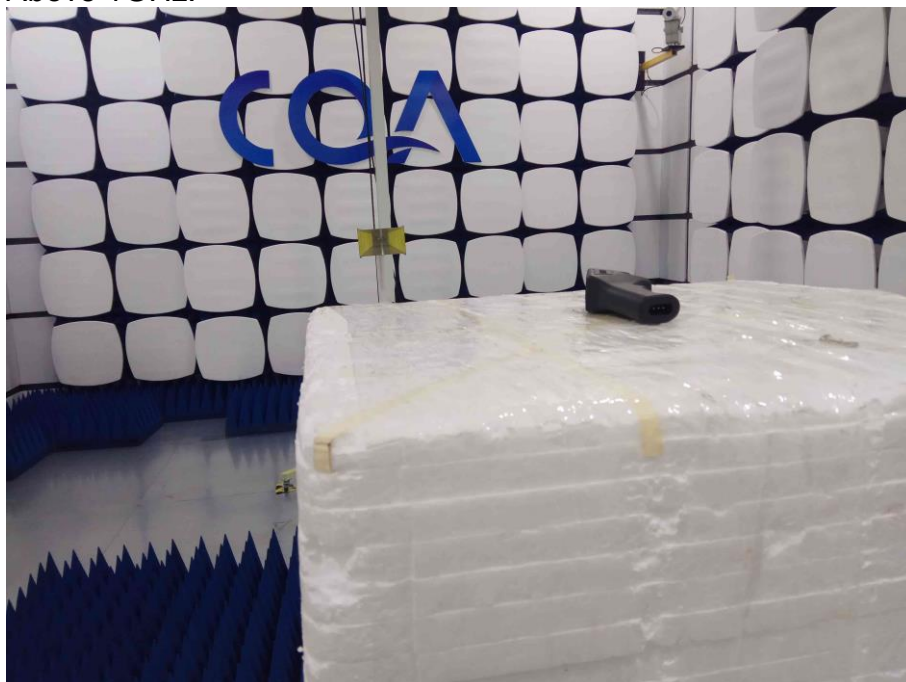

## 7 Photographs - EUT Constructional Details







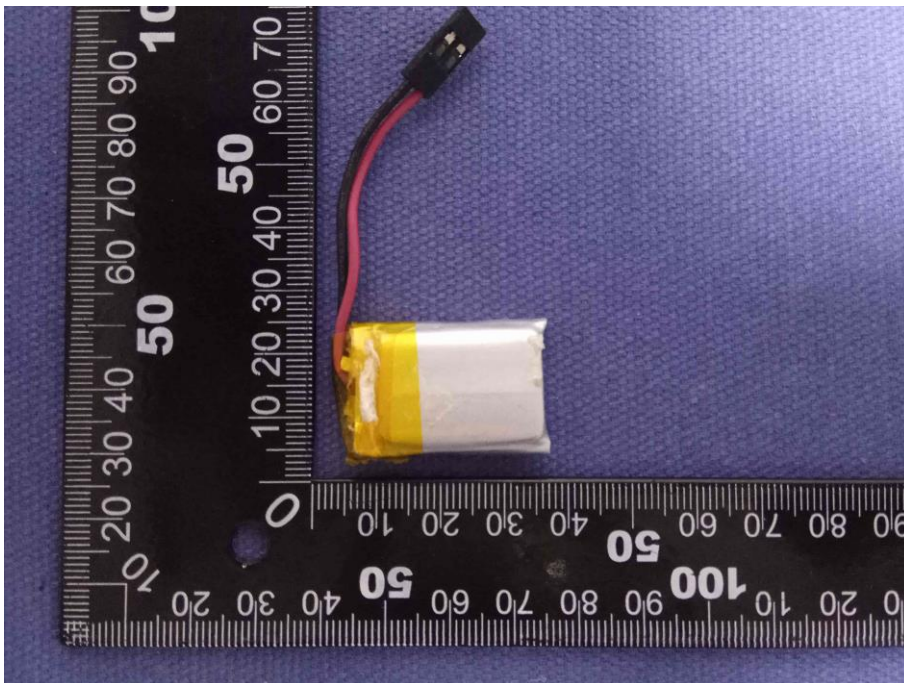

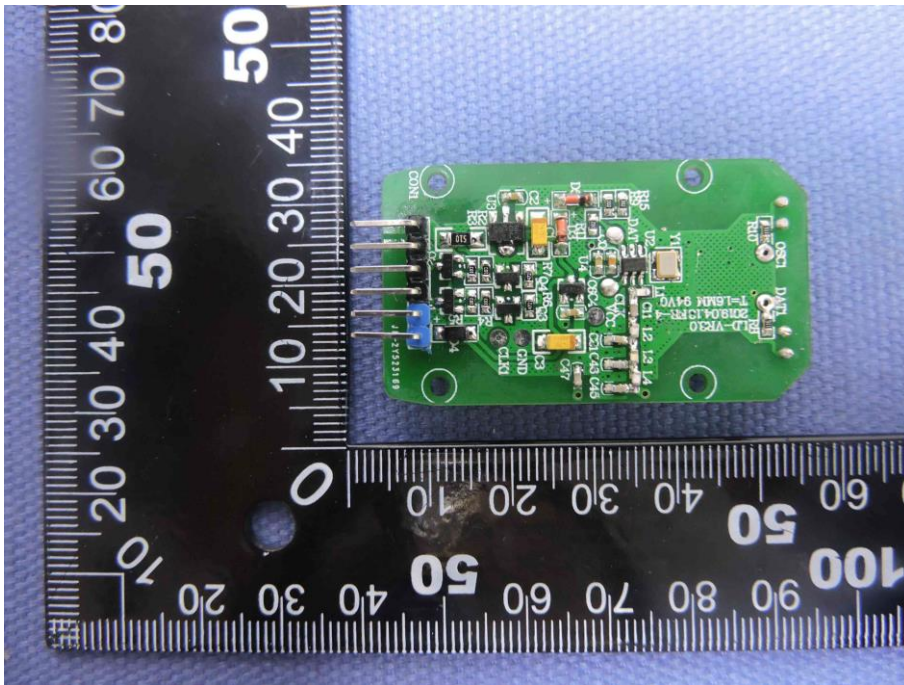
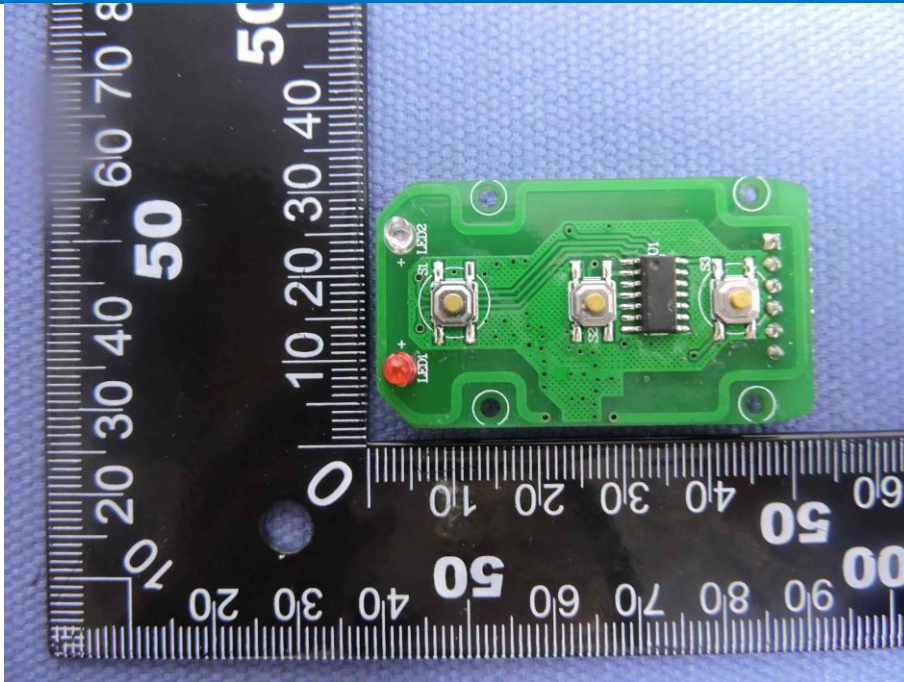

The End