

Owner's Manual & Safety Instructions

Save This Manual Keep this manual for the safety warnings and precautions, assembly, operating, inspection, maintenance and cleaning procedures. Write the product's serial number in the back of the manual near the assembly diagram (or month and year of purchase if product has no number). Keep this manual and the receipt in a safe and dry place for future reference.

20d

BADLAND[®] APEX[™]

TRUCK / SUV WINCH Wireless remote
DW12K
12000 LB.



Visit our website at: <http://www.harborfreight.com>
Email our technical support at: productsupport@harborfreight.com

56385

When unpacking, make sure that the product is intact and undamaged. If any parts are missing or broken, please call 1-888-866-5797 as soon as possible.

Copyright© 2019 by Harbor Freight Tools®. All rights reserved.
No portion of this manual or any artwork contained herein may be reproduced in any shape or form without the express written consent of Harbor Freight Tools. Diagrams within this manual may not be drawn proportionally. Due to continuing improvements, actual product may differ slightly from the product described herein. Tools required for assembly and service may not be included.

⚠WARNING

Read this material before using this product.
Failure to do so can result in serious injury.
SAVE THIS MANUAL.

Table of Contents

Specifications	2	Maintenance	14
Safety	3	Parts List and Diagram	18
Setup	6	Warranty	20
Operation	13		

Specifications





Rated Single Line Pull	12,000 lb (5443 kg)	Fairlead	Aluminum Fairlead
Application	Vehicle Recovery / For Trucks and SUV's	Sound Rating	85 dB
Motor	12VDC Series Wound	Synthetic Rope Size / Type	Ø0.375" x 80' (Ø9.5mm x 24.4m)
Power IN & Power OUT	Yes	Battery	12VDC Minimum 650 CCA
Duty Cycle Rating	5% (45 sec at Max Rated Load; 14 min, 15 sec Rest)	Battery Cables	Minimum 2 AWGx6'
Remote Control	Wireless/Wired, 12 ft (3.7m) long	Mounting Bolt Pattern	10" x 4.5" (254 mm x 114.3mm)
Gear Train	3-Stage Planetary	Mounting Hardware	Winch: 8x Gr8.8, M10 x 30mm Fairlead: 2x Gr8.8, M12 x 40mm
Gear Ratio	210:1	Overall Dimensions (L x D x H)	23.2" x 6.67" x 9.96" (590mm x 169.5mm x 253mm)
Freespool	Rotating Ring Gear	Shipping Weight	80 lb (36.2 kg)
Brake	Automatic Load Holding	IP Rating	IP68 / IP69K
Drum (Dia. X L)	2.5" x 8.8" (64mm x 224mm)		
Clevis Hook	3/8", Replaceable with Spring-loaded Safety Latch		











Layer	Rated Line Pull	Synthetic Rope Capacity
1	12000 lb (5443 kg)	16.3' (5m)
2	9517 lb (4317 kg)	37' (11m)
3	7885 lb (3577 kg)	60' (18.3m)
4	6732 lb (3,054 kg)	80' (24.4m)



First Layer of Synthetic Rope Performance

	Line Pull lb (kg)	Line Speed fpm (mpm)	Amp Draw (@ 12V)
1	0 (0)	31.5 (9.6)	60
	3000 (1361)	12.1 (3.7)	166
	6000 (2722)	8.9 (2.7)	259
	9000 (4082)	6.7 (2.0)	349
	12000 (5443)	4.7 (1.43)	448

WARNING SYMBOLS AND DEFINITIONS

	This is the safety alert symbol. It is used to alert you to potential personal injury hazards. Obey all safety messages that follow this symbol to avoid possible injury or death.
	Indicates a hazardous situation which, if not avoided, will result in death or serious injury.
	Indicates a hazardous situation which, if not avoided, could result in death or serious injury.
	Indicates a hazardous situation which, if not avoided, could result in minor or moderate injury.
	Addresses practices not related to personal injury.

Symbol	Property or Statement
	Wear heavy-duty, cut- and abrasion-resistant leather gloves.
	Wear ANSI-approved safety glasses.
	Cut or sever hazard.
	Roller entanglement hazard.
	Hot surface burn hazard.
	Fire hazard.
	Caustic chemical (acid) hazard.
	Explosion hazard.
	Do not loop the synthetic rope around object and hook onto itself.
	Do not place finger(s) through hook. Fingers may be caught and get pulled into fairlead or drum.
	Pull hook using strap only.

Symbol	Property or Statement
	Do not use winch in overwind orientation. (Synthetic rope enters/exits at the top.)
	Use winch only in underwind orientation. (Synthetic rope enters/exits at the bottom.)
VDC	Volts Direct Current
A	Amperes
CCA	Cold Cranking Amperes
HP	Horsepower
fpm	Feet Per Minute
mpm	Meters Per Minute
RPM	Revolutions Per Minute
IP	International Protection rating Classifies the degrees of protection provided against the intrusion of solid objects, dust, accidental contact, and water.
G8	Grade 8 A fastener strength rating.

IMPORTANT SAFETY INFORMATION



WARNING! Read all instructions. Failure to follow all instructions listed on page 4 may result in fire, serious injury and/or DEATH.

The warnings and precautions discussed in this manual cannot cover all possible conditions and situations that may occur. It must be understood by the operator that common sense and caution are factors which cannot be built into this product, but must be supplied by the operator.

Installation Precautions



1. Do not wear loose clothing or jewelry, as they can be caught in moving parts. Non-skid footwear is recommended. Wear restrictive hair covering to contain long hair.
2. Wear ANSI-approved safety goggles and heavy-duty leather work gloves during installation.
3. Before installation confirm that area is clear of fuel lines, brake lines, electrical wires, gas tanks or any other component which could be damaged during drilling.
4. Mounting location and hardware must support Winch and load.
5. Use supplied power cords and synthetic rope listed in manual only. Do not use thinner/longer cables or link multiple cables together.
6. Do not route electrical cables near sharp edges or parts that will move or become hot.
7. Ventilate area well before and while working on battery. Explosive invisible hydrogen gas can accumulate and then explode when ignited by a spark from the battery connection.
8. Only connect to a clean, corrosion free battery.
9. Do not lean over or come in contact with battery while making connections.
10. Remove all metal jewelry before working near battery.
11. Connect the red cable to the Disconnect Switch, then connect the 12" 2AWG cable to the Disconnect Switch and the positive battery terminal. Connect the black cable to the negative battery terminal.
12. Insulate all exposed wiring and terminals after installation.
13. Install Winch and Fairlead in underwind orientation, so that the Synthetic Rope enters and exits the Winch at the bottom of the drum.

Service Precautions



1. Wear ANSI-approved safety goggles and heavy-duty leather work gloves during service.
2. Disconnect power to Winch and allow it to cool completely before service.
3. Use supplied power cords, synthetic rope or cables listed in manual only. Do not use thinner/longer cables or link multiple cables together.
4. Have the Winch serviced by a qualified repair person using only identical replacement parts. This will ensure that the safety of the Winch is maintained.
5. Maintain labels and nameplates on the Winch. These carry important safety information. If unreadable or missing, contact Harbor Freight Tools for a replacement.



SAVE THESE INSTRUCTIONS.

Installation and Setup



Read the **ENTIRE IMPORTANT SAFETY INFORMATION** section at the beginning of this manual including all text under subheadings therein before set up or use of this product.

What's in the Box

Winch x 1

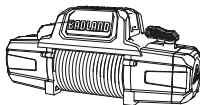

Aluminum Fairlead x 1

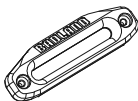

Remote Control x 1



Remote Control Cable x 1



Hook x 1



Rope Protecting Mat x 2

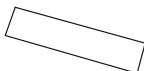

Ground Cable x 1



Disconnect Switch x 1



Red Hook Strap x 1



Control Box Baseplate x 1

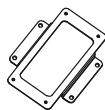

Sheath (red, black, yellow) x 3



Extended Copper Screw x 3



Small Black Wire Extension x 1



Small Black Wire Connector x 1



Disconnect Switch Cable x 1



Terminal Box x 1
Terminal Box Cover x 1

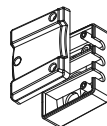

Power Cables (relocation kit) x 3



Instruction Books



- Manual
- Guide to Winching

Mounting the Winch

1. Make sure the Winch will fit the chosen mounting area. If relocating the Control Box is necessary or desired, perform the removal and installation of cables to the Winch before mounting. Refer to *Relocating the Control Box* on page 8.
2. The mounting plate must be rated to at least the Winch's capacity.
3. Align the Winch perpendicular to center line of the vehicle at the desired location, and mark the locations of the winch base holes. Compare the dimensions of the marked holes to Figure A.
4. Before drilling, verify that the installation surface has no hidden components or structural pieces that will be damaged.

NOTE: This Winch can generate extreme forces. Select a location that can withstand the rated capacity without damage or weakening. Steel reinforcement plates may be needed or a certified welder may need to weld on additional bracing depending on the mounting location.

5. Drill holes appropriate for the hardware at the marked locations.

Note: Depending on the vehicle application, it may be beneficial to install the wiring before mounting the Winch. Check all terminal access and plan wiring routes before mounting the Winch.

6. Install the Winch using hardware specified on the specification chart. Tighten fasteners to the following torque values:

Winch mounting fasteners	30–33 ft-lb
--------------------------	-------------

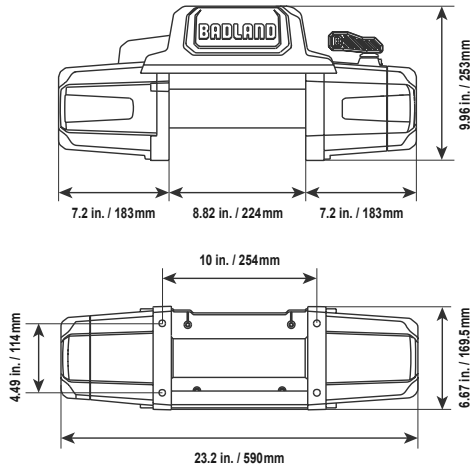

Figure A: Winch Dimensions

7. Mount the Fairlead centered on the Winch to guide the Rope onto the Winch drum.
8. Install the Fairlead using hardware specified on the specification chart. Tighten fasteners to the following torque values:

Fairlead mounting fasteners	53–57 ft-lb
-----------------------------	-------------

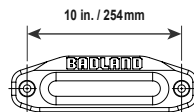

Figure B: Fairlead Mounting Dimensions

Relocating the Control Box (optional)



TO PREVENT SERIOUS INJURY FROM EXPLOSION DUE TO SPARKING AT THE BATTERY CONNECTION:

Unplug the Remote Control Cable and disconnect the Battery Cables before making other wiring connections.

1. Engage the clutch on Winch.
2. Disconnect the vehicle battery cables, negative terminal first.
3. Disconnect the Ground Cable and Small Black Wire from terminal on rear of Winch. Make sure the Small Black Wire that connects to the Control Box is disconnected and hanging freely.

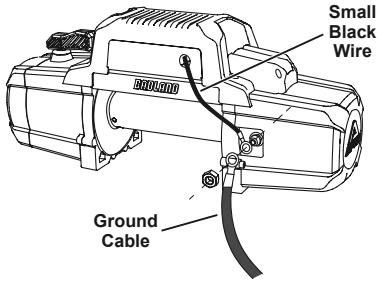

4. Remove the Terminal Cover by unscrewing two M4x16 Screws holding it in place. Remove the six Motor Terminal Nuts and three Copper Plates. Retain all the hardware.

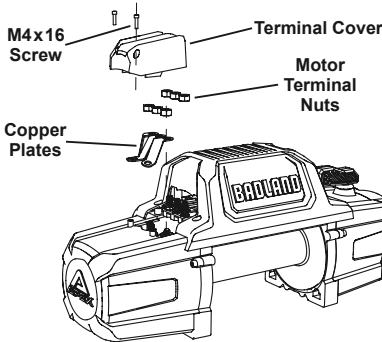

5. Remove four M6x25 Screws holding the Control Box in place and gently lift it off of the Winch.

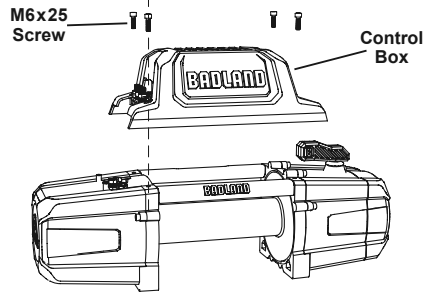

6. Attach the Control Box Baseplate to the Control Box using the four M6x25 Screws removed in step 5.

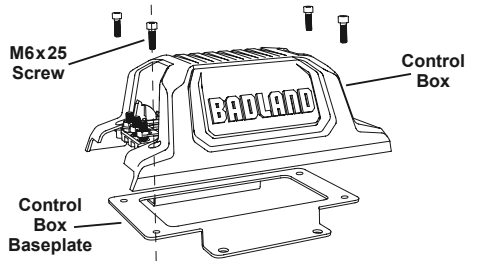

7. Install the three Extended Copper Screws to the terminal on the motor. Mount the Terminal Box on the Winch using two M4x12 screws. Do not overtighten screws.

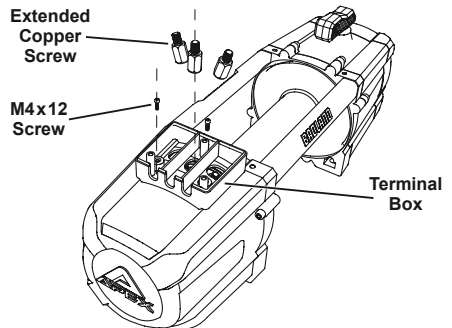

8. Connect three Power Cables (Control Box Relocation Kit) to the Extended Copper Screws on motor terminal using three of the Motor Terminal Nuts removed in step 4.

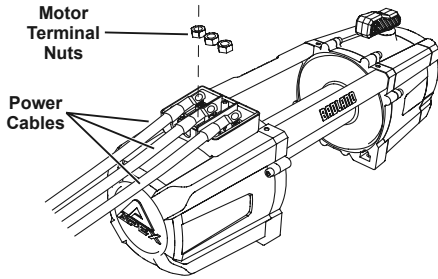

9. Install the Terminal Box Cover on the Terminal Box using three M4.8x16 Self-Tapping Screws. Do not overtighten screws.

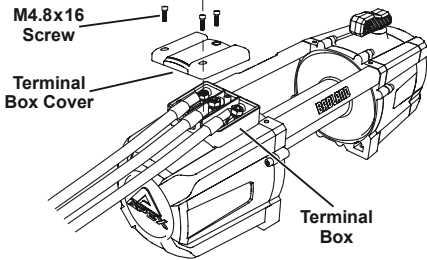

10. Connect three Power Cables (control box relocation kit) to the Control Box using remaining three Motor Terminal Nuts removed in step 4.

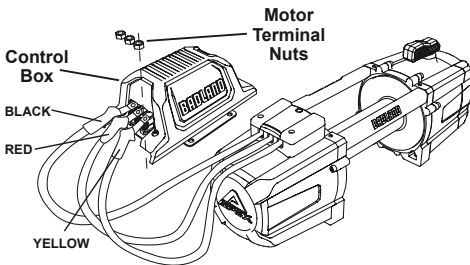

11. Use the Small Black Wire Connector and Small Black Wire Extension to lengthen the Small Black Wire from the Control Box. Reconnect the Ground Cable and Small Black Wire to the backside of the Winch motor.

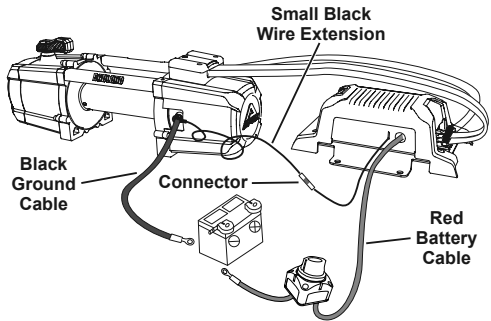

12. Install the four decorative M6x12 Screws onto the Winch.

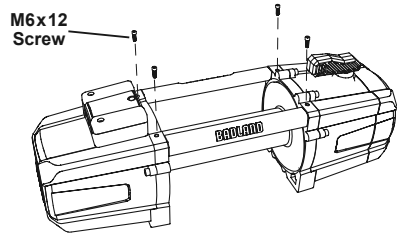

13. Place the Control Box on a solid mounting surface in a suitable place near enough to the Winch to allow the cables to be routed properly.

14. Verify that the installation surface has no hidden components or structural pieces that will be damaged before drilling.

15. Secure the Control Box assembly in place with Baseplate mounting hardware.

Wiring

⚠ WARNING



TO PREVENT SERIOUS INJURY FROM EXPLOSION DUE TO SPARKING AT THE BATTERY CONNECTION:
Unplug the Remote Control Cable and disconnect the Battery Cables before making other wiring connections.



TO PREVENT SERIOUS INJURY FROM LEAKING BATTERY ACID:
Do not use a dirty, corroded or leaking battery.
Only use a 12V automotive (or equivalent) battery, in good condition.

1. Plan a route for the wiring from the point of the vehicle where the Winch will be mounted, or used, to the battery. This route must be secure, out of the way of moving parts, road debris, or any possibility of being damaged by operation or maintenance of the vehicle. For example, you may wish to route the wires under the vehicle, attaching it to the frame using suitable fasteners.

WARNING! TO PREVENT SERIOUS INJURY: Do not attach the wires to the exhaust system, drive shaft, emergency brake cable, fuel line, or any other components which may create damage to the wiring through heat or motion, or create a fire hazard.

2. If you drill through the bumper or any part of the body to route the wires, be sure to install a rubber grommet in the hole to prevent fraying of the wires at that point.
3. Route the Cables from the Winch to the battery, following the precautions discussed above. Refer to Figure C.

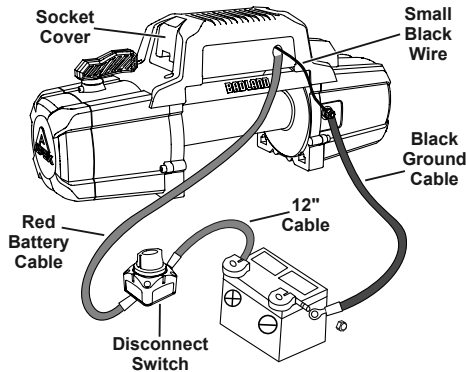

Figure C: Wiring Connections

4. Attach the 12" 2AWG Disconnect Switch Cable to the positive terminal on the battery.
5. Attach the 12" 2AWG Cable from the battery to either terminal on the Disconnect Switch.

6. Attach the red Battery Cable from the Winch to the remaining terminal on the Disconnect Switch.
7. Attach the black Ground Cable and the Small Black Wire to the terminal at the rear of the Winch.
8. Attach the black Ground Cable from the Winch directly to the negative terminal of the battery.
9. Lift the Socket Cover exposing the Remote Control socket and Wireless Receiver Switch. Connect the Remote Control Cable to the socket and the Remote for wired remote control. For wireless control do not use the Remote Control Cable and turn on the Wireless Receiver Switch. Refer to *Remote Control Instructions* on page 12.
10. Turn on the Disconnect Switch and operate the remote controls briefly to test Winch function and drum rotation direction. If operation is reversed, the Battery Cables may be connected backwards. Correct any such issue before use.

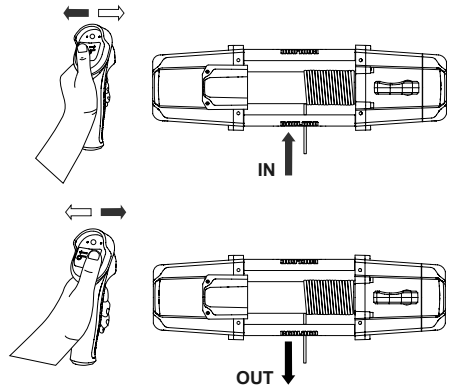

Figure D: Remote Controls

11. Disconnect and turn off the Remote Control when not in use.
12. Turn off the Disconnect Switch when the Winch is not in use or when the vehicle has returned to on-highway operation.

Disconnect Switch

WARNING! TO PREVENT SERIOUS INJURY: Off-highway driving subjects the vehicle and wiring to much higher vibrations than on-highway driving which can cause a breakdown of wiring insulation over time. Use the high current Disconnect Switch included with this Winch to turn OFF the power to the Winch when it is not in use to help reduce the risk of a short circuit.

1. To use the Winch, use the Disconnect Switch to turn the power to the Winch ON.
2. When the Winch is not in use, turn the Disconnect Switch OFF to reduce the risk of a short on the main power to the Winch.

Preparing the Synthetic Rope

The Synthetic Rope must be properly coiled under tension to be able to support a load without damage.

1. Find a suitable location where the Rope can be spooled onto the Winch while anchored to a solid object. Approximately 70 feet will be required. Alternately, a snatch block (sold separately) may be used to reduce the distance to 35 feet.
2. Move the Clutch Handle to the Freespool position and uncoil the Synthetic Rope until 5 wraps remain on the drum. Move the Clutch Handle back to the Engaged position.
3. Slowly and carefully move the vehicle in reverse to remove slack from the line.
4. Place the vehicle in neutral. Spool the Synthetic Rope back into the Winch while gently applying the brakes. If the ground is flat, shallow mud or dirt, the brakes can be fully applied. Pavement can generate much higher loads, in which case only light braking is needed.
5. Use a second person to monitor the rope spooling evenly onto the drum.
6. The last layer of Rope can be put on without tension.

Remote Control Instructions

Wired Operation

1. To use the Remote Control in a wired configuration, connect the Remote Control Cable to the bottom of the Remote Control and to the Remote Control Socket on the Control Box.

Red Indicator Light

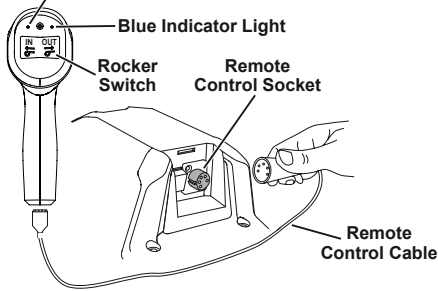

2. The blue indicator light will come on indicating the Remote Control is ready for use.

3. With the Clutch Handle in the Engaged position, press IN on the Rocker Switch to retract the Synthetic Rope—the red indicator light will flash during winding.

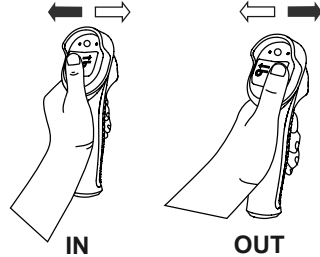

4. Press OUT on the Rocker Switch to extend the Synthetic Rope out.

Wireless Operation

1. For wireless Remote Control operation, turn on the Wireless Receiver Switch on the Control Box.

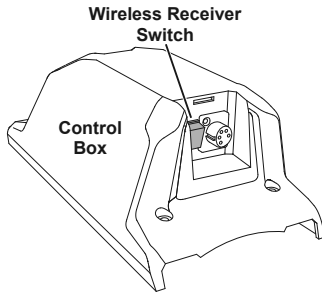

2. Press and hold the ON/OFF Switch on the Remote for approximately 2 seconds until the red indicator light comes on, indicating the Remote Control is ready for use.

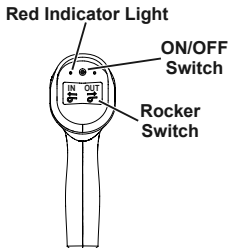

3. With the Clutch Handle in the Engaged position, press IN on the Rocker Switch to retract the Synthetic Rope—the red indicator light will flash during winding.

4. Press OUT on the Rocker Switch to extend the Synthetic Rope out.

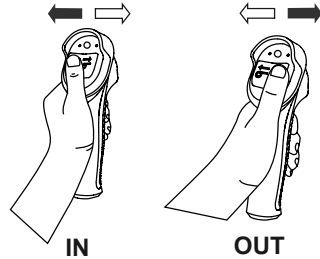

5. To turn off the Remote Control, press and hold the ON/OFF Switch until the red indicator light goes out, approximately 2 seconds. Turn off the Wireless Receiver Switch.

Note: The Remote Control will automatically shut itself off after 2 minutes of inactivity to save the battery.

Operation

Before operating this Winch, refer to the Harbor Freight Tools publication *Guide to Winching* included with the Winch for important operational safety information, winch basics, winching tips, and general winch operating procedures. If this guide is unreadable or missing, contact Harbor Freight Tools for a replacement.



Read the **ENTIRE IMPORTANT SAFETY INFORMATION** section at the beginning of the *Guide to Winching* including all text under subheadings therein before use of this product. The instructions included in the *Guide to Winching* are basic guidelines only and cannot cover all situations encountered during use. The operator and assistants must carefully plan usage to prevent accidents.

SAFETY

SETUP

OPERATION

MAINTENANCE

BADLAND®

Maintenance and Servicing



Procedures not specifically explained in this manual must be performed only by a qualified technician.

⚠️ WARNING



TO PREVENT SERIOUS INJURY FROM ACCIDENTAL OPERATION:

Unplug the Remote Control Cable and disconnect the Battery Cables before performing any inspection, maintenance, or cleaning procedures.

TO PREVENT SERIOUS INJURY FROM WINCH FAILURE:

Do not use damaged equipment. If abnormal noise or vibration occurs, have the problem corrected before further use.

Cleaning, Maintenance, and Lubrication

- BEFORE EACH USE**, inspect the general condition of the Winch. Check for:
 - loose hardware
 - misalignment or binding of moving parts
 - cracked or broken parts
 - damaged electrical wiring
 - corroded or loose terminals
 - any other condition that may affect its safe operation.
- AFTER USE**, wipe external surfaces of the Winch with clean cloth. If the Winch is submerged during use, rinse thoroughly with fresh, clean water when finished.
- The Winch's internal mechanism is permanently lubricated. Do not open the housing.

Examine the Synthetic Rope. Do not use the Winch if the Rope is frayed or has cut strands.

Synthetic Rope Replacement

- Move Clutch Handle to the Freespool position.
- Extend the Synthetic Rope to its full length, noting how the existing Rope is connected to the inside of the drum.
- Remove old Synthetic Rope and attach new assembly.
- Retract Synthetic Rope onto Rope drum. Refer to instructions for tensioning the Synthetic Rope under *Preparing the Synthetic Rope* on page 11.
- Test Winch for proper operation.

CAUTION! Do not replace with inferior synthetic rope. Only use a synthetic rope rated to the same rating cited on the specification chart or better.

Troubleshooting

Problem	Possible Causes	Likely Solutions
Motor overheats.	<ol style="list-style-type: none"> 1. Incorrect power cords. 2. Winch running time too long. 3. Insufficient current or voltage. 4. Loose motor connections. 	<ol style="list-style-type: none"> 1. Use only supplied power cords. 2. Allow Winch to cool down periodically. 3. Fully charge battery. Run Winch with vehicle motor running. 4. Check and tighten motor connections to Control Box.
Motor does not turn on.	<ol style="list-style-type: none"> 1. Remote Socket not connected properly. 2. Loose battery cable connections. 3. Insufficient current or voltage. 4. Defective contactor. 5. Wireless Receiver Switch turned OFF. 6. Wireless Remote turned OFF. 7. Winch Disconnect Switch turned OFF. 8. Low batteries in Wireless Remote. 9. Defective motor. 10. Loose Control Box ground cable. 11. Internal wear or damage. 	<ol style="list-style-type: none"> 1. Insert Remote Socket all the way into connector. 2. Tighten nuts on all cable connections. 3. Fully charge battery. Run Winch with vehicle motor running. 4. Replace Control Box. 5. Turn ON Wireless Receiver Switch. 6. Turn ON Wireless Remote. 7. Turn ON Winch Disconnect Switch. 8. Replace Remote batteries—CR2032, quantity two. 9. Check for voltage at armature port with Switch pressed. If voltage is present, replace motor. 10. Check and tighten ground cable to Control Box. 11. Replace motor.
Motor runs but drum does not turn.	Clutch not engaged.	Move the Clutch Handle to the Engaged position. If problem persists, a qualified technician needs to check and repair.
Motor runs slowly or without normal power.	<ol style="list-style-type: none"> 1. Insufficient current or voltage. 2. Loose or corroded battery cable connections. 3. Incorrect power cords. 	<ol style="list-style-type: none"> 1. Battery weak, recharge. Run Winch with vehicle motor running. 2. Clean, tighten, or replace. 3. Use only supplied power cords.
Motor runs in one direction only.	<ol style="list-style-type: none"> 1. Defective contactor. 2. Defective Wireless Remote. 3. Loose motor connections. 	<ol style="list-style-type: none"> 1. Replace Control Box. 2. Replace Wireless Remote. 3. Check and tighten motor connections to Control Box.
 Follow all safety precautions whenever diagnosing or servicing the tool. Disconnect power supply before service.		

PLEASE READ THE FOLLOWING CAREFULLY

THE MANUFACTURER AND/OR DISTRIBUTOR HAS PROVIDED THE PARTS LIST AND ASSEMBLY DIAGRAM IN THIS MANUAL AS A REFERENCE TOOL ONLY. NEITHER THE MANUFACTURER OR DISTRIBUTOR MAKES ANY REPRESENTATION OR WARRANTY OF ANY KIND TO THE BUYER THAT HE OR SHE IS QUALIFIED TO MAKE ANY REPAIRS TO THE PRODUCT, OR THAT HE OR SHE IS QUALIFIED TO REPLACE ANY PARTS OF THE PRODUCT. IN FACT, THE MANUFACTURER AND/OR DISTRIBUTOR EXPRESSLY STATES THAT ALL REPAIRS AND PARTS REPLACEMENTS SHOULD BE UNDERTAKEN BY CERTIFIED AND LICENSED TECHNICIANS, AND NOT BY THE BUYER. THE BUYER ASSUMES ALL RISK AND LIABILITY ARISING OUT OF HIS OR HER REPAIRS TO THE ORIGINAL PRODUCT OR REPLACEMENT PARTS THERETO, OR ARISING OUT OF HIS OR HER INSTALLATION OF REPLACEMENT PARTS THERETO.

SAFETY

SETUP

OPERATION

MAINTENANCE

Record Product's Serial Number Here: _____

Note: If product has no serial number, record month and year of purchase instead.

Note: Some parts are listed and shown for illustration purposes only, and are not available individually as replacement parts.

SAFETY

SETUP

OPERATION

MAINTENANCE

Parts List and Diagram

Parts List

Part	Description	Qty
1	Gearbox End Cover	1
2	Washer	1
3	Star Screw M6x20	10
4	Gear Box Z69	1
5	Clutch Retaining Bolt	1
6	Clutch Handle	1
7	Clutch Handle Washer	1
8	Hex Socket Screw M5x20	4
9	Bearing	1
10	Hex Sun Gear	1
11	Planetary Gear Assembly 1	1
12	Planetary Gear Assembly 2	1
13	Washer	1
14	Ring Gear Z66	1
15	Circlip Washer Ø125	1
16	Planetary Gear Assembly 3	1
17	Ring Gear Z57	1
18	O-Ring Ø126x2	1
19	Star Screw M8x25	4
20	Gearbox Base	1
21	Pin	2
22	Drum Assembly	1
23	Tie Bar	2
24	Star Screw M6x25	4
25	Control Box Assembly	1
26	Transmission Shaft S8x289	1
27	Brake Assembly	1
28	Spline Drive Sleeve	1
29	Tab	2
30	Waterproof Sealing Ring	2
31	Radial Ring	2

Part	Description	Qty
32	Iron Bushing	2
33	Motor Assembly	1
34	Terminal Cover	1
35	Star Screw M4x16	2
36	Motor Cover	1
37	Winch Mounting Hardware	4 sets
38	Synthetic Rope	1
39	Fairlead	1
40	Fairlead Mounting Hardware	2
41	Hook	1
42	Remote Control Cable	1
43	Wireless/Wired Remote Control	1
44	Rope Protecting Mat	2
45	Ground Cable	1
46	Disconnect Switch	1
47	Red Hook Strap	1
48	Power Cables (relocation kit)	3
49	Terminal Box	1
50	Screw M4x12	2
51	Terminal Box Cover	1
52	Self-Tapping Screw M4.8x16	3
53	Control Box Baseplate	1
54	Baseplate Mounting Hardware	4 sets
55	Extended Copper Screw	3
56	Sheath	3
57	Small Black Wire Extension	1
58	Small Black Wire Connector	1
59	Screw M6x12	4
60	Disconnect Switch Cable	1
61	Rope Retainer	1
62	Bolt M8X16	1

SAFETY

SETUP

OPERATION

MAINTENANCE

Assembly Diagram

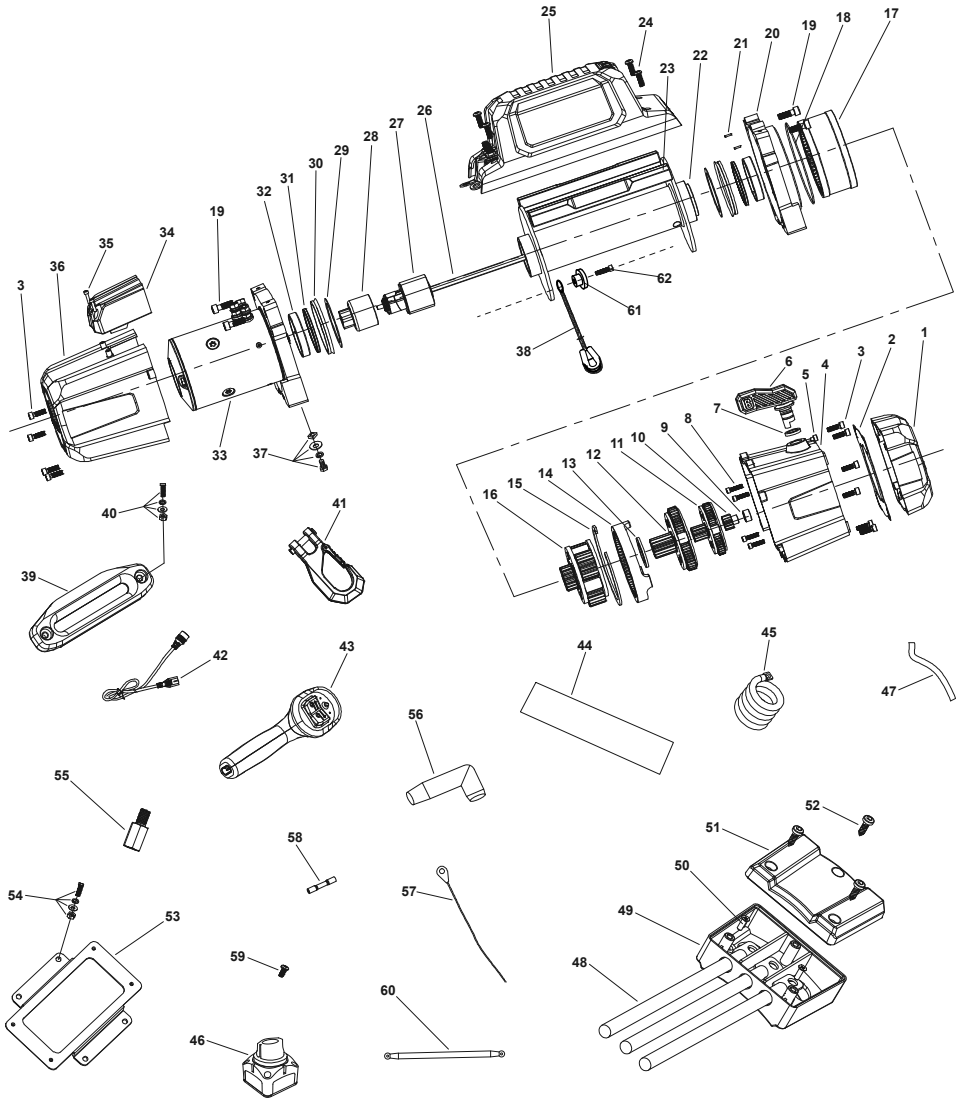

SAFETY

SETUP

OPERATION

MAINTENANCE

Limited 90 Day Warranty

Harbor Freight Tools Co. makes every effort to assure that its products meet high quality and durability standards, and warrants to the original purchaser that this product is free from defects in materials and workmanship for the period of 90 days from the date of purchase. This warranty does not apply to damage due directly or indirectly, to misuse, abuse, negligence or accidents, repairs or alterations outside our facilities, criminal activity, improper installation, normal wear and tear, or to lack of maintenance. We shall in no event be liable for death, injuries to persons or property, or for incidental, contingent, special or consequential damages arising from the use of our product. Some states do not allow the exclusion or limitation of incidental or consequential damages, so the above limitation of exclusion may not apply to you. THIS WARRANTY IS EXPRESSLY IN LIEU OF ALL OTHER WARRANTIES, EXPRESS OR IMPLIED, INCLUDING THE WARRANTIES OF MERCHANTABILITY AND FITNESS.

To take advantage of this warranty, the product or part must be returned to us with transportation charges prepaid. Proof of purchase date and an explanation of the complaint must accompany the merchandise. If our inspection verifies the defect, we will either repair or replace the product at our election or we may elect to refund the purchase price if we cannot readily and quickly provide you with a replacement. We will return repaired products at our expense, but if we determine there is no defect, or that the defect resulted from causes not within the scope of our warranty, then you must bear the cost of returning the product.

This warranty gives you specific legal rights and you may also have other rights which vary from state to state.

The logo for BADLAND is rendered in a bold, blocky, sans-serif font. Each letter is white with a thick black outline, giving it a three-dimensional, metallic appearance. The letters are closely spaced and sit on a solid black rectangular background. A small registered trademark symbol (®) is located at the bottom right corner of the letter 'D'.

26541 Agoura Road • Calabasas, CA 91302 • 1-888-866-5797

BADLAND®

GUIDE TO WINCHING



WWW.HARBORFREIGHT.COM

Copyright© 2019 by Harbor Freight Tools®. All rights reserved. No portion of this guide or any artwork contained herein may be reproduced in any shape or form without the express written consent of Harbor Freight Tools. Diagrams within this guide may not be drawn proportionally.

Table of Contents







Warning Symbols	3	Winch Basics	10
Important Safety Information	4	Single Line Winching—Straight Pull	14
Basic Winching Tips	7	Single Line Winching—Snatch Block	16
Before You Go	7	Double Line Winching.....	18
Estimating Load.....	8		













Read the **ENTIRE IMPORTANT SAFETY INFORMATION** section beginning on page 4 of this guide including all text under subheadings therein before use of this product. The instructions that follow are basic guidelines only and cannot cover all situations encountered during use. The operator and assistants must carefully plan usage to prevent accidents.

BADLAND®

WARNING SYMBOLS AND DEFINITIONS

	This is the safety alert symbol. It is used to alert you to potential personal injury hazards. Obey all safety messages that follow this symbol to avoid possible injury or death.
	Indicates a hazardous situation which, if not avoided, will result in death or serious injury.
	Indicates a hazardous situation which, if not avoided, could result in death or serious injury.
	Indicates a hazardous situation which, if not avoided, could result in minor or moderate injury.
	Addresses practices not related to personal injury.
	

Symbol	Property or Statement
	Wear heavy-duty, cut- and abrasion-resistant leather gloves.
	Wear ANSI-approved safety glasses.
	Cut or sever hazard.
	Roller entanglement hazard.
	Hot surface burn hazard.
	Fire hazard.
	Caustic chemical (acid) hazard.
	Explosion hazard.
	Do not loop the wire or synthetic rope around object and hook onto itself.
	Do not place finger(s) through hook. Fingers may be caught and get pulled into fairlead or drum.
	Pull hook using strap only.

Symbol	Property or Statement
	Do not use winch in overwind orientation. (Rope enters/exits at the top.)
	Use winch only in underwind orientation. (Rope enters/exits at the bottom.)
VDC	Volts Direct Current
A	Amperes
CCA	Cold Cranking Amperes
HP	Horsepower
fpm	Feet Per Minute
mpm	Meters Per Minute
RPM	Revolutions Per Minute
IP	International Protection rating Classifies the degrees of protection provided against the intrusion of solid objects, dust, accidental contact, and water.
G8	Grade 8 A fastener strength rating.

IMPORTANT SAFETY INFORMATION



WARNING! Read all instructions. Failure to follow all instructions listed on pages 4 to 6 may result in fire, serious injury and/or DEATH.

The warnings and precautions discussed in this manual cannot cover all possible conditions and situations that may occur. It must be understood by the operator that common sense and caution are factors which cannot be built into this product, but must be supplied by the operator.

Operation Precautions



1. Do not exceed load capacity. **Be aware of dynamic loading!** Sudden load movement may briefly create excess load causing product failure.
2. **Do not maintain power to the Winch if the motor stalls.** Verify load is within rated capacity for the wire or synthetic rope layer. Make sure the battery is fully charged. Use double line rigging whenever possible. Refer to *Double Line Winching* on page 18.
3. Wear ANSI-approved safety goggles and heavy-duty leather work gloves during operation.
4. Do not disengage clutch under load. Engage clutch before starting.
5. Keep clear of fairlead when operating. Do not try to guide rope.
6. **Do not place finger(s) through hook.** Fingers may be caught and get pulled into fairlead or drum. Use included strap to hold hook instead.
7. Stay out of the direct line that the rope is pulling. In case it slips or breaks, it will “whiplash” along this line.
8. Do not use for lifting or moving people.
9. Use a spotter to assist you in assuring that it is safe to operate the Winch. Make sure the spotter is out of the way of the vehicle and the rope before activating the Winch.
10. Do not use vehicle to pull on the rope and “assist” the Winch.

11. Place a heavy blanket or winch damper over the rope span 6 feet from hook to help absorb the force released if the rope breaks. Refer to Figure A.

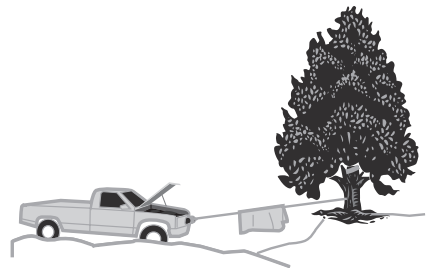

Figure A: Whiplash Dampening Blanket or Winch Damper

12. Use as intended only. Do not lift items vertically or use for aircraft purposes.
13. Prevent entanglement. Do not wear loose clothing or jewelry, as they can be caught in moving parts. Non-skid footwear is recommended. Wear restrictive hair covering to contain long hair.
14. Disconnect remote control and turn off wireless function before working near the rope, drum, fairlead or load, to prevent accidental starting.
15. Inspect before every use; do not use if damaged or parts loose. Examine the Winch for structural cracks, bends, damage, frayed or kinked wire rope, frayed or cut synthetic rope, and any other conditions that may affect the safe operation of the Winch. Do not use the Winch even if minor damage appears.

16. A kink permanently weakens a wire rope, even after it is straightened out; kinked wire rope can fail suddenly and must not be used. Keep wire rope straight to avoid kinking the wire rope. The illustrations below show how a kink forms:

a. This illustration shows a kink about to form. At this point the winch should be stopped and the wire rope should be straightened out to prevent kinking.



b. This wire rope is kinked. It is too late to reverse the damage at this point, the wire rope must be discarded. It is permanently damaged and must not be used.



c. This is a kinked wire rope that has been straightened out. Even though it has been pulled straight, some wires in the wire rope are stretched, and others are severely bent, if not broken. The unstretched wires will take more load and can fail suddenly before the rope reaches its capacity. This wire rope must be discarded and not be used.

A kink permanently weakens the wire rope, even after it is straightened out; kinked wire rope can fail suddenly and must not be used.

- 17. Keep children and bystanders away while operating. Distractions can cause you to lose control.
- 18. Stay alert, watch what you are doing and use common sense when operating. Do not use a winch while you are tired or under the influence of drugs, alcohol or medication. A moment of inattention while operating winches may result in serious personal injury.

- 19. Do not overreach. Keep proper footing and balance at all times. This enables better control of the Winch in unexpected situations.
- 20. Hook onto the object using a pulling point, tow strap or chain. Do not wrap the rope around the object and hook onto the rope itself. This can cause damage to the object being pulled and kink or fray the rope.
- 21. **Do not use a Recovery Strap while winching.** They are designed to stretch and can suddenly whip back towards the operator during a winching operation.

22. Do not operate the Winch at extreme angles. Do not exceed the angles shown in Figure B for a roller fairlead and Figure C for a hawse fairlead.

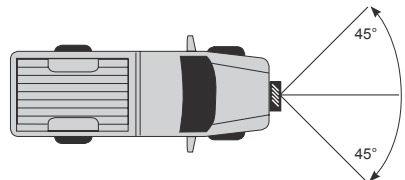

Figure B: Roller Fairlead Maximum Winching Angles

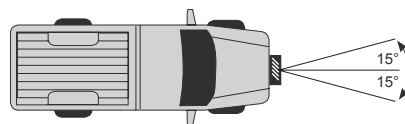

Figure C: Hawse Fairlead Maximum Winching Angles

23. If the object to be pulled must be pulled at an angle in relation to the Winch, use a snatch block (sold separately) and an anchor point directly in front of the Winch, as shown in Figure D, to keep the rope pull straight.

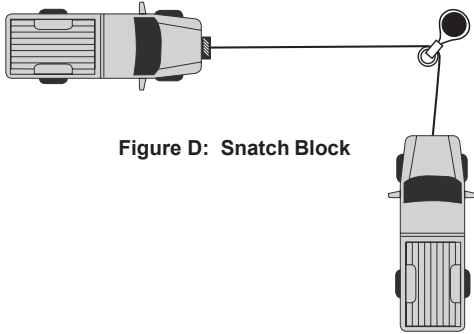

Figure D: Snatch Block

24. Wrap rope under tension before use. Otherwise, rope may bind during operation.

25. Keep clear of rope, hook, and load while winching. Do not step over rope.
Do not push sideways against rope under tension; rope might break under this load and recoil back, striking the person pushing against it or a bystander.

26. If rope begins to get entangled, stop Winch immediately and release rope using switch.

27. Only winch with the winching vehicle's transmission in neutral. Winching with a vehicle's transmission in gear or park may damage the transmission. A vehicle's transmission is not designed to handle that type of load.

28. Broken strands of a wire rope will be sharp. Wear heavy-duty work gloves when handling a wire rope. Do not slide a wire or synthetic rope through hands, even with gloves on.

29. Winch motor will be hot during and after use. Keep clear.

30. Do not power the hook all the way into the fairlead or Winch.

31. To prevent accidental starting, unplug winch controls and any RF receivers immediately after extending or retracting. This is especially important before rigging, installing, free spooling, or servicing.

32. People with pacemakers should consult their physician(s) before use. Electromagnetic fields in close proximity to heart pacemaker could cause pacemaker interference or pacemaker failure.

Service Precautions



1. Wear ANSI-approved safety goggles and heavy-duty leather work gloves during service.
2. Disconnect power to Winch and allow it to cool completely before service.
3. Use supplied power cords, rope or cables listed in manual only. Do not use thinner/longer cables or link multiple cables together.

4. Have the Winch serviced by a qualified repair person using only identical replacement parts. This will ensure that the safety of the Winch is maintained.
5. Maintain labels and nameplates on the Winch. These carry important safety information. If unreadable or missing, contact Harbor Freight Tools for a replacement.



SAVE THESE INSTRUCTIONS.

Basic Winching Tips

- **ESTABLISH A DANGER ZONE:**

At least 20ft on each side of the winch line and beyond the vehicle and anchor point. Make sure no people enter during the winching operation or when the line is under tension.



- **FIRST LAYER WINCHING:**

Winch with the most rope out possible to utilize the maximum power of the winch and prevent overloading and overheating.

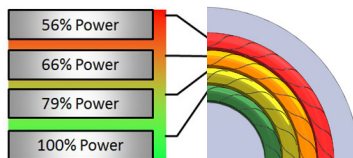

- **WINCH RECOVERIES ARE SLOW:**

Take time to properly evaluate the situation, and take all safety precautions. The loads that the winch can generate are extreme.

- **USE A SNATCH BLOCK:**

When in doubt of the recovery load or if the two vehicles are within 20ft of each other, use a snatch block for a double line pull.



- **KEEP THE LINE STRAIGHT:**

Winch with the rope as straight as possible to the winching vehicle. Use a snatch block if needed.

- **KEEP VEHICLE RUNNING:**

The winch will place an enormous amount of strain on the vehicle electrical system. Keeping the engine at 2000 RPM can provide some help from the alternator.

- **KEEP THE VEHICLE IN NEUTRAL:**

The parking brake is not designed to hold the loads that the winch can apply. If recovering another vehicle, keep foot firmly on brake. For self-recovery, carefully steer vehicle to avoid obstacles and spotter and keep foot off brake.

Before You Go

1. Check the power cables from the battery to the winch for abrasion and heat damage. Replace if worn or damaged.
2. The winch is an intermittently used product—over time the grease may settle in the gear train and make it difficult to freespool. Before a trip, check the winch for proper operation in three modes:
 - Power-IN • Power-OUT • Freespool
2. Inspect the rope for signs of abrasion damage, knots or kinks, or compression damage. Replace if damaged. See *Rope Inspection* on page 13 for more detail.
3. Ensure you have basic rigging hardware and safety gear such as: shackles, winch line damper, tree strap, safety glasses, and gloves. A snatch block is highly recommended.



Shackle



Damper



Tree Strap



Safety Gear



Snatch Block

Estimating Load

The ability to determine the load that the recovery will take is an important skill to learn. It allows you to properly setup rigging for a successful recovery the first time and reduces the chance of equipment damage and danger to bystanders.

Resistance Types

- **Grade Resistance:** The resistance of pulling a vehicle up a slope.
- **Mire Resistance:** The resistance of pulling a vehicle from soft terrain, such as mud, sand or snow.
- **Tackle Resistance:** The added resistance of snatch blocks during winching.

Grade Resistance

For recoveries or applications that pull a vehicle up a slope, grade resistance is a factor in the recovery load. This is because there are many other variables to consider off-road that add resistance. For example, the ground is not smooth or solid like pavement, the vehicle's wheels may not turn smoothly, the vehicle's steering may be broken, and a host of other factors.

For the majority of off-road recoveries, the grade resistance can be equal to the gross vehicle weight (GVW).

For smooth ramps used to load a trailer or other situations that are not as varied, you can use the following to estimate the recovery load. To estimate load you will need the gross vehicle weight (GVW) and the grade of the terrain.

- GVW can be found on the nameplate of the vehicle, or by a weigh station scale.
- % Grade = Rise / Run
Example: Rise 4ft / Run 10ft = 40% Grade

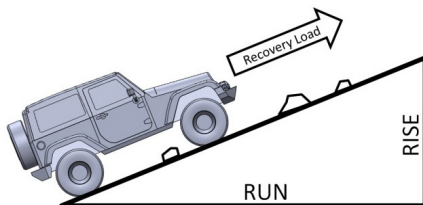

Reference the chart to find the estimated recovery load resistance.

Example: GVW of 6000lb on a 60% grade = recovery load of 51% of 6000lb = About 3060lb

Grade	Angle	% of GVW
20%	11	20%
40%	22	37%
60%	31	51%
80%	39	62%
100%	45	71%

Mire Resistance

For recoveries in mud, sand, or snow, mire resistance becomes a factor. Mire resistance is the added resistance that the soft terrain adds as the vehicle is submerged beneath the ground level. The vehicle's GVW is used to estimate the recovery load.

- Wheel Depth = 1x GVW

Wheel Depth Mire

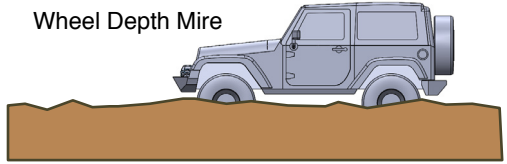

- Fender Depth = 2x GVW

Fender Depth Mire

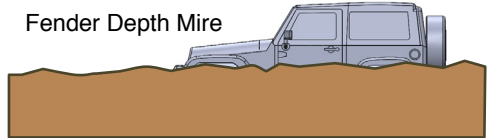

- Cab Depth = 3x GVW

Cab Depth Mire

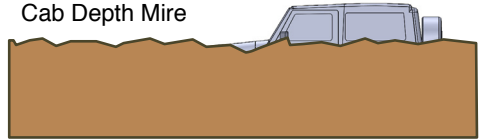

A snatch block is a great way to double the pulling power of your winch.

Tackle Resistance

Each shackle that is used in the recovery rigging adds a small amount of resistance to the winch. Each snatch block used in the recovery adds about 10% to the recovery load—add this to the recovery load on the winch.

Example: 4000lb recovery load +10% = 4400lb winch load

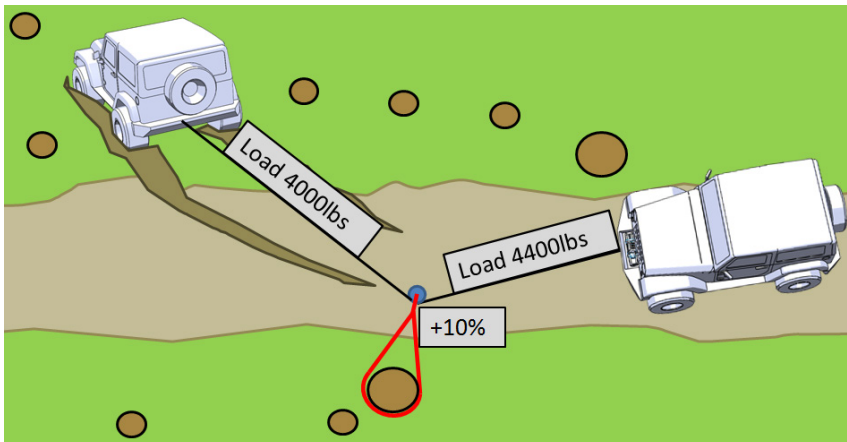

Winch Basics

Rope Layer

Imagine trying to hold a full length shovel horizontal by the very end of the handle—pretty hard, right?



Now imagine holding a shorter shovel by the end of the handle. Maybe not easy, but certainly easier than the full length shovel.

This is an example of how the winch must exert torque on the drum for the various layers of rope on the drum. The outermost layer of rope is represented by the full length shovel, and the first layer of rope is represented by the short shovel.

The winch and the vehicle electrical system have a limited amount of power available, so it is important to use the power in the most efficient way possible.

The winch can pull to 100% full rated load only on the first layer of rope that touches the drum.

For a constant load, as each layer of rope winds on, the winch must exert more torque on the drum, because of the added leverage of each layer.

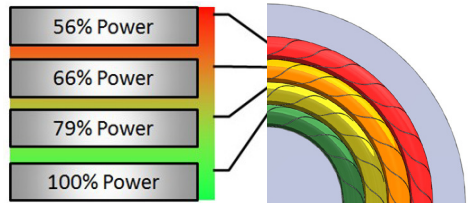

WARNING! To prevent serious injury from sudden detachment of the winch rope leave at least 5 full wraps of rope on the drum.

BADLAND®

Rope Angle

Your winch is designed to handle off-angle pulls for brief periods. However, extended pulls on one side of the drum can cause damage to the winch and rope. Use a snatch block to change the direction or move the anchor point.

Try to winch with the rope as straight into the winch as possible. If you do have to winch off-angle, do not exceed the angles shown below.

Spotter must be outside danger zone. Have spotter watch for even winding of rope on drum. If rope starts winding unevenly on the drum, stop winching and adjust rigging or vehicle position. Freespool the winch to remove the rope bunching on the drum flange and evenly spool the rope back on the drum, then continue the recovery.

Or, plan ahead and use a snatch block to ensure that an off-angle pull will be avoided. Periodically check your fairlead for wear and replace as needed.

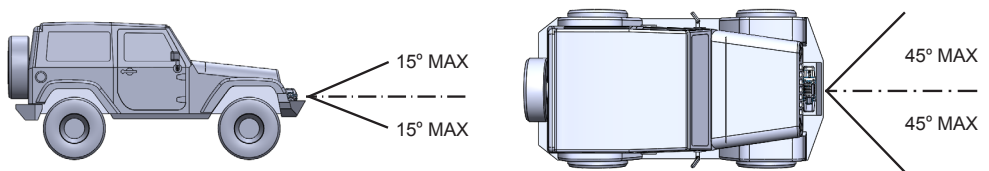

Roller Fairlead Maximum Winching Angles

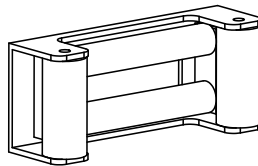

Roller Fairlead

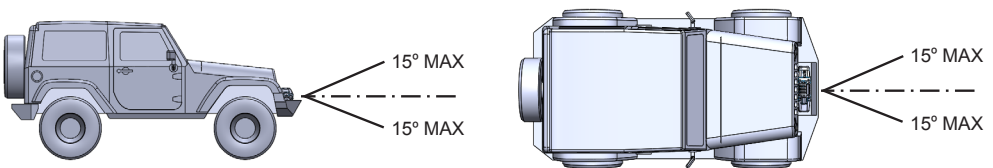

Hawse Fairlead Maximum Winching Angles



Hawse Fairlead

Snatch Blocks

Snatch blocks are the second most important accessory for your winch (the first being shackles). Being able to change the line direction for pulls around corners and multiple line pulls makes them extremely versatile. Let's understand how they work before we show examples of vehicle recoveries.

The most basic use of a snatch block is to change the direction of a rope. In the diagram a 4 ton vehicle is attached to a rope which passes around a snatch block to a winching vehicle.

Notice that the tension in each of the ropes is equal to the total load weight, and the snatch block must carry the combined load of the ropes.

This is a simplified example neglecting the angle of pull of the ropes. As the angle between the ropes increases, the load on the snatch block will decrease.

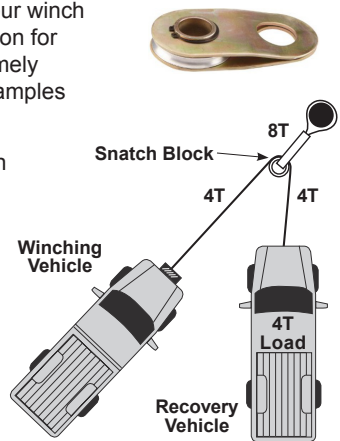

Example 1: Direction Change

In a direction change situation, the objective is to pull from a direction that has a greater impact on the stuck vehicle. In this example the weight is the stuck vehicle and the snatch block is attached to an anchor point. The snatch block does not provide any increase to the recovery force but it does change the direction of the pull.

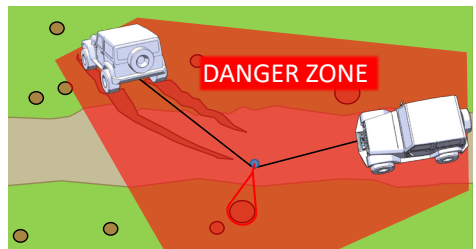

Example 2: Recovery Force Increase

In a situation where the recovery will take more force than the winch can provide, a double line pull should be used. This can help reduce the load on the winch and decrease the electrical load on the vehicle.

In this example the weight becomes the vehicle with the winch, and the snatch block is again connected to an anchor point. The usefulness of this rigging is to leverage the doubled force of the two ropes that the snatch block carries, allowing the recovery force to be double that of a single line pull.

Additionally the double line rigging will require more rope off the drum, allowing the winch to work on lower layers and provide more available pull force.

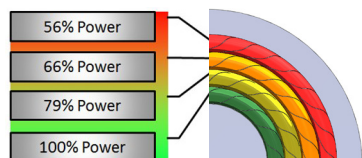
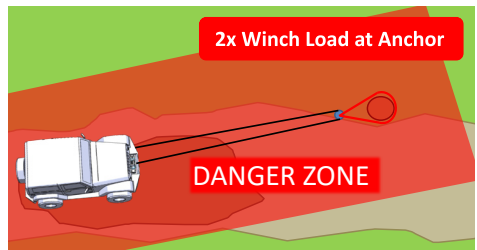

Rope Inspection

The rope on the winch is the highest wear item in the winching system, and the most dangerous if not inspected regularly. Wire rope and synthetic rope have different wear and replacement criteria—it is important to highlight both.

Wire Rope—Always Replace

WARNING! To prevent serious injury from razor sharp broken strands, wear heavy-duty work gloves when handling wire rope. Do not run hands along wire rope, even with gloved hands—some wire strands can be sharp enough to pierce gloves.

- Kinked Strands: Replace



- Separated Strand: Replace



- Broken Strands: Replace



- Twisted Rope: Replace



Synthetic Rope

CAUTION! Wear work gloves to protect from cuts from debris when working with synthetic rope.

- Abrasion: Severe abrasion must be replaced; minor abrasion or a fuzzy look can be monitored.



- Cut Strands: Replace immediately.



- Pulled Strand: Repair—work the strand carefully back into the rope.



- Compression: Commonly seen on drums. Repair—flex the rope without load to remove the compression.



Single Line Winching—Straight Pull

Setup

WARNING! To prevent serious injury from electrical fire: check the electrical cables to your winch for abrasion or heat damage before use. Replace worn or damaged cables immediately.

1. MAKE A PLAN. Pick a sturdy anchor such as a large tree, large rock, or other vehicle that is generally straight on and that allows for sufficient rope out to obtain maximum power from the winch.
2. PUT ON GLOVES. Regardless of synthetic or wire rope, heavy-duty work gloves are always a good idea.
3. Place the winch into freespool.

Rigging

1. Pull the hook out using the strap to the anchor point. Don't forget any rigging you will need, such as a tree strap and shackle.

WARNING! To prevent serious injury from sudden detachment of the winch rope leave at least 5 full wraps of rope on the drum.

2. Secure the winch rope to the anchor point. Do not wrap the winch rope directly around a tree or rock. Not only will this damage or kill the tree, but it will also damage the rope where the hook attaches back to the rope.

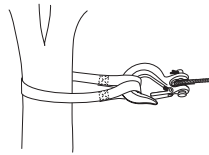

3. If possible, have the latch side of the hook facing up. This will help force the hook to the ground if the hook should fail or slip off the rigging.

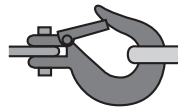

4. Make sure the hook is fully engaged on the shackle or vehicle anchor point. THE HOOK LATCH MUST CLOSE.
5. Place a winch damper or other heavy object on the line, 1/3 of the total distance from the hook end of the rope.

Use double line rigging whenever practical to prevent overloading and overheating of the winch.

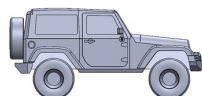

Damper

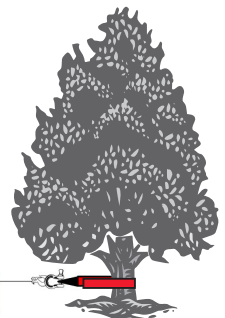

- ESTABLISH A DANGER ZONE. At least 20ft on each side of the winch line and beyond the vehicle and anchor point. Make sure no people enter during the winching operation or when the line is under tension.



WARNING! Do not allow anyone to stand near the rope, or inline with the rope behind the winch or anchor point while it is under power. If the rope should slip or break, it can suddenly whip back towards the winch or anchor, causing a hazard for anyone in the area established by the danger zone. Stand well to the side when winching.

Winching

For self recovery:
Place winch vehicle in NEUTRAL • Keep foot OFF brake

For other vehicle recovery:
Place winch vehicle in NEUTRAL • Keep foot ON brake

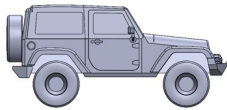

Damper



- Re-engage the freespool clutch, and plug-in or connect the remote to the winch.
- Slowly take up slack in the winch line to do a final check on the rigging setup. Designate one person as a spotter to watch for vehicle hazards and to make sure the rope is spooling on the drum correctly.
- Perform the winching operation, with the vehicle in NEUTRAL or DRIVE. Watch your spotter, and monitor the battery voltage while winching. Increase the engine RPM to raise the battery voltage level.
- When the vehicle is recovered engage parking brakes, remove all rigging and wind the rope fully into the winch USING THE HOOK STRAP.
- Unplug or disconnect the remote and store it in the vehicle for the next use.

NOTICE: Your winch is designed for INTERMITTENT USE ONLY. If the motor stalls, STOP OPERATION and use a snatch block.

Duty Cycle (Duration of Use)

Avoid damage to the Winch by not winching for more than the prescribed duty cycle time. The Duty Cycle defines the amount of time, within a 15 minute period, during which a Winch can operate at its maximum capacity without overheating. For example, a Winch with a 5% duty cycle at its maximum load must be allowed to rest for at least 14 minutes, 15 seconds after every 45 seconds of continuous operation. Failure to carefully observe duty cycle limitations can easily over-stress a Winch contributing to premature Winch failure.

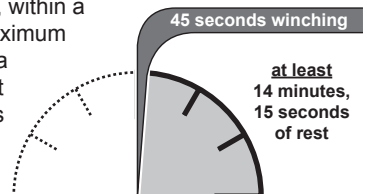

Single Line Winching—Snatch Block

Overview

Not every recovery can be handled with a straight line pull. Often the most effective recovery requires an angle that cannot be accomplished from straight on. By using a snatch block on a single line pull, the pull direction can be changed without moving the winching vehicle.

Around a Corner

When stuck on a hill or tight trail and an anchor point is too close to winch effectively, a snatch block can be used. Not only does this lower the rope layer so that the winch can pull harder, it also allows the vehicle to remain connected to the farthest anchor once the snatch block is removed.

Pay special attention to the danger zone, since it is much larger than a straight line pull.

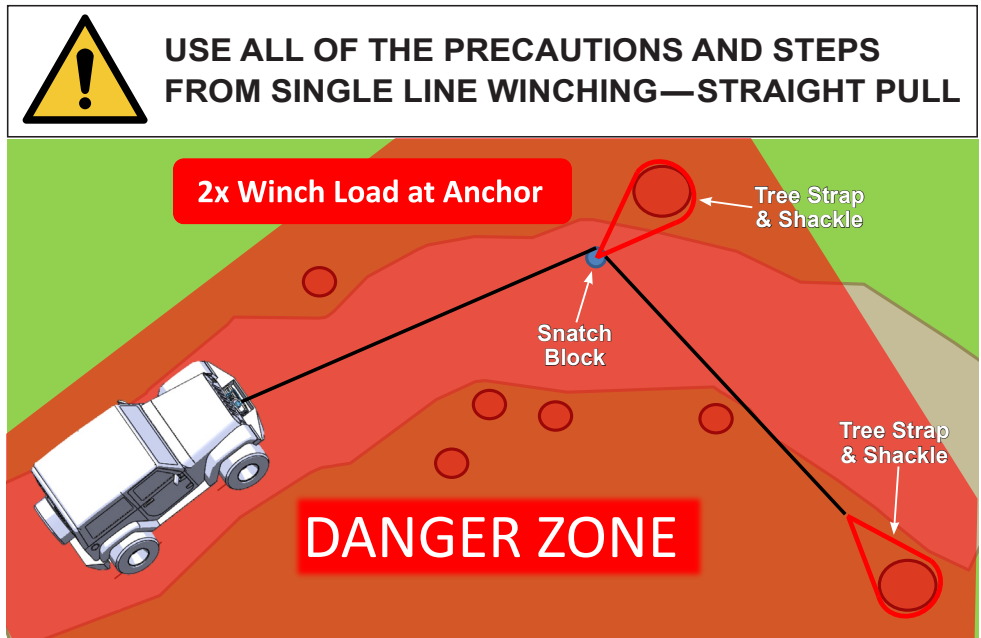

Rigging Needed:

- 2x Tree Straps
- 2x Shackles
- 1x Snatch Block

Vehicle Off Trail

If a vehicle leaves the trail and becomes stuck, often the most effective way to return the vehicle to the road is using an angled pull since this pulls the vehicle most directly onto the trail. Find a suitable anchor on the opposite side of the trail to attach a snatch block to, and perform the recovery.

Pay special attention to the danger zone, since it is much larger than a straight line pull.

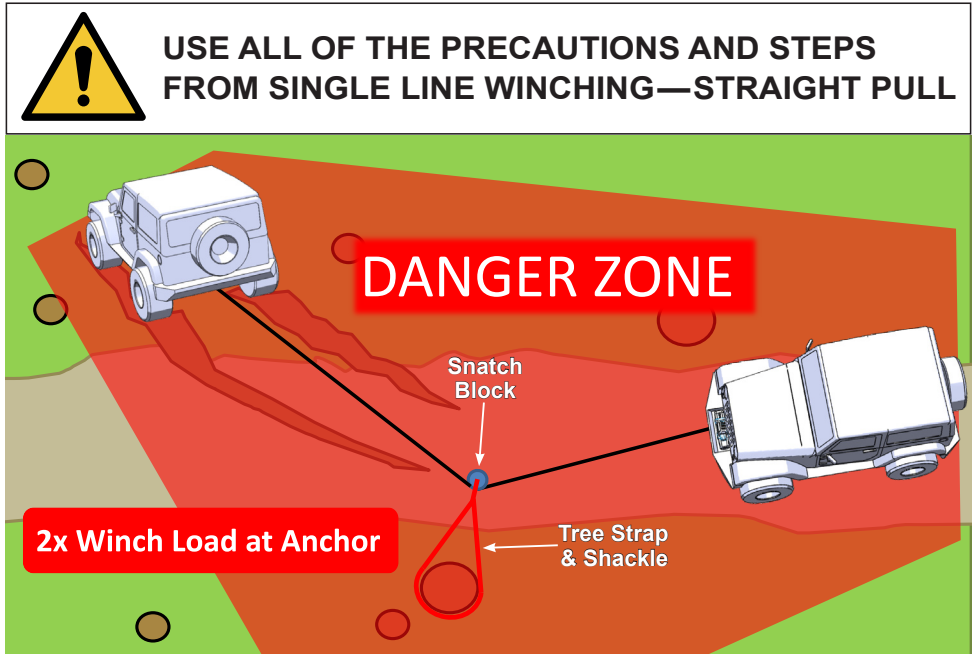

Rigging Needed:

- 1x Tree Strap
- 2x Shackles – Possibly more depending on tow points of stuck vehicle
- 1x Snatch Block

For self recovery:

Place winch vehicle in NEUTRAL • Keep foot OFF brake

For other vehicle recovery:

Place winch vehicle in NEUTRAL • Keep foot ON brake

Double Line Winching

Overview

Certain recoveries require more force than a single line pull can provide. In these situations a double line pull is necessary to develop enough force to recover the vehicle.

Double Line—Self Recovery

For self recovery efforts that require more force than a single line pull can provide, use a double line rigging back to the winching vehicle. Make sure the rigging at the anchor is rated to withstand the estimated load to recover the vehicle.

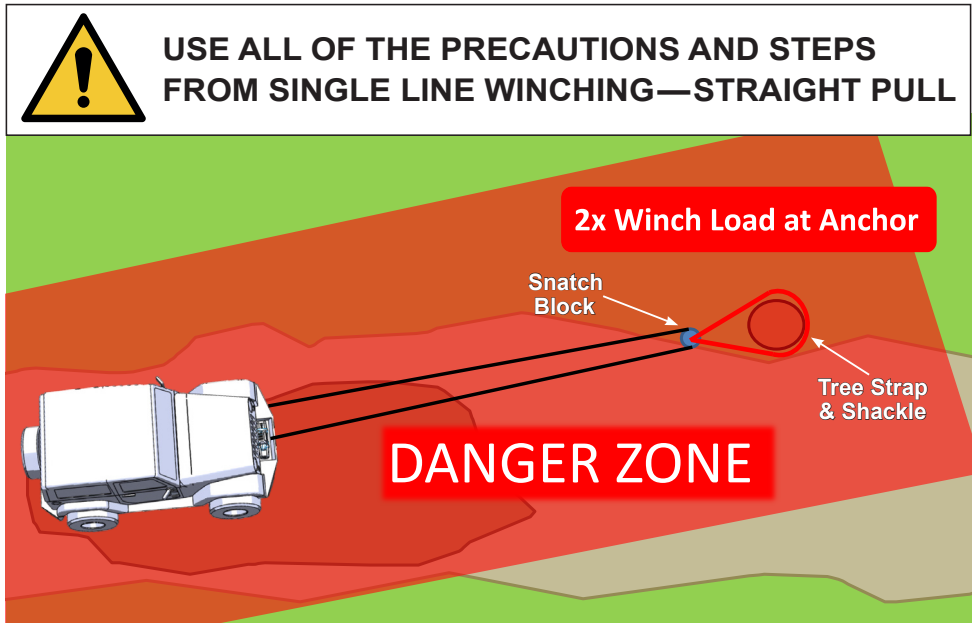

Rigging Needed:

- 1x Tree Strap
- 2x Shackles – Possibly more depending on tow points of stuck vehicle
- 1x Snatch Block

For self recovery:

Place winch vehicle in NEUTRAL • Keep foot OFF brake

Double Line—Other Vehicle Recovery

By placing the hook end at a stationary anchor or other vehicle and attaching a snatch block to the recovery vehicle, the load on the winching vehicle is reduced by 50%. This can be especially helpful in low traction conditions such as snow or mud.

Pay special attention to the danger zone, since it is much larger than a straight line pull.

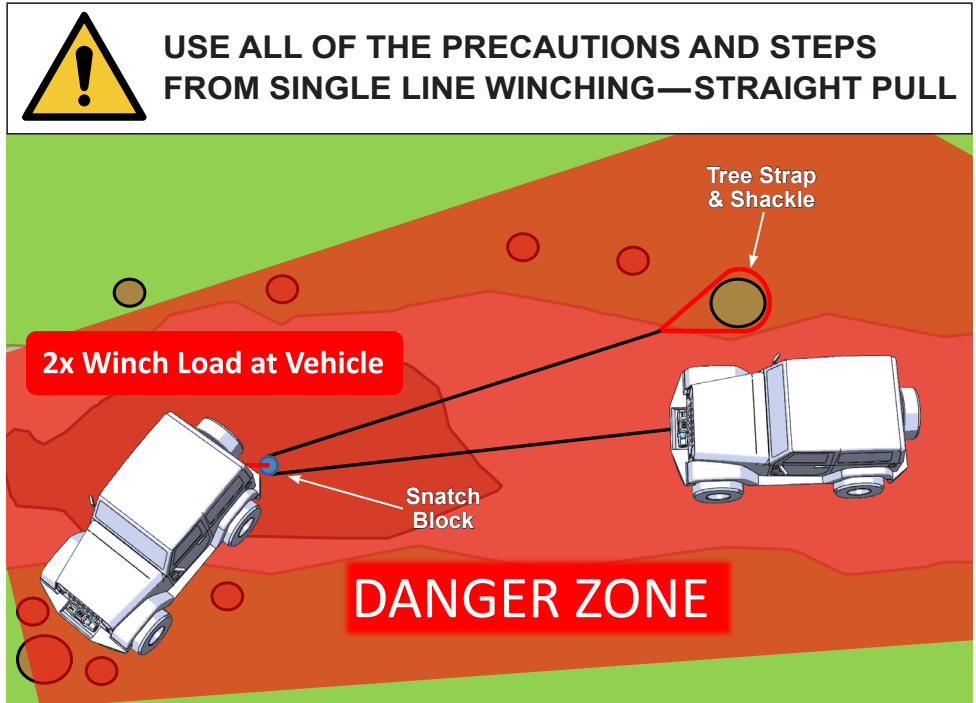

Rigging Needed:

- 1x Tree Strap
- 2x Shackles – Possibly more depending on tow points of stuck vehicle
- 1x Snatch Block

For other vehicle recovery:

Place winch vehicle in NEUTRAL • Keep foot ON brake

FCC Requirement

Any changes or modifications not expressly approved by the party responsible for compliance could void the user's authority to operate the equipment.

This device complies with Part 15 of the FCC Rules. Operation is subject to the following two conditions:

- (1) this device may not cause harmful interference, and
- (2) this device must accept any interference received, including interference that may cause undesired operation.

Note: This equipment has been tested and found to comply with the limits for a Class B digital device, pursuant to Part 15 of the FCC Rules. These limits are designed to provide reasonable protection against harmful interference in a residential installation. This equipment generates, uses, and can radiate radio frequency energy, and if not installed and used in accordance with the instructions, may cause harmful interference to radio communications. However, there is no guarantee that interference will not occur in a particular installation. If this equipment does cause harmful interference to radio or television reception, which can be determined by turning the equipment off and on, the user is encouraged to try to correct the interference by one or more of the following measures:

- Reorient or relocate the receiving antenna.
- Increase the separation between the equipment and receiver.
- Connect the equipment into an outlet on a circuit different from that to which the receiver is connected.
- Consult the dealer or an experienced radio/TV technician for help.

