

FCC Radio Test Report

FCC ID: 2ASYH-K01

The report concerns: Original Grant

Report Reference No.....: 22EFSS07001 06531

Date Sample(s) Received.....: 2022-06-28

Date of Tested.....: From 2022-06-28 to 2022-08-08

Date of issue.....: 2022-08-08

Testing Laboratory: DongGuanShuoXin Electronic Technology Co., Ltd.
Zone A, 1F, No. 6, XinGang Road YuanGang Street,
Address: XinAn District, ChangAn Town, DongGuan City,
GuangDong, China

Applicant's name: HOHMEEASY INDUSTRIAL CO., LIMITED

Address: Flat/Rm 17/F Royal Commercial Centre 56 Parks
Street, Jordan Kowloon,Hong kong

Manufacturer.....: Zhongshan Meta Intelligence Technology Co.,Ltd.

Equipment.....: Fingerprint Lock

Trade Mark: N/A

Model: K01

Ratings: I/P: DC 4.5-6.5V

Test Engineer:

Blue Qiu

Responsible Engineer :

Smile Wang

Authorized Signatory:

King Wang

Table of Contents	Page
1 TEST REPORT DECLARE	4
2 SUMMARY OF TEST RESULTS	5
2.1 MEASUREMENT UNCERTAINTY	6
3 GENERAL INFORMATION	7
3.1 GENERAL DESCRIPTION OF EUT	7
3.2 DESCRIPTION OF TEST MODES	9
3.3 PARAMETERS OF TEST SOFTWARE	9
3.4 BLOCKDIAGRAMSHOWINGTHECONFIGURATIONOFSYSTEMTESTED	10
3.5 SUPPORT UNITS	10
3.6 TEST ENVIRONMENT CONDITIONS	10
4 AC POWER LINE CONDUCTED EMISSIONS TEST	11
4.1 LIMIT	11
4.2 TEST PROCEDURE	11
4.3 MEASUREMENT INSTRUMENTS LIST	11
4.4 TESTSETUP	12
4.5 EUT OPERATING CONDITIONS	12
4.6 TEST RESULTS	13
5 RADIATED EMISSION TEST	15
5.1 LIMIT	15
5.2 TEST PROCEDURE	16
5.3 MEASUREMENT INSTRUMENTS LIST	17
5.4 TESTSETUP	17
5.5 EUT OPERATING CONDITIONS	18
5.6 TEST RESULT- 9KHZ TO 30MHZ	19
5.7 TEST RESULT- 30MHZ TO 1000MHZ	20
5.8 TEST RESULT- ABOVE 1000MHZ(BAND EDGE)	22
5.9 TEST RESULTS - ABOVE 1000MHZ(HARMONIC)	30
6 BANDWIDTH TEST	42
6.1 LIMIT	42
6.2 TEST PROCEDURE AND SETTING	42
6.3 MEASUREMENT INSTRUMENTS LIST	42
6.4 TEST SETUP	42
6.5 EUT OPERATION CONDITIONS	42

Table of Contents	Page
6.6 TESTRESULTS	43
7 MAXIMUM OUTPUT POWER	45
7.1 LIMIT	45
7.2 TEST PROCEDURE	45
7.3 MEASUREMENT INSTRUMENTS LIST	45
7.4 TEST SETUP	45
7.5 EUT OPERATION CONDITIONS	45
7.6 TESTRESULTS	46
8 CONDUCTED SPURIOUS EMISSION	47
8.1 LIMIT	47
8.2 TEST PROCEDURE	47
8.3 MEASUREMENT INSTRUMENTS LIST	47
8.4 TEST SETUP	47
8.5 EUT OPERATION CONDITIONS	47
8.6 TEST RESULTS	48
9 POWER SPECTRAL DENSITY TEST	50
9.1 LIMIT	50
9.2 TEST PROCEDURE	50
9.3 MEASUREMENT INSTRUMENTS LIST	50
9.4 TEST SETUP	50
9.5 EUT OPERATION CONDITIONS	50
9.6 TEST RESULTS	51

1TEST REPORT DECLARE

Applicant	HOHMEEASY INDUSTRIAL CO., LIMITED
Address	Flat/Rm 17/F Royal Commercial Centre 56 Parks Street, Jordan Kowloon,Hong kong
Manufacturer	Zhongshan Meta Intelligence Technology Co.,Ltd.
Address	No.18,Yonghui Road, Nantou Town, Zhongshan, Guangdong, China 528427
Factory	Zhongshan Meta Intelligence Technology Co.,Ltd.
Address	No.18,Yonghui Road, Nantou Town, Zhongshan, Guangdong, China 528427
Equipment	Fingerprint Lock
Model No.	K01
Trade Mark	/
Standard	FCC Part15, Subpart C (15.247) ANSI C63.10-2013

We Declare:

The equipment described above is tested by DongGuan ShuoXin Electronic Technology Co., Ltd(ATT). and in the configuration tested the equipment complied with the standards specified above. The test results are contained in this test report and DongGuan ShuoXin Electronic Technology Co., Ltd.(ATT) is assumed of full responsibility for the accuracy and completeness of these tests.

ATT is not responsible for the sampling stage, so the results only apply to the sample as received.

ATT's reports apply only to the specific samples tested under conditions. It is manufacture's responsibility to ensure that additional production units of this model are manufactured with the identical electrical and mechanical components. ATT shall have no liability for any declarations, inferences or generalizations drawn by the client or others from ATT issued reports.

2SUMMARY OF TEST RESULTS

The EUT have been tested according to the applicable standards as referenced below:

Standard(s) Section		Test Item	Judgment	Remark
FCC	ISED			
15.207	-	AC Power Line Conducted Emissions	PASS	-----
15.247(d) 15.205(a) 15.209(a)	-	Radiated Emissions	PASS	-----
15.247(a)(2)	-	Bandwidth	PASS	-----
15.247(b)(3)	-	Maximum Output Power	PASS	-----
15.247(d)	-	ConductedSpurious Emission	PASS	-----
15.247(e)	-	Power Spectral Density	PASS	-----
-	-	Frequency Stability	PASS	-----
15.203	-	Antenna Requirement	PASS	Note(2)

Note:

- (1) "N/A" denotes test is not applicable to this device.
- (2) The device what use a permanently attached antenna were considered sufficient to comply with the provisions of 15.203.

2.1 MEASUREMENT UNCERTAINTY

Test Item	Uncertainty
Uncertainty for Conduction emission test (9kHz-150kHz)	3.7 dB
Uncertainty for Conduction emission test (150kHz-30MHz)	3.3 dB
Uncertainty for Radiation Emission test (30MHz-200MHz)	4.60 dB (Polarize: V)
	4.60 dB (Polarize: H)
Uncertainty for Radiation Emission test (200MHz-1GHz)	6.10 dB (Polarize: V)
	5.08 dB (Polarize: H)
Uncertainty for Radiation Emission test (1GHz-6GHz)	5.01 dB (Polarize: V)
	5.01 dB (Polarize: H)
Uncertainty for Radiation Emission test (6GHz-18GHz)	5.26 dB (Polarize: V)
	5.26 dB (Polarize: H)
Uncertainty for Radiation Emission test (18GHz-40GHz)	5.06 dB (Polarize: V)
	5.06 dB (Polarize: H)
Uncertainty for radio frequency	±0.048kHz
Uncertainty for conducted RF Power	±0.32dB

Note:

This uncertainty represents an expanded uncertainty expressed at approximately the 95% confidence level using a coverage factor of k=2.

Test Facility:

The Test site used by DongGuan ShuoXin Electronic Technology Co., Ltd. to collect test data is located on the Zone A, 1F, No. 6, XinGang Road YuanGang Street, XinAn District, ChangAn Town, DongGuan City, GuangDong, China

The test facility is recognized, certified, or accredited by the following organizations:

Item	Registration No.	Expiration Date
CNAS	L3098	2024-08-27
A2LA	4893.01	2022-08-30
Innovation, Science and Economic Development Canada (ISED)	11033A CAB identifier:CN0083	2022-08-30
Federal Communications Commission (FCC)	171688 Designation No.:CN1235	2022-08-30

3 GENERAL INFORMATION

3.1 GENERAL DESCRIPTION OF EUT

Equipment	Fingerprint Lock	
Brand Name	/	
Test Model	K01	
Series Model	N/A	
Model Difference(s)	N/A	
Hardware Version	V1.0	
Software Version	V1.0	
Power Source	Supplied from Battery.	
Power Rating	DC 6V	
Operation Frequency	2402 MHz ~ 2480 MHz	
Modulation Technology	GFSK	
Bit Rate of Transmitter	2Mbps	
Antenna Information	Antenna Type:PCB	Maximum Peak Gain:0dBi
Max. Output Power	4.079dBm(0.002558W)1Mbps 4.089dBm(0.002564W)2Mbps	

Note:

1. For a more detailed features description, please refer to the manufacturer's specifications or the user's manual.

2. Channel List:

Channel	Frequency (MHz)	Channel	Frequency (MHz)
00	2402	20	2442
01	2404	21	2444
02	2406	22	2446
03	2408	23	2448
04	2410	24	2450
05	2412	25	2452
06	2414	26	2454
07	2416	27	2456
08	2418	28	2458
09	2420	29	2460
10	2422	30	2462
11	2424	31	2464
12	2426	32	2466
13	2428	33	2468
14	2430	34	2470
15	2432	35	2472
16	2434	36	2474
17	2436	37	2476
18	2438	38	2478
19	2440	39	2480

3.2 DESCRIPTION OF TEST MODES

The test system was pre-tested based on the consideration of all possible combinations of EUT operation mode.

Pretest Mode	Description
Mode 1	BLE 1M TX Mode NOTE (1)
Mode 2	BLE 2M TX Mode NOTE (1)

Following mode(s) as (were) found to be the worst case(s) and selected for the final test.

Radiated emissions test - Below 1GHz	
Final Test Mode	Description
Mode 1	BLE 1M TX Mode NOTE (1)

Radiated emissions test - Above 1GHz	
Final Test Mode	Description
Mode 1	BLE 1M TX Mode NOTE (1)
Mode 2	BLE 2M TX Mode NOTE (1)

Conducted test	
Final Test Mode	Description
Mode 1	BLE 1M TX Mode NOTE (1)
Mode 2	BLE 2M TX Mode NOTE (1)

Note:

(1) The measurements are performed at the high, middle, low available channels.

3.3 PARAMETERS OF TEST SOFTWARE

During testing channel & power controlling software provided by the customer was used to control the operating channel as well as the output power level. The RF output power selection is for the setting of RF output power expected by the customer and is going to be fixed on the firmware of the final end product power parameters of BT LE

Test Software	RTL8762x_RFTTestTool		
Frequency (MHz)	2402	2440	2480
Parameters-1Mbps	Default	Default	Default
Parameters-2Mbps	Default	Default	Default

3.4 BLOCK DIAGRAM SHOWING THE CONFIGURATION OF SYSTEM TESTED

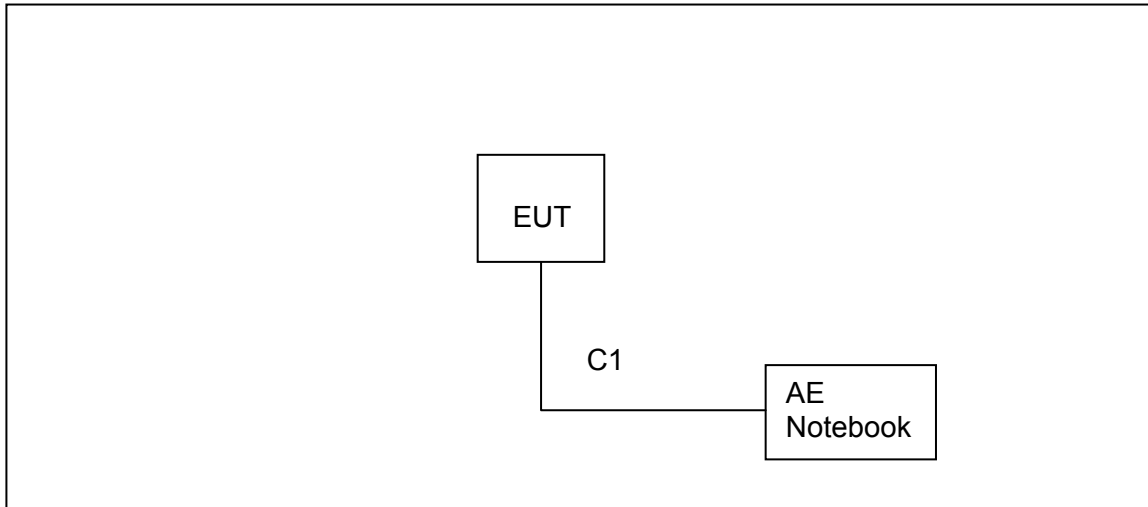

3.5 SUPPORT UNITS

Item	Equipment	Brand	Model No.	Series No.
AE	Notebook	Lenovo	/	/

Item	Cable Type	Shielded Type	Ferrite Core	Length
C1	DC Cable	NO	NO	0.8m

3.6 TEST ENVIRONMENT CONDITIONS

Test Item	Temperature	Humidity	Test Voltage
AC Power Line Conducted Emissions	23.1°C	52%	AC120V 60Hz
Radiated Emissions-9K-30MHz	22°C	60%	DC 5V
Radiated Emissions-30 MHz to 1GHz	23°C	54%	DC 5V
Radiated Emissions-Above 1000 MHz	23°C	54%	DC 5V
Bandwidth	20.6°C	51%	DC 5V
Maximum Output Power	20.6°C	51%	DC 5V
Conducted Spurious Emission	20.6°C	51%	DC 5V
Power Spectral Density	20.6°C	51%	DC 5V

4AC POWER LINE CONDUCTED EMISSIONS TEST

4.1LIMIT

Frequency of Emission (MHz)	Limit (dBµV)	
	Quasi-peak	Average
0.15 - 0.50	66 to 56*	56 to 46*
0.50 - 5.0	56	46
5.0 - 30.0	60	50

Note:

- (1) The tighter limit applies at the band edges.
- (2) The limit of " * " marked band means the limitation decreases linearly with the logarithm of the frequency in the range.

The following table is the setting of the receiver

Receiver Parameters	Setting
Attenuation	10 dB
Start Frequency	0.15 MHz
Stop Frequency	30 MHz
IF Bandwidth	9 kHz

4.2TEST PROCEDURE

- a. The EUT was placed 0.8 meters from the horizontal ground plane with EUT being connected to the power mains through a line impedance stabilization network (LISN). All other support equipment powered from additional LISN(s). The LISN provide 50 Ohm/ 50uH of coupling impedance for the measuring instrument.
- b. Interconnecting cables that hang closer than 40 cm to the ground plane shall be folded back and forth in the center forming a bundle 30 to 40 cm long.
- c. I/O cables that are not connected to a peripheral shall be bundled in the center. The end of the cable may be terminated, if required, using the correct terminating impedance. The overall length shall not exceed 1 m.
- d. LISN at least 80 cm from nearest part of EUT chassis.

4.3MEASUREMENT INSTRUMENTS LIST

Item	Kind of Equipment	Manufacturer	Type No.	Serial No.	Calibrated until
1	Pulse Limiter	MTS-systemtechnik	MTS-IMP-136	261115-010-0024	12/19/2022
2	EMI Test Receiver	R&S	ESCI	101308	12/17/2022
3	LISN	AFJ	LS16	16011103219	05/23/2023
4	LISN	Schwarzbeck	NSLK 8127	8127-432	12/17/2022
5	Measurement Software	Farad	EZ-EMC (Ver.ATT-03A)	N/A	N/A

4.4 TEST SETUP

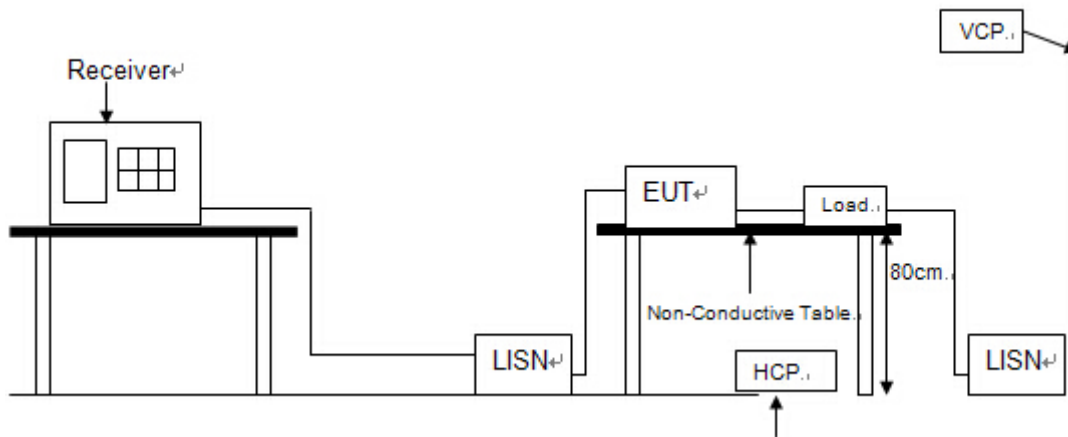

4.5 EUT OPERATING CONDITIONS

The EUT was configured for testing in a typical function (as a customer would normally use it), EUT was programmed to be in continuously transmitting data or hopping on mode.

4.6 TEST RESULTS

Test Mode: BLE 1M TX Mode

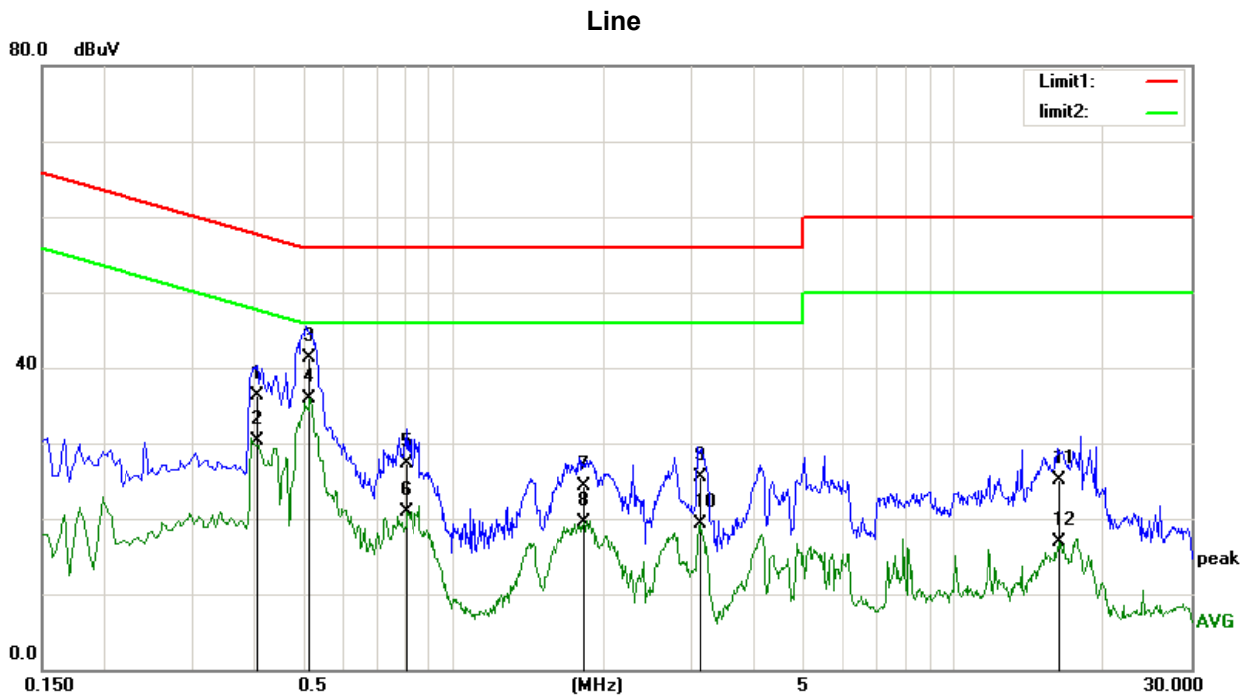

No.	Frequency (MHz)	Reading (dBuV)	Correct Factor(dB)	Result (dBuV)	Limit (dBuV)	Margin (dB)	Remark
1	0.4060	25.87	10.42	36.29	57.73	-21.44	QP
2	0.4060	19.96	10.42	30.38	47.73	-17.35	AVG
3	0.5180	30.96	10.30	41.26	56.00	-14.74	QP
4	0.5180	25.61	10.30	35.91	46.00	-10.09	AVG
5	0.8059	17.02	10.24	27.26	56.00	-28.74	QP
6	0.8059	10.63	10.24	20.87	46.00	-25.13	AVG
7	1.8220	14.15	10.24	24.39	56.00	-31.61	QP
8	1.8220	9.24	10.24	19.48	46.00	-26.52	AVG
9	3.1179	15.23	10.25	25.48	56.00	-30.52	QP
10	3.1179	9.07	10.25	19.32	46.00	-26.68	AVG
11	16.3899	14.90	10.25	25.15	60.00	-34.85	QP
12	16.3899	6.71	10.25	16.96	50.00	-33.04	AVG

Remarks:

- (1) Measurement Value = Reading Level + Correct Factor.
- (2) Margin Level = Measurement Value - Limit Value.

Test Mode: BLE 1M TX Mode

Neutral

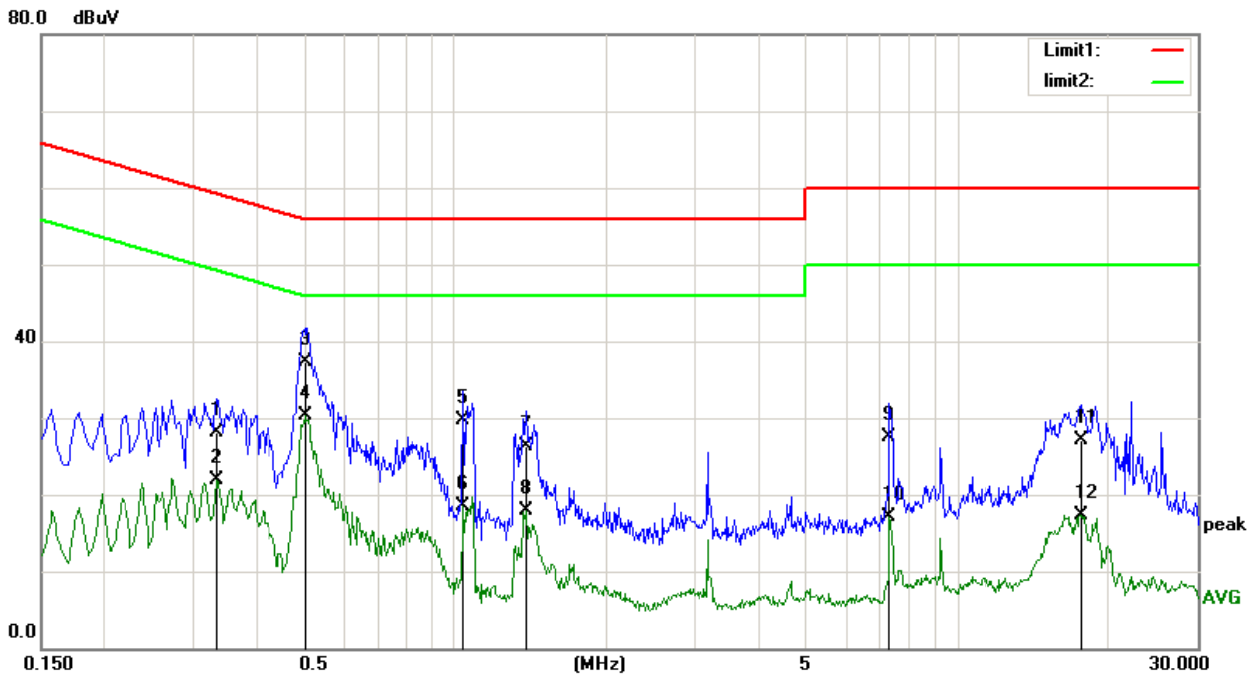

No.	Frequency (MHz)	Reading (dBuV)	Correct Factor(dB)	Result (dBuV)	Limit (dBuV)	Margin (dB)	Remark
1	0.3339	17.66	10.50	28.16	59.35	-31.19	QP
2	0.3339	11.41	10.50	21.91	49.35	-27.44	AVG
3	0.5020	26.95	10.31	37.26	56.00	-18.74	QP
4	0.5020	19.92	10.31	30.23	46.00	-15.77	AVG
5	1.0380	19.42	10.23	29.65	56.00	-26.35	QP
6	1.0380	8.37	10.23	18.60	46.00	-27.40	AVG
7	1.3819	16.15	10.23	26.38	56.00	-29.62	QP
8	1.3819	7.59	10.23	17.82	46.00	-28.18	AVG
9	7.3139	17.28	10.23	27.51	60.00	-32.49	QP
10	7.3139	6.91	10.23	17.14	50.00	-32.86	AVG
11	17.6058	16.90	10.25	27.15	60.00	-32.85	QP
12	17.6058	7.13	10.25	17.38	50.00	-32.62	AVG

Remarks:

- (1) Measurement Value = Reading Level + Correct Factor.
- (2) Margin Level = Measurement Value - Limit Value.

5 RADIATED EMISSION TEST

5.1 LIMIT

In case the emission fall within the restricted band specified on 15.205(a) and RSS-Gen 8.10, then the 15.209(a) and RSS-Gen 8.9 limit in the table below has to be followed.

LIMITS OF RADIATED EMISSION MEASUREMENT (9 kHz-1000MHz)

Frequency (MHz)	Field Strength (microvolts/meter)	Measurement Distance (meters)
0.009-0.490	2400/F(kHz)	300
0.490-1.705	24000/F(kHz)	30
1.705-30.0	30	30
30-88	100	3
88-216	150	3
216-960	200	3
Above 960	500	3

LIMITS OF RADIATED EMISSION MEASUREMENT (9 kHz-30 MHz)

Frequency (MHz)	Magnetic field strength (H-Field) (µA/m)	Measurement Distance (meters)
0.009-0.490	6.37/F(kHz)	300
0.490-1.705	6.37/F(kHz)	30
1.705-30.0	0.08	30

LIMITS OF RADIATED EMISSION MEASUREMENT (30 MHz-1000MHz)

Frequency (MHz)	Field Strength (µV/m at 3m)
30-88	100
88-216	150
216-960	200
Above 960	500

LIMITS OF RADIATED EMISSION MEASUREMENT (Above 1000MHz)

Frequency (MHz)	(dBuV/m at 3 m)	
	Peak	Average
Above 1000	74	54

Note:

- (1) The limit for radiated test was performed according to FCC PART 15C and RSS-247.
- (2) The tighter limit applies at the band edges.
- (3) Emission level (dBuV/m)=20log Emission level (uV/m).

5.2 TEST PROCEDURE

- a. The measuring distance of 3 m shall be used for measurements. The EUT was placed on the top of a rotating table 0.8 meter above the ground at a 3 meter semi-anechoic chamber. The table was rotated 360 degrees to determine the position of the highest radiation.(below 1GHz)
- b. The measuring distance of 3 m or 1.5m shall be used for measurements. The EUT was placed on the top of a rotating table 1.5 meter above the ground at a 3 meter semi-anechoic chamber. The table was rotated 360 degrees to determine the position of the highest radiation.(above 1GHz)
- c. The height of the equipment or of the substitution antenna shall be 0.8m or 1.5m; the height of the test antenna shall vary between 1 m to 4 m. Both horizontal and vertical polarizations of the antenna are set to make the measurement.
- d. For each suspected emission, the EUT was arranged to its worst case and then the antenna was tuned to heights find the maximum reading (used Bore sight function).
- e. The receiver system was set to peak and average detect function and specified bandwidth with maximum hold mode when the test frequency is above 1GHz.
- f. The initial step in collecting radiated emission data is a receiver peak detector mode pre-scanning the measurement frequency range. Significant peaks are then marked and then Quasi Peak detector mode re-measured.
- g. All readings are Peak unless otherwise stated QP in column of Note. Peak denotes that the Peak reading compliance with the QP Limits and then QP Mode measurement didn't perform. (below 1GHz)
- h. All readings are Peak Mode value unless otherwise stated AVG in column of Note. If the Peak Mode Measured value compliance with the Peak Limits and lower than AVG Limits, the EUT shall be deemed to meet both Peak & AVG Limits and then only Peak Mode was measured, but AVG Mode didn't perform. (above 1GHz)
- i. The test result is calculated as the following:
 - (1) Result = Reading + Correct Factor
 - (2) Correct Factor = Antenna Factor + Cable Loss – Amplifier Gain + Attenuator
 - (3) Margin = Result - Limit

Spectrum Parameter	Setting
Attenuation	Auto
Start Frequency	1000 MHz
Stop Frequency	10th carrier harmonic
RBW / VBW (Emission in restricted band)	RBW 1MHz VBW 3MHz peak detector for Pk value RMS detector for AV value

Receiver Parameter	Setting
Attenuation	Auto
Start ~ Stop Frequency	9 kHz~90 kHz for PK/AVG detector
Start ~ Stop Frequency	90 kHz~110 kHz for QP detector
Start ~ Stop Frequency	110 kHz~490 kHz for PK/AVG detector
Start ~ Stop Frequency	490 kHz~30 MHz for QP detector
Start ~ Stop Frequency	30MHz~1000MHz for QP detector

5.3 MEASUREMENT INSTRUMENTS LIST

Item	Equipment	Manufacturer	Model No.	Serial No.	Calibrated until
1	EMI Test Receiver	R&S	ESCI	101307	12/17/2022
2	Spectrum Analyzer	Agilent	E4407B	US40240708	11/16/2022
3	Loop antenna	SCHWARZBECK K	FMZB1519	1519-062	12/17/2022
4	Broadband antenna	SCHWARZBECK	VULB9168	VULB9168-192	08/05/2022
5	HORN ANTENNA	SCHWARZBECK	BBHA9120D	9120D 1065	04/18/2023
6	Preamplifier Amplifier	HP	8447F	3113A05680	12/19/2022
7	PRE-AMPLIFIER	CY	EMC011830	980136	04/18/2023
8	RF Cable	R&S	Test Cable 4	4	12/19/2022
9	RF Cable	R&S	Test Cable 5	5	12/19/2022
10	RF Cable	R&S	Test Cable 9	9	04/18/2023
11	RF Cable	R&S	Test Cable 10	10	12/19/2022
12	Measurement Software	Farad	EZ-EMC (Ver.ATT-03A)	N/A	N/A

5.4 TEST SETUP

9 kHz-30 MHz

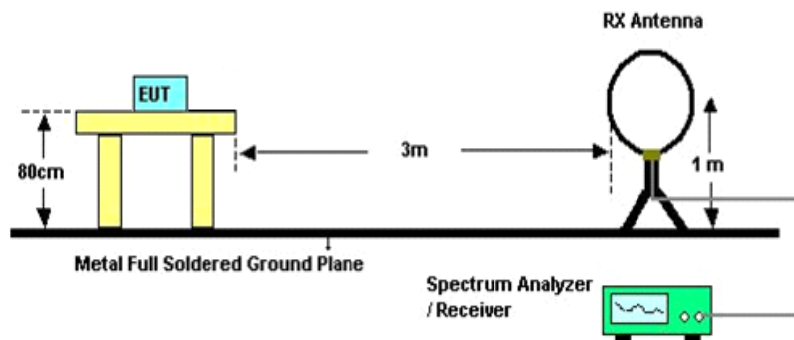

30 MHz to 1 GHz

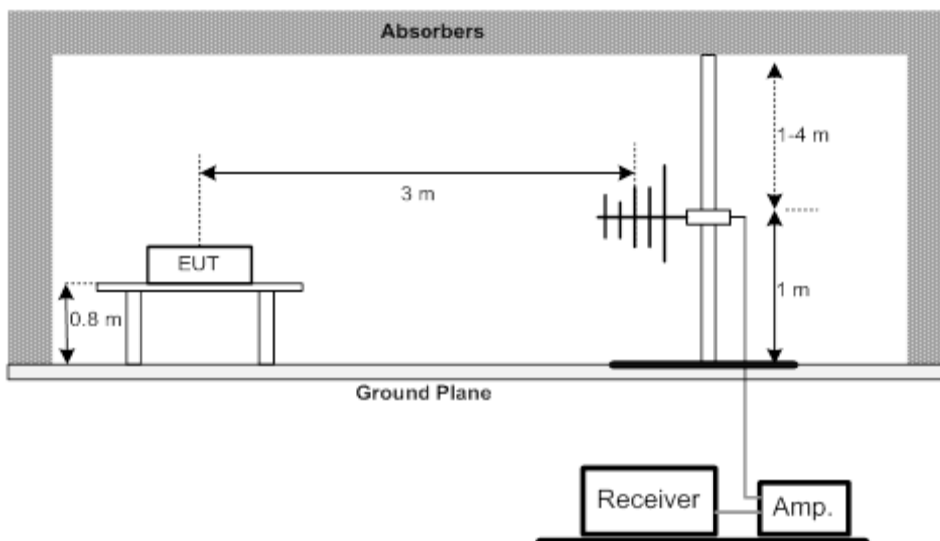

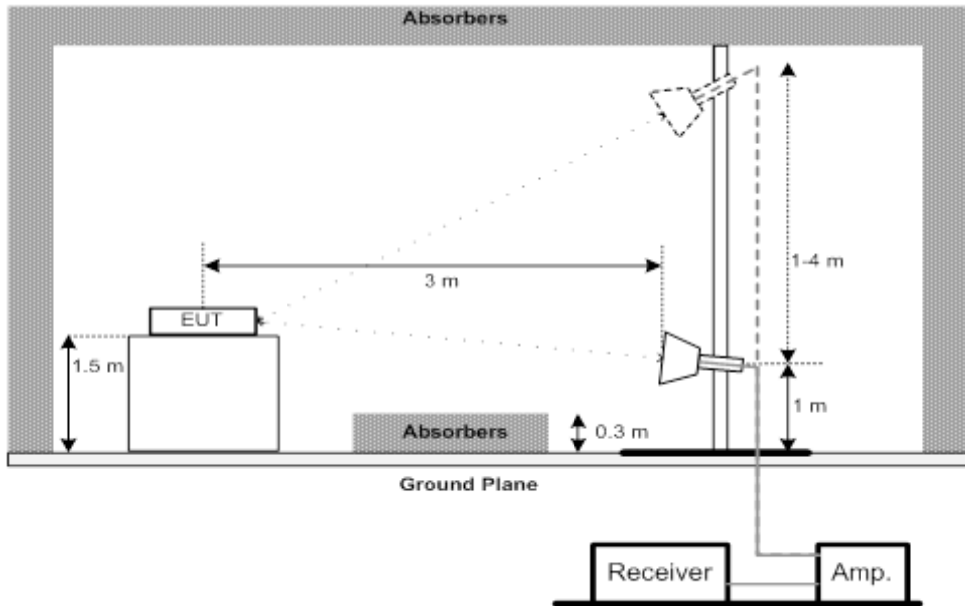
Above 1 GHz**5.5 EUT OPERATING CONDITIONS**

The EUT was programmed to be in continuously transmitting mode.

5.6 TEST RESULT- 9kHz TO 30MHz

Test Mode:	BLE 1M TX Mode
------------	----------------

Freq. (MHz)	Reading (dBuV/m)	Limit (dBuV/m)	Margin (dB)	State P/F
--	--	--	--	P
--	--	--	--	P

Note:

The amplitude of spurious emissions which are attenuated by more than 20dB below the permissible value has no need to be reported.

Distance extrapolation factor = $20 \log (\text{specific distance}/\text{test distance})(\text{dB})$;

Limit line = specific limits(dBuv) + distance extrapolation factor

5.7 TEST RESULT- 30MHz TO 1000MHz

Test Mode : BLE 1M TX Mode

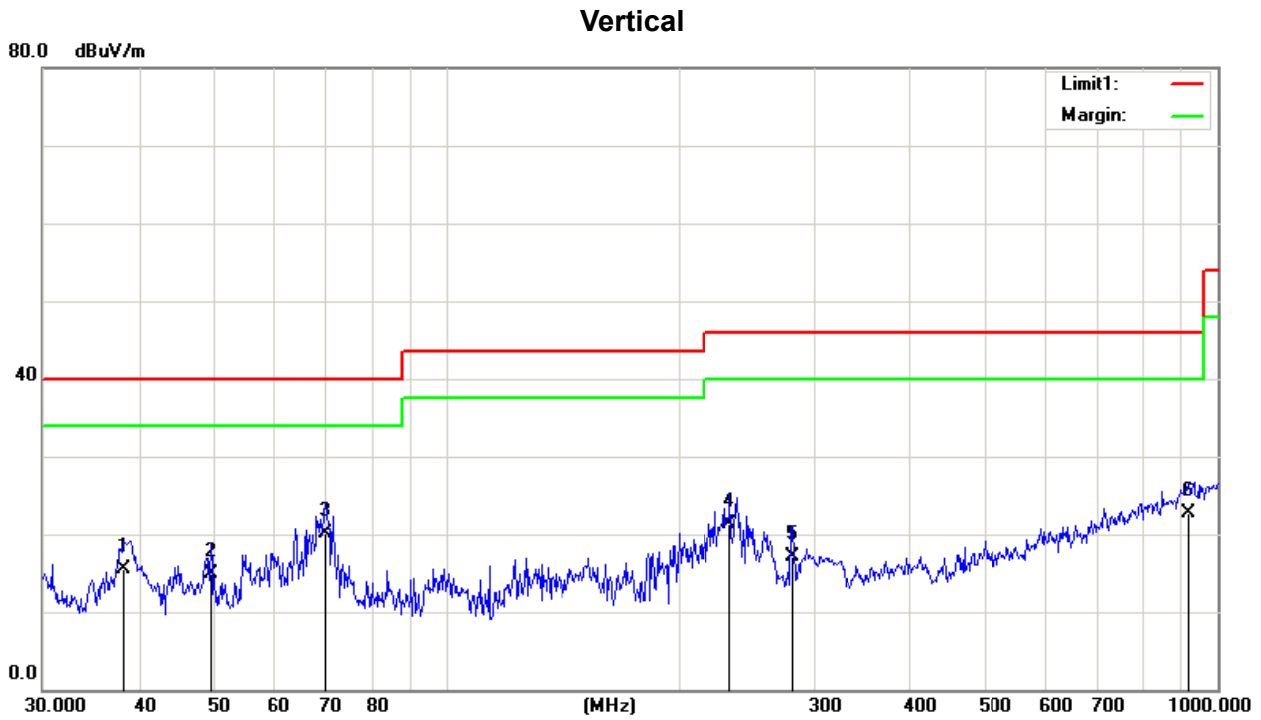

No.	Frequency (MHz)	Reading (dBuV/m)	Correct Factor(dB/m)	Result (dBuV/m)	Limit (dBuV/m)	Margin (dB)	Remark
1	38.0782	29.45	-13.85	15.60	40.00	-24.40	QP
2	49.5328	28.90	-14.04	14.86	40.00	-25.14	QP
3	69.6003	35.79	-15.73	20.06	40.00	-19.94	QP
4	233.3487	32.45	-11.05	21.40	46.00	-24.60	QP
5	281.0074	25.79	-8.63	17.16	46.00	-28.84	QP
6	916.0687	22.78	-0.02	22.76	46.00	-23.24	QP

Test Mode : BLE 1M TX Mode Channel 00

Horizontal

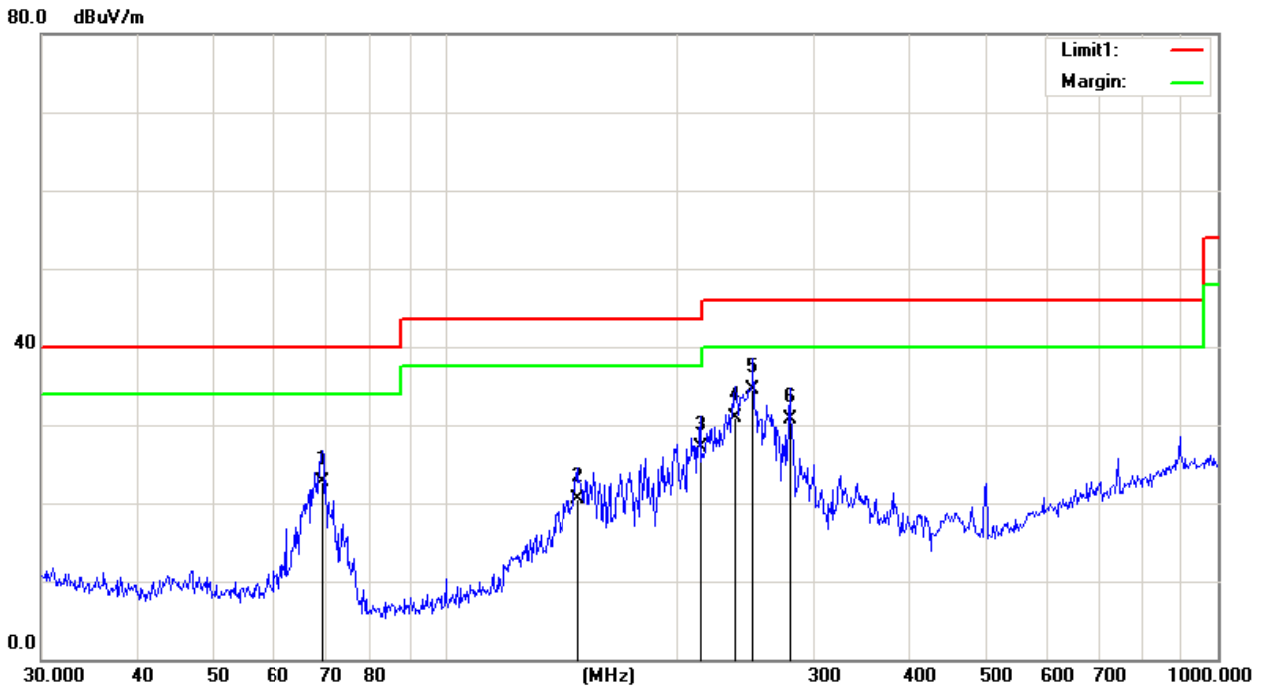

No.	Frequency (MHz)	Reading (dBuV/m)	Correct Factor(dB/m)	Result (dBuV/m)	Limit (dBuV/m)	Margin (dB)	Remark
1	69.3568	39.56	-16.87	22.69	40.00	-17.31	QP
2	148.4410	34.69	-14.21	20.48	43.50	-23.02	QP
3	213.7632	38.57	-11.45	27.12	43.50	-16.38	QP
4	237.4756	39.84	-8.96	30.88	46.00	-15.12	QP
5	250.3009	42.65	-8.19	34.46	46.00	-11.54	QP
6	279.0436	38.09	-7.29	30.80	46.00	-15.20	QP

5.8 TEST RESULT- ABOVE 1000MHz(BAND EDGE)

Test Mode: TX 2402 MHz_CH00_1Mbps

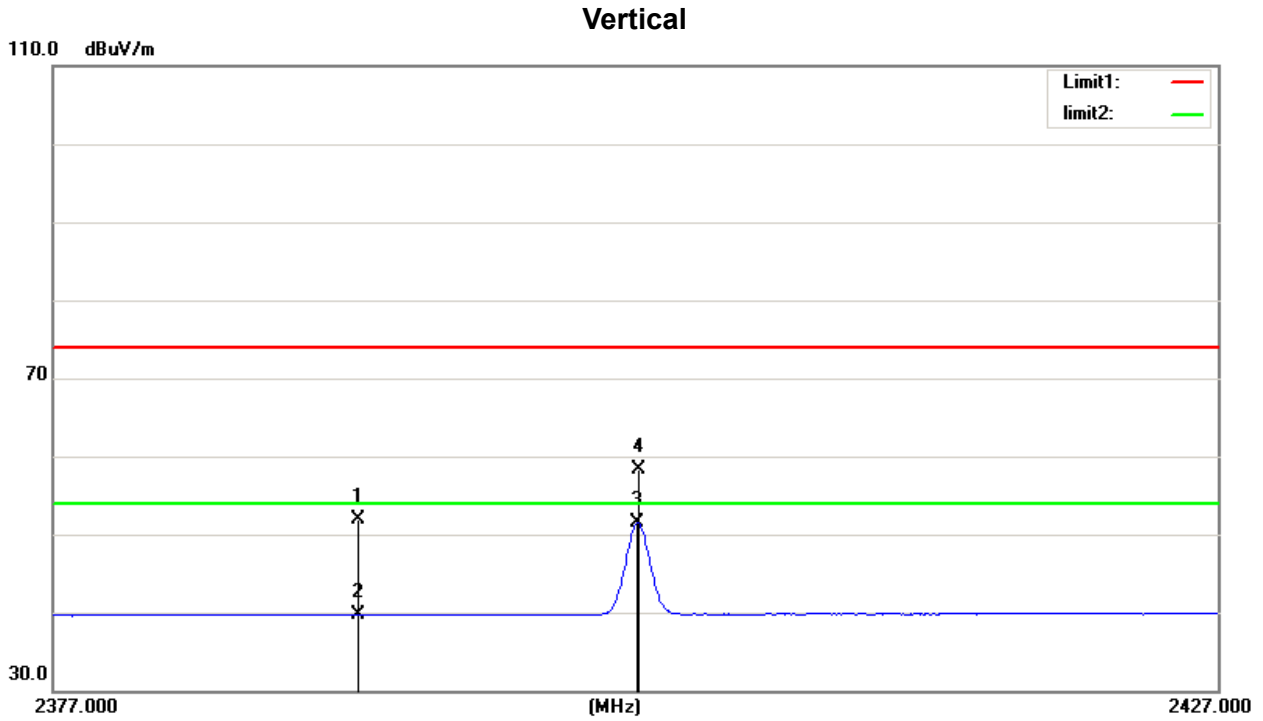

No.	Frequency (MHz)	Reading (dBuV/m)	Correct Factor(dB/m)	Result (dBuV/m)	Limit (dBuV/m)	Margin (dB)	Remark
1	2390.000	22.30	29.60	51.90	74.00	-22.10	peak
2	2390.000	10.05	29.60	39.65	54.00	-14.35	AVG
3	2402.000	21.86	29.62	51.48	/	/	AVG
4	2402.050	28.62	29.62	58.24	/	/	peak

Test Mode: TX 2402 MHz_CH00_1Mbps

Horizontal

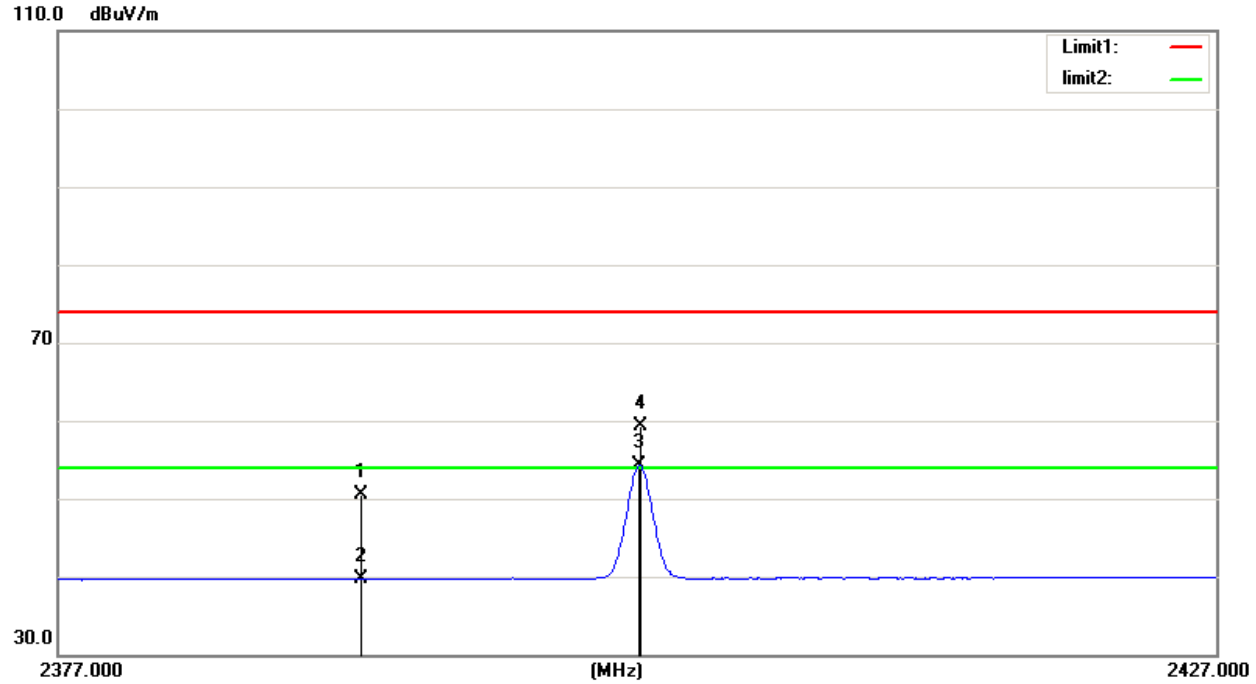

No.	Frequency	Reading	Correct	Result	Limit	Margin	Remark
	(MHz)	(dBuV/m)	Factor(dB/m)	(dBuV/m)	(dBuV/m)	(dB)	
1	2390.000	20.91	29.60	50.51	74.00	-23.49	peak
2	2390.000	10.09	29.60	39.69	54.00	-14.31	AVG
3	2402.000	24.59	29.62	54.21	/	/	AVG
4	2402.050	29.59	29.62	59.21	/	/	peak

Test Mode: TX 2480 MHz_CH39_1Mbps

Vertical

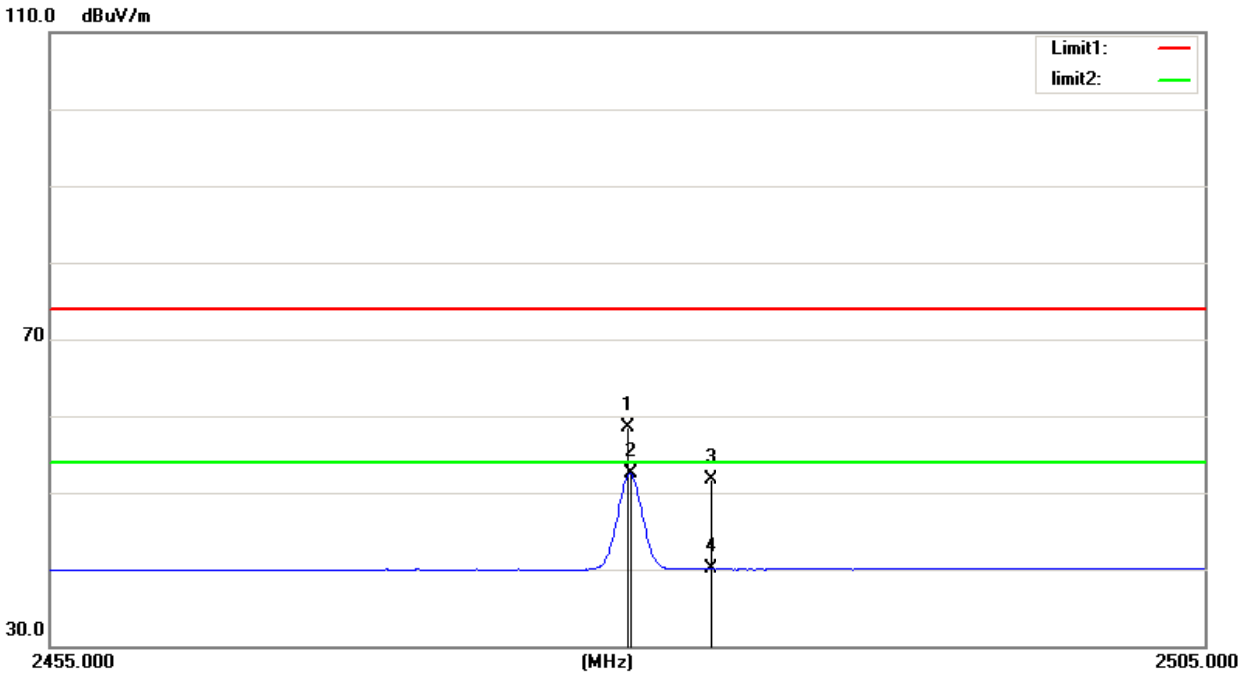

No.	Frequency (MHz)	Reading (dBuV/m)	Correct Factor(dB/m)	Result (dBuV/m)	Limit (dBuV/m)	Margin (dB)	Remark
1	2479.900	28.65	29.80	58.45	/	/	peak
2	2480.050	22.62	29.80	52.42	/	/	AVG
3	2483.500	21.88	29.81	51.69	74.00	-22.31	peak
4	2483.500	10.24	29.81	40.05	54.00	-13.95	AVG

Test Mode: TX 2480 MHz_CH39_1Mbps

Horizontal

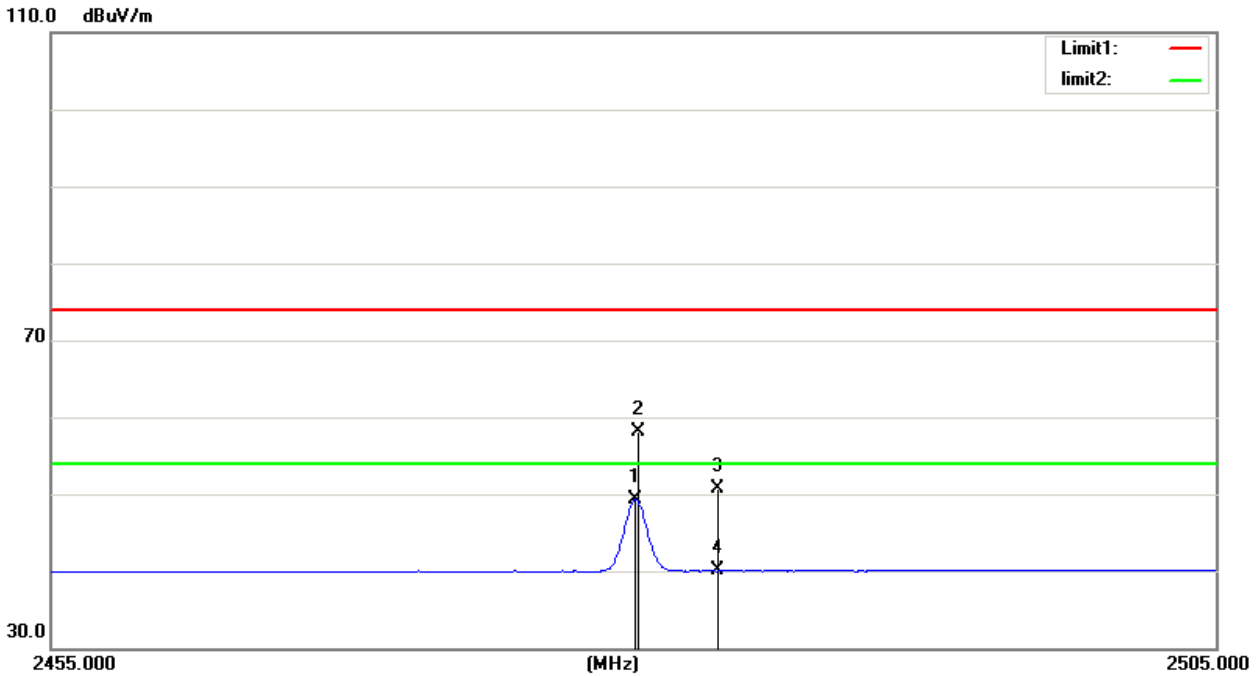

No.	Frequency (MHz)	Reading (dBuV/m)	Correct Factor(dB/m)	Result (dBuV/m)	Limit (dBuV/m)	Margin (dB)	Remark
1	2480.000	19.52	29.80	49.32	/	/	AVG
2	2480.150	28.24	29.80	58.04	/	/	peak
3	2483.500	20.80	29.81	50.61	74.00	-23.39	peak
4	2483.500	10.20	29.81	40.01	54.00	-13.99	AVG

Test Mode: TX 2402 MHz_CH00_2Mbps

Vertical

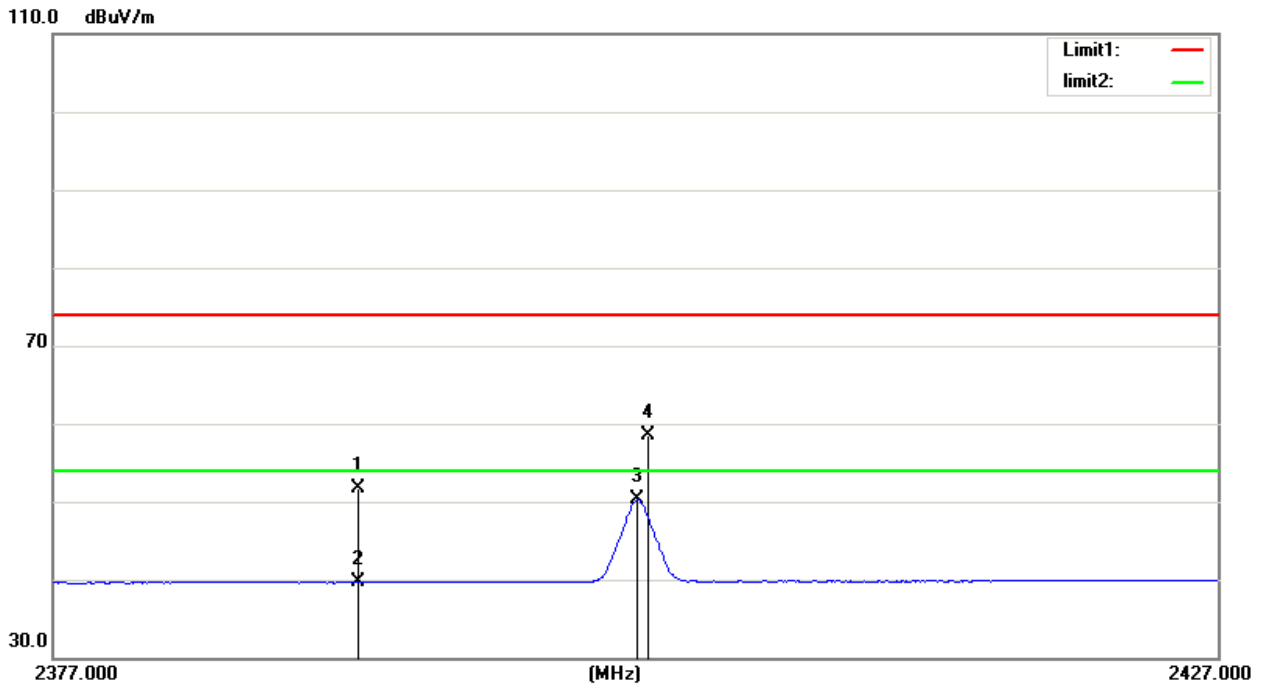

No.	Frequency (MHz)	Reading (dBuV/m)	Correct Factor(dB/m)	Result (dBuV/m)	Limit (dBuV/m)	Margin (dB)	Remark
1	2390.000	22.08	29.60	51.68	74.00	-22.32	peak
2	2390.000	10.04	29.60	39.64	54.00	-14.36	AVG
3	2402.000	20.63	29.62	50.25	/	/	AVG
4	2402.450	28.85	29.63	58.48	/	/	peak

Test Mode: TX 2402 MHz_CH00_2Mbps

Horizontal

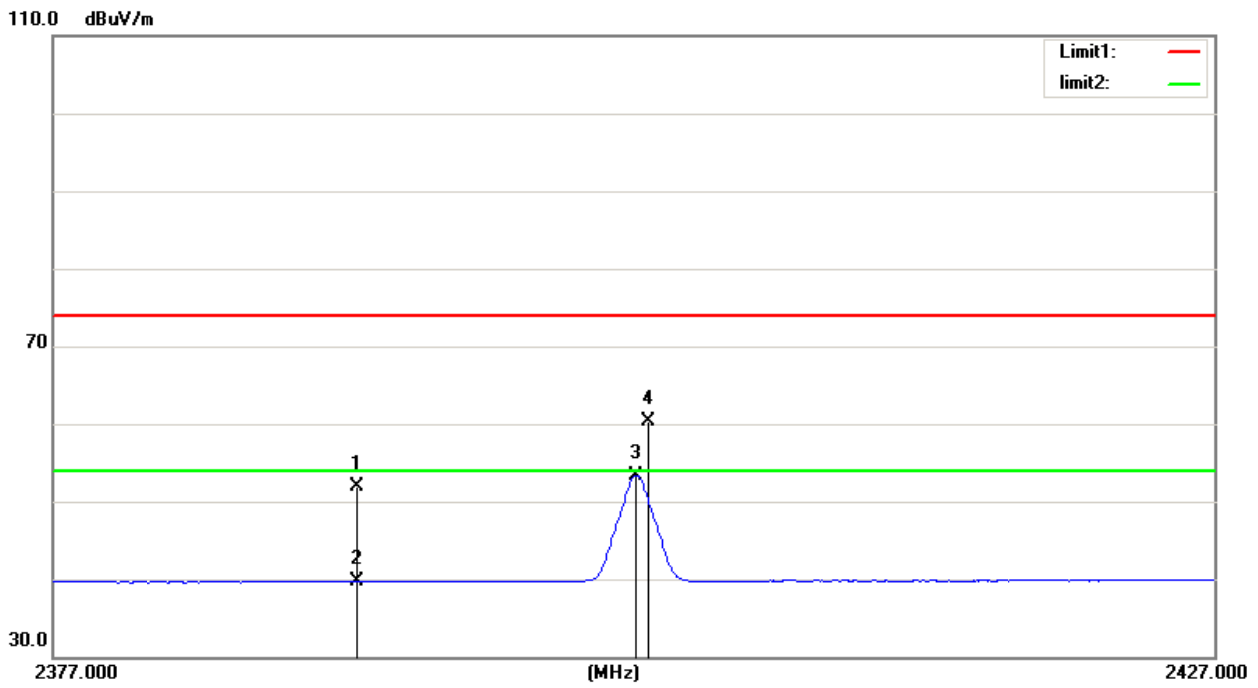

No.	Frequency (MHz)	Reading (dBuV/m)	Correct Factor(dB/m)	Result (dBuV/m)	Limit (dBuV/m)	Margin (dB)	Remark
1	2390.000	22.28	29.60	51.88	74.00	-22.12	peak
2	2390.000	10.03	29.60	39.63	54.00	-14.37	AVG
3	2402.000	23.76	29.62	53.38	/	/	AVG
4	2402.500	30.62	29.63	60.25	/	/	peak

Test Mode: TX 2480 MHz_CH39_2Mbps

Vertical

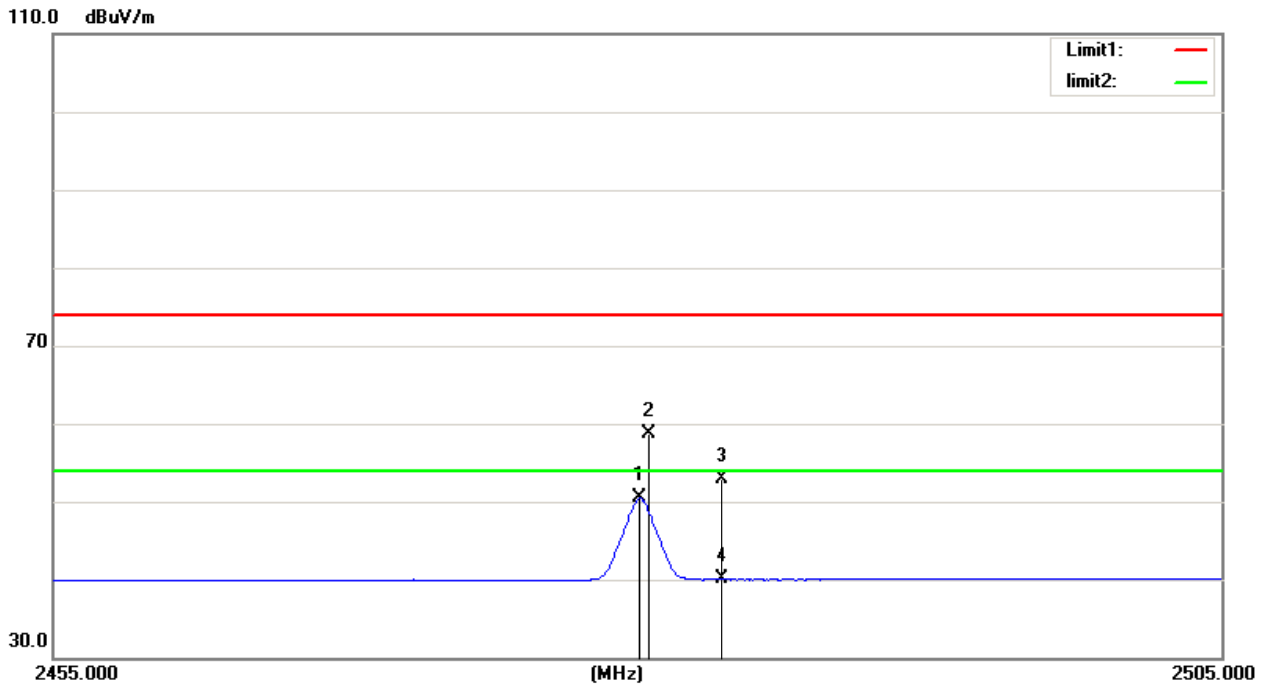

No.	Frequency (MHz)	Reading (dBuV/m)	Correct Factor(dB/m)	Result (dBuV/m)	Limit (dBuV/m)	Margin (dB)	Remark
1	2480.000	20.61	29.80	50.41	/	/	peak
2	2480.400	28.83	29.80	58.63	/	/	peak
3	2483.500	23.08	29.81	52.89	74.00	-21.11	peak
4	2483.500	10.27	29.81	40.08	74.00	-33.92	peak

Test Mode: TX 2480 MHz_CH39_2Mbps

Horizontal

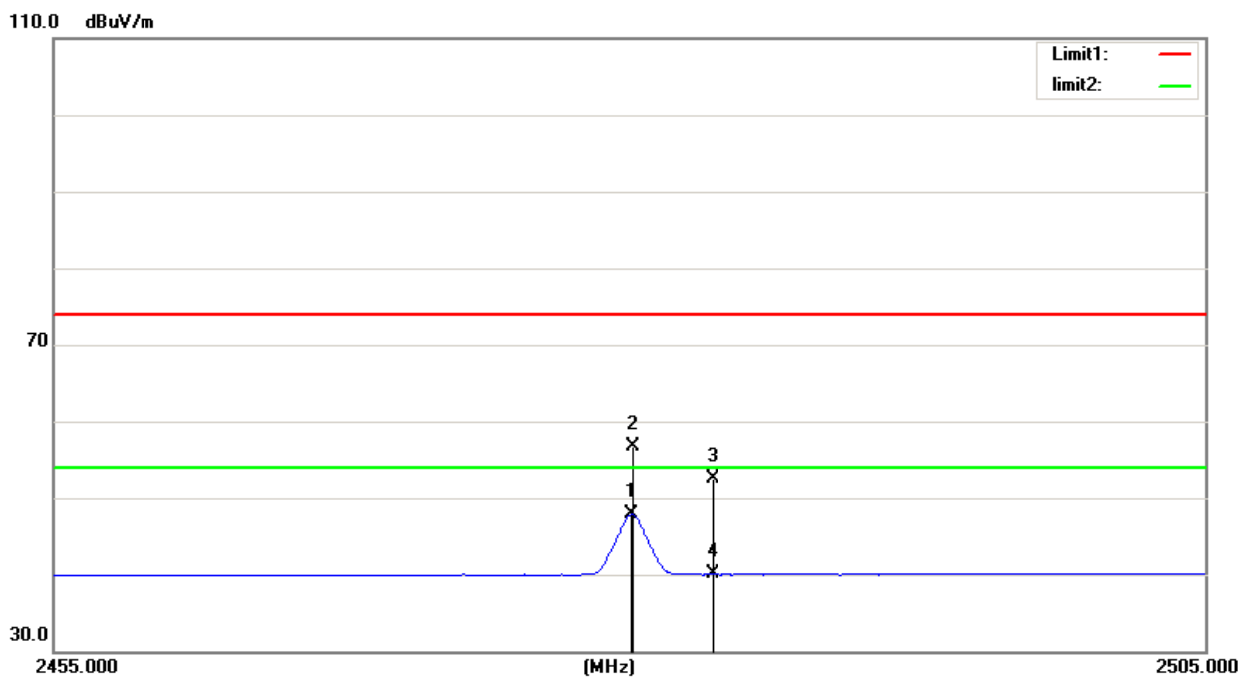

No.	Frequency (MHz)	Reading (dBuV/m)	Correct Factor(dB/m)	Result (dBuV/m)	Limit (dBuV/m)	Margin (dB)	Remark
1	2480.000	18.05	29.80	47.85	/	/	AVG
2	2480.050	26.83	29.80	56.63	/	/	peak
3	2483.500	22.72	29.81	52.53	74.00	-21.47	peak
4	2483.500	10.24	29.81	40.05	54.00	-13.95	AVG

5.9 TEST RESULTS - ABOVE 1000MHz(HARMONIC)

Test Mode: TX 2402 MHz_CH00_1Mbps

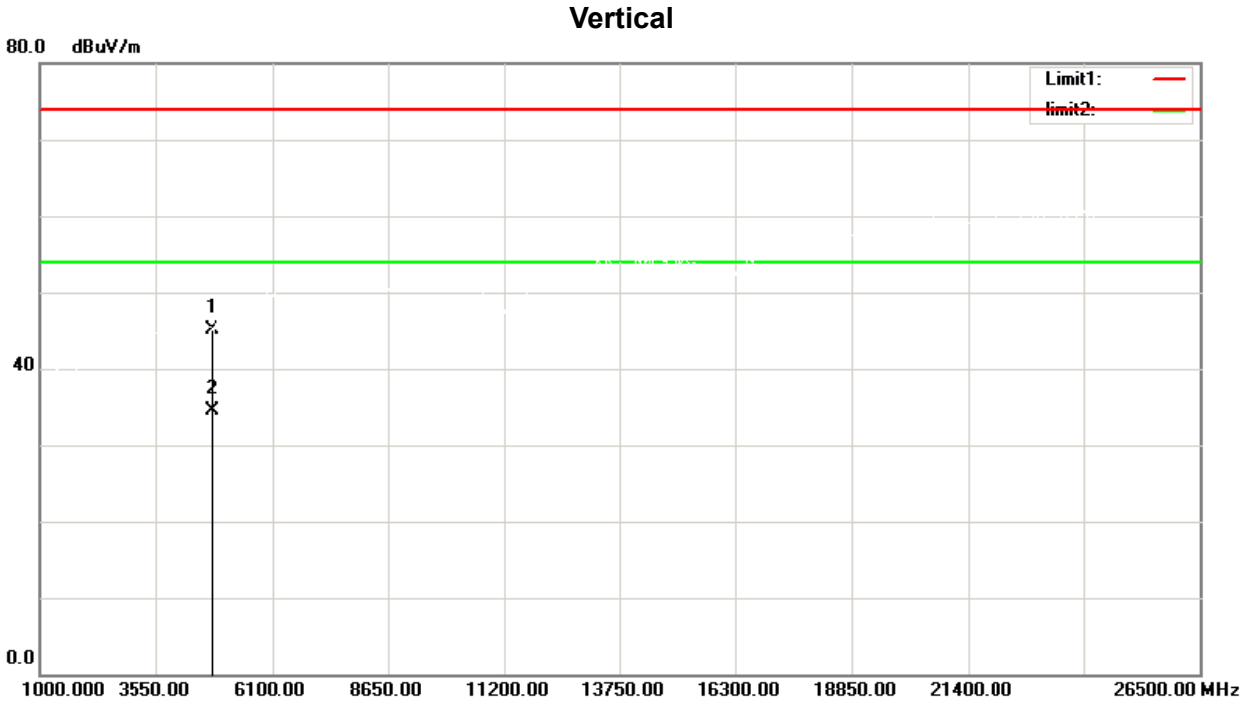

No.	Frequency (MHz)	Reading (dBuV/m)	Correct Factor(dB/m)	Result (dBuV/m)	Limit (dBuV/m)	Margin (dB)	Remark
1	4804.000	53.04	-8.01	45.03	74.00	-28.97	peak
2	4804.000	42.57	-8.01	34.56	54.00	-19.44	AVG

Test Mode: TX 2402 MHz_CH00_1Mbps

Horizontal

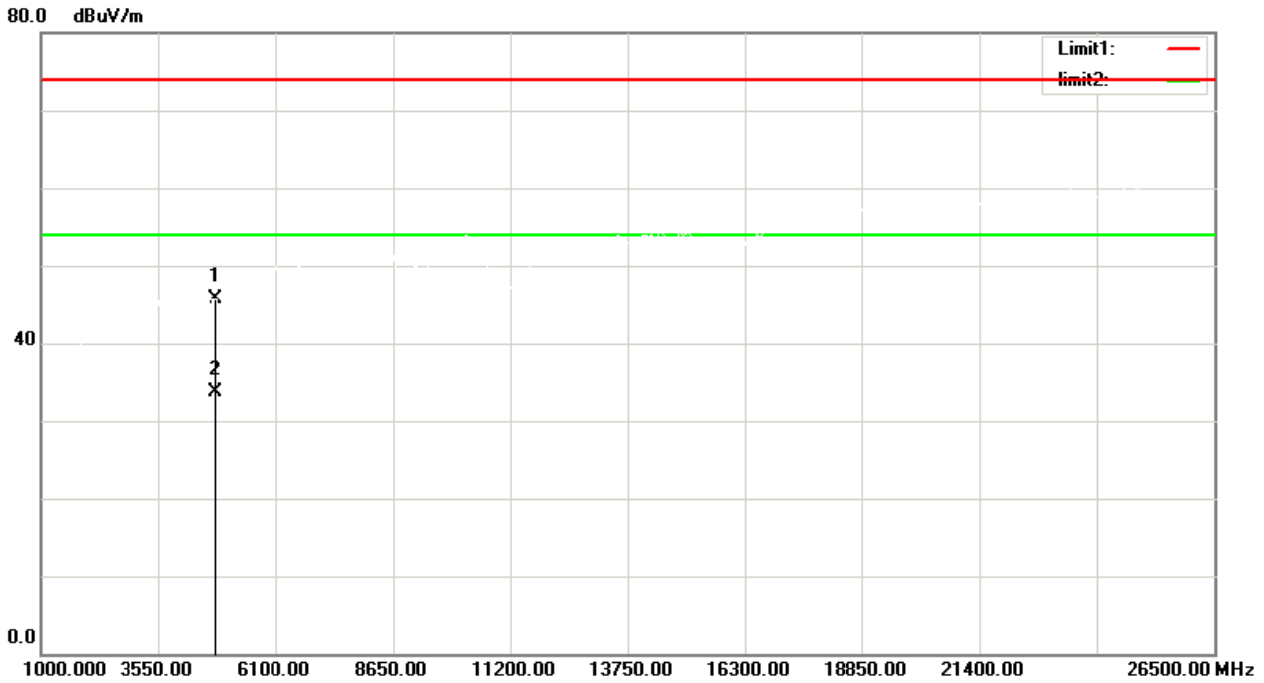

No.	Frequency (MHz)	Reading (dBuV/m)	Correct Factor(dB/m)	Result (dBuV/m)	Limit (dBuV/m)	Margin (dB)	Remark
1	4804.000	53.76	-8.01	45.75	74.00	-28.25	peak
2	4804.000	41.69	-8.01	33.68	54.00	-20.32	AVG

Test Mode: TX 2440 MHz_CH19_1Mbps

Vertical

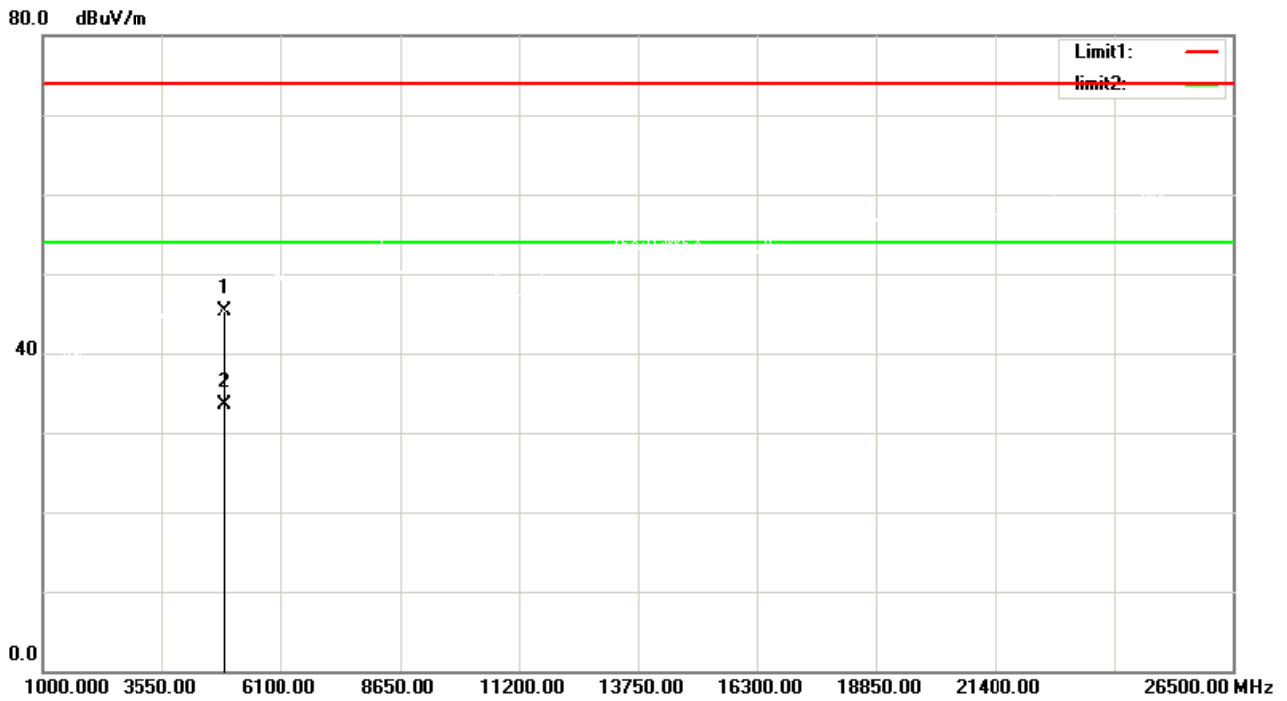

No.	Frequency (MHz)	Reading (dBuV/m)	Correct Factor(dB/m)	Result (dBuV/m)	Limit (dBuV/m)	Margin (dB)	Remark
1	4880.000	53.22	-7.84	45.38	74.00	-28.62	peak
2	4880.000	41.42	-7.84	33.58	54.00	-20.42	AVG

Test Mode: TX 2440 MHz_CH19_1Mbps

Horizontal

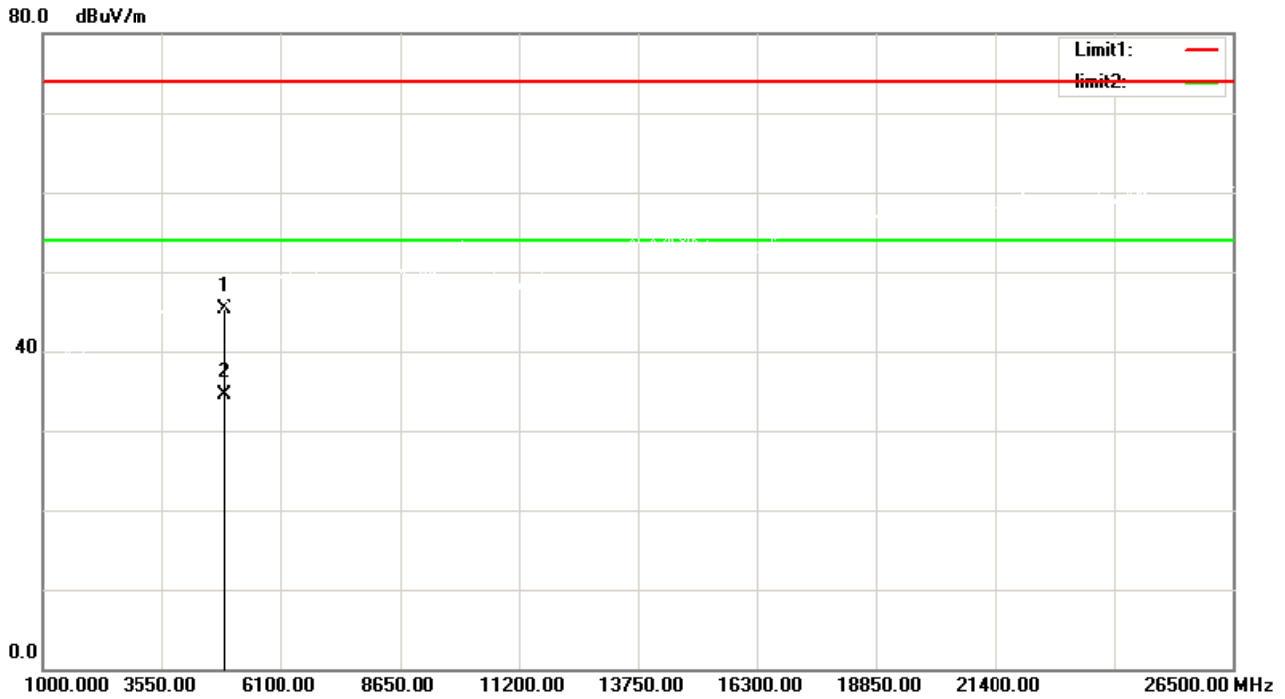

No.	Frequency (MHz)	Reading (dBuV/m)	Correct Factor(dB/m)	Result (dBuV/m)	Limit (dBuV/m)	Margin (dB)	Remark
1	4880.000	53.15	-7.84	45.31	74.00	-28.69	peak
2	4880.000	42.36	-7.84	34.52	54.00	-19.48	AVG

Test Mode: TX 2480 MHz_CH39_1Mbps

Vertical

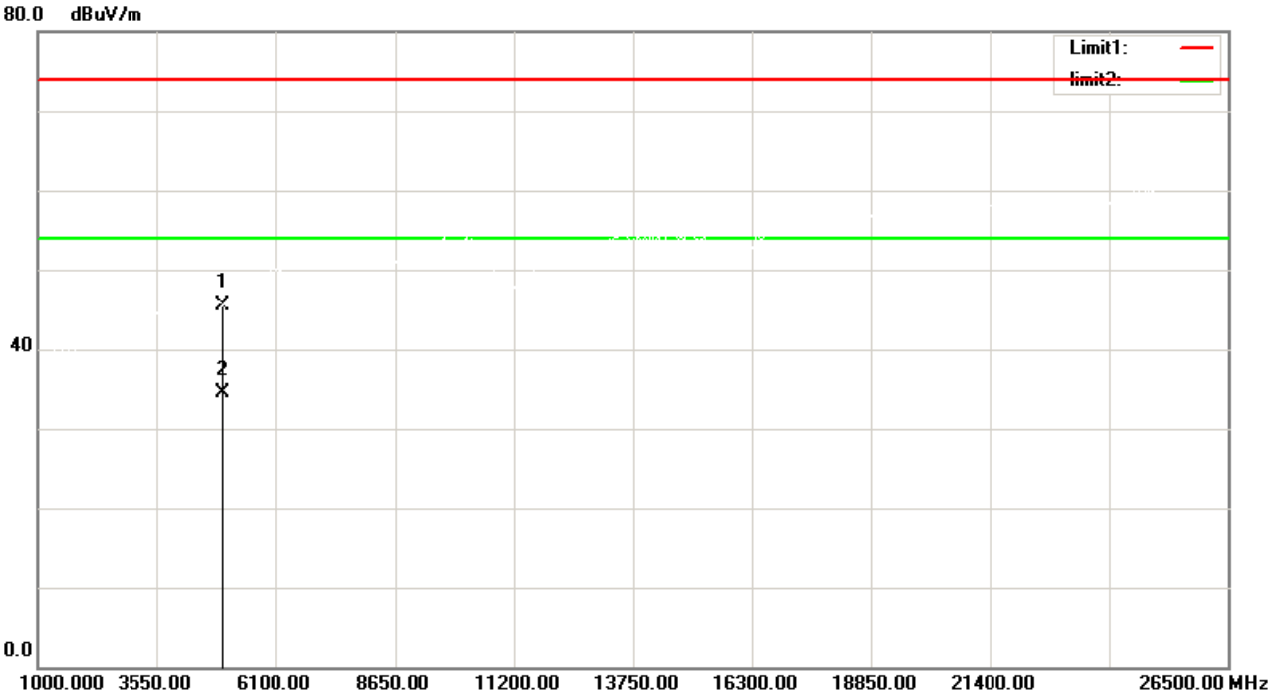

No.	Frequency (MHz)	Reading (dBuV/m)	Correct Factor(dB/m)	Result (dBuV/m)	Limit (dBuV/m)	Margin (dB)	Remark
1	4960.000	53.21	-7.67	45.54	74.00	-28.46	peak
2	4960.000	42.19	-7.67	34.52	54.00	-19.48	AVG

Test Mode: TX 2480 MHz_CH39_1Mbps

Horizontal

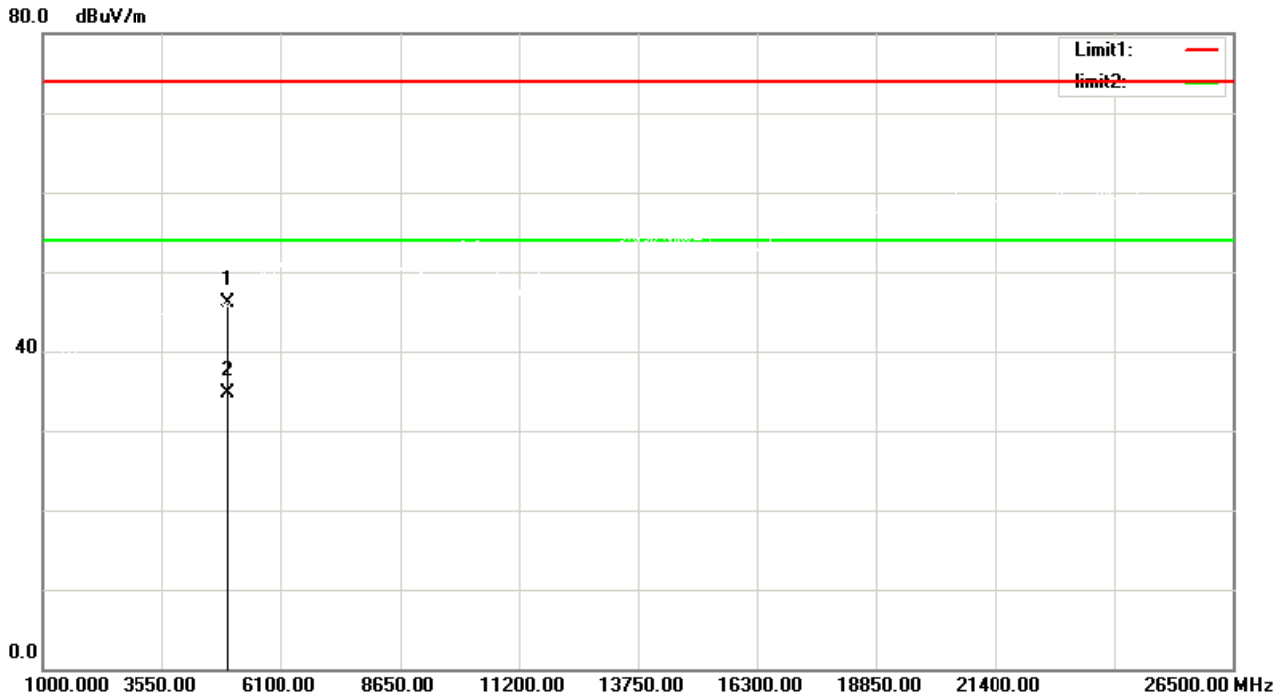

No.	Frequency (MHz)	Reading (dBuV/m)	Correct Factor(dB/m)	Result (dBuV/m)	Limit (dBuV/m)	Margin (dB)	Remark
1	4960.000	53.76	-7.67	46.09	74.00	-27.91	peak
2	4960.000	42.39	-7.67	34.72	54.00	-19.28	AVG

Test Mode: TX 2402 MHz_CH00_2Mbps

Vertical

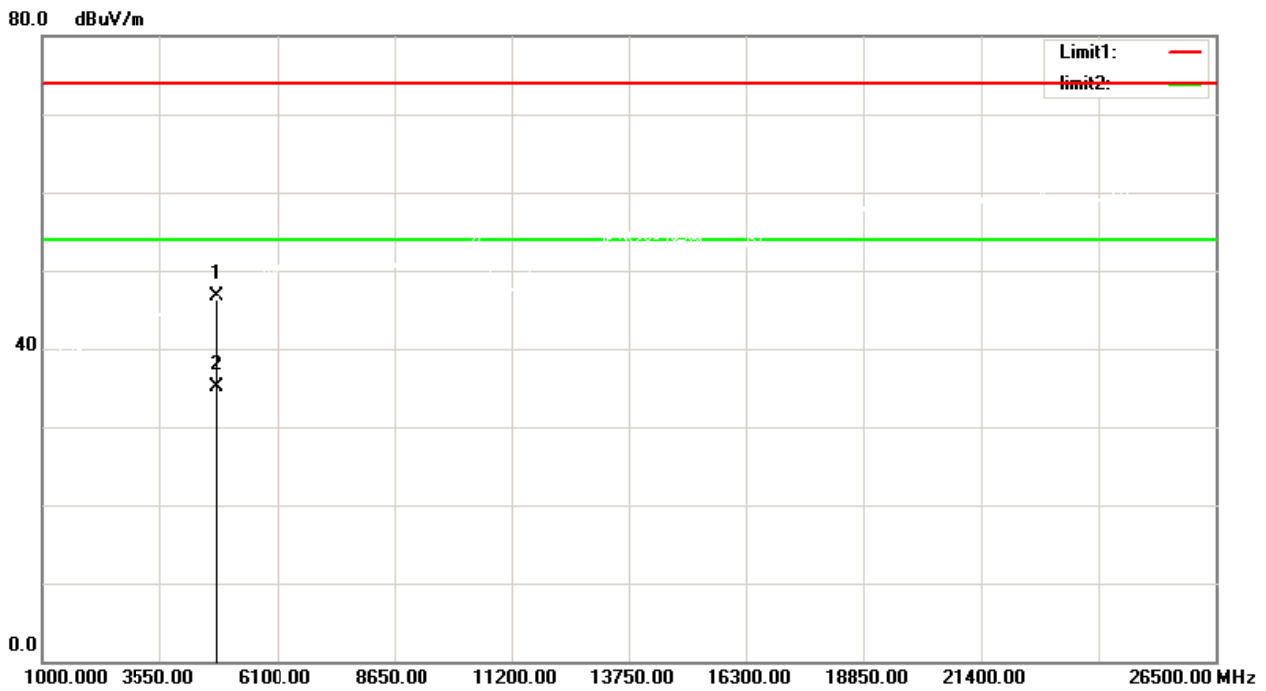

No.	Frequency (MHz)	Reading (dBuV/m)	Correct Factor(dB/m)	Result (dBuV/m)	Limit (dBuV/m)	Margin (dB)	Remark
1	4804.000	54.77	-8.01	46.76	74.00	-27.24	peak
2	4804.000	43.20	-8.01	35.19	54.00	-18.81	AVG

Test Mode: TX 2402 MHz_CH00_2Mbps

Horizontal

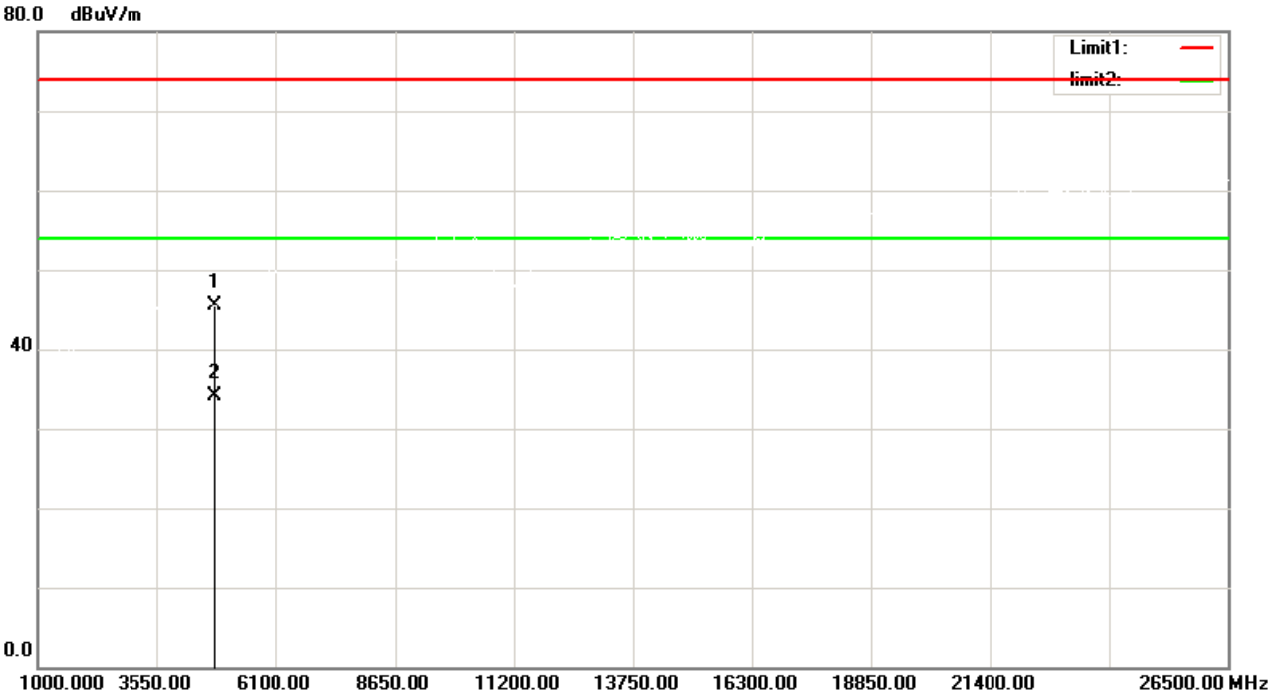

No.	Frequency (MHz)	Reading (dBuV/m)	Correct Factor(dB/m)	Result (dBuV/m)	Limit (dBuV/m)	Margin (dB)	Remark
1	4804.000	53.54	-8.01	45.53	74.00	-28.47	peak
2	4804.000	42.17	-8.01	34.16	54.00	-19.84	AVG

Test Mode: TX 2440 MHz_CH19_2Mbps

Vertical

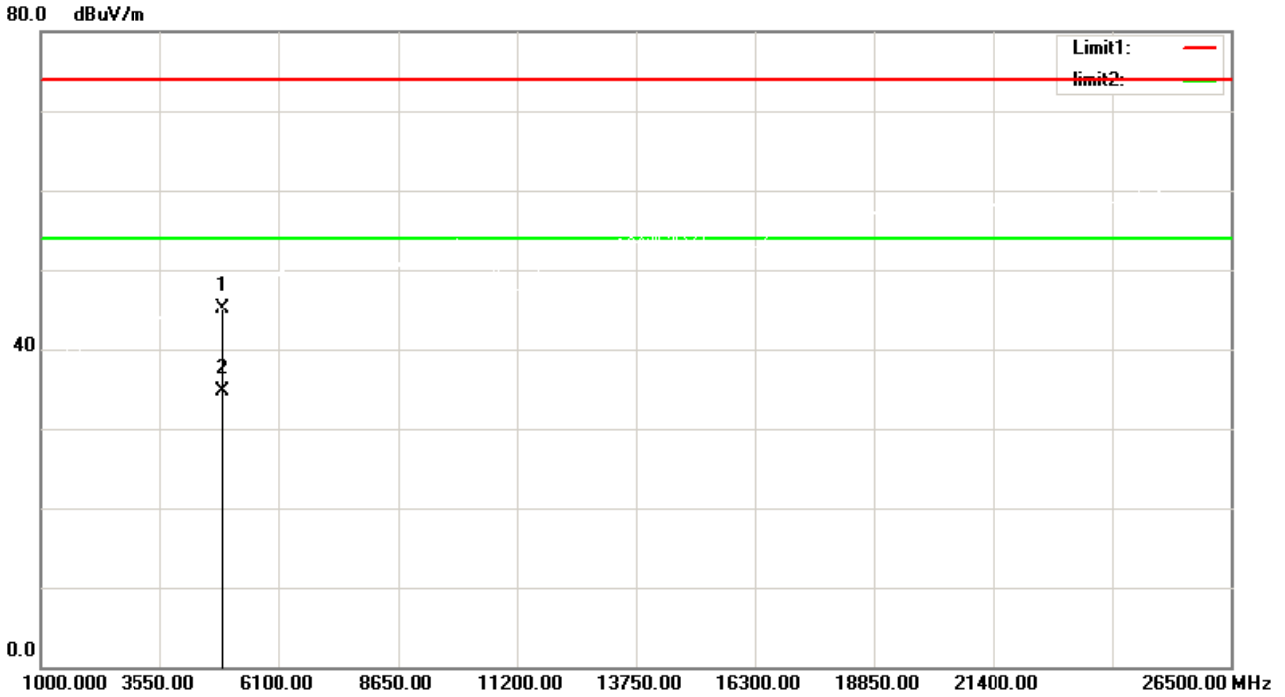

No.	Frequency (MHz)	Reading (dBuV/m)	Correct Factor(dB/m)	Result (dBuV/m)	Limit (dBuV/m)	Margin (dB)	Remark
1	4880.000	53.04	-7.84	45.20	74.00	-28.80	peak
2	4880.000	42.52	-7.84	34.68	54.00	-19.32	AVG

Test Mode: TX 2440 MHz_CH19_2Mbps

Horizontal

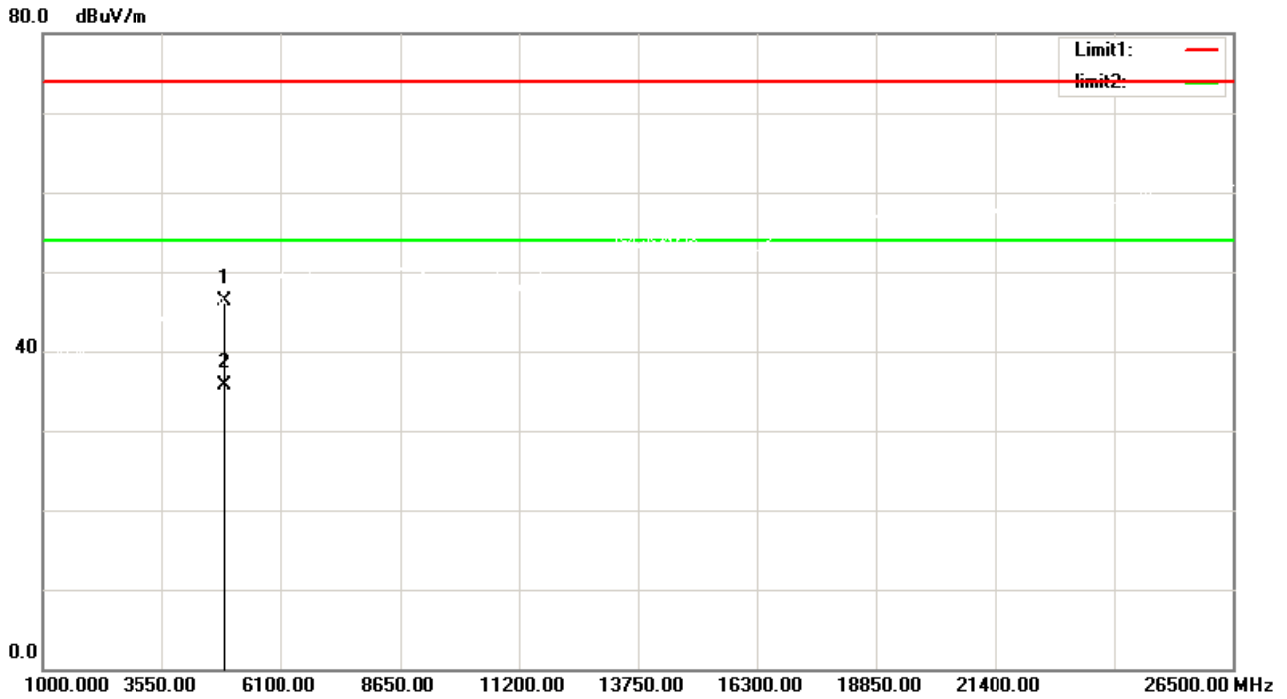

No.	Frequency (MHz)	Reading (dBuV/m)	Correct Factor(dB/m)	Result (dBuV/m)	Limit (dBuV/m)	Margin (dB)	Remark
1	4880.000	54.06	-7.84	46.22	74.00	-27.78	peak
2	4880.000	43.58	-7.84	35.74	54.00	-18.26	AVG

Test Mode: TX 2480 MHz_CH39_2Mbps

Vertical

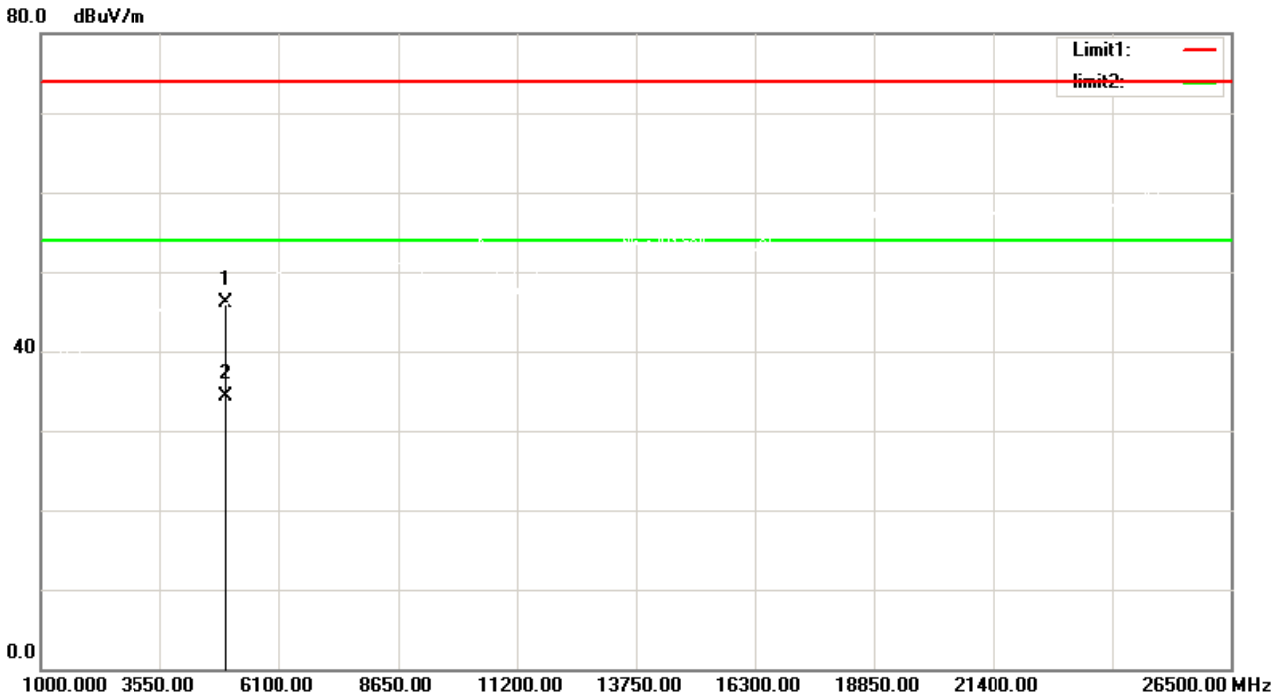

No.	Frequency (MHz)	Reading (dBuV/m)	Correct Factor(dB/m)	Result (dBuV/m)	Limit (dBuV/m)	Margin (dB)	Remark
1	4960.000	53.78	-7.67	46.11	74.00	-27.89	peak
2	4960.000	41.94	-7.67	34.27	54.00	-19.73	AVG

Test Mode: TX 2480 MHz_CH39_2Mbps

Horizontal

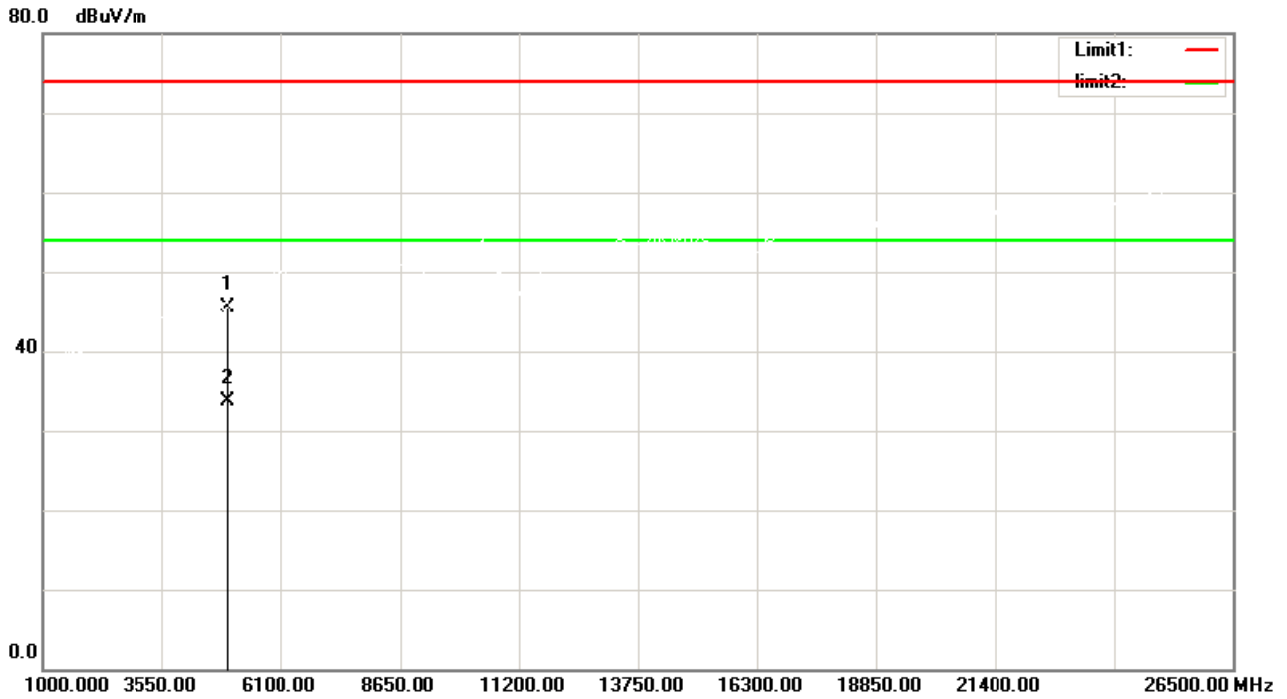

No.	Frequency (MHz)	Reading (dBuV/m)	Correct Factor(dB/m)	Result (dBuV/m)	Limit (dBuV/m)	Margin (dB)	Remark
1	4960.000	53.15	-7.67	45.48	74.00	-28.52	peak
2	4960.000	41.35	-7.67	33.68	54.00	-20.32	AVG

6BANDWIDTH TEST

6.1LIMIT

FCC Part15, Subpart C (15.247)		
Section	Test Item	Limit
15.247(a)(2)	Bandwidth	>= 500 kHz (6dB bandwidth)

6.2TEST PROCEDURE AND SETTING

- a. The EUT was directly connected to the spectrum analyzer and antenna output port as show in the block diagram below.
- b. Spectrum Setting:
 For 6dB Bandwidth RBW= 100 kHz, VBW=300 kHz, Sweep time =Auto.
 For 99% Bandwidth RBW=30kHz, VBW=100kHz, Sweep time =Auto for 1Mbps.
 RBW=100kHz, VBW=300kHz, Sweep time =Auto for 2Mbps.

6.3MEASUREMENT INSTRUMENTS LIST

Item	Kind of Equipment	Manufacturer	Type No.	Serial No.	Calibrated until
1	Spectrum analyzer	KEYSIGHT	N9010A	MY55150427	2023/05/26
2	Attenuator	Mini-Circuits	BW-S10W2	101109	N/A
3	RF Cable	Mi-cable	C10-01-01-1	100309	N/A

6.4TEST SETUP

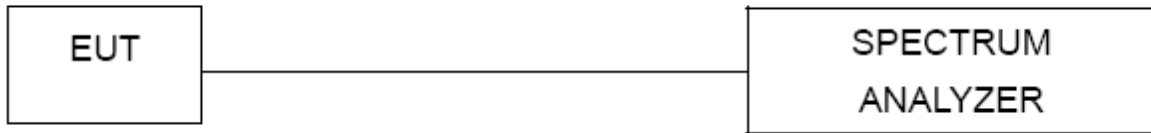

6.5EUT OPERATION CONDITIONS

The EUT tested system was configured as the statements of 4.5 unless otherwise a special operating condition is specified in the follows during the testing.

6.6 TEST RESULTS

TX Mode_1Mbps				
Channel	Frequency (MHz)	6 dB bandwidth (MHz)	99%OBW (MHz)	Result
CH00	2402	0.8571	1.0403	PASS
CH19	2440	0.9168	1.3525	PASS
CH39	2480	0.6864	1.2602	PASS

6dB

2402MHz

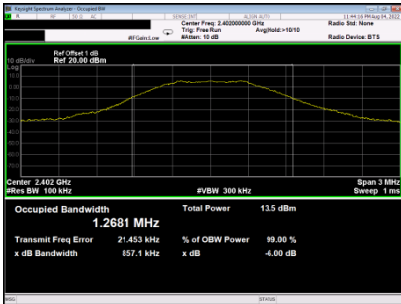

2440MHz

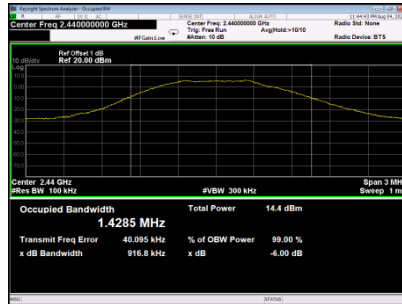

2480MHz

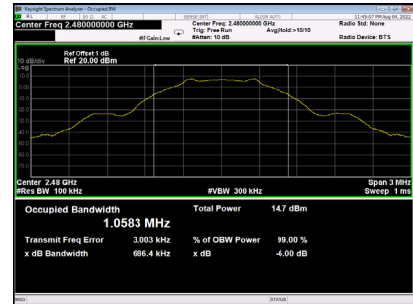

99%

2402MHz

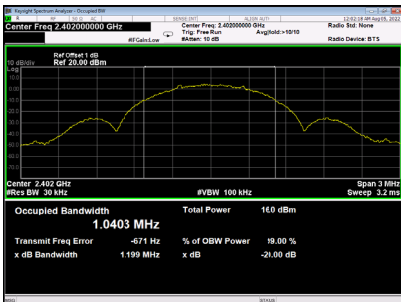

2440MHz

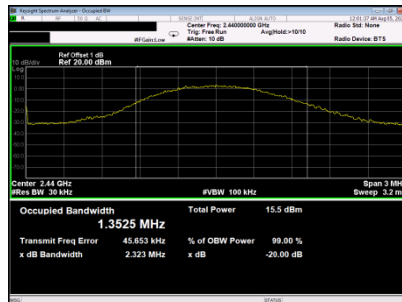

2480MHz

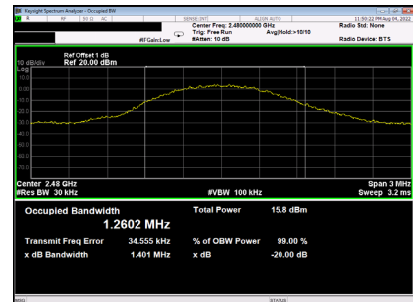

TX Mode_2Mbps				
Channel	Frequency (MHz)	6 dB bandwidth (MHz)	99%OBW (MHz)	Result
CH00	2402	1.372	2.0972	PASS
CH19	2440	1.639	2.2186	PASS
CH39	2480	1.533	2.0852	PASS

6dB

2402MHz

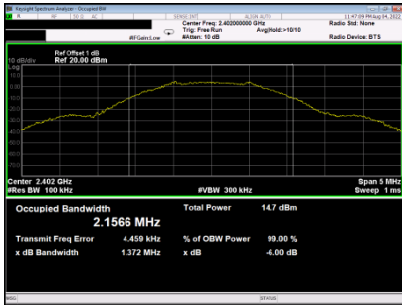

2440MHz

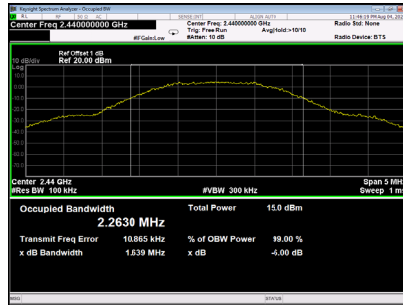

2480MHz

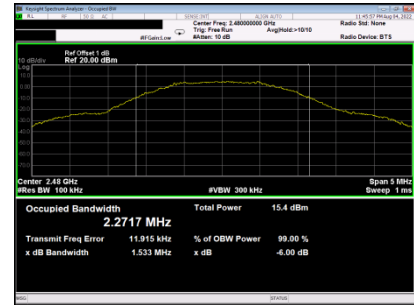

99%

2402MHz

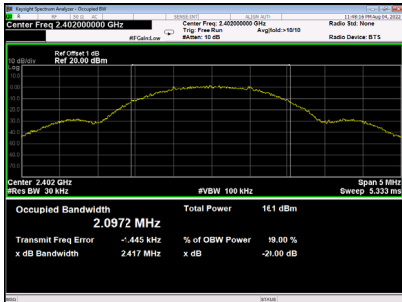

2440MHz

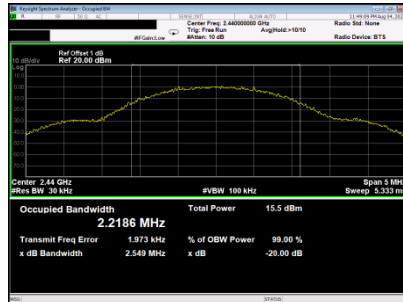

2480MHz

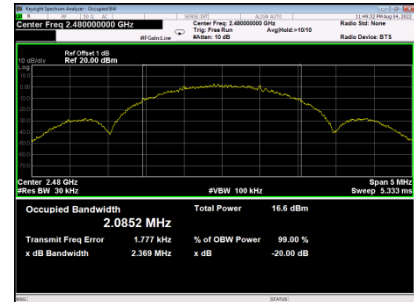

7 MAXIMUM OUTPUT POWER

7.1 LIMIT

FCC Part15, Subpart C (15.247)		
Section	Test Item	Limit
15.247(b)(3)	Maximum Output Power	1 watt or 30dBm

7.2 TEST PROCEDURE

- a. The EUT was directly connected to the spectrum analyzer and antenna output port as show in the block diagram below.
- b. The maximum conducted output power was performed in accordance with method 11.9.1.3(for peak power)ofANSI C63.10-2013.

7.3 MEASUREMENT INSTRUMENTS LIST

Item	Kind of Equipment	Manufacturer	Type No.	Serial No.	Calibrated until
1	Spectrum analyzer	KEYSIGHT	N9010A	MY55150427	2023/05/26
2	Attenuator	Mini-Circuits	BW-S10W2	101109	N/A
3	RF Cable	Mi-cable	C10-01-01-1	100309	N/A

7.4 TEST SETUP



7.5 EUT OPERATION CONDITIONS

The EUT tested system was configured as the statements of 4.5 unless otherwise a special operating condition is specified in the follows during the testing.

7.6 TEST RESULTS

TX Mode_1Mbps				
Channel	Frequency (MHz)	Output Power (dBm)	Output Power (W)	Result
CH00	2402	3.406	0.002191	PASS
CH19	2440	4.015	0.002521	PASS
CH39	2480	4.079	0.002558	PASS
Limit	30dBm / 1W			

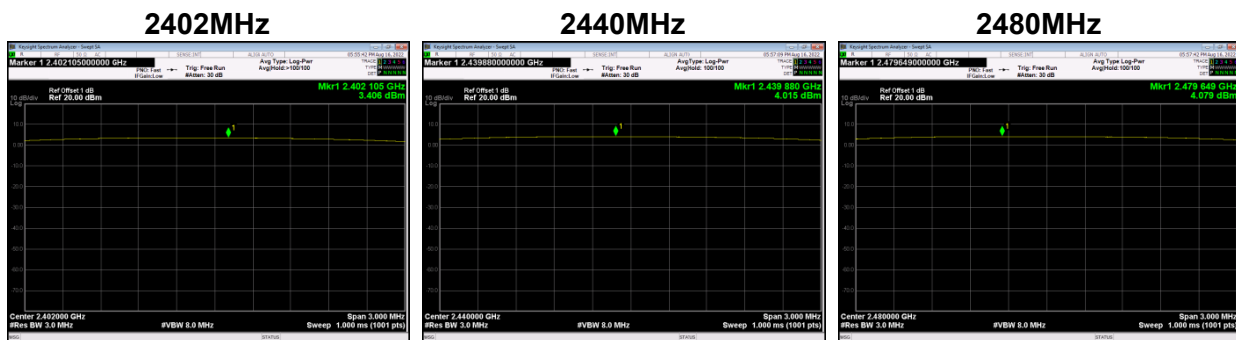

TX Mode_2Mbps				
Channel	Frequency (MHz)	Output Power (dBm)	Output Power (W)	Result
CH00	2402	3.411	0.002193	PASS
CH19	2440	4.021	0.002524	PASS
CH39	2480	4.089	0.002564	PASS
Limit	30dBm / 1W			

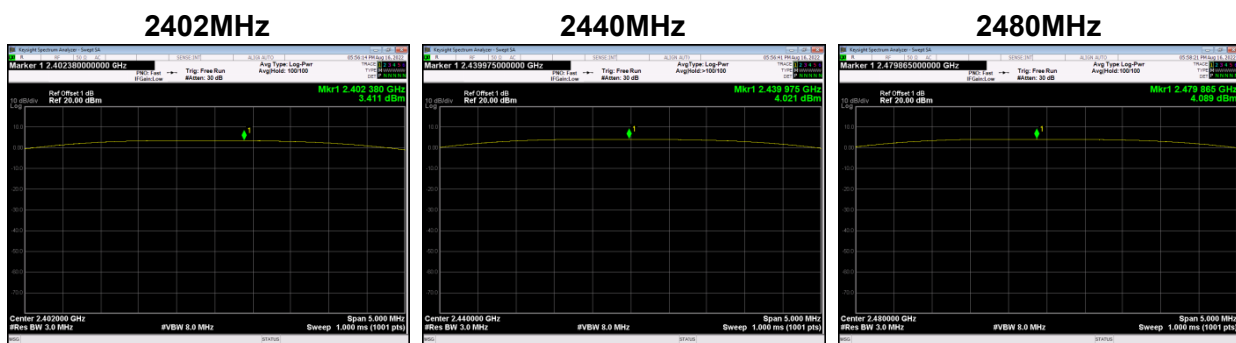

8 CONDUCTED SPURIOUS EMISSION

8.1 LIMIT

For FCC

In any 100 kHz bandwidth outside the frequency band in which the spread spectrum or digitally modulated intentional radiator is operating, the radio frequency power that is produced by the intentional radiator shall be at least 20 dB below that in the 100 kHz bandwidth within the band that contains the highest level of the desired power, based on either an RF conducted or a radiated measurement, provided the transmitter demonstrates compliance with the peak Output Power limits. If the transmitter complies with the Output Power limits based on the use of RMS averaging over a time interval, as permitted under paragraph (b)(3) of this section, the attenuation required under this paragraph shall be 30 dB instead of 20 dB. Attenuation below the general limits specified in Section 15.209(a) is not required.

For ISED

In any 100 kHz bandwidth outside the frequency band in which the spread spectrum or digitally modulated device is operating, the RF power that is produced shall be at least 20 dB below that in the 100 kHz bandwidth within the band that contains the highest level of the desired power, based on either an RF conducted or a radiated measurement, provided that the transmitter demonstrates compliance with the peak Output Power limits. If the transmitter complies with the Output Power limits based on the use of root-mean-square averaging over a time interval, as permitted under section 5.4(d), the attenuation required shall be 30 dB instead of 20 dB. Attenuation below the general field strength limits specified in RSS-Gen is not required.

8.2 TEST PROCEDURE

- a. The EUT was directly connected to the spectrum analyzer and antenna output port as show in the block diagram below.
- b. Spectrum Setting : RBW= 100 kHz, VBW=300 kHz, Sweep time = Auto.

8.3 MEASUREMENT INSTRUMENTS LIST

Item	Kind of Equipment	Manufacturer	Type No.	Serial No.	Calibrated until
1	Spectrum analyzer	KEYSIGHT	N9010A	MY55150427	2023/05/26
2	Attenuator	Mini-Circuits	BW-S10W2	101109	N/A
3	RF Cable	Mi-cable	C10-01-01-1	100309	N/A

8.4 TEST SETUP



8.5 EUT OPERATION CONDITIONS

The EUT tested system was configured as the statements of 4.5 unless otherwise a special operating condition is specified in the follows during the testing.

8.6 TEST RESULTS

TX Mode_1Mbps

Bandedge- CH00 (Lower)

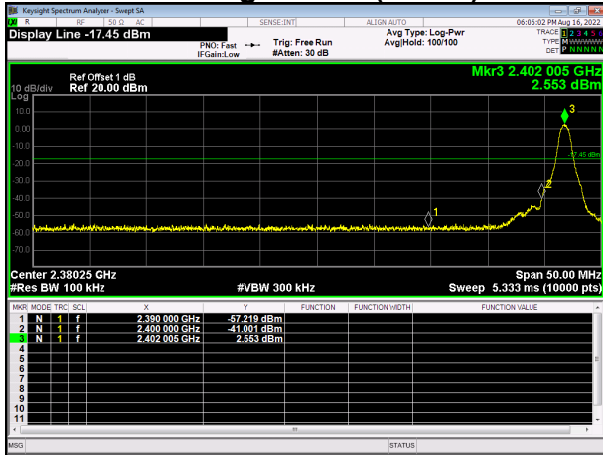

Bandedge CH39 (Upper)

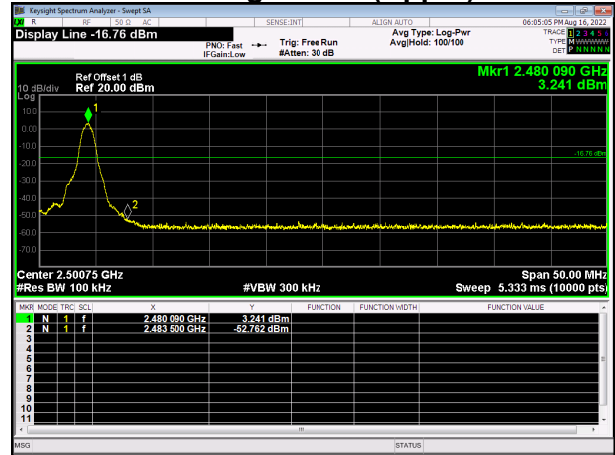

CH00 – 10th Harmonic of the fundamental frequency

2402MHz

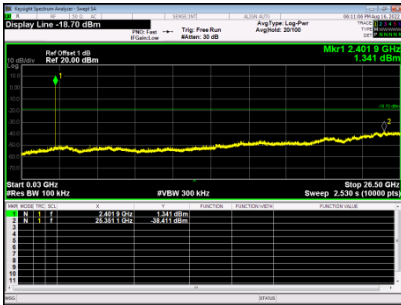

2440MHz

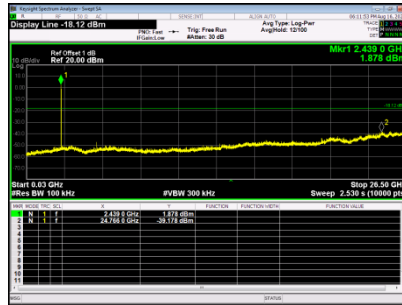

2480MHz

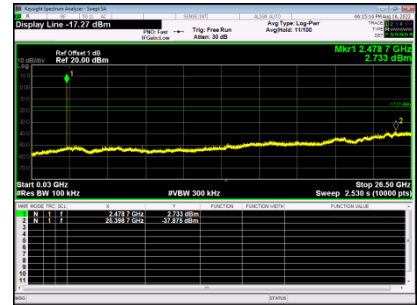

TX Mode_2Mbps

Bandedge- CH00 (Lower)

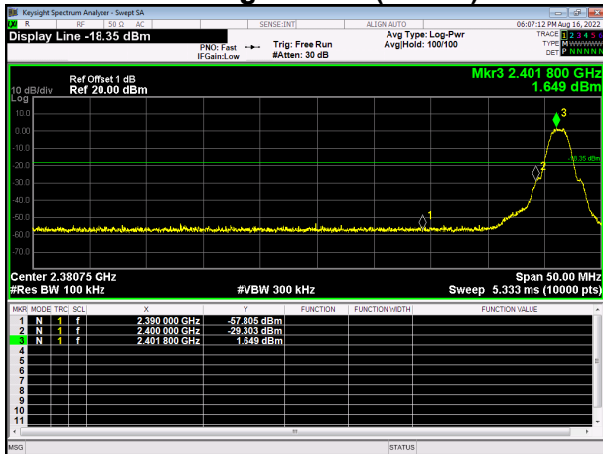

Bandedge CH39 (Upper)

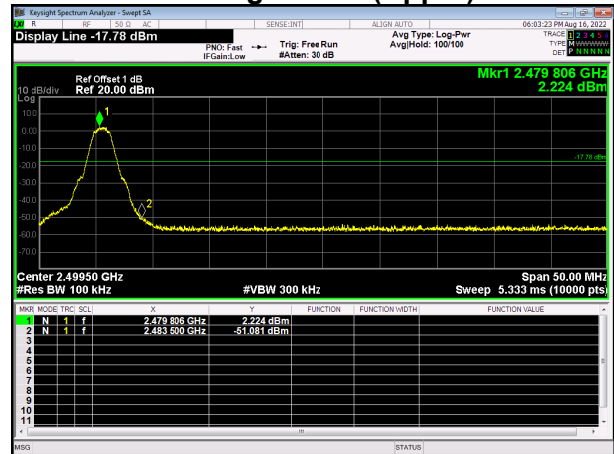

CH00 – 10th Harmonic of the fundamental frequency

2402MHz

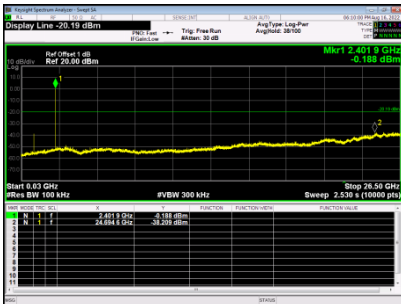

2440MHz

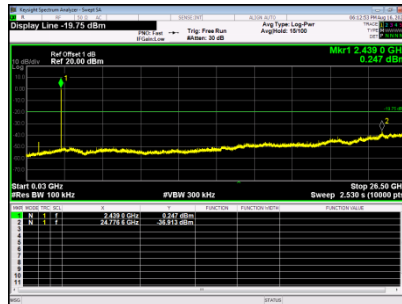

2480MHz

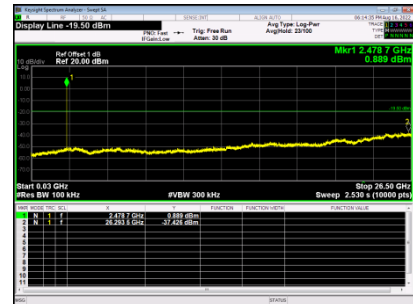

9 POWER SPECTRAL DENSITY TEST

9.1 LIMIT

FCC Part15, Subpart C (15.247)		
Section	Test Item	Limit
15.247(e)	Power Spectral Density	8 dBm (in any 3 kHz)

9.2 TEST PROCEDURE

- a. The EUT was directly connected to the spectrum analyzer and antenna output port as show in the block diagram below.
- b. Spectrum Setting: RBW=3 kHz, VBW=10kHz, Sweep time = auto.

9.3 MEASUREMENT INSTRUMENTS LIST

Item	Kind of Equipment	Manufacturer	Type No.	Serial No.	Calibrated until
1	Spectrum analyzer	KEYSIGHT	N9010A	MY55150427	2023/05/26
2	Attenuator	Mini-Circuits	BW-S10W2	101109	N/A
3	RF Cable	Mi-cable	C10-01-01-1	100309	N/A

9.4 TEST SETUP



9.5 EUT OPERATION CONDITIONS

The EUT tested system was configured as the statements of 3.5 unless otherwise a special operating condition is specified in the follows during the testing.

9.6 TEST RESULTS

TX Mode_1Mbps				
Channel	Frequency (MHz)	Power SpectralDensity (dBm/3 kHz)	Limit: <dBm/3KHz	Result
CH00	2402	-5.314	8	PASS
CH19	2440	-5.117	8	PASS
CH39	2480	-3.389	8	PASS

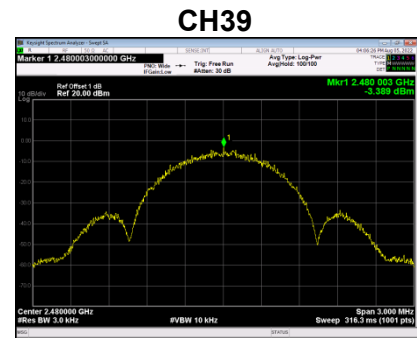
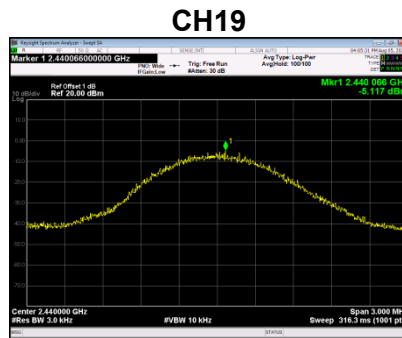
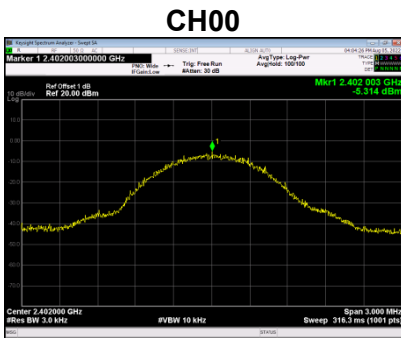

TX Mode_2Mbps				
Channel	Frequency (MHz)	Power SpectralDensity (dBm/3 kHz)	Limit: <dBm/3KHz	Result
CH00	2402	-7.351	8	PASS
CH19	2440	-8.421	8	PASS
CH39	2480	-7.855	8	PASS

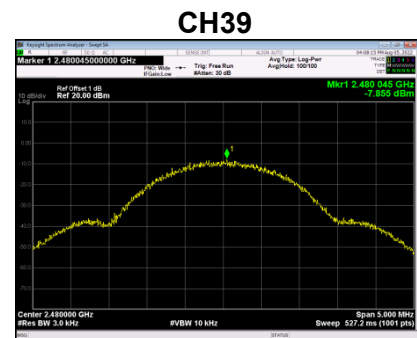
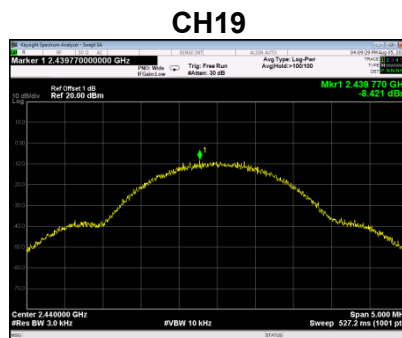
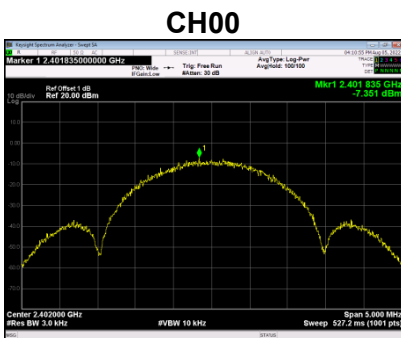

END OF TEST REPORT