

2.4 GHz - Wi-Fi/BT/BLE Stamped Metal Antenna



PRO-OB-440

Request Samples



Check Inventory



13.75 x 5.23 x 3.53 mm
RoHS/RoHS II Compliant
MSL Level = 1

Features

- Compact
- Low loss material
- Highly efficient ($\eta > 65\%$)
- High Gain of 4.9 dBi
- Surface Mount Device

Applications

- 2.4 GHz - Wi-Fi/BT/BLE/ZigBee/ISM Applications
- IoT, M2M
 - Industrial IoT
 - Consumer IoT
 - Medical IoT
- Telemetry
- Wireless Remote Control
- Personal Area Networks (PAN)
- Industrial/Commercial Equipments

Product Image

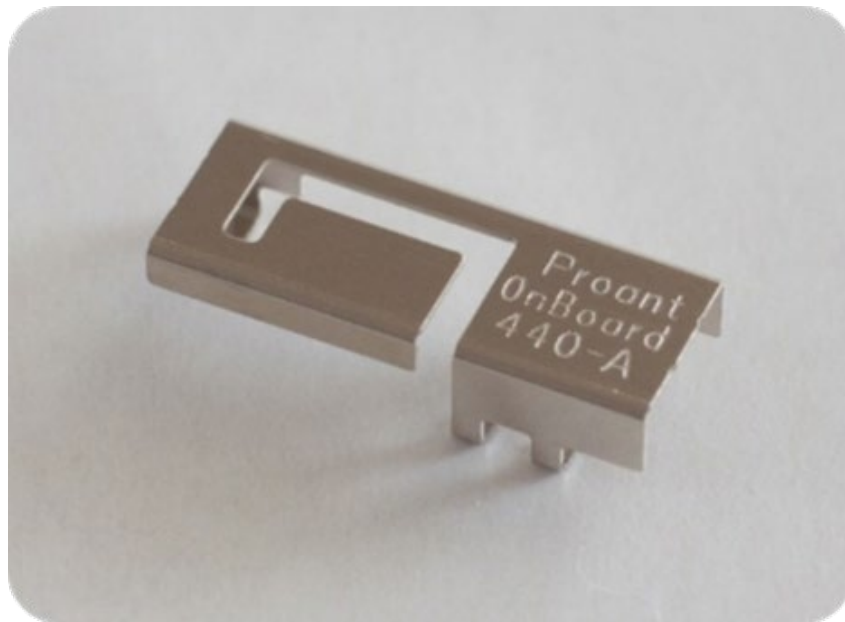

2.4 GHz - Wi-Fi/BT/BLE Stamped Metal Antenna

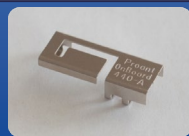

PRO-OB-440

Request Samples



Check Inventory



13.75 x 5.23 x 3.53 mm
RoHS/RoHS II Compliant
 MSL Level = 1

Electrical Specification

Parameter	Specification			Unit
	Min	Typ	Max	
Operating Frequency	2400		2500	MHz
Center Frequency		2450		
Return Loss			-6.9	dB
Polarization	Linear			
Peak Gain			4.9	dBi
Efficiency	65			%
Impedance		50		Ω

Note: All test measurements were conducted with the antenna on a 100 x 50 mm Evaluation board (PRO-EB-450). Please note that the performance is dependent on the ground plane dimensions, tuning components and application environment.

Mechanical Specification

Parameter	Specification
Antenna Dimension	13.75 x 5.23 x 3.53 mm
Evaluation board Dimension	100 x 50 mm
Mounting Type	Surface Mount

Environmental Specification

Parameter	Specification
Operating Temperature	-40 °C to +125 °C
Storage Temperature	
Maximum Temperature	400 °C
RoHS Compliance	Yes (Compliant with EU directive 2011/65/EU and 2015/863)
Shelf life	10 years
MSL	Level 1, unlimited
Mechanical resistance	Immunity to vibrations IEC/EN 60068-2-6, Fc test Immunity to shock IEC/EN 60068-2-27, Ea test



5101 Hidden Creek Ln Spicewood TX 78669
 Phone: 512-371-6159 | Fax: 512-351-8858
 For terms and conditions of sales, please visit:
www.abracon.com

REVISED: 07-19-21

ABRACON IS
 ISO9001-2015
 CERTIFIED

2.4 GHz - Wi-Fi/BT/BLE Stamped Metal Antenna



PRO-OB-440

Request Samples



Check Inventory



13.75 x 5.23 x 3.53 mm
RoHS/RoHS II Compliant
MSL Level = 1

Product Dimension

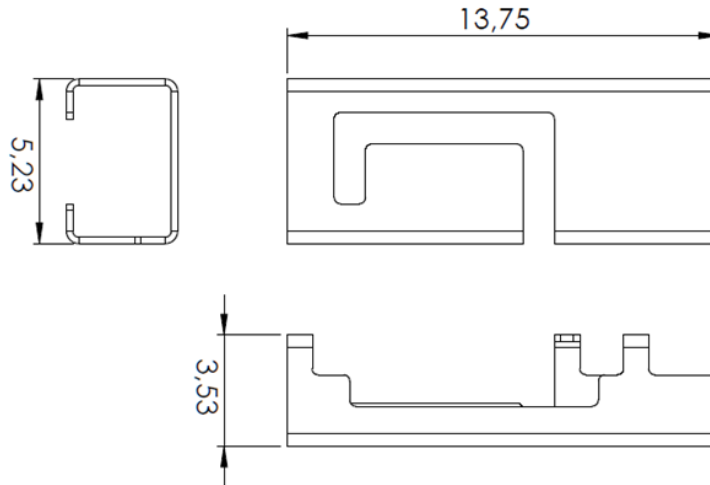

Unit : mm

Antenna pins and keep-out block

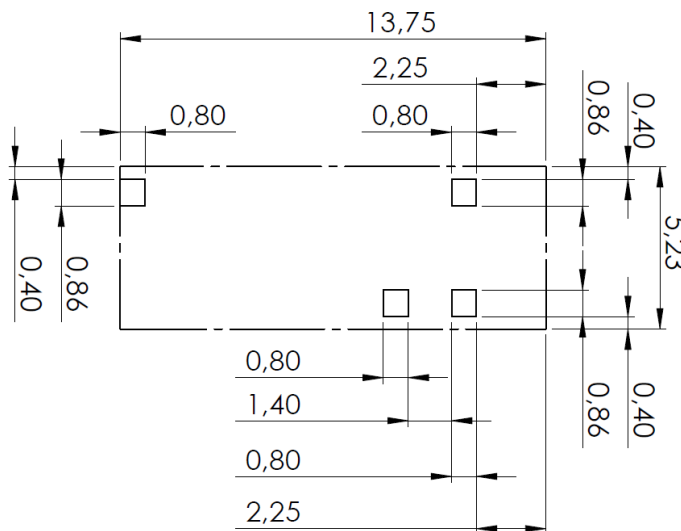

Unit : mm



5101 Hidden Creek Ln Spicewood TX 78669
Phone: 512-371-6159 | Fax: 512-351-8858
For terms and conditions of sales, please visit:
www.abracon.com

REVISED: 07-19-21

ABRACON IS
ISO9001-2015
CERTIFIED

2.4 GHz - Wi-Fi/BT/BLE Stamped Metal Antenna



PRO-OB-440

Request Samples



Check Inventory



13.75 x 5.23 x 3.53 mm
RoHS/RoHS II Compliant
MSL Level = 1

Measurement Setup

The antenna measurements were done with the OnBoard SMD 2400 evaluation board (PRO-EB-450, 100 x 50 mm) in free space.

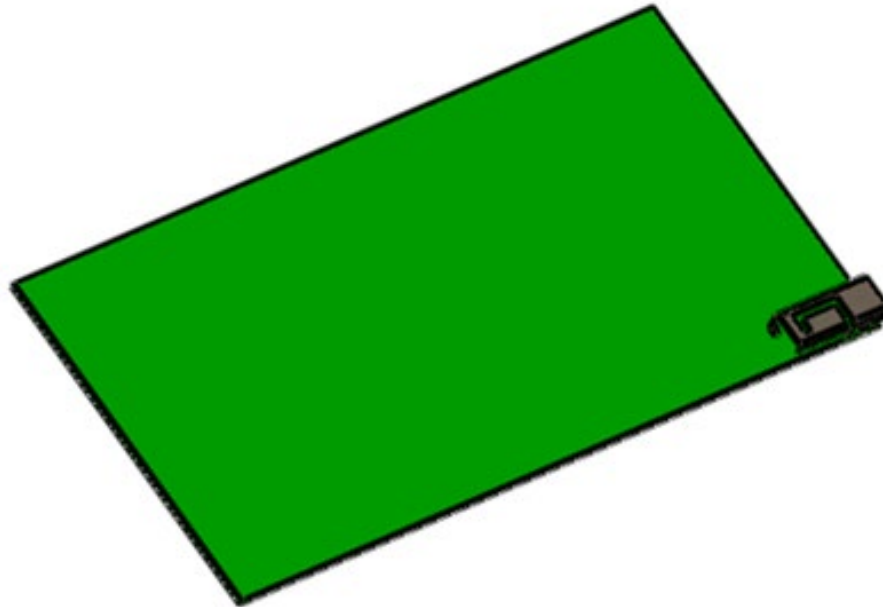

2.4 GHz - Wi-Fi/BT/BLE Stamped Metal Antenna



PRO-OB-440

Request Samples



Check Inventory



13.75 x 5.23 x 3.53 mm
RoHS/RoHS II Compliant
 MSL Level = 1

PCB Layout

The antenna is developed for optimum performance when mounted on a ground plane and is therefore very suitably mounted on a printed circuit board, where all empty space in the layout shall be filled solid copper. This also means that no ground cutout area is required under the antenna. If there are several layers in the PCB, there is an advantage to add via holes for interconnection of the ground areas. It is also very important that there is a ground clearance around the NC pads and the RF feed pad, through all layers of the PCB. Otherwise, there will be capacitive coupling which may detune the antenna.

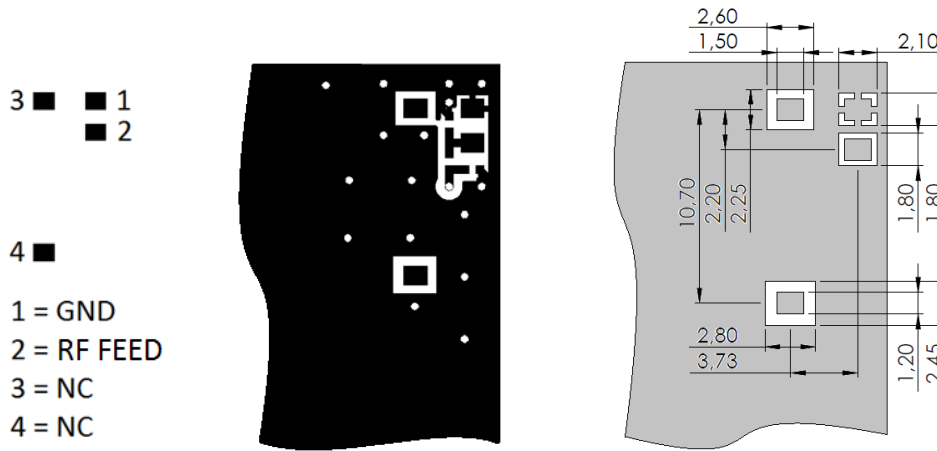

Pin configuration

PCB Layout (from evaluation board)

The antenna is preferably positioned along one side of the PCB ground plane, where pin 1 shall be as close as possible to the layout corner.

It is also recommended to implement a pi-matching network as seen in the PCB layout to compensate for eventual mismatch due to the practical implementation. The components can be positioned below the antenna next to the feed pad. See “Evaluation Board Outline & Matching Circuit” section for more details.

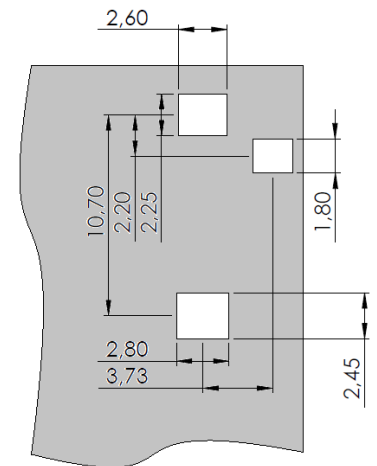

Clearance through all layers

Unit : mm

2.4 GHz - Wi-Fi/BT/BLE Stamped Metal Antenna



PRO-OB-440

Request Samples



Check Inventory



13.75 x 5.23 x 3.53 mm
RoHS/RoHS II Compliant
MSL Level = 1

Evaluation Board Outline & Matching Circuit

The evaluation board is developed to simplify antenna testing and evaluation. It has an arbitrary size of 100 x 50 mm and includes an SMA connector. The purpose is to give a reference design for an optimal antenna implementation. The evaluation board can also be used to test other implementations by cutting and soldering the PCB into any device.



Evaluation board outline

The evaluation board has a matching circuit implemented next to the antenna. This is aimed to enable optimization possibilities for the user. The component positions are sized for 0402 (1005 metric) SMD components.

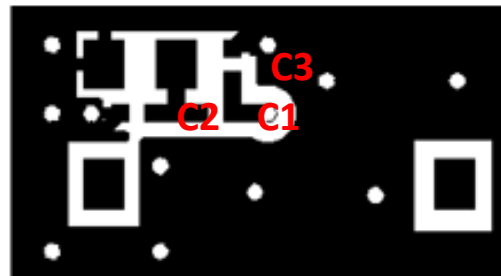
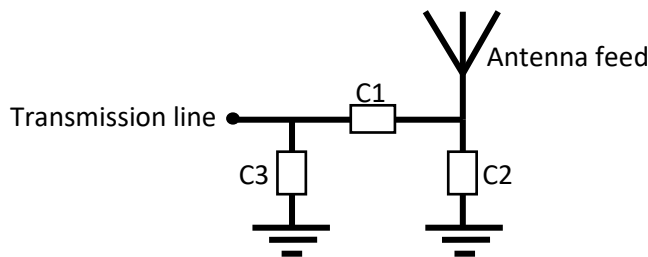

Matching circuit

The antenna needs a matching circuit to adjust the resonant frequency balance. When delivered, the evaluation board is tuned for optimum balance at the 2.4 GHz band. The component values for this setup is $C1 = 1.5nH$, $C2 = 0.5pF$, $C3 = N/A$. However, it is common that the resonant frequency will shift during implementation in an arbitrary device. Therefore, this matching may be changed for compensation of such effects.

2.4 GHz - Wi-Fi/BT/BLE Stamped Metal Antenna

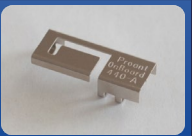

PRO-OB-440

Request Samples



Check Inventory



13.75 x 5.23 x 3.53 mm
RoHS/RoHS II Compliant
MSL Level = 1

Reflection Characteristics - Return Loss

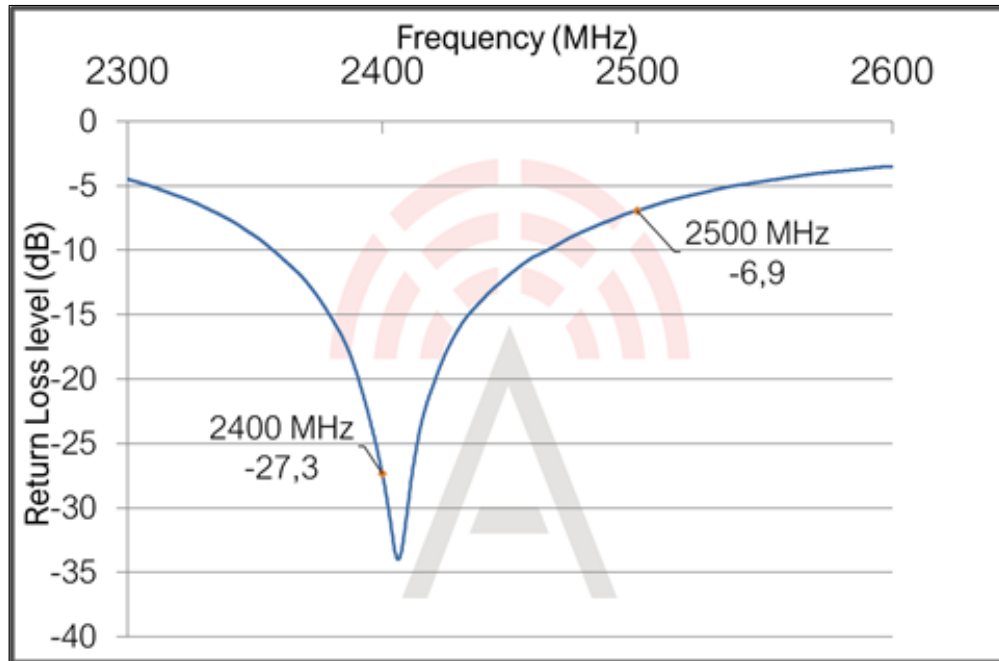

Total Radiation Efficiency

Maximum Radiation Gain

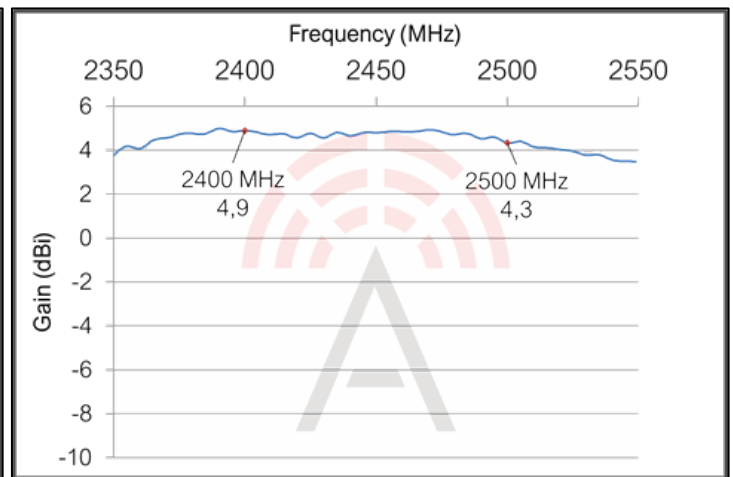
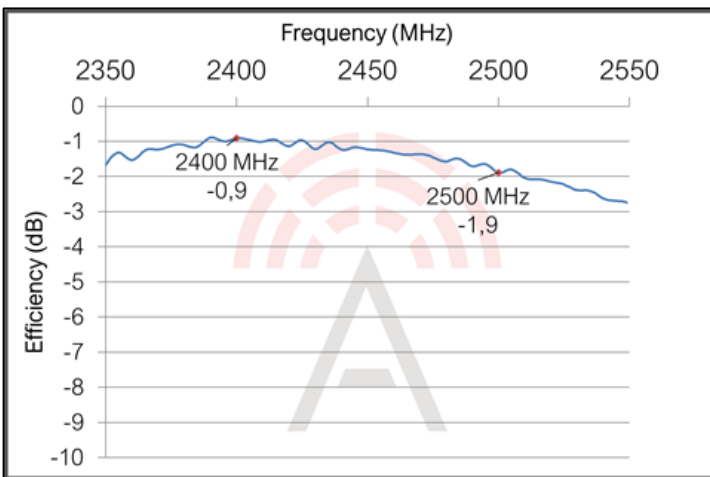

5101 Hidden Creek Ln Spicewood TX 78669
Phone: 512-371-6159 | Fax: 512-351-8858
For terms and conditions of sales, please visit:
www.abracon.com

REVISED: 07-19-21

ABRACON IS
ISO9001-2015
CERTIFIED

2.4 GHz - Wi-Fi/BT/BLE Stamped Metal Antenna

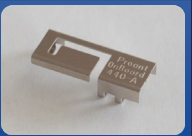

PRO-OB-440

Request Samples



Check Inventory



13.75 x 5.23 x 3.53 mm
RoHS/RoHS II Compliant
MSL Level = 1

Radiation Characteristics - 2D Pattern (2400 MHz)

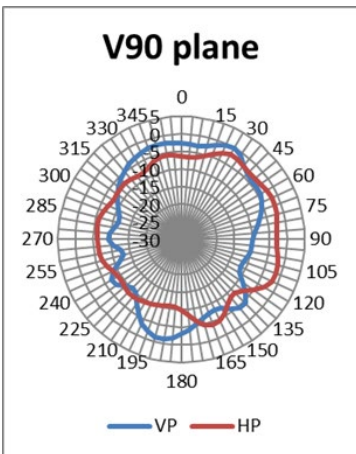
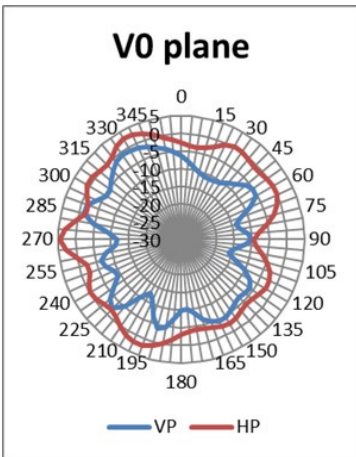
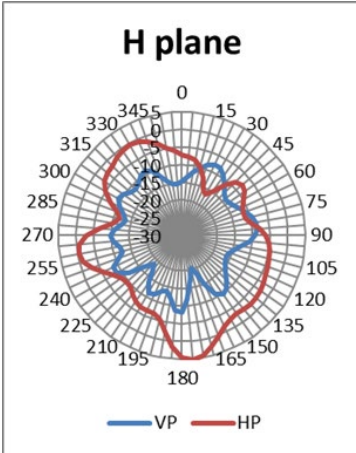

2.4 GHz - Wi-Fi/BT/BLE Stamped Metal Antenna



PRO-OB-440

Request Samples



Check Inventory



13.75 x 5.23 x 3.53 mm
RoHS/RoHS II Compliant
MSL Level = 1

Radiation Characteristics - 2D Pattern (2500 MHz)

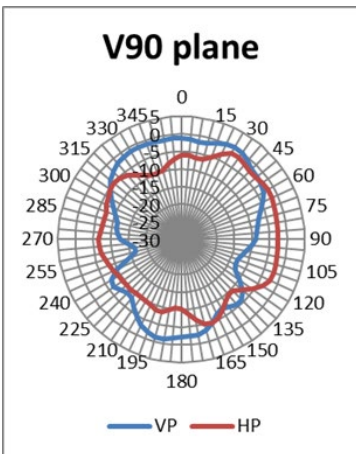
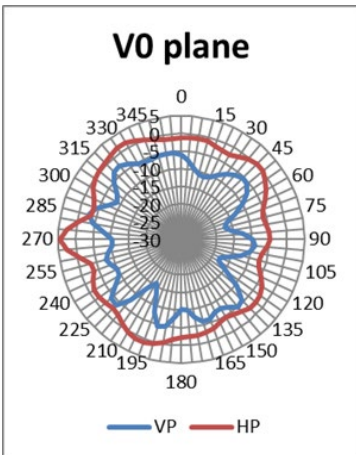
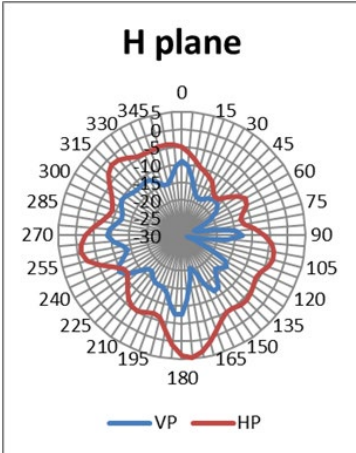

5101 Hidden Creek Ln Spicewood TX 78669
Phone: 512-371-6159 | Fax: 512-351-8858
For terms and conditions of sales, please visit:
www.abracon.com

REVISED: 07-19-21

ABRACON IS
ISO9001-2015
CERTIFIED

2.4 GHz - Wi-Fi/BT/BLE Stamped Metal Antenna

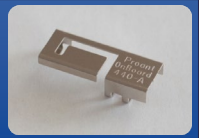

PRO-OB-440

Request Samples



Check Inventory



13.75 x 5.23 x 3.53 mm
RoHS/RoHS II Compliant
MSL Level = 1

Antenna Tuning & Impedance Matching

The antenna should have nominal tuning in most applications when $C1 = 0$ Ohm (measured with coaxial cable on the evaluation board). However, the user may like to elaborate with the tuning if the implementation causes a resonant frequency shift. This part shows two examples of how a simple frequency tuning can be implemented.

Tune 50 MHz down

$C1 = 2.7$ nH (Murata LQW15AN2N7G80D)
 $C2 = 0.75$ pF (Murata GJM1555C1HR75WB01)
 $C3 = \text{N/A}$

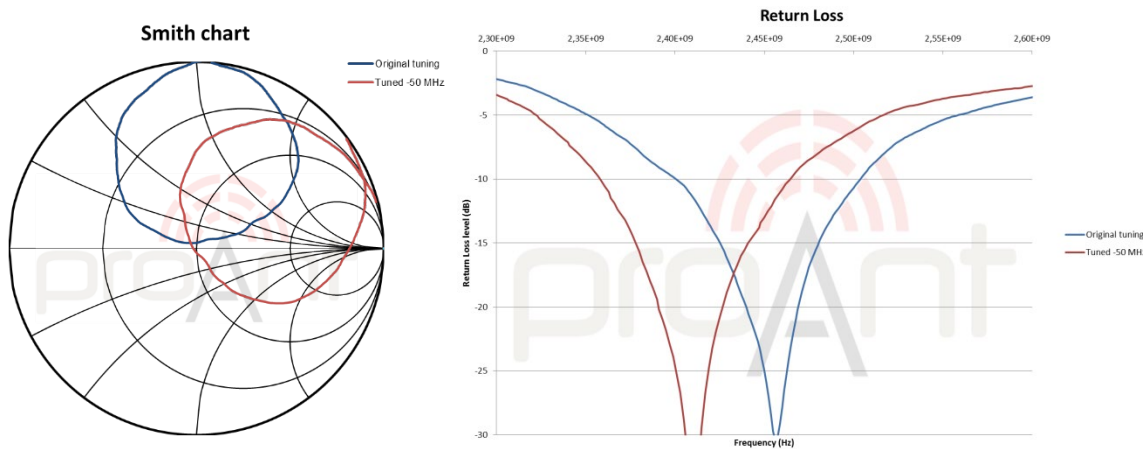

Tune 50 MHz up

$C1 = 1.0$ nH (Murata LQP15MN1N0W02)
 $C2 = \text{N/A}$
 $C3 = 1.0$ pF (Murata GJM1555C1H1R0WB01)

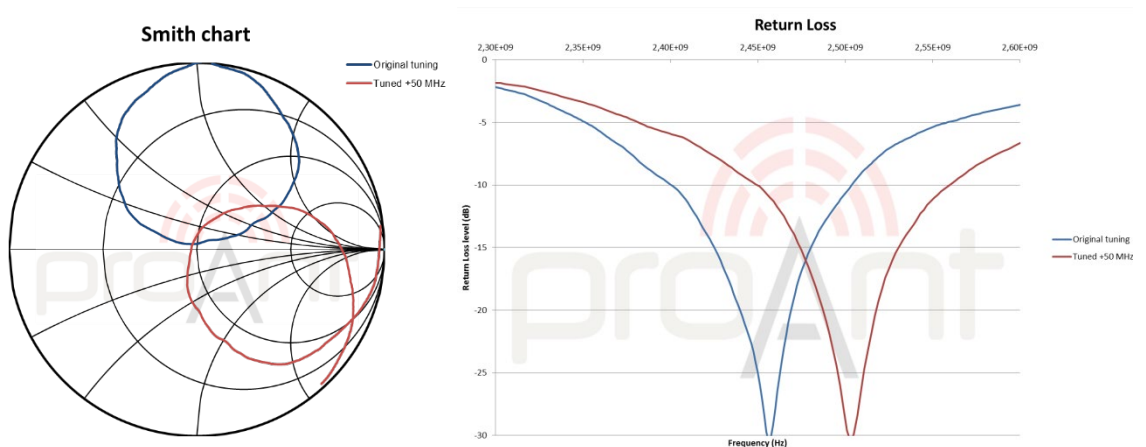

5101 Hidden Creek Ln Spicewood TX 78669
Phone: 512-371-6159 | Fax: 512-351-8858
For terms and conditions of sales, please visit:
www.abracon.com

REVISED: 07-19-21

ABRACON IS
ISO9001-2015
CERTIFIED

2.4 GHz - Wi-Fi/BT/BLE Stamped Metal Antenna

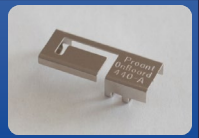

PRO-OB-440

Request Samples



Check Inventory



13.75 x 5.23 x 3.53 mm
RoHS/RoHS II Compliant
MSL Level = 1

General Implementation Guidelines

The antenna can be positioned in many ways, although there are some positions which are more beneficial. Below picture shows a typical PCB with six possible antenna positions. The positions have been arranged according to the best general fit.

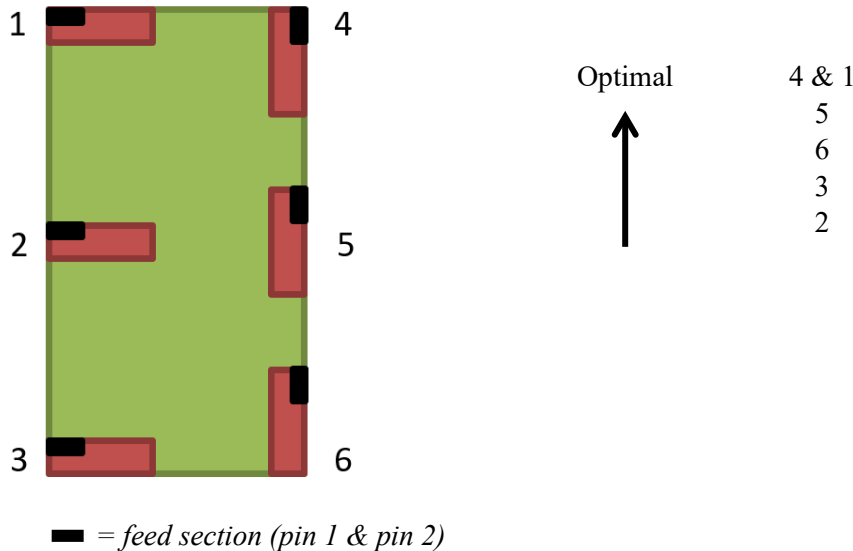

The antenna should be aligned with the PCB edge if possible. It is also important to align pin 1 & 2 along the outer side of the PCB, and even more preferably close to a corner. This fact makes position 2, 3 and 6 difficult to define, why these positions are less optimal.

The OnBoard SMD 2400 antenna enables that small electrical components are mounted inside the antenna keep-out block. This may have an impact on the antenna tuning and radiated performance but is fully possible if there is limited space on the PCB.

Another general aspect on surface mounted antennas is regarding the PCB population. If other electrical components are positioned in the surrounding area of the antenna, some impact on the antenna tuning and radiated performance may be expected. It is recommended that such components are distributed below a topographical slope that starts on PCB level at the antenna keep-out block, and slowly increases the height.

It shall also be highlighted that plastic and metal parts in the near proximity of antennas may influence the antenna tuning and/or performance. This aspect should be noted as a general guideline for all antennas. The effects are difficult to estimate without detailed information, but it is common that a plastic housing above the antenna shifts the resonant frequency down. It is recommended to measure the antenna in the actual device after implementation.

2.4 GHz - Wi-Fi/BT/BLE Stamped Metal Antenna



PRO-OB-440

Request Samples



Check Inventory



13.75 x 5.23 x 3.53 mm
RoHS/RoHS II Compliant
MSL Level = 1

Park Marking

The top marking of the antenna is arranged according to the following illustration.

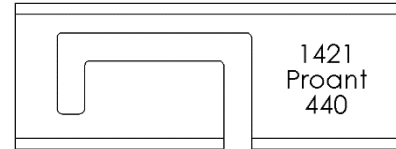
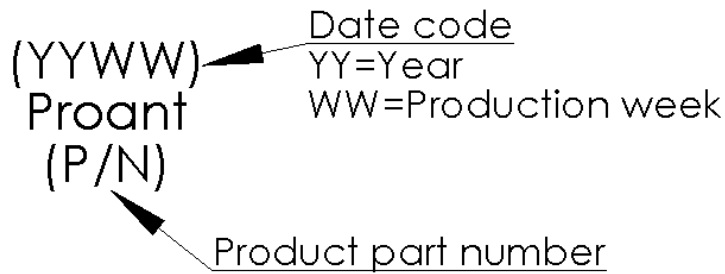

Example top marking

Ordering Information

Part number	Part name	Details
PRO-OB-440	OnBoard SMD 2400	Antenna for 2.4 GHz ISM band.
PRO-EB-450	Evaluation board, Onboard SMD 2400	Evaluation board with PRO-OB-440 for WLAN/Wifi, Bluetooth, Zigbee, RFID, WirelessHART applications.

2.4 GHz - Wi-Fi/BT/BLE Stamped Metal Antenna



PRO-OB-440

Request Samples



Check Inventory



13.75 x 5.23 x 3.53 mm
RoHS/RoHS II Compliant
MSL Level = 1

Packaging

Number of pcs/ reel = 1000

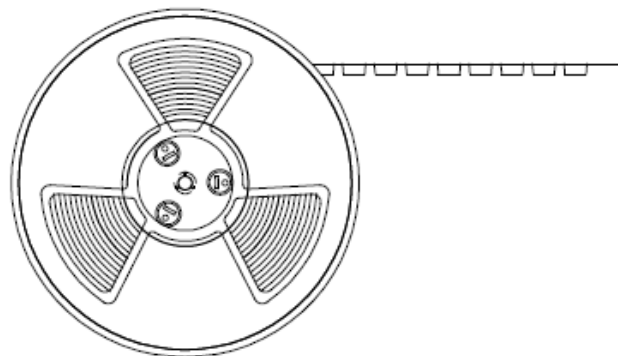
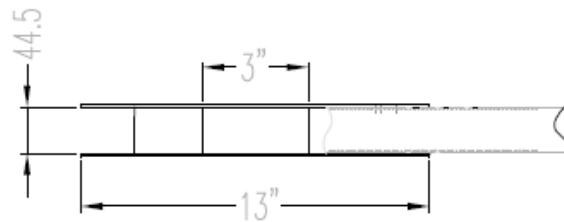
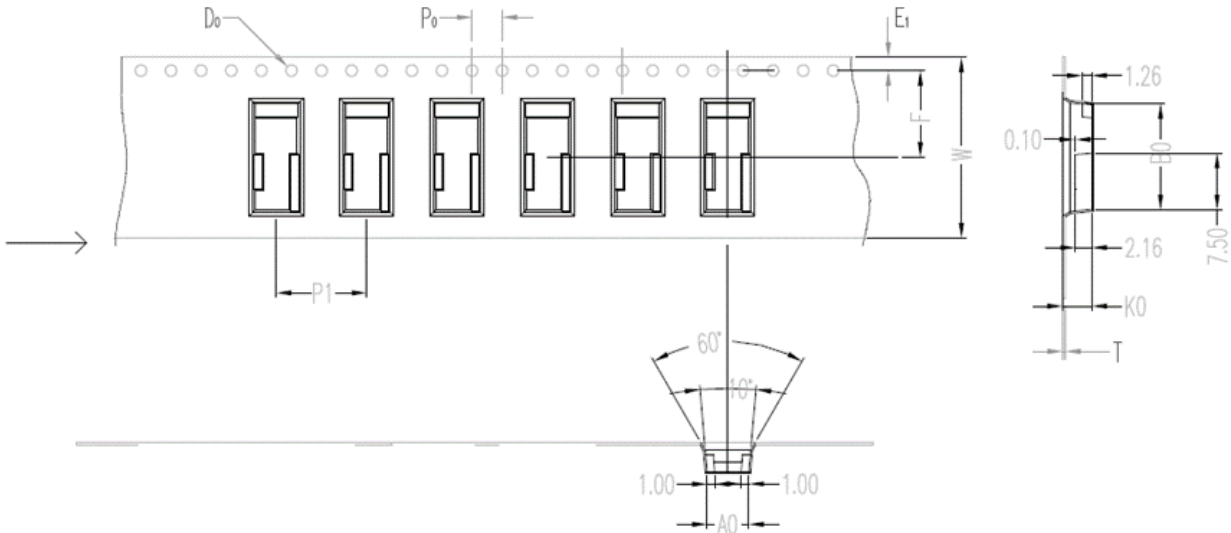

A ₀	5.53 ±0.1
B ₀	14.05 ±0.1
D ₀	∅1.5 ^{+0.10} _{-0.00}
E ₁	1.75 ±0.1
F	11.5 ±0.15
K ₀	3.83 ±0.1
P ₀	4.0 ±0.1
P ₁	12. ±0.1
P ₂	2.0 ±0.15
S ₀	
T	0.35 ±0.05
W	24.0 ±0.3

ATTENTION: Abracon LLC's products are COTS – Commercial-Off-The-Shelf products; suitable for Commercial, Industrial and, where designated, Automotive Applications. Abracon's products are not specifically designed for Military, Aviation, Aerospace, Life-dependent Medical applications or any application requiring high reliability where component failure could result in loss of life and/or property. For applications requiring high reliability and/or presenting an extreme operating environment, written consent and authorization from Abracon LLC is required. Please contact Abracon LLC for more information.



5101 Hidden Creek Ln Spicewood TX 78669
 Phone: 512-371-6159 | Fax: 512-351-8858
 For terms and conditions of sales, please visit:
www.abracon.com

REVISED: 07-19-21

ABRACON IS
 ISO9001-2015
 CERTIFIED