

LIST OF COMPONENTS

- 1) **CPR Rate Monitor Plus**
(Requires two AA batteries)
3.0V \approx 100mA
- 2) User Guide
- 3) Color ID Stickers
- 4) Lung bag with sensor holder

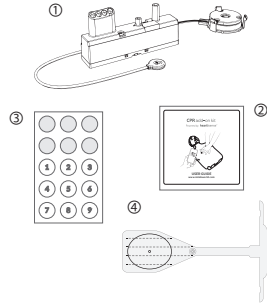

DOWNLOAD APPS



Copyright © 2020. I.M.LAB Inc.

WARRANTY

- 1) Manufacturer offers a **LIMITED WARRANTY** against any defects in workmanship or materials under normal use for one (1) year from the date of purchase. Any component of the **CPR Rate Monitor Plus** which proves defective within the warranty period will be repaired, free of charge. The customer is responsible for shipping and handling fees to the place which manufacturer designates.
- 2) Customer must provide proof of the date of purchase, place of purchase and the purchase price in order to obtain service under this limited warranty. No agent, representative, dealer of Manufacturer has the authority to alter the obligations or limitations of this limited warranty.
- 3) **CUSTOMER'S SOLE AND EXCLUSIVE REMEDY AGAINST MANUFACTURE SHALL BE FOR THE REPAIR OR REPLACEMENT OF DEFECTIVE GOODS AS PROVIDED HEREIN.** Repair of any component of any **CPR Rate Monitor Plus** does not extend this limited warranty or begin a new limited warranty period.
- 4) Manufacturer reserves the right to refuse warranty service or replacement when product failure is due to abrasion, abnormal use, misuse, mishandling, misapplication, accident, neglect, improper installation, modification, use of unauthorized parts or attachments, adjustments or repair performed by anyone other than manufacturer or its authorized agent, or any causes other than defective workmanship or material. This limited warranty does not cover failure or damage resulting from unsuitable operating environments or storing environments or natural disasters or acts of God. **MANUFACTURER SHALL NOT BE LIABLE FOR INCIDENTAL OR CONSEQUENTIAL DAMAGES ARISING OUT OF THE USE OF THE CPR Rate Monitor Plus OR THE BREACH OF THIS OR ANY OTHER EXPRESSED OR IMPLIED WARRANTY.**

CPR Add-on Kit for Prestan

Powered by **heartisense**[®]

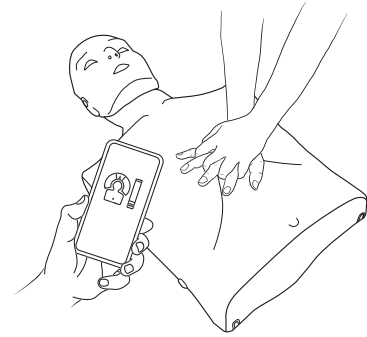

USER GUIDE

www.prestanproducts.com

PRODUCT INFORMATION

Product Name	CPR add-on Kit (for Prestan)
Model	AK2G-PA
Developer	I.M. LAB Inc.
Manufacturer Info.	I.M. LAB Inc. / 7F, 165, Yeoksam-ro, Gangnam, Seoul, Korea
Certification	CE. / FCC ID: 2ASY3AK2G-PA

FCC Part 15.19

This device complies with part 15 of the FCC Rules. Operation is subject to the following two conditions: (1) This device may not cause harmful interference, and (2) this device must accept any interference received, including interference that may cause undesired operation.

FCC Part 15.21

Any changes or modifications (including the antennas) to this device that are not expressly approved by the manufacturer may void the user's authority to operate the equipment.

FCC RF Radiation Exposure Statement:

This equipment complies with FCC RF Radiation exposure limits set forth for an uncontrolled environment. This device and its antenna must not be co-located or operating in conjunction with any other antenna or transmitter.

⚠ CAUTION

- Keep the used batteries out of reach of children and dispose separately.
- If you do not use the device for a long period of time remove and store the batteries.
- Do not use a new battery and an old battery together.

RF Specification

- BLE / 1Mbps
- Frequency : 2.4GHz band



PRESTAN

Prestan Products LLC

701 Beta Drive, Suite 3
Mayfield Village, OH 44143

www.prestanproducts.com

info@prestnproducts.com

800.434.7989

HOW TO INSTALL

1

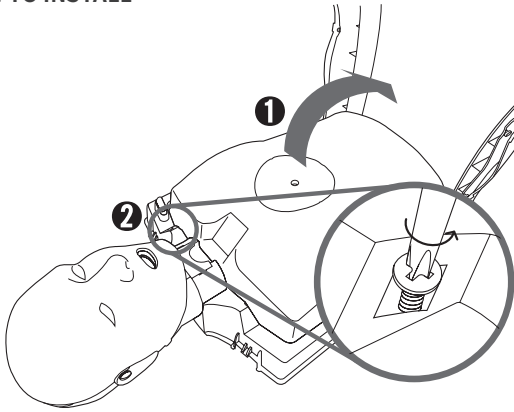

2

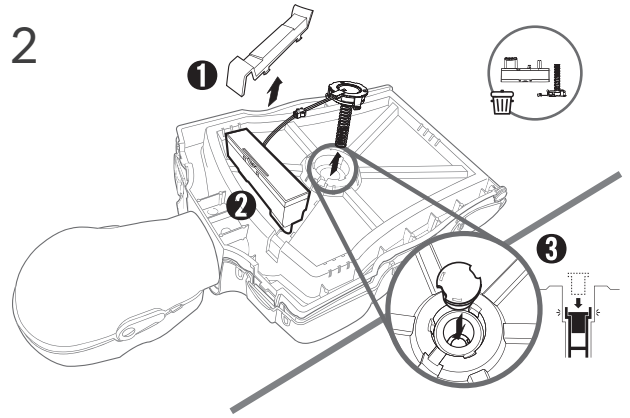

3

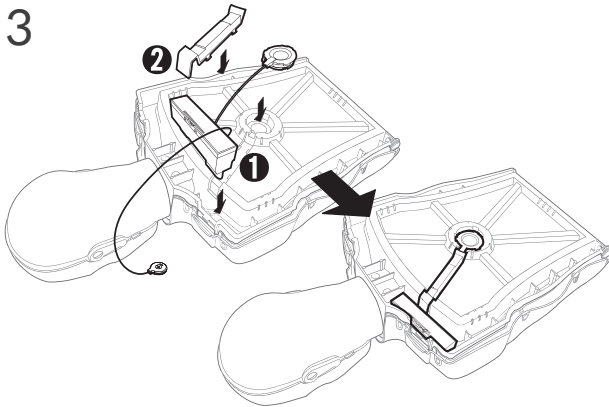

4

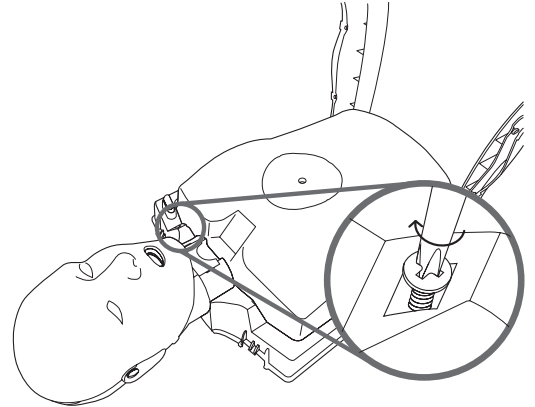

5

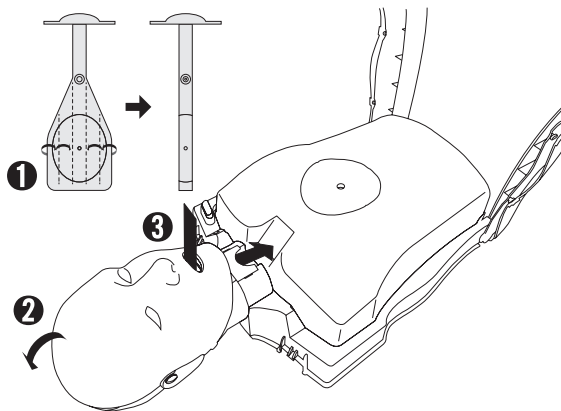

6

