

Dates of Tests: March 25 ~ April 18, 2019
Test Report S/N: LR500111904I
Test Site : LTA CO., LTD.

CERTIFICATION OF COMPLIANCE

FCC ID.

2ASY3AK1G-BB

APPLICANT

I.M.LAB Inc.

Equipment Class	:	Digital Transmission System (DTS)
Manufacturing Description	:	CPR Add-on KIT
Manufacturer	:	I.M.LAB Inc.
Model name	:	AK1G BB
Variant Model name	:	AK1G PT
Test Device Serial No.:	:	Identical prototype
Rule Part(s)	:	FCC Part 15.247 Subpart C ; ANSI C-63.10-2013
Frequency Range	:	2402 ~ 2480 MHz
Max. Output Power	:	Max -0.43 dBm – Conducted
Date of issue	:	MAY 11, 2019

This test report is issued under the authority of:



Ja-Beom, Koo / Manager

The test was supervised by:



jae-Hum, Yeon / Test Engineer

This test result only responds to the tested sample. It is not allowed to copy this report even partly without the allowance of the test laboratory. The report must not be used by the client to claim product certification, approval, or endorsement by NVLAP, NIST, or any agency of the Federal Government.



NVLAP LAB Code.: 200723-0

TABLE OF CONTENTS

1. GENERAL INFORMATION	3
2. INFORMATION ABOUT TEST ITEM	4
3. TEST REPORT	6
3.1 SUMMARY OF TESTS	6
3.2 TECHNICAL CHARACTERISTICS TEST	7
3.2.1 6 dB BANDWIDTH	7
3.2.2 OUTPUT POWER	10
3.2.3 POWER SPECTRAL DENSITY	14
3.2.4 BAND EDGE	17
3.2.5 CONDUCTED SPURIOUS EMISSIONS	10
3.2.6 RADIATED SPURIOUS EMISSIONS	23
3.2.7 AC Conducted Emissions	35
APPENDIX	
APPENDIX TEST EQUIPMENT USED FOR TESTS	36

1. General information

1-1 Test Performed

Company name : LTA Co., Ltd.
 Address : 243, Jubug-ri, Yangji-Myeon, Youngin-Si, Kyunggi-Do, Korea. 17159
 Web site : <http://www.ltalab.com>
 E-mail : chahn@ltalab.com
 Telephone : +82-31-323-6008
 Facsimile : +82-31-323-6010

Quality control in the testing laboratory is implemented as per ISO/IEC 17025 which is the “General requirements for the competents of calibration and testing laboratory”.

1-2 Accredited agencies

LTA Co., Ltd. is approved to perform EMC testing by the following agencies:

Agency	Country	Accreditation No.	Validity	Reference
NVLAP	U.S.A	200723-0	2019-09-30	ECT accredited Lab.
RRA	KOREA	KR0049	-	EMC accredited Lab.
FCC	U.S.A	649054	2021-04-11	FCC CAB
VCCI	JAPAN	C-4948,	2020-09-10	VCCI registration
VCCI	JAPAN	T-2416,	2020-09-10	VCCI registration
VCCI	JAPAN	R-4483(10 m),	2020-10-15	VCCI registration
VCCI	JAPAN	G-847	2021-12-13	VCCI registration
IC	CANADA	5799A-1	2019-11-07	IC filing
KOLAS	KOREA	NO.551	2021-08-20	KOLAS accredited Lab.
NVLAP	U.S.A	200723-0	2021-08-20	ECT accredited Lab.

2. Information about test item

2-1 Client & Manufacturer

Company name : I.M.LAB Inc.
 Address : Haeseong BLDG 7F, 165, Yeoksam-ro, Gangnam-gu, Seoul, Republic of Korea (06247)
 Tel / Fax : TEL No : +82-10-6676-8403 / FAX No : -

2-2 Equipment Under Test (EUT)

Trade name : I.M.LAB Inc.
 Model name : AK1G BB
 Serial number : Identical prototype
 Date of receipt : April 18, 2019
 EUT condition : Pre-production, not damaged
 Antenna type : Patten Antenna (Max Gain : -7.6 dBi)
 Frequency Range : 2402 ~ 2480 MHz
 RF output power : Max -0.43 dBm – Conducted
 Number of channels : 40
 Type of Modulation : GFSK
 Power Source : 3.0 Vdc

2-3 Tested frequency

	LOW	MID	HIGH
Frequency (MHz)	2402	2442	2480

2-4 Ancillary Equipment

Equipment	Model No.	Serial No.	Manufacturer
Notebook	CR720	MS-1736	MSI

2-5 Operating Mode

Mode	Remarks ¹⁾
Bluetooth(BT) Low Energy(LE)	Maxium Packet Size, VQFN 7x7

¹⁾ This setting of software is the worst case.

Any conditions under the normal use do not exceed the condition of setting

In addition, end users cannot change the settings of the output power of the product.

2-5 Duty Cycle

Test Mode	T _{on} (ms)	T _{on+off} (ms)	Duty Cycle (%)
BLE	100	100	100

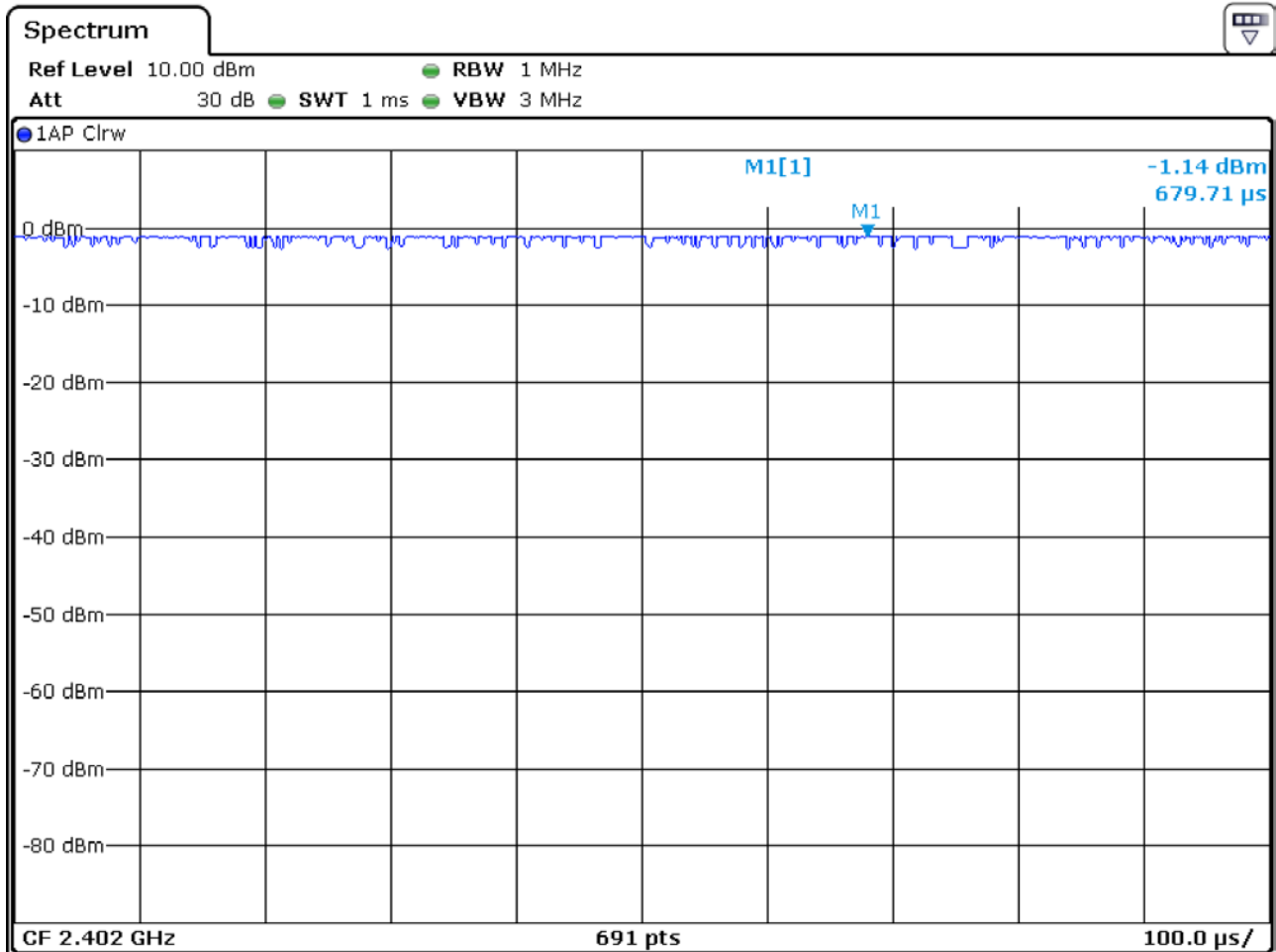

3. Test Report

3.1 Summary of tests

FCC Part Section(s)	Parameter	Limit	Test Condition	Status (note 1)
15.247(a)	6 dB Bandwidth	> 500 kHz	Conducted	C
15.247(b)	Transmitter Peak Output Power	< 1 Watt		C
15.247(e)	Transmitter Power Spectral Density	< 8 dBm @ 3 kHz		C
15.247(d)	Band Edge	> 20 dBc		C
	Conducted Spurious Emissions	> 20 dBc		C
15.209(a)	Radiated Spurious Emissions	On page 23	Radiated	C
15.207	AC Conducted Emissions	Emissions	Conducted	NA
15.203	Antenna requirement	-	-	C

Note 1: C=Complies NC=Not Complies NT=Not Tested NA=Not Applicable

Note 2: This product operates only with battery

The above equipment was tested by LTA Co., Ltd. The test data, data evaluation, test procedures, and equipment configurations shown in this report were made in accordance with the procedures given in ANSI C63.10-2013 and the energy emitted by the sample EUT tested as described in this report is in compliance with the requirements of FCC Rules Part 2 and Part 15.247 The test results of this report relate only to the tested sample identified in this report.

Frequency range to be scanned:

0.15 MHz - 30 MHz as conducted measurement

30 MHz to 5th harmonic of the highest frequency or 40 GHz, whichever is lower as radiated measurement.

Bandwidth:

Measured by the CISPR quasi-peak function Bandwidth is 9 kHz in the frequency 0.15 MHz to 30 MHz and 120 kHz in the frequency 30 MHz to 1,000 MHz.

Measured by the Peak function Bandwidth is 1 MHz in the frequency 1 GHz to 40 GHz.

A sample calculation:

COR. F (correction factor)= Antenna factor + Cable loss- Amp.gain- Distance correction

Emission Level= meter reading + COR.F

→ Antenna Requirement

The **I.M.LAB Inc** FCC ID: **2ASY3AK1G-BB** unit complies with the requirement of §15.203.

The antenna type is Patten Antenna.

3.2 MEASUREMENT METHODS

Parameter	METHODS
6 dB Bandwidth	KDB 558074 D01 v05r02, Section 8.2
Transmitter Peak Output Power	KDB 558074 D01 v05r02, Section 8.3.1.1
Transmitter Power Spectral Density	KDB 558074 D01 v05r02, Section 8.4.
Band Edge	KDB 558074 D01 v05r02, Section 8.7
Conducted Spurious Emissions	KDB 558074 D01 v05r02, Section 8.5
Radiated Spurious Emissions	KDB 558074 D01 v05r02, Section 8.6
AC Conducted Emissions	ANSI C63.10-2013, Section 6.2.

3.2 Technical Characteristics Test

3.2.1 6 dB Bandwidth

Procedure:

The bandwidth at 6 dB below the highest in-band spectral density was measured with a spectrum analyzer connected to the antenna terminal, while EUT is operating in transmission mode at the appropriate frequencies.

After the trace being stable, Use the marker-to-peak function to set the marker to the peak of the emission. Use the marker-delta function to measure 6 dB down one side of the emission. Reset the marker-delta function, and move the marker to the other side of the emission, until it is (as close as possible to) even with the reference marker level. The marker-delta reading at this point is the 6 dB bandwidth of the emission.

The spectrum analyzer is set to:

Center frequency = the highest, middle and the lowest channels

RBW = 100 kHz

Span = 5 MHz

VBW = 300 kHz (VBW \geq 3*RBW)

Sweep = auto

Trace = max hold

Detector function = peak

Measurement Data : Complies

Frequency (MHz)	Test Results	
	Measured Bandwidth (MHz)	Result
2402	0.752	Complies
2442	0.745	Complies
2480	0.752	Complies

- See next pages for actual measured spectrum plots.

Minimum Standard:

6 dB Bandwidth > 500 kHz

Measurement Setup

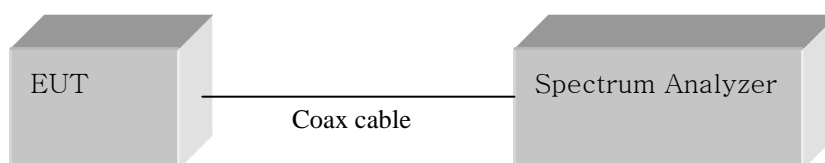
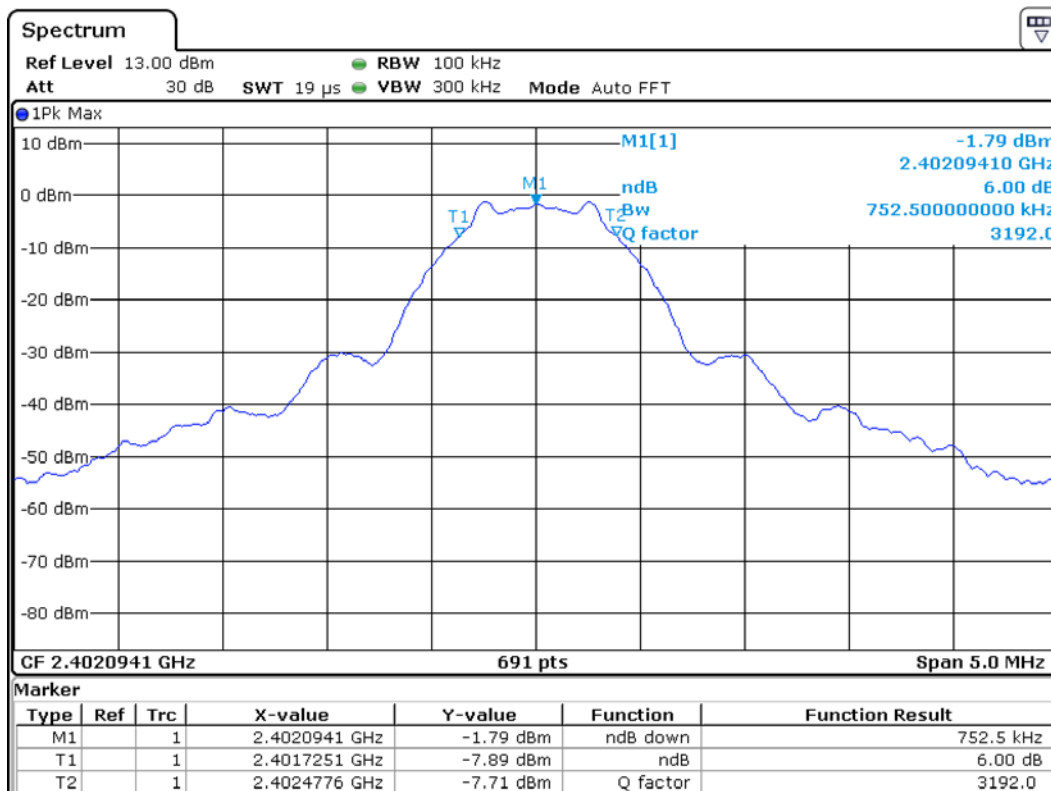
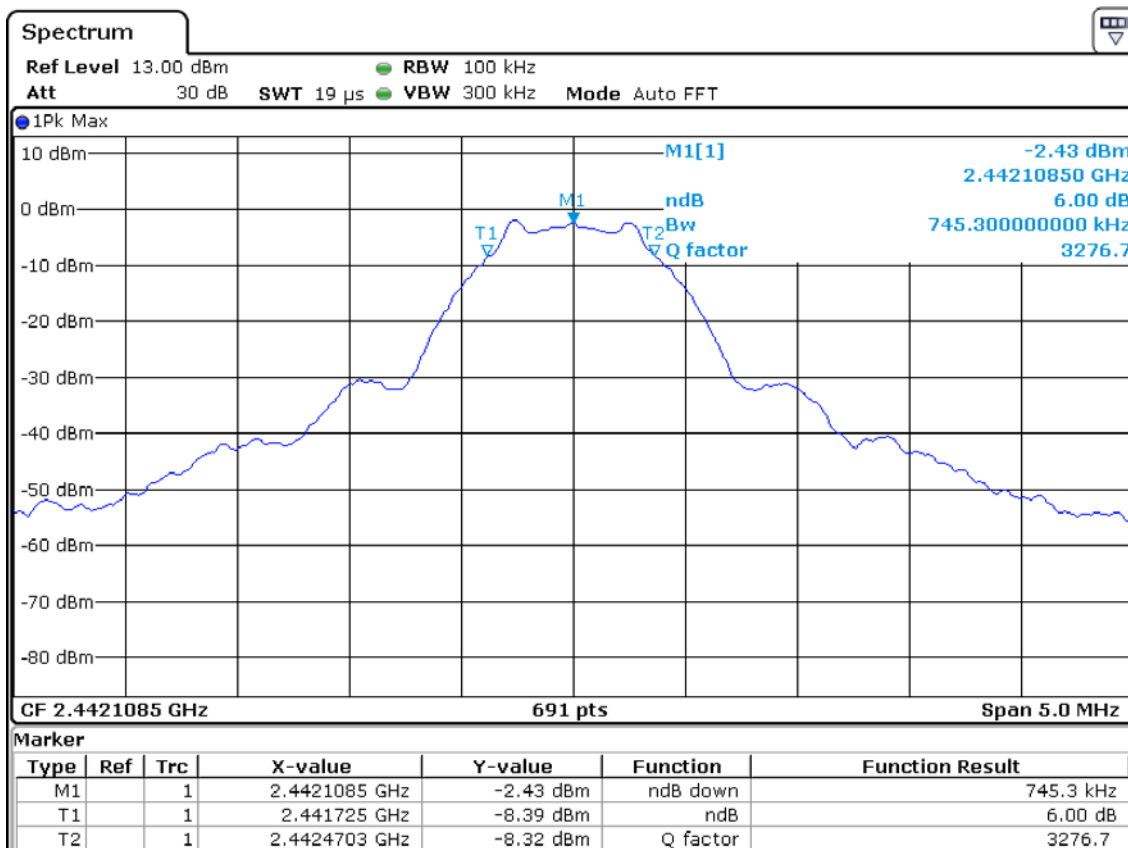

Figure 1: Measurement setup for the carrier frequency separation

Low Channel



Middle Channel



High Channel

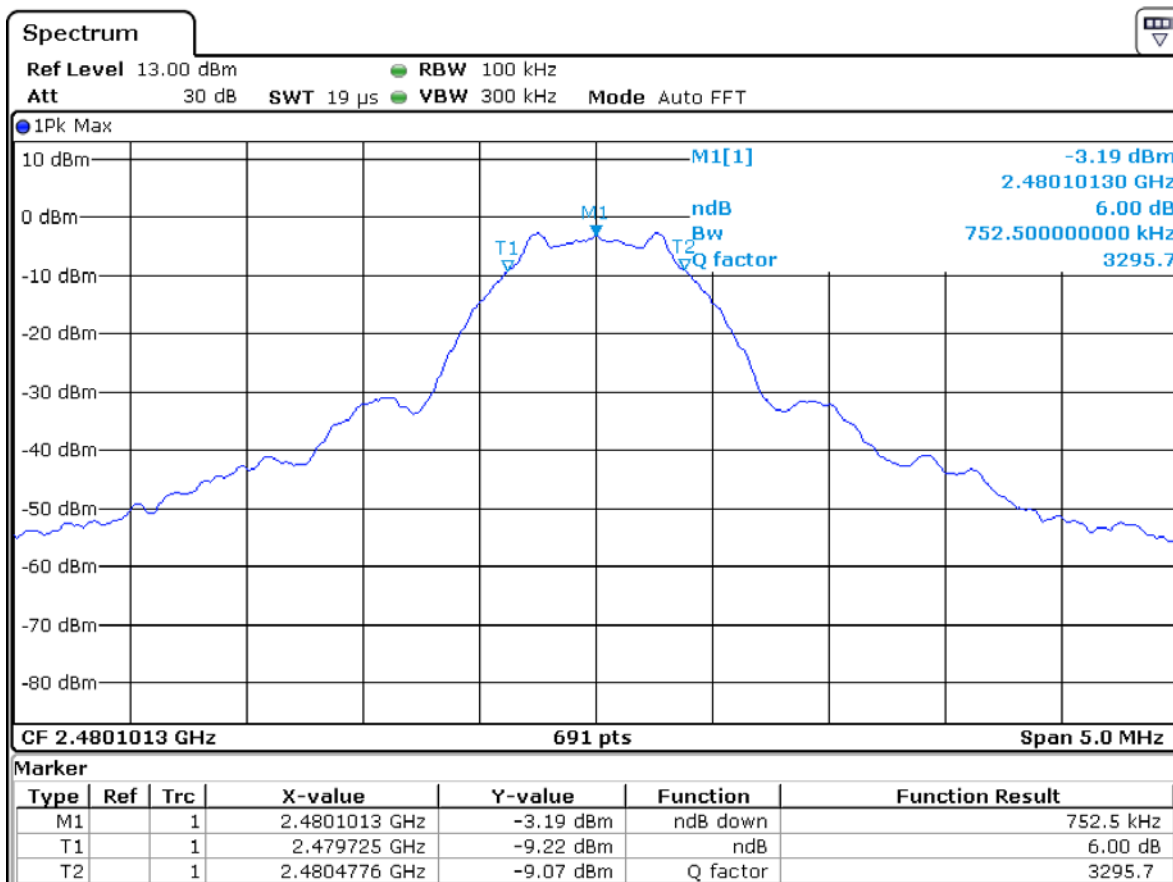

3.2.2 Output Power Measurement

Procedure:

The maximum peak output power was measured with the spectrum analyzer connected to the antenna output of the EUT. The spectrum analyzer's internal channel power integration function is used to integrate the power over a bandwidth greater than or equal to the 99 % bandwidth. The EUT was operating in transmit mode at the appropriate center frequency.

The spectrum analyzer is set to(Peak):

Center frequency = the highest, middle and the lowest channels

RBW = 1 MHz

Span = auto

VBW = 3 MHz (VBW \geq 3 * RBW)

Sweep = auto

Detector function = peak

The spectrum analyzer is set to(Average):

Center frequency = the highest, middle and the lowest channels

RBW = 1 MHz

Span = auto

VBW = 3 MHz (VBW \geq 3 * RBW)

Sweep = auto

Detector function = RMS

Measurement Data : **Complies**

Frequency (MHz)	Test Results				Result
	dBm(AV / Peak)		mW (AV / Peak)		
2402	-1.09	-0.43	0.778	0.905	Complies
2442	-1.74	-1.17	0.669	0.763	Complies
2480	-2.44	-1.84	0.570	0.654	Complies

- See next pages for actual measured spectrum plots.

Minimum Standard:

Peak output power	< 1 W
-------------------	-------

Measurement Setup

Same as the Chapter 3.2.1 (Figure 1)

Low Channel(Peak)

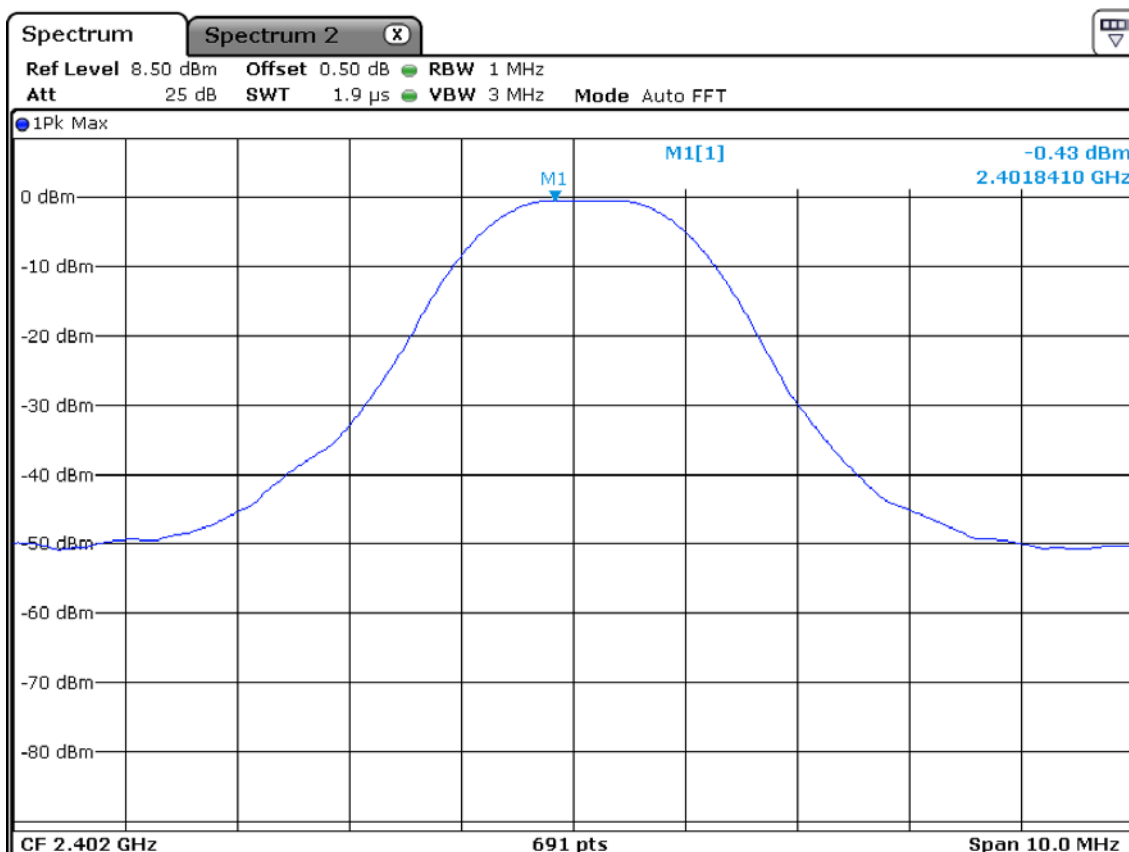

Middle Channel(Peak)

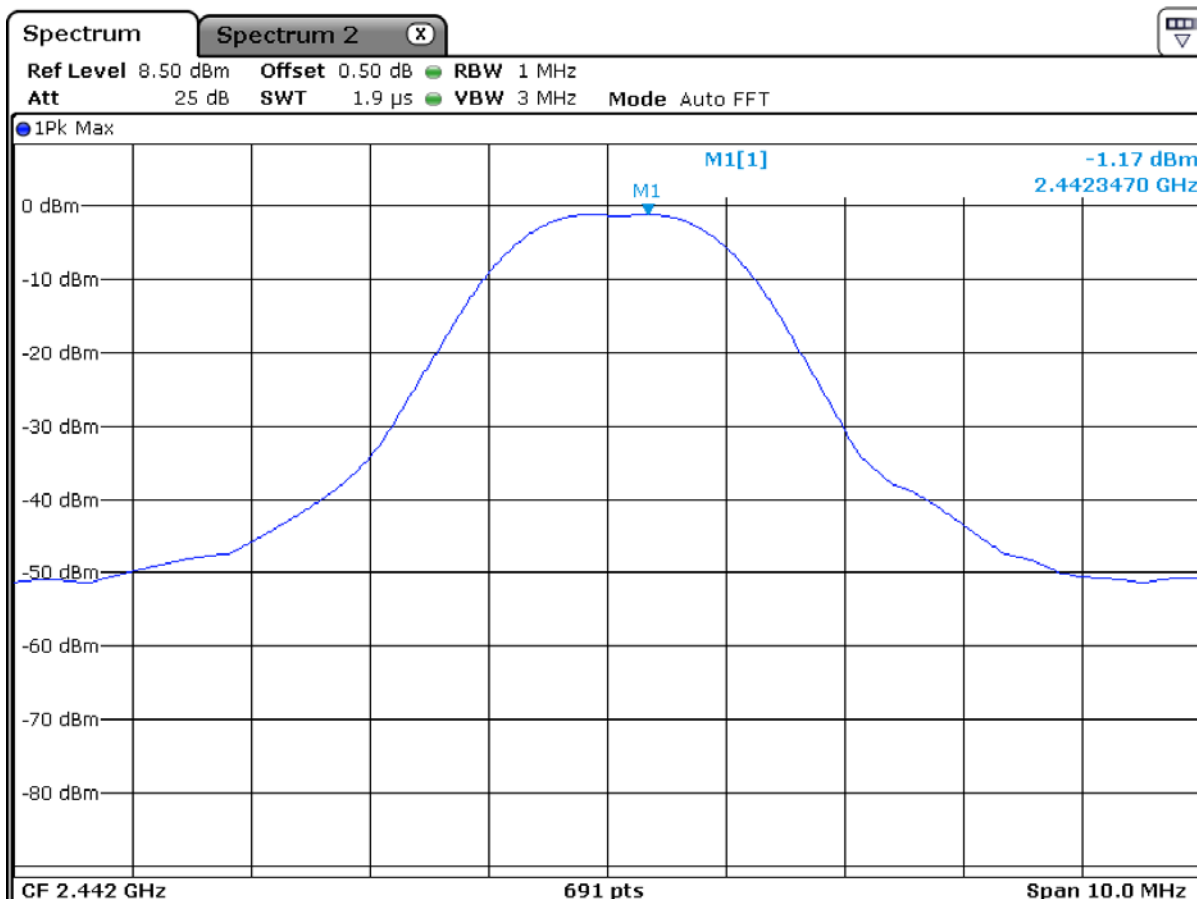

High Channel(Peak)

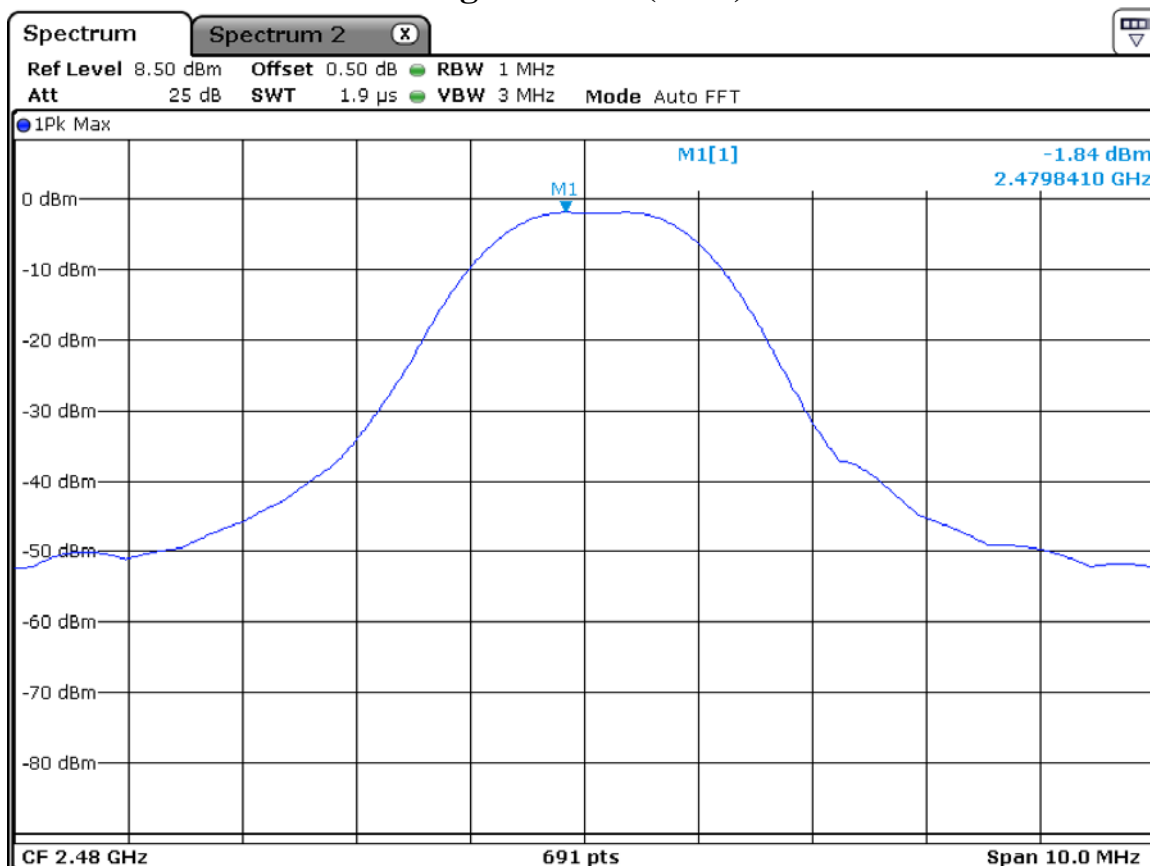

Low Channel(Average)

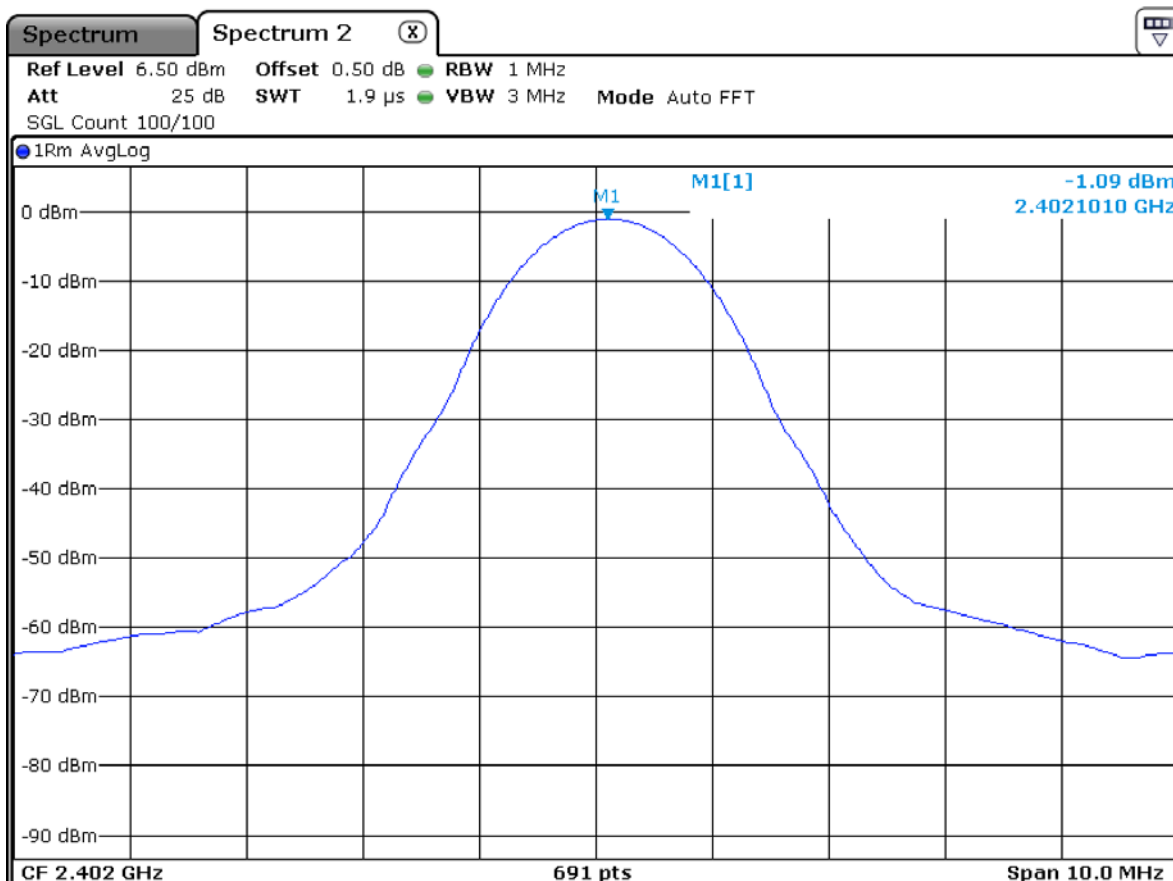

Middle Channel(Average)

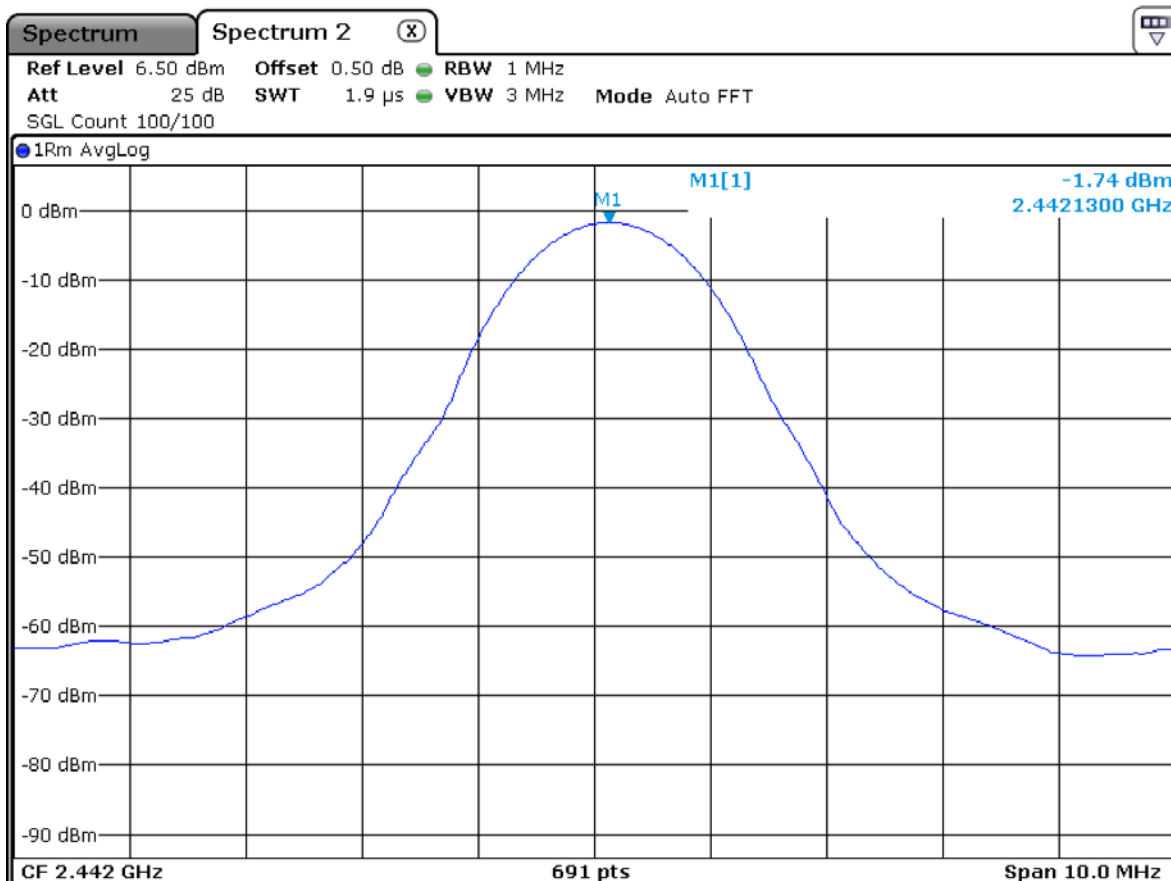

High Channel(Average)

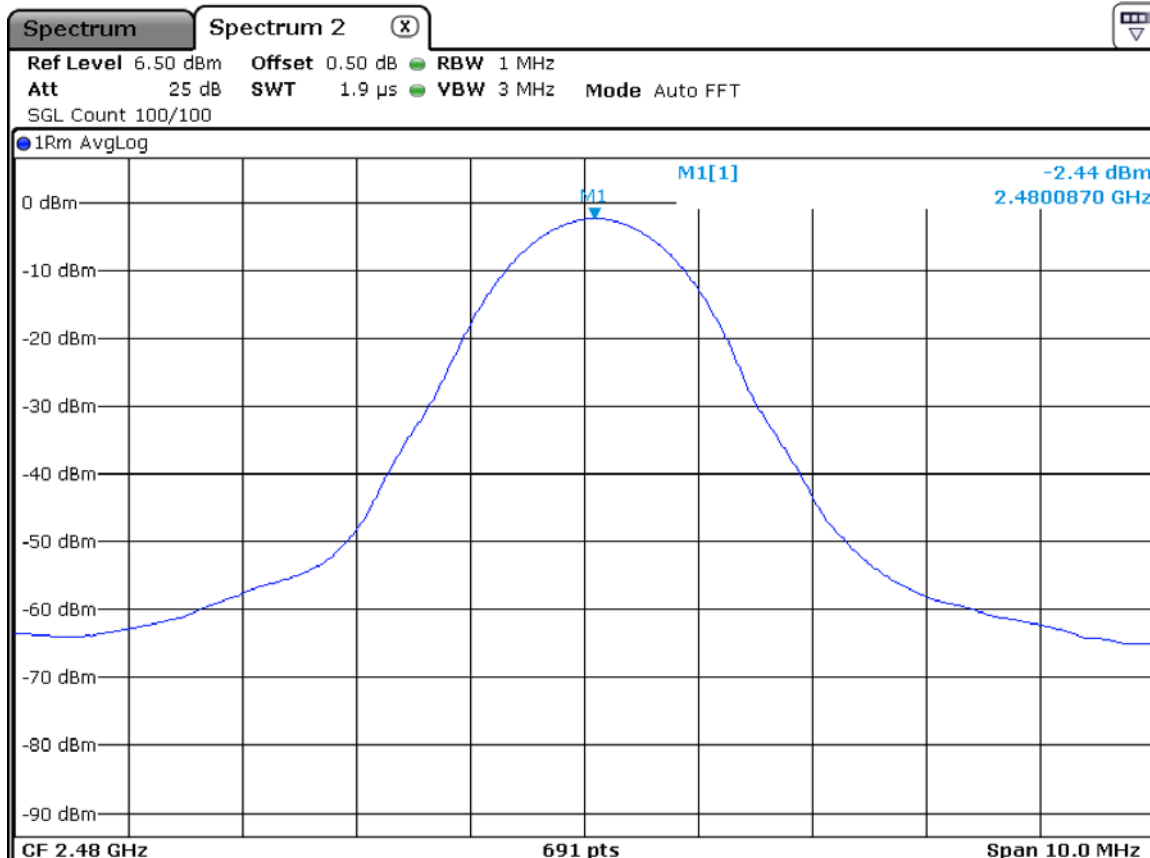

3.2.3 Power Spectral Density

Procedure:

The peak power density is measured with a spectrum analyzer connected to the antenna terminal while the EUT is operating in transmission mode at the appropriate frequencies.

The spectrum analyzer is set to:

RBW = 3 kHz ($3\text{kHz} \leq \text{RBW} \leq 100\text{kHz}$)

Span = 1.5 times the DTS bandwidth

VBW = 10 kHz ($3 * \text{RBW}$)

Sweep = auto

Detector function = peak

Trace = max hold

Measurement Data : **Complies**

Frequency (MHz)	Test Results	
	dBm	Result
2402	-8.55	Complies
2442	-10.20	Complies
2480	-12.26	Complies

- See next pages for actual measured spectrum plots.

Minimum Standard:

Power Spectral Density	< 8 dBm @ 3 kHz BW
------------------------	--------------------

Measurement Setup

Same as the Chapter 3.2.1 (Figure 1)

Power Density Measurement

Low Channel

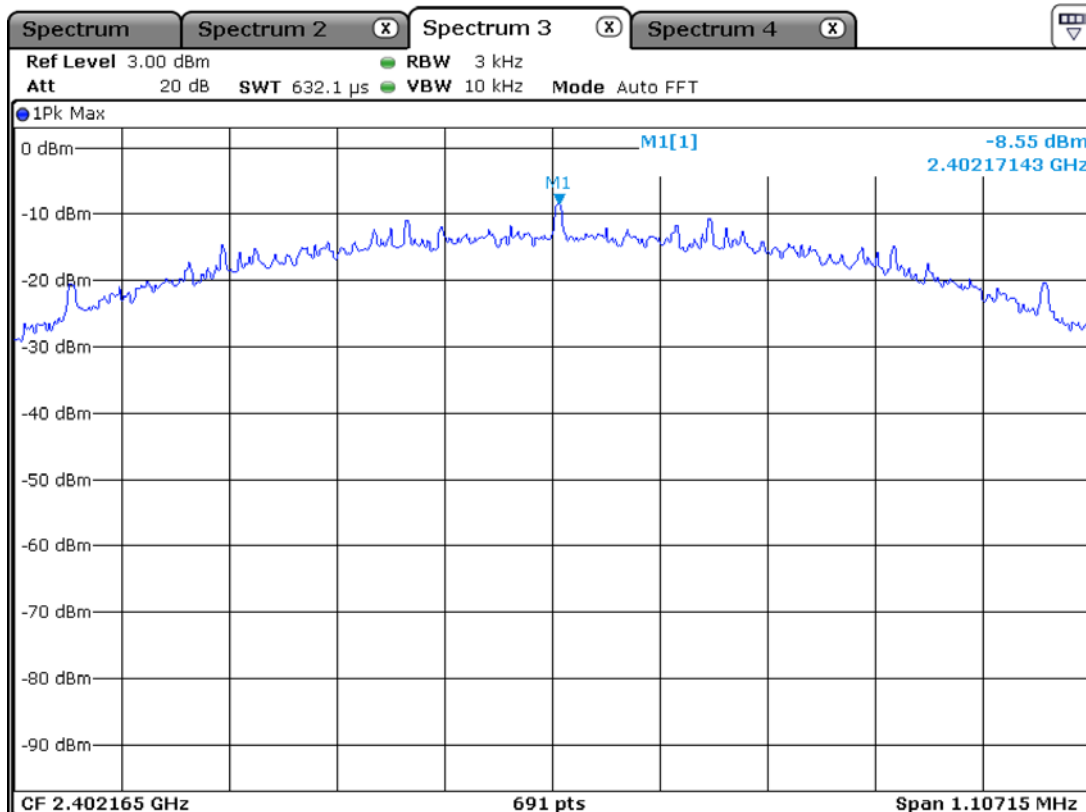

Middle Channel

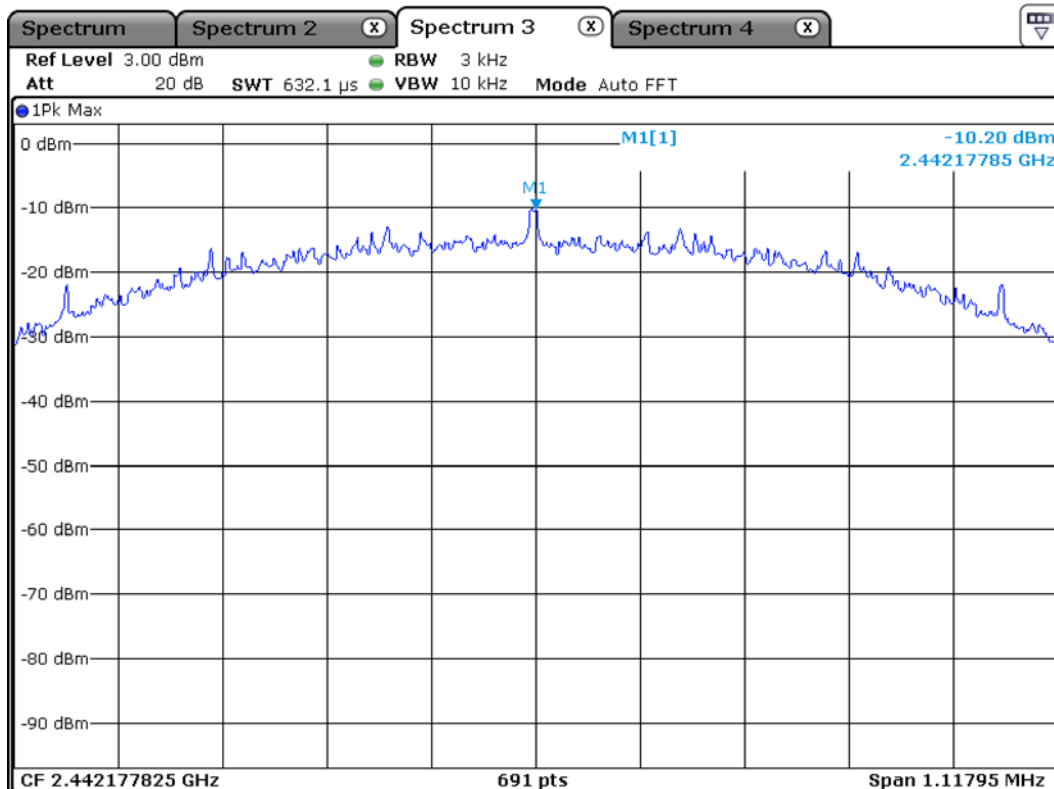

High Channel

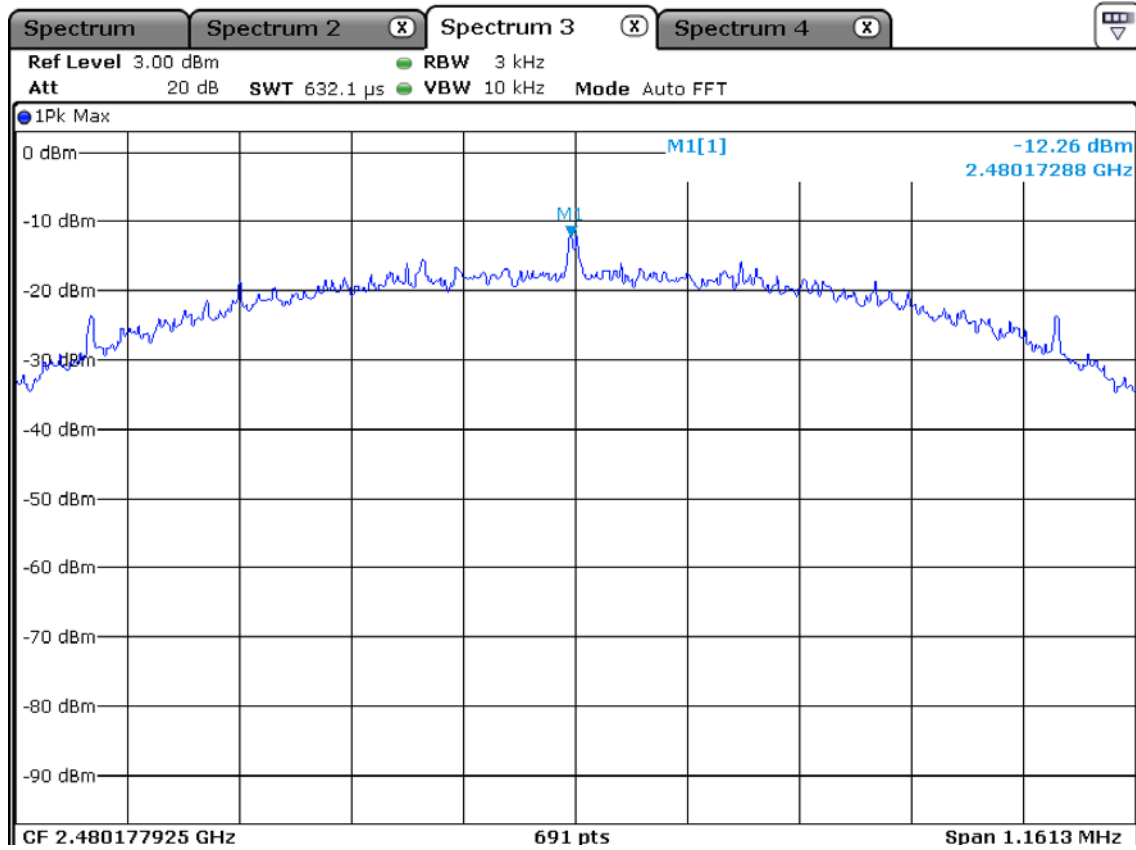

3.2.4 Band Edge

Procedure:

The bandwidth at 20 dB down from the highest inband spectral density is measured with a spectrum analyzer connected to the antenna terminal, while EUT is operating in transmission mode at the appropriate frequencies.

After the trace being stable, Use the marker-to-peak function to measure 20 dB down both sides of the intentional emission.

The spectrum analyzer is set to:

Center frequency = the highest, middle and the lowest channels

RBW = 100 kHz

VBW = 100 kHz

Span = 40 MHz, 100 MHz

Detector function = peak

Trace = max hold

Sweep = auto

Radiated emissions which fall in the restricted bands, as defined in 15.205(a), must also comply with the radiated emission limits specified in 15.209(a)

The spectrum analyzer is set to:

Center frequency = the highest, the lowest channels

PEAK:

RBW = 1 MHz, VBW \geq 3 MHz, Sweep=Auto

Average:

RBW = 1 MHz, VBW = 3 MHz, Sweep=Auto

Measurement Distance:

3 m

Polarization:

Horizontal / Vertical

Measurement Data: Complies

- All conducted emission in any 100 kHz bandwidth outside of the spread spectrum band was at least 20 dB lower than the highest inband spectral density. Therefore the applying equipment meets the requirement.
- See next pages for actual measured spectrum plots.

Minimum Standard:	> 20 dBc
--------------------------	----------

Lower edge

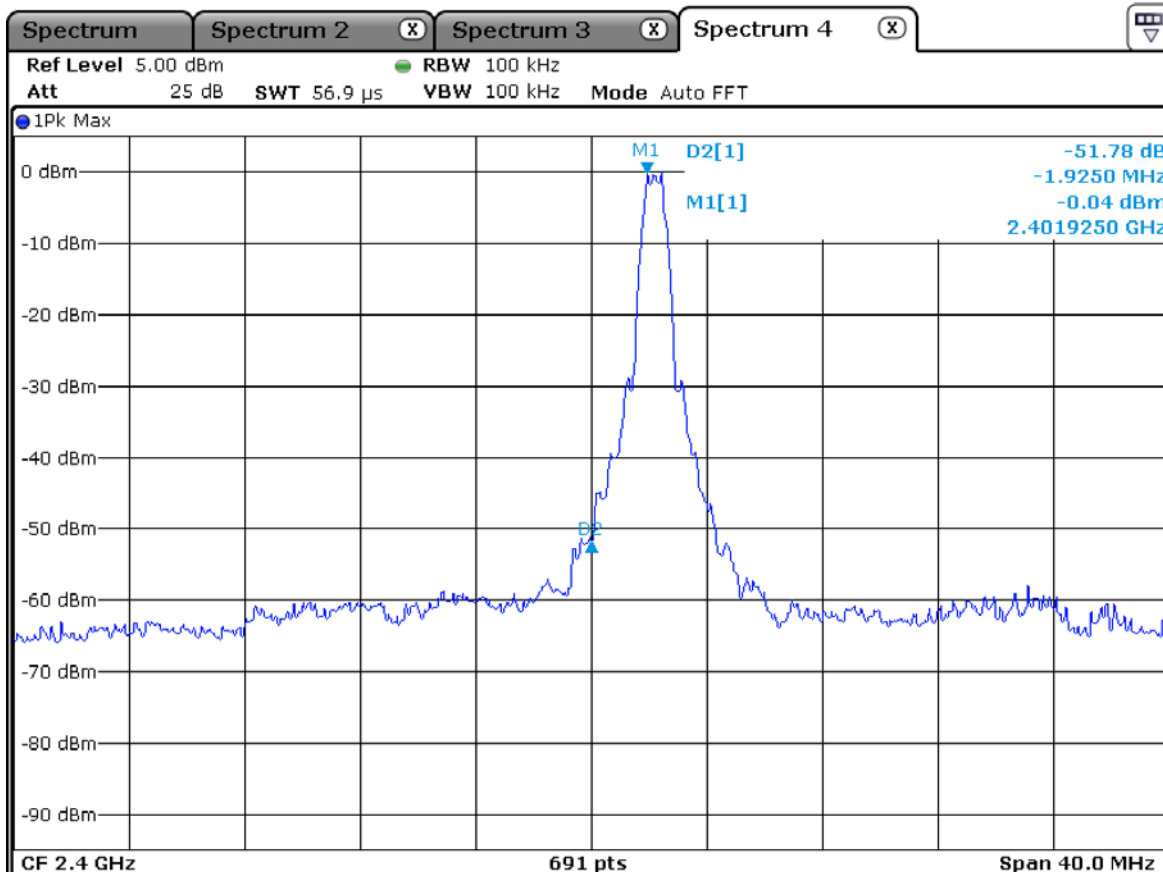

Upper edge

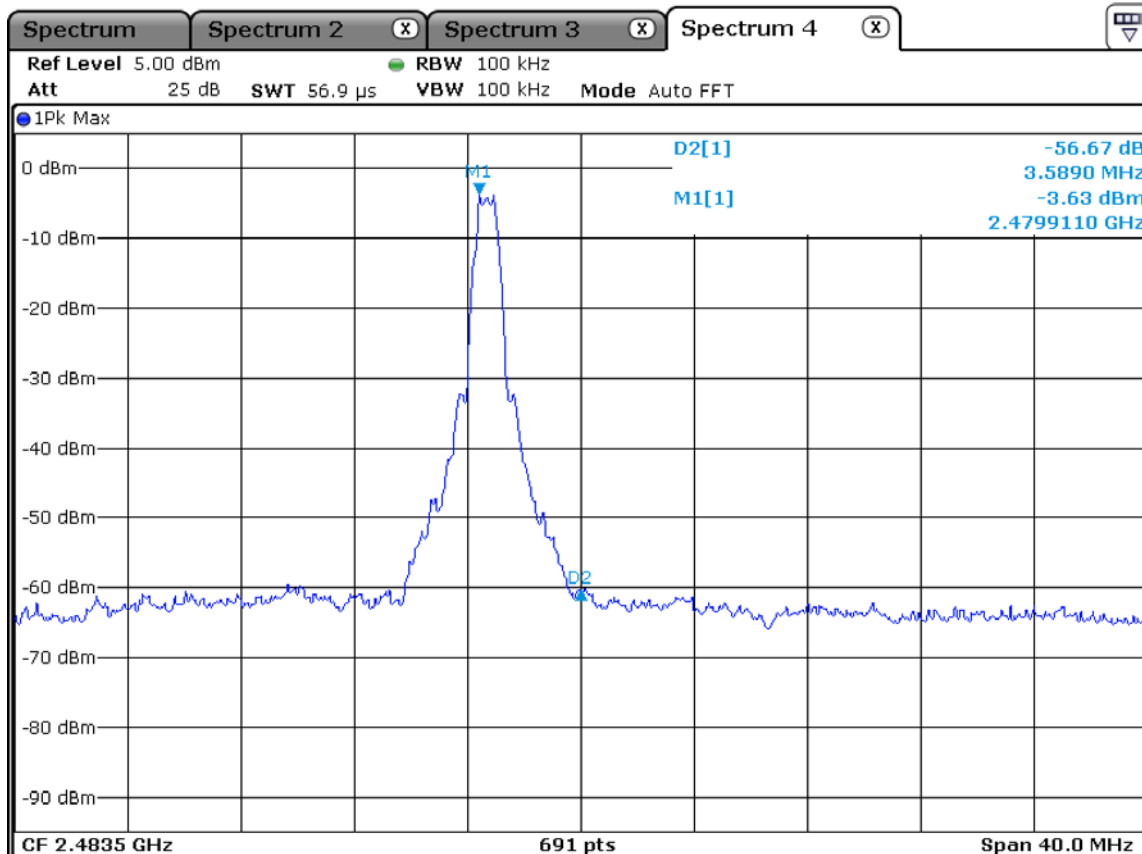

Radiated emissions Lower edge

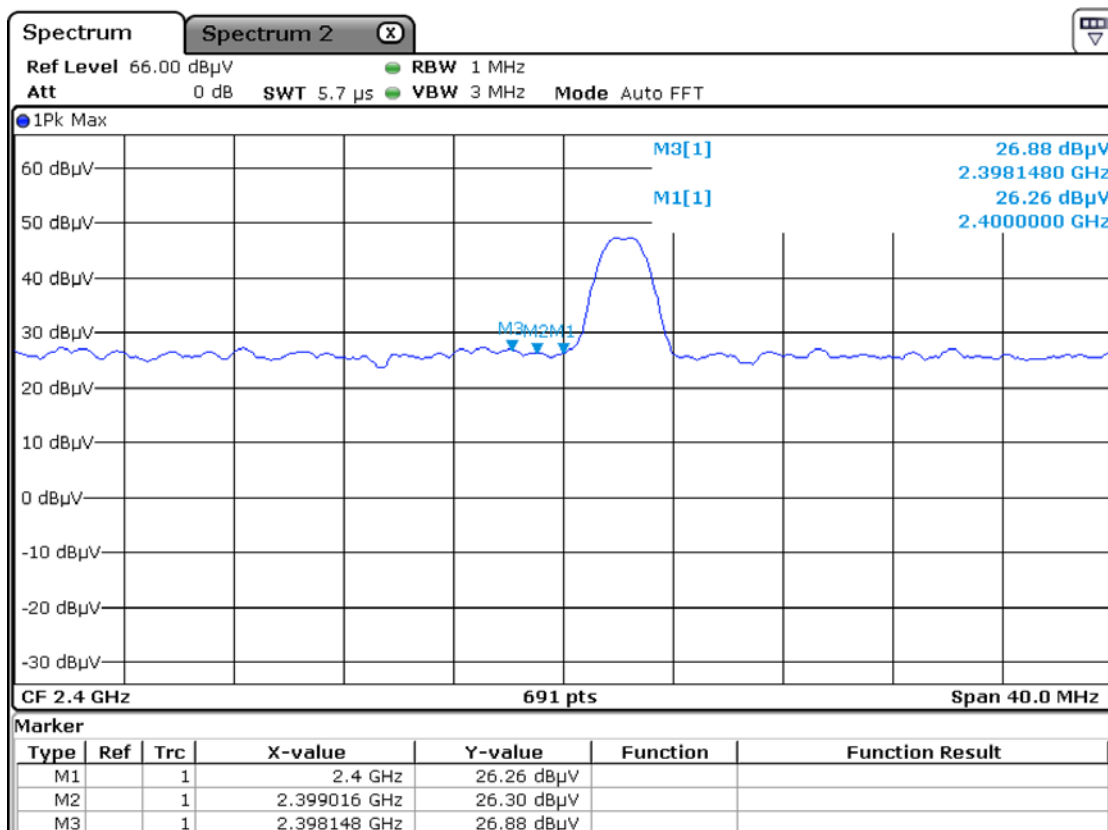

Radiated emissions Upper edge

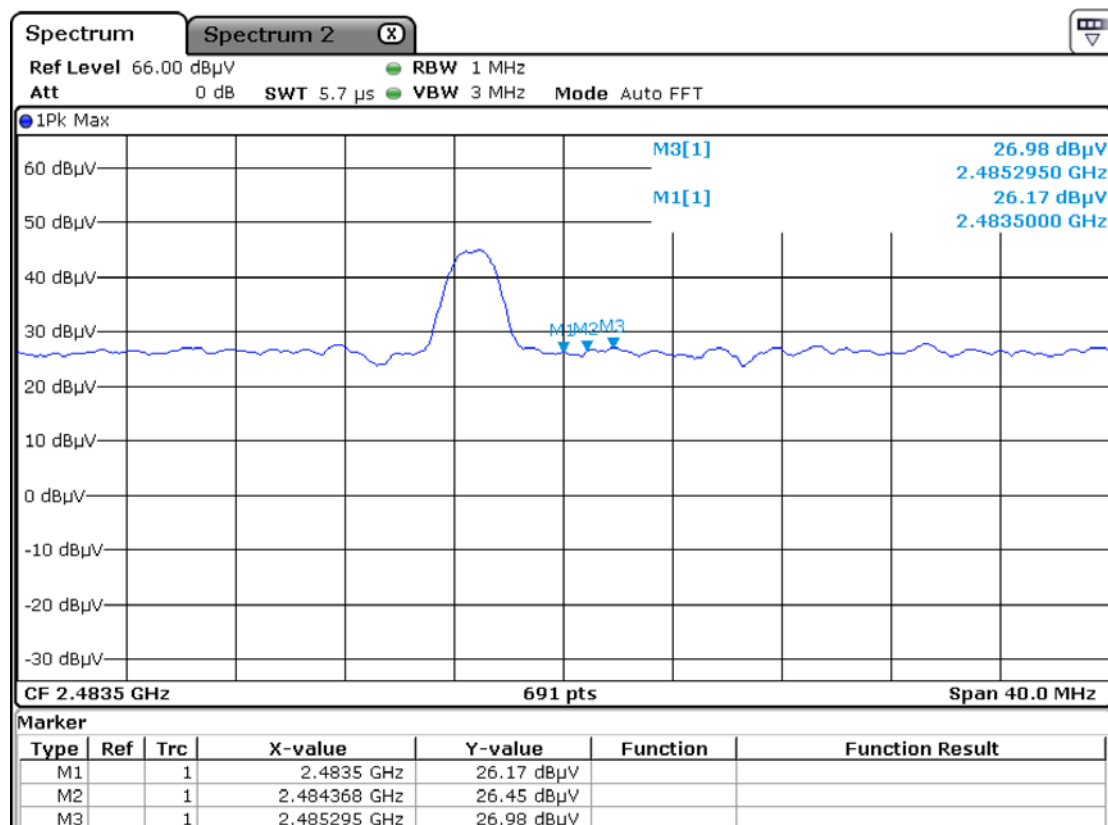

Radiated Band-edges in the restricted band 2310-2390 MHz measurement

Frequency [MHz]	Reading [dBuV/m]		Pol.	Correction Factor		Limits [dBuV/m]		Result [dBuV/m]		Margin [dB]	
	AV / Peak			Antenna	Amp. Gain + Cable Loss	AV / Peak		AV / Peak		AV / Peak	
2400	16.96	26.26	H	28.08	8.77	54	74	36.27	45.57	17.73	28.43
2399	16.47	26.30	H	28.09	8.78	54	74	35.78	45.61	18.22	28.39
2398	16.94	26.8	H	28.08	8.77	54	74	36.25	46.11	17.75	27.89

Radiated Band-edges in the restricted band 2483.5-2500 MHz measurement

Frequency [MHz]	Reading [dBuV/m]		Pol.	Correction Factor		Limits [dBuV/m]		Result [dBuV/m]		Margin [dB]	
	AV / Peak			Antenna	Amp. Gain + Cable Loss	AV / Peak		AV / Peak		AV / Peak	
2493.1	16.25	26.17	H	27.88	8.57	54	74	35.56	45.48	18.44	28.52
2492.2	16.07	26.45	H	27.88	8.57	54	74	35.38	45.76	18.62	28.24
2491.4	16.65	26.98	H	27.88	8.57	54	74	35.96	46.29	18.04	24.03

Note : This EUT was tested in 3 orthogonal positions and the worst-case data was presented

3.2.5 Conducted Spurious Emissions

Procedure:

The test follows KDB558074. The conducted spurious emissions were measured with a spectrum analyzer connected to the antenna terminal, while EUT had its hopping function disabled at the highest, middle and the lowest available channels..

After the trace being stable, set the marker on the peak of any spurious emission recorded.

The spectrum analyzer is set to:

Span = wide enough to capture the peak level of the in-band emission and all spurious emissions

RBW = 100 kHz

Sweep = auto

VBW = 100 kHz

Detector function = peak

Trace = max hold

Measurement Data: **Complies**

- All conducted emission in any 100 kHz bandwidth outside of the spread spectrum band was at least 20 dB lower than the highest inband spectral density. Therefore the applying equipment meets the requirement.
- See next pages for actual measured spectrum plots.

Minimum Standard:	> 20 dBc
--------------------------	----------

Measurement Setup

Same as the Chapter 3.2.1 (Figure 1)

Unwanted Emission – Low Channel
Frequency Range = 30 MHz ~ 26.5 GHz

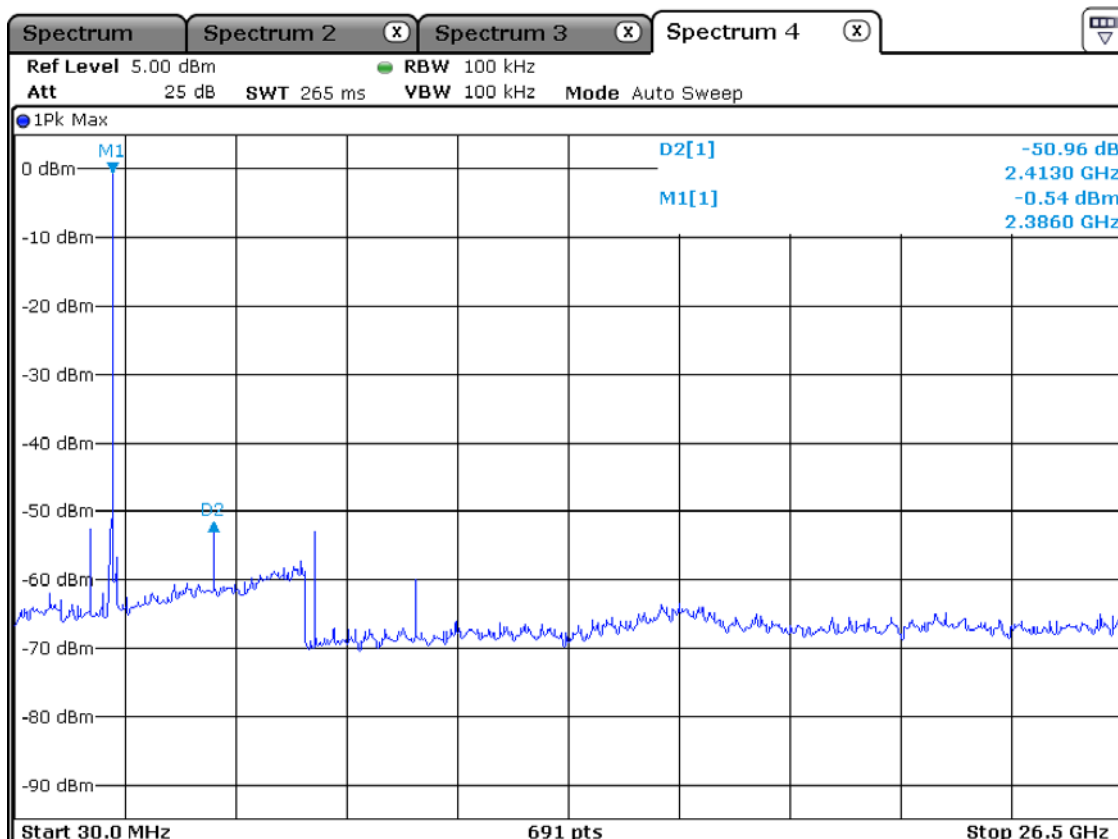

Unwanted Emission – Middle Channel
Frequency Range = 30 MHz ~ 26.5 GHz

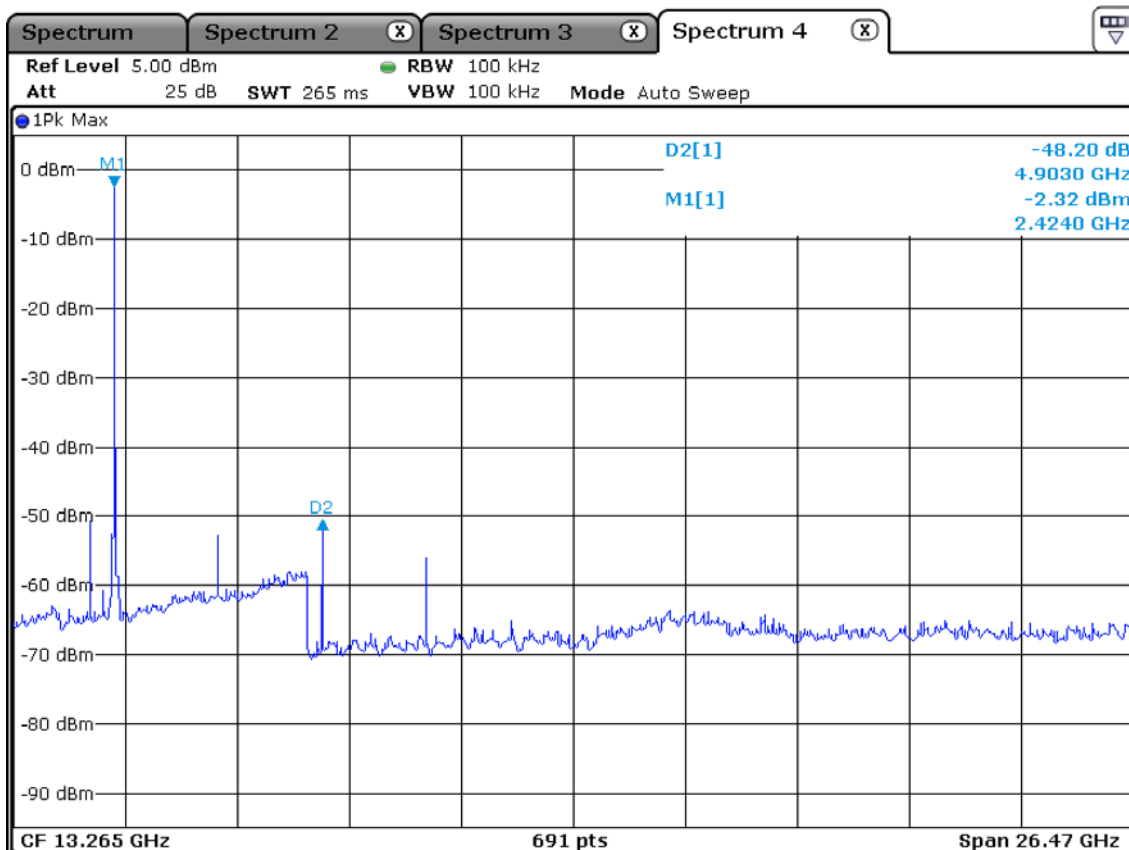

Unwanted Emission – High Channel
Frequency Range = 30 MHz ~ 26.5 GHz

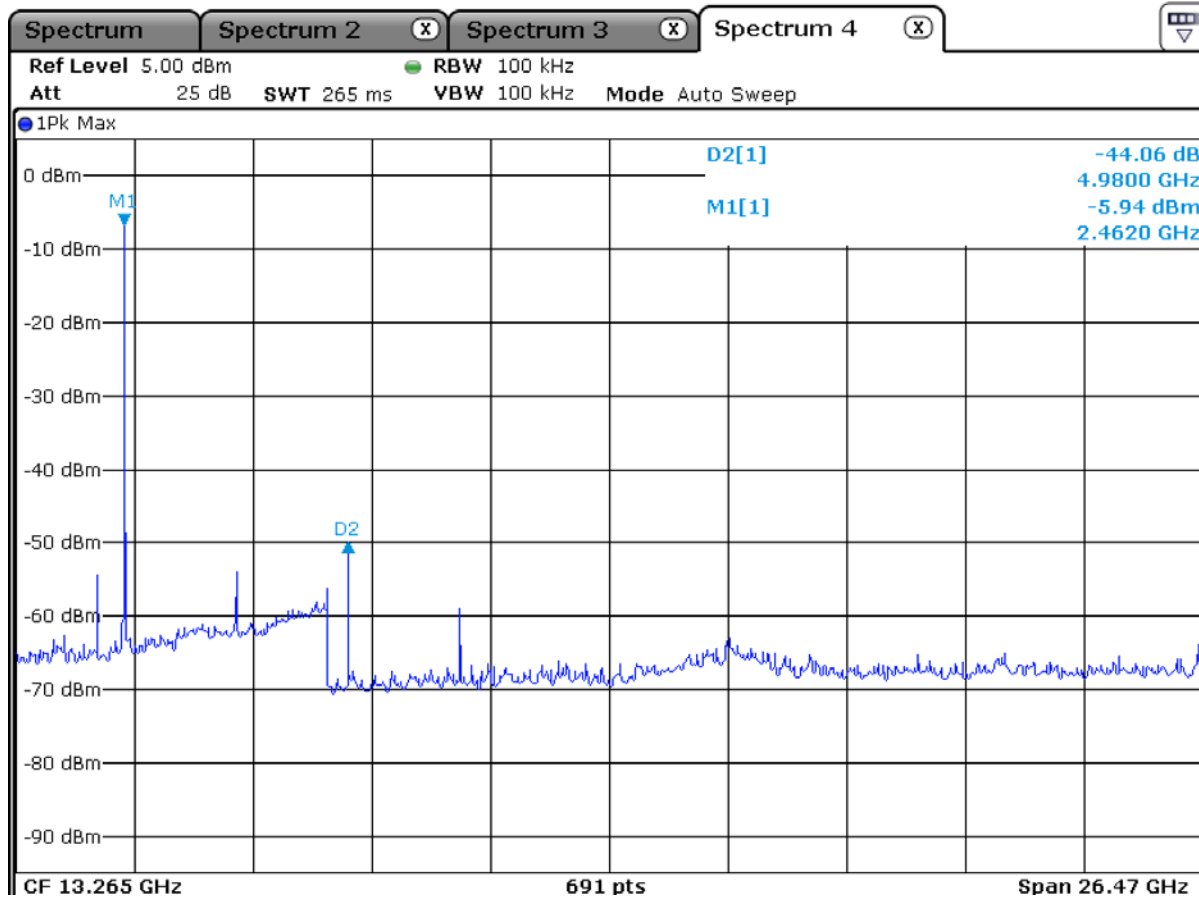

3.2.6 Radiated Spurious Emissions

Procedure:

Radiated emissions from 30 MHz to 25 GHz were measured according to the methods defines in ANSI C63.10-2013.

The EUT is a placed on as turn table. For emissions testing at or below 1 GHz, the table height shall be 0.8 m above the reference ground plane. For emission measurements above 1 GHz, the table height shall be 1.5 m. The turn table shall rotate 360 degrees to determine the position of maximum emission level. EUT is set 3m away from the receiving antenna which varied from 1m to 4m to find out the highest emission. And also, each emission was to be maximized by changing the polarization of receiving antenna both horizontal and vertical. In order to find out the max. emission, the relative positions of this hand-held transmitter (EUT) was rotated through three orthogonal axes and measurement procedures for electric field radiated emissions above 1 GHz the EUT measurement is to be made “while keeping the antenna in the ‘cone of radiation’ from that area and pointed at the area both in azimuth and elevation, with polarization oriented for maximum response.” is still within the 3dB illumination BW of the measurement antenna.

The spectrum analyzer is set to:

Center frequency = the worst channel

Frequency Range = 9 kHz ~ 10th harmonic.

PK

RBW = 100 kHz (30 MHz ~ 1 GHz)

VBW \geq RBW

= 1 MHz (1 GHz ~ 10th harmonic)

Span = 100 MHz

Detector function = peak

Trace = max hold

Sweep = auto

AV

RBW = 1 MHz

VBW = 3MHz

Trace = 100

Detector function = RMS

Duty cycle

The EUT configureal to transmit continuously(D \geq 98%)/ Duty Factor = 0

below 30 MHz

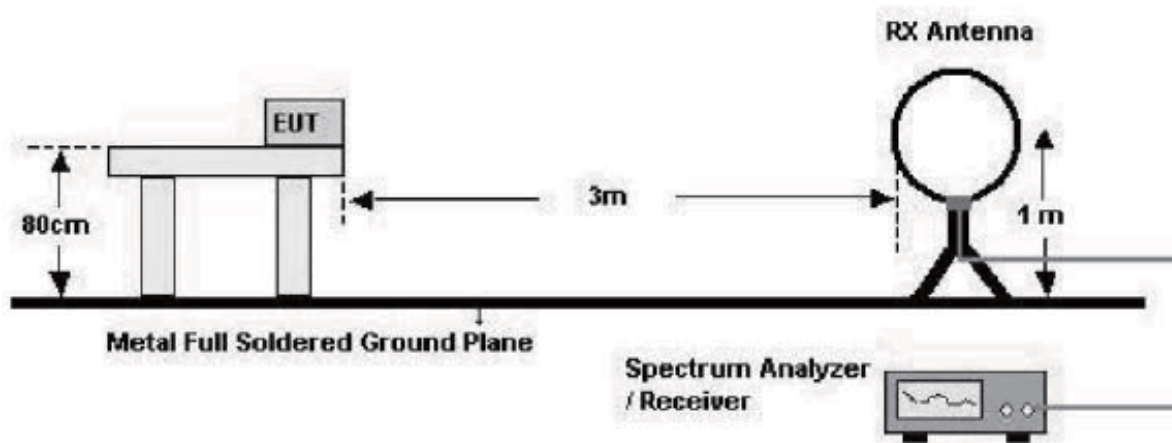

below 1 GHz (30 MHz to 1 GHz)

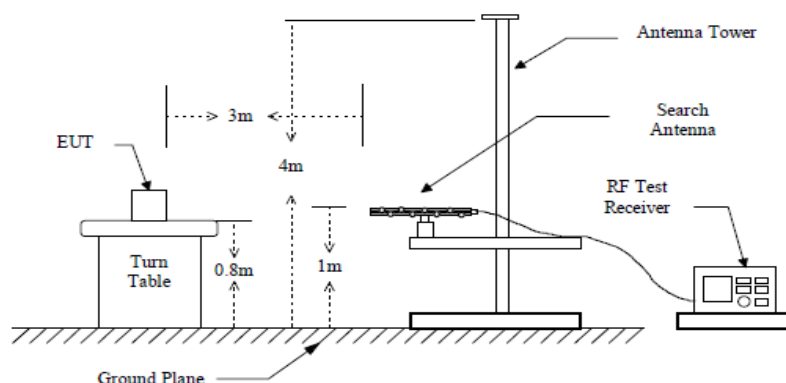

above 1 GHz

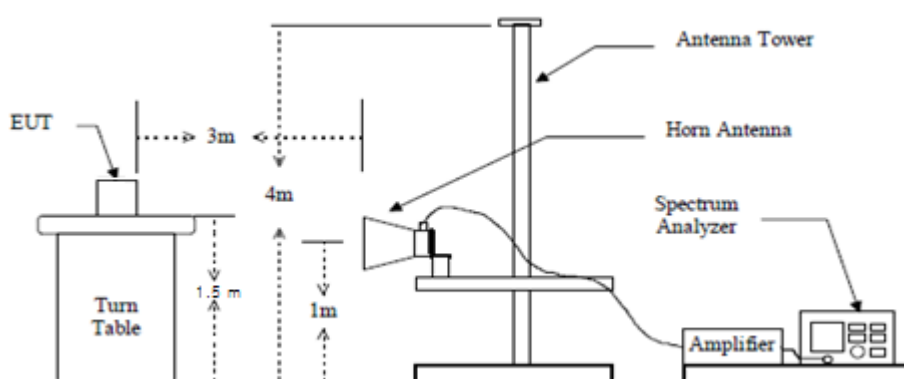

Measurement Data: **Complies**

- See next pages for actual measured data.
- 30 MHz or less Although these tests were performed other than open field test site, adequate comparison on measurements were confirmed against 10m open field test site. Therefore, sufficient tests were made to demonstrate that the alternative site produces results that correlated with the one of tests made in an open field site based on KDB 414788.
- No other emissions were detected at a level greater than 20 dB below limit include from 9 kHz to 30MHz.

Minimum Standard: FCC Part 15.209(a)

Frequency (MHz)	Limit (uV/m) @ 3 m
0.009 ~ 0.490	2400/F(kHz) (@ 300 m)
0.490 ~ 1.705	24000/F(kHz) (@ 30 m)
1.705 ~ 30	30(@ 30 m)
30 ~ 88	100 **
88 ~ 216	150 **
216 ~ 960	200 **
Above 960	500

** Except as provided in 15.209(g), fundamental emissions from intentional radiators operating under this Section shall not be located in the frequency bands 54-72 MHz, 76-88 MHz, 174-216 MHz or 470-806 MHz. However, operation within these frequency bands is permitted under other sections of this Part, e.g. 15.231 and 15.241.

Measurement Data : (9 kHz – 30 MHz)

Frequency [MHz]	Reading [dBuV/m]		Pol.	Correction Factor		Limits [dBuV/m]		Result [dBuV/m]		Margin [dB]	
	AV / Peak			Antenna	Amp.Gain+Cable	AV / Peak		AV / Peak		AV / Peak	
-	-	-	-	-	-	-	-	-	-	-	-
No emissions were detected at a level greater than 20 dB below limit.											
-	-	-	-	-	-	-	-	-	-	-	-
-	-	-	-	-	-	-	-	-	-	-	-

Measurement Data : (Below 1 GHz)

Frequency [MHz]	Reading [dBuV/m]		Pol.	Correction Factor		Limits [dBuV/m]	Result [dBuV/m]	Margin [dB]
	AV / Peak			Antenna	Amp.Gain+Cable			
141.35	53.10		V	-12.89		43.50	40.11	3.39
143.77	52.59		V	-12.85		43.50	39.74	3.76
142.95	51.73		V	-12.88		43.50	38.85	4.65
144.46	51.61		V	-12.80		43.50	38.81	4.69
130.84	52.73		V	-13.93		43.50	38.80	4.70
144.46	51.60		V	-12.80		43.50	38.80	4.70

Measurement Data : (Above 1 GHz)

Frequency [MHz]	Reading [dBuV/m]		Pol.	Correction Factor		Limits [dBuV/m]		Result [dBuV/m]		Margin [dB]	
	AV / Peak			Antenna	Amp.Gain+Cable	AV/Peak		AV/Peak		AV / Peak	
7334	36.70	46.70	V	-6.27		54	74	30.43	40.43	23.57	33.57
7195	39.63	49.63	V	-7.98		54	74	31.65	41.65	22.35	32.35
7439	35.40	43.00	V	-4.97		54	74	30.43	38.03	23.57	35.97
11017	33.43	43.73	V	-5.53		54	74	27.90	38.20	26.10	35.80
13012	11.33	24.77	V	14.84		54	74	26.17	39.61	27.83	34.39
12850	17.89	27.68	V	11.32		54	74	29.21	39.00	24.79	35.00

The eut configureal to transmit continuously(D ≥ 98%)

Radiated Emissions - (Below 1 GHz)



4, Songjuro 236Beon-gil, yanggi-myeon,
Yongin-si, Gyeonggi-do, Korea
Tel : +82-31-3236008,9
Fax : +82-31-3236010
www.ltalab.com

EUT/Model No.: I.M.LAB INC AK1G-BB(LOW) Temp/Humi: 23 / 36

Test Mode : BLE Tested by: KKH

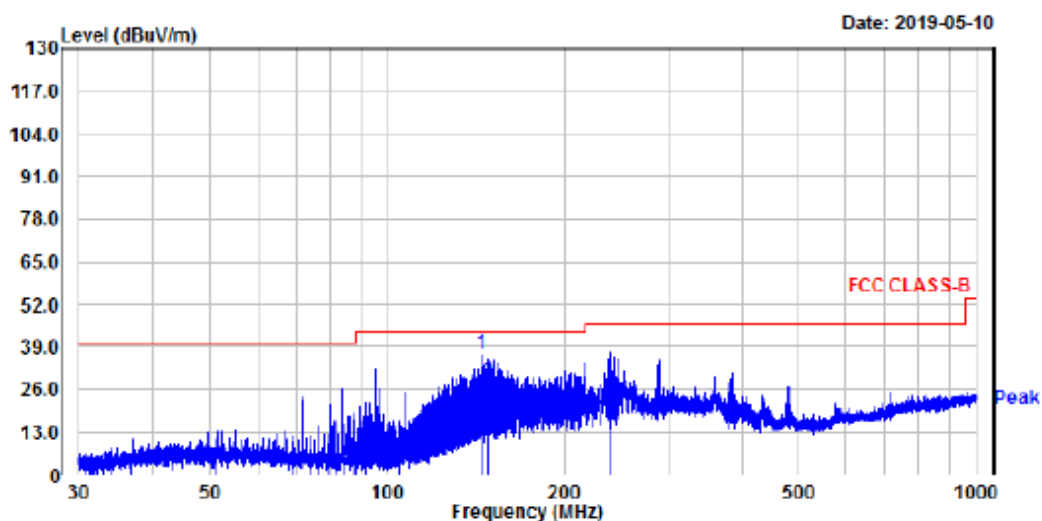

Freq MHz	Reading dBUV	C.F dB	Result PK dBUV/m	Limit dBUV/m	Margin dB	Height cm	Angle deg	Polarity
143.70	49.69	-12.85	36.84	43.50	6.66	0	94	horizontal
147.53	40.70	-12.56	28.14	43.50	15.36	0	148	horizontal
238.52	37.01	-13.61	23.40	46.00	22.60	0	175	horizontal

Remarks: C.F (Correction Factor) = Antenna factor + Cable loss - Preamp gain



4, Songjuro 236Beon-gil, yanggi-myeon,
 Yongin-si, Gyeonggi-do, Korea
 Tel : +82-31-3236008,9
 Fax : +82-31-3236010
 www.ltalab.com

EUT/Model No.: I.M.LAB INC AK1G-BB(LOW) Temp/Humi: 23 / 36

 Test Mode : BLE Tested by: KKH

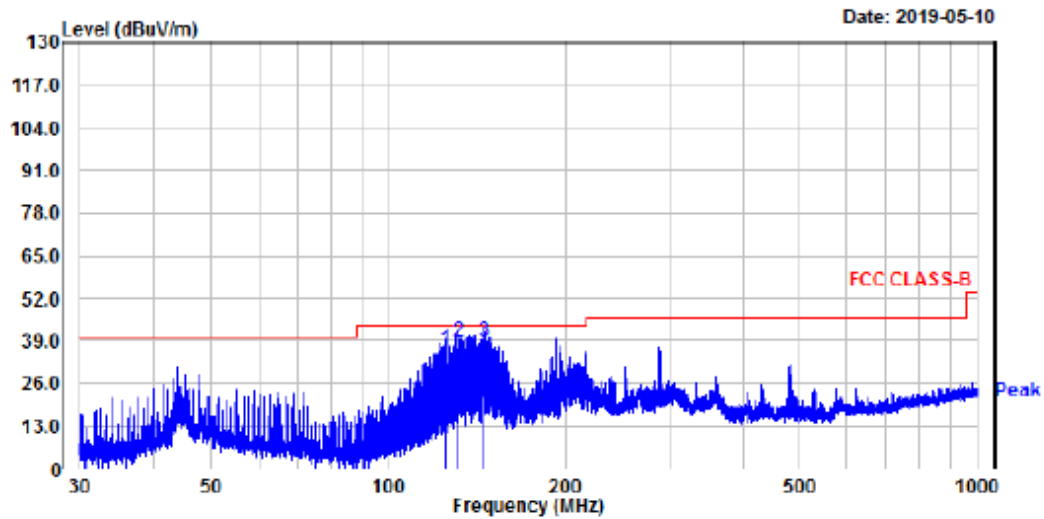

Freq MHz	Reading dBuV	C.F dB	Result PK dBuV/m	Limit dBuV/m	Margin dB	Height cm	Angle deg	Polarity
124.84	51.10	-14.60	36.50	43.50	7.00	0	198	vertical
130.84	52.73	-13.93	38.80	43.50	4.70	0	134	vertical
144.46	51.60	-12.80	38.80	43.50	4.70	0	102	vertical

Remarks: C.F (Correction Factor) = Antenna factor + Cable loss - Preamp gain



4, Songjuro 236Beon-gil, yanggi-myeon,
 Yongin-si, Gyeonggi-do, Korea
 Tel : +82-31-3236008,9
 Fax : +82-31-3236010
 www.ltalab.com

EUT/Model No.: I.M.LAB INC AK1G-BB(MID) Temp/Humi: 23 / 36

 Test Mode : BLE Tested by: KKH

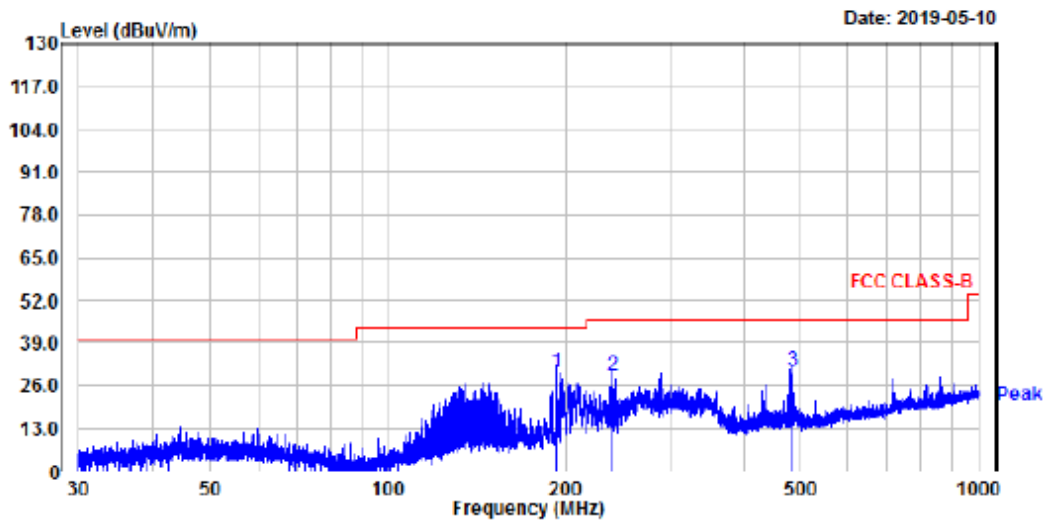

Freq MHz	Reading dBuV	C.F dB	Result PK dBuV/m	Limit dBuV/m	Margin dB	Height cm	Angle deg	Polarity
192.00	45.19	-15.05	30.14	43.50	13.36	0	226	horizontal
239.99	42.28	-13.50	28.78	46.00	17.22	0	262	horizontal
482.00	37.74	-7.53	30.21	46.00	15.79	0	197	horizontal

Remarks: C.F (Correction Factor) = Antenna factor + Cable loss - Preamp gain



4, Songjuro 236Beon-gil, yanggi-myeon,
 Yongin-si, Gyeonggi-do, Korea
 Tel : +82-31-3236008,9
 Fax : +82-31-3236010
 www.ltalab.com

EUT/Model No.: I.M.LAB INC AK1G-BB(MID) Temp/Humi: 23 / 36

 Test Mode : BLE Tested by: KKH

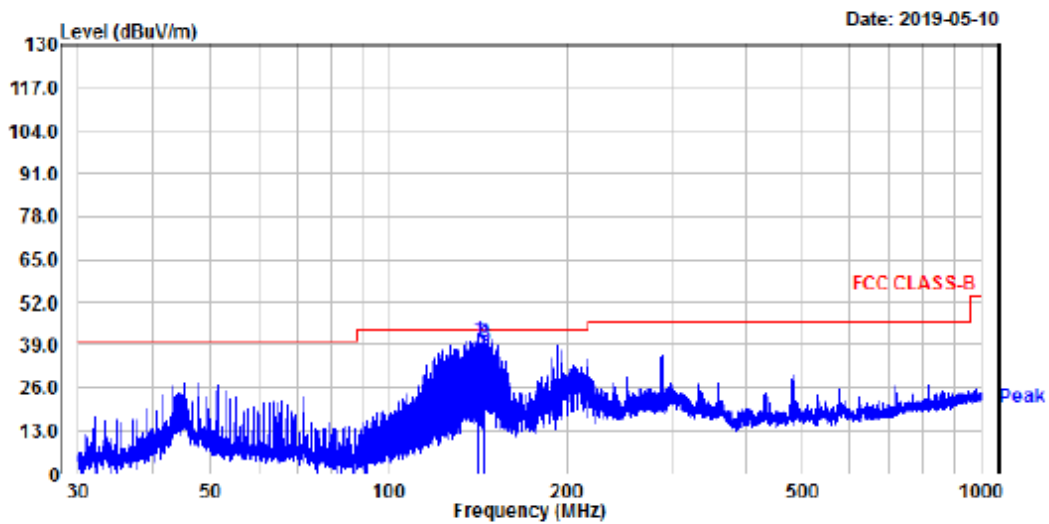

Freq MHz	Reading dBuV	C.F dB	Result PK dBuV/m	Limit dBuV/m	Margin dB	Height cm	Angle deg	Polarity
141.45	53.10	-12.99	40.11	43.50	3.39	0	109	vertical
143.77	52.59	-12.85	39.74	43.50	3.76	0	109	vertical
145.29	51.47	-12.71	38.76	43.50	4.74	0	239	vertical

Remarks: C.F (Correction Factor) = Antenna factor + Cable loss - Preamp gain



4, Songjuro 236Beon-gil, yanggi-myeon,
 Yongin-si, Gyeonggi-do, Korea
 Tel : +82-31-3236008,9
 Fax : +82-31-3236010
 www.ltalab.com

EUT/Model No.: I.M.LAB INC AK1G-BB(HIGH) Temp/Humi: 23 / 36

 Test Mode : BLE Tested by: KKH

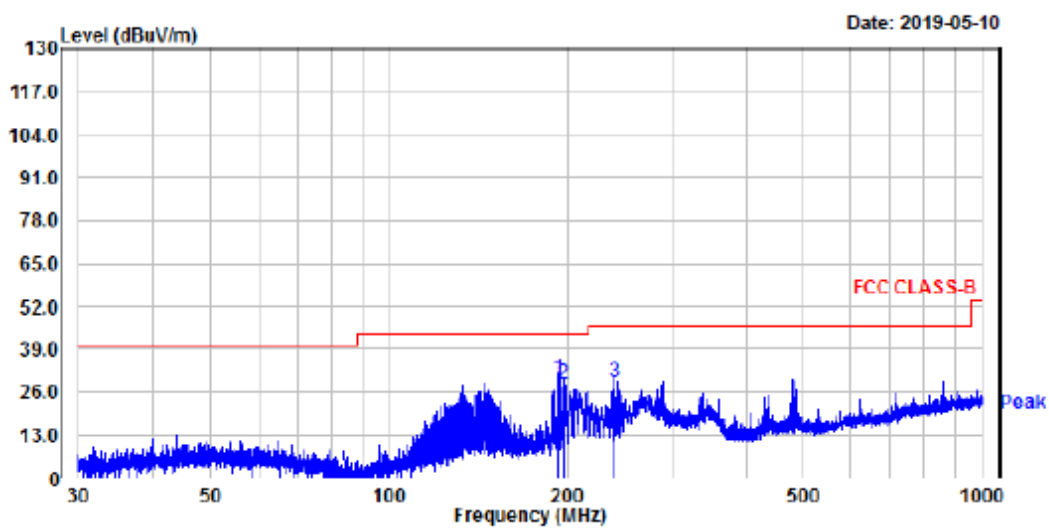

Freq MHz	Reading dBuV	C.F dB	Result PK dBuV/m	Limit dBuV/m	Margin dB	Height cm	Angle deg	Polarity
192.00	45.06	-15.05	30.01	43.50	13.49	0	120	horizontal
196.42	43.80	-15.20	28.60	43.50	14.90	0	158	horizontal
239.99	42.59	-13.50	29.09	46.00	16.91	0	341	horizontal

Remarks: C.F (Correction Factor) = Antenna factor + Cable loss - Preamp gain



4, Songjuro 236Beon-gil, yanggi-myeon,
 Yongin-si, Gyeonggi-do, Korea
 Tel : +82-31-3236008,9
 Fax : +82-31-3236010
 www.ltalab.com

EUT/Model No.: I.M.LAB INC AK1G-BB(HIGH) Temp/Humi: 23 / 36

 Test Mode : BLE Tested by: KKH

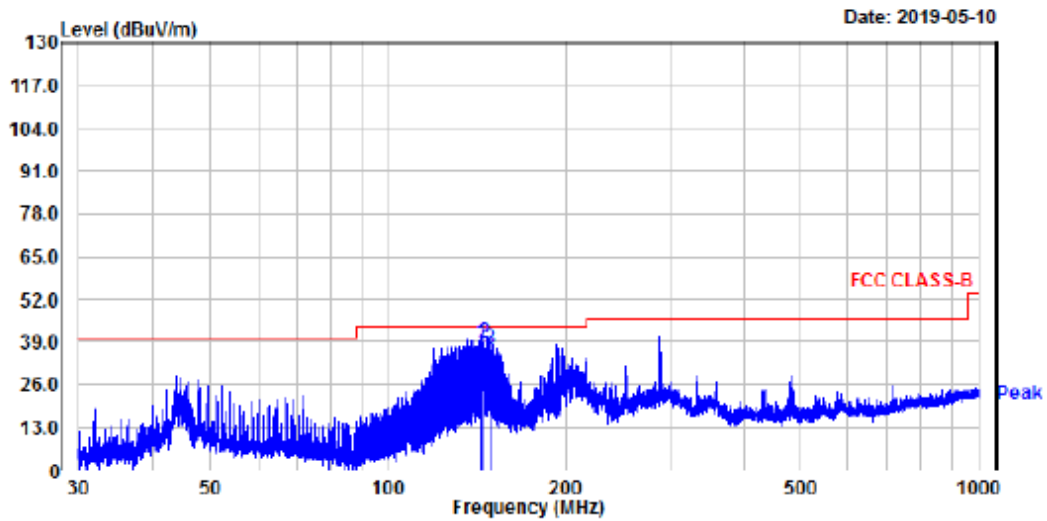

Freq MHz	Reading dBuV	C.F dB	Result PK dBuV/m	Limit dBuV/m	Margin dB	Height cm	Angle deg	Polarity
142.95	51.73	-12.88	38.85	43.50	4.65	0	259	vertical
144.46	51.61	-12.80	38.81	43.50	4.69	0	319	vertical
148.25	49.40	-12.50	36.90	43.50	6.60	0	98	vertical

Remarks: C.F (Correction Factor) = Antenna factor + Cable loss - Preamp gain

Radiated Emissions - (Above 1 GHz)



EMI Chamber of LTA CO.,LTD.
 4, Songjeuro236Beon-gil, Yangji-myeon,
 Yongin-si, Gyeonggi-do, Korea Autho by NVLAP
 Tel :+82-31-3236008,9 www.ltalab.com
 Fax:+82-31-3236010

EUT/Model No.: AK1C-BB Test Mode: BLE (LOW)
 Tested by : KO K H Temp/Humi: 22 / 62

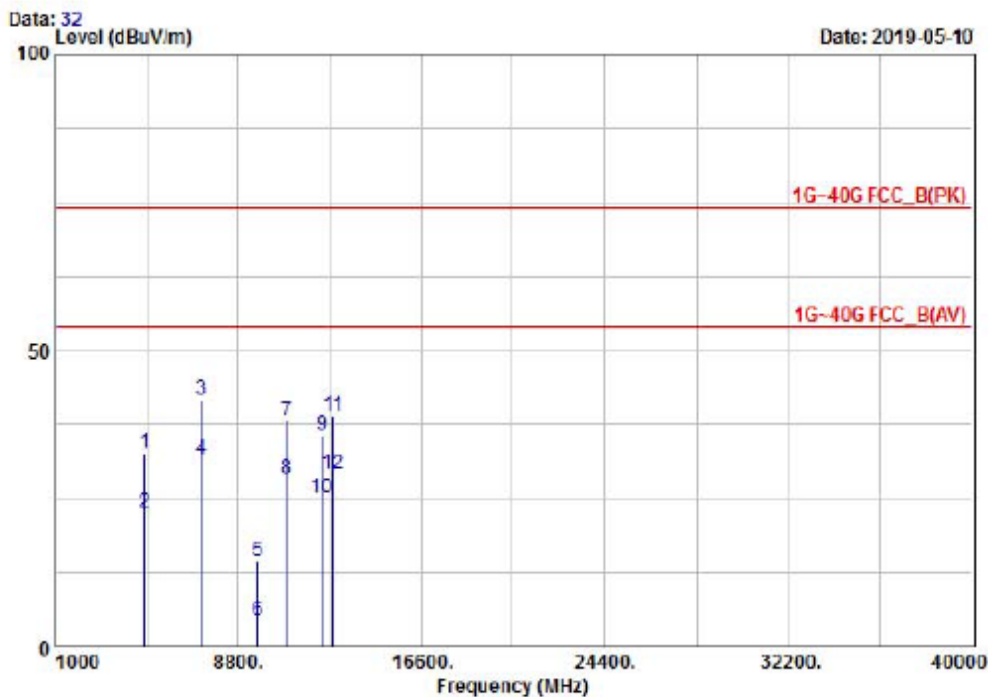

Line	Freq (MHz)	Level (dBuV/m)	CF (dB)	Antenna Factor (dB)	Cable Loss (dB)	Preamp Gain (dB)	Orientation
1	4788.00	47.64	-16.06	32.58	74.00	41.42	HORIZONTAL
2	4788.00	37.64	-16.06	22.58	54.00	31.42	HORIZONTAL
3	7196.00	49.63	-7.98	41.65	74.00	32.35	VERTICAL
4	7196.00	39.63	-7.98	31.65	54.00	22.35	VERTICAL
5	9601.00	22.71	-8.35	14.36	74.00	59.64	VERTICAL
6	9601.00	12.71	-8.35	4.36	54.00	49.64	VERTICAL
7	10850.00	43.93	-5.83	38.10	74.00	35.90	HORIZONTAL
8	10850.00	34.04	-5.83	28.21	54.00	25.79	HORIZONTAL
9	12350.00	33.96	1.64	35.60	74.00	38.40	HORIZONTAL
10	12350.00	23.48	1.64	25.12	54.00	28.88	HORIZONTAL
11	12950.00	27.68	11.32	39.00	74.00	35.00	HORIZONTAL
12	12850.00	17.89	11.32	29.21	54.00	24.79	HORIZONTAL

Remarks: C.F (Correction Factor) = Antenna factor + Cable loss - Preamp gain
 Blue : Vertical Black : Horizontal



EMI Chamber of LTA CO., LTD.
 4, Songjuro236Beon-gil, Yangji-myeon,
 Yongin-si, Gyeonggi-do, Korea Autho by NVLAP
 Tel :+82-31-3236008,9 www.ltalab.com
 Fax:+82-31-3236010

EUT/Model No.: AK1G-BB Test Mode: BLE (MID)
 Tested by : KO R H Temp/Humi: 22 / 62

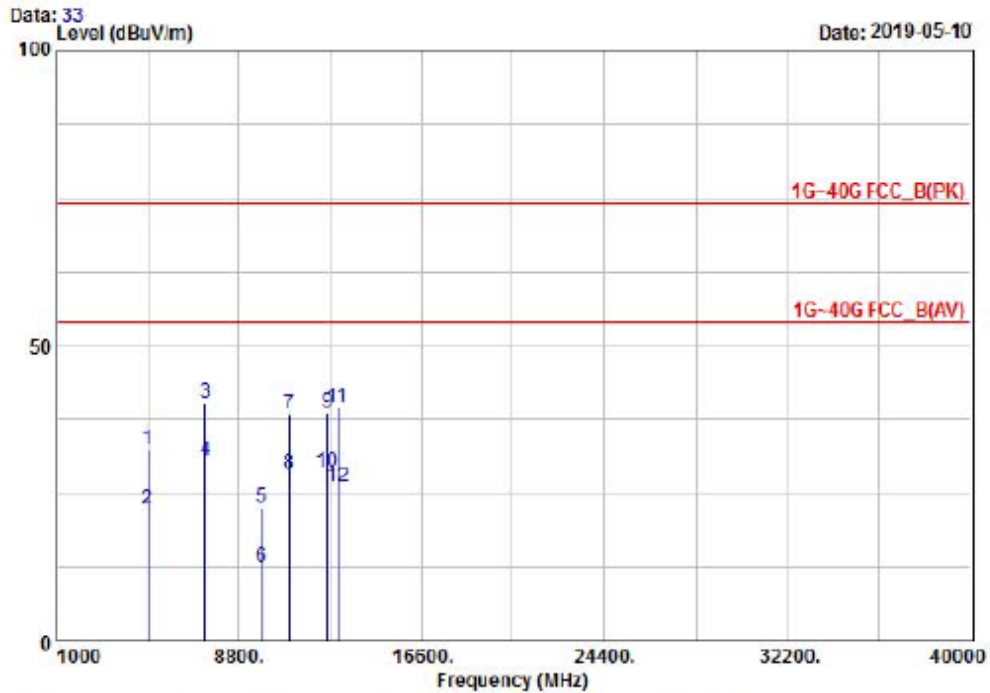

1	2	3	4	5	6	7	8	9	10	11	12
4893.00	4893.00	7334.00	7334.00	9776.00	9776.00	710971.00	910971.00	912567.00	1012567.00	1113012.00	1213012.00
47.34	37.34	46.70	36.70	31.03	21.03	44.10	33.84	34.29	24.08	24.77	11.33
-15.02	-15.02	-6.27	-6.27	-8.51	-8.51	-5.60	-5.60	4.52	4.52	14.84	14.84
32.32	22.32	40.43	30.43	22.52	12.62	38.50	29.24	38.81	28.60	39.61	26.17
74.00	54.00	74.00	54.00	74.00	54.00	74.00	54.00	74.00	54.00	74.00	54.00
41.68	31.68	33.57	23.57	51.48	41.48	35.50	25.76	35.19	25.40	34.39	27.83
HORIZONTAL	HORIZONTAL	VERTICAL	VERTICAL	VERTICAL	VERTICAL	HORIZONTAL	HORIZONTAL	HORIZONTAL	HORIZONTAL	HORIZONTAL	HORIZONTAL

Remarks: C.F (Correction Factor) = Antenna factor + Cable loss - Preamp gain
 Blue : Vertical Black : Horizontal



EMI Chamber of LTA CO., LTD.
 4, Songjuro236Beon-gil, Yangji-myeon,
 Yongin-si, Gyeonggi-do, Korea Autho by NVLAP
 Tel :+82-31-3236008,9 www.ltalab.com
 Fax:+82-31-3236010

EUT/Model No.: AK1C-BB Test Mode: BLE (HIGH)
 Tested by : KO K H Temp/Humi: 22 / 62

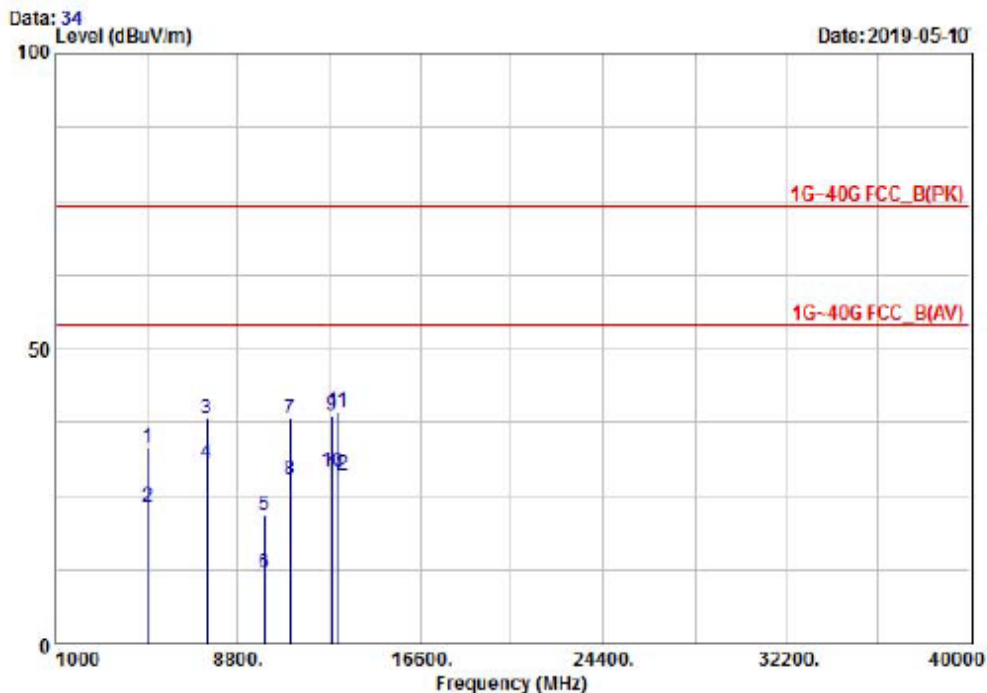

1	4963.00	49.11	-15.00	33.11	74.00	40.89	HORIZONTAL
2	4963.00	38.11	-15.00	23.11	54.00	30.89	HORIZONTAL
3	7439.00	43.00	-4.97	38.03	74.00	36.97	VERTICAL
4	7439.00	35.40	-4.97	30.43	54.00	23.57	VERTICAL
5	9915.00	30.53	-8.64	21.89	74.00	52.11	VERTICAL
6	9915.00	20.59	-8.64	11.95	54.00	42.06	VERTICAL
7	11017.00	43.73	-5.53	38.20	74.00	35.80	HORIZONTAL
8	11017.00	33.43	-5.53	27.90	54.00	26.10	HORIZONTAL
9	12813.00	28.27	10.43	38.70	74.00	35.30	HORIZONTAL
10	12813.00	18.77	10.43	25.20	54.00	24.80	HORIZONTAL
11	13071.00	24.76	14.44	39.20	74.00	34.80	HORIZONTAL
12	13071.00	14.16	14.44	28.60	54.00	25.40	HORIZONTAL

Remarks: C.F (Correction Factor) = Antenna factor + Cable loss - Preamp gain
 Blue : Vertical Black : Horizontal

3.2.7 AC Conducted Emissions

Procedure:

The conducted emissions are measured in the shielded room with a spectrum analyzer in peak hold. While the measurement, EUT had its hopping function disabled at the middle channels in line with Section 15.31(m). Emissions closest to the limit are measured in the quasi-peak mode (QP) with the tuned receiver using a bandwidth of 9 kHz. The emissions are maximized further by cable manipulation and Exerciser operation. The highest emissions relative to the limit are listed.

Measurement Data: NT

Minimum Standard: FCC Part 15.207(a) / EN 55022

Frequency Range	quasi-peak	Average
0.15 ~ 0.5	66 to 56 *	56 to 46 *
0.5 ~ 5	56	46
5 ~ 30	60	50

* Note: This product operates only with battery

APPENDIX
TEST EQUIPMENT USED FOR TESTS

	Use	Description	Model No.	Serial No.	Manufacturer	Interval	Last Cal. Date
1		Signal Analyzer (9 kHz ~ 30 GHz)	FSV30	100757	R&S	1 year	2018-09-06
2		SYNTHESIZED CW GENERATOR	83711B	US34490456	HP	1 year	2019-03-16
3		Attenuator (3 dB)	8491A	37822	HP	1 year	2018-09-07
4		Attenuator (10 dB)	8491A	63196	HP	1 year	2018-09-07
5	■	EMI Test Receiver (~7 GHz)	ESC17	100722	R&S	1 year	2018-09-07
6		RF Amplifier (~1.3 GHz)	8447D OPT 010	2944A07684	HP	1 year	2018-09-07
7	■	RF Amplifier (1~26.5 GHz)	8449B	3008A02126	HP	1 year	2019-03-21
8	■	Horn Antenna (1~18 GHz)	3115	00114105	ETS	2 year	2018-09-26
9		DRG Horn (Small)	3116B	81109	ETS-Lindgren	2 year	2018-05-03
10		DRG Horn (Small)	3116B	133350	ETS-Lindgren	2 year	2018-05-03
11	■	TRILOG Antenna	VULB 9160	9160-3237	SCHWARZBECK	2 year	2019-04-17
12		Temp.Humidity Data Logger	SK-L200TH II A	00801	SATO	1 year	2018-11-23
13	■	DC Power Supply	6674A	3637A01657	Agilent	-	-
14		AC Power Supply	HK-80	LR001	DAERIMTECH	-	-
15	■	Power Meter	EPM-441A	GB32481702	HP	1 year	2019-03-20
16	■	Power Sensor	8481A	3318A94972	HP	1 year	2018-12-26
17		Audio Analyzer	8903B	3729A18901	HP	1 year	2018-09-07
18		Modulation Analyzer	8901B	3749A05878	HP	1 year	2018-09-07
19	■	TEMP & HUMIDITY Chamber	YJ-500	LTAS06041	JinYoung Tech	1 year	2018-09-07
20		Stop Watch	HS-3	812Q08R	CASIO	2 year	2019-03-21
21		LISN	KNW-407	8-1430-1	Kyoritsu	1 year	2018-09-07
22		Two-Lime V-Network	ESH3-Z5	893045/017	R&S	1 year	2019-03-20
23		Highpass Filter	WHKX1.5/15G-10SS	74	Wainwright Instruments	1 year	2019-03-19
24		Highpass Filter	WHKX3.0/18G-10SS	118	Wainwright Instruments	1 year	2019-03-19
25		OSP120 BASE UNIT	OSP120	101230	R&S	1 year	2019-03-21
26	■	Signal Generator(100 kHz ~ 40 GHz)	SMB100A	177621	R&S	1 year	2019-03-20
27		Vector Signal Generator(9kHz ~ 6 GHz)	SMBV100A	255081	R&S	1 year	2019-03-20
28	■	Signal Analyzer (10 Hz ~ 40 GHz)	FSV40	101367	R&S	1 year	2019-03-20