

EMC Test Report

Applicant : Plasma Cloud Limited
Product Type : WiFi Access Point
Trade Name : Plasma Cloud
Model Number : PA300E
Applicable Standard : FCC 47 CFR PART 15 SUBPART B
ANSI C63.4: 2014
Receive Date : Apr. 12, 2019
Test Period : May 14 ~ May 20, 2019
Issue Date : Aug. 02, 2019

Issue by

A Test Lab Techno Corp.
No. 140-1, Changan Street, Bade District,
Taoyuan City 33465, Taiwan (R.O.C.)
Tel : +886-3-2710188 / Fax : +886-3-2710190



Taiwan Accreditation Foundation accreditation number: 1330
Test Firm MRA designation number: TW1062

Note:

- 1.The test results are valid only for samples provided by customers and under the test conditions described in this report.
- 2.This report shall not be reproduced except in full, without the written approval of A Test Lab Technology Corporation.
- 3.The relevant information is provided by customers in this test report. According to the correctness, appropriateness or completeness of the information provided by the customer, if there is any doubt or error in the information which affects the validity of the test results, the laboratory does not take the responsibility.



Revision History

Rev.	Issue Date	Revisions	Revised By
00	Aug. 02, 2019	Initial Issue	Serene Yang

Verification of Compliance

Issued Date: Aug. 02, 2019

Applicant : Plasma Cloud Limited

Product Type : WiFi Access Point

Trade Name : Plasma Cloud

Model Number : PA300E

EUT Rated Voltage : DC 12-24 V, 1 A (DC Power Adapter)
DC 24 V, 1 A (passive PoE injector)
DC 48-54 V, 0.5 A (PoE injector (802.3af/at))

Test Voltage : 120 Vac / 60 Hz

Applicable Standard : FCC 47 CFR PART 15 SUBPART B
ANSI C63.4: 2014

Test Result : Complied

Performing Lab. : A Test Lab Techno Corp.
No. 140-1, Changan Street, Bade District,
Taoyuan City 33465, Taiwan (R.O.C.)
Tel : +886-3-2710188 / Fax : +886-3-2710190
Taiwan Accreditation Foundation accreditation number: 1330
<http://www.atl-lab.com.tw/e-index.htm>



The above equipment has been tested by A Test Lab Techno Corp., and found compliance with the requirements set forth in the technical standards mentioned above. The results of testing in this report apply only to the product/system, which was tested. Other similar equipment will not necessarily produce the same results due to production tolerance and measurement uncertainties.

Approved By : Terry Liao Reviewed By : Misty Wu
(Manager) (Terry Liao) (Testing Engineer) (Misty Wu)



TABLE OF CONTENTS

1	General Information	5
1.1.	Summary of Test Result	5
1.2.	Testing Location	5
1.3.	Measurement Uncertainty	6
1.4.	Test Site Environment	6
2	EUT Description	7
3	Test Methodology	8
3.1.	Decision of Test Mode	8
3.2.	EUT Test Step	8
3.3.	Configuration of Test System Details.....	9
3.4.	Test Instruments.....	11
4	Measurement Procedure	12
4.1.	Conducted Emission	12
4.2.	Radiated Emission	14
5	Test Results.....	17
5.1.	Conducted Emission	17
5.2.	Radiated Emission	22

1 General Information

1.1. Summary of Test Result

Emission			
Standard	Item	Verdict	Remark
FCC 47 CFR PART 15 SUBPART B ANSI C63.4	Conducted Emission	PASS	Meet Class B limit
FCC 47 CFR PART 15 SUBPART B ANSI C63.4	Radiated Emission	PASS	Meet Class B limit

The test results of this report was related only to the tested sample(s) identified in this report.

1.2. Testing Location

Site Name: A Test Lab Techno Corp.

<http://www.atl-lab.com.tw/e-index.htm>

Site Address: No. 140-1, Changan Street, Bade District, Taoyuan City 33465, Taiwan (R.O.C.)

Tel : +886-3-2710188

Fax : +886-3-2710190

1.3. Measurement Uncertainty

Test Item		Frequency Range	Uncertainty (dB)
Conducted Emission	AC Power Port	9 kHz ~ 150 kHz	2.7
		150 kHz ~ 30 MHz	2.7

Test Item	Test Site	Frequency Range	Uncertainty (dB)	
Radiated Emission	TE06	30 MHz ~ 1000 MHz	Horizontal	5.6
			Vertical	6.0
	TE01	1000 MHz ~ 6000 MHz	6000 MHz ~ 18000 MHz	5.5
			18000 MHz ~ 26500 MHz	4.8
			26500 MHz ~ 40000 MHz	4.8
			1000 MHz ~ 6000 MHz	4.9
	TE09	6000 MHz ~ 18000 MHz	18000 MHz ~ 26500 MHz	4.5
			26500 MHz ~ 40000 MHz	4.8
			1000 MHz ~ 6000 MHz	4.9
			6000 MHz ~ 18000 MHz	5.3

Note: The Vertical and Horizontal measurement uncertainty of 1 GHz to 40 GHz is evaluated and choose which polarity is worst value.

Decision Rule

- Uncertainty is not included.
- Uncertainty is included.

1.4. Test Site Environment

Test Item	Items	Required (IEC 60068-1)	Actual
Conducted Emission	Temperature (°C)	15-35	26
	Humidity (%RH)	25-75	60
	Barometric pressure (mbar)	860-1060	990
Radiated Emission	Temperature (°C)	15-35	26
	Humidity (%RH)	25-75	60
	Barometric pressure (mbar)	860-1060	990

2 EUT Description

Applicant	Plasma Cloud Limited 5/F, Yat Chau Building 262 Des Voeux Road Central Hong Kong
Manufacturer	Emplus Technologies, Inc. Bldg. B, 10F., No.209, Sec. 1, Nangang Rd., Nangang Dist., Taipei City 11568, Taiwan
Product Type	WiFi Access Point
Trade Name	Plasma Cloud
Model Number	PA300E
I/O Ports	Refer to User Manual
Highest Operating Frequency	2483.5 MHz

EUT Modify Description :

Modify Description: Change model number, FCC ID and external antenna. After our evaluation, the changes do not affect the test results. Please refer to the Original Report: 1906FE15.
Original Report : 1905FE21 Modify : 1907FE32

3 Test Methodology

3.1. Decision of Test Mode

3.1.1. The following test mode(s) were scanned during the preliminary test:

Pre-Test Mode	
Mode 1: LAN + WiFi Link with AC Adapter mode (PA1024-120HUB200)	
Mode 2: LAN + WiFi Link with PoE Adapter mode (EPA2406GR)	

3.1.2. After the preliminary scan, the following test mode was final mode and found to produce the highest emission level.

Final Test Mode			
Emission	Conducted Emission		Mode 1 / Mode 2
	Radiated Emission	Below 1 GHz	Mode 1 / Mode 2
		Above 1 GHz	Mode 1 / Mode 2

The above highest emission mode of the configuration of the EUT and cable was chosen for all final test items.

3.2. EUT Test Step

1	Turn on the power of all equipment.
2	Notebook link to EUT by LAN.
3	Notebook link to EUT by Wi-Fi.
4	Data will communicate between Notebook and Notebook through EUT.
5	Start to test and get the worst reading.

Measurement Software			
No.	Description	Software	Version
1	Conducted Emission	EZ EMC	1.1.4.3
2	Radiated Emission _ Below 1 GHz	EZ EMC	1.1.4.2
3	Radiated Emission _ Above 1 GHz	EZ EMC	1.1.4.4

3.3. Configuration of Test System Details

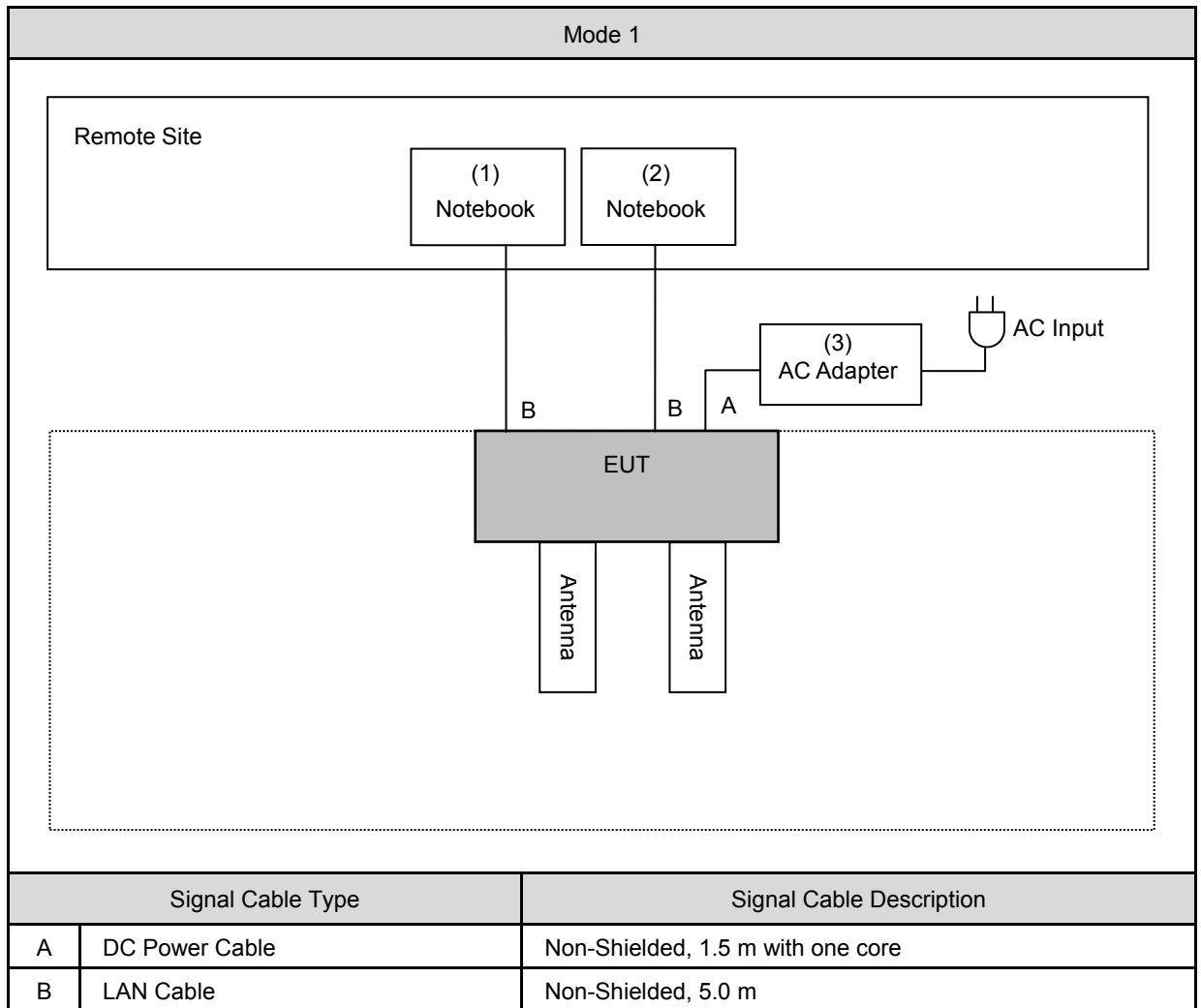

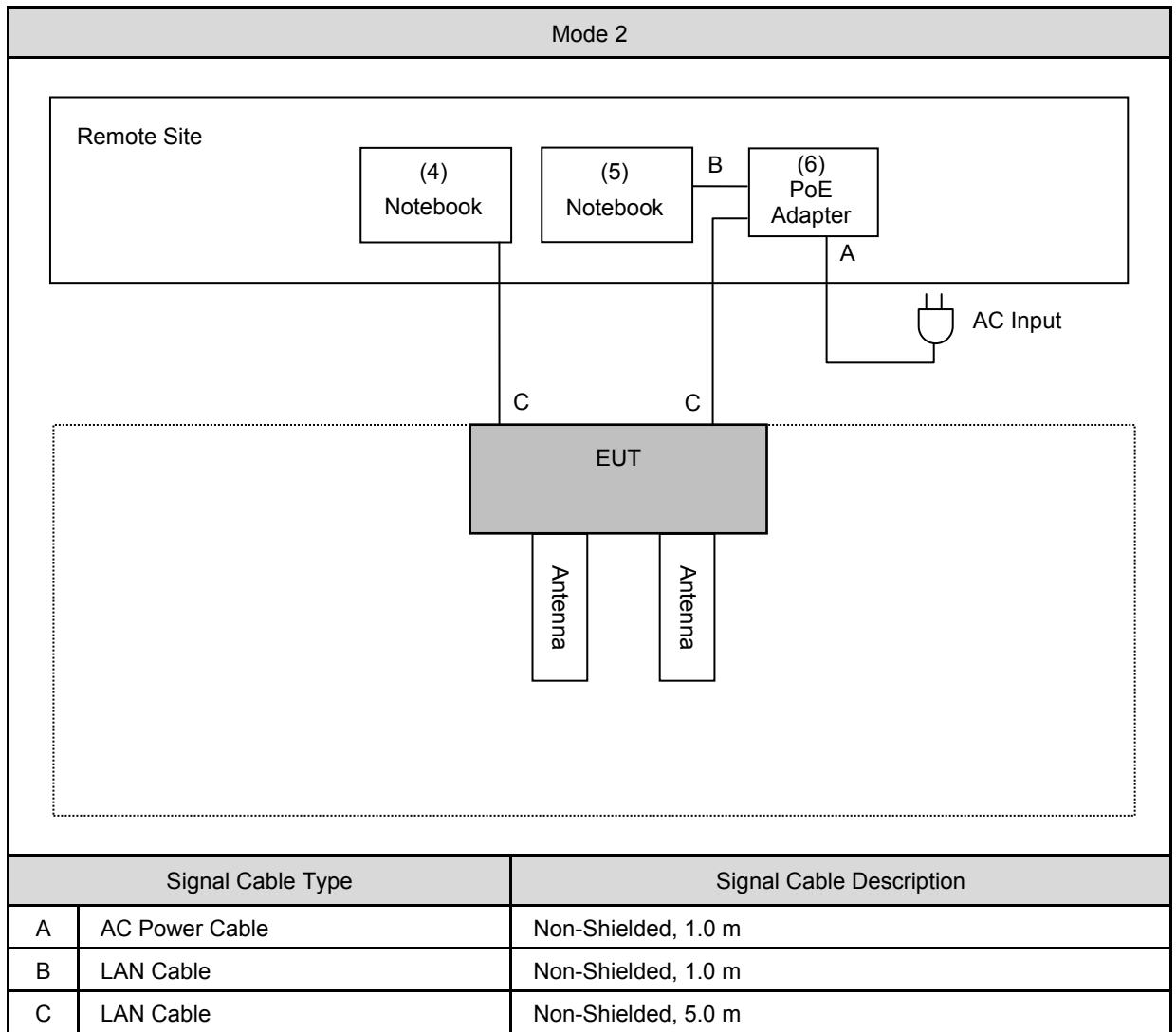

Devices Description					
	Product	Manufacturer	Model Number	Serial Number	Power Cord
(1)	Notebook	DELL	LATITUDE E5440	25627158361	Non-Shielded, 1.8 m
(2)	Notebook	DELL	LATITUDE E5440	6699565657	Non-Shielded, 1.8 m
(3)	AC adapter	Powertron Electronics Corp.	PA1024-120HUB200	N/A	N/A
(4)	Notebook	DELL	LATITUDE E5440	25627158361	Non-Shielded, 0.8 m
(5)	Notebook	DELL	LATITUDE E5440	6699565657	Non-Shielded, 0.8 m
(6)	PoE Adapter	EnGenius	EPA2406GR	177214704	Non-Shielded, 1.0 m



3.4. Test Instruments

Test Period : May 14, 2019

Conducted Emission test site					
Equipment	Manufacturer	Model Number	Serial Number	Cal. Date	Cal. Period
Test Receiver	R&S	ESCI	100367	05/21/2018	1 year
LISN	R&S	ENV216	101040	04/03/2019	1 year
LISN	R&S	ENV216	101041	03/28/2019	1 year
Test Site	ATL	TE02	TE02	N.C.R.	-----

Test Period : May 20, 2019

Radiated Emission - 10 Meter Chamber					
Equipment	Manufacturer	Model Number	Serial Number	Cal. Date	Cal. Period
Amplifier	EMCI	EMC9135	980298	10/24/2018	1 year
Amplifier	EMCI	EMC9135	980299	11/29/2018	1 year
Test Receiver	R&S	ESCI	100722	10/24/2018	1 year
Test Receiver	R&S	ESCI	101000	12/03/2018	1 year
Broadband Antenna	SCHWARZBECK MESS-ELEKTRONIK	VULB 9168	670	10/23/2018	1 year
Broadband Antenna	SCHWARZBECK MESS-ELEKTRONIK	VULB 9168	671	12/03/2018	1 year
Test Site	ATL	TE06	TE06	10/21/2018	1 year

Test Period : May 15, 2019

Radiated Emission - 3 Meter Chamber					
Equipment	Manufacturer	Model Number	Serial Number	Cal. Date	Cal. Period
Spectrum Analyzer	Agilent	E4445A	MY46181986	05/28/2018	1 year
Amplifier	Agilent	8449B	3008A02456	03/20/2019	1 year
Double Ridged Horn Antenna (1~18 GHz)	ETS	3117	00152321	09/27/2018	1 year
Test Site	ATL	TE09	TE09	04/11/2019	1 year

Note: N.C.R. = No Calibration Request.

4 Measurement Procedure

4.1. Conducted Emission

■ Test Setup

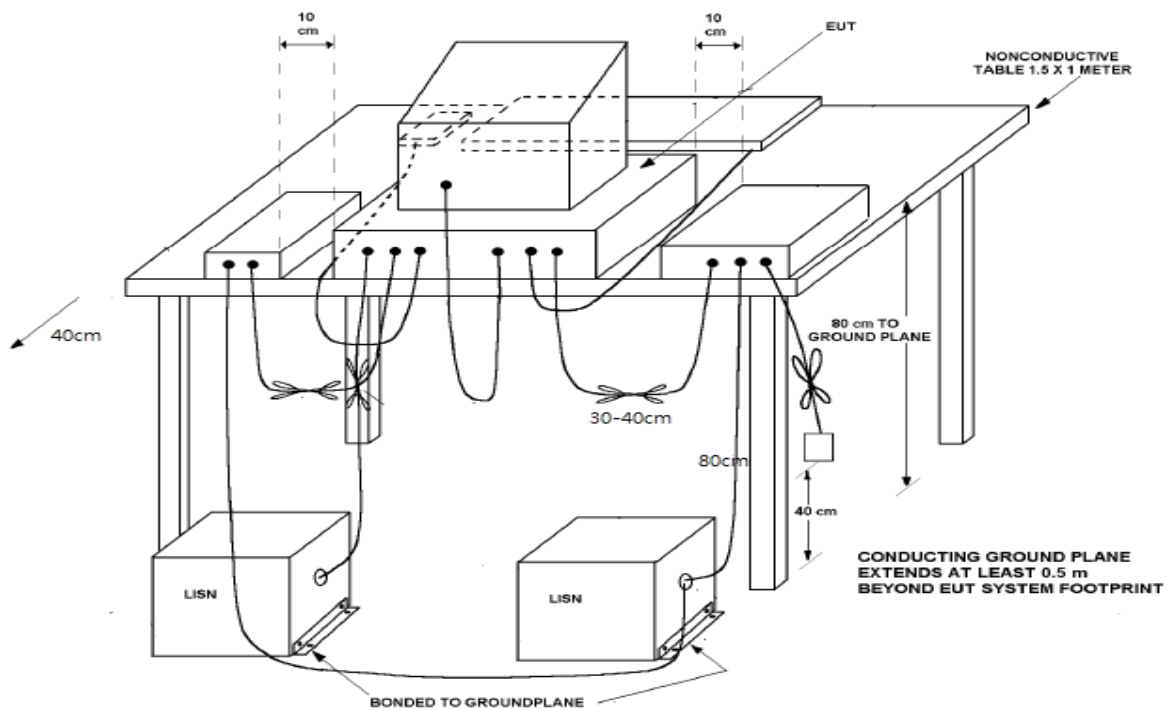
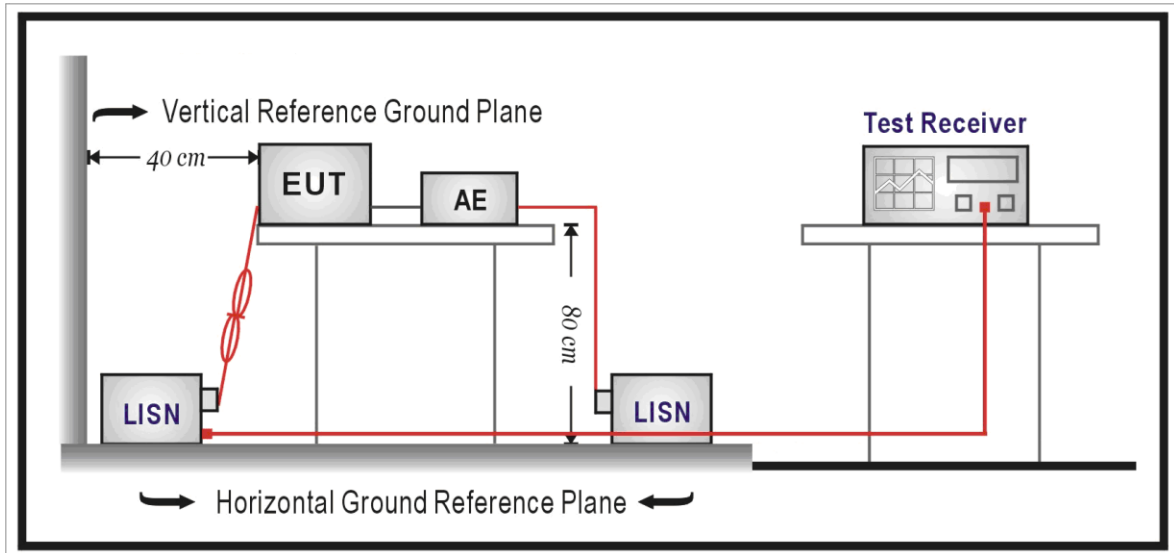

■ Test Procedure

The EUT and simulators are connected to the main power through a line impedance stabilization network (L.I.S.N.). This provides a 50 Ω // 50 μ H coupling impedance for the measuring equipment. The peripheral devices are also connected to the main power through a LISN that provides a 50 Ω // 50 μ H coupling impedance with 50ohm termination.

Tabletop device shall be placed on a non-conducting platform, of nominal size 1 m by 1.5 m, raised 80 cm above the reference ground plane. The wall of screened room shall be located 40cm to the rear of the EUT. Other surfaces of tabletop or floor standing EUT shall be at least 80cm from any other ground conducting surface including one or more LISNs. For floor-standing device shall be placed under the EUT with a 12 mm insulating material.

Conducted emissions were investigated over the frequency range from 0.15 MHz to 30 MHz using a resolution bandwidth of 9 kHz. The equipment under test (EUT) shall be meet the limits in section 4.1.1, as applicable, including the average limit and the quasi-peak limit when using respectively, an average detector and quasi-peak detector measured in accordance with the methods described of related standard. When all of peak value were complied with quasi-peak and average limit from 150 kHz to 30 MHz then quasi-peak and average measurement was unnecessary.

The AMN shall be placed 0,8 m from the boundary of the unit under test and bonded to a ground reference plane for AMNs mounted on top of the ground reference plane. This distance is between the closest points of the AMN and the EUT. All other units of the EUT and associated equipment shall be at least 0,8 m from the AMN. If the mains power cable is longer than 1m then the cable shall be folded back and forth at the centre of the lead to form a bundle no longer than 0.4 m. All of interconnecting cables that hang closer than 40 cm to the ground plane shall be folded back and forth in the center forming a bundle 30 cm to 40 cm long. All of EUT and AE shall be separate place more than 0.1 m. All 50 Ω ports of the LISN shall be resistively terminated into 50 Ω loads when not connected to the measuring instrument.

If the reading of the measuring receiver shows fluctuations close to the limit, the reading shall be observed for at least 15 s at each measurement frequency; the higher reading shall be recorded with the exception of any brief isolated high reading which shall be ignored.

4.2. Radiated Emission

■ Test Setup

Below 1 GHz

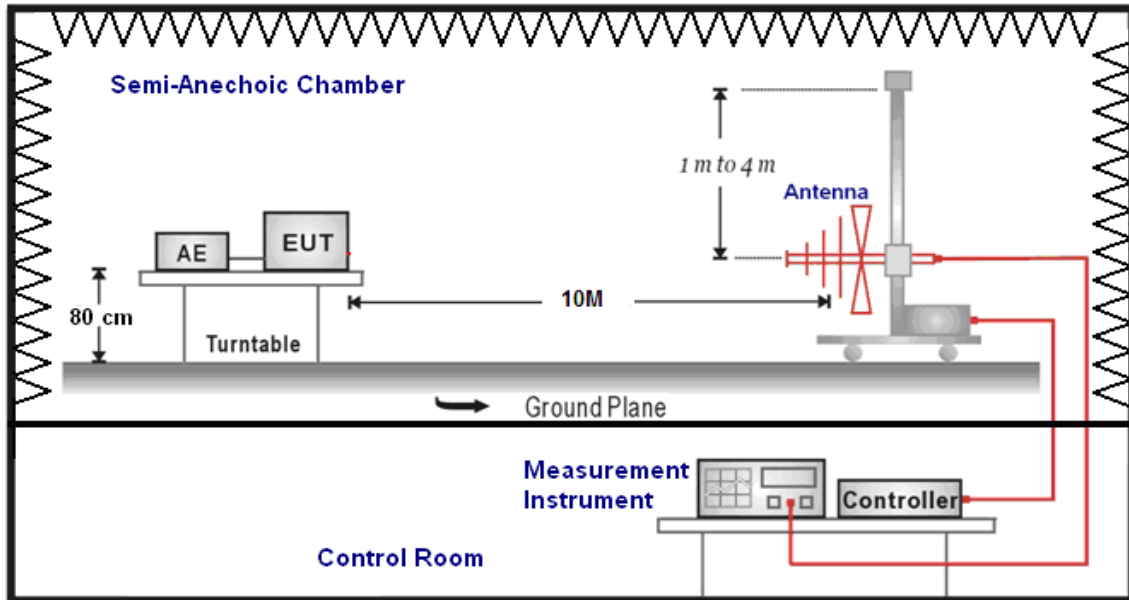

Above 1 GHz

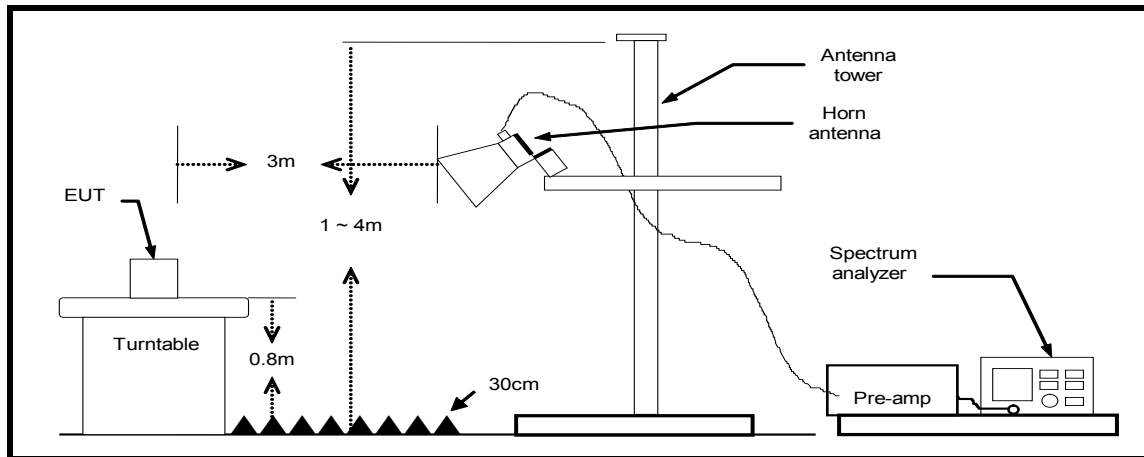

Test arrangement for radiated emissions of tabletop equipment.

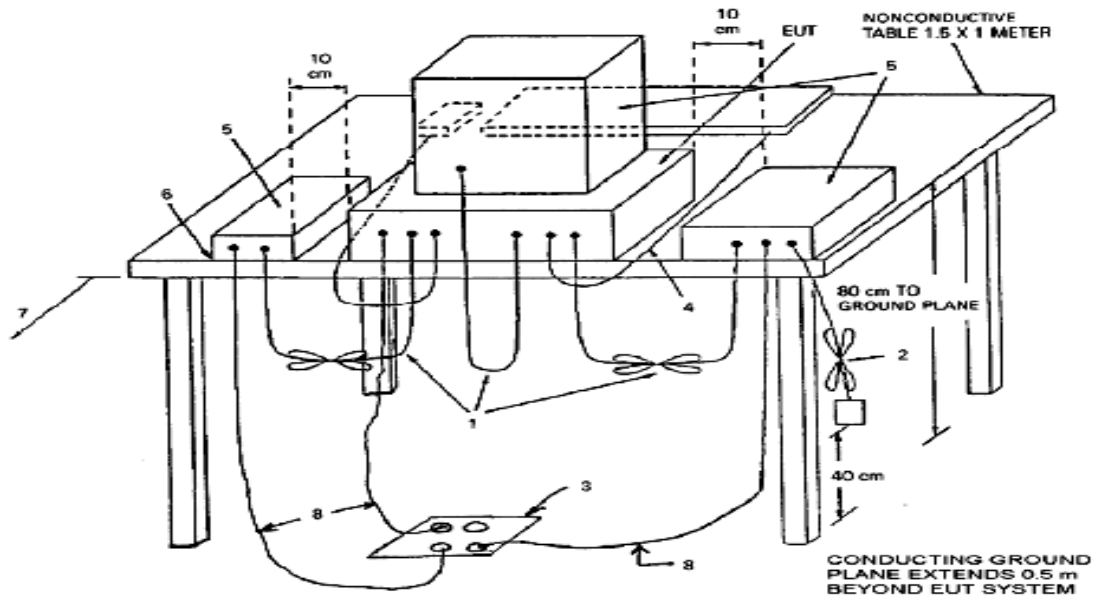

■ **Test Procedure**

Below 1 GHz

The EUT and its simulators are placed on a turn table which is 0.8 meter above ground. When the EUT is floor-standing equipment, it is placed on the ground plane which has a 12 mm non-conductive covering to insulate the EUT from the ground plane.

The turn table is 0.8 m height and 2.0 m wide x 1.0 m deep size. It can rotate 360 degrees to determine the position of the maximum emission level. The spacing between the each equipment was 10 cm. The mains cables are dropped to floor and are round to receptacle. Interconnecting cables of table top equipment that hang closer than 0.4 m to the ground plane are folded back and forth forming a bundle 0.3 m to 0.4 m long, hanging approximately in the middle between ground plane and table. The EUT was positioned such that the distance from antenna to the EUT was 10 meters and the receive antenna was moved from 1 m to 4 m to investigate maximum highest emission at least 6 points over the frequency range from 30 MHz to 1 GHz using a resolution bandwidth of 120 kHz and measured by the quasi-peak detector.

According to this standard paragraph 15.109, as an alternative to the radiated emission limits, digital devices may be shown to comply with the standards contained in Third Edition of the International Special Committee on Radio Interference (CISPR), Pub. 22, "Information Technology Equipment - Radio Disturbance Characteristics - Limits and Methods of Measurement".

Above 1 GHz

The Setup is same as Below 1 GHz placement. The turn table is 0.8 m height and 1.8 m wide x 1.0 m deep size. The turn table can rotate 360 degrees to determine the position of the maximum emission level. The EUT was positioned such that the distance from antenna to the EUT was 3 meter for above 1 GHz, the highest frequency performed according to internal source frequency of the EUT, the specification was below:

Highest frequency generated or used in the device or on which the device operates or tunes (MHz)	Upper frequency of measurement range (MHz)
Below 1.705	30
1.705 - 108	1000
108 - 500	2000
500 - 1000	5000
Above 1000	5th harmonic of the highest frequency or 40 GHz, whichever is lower

Absorber shall be spread between floor of a turn table and a receive antenna shown in 4.2.3. The antenna used boresight antenna master from 1 meter and 4 meters to find out the maximum emission level and find the highest emission at least 6 points. Both horizontal and vertical polarization of the antenna are set on measurement. In order to find the maximum emission, all of the interface cables must be manipulated on radiated measurement.

Radiated emissions were applied to above 1 GHz using a resolution bandwidth of 1 MHz and measured by the peak and average detector which antenna to the EUT distance was 3 meters. If the EUT was meet both limits and measurement with the average detector receiver is unnecessary.

5 Test Results

5.1. Conducted Emission

■ Limit

Frequency (MHz)	Class A (dBuV)		Class B (dBuV)	
	Quasi-peak	Average	Quasi-peak	Average
0.15 - 0.5	79	66	66 - 56	56 - 46
0.50 - 5.0	73	60	56	46
5.0 - 30.0	73	60	60	50

Note: (1) The lower limit shall apply at the transition frequencies.

(2) The limit decreases in line with the logarithm of the frequency in the range 0.15 to 0.50 MHz.

■ Test Result

Test Standard:	FCC Part 15B	Power Line:	L1
Test Mode:	Mode 1	Test Power:	AC 120 V / 60 Hz
Description:			

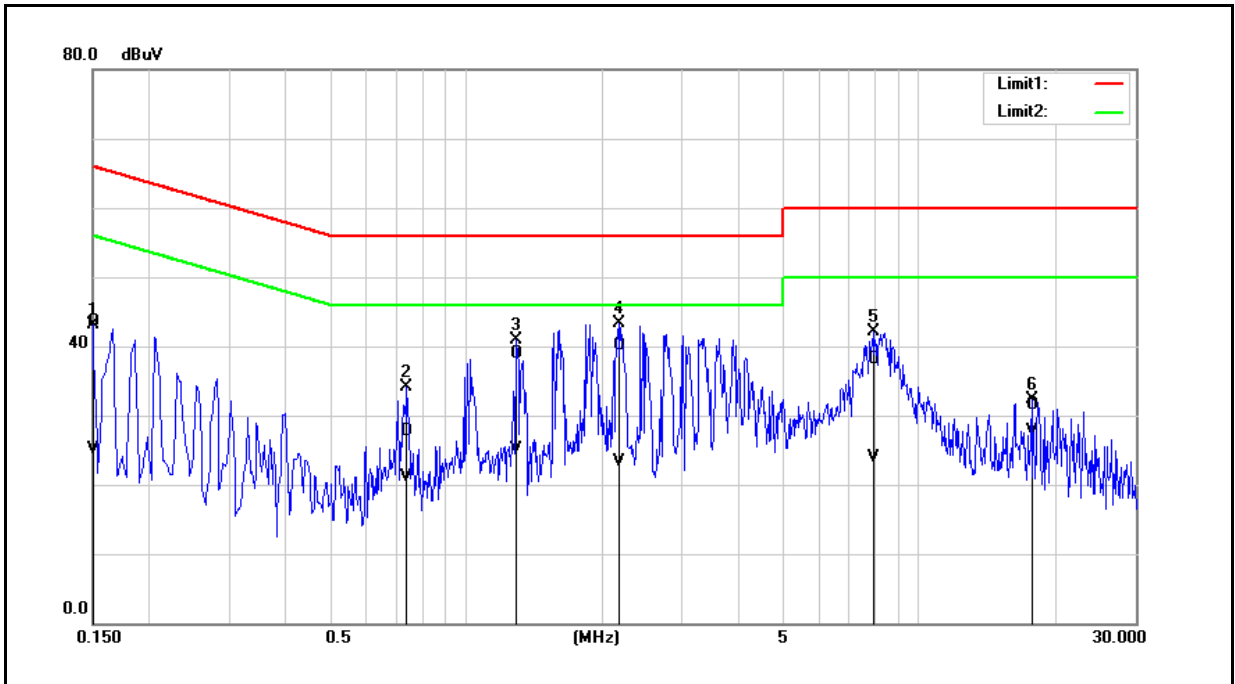

No.	Frequency (MHz)	QP reading (dBuV)	AVG reading (dBuV)	Correction factor (dB)	QP result (dBuV)	AVG result (dBuV)	QP limit (dBuV)	AVG limit (dBuV)	QP margin (dB)	AVG margin (dB)	Remark
1	0.1500	33.86	15.52	9.63	43.49	25.15	66.00	56.00	-22.51	-30.85	Pass
2	0.7420	17.96	11.40	9.66	27.62	21.06	56.00	46.00	-28.38	-24.94	Pass
3	1.2940	29.30	15.42	9.68	38.98	25.10	56.00	46.00	-17.02	-20.90	Pass
4	2.1740	30.50	13.52	9.70	40.20	23.22	56.00	46.00	-15.80	-22.78	Pass
5	7.9180	28.21	14.08	9.86	38.07	23.94	60.00	50.00	-21.93	-26.06	Pass
6	17.6940	21.50	17.72	9.98	31.48	27.70	60.00	50.00	-28.52	-22.30	Pass

Note: 1. Result (dBuV) = Correction factor (dB) + Reading(dBuV).
2. Correction factor (dB) = Cable loss (dB) + L.I.S.N. factor (dB).



Test Standard:	FCC Part 15B	Power Line:	N
Test Mode:	Mode 1	Test Power:	AC 120 V / 60 Hz
Description:			

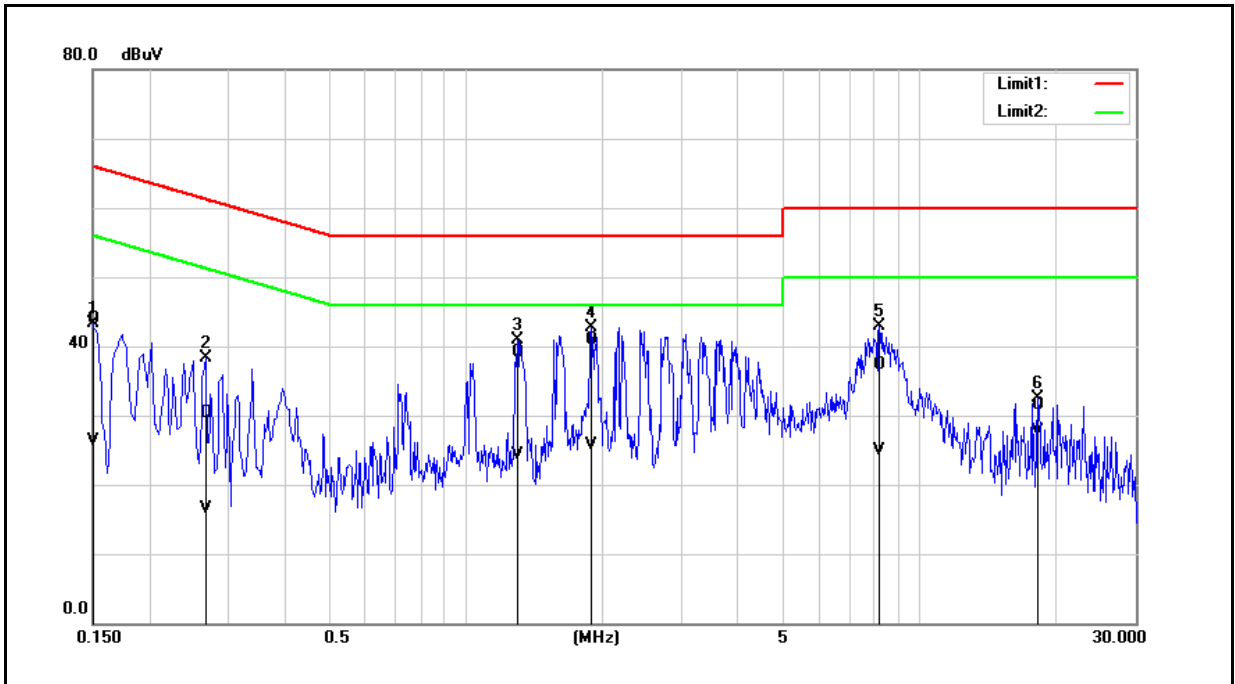

No.	Frequency (MHz)	QP reading (dBuV)	AVG reading (dBuV)	Correction factor (dB)	QP result (dBuV)	AVG result (dBuV)	QP limit (dBuV)	AVG limit (dBuV)	QP margin (dB)	AVG margin (dB)	Remark
1	0.1500	34.26	16.64	9.63	43.89	26.27	66.00	56.00	-22.11	-29.73	Pass
2	0.2660	20.67	6.92	9.63	30.30	16.55	61.24	51.24	-30.94	-34.69	Pass
3	1.3020	29.36	14.55	9.68	39.04	24.23	56.00	46.00	-16.96	-21.77	Pass
4	1.8900	31.14	15.98	9.70	40.84	25.68	56.00	46.00	-15.16	-20.32	Pass
5	8.1500	27.54	14.96	9.86	37.40	24.82	60.00	50.00	-22.60	-25.18	Pass
6	18.2420	21.47	17.72	9.99	31.46	27.71	60.00	50.00	-28.54	-22.29	Pass

Note: 1. Result (dBuV) = Correction factor (dB) + Reading(dBuV).
2. Correction factor (dB) = Cable loss (dB) + L.I.S.N. factor (dB).

Test Standard:	FCC Part 15B	Power Line:	L1
Test Mode:	Mode 2	Test Power:	AC 120 V / 60 Hz
Description:			

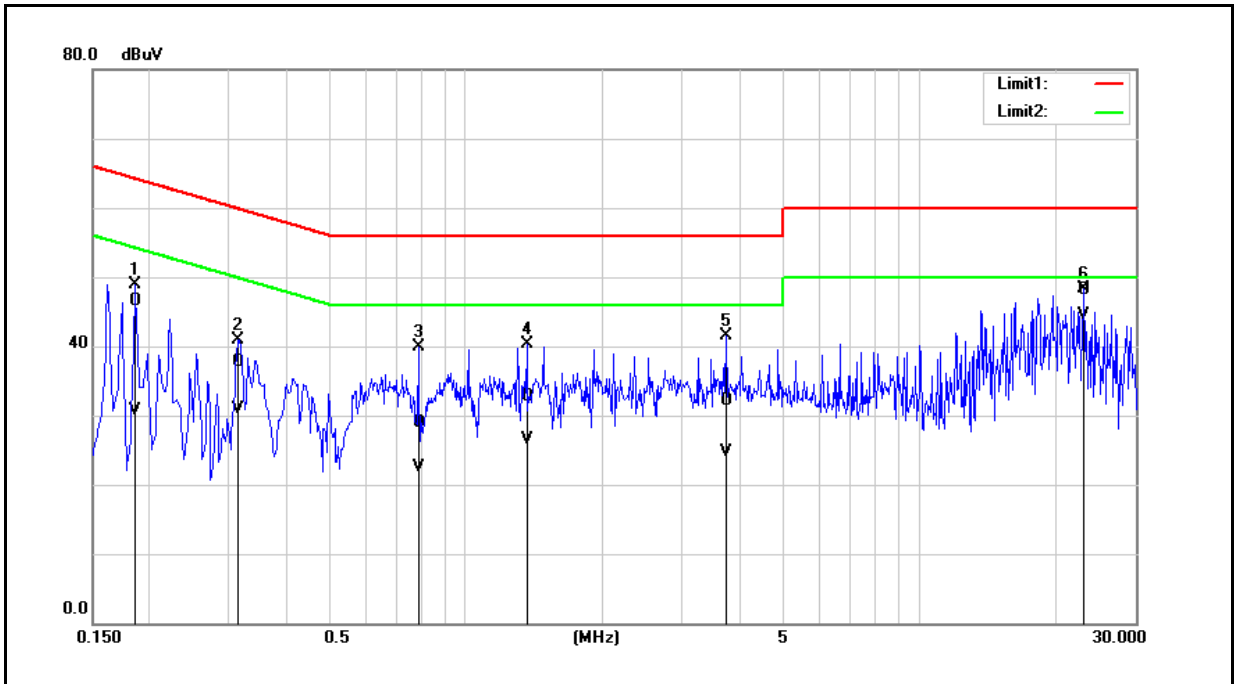

No.	Frequency (MHz)	QP reading (dBuV)	AVG reading (dBuV)	Correction factor (dB)	QP result (dBuV)	AVG result (dBuV)	QP limit (dBuV)	AVG limit (dBuV)	QP margin (dB)	AVG margin (dB)	Remark
1	0.1860	36.85	21.00	9.63	46.48	30.63	64.21	54.21	-17.73	-23.58	Pass
2	0.3140	28.09	21.26	9.63	37.72	30.89	59.86	49.86	-22.14	-18.97	Pass
3	0.7860	19.22	12.88	9.66	28.88	22.54	56.00	46.00	-27.12	-23.46	Pass
4	1.3660	22.95	16.77	9.68	32.63	26.45	56.00	46.00	-23.37	-19.55	Pass
5	3.7500	22.35	14.95	9.76	32.11	24.71	56.00	46.00	-23.89	-21.29	Pass
6	23.1300	38.02	34.52	10.01	48.03	44.53	60.00	50.00	-11.97	-5.47	Pass

Note: 1. Result (dBuV) = Correction factor (dB) + Reading(dBuV).
2. Correction factor (dB) = Cable loss (dB) + L.I.S.N. factor (dB).

Test Standard:	FCC Part 15B	Power Line:	N
Test Mode:	Mode 2	Test Power:	AC 120 V / 60 Hz
Description:			

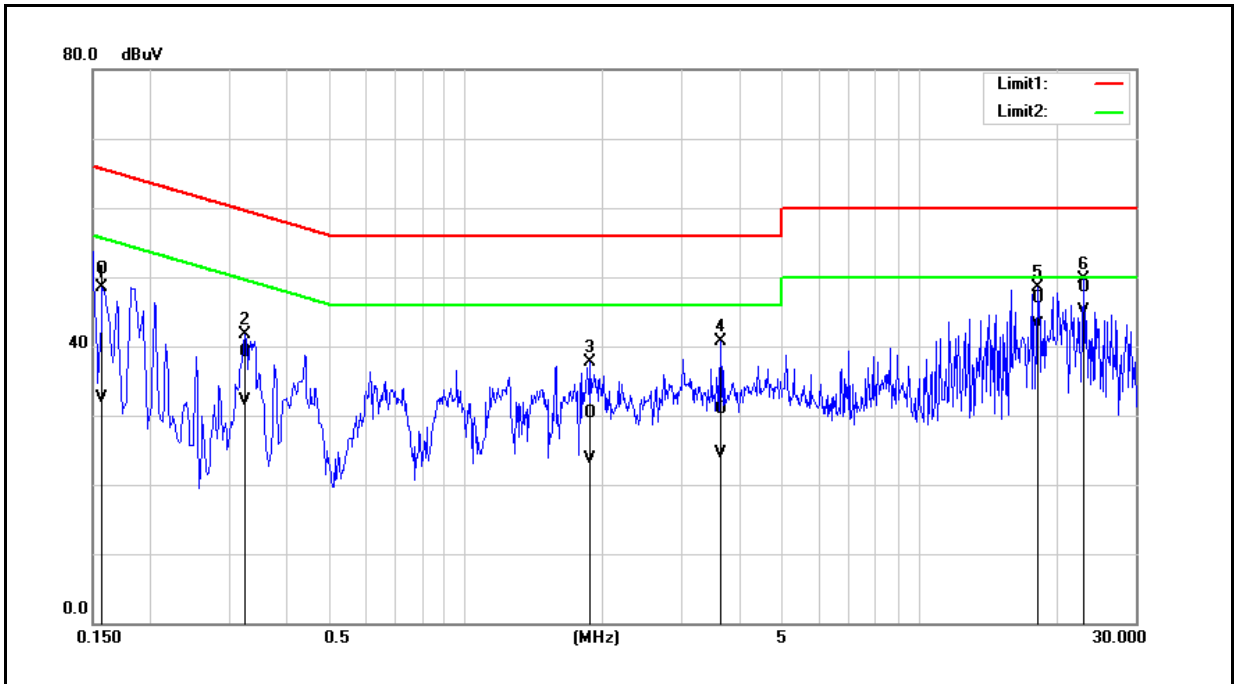

No.	Frequency (MHz)	QP reading (dBuV)	AVG reading (dBuV)	Correction factor (dB)	QP result (dBuV)	AVG result (dBuV)	QP limit (dBuV)	AVG limit (dBuV)	QP margin (dB)	AVG margin (dB)	Remark
1	0.1580	41.44	22.80	9.64	51.08	32.44	65.57	55.57	-14.49	-23.13	Pass
2	0.3260	29.57	22.53	9.63	39.20	32.16	59.55	49.55	-20.35	-17.39	Pass
3	1.8820	20.55	13.94	9.70	30.25	23.64	56.00	46.00	-25.75	-22.36	Pass
4	3.6500	21.15	14.73	9.75	30.90	24.48	56.00	46.00	-25.10	-21.52	Pass
5	18.2420	36.87	33.19	9.99	46.86	43.18	60.00	50.00	-13.14	-6.82	Pass
6	23.1300	38.45	35.01	10.01	48.46	45.02	60.00	50.00	-11.54	-4.98	Pass

Note: 1. Result (dBuV) = Correction factor (dB) + Reading(dBuV).
2. Correction factor (dB) = Cable loss (dB) + L.I.S.N. factor (dB).

5.2. Radiated Emission

■ Limit

Under 1 GHz test shall not exceed following value

FCC 47 CFR PART 15 SUBPART B				
Frequency range (MHz)	Class A		Class B	
	Distance (m)	dBuV/m	Distance (m)	dBuV/m
30 to 88	10	39	3	40
88 to 216	10	43.5	3	43.5
216 to 960	10	46.4	3	46
Above 960	10	49.5	3	54

CISPR 22				
Frequency range (MHz)	Class A		Class B	
	Distance (m)	dBuV/m	Distance (m)	dBuV/m
30 to 230	10	40	10	30
230 to 1000	10	47	10	37

Above 1 GHz test shall not exceed following value

Frequency (MHz)	dBuV/m (Distance 3 m)			
	Class A		Class B	
	Average	Peak	Average	Peak
1000 ~ 40000	60	80	54	74

- Remark:
1. The tighter limit shall apply at the edge between two frequency bands.
 2. Distance refers to the distance in meters between the measuring instrument antenna and the closed point of any part of the device or system.
 3. RF Voltage (dBuV/m) = 20 log RF Voltage (uV/m)
 4. Peak detector limit is corresponding to 20 dB above the maximum permitted average limit.

According to FCC Part 15.33 (b), for an unintentional radiator, including a digital device, the spectrum shall be investigated from the lowest radio frequency signal generated or used in the device, without going below the lowest frequency for which a radiated emission limit is specified, up to the frequency shown in the following table:

Highest frequency generated or used in the device or in which the device operated or tunes (MHz)	Upper frequency of measurement range (MHz)
Below 1.705	30
1.705-108	1000
108-500	2000
500-1000	5000
Above 1000	5th harmonic of the highest frequency or 40 GHz, whichever is lower

■ Test Result

Test Standard:	FCC Part 15B (limit use CISPR 22)	Test Distance:	10 m
Test Mode:	Mode 1	Test Power:	AC 120 V / 60 Hz
Measurement Range:	30 MHz~1 GHz	Ant.Polar.:	Horizontal

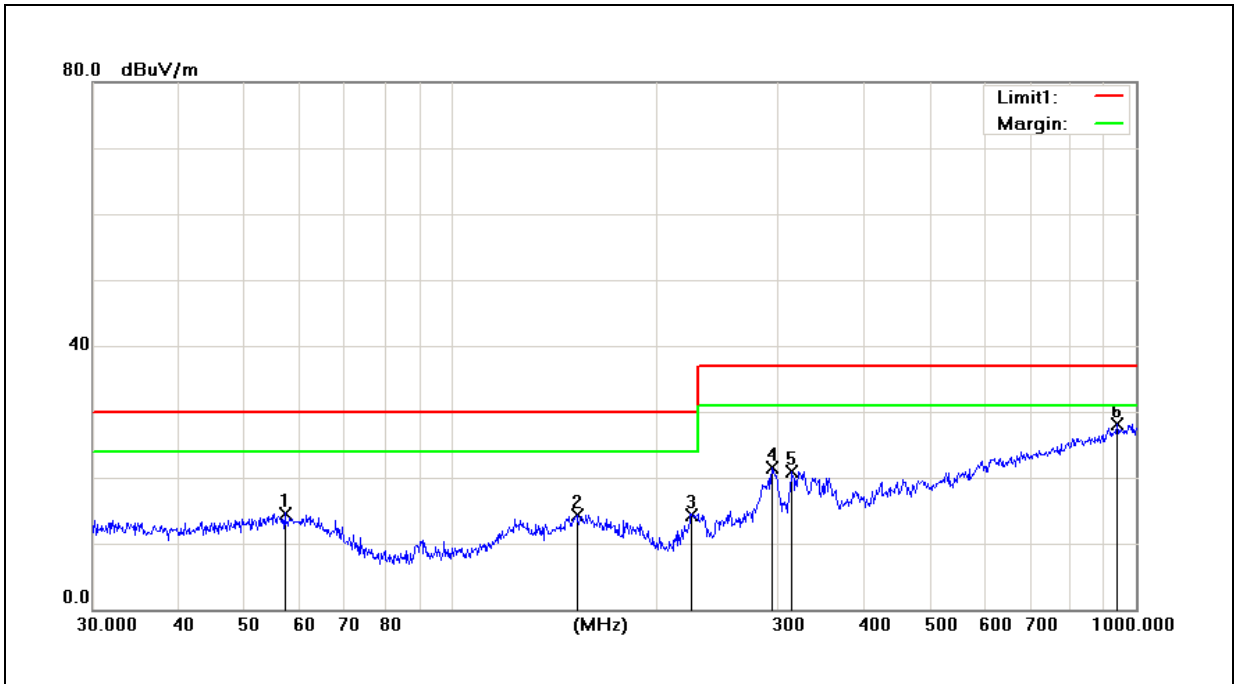

No.	Frequency (MHz)	Reading (dBuV)	Correct Factor (dB/m)	Result (dBuV/m)	Limit (dBuV/m)	Margin (dB)	Height (cm)	Degree (°)	Remark
1	57.1914	31.29	-16.69	14.60	30.00	-15.40	100	133	QP
2	152.6641	29.91	-15.61	14.30	30.00	-15.70	300	0	QP
3	224.5193	32.71	-18.31	14.40	30.00	-15.60	400	306	QP
4	294.1137	36.37	-14.87	21.50	37.00	-15.50	167	0	QP
5	314.3765	35.34	-14.44	20.90	37.00	-16.10	400	359	QP
6	938.8326	31.08	-2.98	28.10	37.00	-8.90	200	359	QP

Note: 1. Result (dBuV/m) = Correction factor (dB/m) + Reading(dBuV).

Example: 30.00 = -16.69 + 31.29

2. Correction factor (dB/m) = Antenna Factor (dB/m) + Cable loss (dB) – Pre-Amplifier gain (dB).



Test Standard:	FCC Part 15B (limit use CISPR 22)	Test Distance:	10 m
Test Mode:	Mode 1	Test Power:	AC 120 V / 60 Hz
Measurement Range:	30 MHz~1 GHz	Ant.Polar.:	Vertical

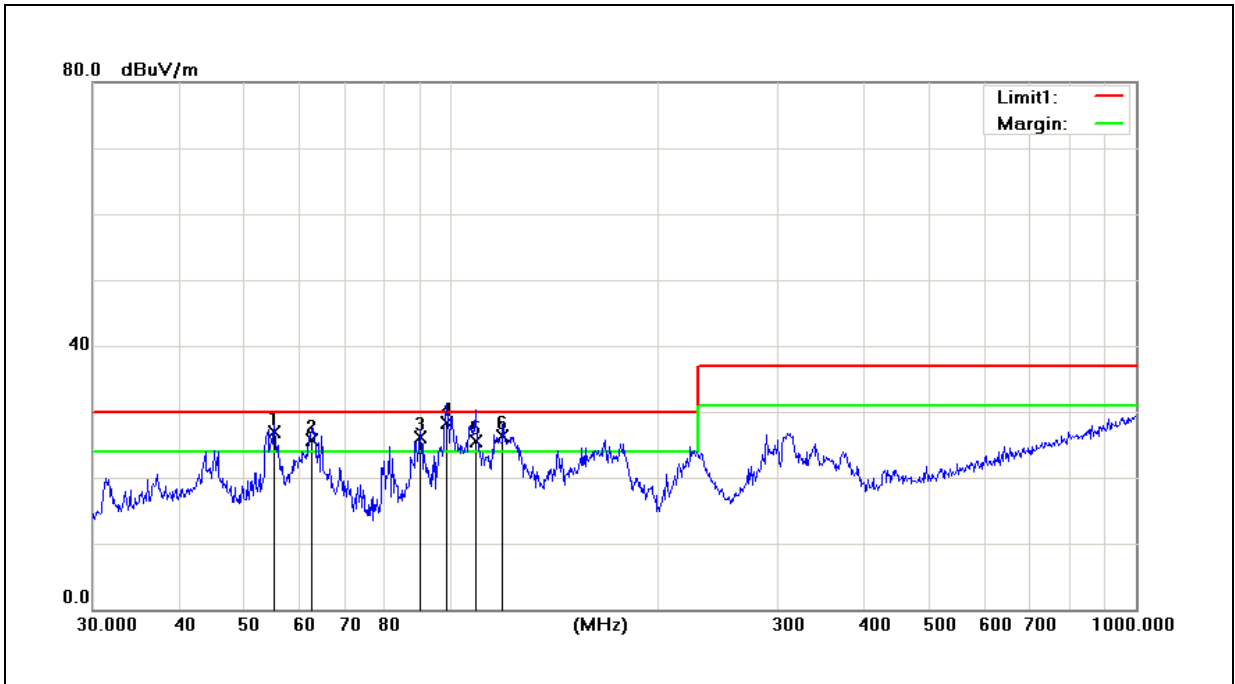

No.	Frequency (MHz)	Reading (dBuV)	Correct Factor (dB/m)	Result (dBuV/m)	Limit (dBuV/m)	Margin (dB)	Height (cm)	Degree (°)	Remark
1	55.2207	42.95	-16.05	26.90	30.00	-3.10	101	0	QP
2	62.6507	42.55	-16.75	25.80	30.00	-4.20	101	0	QP
3	90.2205	47.41	-21.31	26.10	30.00	-3.90	200	360	QP
4	98.4866	48.55	-20.25	28.30	30.00	-1.70	200	360	QP
5	108.6470	44.11	-18.61	25.50	30.00	-4.50	101	0	QP
6	119.0180	43.82	-17.42	26.40	30.00	-3.60	101	0	QP

Note: 1. Result (dBuV/m) = Correction factor (dB/m) + Reading(dBuV).

Example: 26.90 = -16.05 + 42.95

2. Correction factor (dB/m) = Antenna Factor (dB/m) + Cable loss (dB) – Pre-Amplifier gain (dB).

Test Standard:	FCC Part 15B (limit use CISPR 22)	Test Distance:	10 m
Test Mode:	Mode 2	Test Power:	AC 120 V / 60 Hz
Measurement Range:	30 MHz~1 GHz	Ant.Polar.:	Horizontal

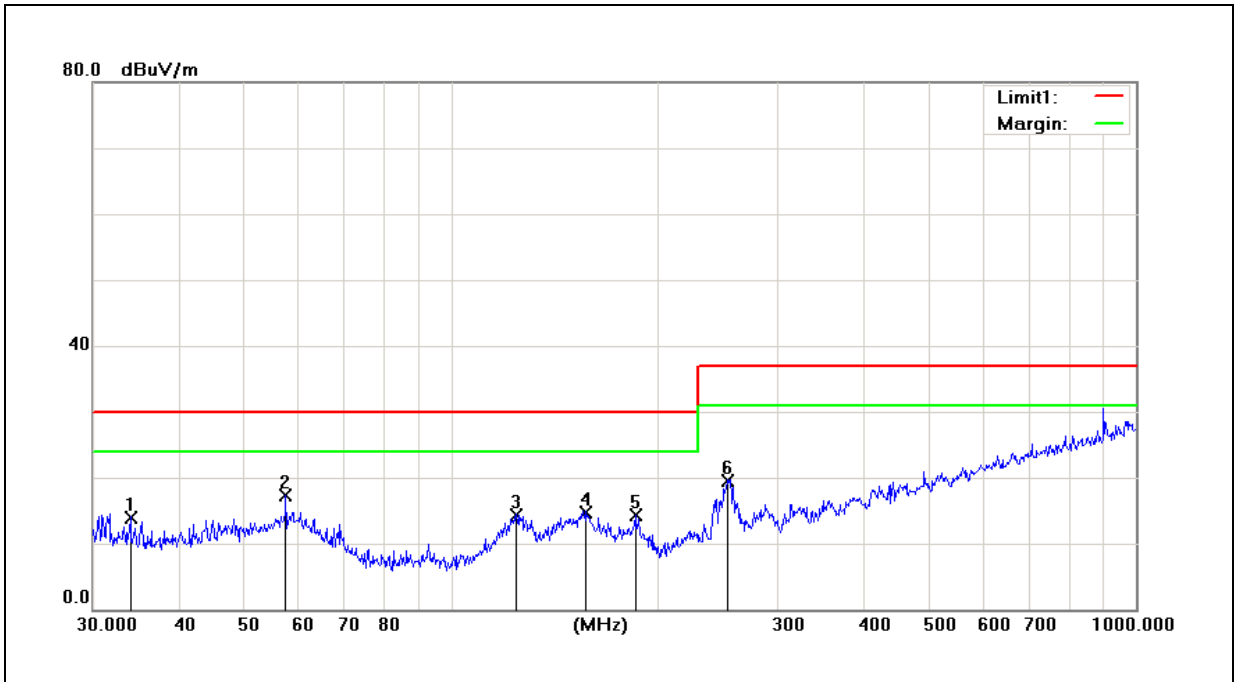

No.	Frequency (MHz)	Reading (dBuV)	Correct Factor (dB/m)	Result (dBuV/m)	Limit (dBuV/m)	Margin (dB)	Height (cm)	Degree (°)	Remark
1	34.0365	31.30	-17.30	14.00	30.00	-16.00	100	0	QP
2	57.3923	33.99	-16.69	17.30	30.00	-12.70	155	0	QP
3	124.5690	31.93	-17.53	14.40	30.00	-15.60	400	216	QP
4	157.5588	30.30	-15.50	14.80	30.00	-15.20	300	296	QP
5	185.7882	31.94	-17.64	14.30	30.00	-15.70	100	360	QP
6	253.8367	36.06	-16.46	19.60	37.00	-17.40	133	0	QP

Note: 1. Result (dBuV/m) = Correction factor (dB/m) + Reading(dBuV).

2. Correction factor (dB/m) = Antenna Factor (dB/m) + Cable loss (dB) – Pre-Amplifier gain (dB).

Test Standard:	FCC Part 15B (limit use CISPR 22)	Test Distance:	10 m
Test Mode:	Mode 2	Test Power:	AC 120 V / 60 Hz
Measurement Range:	30 MHz~1 GHz	Ant.Polar.:	Vertical

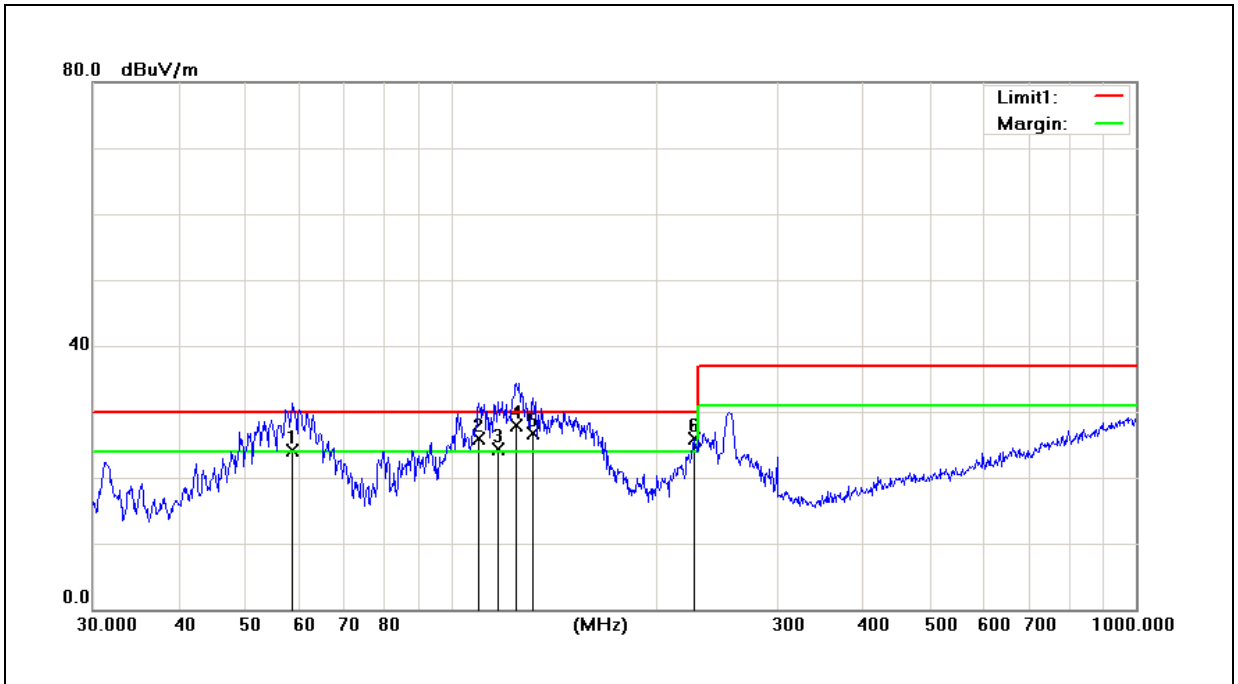

No.	Frequency (MHz)	Reading (dBuV)	Correct Factor (dB/m)	Result (dBuV/m)	Limit (dBuV/m)	Margin (dB)	Height (cm)	Degree (°)	Remark
1	58.6126	40.43	-16.23	24.20	30.00	-5.80	100	77	QP
2	109.7960	44.33	-18.43	25.90	30.00	-4.10	100	86	QP
3	117.3603	41.99	-17.59	24.40	30.00	-5.60	200	152	QP
4	124.5690	44.74	-16.84	27.90	30.00	-2.10	200	175	QP
5	131.7577	42.80	-16.10	26.70	30.00	-3.30	100	113	QP
6	226.0994	43.22	-17.32	25.90	30.00	-4.10	100	0	QP

Note: 1. Result (dBuV/m) = Correction factor (dB/m) + Reading(dBuV).

2. Correction factor (dB/m) = Antenna Factor (dB/m) + Cable loss (dB) – Pre-Amplifier gain (dB).

Test Standard:	FCC Part 15B	Test Distance:	3 m
Test Mode:	Mode 1	Test Power:	AC 120 V / 60 Hz
Measurement Range:	1 GHz~13 GHz	Ant.Polar.:	Horizontal

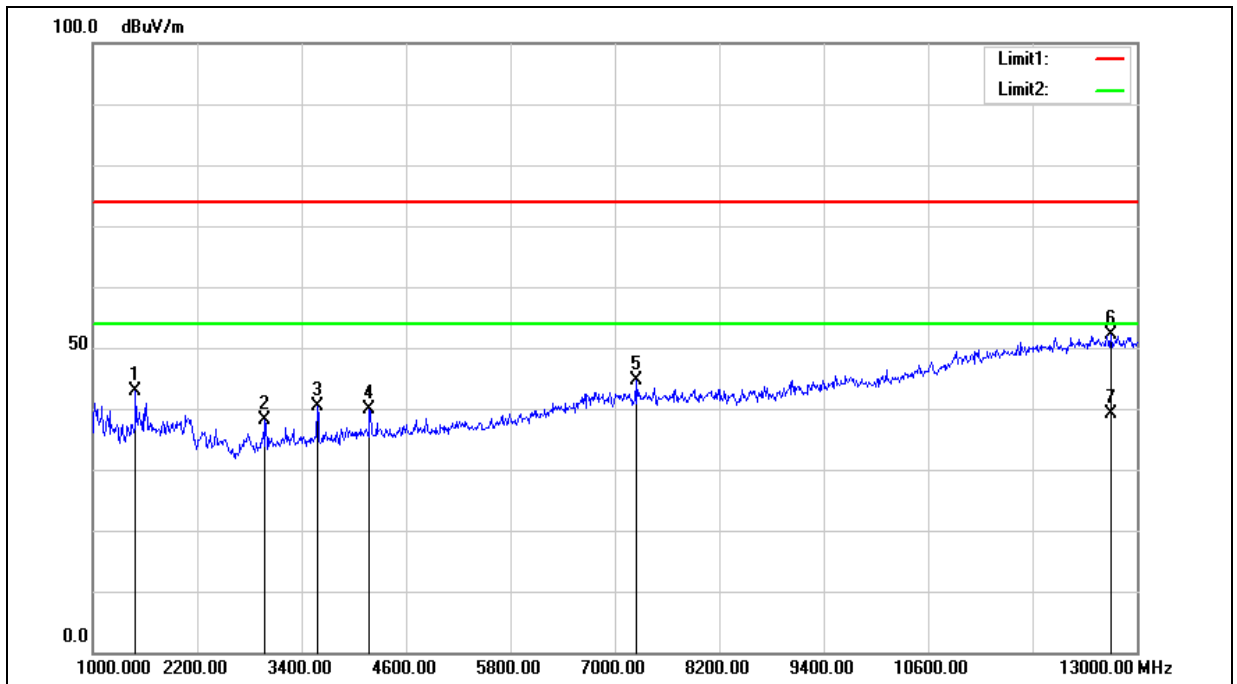

No.	Frequency (MHz)	Reading (dBuV)	Correct Factor (dB/m)	Result (dBuV/m)	Limit (dBuV/m)	Margin (dB)	Height (cm)	Degree (°)	Remark
1	1492.000	44.36	-1.49	42.87	74.00	-31.13	200	0	peak
2	2980.000	34.15	4.02	38.17	74.00	-35.83	200	223	peak
3	3580.000	35.28	5.02	40.30	74.00	-33.70	200	164	peak
4	4180.000	33.32	6.54	39.86	74.00	-34.14	200	116	peak
5	7240.000	34.90	9.63	44.53	74.00	-29.47	100	12	peak
6	12700.000	32.57	19.53	52.10	74.00	-21.90	100	252	peak
7	12700.000	19.71	19.53	39.24	54.00	-14.76	100	252	AVG

Note: 1. Result (dBuV/m) = Correction factor (dB/m) + Reading(dBuV).

Example: 42.87 = -1.49 + 44.36

2. Correction factor (dB/m) = Antenna Factor (dB/m) + Cable loss (dB) – Pre-Amplifier gain (dB).



Test Standard:	FCC Part 15B	Test Distance:	3 m
Test Mode:	Mode 1	Test Power:	AC 120 V / 60 Hz
Measurement Range:	1 GHz~13 GHz	Ant.Polar.:	Vertical

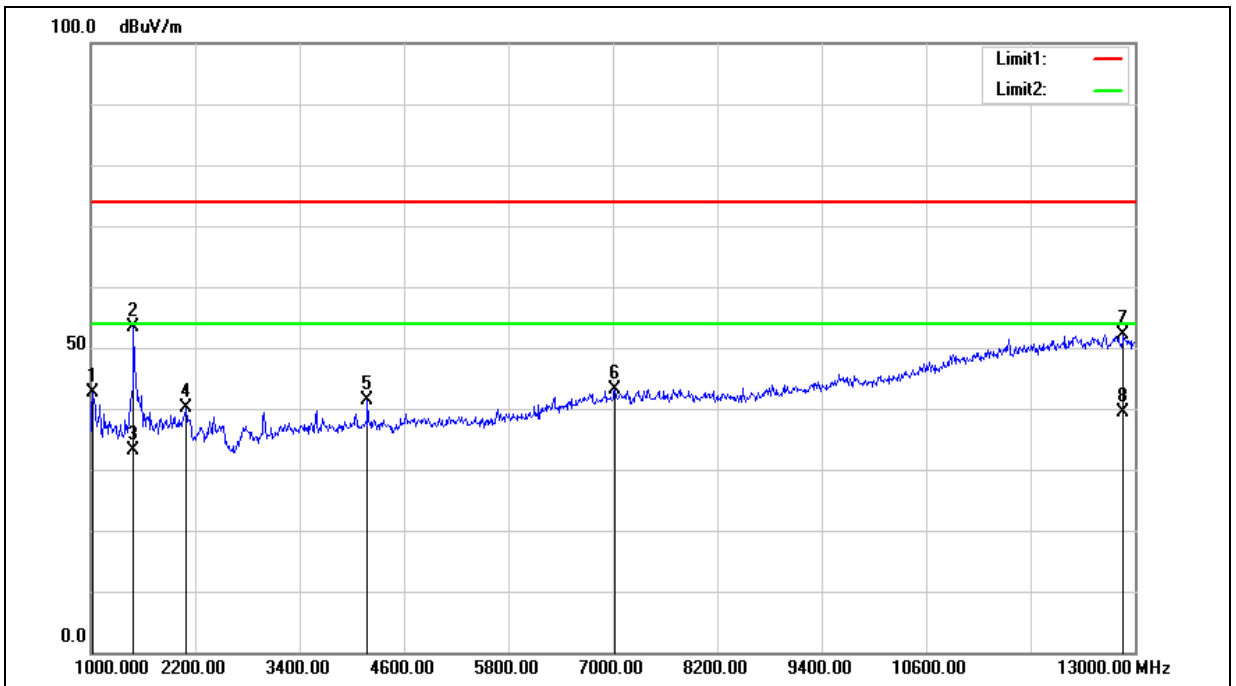

No.	Frequency (MHz)	Reading (dBuV)	Correct Factor (dB/m)	Result (dBuV/m)	Limit (dBuV/m)	Margin (dB)	Height (cm)	Degree (°)	Remark
1	1024.000	47.11	-4.51	42.60	74.00	-31.40	200	84	peak
2	1492.000	54.88	-1.49	53.39	74.00	-20.61	100	0	peak
3	1492.000	34.64	-1.49	33.15	54.00	-20.85	100	0	AVG
4	2092.000	37.51	2.57	40.08	74.00	-33.92	100	303	peak
5	4180.000	34.79	6.54	41.33	74.00	-32.67	100	32	peak
6	7024.000	33.46	9.62	43.08	74.00	-30.92	200	0	peak
7	12868.000	32.36	19.81	52.17	74.00	-21.83	146	360	peak
8	12868.000	19.61	19.81	39.42	54.00	-14.58	146	360	AVG

Note: 1. Result (dBuV/m) = Correction factor (dB/m) + Reading(dBuV).

Example: 42.60 = -4.51 + 47.11

2. Correction factor (dB/m) = Antenna Factor (dB/m) + Cable loss (dB) – Pre-Amplifier gain (dB).

Test Standard:	FCC Part 15B	Test Distance:	3 m
Test Mode:	Mode 2	Test Power:	AC 120 V / 60 Hz
Measurement Range:	1 GHz~13 GHz	Ant.Polar.:	Horizontal

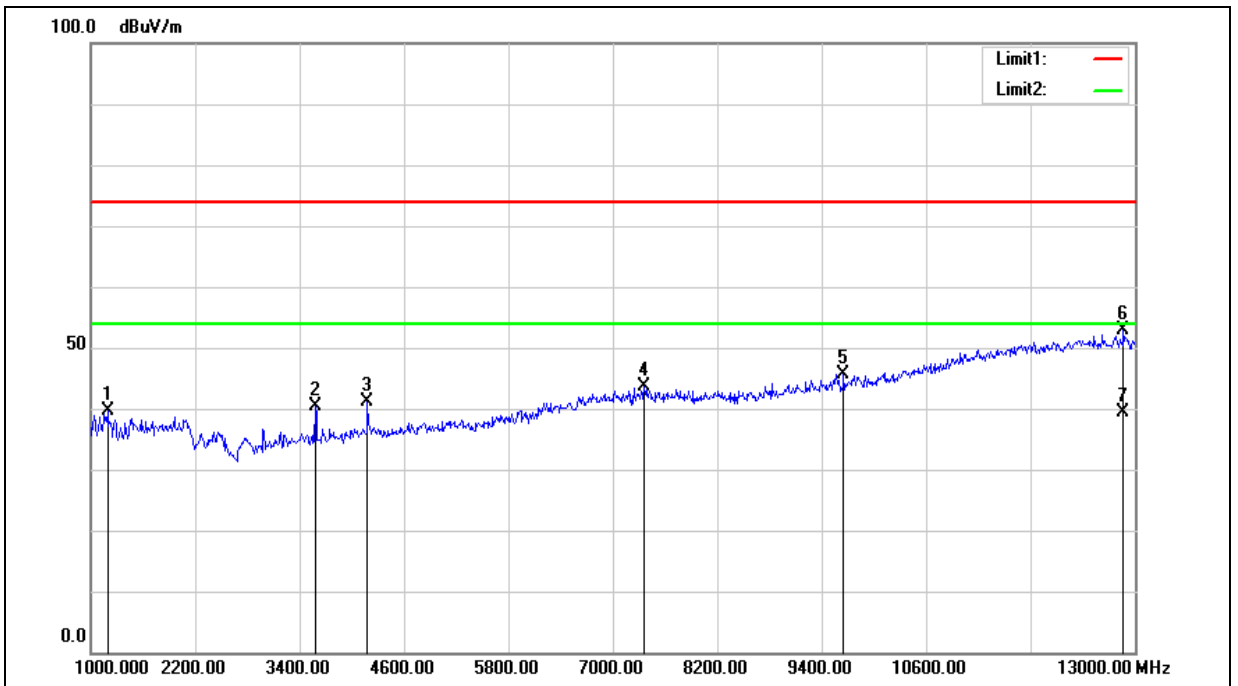

No.	Frequency (MHz)	Reading (dBuV)	Correct Factor (dB/m)	Result (dBuV/m)	Limit (dBuV/m)	Margin (dB)	Height (cm)	Degree (°)	Remark
1	1192.000	43.06	-3.43	39.63	74.00	-34.37	100	359	peak
2	3580.000	35.39	5.02	40.41	74.00	-33.59	200	125	peak
3	4180.000	34.69	6.54	41.23	74.00	-32.77	200	219	peak
4	7360.000	33.99	9.63	43.62	74.00	-30.38	200	249	peak
5	9652.000	34.54	11.11	45.65	74.00	-28.35	100	75	peak
6	12868.000	33.02	19.81	52.83	74.00	-21.17	200	89	peak
7	12868.000	19.54	19.81	39.35	54.00	-14.65	200	89	AVG

Note: 1. Result (dBuV/m) = Correction factor (dB/m) + Reading(dBuV).

2. Correction factor (dB/m) = Antenna Factor (dB/m) + Cable loss (dB) – Pre-Amplifier gain (dB).



Test Standard:	FCC Part 15B	Test Distance:	3 m
Test Mode:	Mode 2	Test Power:	AC 120 V / 60 Hz
Measurement Range:	1 GHz~13 GHz	Ant.Polar.:	Vertical

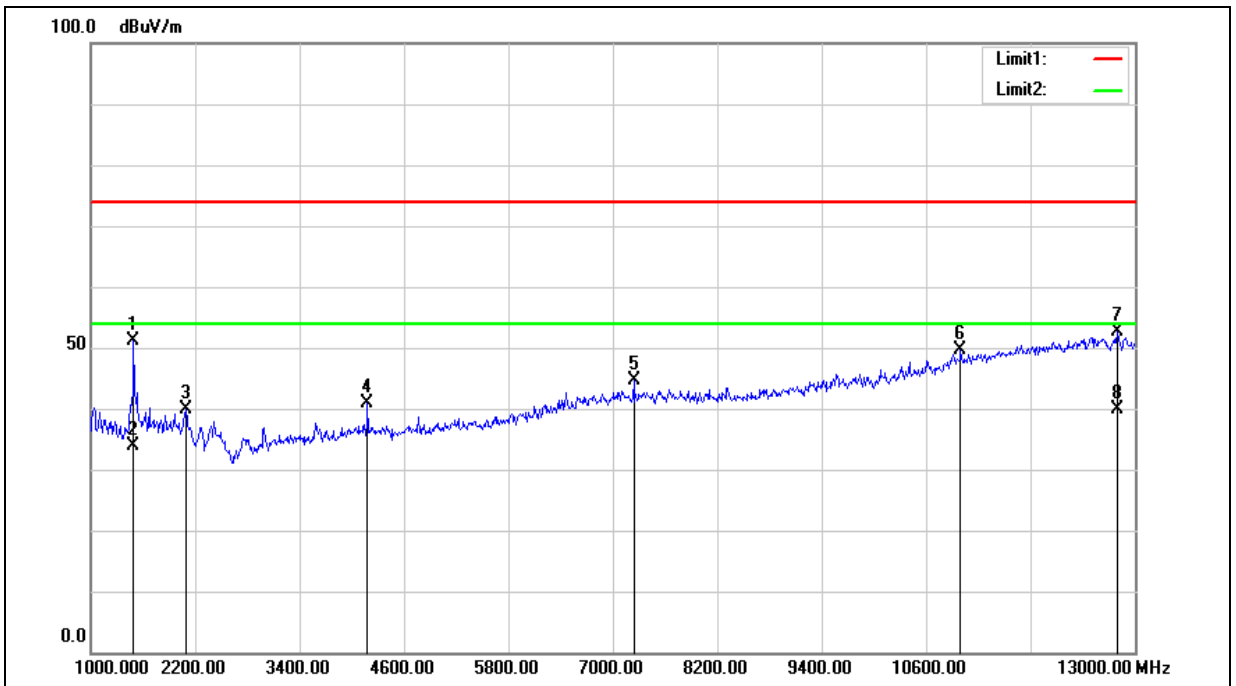

No.	Frequency (MHz)	Reading (dBuV)	Correct Factor (dB/m)	Result (dBuV/m)	Limit (dBuV/m)	Margin (dB)	Height (cm)	Degree (°)	Remark
1	1492.000	52.57	-1.49	51.08	74.00	-22.92	100	321	peak
2	1492.000	35.36	-1.49	33.87	54.00	-20.13	100	321	AVG
3	2092.000	37.35	2.57	39.92	74.00	-34.08	100	335	peak
4	4180.000	34.44	6.54	40.98	74.00	-33.02	100	36	peak
5	7240.000	34.95	9.63	44.58	74.00	-29.42	127	360	peak
6	10996.000	33.39	16.30	49.69	74.00	-24.31	200	310	peak
7	12796.000	32.90	19.69	52.59	74.00	-21.41	200	83	peak
8	12796.000	20.21	19.69	39.90	54.00	-14.10	200	83	AVG

Note: 1. Result (dBuV/m) = Correction factor (dB/m) + Reading(dBuV).

2. Correction factor (dB/m) = Antenna Factor (dB/m) + Cable loss (dB) – Pre-Amplifier gain (dB).

--- END---