

FCC Test Report

Report No.: RF181129C36A-1

FCC ID: 2ASXXPA2200

Test Model: PA2200

Received Date: Oct. 01, 2019

Test Date: Oct. 29 ~ Nov. 04, 2019

Issued Date: Nov. 11, 2019

Applicant: Plasma Cloud Limited

Address: 5/F, Yat Chau Building 262 Des Voeux Road Central Hong Kong

Issued By: Bureau Veritas Consumer Products Services (H.K.) Ltd., Taoyuan Branch
Lin Kou Laboratories

Lab Address: No. 47-2, 14th Ling, Chia Pau Vil., Lin Kou Dist., New Taipei City, Taiwan

Test Location: No. 19, Hwa Ya 2nd Rd., Wen Hwa Vil., Kwei Shan Dist., Taoyuan City
33383, TAIWAN

**FCC Registration /
Designation Number:** 788550 / TW0003



This report is for your exclusive use. Any copying or replication of this report to or for any other person or entity, or use of our name or trademark, is permitted only with our prior written permission. This report sets forth our findings solely with respect to the test samples identified herein. The results set forth in this report are not indicative or representative of the quality or characteristics of the lot from which a test sample was taken or any similar or identical product specifically and expressly noted. Our report includes all of the tests requested by you and the results thereof based upon the information that you provided to us. You have 60 days from date of issuance of this report to notify us of any material error or omission caused by our negligence, provided, however, that such notice shall be in writing and shall specifically address the issue you wish to raise. A failure to raise such issue within the prescribed time shall constitute your unqualified acceptance of the completeness of this report, the tests conducted and the correctness of the report contents. Unless specific mention, the uncertainty of measurement has been explicitly taken into account to declare the compliance or non-compliance to the specification. The report must not be used by the client to claim product certification, approval, or endorsement by TAF or any government agencies.

Table of Contents

Release Control Record	4
1 Certificate of Conformity	5
2 Summary of Test Results	6
2.1 Measurement Uncertainty	6
2.2 Modification Record	6
3 General Information	7
3.1 General Description of EUT	7
3.2 Description of Test Modes	9
3.2.1 Test Mode Applicability and Tested Channel Detail	10
3.3 Duty Cycle of Test Signal	12
3.4 Description of Support Units	13
3.4.1 Configuration of System under Test	13
3.5 General Description of Applied Standards	14
4 Test Types and Results	15
4.1 Radiated Emission and Bandedge Measurement	15
4.1.1 Limits of Radiated Emission and Bandedge Measurement	15
4.1.2 Test Instruments	16
4.1.3 Test Procedures	17
4.1.4 Deviation from Test Standard	17
4.1.5 Test Setup	18
4.1.6 EUT Operating Conditions	19
4.1.7 Test Results	20
4.2 Conducted Emission Measurement	46
4.2.1 Limits of Conducted Emission Measurement	46
4.2.2 Test Instruments	46
4.2.3 Test Procedures	47
4.2.4 Deviation from Test Standard	47
4.2.5 Test Setup	47
4.2.6 EUT Operating Conditions	47
4.2.7 Test Results	48
4.3 Transmit Power Measurement	56
4.3.1 Limits of Transmit Power Measurement	56
4.3.2 Test Setup	56
4.3.3 Test Instruments	56
4.3.4 Test Procedure	56
4.3.5 Deviation from Test Standard	56
4.3.6 EUT Operating Conditions	56
4.3.7 Test Result	57
4.4 Occupied Bandwidth Measurement	59
4.4.1 Test Setup	59
4.4.2 Test Instruments	59
4.4.3 Test Procedure	59
4.4.4 Test Result	60
4.5 Peak Power Spectral Density Measurement	62
4.5.1 Limits of Peak Power Spectral Density Measurement	62
4.5.2 Test Setup	62
4.5.3 Test Instruments	62
4.5.4 Test Procedures	62
4.5.5 Deviation from Test Standard	63
4.5.6 EUT Operating Conditions	63
4.5.7 Test Results	64
4.6 Frequency Stability	69
4.6.1 Limits of Frequency Stability Measurement	69

4.6.2 Test Setup.....	69
4.6.3 Test Instruments	69
4.6.4 Test Procedure	69
4.6.5 Deviation from Test Standard	70
4.6.6 EUT Operating Condition	70
4.6.7 Test Results	70
4.7 6dB Bandwidth Measurement	71
4.7.1 Limits of 6dB Bandwidth Measurement.....	71
4.7.2 Test Setup.....	71
4.7.3 Test Instruments	71
4.7.4 Test Procedure	71
4.7.5 Deviation from Test Standard	71
4.7.6 EUT Operating Condition	71
4.7.7 Test Results	72
5 Pictures of Test Arrangements.....	74
Annex A- Radiated Out of Band Emission (OOBE) Measurement (For U-NII-3 band)	75
Appendix – Information on the Testing Laboratories	78

Release Control Record

Issue No.	Description	Date Issued
RF181129C36A-1	Original release	Nov. 11, 2019

1 Certificate of Conformity

Product: PA2200

Brand: PLASMA CLOUD

Test Model: PA2200

Sample Status: Engineering sample

Applicant: Plasma Cloud Limited

Test Date: Oct. 29 ~ Nov. 04, 2019

Standards: 47 CFR FCC Part 15, Subpart E (Section 15.407)
ANSI C63.10:2013

The above equipment has been tested by **Bureau Veritas Consumer Products Services (H.K.) Ltd., Taoyuan Branch**, and found compliance with the requirement of the above standards. The test record, data evaluation & Equipment Under Test (EUT) configurations represented herein are true and accurate accounts of the measurements of the sample's RF characteristics under the conditions specified in this report.

Prepared by : Celine Chou , **Date:** Nov. 11, 2019
Celine Chou / Senior Specialist

Approved by : Bruce Chen , **Date:** Nov. 11, 2019
Bruce Chen / Senior Project Engineer

2 Summary of Test Results

47 CFR FCC Part 15, Subpart E (Section 15.407)			
FCC Clause	Test Item	Result	Remarks
15.407(b)(6)	AC Power Conducted Emissions	Pass	Meet the requirement of limit. Minimum passing margin is -7.78dB at 0.47684MHz.
15.407(b) (1/2/3/4(i/ii)/6)	Radiated Emissions & Band Edge Measurement	Pass	Meet the requirement of limit. Minimum passing margin is -2.2dB at 5650.00MHz.
15.407(a)(1/2/3)	Max Average Transmit Power	Pass	Meet the requirement of limit.
---	Occupied Bandwidth Measurement	-	Reference only.
15.407(a)(1/2/3)	Peak Power Spectral Density	Pass	Meet the requirement of limit.
15.407(e)	6dB bandwidth	Pass	Meet the requirement of limit. (U-NII-3 Band only)
15.407(g)	Frequency Stability	Pass	Meet the requirement of limit.
15.203	Antenna Requirement	Pass	Antenna connector is IPEX not a standard connector.

Note:

- Determining compliance based on the results of the compliance measurement, not taking into account measurement instrumentation uncertainty.
- For U-NII-3 band compliance with rule part 15.407(b)(4)(i), the OOB test plots were recorded in Annex A.

2.1 Measurement Uncertainty

Where relevant, the following measurement uncertainty levels have been estimated for tests performed on the EUT as specified in CISPR 16-4-2:

Measurement	Frequency	Expanded Uncertainty (k=2) (\pm)
Conducted Emissions at mains ports	150kHz ~ 30MHz	2.79 dB
Radiated Emissions up to 1 GHz	9kHz ~ 30MHz	3.04 dB
	30MHz ~ 200MHz	3.86 dB
	200MHz ~ 1000MHz	3.87 dB
Radiated Emissions above 1 GHz	1GHz ~ 18GHz	2.29 dB
	18GHz ~ 40GHz	2.29 dB

2.2 Modification Record

There were no modifications required for compliance.

3 General Information

3.1 General Description of EUT

Product	PA2200
Brand	PLASMA CLOUD
Test Model	PA2200
Sample Status	Engineering sample
Power Supply Rating	12Vdc from adapter 54Vdc from POE
Modulation Type	256QAM, 64QAM, 16QAM, QPSK, BPSK
Modulation Technology	OFDM
Transfer Rate	802.11a: 54/48/36/24/18/12/9/6Mbps 802.11n: up to 300Mbps 802.11ac: up to 867Mbps
Operating Frequency	5180 ~ 5240MHz, 5745 ~ 5825MHz
Number of Channel	5180 ~ 5240MHz: 802.11a, 802.11n (HT20), 802.11ac (VHT20): 4 802.11n (HT40), 802.11ac (VHT40): 2 802.11ac (VHT80): 1 5745 ~ 5825MHz: 802.11a, 802.11n (HT20), 802.11ac (VHT20): 5 802.11n (HT40), 802.11ac (VHT40): 2 802.11ac (VHT80): 1
Output Power	CDD Mode: 5180 ~ 5240MHz: 172.970mW 5745 ~ 5825MHz: 209.325mW Beamforming Mode: 5180 ~ 5240MHz: 86.491mW 5745 ~ 5825MHz: 104.670mW
Antenna Type	Refer to note
Antenna Connector	Refer to note
Accessory Device	NA
Cable Supplied	NA

Note:

1. The EUT incorporates a MIMO function. Physically, the EUT provides 2 completed transmitters and 2 receivers.

Band	Modulation Mode	Beamforming Mode	TX Function	Remark
5GHz Band 1	802.11a	Not Support	2TX	Radio 3 (Ant. 4, 5)
	802.11n (HT20)	Support	2TX	
	802.11n (HT40)	Support	2TX	
	802.11ac (VHT20)	Support	2TX	
	802.11ac (VHT40)	Support	2TX	
	802.11ac (VHT80)	Support	2TX	
5GHz Band 4	802.11a	Not Support	2TX	Radio 2 (Ant. 3, 6)
	802.11n (HT20)	Support	2TX	
	802.11n (HT40)	Support	2TX	
	802.11ac (VHT20)	Support	2TX	
	802.11ac (VHT40)	Support	2TX	
	802.11ac (VHT80)	Support	2TX	

* The bandwidth and modulation are similar for HT20/HT40 on 802.11n mode and VHT20/VHT40 on 802.11ac mode. Therefore the investigated worst case is the representative mode in test report. (Final test mode refer section 3.2.1)

* For 802.11n and 802.11ac, CDD mode and Beamforming mode are presented in power output test item. For other test items, CDD mode is the worst case for final tests after pretesting.

2. The EUT consumes power from the following adapter & POE.

Adapter (support unit only)	
Brand	DEE VAN ENTERPRISE CO., LTD
Model	DSA-12PFT-12 FUS 120100
Input Power	100-240Vac, 50/60Hz, 0.5A
Output Power	12Vdc, 1A
Power Line	1.45m DC cable without core attached on adapter

POE (support unit only)	
Brand	EnGenius
Model	EPA5006GP
Input Power	100-240Vac, 50-60Hz, 0.8A
Output Power	54Vdc, 0.6A
Power Line	0.5m AC cable without core

3. The following antennas were provided to the EUT.

Ant. No.	1	2	3	4	5	6
Ant. Type	PIFA	PIFA	PIFA	PIFA	PIFA	PIFA
Ant. Connector	IPEX	IPEX	IPEX	IPEX	IPEX	IPEX
Frequency (MHz)	2400-2500		5150-5875			
Peak Gain (dBi)	4.62	4.44	5.97	5.94	5.88	5.99
Remark	Radio 1 (WLAN 2.4G)		Radio 2 (WLAN 5G Band 4)	Radio 3 (WLAN 5G Band 1)		Radio 2 (WLAN 5G Band 4)

4. 2.4GHz (Radio 1) & 5GHz (Radio 2) & 5GHz (Radio 3) technology can transmit at same time.
5. Spurious emission of the simultaneous operation (2.4GHz (Radio 1) & 5GHz (Radio 2) & 5GHz (Radio 3)) has been evaluated and no non-compliance was found.

3.2 Description of Test Modes

For 5180 ~ 5240MHz:

4 channels are provided for 802.11a, 802.11n (HT20), 802.11ac (VHT20):

Channel	Frequency	Channel	Frequency
36	5180 MHz	44	5220 MHz
40	5200 MHz	48	5240 MHz

2 channels are provided for 802.11n (HT40), 802.11ac (VHT40):

Channel	Frequency	Channel	Frequency
38	5190 MHz	46	5230 MHz

1 channel is provided for 802.11ac (VHT80):

Channel	Frequency
42	5210MHz

For 5745 ~ 5825MHz:

5 channels are provided for 802.11a, 802.11n (HT20), 802.11ac (VHT20):

Channel	Frequency	Channel	Frequency
149	5745MHz	161	5805MHz
153	5765MHz	165	5825MHz
157	5785MHz		

2 channels are provided for 802.11n (HT40), 802.11ac (VHT40):

Channel	Frequency	Channel	Frequency
151	5755MHz	159	5795MHz

1 channel is provided for 802.11ac (VHT80):

Channel	Frequency
155	5775MHz

3.2.1 Test Mode Applicability and Tested Channel Detail

EUT Configure Mode	Applicable to				Description
	RE \geq 1G	RE<1G	PLC	APCM	
A	√	√	√	√	Powered by adapter
B	-	√	√	-	Powered by POE

Where RE \geq 1G: Radiated Emission above 1GHz & Bandedge Measurement
 RE<1G: Radiated Emission below 1GHz
 PLC: Power Line Conducted Emission
 APCM: Antenna Port Conducted Measurement

Note:

- The EUT had been pre-tested on the positioned of each 3 axis. The worst case was found when positioned on **X-plane**.
- Radiated emission test (below 1GHz) and power line conducted emission test items chosen the worst maximum power.

Radiated Emission Test (Above 1GHz):

- Pre-Scan has been conducted to determine the worst-case mode from all possible combinations between available modulations, data rates and antenna ports (if EUT with antenna diversity architecture).
- Following channel(s) was (were) selected for the final test as listed below.

EUT Configure Mode	Mode	Frequency Band (MHz)	Available Channel	Tested Channel	Modulation Technology	Data Rate (Mbps)	Remark
A	802.11a	5180-5240	36 to 48	36, 40, 48	OFDM	6.0	Radio 3
	802.11n (HT20)		36 to 48	36, 40, 48	OFDM	6.5	Radio 3
	802.11n (HT40)		38 to 46	38, 46	OFDM	13.5	Radio 3
	802.11ac (VHT80)		42	42	OFDM	29.3	Radio 3
A	802.11a	5745-5825	149 to 165	149, 157, 165	OFDM	6.0	Radio 2
	802.11n (HT20)		149 to 165	149, 157, 165	OFDM	6.5	Radio 2
	802.11n (HT40)		151 to 159	151, 159	OFDM	13.5	Radio 2
	802.11ac (VHT80)		155	155	OFDM	29.3	Radio 2

Radiated Emission Test (Below 1GHz):

- Pre-Scan has been conducted to determine the worst-case mode from all possible combinations between available modulations, data rates and antenna ports (if EUT with antenna diversity architecture).
- Following channel(s) was (were) selected for the final test as listed below.

EUT Configure Mode	Mode	Frequency Band (MHz)	Available Channel	Tested Channel	Modulation Technology	Data Rate (Mbps)	Remark
A, B	802.11n (HT20)	5180-5240	36 to 48	40	OFDM	6.5	Radio 3
A, B	802.11n (HT40)	5745-5825	151 to 159	159	OFDM	13.5	Radio 2

Power Line Conducted Emission Test:

- Pre-Scan has been conducted to determine the worst-case mode from all possible combinations between available modulations, data rates and antenna ports (if EUT with antenna diversity architecture).
- Following channel(s) was (were) selected for the final test as listed below.

EUT Configure Mode	Mode	Frequency Band (MHz)	Available Channel	Tested Channel	Modulation Technology	Data Rate (Mbps)	Remark
A, B	802.11n (HT20)	5180-5240	36 to 48	40	OFDM	6.5	Radio 3
A, B	802.11n (HT40)	5745-5825	151 to 159	159	OFDM	13.5	Radio 2

Antenna Port Conducted Measurement:

- This item includes all test value of each mode, but only includes spectrum plot of worst value of each mode.
- Pre-Scan has been conducted to determine the worst-case mode from all possible combinations between available modulations, data rates and antenna ports (if EUT with antenna diversity architecture).
- Following channel(s) was (were) selected for the final test as listed below.

EUT Configure Mode	Mode	Frequency Band (MHz)	Available Channel	Tested Channel	Modulation Technology	Data Rate (Mbps)	Remark
A	802.11a	5180-5240	36 to 48	36, 40, 48	OFDM	6.0	Radio 3
	802.11n (HT20)		36 to 48	36, 40, 48	OFDM	6.5	Radio 3
	802.11n (HT40)		38 to 46	38, 46	OFDM	13.5	Radio 3
	802.11ac (VHT80)		42	42	OFDM	29.3	Radio 3
A	802.11a	5745-5825	149 to 165	149, 157, 165	OFDM	6.0	Radio 2
	802.11n (HT20)		149 to 165	149, 157, 165	OFDM	6.5	Radio 2
	802.11n (HT40)		151 to 159	151, 159	OFDM	13.5	Radio 2
	802.11ac (VHT80)		155	155	OFDM	29.3	Radio 2

Test Condition:

Applicable to	Environmental Conditions	Input Power	Tested by
RE \geq 1G	23 deg. C, 68% RH	120Vac, 60Hz	Adair Peng
RE<1G	23 deg. C, 66% RH	120Vac, 60Hz 54Vdc	Titan Hsu
PLC	23 deg. C, 66% RH	120Vac, 60Hz 54Vdc	Titan Hsu
APCM	25 deg. C, 60% RH	120Vac, 60Hz	Frank Lui

3.3 Duty Cycle of Test Signal

Duty cycle of test signal is < 98%, duty factor is required.

802.11a: Duty cycle = 2.024/2.149 = 0.942, Duty factor = $10 \cdot \log(1/0.942) = 0.26$

802.11n (HT20): Duty cycle = 4.926/5.038 = 0.978, Duty factor = $10 \cdot \log(1/0.978) = 0.10$

802.11n (HT40): Duty cycle = 2.362/3.550 = 0.665, Duty factor = $10 \cdot \log(1/0.665) = 1.77$

802.11ac (VHT80): Duty cycle = 1.050/1.200 = 0.875, Duty factor = $10 \cdot \log(1/0.875) = 0.58$

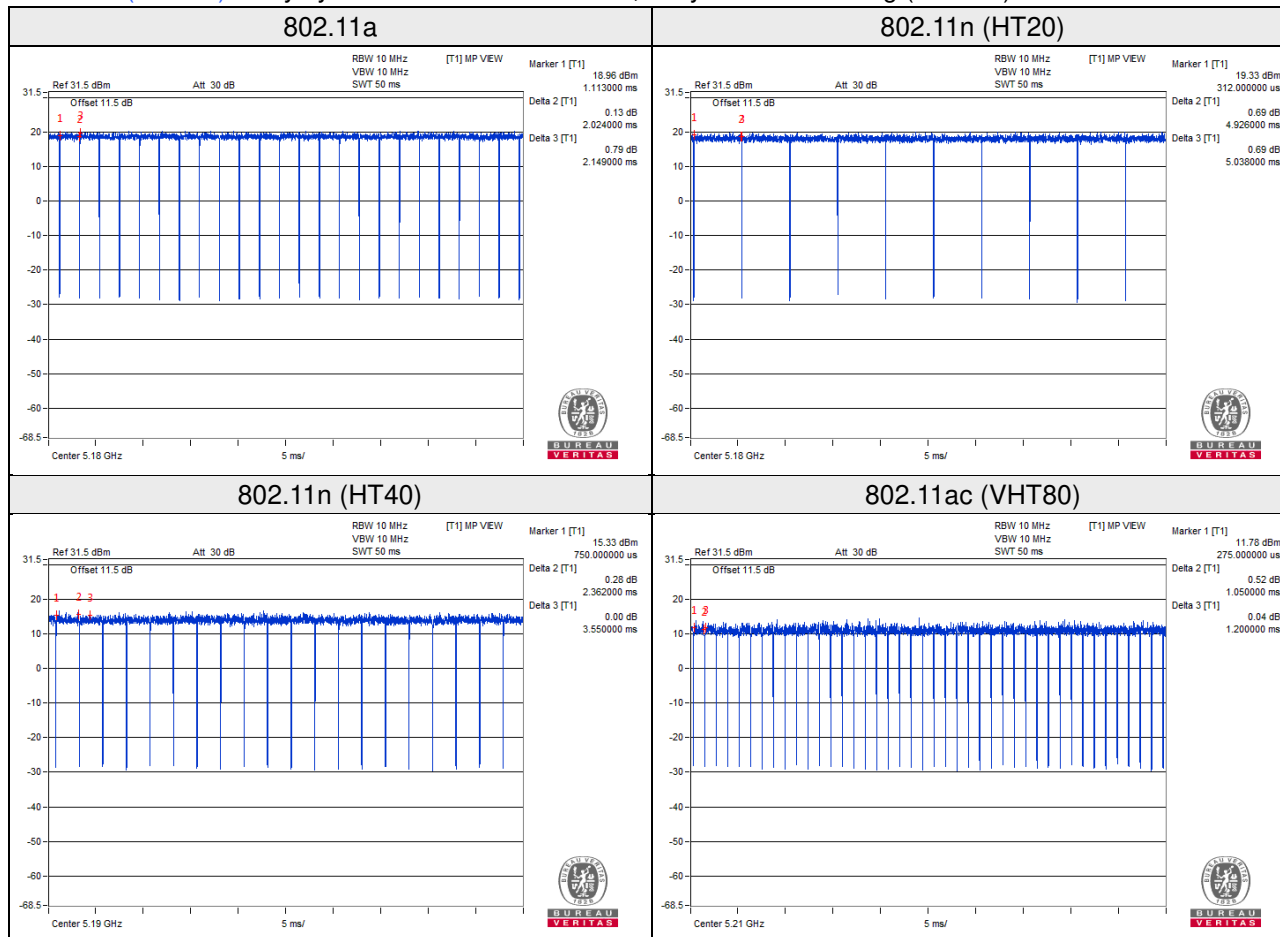

3.4 Description of Support Units

The EUT has been tested as an independent unit together with other necessary accessories or support units. The following support units or accessories were used to form a representative test configuration during the tests.

ID	Product	Brand	Model No.	Serial No.	FCC ID	Remarks
A.	Notebook	DELL	E5410	1HC2XM1	FCC DoC Approved	-
B.	Load	NA	NA	NA	NA	-
C.	Adapter	DEE VAN ENTERPRISE CO., LTD	DSA-12PFT-12 FUS 120100	NA	NA	Provided by manufacturer
D.	POE	EnGenius	EPA5006GP	NA	NA	Provided by manufacturer

Note:

1. All power cords of the above support units are non-shielded (1.8m).
2. Item A acted as a communication partner to transfer data.

ID	Descriptions	Qty.	Length (m)	Shielding (Yes/No)	Cores (Qty.)	Remarks
1.	RJ45, Cat5e	1	1.5	N	0	-
2.	RJ45, Cat5e	1	1.5	N	0	-
3.	RJ45, Cat5e	1	5	N	0	-
4.	DC	1	1.45	-	0	Provided by manufacturer

3.4.1 Configuration of System under Test

Test Mode A

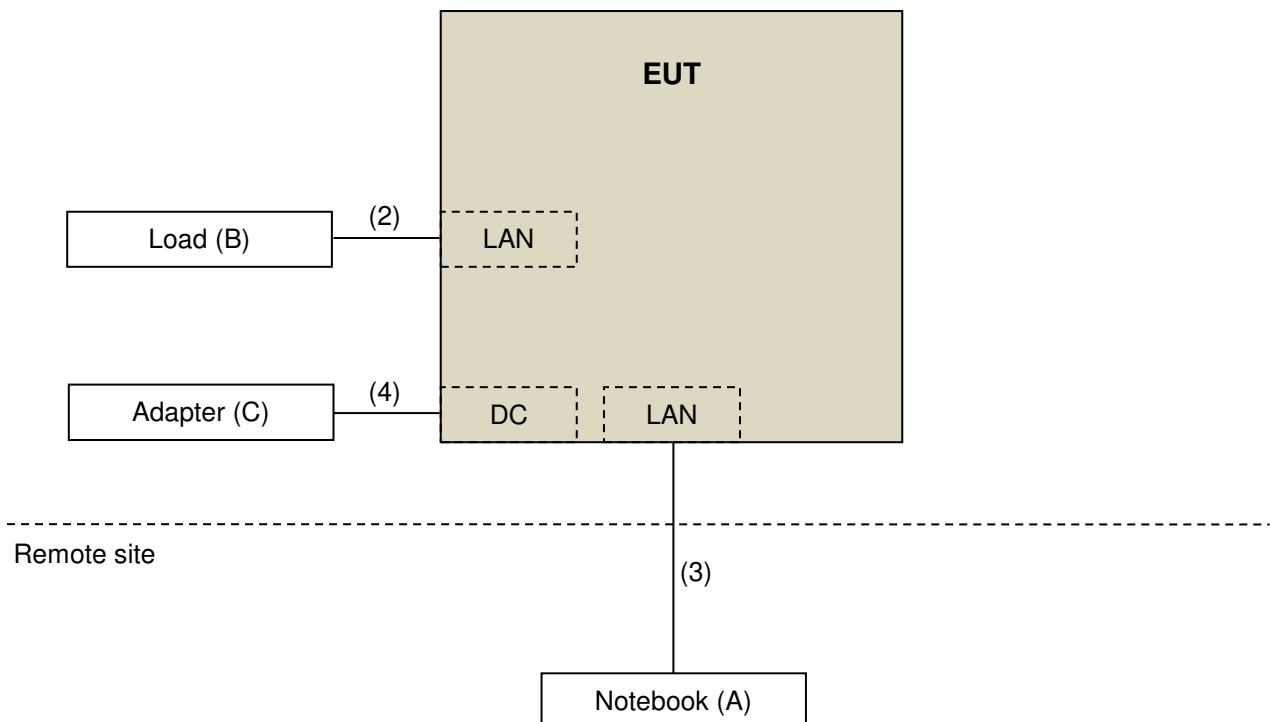

Test Mode B

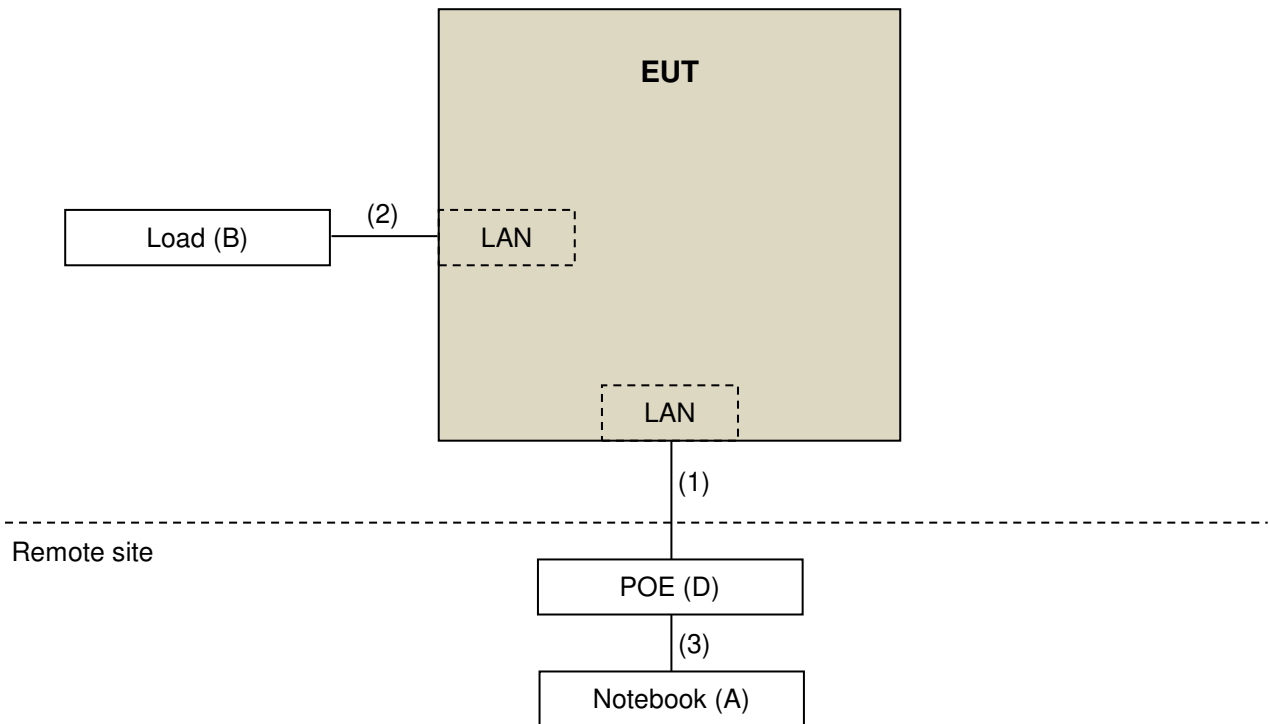

3.5 General Description of Applied Standards

The EUT is a RF Product. According to the specifications of the manufacturer, it must comply with the requirements of the following standards:

FCC Part 15, Subpart E (15.407)

KDB 789033 D02 General UNII Test Procedure New Rules v02r01

KDB 662911 D01 Multiple Transmitter Output v02r01

ANSI C63.10:2013

All test items have been performed and recorded as per the above standards.

4 Test Types and Results

4.1 Radiated Emission and Bandedge Measurement

4.1.1 Limits of Radiated Emission and Bandedge Measurement

Radiated emissions which fall in the restricted bands must comply with the radiated emission limits specified as below table.

Frequencies (MHz)	Field Strength (microvolts/meter)	Measurement Distance (meters)
0.009 ~ 0.490	2400/F(kHz)	300
0.490 ~ 1.705	24000/F(kHz)	30
1.705 ~ 30.0	30	30
30 ~ 88	100	3
88 ~ 216	150	3
216 ~ 960	200	3
Above 960	500	3

Note:

1. The lower limit shall apply at the transition frequencies.
2. Emission level (dBuV/m) = 20 log Emission level (uV/m).
3. For frequencies above 1000MHz, the field strength limits are based on average detector, however, the peak field strength of any emission shall not exceed the maximum permitted average limits, specified above by more than 20dB under any condition of modulation.

Limits of unwanted emission out of the restricted bands

Applicable To		Limit	
789033 D02 General UNII Test Procedure New Rules v02r01		Field Strength at 3m	
		PK: 74 (dBµV/m)	AV: 54 (dBµV/m)
Frequency Band	Applicable To	EIRP Limit	Equivalent Field Strength at 3m
5150~5250 MHz	15.407(b)(1)	PK: -27 (dBm/MHz)	PK: 68.2(dBµV/m)
5250~5350 MHz	15.407(b)(2)		
5470~5725 MHz	15.407(b)(3)		
5725~5850 MHz	<input checked="" type="checkbox"/> 15.407(b)(4)(i)	PK: -27 (dBm/MHz) ^{*1} PK: 10 (dBm/MHz) ^{*2} PK: 15.6 (dBm/MHz) ^{*3} PK: 27 (dBm/MHz) ^{*4}	PK: 68.2(dBµV/m) ^{*1} PK: 105.2 (dBµV/m) ^{*2} PK: 110.8(dBµV/m) ^{*3} PK: 122.2 (dBµV/m) ^{*4}
	<input type="checkbox"/> 15.407(b)(4)(ii)	Emission limits in section 15.247(d)	
^{*1} beyond 75 MHz or more above of the band edge.		^{*2} below the band edge increasing linearly to 10 dBm/MHz at 25 MHz above.	
^{*3} below the band edge increasing linearly to a level of 15.6 dBm/MHz at 5 MHz above.		^{*4} from 5 MHz above or below the band edge increasing linearly to a level of 27 dBm/MHz at the band edge.	

Note: The following formula is used to convert the equipment isotropic radiated power (eirp) to field strength:

$$E = \frac{1000000 \sqrt{30P}}{3} \mu\text{V/m, where P is the eirp (Watts).}$$

4.1.2 Test Instruments

Description & Manufacturer	Model No.	Serial No.	Cal. Date	Cal. Due
Test Receiver ROHDE & SCHWARZ	ESIB7	100187	May 30, 2019	May 29, 2020
BILOG Antenna SCHWARZBECK	VULB9168	9168-171	Nov. 22, 2018	Nov. 21, 2019
HORN Antenna SCHWARZBECK	9120D	209	Nov. 25, 2018	Nov. 24, 2019
HORN Antenna SCHWARZBECK	BBHA 9170	BBHA9170241	Nov. 25, 2018	Nov. 24, 2019
Loop Antenna TESEQ	HLA 6121	45745	Jul. 01, 2019	Jun. 30, 2020
Preamplifier Agilent (Below 1GHz)	8447D	2944A10738	Aug. 20, 2019	Aug. 19, 2020
Preamplifier Agilent (Above 1GHz)	8449B	3008A02465	Mar. 27, 2019	Mar. 26, 2020
RF Coaxial Cable WOKEN With 5dB PAD	8D-FB	Cable-CH3-01	Aug. 20, 2019	Aug. 19, 2020
RF signal cable HUBER+SUHNER	SUCOFLEX 104	Cable-CH3-03 (223653/4)	Aug. 20, 2019	Aug. 19, 2020
RF signal cable HUBER+SUHNER& EMCI	SUCOFLEX 104&EMC104-SM-S M-8000	Cable-CH3-03 (309224+170907)	Aug. 20, 2019	Aug. 19, 2020
Software BV ADT	ADT_Radiated_ V7.6.15.9.5	NA	NA	NA
Antenna Tower inn-co GmbH	MA 4000	013303	NA	NA
Antenna Tower Controller BV ADT	AT100	AT93021702	NA	NA
Turn Table BV ADT	TT100	TT93021702	NA	NA
Turn Table Controller BV ADT	SC100	SC93021702	NA	NA
Boresight Antenna Fixture	FBA-01	FBA-SIP01	NA	NA
Pre-amplifier (18GHz-40GHz) EMC	EMC184045B	980175	Nov. 14, 2018	Nov. 13, 2019
USB Wideband Power Sensor KEYSIGHT	U2021XA	MY55050005/MY5519 0004/MY55190007/MY 55210005	Jul. 15, 2019	Jul. 14, 2020

- Note: 1. The calibration interval of the above test instruments is 12 months and the calibrations are traceable to NML/ROC and NIST/USA.
2. The test was performed in HwaYa Chamber 3.

4.1.3 Test Procedures

For Radiated emission below 30MHz

- a. The EUT was placed on the top of a rotating table 0.8 meters above the ground at a 3 meter chamber room. The table was rotated 360 degrees to determine the position of the highest radiation.
- b. The EUT was set 3 meters away from the interference-receiving antenna, which was mounted on the top of a variable-height antenna tower.
- c. Parallel, perpendicular, and ground-parallel orientations of the antenna are set to make the measurement.
- d. For each suspected emission, the EUT was arranged to its worst case and the rotatable table was turned from 0 degrees to 360 degrees to find the maximum reading.
- e. The test-receiver system was set to Quasi-Peak Detect Function and Specified Bandwidth with Maximum Hold Mode.

Note:

1. The resolution bandwidth and video bandwidth of test receiver/spectrum analyzer is 9kHz at frequency below 30MHz.

For Radiated emission above 30MHz

- a. The EUT was placed on the top of a rotating table 0.8 meters (for 30MHz ~ 1GHz) / 1.5 meters (for above 1GHz) above the ground at 3 meter chamber room for test. The table was rotated 360 degrees to determine the position of the highest radiation.
- b. The EUT was set 3 meters away from the interference-receiving antenna, which was mounted on the top of a variable-height antenna tower.
- c. The height of antenna is varied from one meter to four meters above the ground to determine the maximum value of the field strength. Both horizontal and vertical polarizations of the antenna are set to make the measurement.
- d. For each suspected emission, the EUT was arranged to its worst case and then the antenna was tuned to heights from 1 meter to 4 meters and the rotatable table was turned from 0 degrees to 360 degrees to find the maximum reading.
- e. The test-receiver system was set to quasi-peak detect function and specified bandwidth with maximum hold mode when the test frequency is below 1 GHz.
- f. The test-receiver system was set to peak and average detect function and specified bandwidth with maximum hold mode when the test frequency is above 1 GHz. If the peak reading value also meets average limit, measurement with the average detector is unnecessary.

Note:

1. The resolution bandwidth and video bandwidth of test receiver/spectrum analyzer is 120kHz for Quasi-peak detection (QP) at frequency below 1GHz.
2. The resolution bandwidth of test receiver/spectrum analyzer is 1 MHz and the video bandwidth is 3 MHz for Peak detection (PK) at frequency above 1GHz.
3. The resolution bandwidth of test receiver/spectrum analyzer is 1MHz and the video bandwidth is $\geq 1/T$ (Duty cycle < 98%) or 10Hz (Duty cycle $\geq 98\%$) for Average detection (AV) at frequency above 1GHz. (802.11a: RBW = 1MHz, VBW = 1kHz; 802.11n (HT20): RBW = 1MHz, VBW = 1kHz; 802.11n (HT40): RBW = 1MHz, VBW = 1kHz; 802.11ac (VHT80): RBW = 1MHz, VBW = 1kHz)
4. All modes of operation were investigated and the worst-case emissions are reported.

4.1.4 Deviation from Test Standard

No deviation.

4.1.5 Test Setup

For Radiated emission below 30MHz

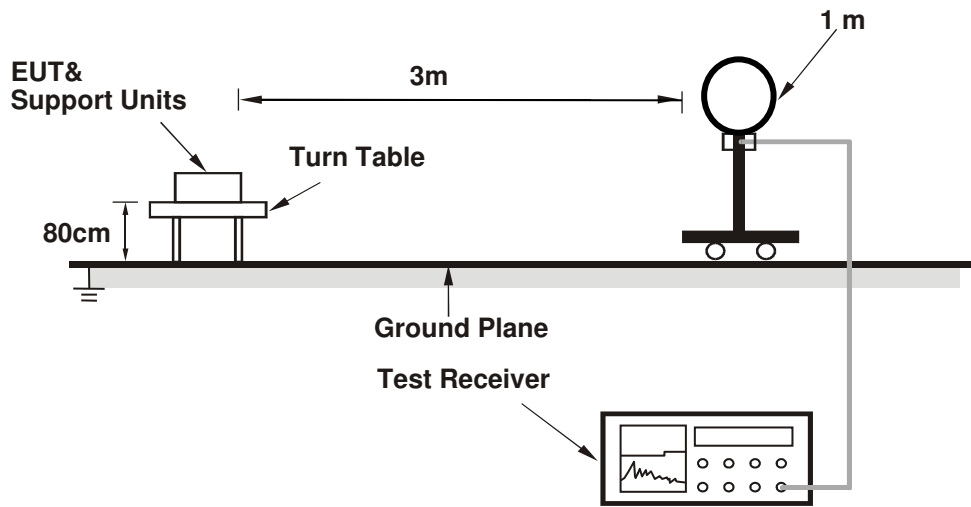

For Radiated emission 30MHz to 1GHz

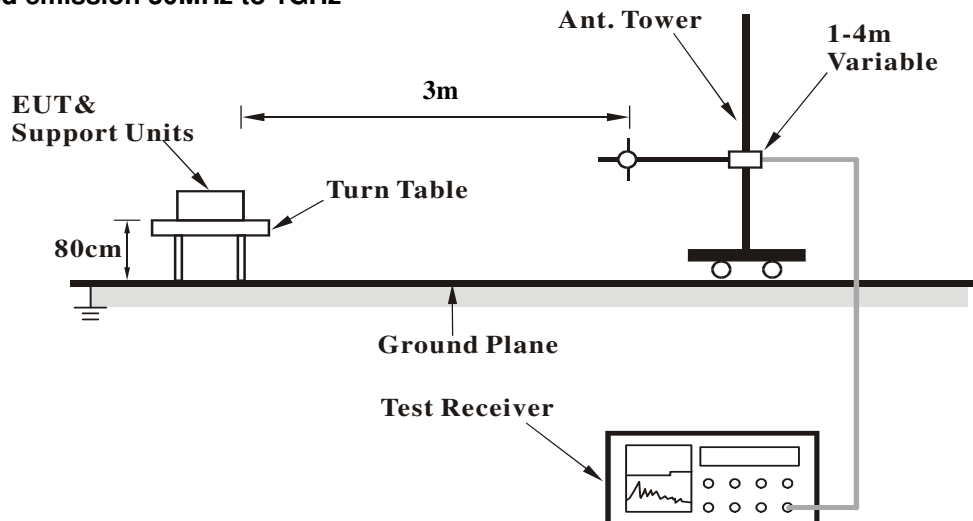

For Radiated emission above 1GHz

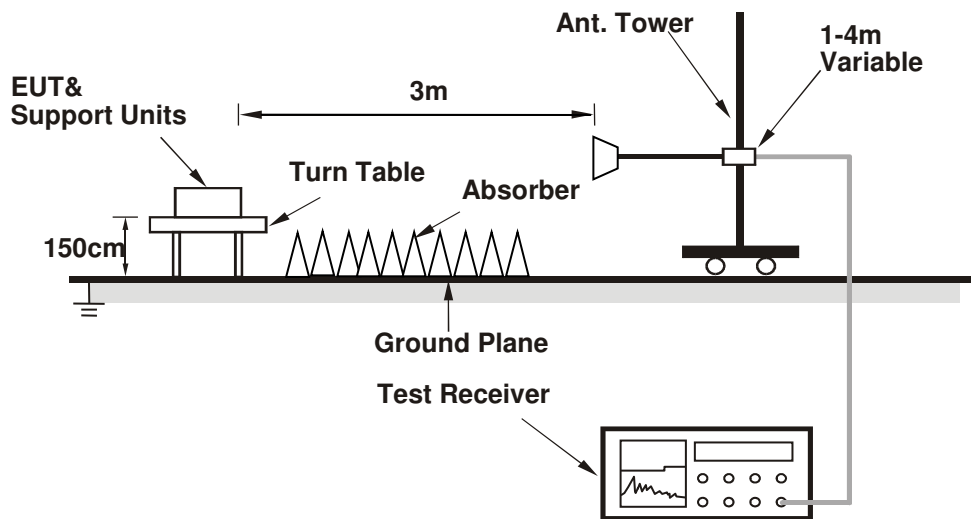

For the actual test configuration, please refer to the attached file (Test Setup Photo).

4.1.6 EUT Operating Conditions

- a. Placed the EUT on the testing table.
- b. Prepared a notebook to act as a communication partner and placed it outside of testing area.
- c. The communication partner connected with EUT via a RJ45 cable and ran a test program (provided by manufacturer) to enable EUT under transmission condition continuously at specific channel frequency.
- d. The communication partner sent data to EUT by command "PING".

4.1.7 Test Results

Above 1GHz data:

802.11a

CHANNEL	TX Channel 36	DETECTOR FUNCTION	Peak (PK) Average (AV)
FREQUENCY RANGE	1GHz ~ 40GHz		

ANTENNA POLARITY & TEST DISTANCE: HORIZONTAL AT 3 M

NO.	FREQ. (MHz)	EMISSION LEVEL (dBuV/m)	LIMIT (dBuV/m)	MARGIN (dB)	ANTENNA HEIGHT (m)	TABLE ANGLE (Degree)	RAW VALUE (dBuV)	CORRECTION FACTOR (dB/m)
1	5150.00	60.7 PK	74.0	-13.3	2.75 H	313	56.5	4.2
2	5150.00	44.8 AV	54.0	-9.2	2.75 H	313	40.6	4.2
3	*5180.00	105.6 PK			3.15 H	300	66.2	39.4
4	*5180.00	94.7 AV			3.15 H	300	55.3	39.4
5	#10360.00	57.7 PK	68.2	-10.5	3.15 H	269	40.2	17.5

ANTENNA POLARITY & TEST DISTANCE: VERTICAL AT 3 M

NO.	FREQ. (MHz)	EMISSION LEVEL (dBuV/m)	LIMIT (dBuV/m)	MARGIN (dB)	ANTENNA HEIGHT (m)	TABLE ANGLE (Degree)	RAW VALUE (dBuV)	CORRECTION FACTOR (dB/m)
1	5150.00	70.1 PK	74.0	-3.9	3.15 V	111	65.9	4.2
2	5150.00	51.5 AV	54.0	-2.5	3.15 V	111	47.3	4.2
3	*5180.00	114.7 PK			3.19 V	99	75.3	39.4
4	*5180.00	104.0 AV			3.19 V	99	64.6	39.4
5	#10360.00	57.0 PK	68.2	-11.2	2.21 V	268	39.5	17.5

Remarks:

1. Emission Level(dBuV/m) = Raw Value(dBuV) + Correction Factor(dB/m).
2. Correction Factor(dB/m) = Antenna Factor(dB/m) + Cable Factor(dB) – Pre-Amplifier Factor(dB).
3. Margin value = Emission Level – Limit value.
4. The other emission levels were very low against the limit.
5. " * ": Fundamental frequency.
6. " # ": The radiated frequency is out of the restricted band.

CHANNEL	TX Channel 40	DETECTOR FUNCTION	Peak (PK) Average (AV)
FREQUENCY RANGE	1GHz ~ 40GHz		

ANTENNA POLARITY & TEST DISTANCE: HORIZONTAL AT 3 M								
NO.	FREQ. (MHz)	EMISSION LEVEL (dBuV/m)	LIMIT (dBuV/m)	MARGIN (dB)	ANTENNA HEIGHT (m)	TABLE ANGLE (Degree)	RAW VALUE (dBuV)	CORRECTION FACTOR (dB/m)
1	*5200.00	110.8 PK			3.93 H	289	71.5	39.3
2	*5200.00	100.5 AV			3.93 H	289	61.2	39.3
3	#10400.00	57.7 PK	68.2	-10.5	2.39 H	202	40.1	17.6

ANTENNA POLARITY & TEST DISTANCE: VERTICAL AT 3 M								
NO.	FREQ. (MHz)	EMISSION LEVEL (dBuV/m)	LIMIT (dBuV/m)	MARGIN (dB)	ANTENNA HEIGHT (m)	TABLE ANGLE (Degree)	RAW VALUE (dBuV)	CORRECTION FACTOR (dB/m)
1	*5200.00	116.3 PK			2.97 V	123	77.0	39.3
2	*5200.00	105.5 AV			2.97 V	123	66.2	39.3
3	#10400.00	57.6 PK	68.2	-10.6	2.98 V	1	40.0	17.6

Remarks:

1. Emission Level(dBuV/m) = Raw Value(dBuV) + Correction Factor(dB/m).
2. Correction Factor(dB/m) = Antenna Factor(dB/m) + Cable Factor(dB) – Pre-Amplifier Factor(dB).
3. Margin value = Emission Level – Limit value.
4. The other emission levels were very low against the limit.
5. " * ": Fundamental frequency.
6. " # ": The radiated frequency is out of the restricted band.

CHANNEL	TX Channel 48	DETECTOR FUNCTION	Peak (PK) Average (AV)
FREQUENCY RANGE	1GHz ~ 40GHz		

ANTENNA POLARITY & TEST DISTANCE: HORIZONTAL AT 3 M

NO.	FREQ. (MHz)	EMISSION LEVEL (dBuV/m)	LIMIT (dBuV/m)	MARGIN (dB)	ANTENNA HEIGHT (m)	TABLE ANGLE (Degree)	RAW VALUE (dBuV)	CORRECTION FACTOR (dB/m)
1	*5240.00	109.9 PK			3.74 H	222	70.8	39.1
2	*5240.00	98.7 AV			3.74 H	222	59.6	39.1
3	5350.00	46.1 PK	74.0	-27.9	3.63 H	203	42.0	4.1
4	5350.00	42.2 AV	54.0	-11.8	3.63 H	203	38.1	4.1
5	#10480.00	58.0 PK	68.2	-10.2	1.75 H	233	39.6	18.4

ANTENNA POLARITY & TEST DISTANCE: VERTICAL AT 3 M

NO.	FREQ. (MHz)	EMISSION LEVEL (dBuV/m)	LIMIT (dBuV/m)	MARGIN (dB)	ANTENNA HEIGHT (m)	TABLE ANGLE (Degree)	RAW VALUE (dBuV)	CORRECTION FACTOR (dB/m)
1	*5240.00	117.1 PK			2.87 V	245	78.0	39.1
2	*5240.00	106.2 AV			2.87 V	245	67.1	39.1
3	5350.00	55.7 PK	74.0	-18.3	3.33 V	221	51.6	4.1
4	5350.00	42.3 AV	54.0	-11.7	3.33 V	221	38.2	4.1
5	#10480.00	57.7 PK	68.2	-10.5	2.78 V	192	39.3	18.4

Remarks:

1. Emission Level(dBuV/m) = Raw Value(dBuV) + Correction Factor(dB/m).
2. Correction Factor(dB/m) = Antenna Factor(dB/m) + Cable Factor(dB) – Pre-Amplifier Factor(dB).
3. Margin value = Emission Level – Limit value.
4. The other emission levels were very low against the limit.
5. " * " : Fundamental frequency.
6. " # " : The radiated frequency is out of the restricted band.

CHANNEL	TX Channel 149	DETECTOR FUNCTION	Peak (PK) Average (AV)
FREQUENCY RANGE	1GHz ~ 40GHz		

ANTENNA POLARITY & TEST DISTANCE: HORIZONTAL AT 3 M

NO.	FREQ. (MHz)	EMISSION LEVEL (dBuV/m)	LIMIT (dBuV/m)	MARGIN (dB)	ANTENNA HEIGHT (m)	TABLE ANGLE (Degree)	RAW VALUE (dBuV)	CORRECTION FACTOR (dB/m)
1	#5635.20	56.9 PK	68.2	-11.3	3.41 H	253	52.5	4.4
2	*5745.00	109.7 PK			3.41 H	253	69.6	40.1
3	*5745.00	98.8 AV			3.41 H	253	58.7	40.1
4	#5925.60	58.2 PK	68.2	-10.0	3.41 H	253	52.8	5.4
5	11490.00	59.9 PK	74.0	-14.1	3.56 H	266	40.6	19.3
6	11490.00	47.1 AV	54.0	-6.9	3.56 H	266	27.8	19.3

ANTENNA POLARITY & TEST DISTANCE: VERTICAL AT 3 M

NO.	FREQ. (MHz)	EMISSION LEVEL (dBuV/m)	LIMIT (dBuV/m)	MARGIN (dB)	ANTENNA HEIGHT (m)	TABLE ANGLE (Degree)	RAW VALUE (dBuV)	CORRECTION FACTOR (dB/m)
1	#5619.20	58.3 PK	68.2	-9.9	2.69 V	40	53.8	4.5
2	*5745.00	117.1 PK			2.69 V	40	77.0	40.1
3	*5745.00	106.5 AV			2.69 V	40	66.4	40.1
4	#5939.20	58.8 PK	68.2	-9.4	2.69 V	40	53.4	5.4
5	11490.00	65.1 PK	74.0	-8.9	3.33 V	193	45.8	19.3
6	11490.00	51.2 AV	54.0	-2.8	3.33 V	193	31.9	19.3

Remarks:

1. Emission Level(dBuV/m) = Raw Value(dBuV) + Correction Factor(dB/m).
2. Correction Factor(dB/m) = Antenna Factor(dB/m) + Cable Factor(dB) – Pre-Amplifier Factor(dB).
3. Margin value = Emission Level – Limit value.
4. The other emission levels were very low against the limit.
5. " * " : Fundamental frequency.
6. " # " : The radiated frequency is out of the restricted band.

CHANNEL	TX Channel 157	DETECTOR FUNCTION	Peak (PK) Average (AV)
FREQUENCY RANGE	1GHz ~ 40GHz		

ANTENNA POLARITY & TEST DISTANCE: HORIZONTAL AT 3 M

NO.	FREQ. (MHz)	EMISSION LEVEL (dBuV/m)	LIMIT (dBuV/m)	MARGIN (dB)	ANTENNA HEIGHT (m)	TABLE ANGLE (Degree)	RAW VALUE (dBuV)	CORRECTION FACTOR (dB/m)
1	#5620.80	58.2 PK	68.2	-10.0	3.66 H	255	53.7	4.5
2	*5785.00	110.2 PK			3.66 H	255	69.9	40.3
3	*5785.00	99.1 AV			3.66 H	255	58.8	40.3
4	#5952.00	58.4 PK	68.2	-9.8	3.66 H	255	53.0	5.4
5	11570.00	58.1 PK	74.0	-15.9	2.23 H	309	39.1	19.0
6	11570.00	44.7 AV	54.0	-9.3	2.23 H	309	25.7	19.0

ANTENNA POLARITY & TEST DISTANCE: VERTICAL AT 3 M

NO.	FREQ. (MHz)	EMISSION LEVEL (dBuV/m)	LIMIT (dBuV/m)	MARGIN (dB)	ANTENNA HEIGHT (m)	TABLE ANGLE (Degree)	RAW VALUE (dBuV)	CORRECTION FACTOR (dB/m)
1	#5639.20	58.1 PK	68.2	-10.1	2.83 V	44	53.7	4.4
2	*5785.00	117.1 PK			2.83 V	44	76.8	40.3
3	*5785.00	106.3 AV			2.83 V	44	66.0	40.3
4	#5924.80	58.1 PK	68.3	-10.2	2.83 V	44	52.7	5.4
5	11570.00	44.7 PK	74.0	-29.3	2.45 V	199	25.7	19.0
6	11570.00	32.0 AV	54.0	-22.0	2.45 V	199	13.0	19.0

Remarks:

1. Emission Level(dBuV/m) = Raw Value(dBuV) + Correction Factor(dB/m).
2. Correction Factor(dB/m) = Antenna Factor(dB/m) + Cable Factor(dB) – Pre-Amplifier Factor(dB).
3. Margin value = Emission Level – Limit value.
4. The other emission levels were very low against the limit.
5. " * " : Fundamental frequency.
6. " # " : The radiated frequency is out of the restricted band.

CHANNEL	TX Channel 165	DETECTOR FUNCTION	Peak (PK) Average (AV)
FREQUENCY RANGE	1GHz ~ 40GHz		

ANTENNA POLARITY & TEST DISTANCE: HORIZONTAL AT 3 M

NO.	FREQ. (MHz)	EMISSION LEVEL (dBuV/m)	LIMIT (dBuV/m)	MARGIN (dB)	ANTENNA HEIGHT (m)	TABLE ANGLE (Degree)	RAW VALUE (dBuV)	CORRECTION FACTOR (dB/m)
1	#5648.80	57.4 PK	68.2	-10.8	3.75 H	242	53.0	4.4
2	*5825.00	110.5 PK			3.75 H	242	70.1	40.4
3	*5825.00	100.1 AV			3.75 H	242	59.7	40.4
4	#5958.40	57.5 PK	68.2	-10.7	3.75 H	242	52.1	5.4
5	11650.00	59.1 PK	74.0	-14.9	2.43 H	266	40.2	18.9
6	11650.00	44.8 AV	54.0	-9.2	2.43 H	266	25.9	18.9

ANTENNA POLARITY & TEST DISTANCE: VERTICAL AT 3 M

NO.	FREQ. (MHz)	EMISSION LEVEL (dBuV/m)	LIMIT (dBuV/m)	MARGIN (dB)	ANTENNA HEIGHT (m)	TABLE ANGLE (Degree)	RAW VALUE (dBuV)	CORRECTION FACTOR (dB/m)
1	#5646.40	57.3 PK	68.2	-10.9	3.15 V	49	52.9	4.4
2	*5825.00	117.2 PK			3.15 V	49	76.8	40.4
3	*5825.00	105.9 AV			3.15 V	49	65.5	40.4
4	#5951.20	57.8 PK	68.2	-10.4	3.15 V	49	52.4	5.4
5	11650.00	57.9 PK	74.0	-16.1	1.35 V	299	39.0	18.9
6	11650.00	48.0 AV	54.0	-6.0	1.35 V	299	29.1	18.9

Remarks:

1. Emission Level(dBuV/m) = Raw Value(dBuV) + Correction Factor(dB/m).
2. Correction Factor(dB/m) = Antenna Factor(dB/m) + Cable Factor(dB) – Pre-Amplifier Factor(dB).
3. Margin value = Emission Level – Limit value.
4. The other emission levels were very low against the limit.
5. " * " : Fundamental frequency.
6. " # " : The radiated frequency is out of the restricted band.

802.11n (HT20)

CHANNEL	TX Channel 36	DETECTOR FUNCTION	Peak (PK) Average (AV)
FREQUENCY RANGE	1GHz ~ 40GHz		

ANTENNA POLARITY & TEST DISTANCE: HORIZONTAL AT 3 M

NO.	FREQ. (MHz)	EMISSION LEVEL (dBuV/m)	LIMIT (dBuV/m)	MARGIN (dB)	ANTENNA HEIGHT (m)	TABLE ANGLE (Degree)	RAW VALUE (dBuV)	CORRECTION FACTOR (dB/m)
1	5150.00	59.3 PK	74.0	-14.7	3.39 H	285	55.1	4.2
2	5150.00	45.2 AV	54.0	-8.8	3.39 H	285	41.0	4.2
3	*5180.00	105.3 PK			3.09 H	299	65.9	39.4
4	*5180.00	93.9 AV			3.09 H	299	54.5	39.4
5	#10360.00	57.7 PK	68.2	-10.5	2.41 H	133	40.2	17.5

ANTENNA POLARITY & TEST DISTANCE: VERTICAL AT 3 M

NO.	FREQ. (MHz)	EMISSION LEVEL (dBuV/m)	LIMIT (dBuV/m)	MARGIN (dB)	ANTENNA HEIGHT (m)	TABLE ANGLE (Degree)	RAW VALUE (dBuV)	CORRECTION FACTOR (dB/m)
1	5150.00	68.0 PK	74.0	-6.0	3.05 V	229	63.8	4.2
2	5150.00	51.3 AV	54.0	-2.7	3.05 V	229	47.1	4.2
3	*5180.00	114.5 PK			2.97 V	233	75.1	39.4
4	*5180.00	103.3 AV			2.97 V	233	63.9	39.4
5	#10360.00	56.2 PK	68.2	-12.0	2.75 V	139	38.7	17.5

Remarks:

1. Emission Level(dBuV/m) = Raw Value(dBuV) + Correction Factor(dB/m).
2. Correction Factor(dB/m) = Antenna Factor(dB/m) + Cable Factor(dB) – Pre-Amplifier Factor(dB).
3. Margin value = Emission Level – Limit value.
4. The other emission levels were very low against the limit.
5. " * ": Fundamental frequency.
6. " # ": The radiated frequency is out of the restricted band.

CHANNEL	TX Channel 40	DETECTOR FUNCTION	Peak (PK) Average (AV)
FREQUENCY RANGE	1GHz ~ 40GHz		

ANTENNA POLARITY & TEST DISTANCE: HORIZONTAL AT 3 M

NO.	FREQ. (MHz)	EMISSION LEVEL (dBuV/m)	LIMIT (dBuV/m)	MARGIN (dB)	ANTENNA HEIGHT (m)	TABLE ANGLE (Degree)	RAW VALUE (dBuV)	CORRECTION FACTOR (dB/m)
1	*5200.00	111.1 PK			3.63 H	277	71.8	39.3
2	*5200.00	109.7 AV			3.63 H	277	70.4	39.3
3	#10400.00	57.3 PK	68.2	-10.9	2.03 H	233	39.7	17.6

ANTENNA POLARITY & TEST DISTANCE: VERTICAL AT 3 M

NO.	FREQ. (MHz)	EMISSION LEVEL (dBuV/m)	LIMIT (dBuV/m)	MARGIN (dB)	ANTENNA HEIGHT (m)	TABLE ANGLE (Degree)	RAW VALUE (dBuV)	CORRECTION FACTOR (dB/m)
1	*5200.00	116.2 PK			2.66 V	136	76.9	39.3
2	*5200.00	105.2 AV			2.66 V	136	65.9	39.3
3	#10400.00	56.7 PK	68.2	-11.5	2.63 V	339	39.1	17.6

Remarks:

1. Emission Level(dBuV/m) = Raw Value(dBuV) + Correction Factor(dB/m).
2. Correction Factor(dB/m) = Antenna Factor(dB/m) + Cable Factor(dB) – Pre-Amplifier Factor(dB).
3. Margin value = Emission Level – Limit value.
4. The other emission levels were very low against the limit.
5. " * ": Fundamental frequency.
6. " # ": The radiated frequency is out of the restricted band.

CHANNEL	TX Channel 48	DETECTOR FUNCTION	Peak (PK) Average (AV)
FREQUENCY RANGE	1GHz ~ 40GHz		

ANTENNA POLARITY & TEST DISTANCE: HORIZONTAL AT 3 M

NO.	FREQ. (MHz)	EMISSION LEVEL (dBuV/m)	LIMIT (dBuV/m)	MARGIN (dB)	ANTENNA HEIGHT (m)	TABLE ANGLE (Degree)	RAW VALUE (dBuV)	CORRECTION FACTOR (dB/m)
1	*5240.00	110.7 PK			3.66 H	277	71.6	39.1
2	*5240.00	99.5 AV			3.66 H	277	60.4	39.1
3	5350.00	56.3 PK	74.0	-17.7	3.91 H	293	52.2	4.1
4	5350.00	42.1 AV	54.0	-11.9	3.91 H	293	38.0	4.1
5	#10480.00	57.9 PK	68.2	-10.3	2.05 H	255	39.5	18.4

ANTENNA POLARITY & TEST DISTANCE: VERTICAL AT 3 M

NO.	FREQ. (MHz)	EMISSION LEVEL (dBuV/m)	LIMIT (dBuV/m)	MARGIN (dB)	ANTENNA HEIGHT (m)	TABLE ANGLE (Degree)	RAW VALUE (dBuV)	CORRECTION FACTOR (dB/m)
1	*5240.00	116.7 PK			2.57 V	309	77.6	39.1
2	*5240.00	105.9 AV			2.57 V	309	66.8	39.1
3	5350.00	55.7 PK	74.0	-18.3	2.85 V	299	51.6	4.1
4	5350.00	42.7 AV	54.0	-11.3	2.85 V	299	38.6	4.1
5	#10480.00	57.7 PK	68.2	-10.5	2.55 V	319	39.3	18.4

Remarks:

1. Emission Level(dBuV/m) = Raw Value(dBuV) + Correction Factor(dB/m).
2. Correction Factor(dB/m) = Antenna Factor(dB/m) + Cable Factor(dB) – Pre-Amplifier Factor(dB).
3. Margin value = Emission Level – Limit value.
4. The other emission levels were very low against the limit.
5. " * ": Fundamental frequency.
6. " # ": The radiated frequency is out of the restricted band.

CHANNEL	TX Channel 149	DETECTOR FUNCTION	Peak (PK) Average (AV)
FREQUENCY RANGE	1GHz ~ 40GHz		

ANTENNA POLARITY & TEST DISTANCE: HORIZONTAL AT 3 M

NO.	FREQ. (MHz)	EMISSION LEVEL (dBuV/m)	LIMIT (dBuV/m)	MARGIN (dB)	ANTENNA HEIGHT (m)	TABLE ANGLE (Degree)	RAW VALUE (dBuV)	CORRECTION FACTOR (dB/m)
1	#5625.60	57.9 PK	68.2	-10.3	3.33 H	221	53.5	4.4
2	*5745.00	110.0 PK			3.33 H	221	69.9	40.1
3	*5745.00	99.1 AV			3.33 H	221	59.0	40.1
4	#5932.80	57.4 PK	68.2	-10.8	3.33 H	221	52.0	5.4
5	11490.00	41.5 PK	74.0	-32.5	3.59 H	266	22.2	19.3
6	11490.00	28.9 AV	54.0	-25.1	3.59 H	266	9.6	19.3

ANTENNA POLARITY & TEST DISTANCE: VERTICAL AT 3 M

NO.	FREQ. (MHz)	EMISSION LEVEL (dBuV/m)	LIMIT (dBuV/m)	MARGIN (dB)	ANTENNA HEIGHT (m)	TABLE ANGLE (Degree)	RAW VALUE (dBuV)	CORRECTION FACTOR (dB/m)
1	#5634.40	58.1 PK	68.2	-10.1	2.75 V	45	53.7	4.4
2	*5745.00	117.2 PK			2.75 V	45	77.1	40.1
3	*5745.00	106.3 AV			2.75 V	45	66.2	40.1
4	#5948.80	57.7 PK	68.2	-10.5	2.75 V	45	52.3	5.4
5	11490.00	63.3 PK	74.0	-10.7	2.23 V	199	44.0	19.3
6	11490.00	49.2 AV	54.0	-4.8	2.23 V	199	29.9	19.3

Remarks:

1. Emission Level(dBuV/m) = Raw Value(dBuV) + Correction Factor(dB/m).
2. Correction Factor(dB/m) = Antenna Factor(dB/m) + Cable Factor(dB) – Pre-Amplifier Factor(dB).
3. Margin value = Emission Level – Limit value.
4. The other emission levels were very low against the limit.
5. " * " : Fundamental frequency.
6. " # " : The radiated frequency is out of the restricted band.

CHANNEL	TX Channel 157	DETECTOR FUNCTION	Peak (PK) Average (AV)
FREQUENCY RANGE	1GHz ~ 40GHz		

ANTENNA POLARITY & TEST DISTANCE: HORIZONTAL AT 3 M

NO.	FREQ. (MHz)	EMISSION LEVEL (dBuV/m)	LIMIT (dBuV/m)	MARGIN (dB)	ANTENNA HEIGHT (m)	TABLE ANGLE (Degree)	RAW VALUE (dBuV)	CORRECTION FACTOR (dB/m)
1	#5627.20	57.7 PK	68.2	-10.5	2.85 H	233	53.3	4.4
2	*5785.00	107.9 PK			2.85 H	233	67.6	40.3
3	*5785.00	96.7 AV			2.85 H	233	56.4	40.3
4	#5928.00	58.6 PK	68.2	-9.6	2.85 H	233	53.2	5.4
5	11570.00	58.3 PK	74.0	-15.7	1.99 H	255	39.3	19.0
6	11570.00	44.9 AV	54.0	-9.1	1.99 H	255	25.9	19.0

ANTENNA POLARITY & TEST DISTANCE: VERTICAL AT 3 M

NO.	FREQ. (MHz)	EMISSION LEVEL (dBuV/m)	LIMIT (dBuV/m)	MARGIN (dB)	ANTENNA HEIGHT (m)	TABLE ANGLE (Degree)	RAW VALUE (dBuV)	CORRECTION FACTOR (dB/m)
1	#5622.40	58.2 PK	68.2	-10.0	2.49 V	33	53.8	4.4
2	*5785.00	116.9 PK			2.49 V	33	76.6	40.3
3	*5785.00	106.2 AV			2.49 V	33	65.9	40.3
4	#5940.00	57.9 PK	68.2	-10.3	2.49 V	33	52.5	5.4
5	11570.00	62.1 PK	74.0	-11.9	2.35 V	199	43.1	19.0
6	11570.00	47.8 AV	54.0	-6.2	2.35 V	199	28.8	19.0

Remarks:

1. Emission Level(dBuV/m) = Raw Value(dBuV) + Correction Factor(dB/m).
2. Correction Factor(dB/m) = Antenna Factor(dB/m) + Cable Factor(dB) – Pre-Amplifier Factor(dB).
3. Margin value = Emission Level – Limit value.
4. The other emission levels were very low against the limit.
5. " * " : Fundamental frequency.
6. " # " : The radiated frequency is out of the restricted band.

CHANNEL	TX Channel 165	DETECTOR FUNCTION	Peak (PK) Average (AV)
FREQUENCY RANGE	1GHz ~ 40GHz		

ANTENNA POLARITY & TEST DISTANCE: HORIZONTAL AT 3 M

NO.	FREQ. (MHz)	EMISSION LEVEL (dBuV/m)	LIMIT (dBuV/m)	MARGIN (dB)	ANTENNA HEIGHT (m)	TABLE ANGLE (Degree)	RAW VALUE (dBuV)	CORRECTION FACTOR (dB/m)
1	#5615.20	58.0 PK	68.2	-10.2	3.09 H	233	53.5	4.5
2	*5825.00	108.3 PK			3.09 H	233	67.9	40.4
3	*5825.00	97.3 AV			3.09 H	233	56.9	40.4
4	#5945.60	58.0 PK	68.2	-10.2	3.09 H	233	52.6	5.4
5	11650.00	57.5 PK	74.0	-16.5	2.99 H	279	38.6	18.9
6	11650.00	44.7 AV	54.0	-9.3	2.99 H	279	25.8	18.9

ANTENNA POLARITY & TEST DISTANCE: VERTICAL AT 3 M

NO.	FREQ. (MHz)	EMISSION LEVEL (dBuV/m)	LIMIT (dBuV/m)	MARGIN (dB)	ANTENNA HEIGHT (m)	TABLE ANGLE (Degree)	RAW VALUE (dBuV)	CORRECTION FACTOR (dB/m)
1	#5616.80	57.8 PK	68.2	-10.4	3.37 V	47	53.3	4.5
2	*5825.00	117.8 PK			3.37 V	47	77.4	40.4
3	*5825.00	106.8 AV			3.37 V	47	66.4	40.4
4	#5929.60	58.9 PK	68.2	-9.3	3.37 V	47	53.5	5.4
5	11650.00	57.9 PK	74.0	-16.1	1.23 V	277	39.0	18.9
6	11650.00	48.0 AV	54.0	-6.0	1.23 V	277	29.1	18.9

Remarks:

1. Emission Level(dBuV/m) = Raw Value(dBuV) + Correction Factor(dB/m).
2. Correction Factor(dB/m) = Antenna Factor(dB/m) + Cable Factor(dB) – Pre-Amplifier Factor(dB).
3. Margin value = Emission Level – Limit value.
4. The other emission levels were very low against the limit.
5. " * " : Fundamental frequency.
6. " # " : The radiated frequency is out of the restricted band.

802.11n (HT40)

CHANNEL	TX Channel 38	DETECTOR FUNCTION	Peak (PK) Average (AV)
FREQUENCY RANGE	1GHz ~ 40GHz		

ANTENNA POLARITY & TEST DISTANCE: HORIZONTAL AT 3 M

NO.	FREQ. (MHz)	EMISSION LEVEL (dBuV/m)	LIMIT (dBuV/m)	MARGIN (dB)	ANTENNA HEIGHT (m)	TABLE ANGLE (Degree)	RAW VALUE (dBuV)	CORRECTION FACTOR (dB/m)
1	5150.00	61.0 PK	74.0	-13.0	3.15 H	177	56.8	4.2
2	5150.00	44.1 AV	54.0	-9.9	3.15 H	177	39.9	4.2
3	*5190.00	102.2 PK			3.43 H	203	62.9	39.3
4	*5190.00	91.9 AV			3.43 H	203	52.6	39.3
5	#10380.00	57.0 PK	68.2	-11.2	1.85 H	233	39.3	17.7

ANTENNA POLARITY & TEST DISTANCE: VERTICAL AT 3 M

NO.	FREQ. (MHz)	EMISSION LEVEL (dBuV/m)	LIMIT (dBuV/m)	MARGIN (dB)	ANTENNA HEIGHT (m)	TABLE ANGLE (Degree)	RAW VALUE (dBuV)	CORRECTION FACTOR (dB/m)
1	5150.00	67.5 PK	74.0	-6.5	2.53 V	111	63.3	4.2
2	5150.00	51.3 AV	54.0	-2.7	2.53 V	111	47.1	4.2
3	*5190.00	110.0 PK			2.93 V	119	70.7	39.3
4	*5190.00	99.7 AV			2.93 V	119	60.4	39.3
5	#10380.00	57.7 PK	68.2	-10.5	2.63 V	70	40.0	17.7

Remarks:

1. Emission Level(dBuV/m) = Raw Value(dBuV) + Correction Factor(dB/m).
2. Correction Factor(dB/m) = Antenna Factor(dB/m) + Cable Factor(dB) – Pre-Amplifier Factor(dB).
3. Margin value = Emission Level – Limit value.
4. The other emission levels were very low against the limit.
5. " * ": Fundamental frequency.
6. " # ": The radiated frequency is out of the restricted band.

CHANNEL	TX Channel 46	DETECTOR FUNCTION	Peak (PK) Average (AV)
FREQUENCY RANGE	1GHz ~ 40GHz		

ANTENNA POLARITY & TEST DISTANCE: HORIZONTAL AT 3 M

NO.	FREQ. (MHz)	EMISSION LEVEL (dBuV/m)	LIMIT (dBuV/m)	MARGIN (dB)	ANTENNA HEIGHT (m)	TABLE ANGLE (Degree)	RAW VALUE (dBuV)	CORRECTION FACTOR (dB/m)
1	5150.00	58.3 PK	74.0	-15.7	3.53 H	233	54.1	4.2
2	5150.00	44.3 AV	54.0	-9.7	3.53 H	233	40.1	4.2
3	*5230.00	105.2 PK			3.70 H	213	66.1	39.1
4	*5230.00	96.0 AV			3.70 H	213	56.9	39.1
5	5350.00	55.3 PK	74.0	-18.7	3.57 H	250	51.2	4.1
6	5350.00	42.1 AV	54.0	-11.9	3.57 H	250	38.0	4.1
7	#10460.00	57.1 PK	68.2	-11.1	1.99 H	211	38.9	18.2

ANTENNA POLARITY & TEST DISTANCE: VERTICAL AT 3 M

NO.	FREQ. (MHz)	EMISSION LEVEL (dBuV/m)	LIMIT (dBuV/m)	MARGIN (dB)	ANTENNA HEIGHT (m)	TABLE ANGLE (Degree)	RAW VALUE (dBuV)	CORRECTION FACTOR (dB/m)
1	5150.00	66.4 PK	74.0	-7.6	3.03 V	266	62.2	4.2
2	5150.00	50.1 AV	54.0	-3.9	3.03 V	266	45.9	4.2
3	*5230.00	114.5 PK			2.85 V	233	75.4	39.1
4	*5230.00	103.7 AV			2.85 V	233	64.6	39.1
5	5350.00	57.5 PK	74.0	-16.5	2.99 V	243	53.4	4.1
6	5350.00	43.1 AV	54.0	-10.9	2.99 V	243	39.0	4.1
7	#10460.00	58.0 PK	68.2	-10.2	2.53 V	320	39.8	18.2

Remarks:

1. Emission Level(dBuV/m) = Raw Value(dBuV) + Correction Factor(dB/m).
2. Correction Factor(dB/m) = Antenna Factor(dB/m) + Cable Factor(dB) – Pre-Amplifier Factor(dB).
3. Margin value = Emission Level – Limit value.
4. The other emission levels were very low against the limit.
5. " * ": Fundamental frequency.
6. " # ": The radiated frequency is out of the restricted band.

CHANNEL	TX Channel 151	DETECTOR FUNCTION	Peak (PK) Average (AV)
FREQUENCY RANGE	1GHz ~ 40GHz		

ANTENNA POLARITY & TEST DISTANCE: HORIZONTAL AT 3 M

NO.	FREQ. (MHz)	EMISSION LEVEL (dBuV/m)	LIMIT (dBuV/m)	MARGIN (dB)	ANTENNA HEIGHT (m)	TABLE ANGLE (Degree)	RAW VALUE (dBuV)	CORRECTION FACTOR (dB/m)
1	#5637.60	58.3 PK	68.2	-9.9	3.33 H	231	53.9	4.4
2	#5650.00	57.0 PK	68.2	-11.2	3.31 H	215	52.6	4.4
3	*5755.00	106.4 PK			3.33 H	231	66.3	40.1
4	*5755.00	96.5 AV			3.33 H	231	56.4	40.1
5	#5936.80	57.5 PK	68.2	-10.7	3.33 H	231	52.1	5.4
6	11510.00	56.5 PK	74.0	-17.5	2.85 H	236	37.1	19.4
7	11510.00	44.2 AV	54.0	-9.8	2.85 H	236	24.8	19.4

ANTENNA POLARITY & TEST DISTANCE: VERTICAL AT 3 M

NO.	FREQ. (MHz)	EMISSION LEVEL (dBuV/m)	LIMIT (dBuV/m)	MARGIN (dB)	ANTENNA HEIGHT (m)	TABLE ANGLE (Degree)	RAW VALUE (dBuV)	CORRECTION FACTOR (dB/m)
1	#5647.20	59.8 PK	68.2	-8.4	2.85 V	39	55.4	4.4
2	#5650.00	66.0 PK	68.2	-2.2	2.85 V	37	61.6	4.4
3	*5755.00	114.4 PK			2.85 V	39	74.3	40.1
4	*5755.00	103.5 AV			2.85 V	39	63.4	40.1
5	#5932.80	58.2 PK	68.2	-10.0	2.85 V	39	52.8	5.4
6	11510.00	60.3 PK	74.0	-13.7	2.45 V	199	40.9	19.4
7	11510.00	47.5 AV	54.0	-6.5	2.45 V	199	28.1	19.4

Remarks:

1. Emission Level(dBuV/m) = Raw Value(dBuV) + Correction Factor(dB/m).
2. Correction Factor(dB/m) = Antenna Factor(dB/m) + Cable Factor(dB) – Pre-Amplifier Factor(dB).
3. Margin value = Emission Level – Limit value.
4. The other emission levels were very low against the limit.
5. " * ": Fundamental frequency.
6. " # ": The radiated frequency is out of the restricted band.

CHANNEL	TX Channel 159	DETECTOR FUNCTION	Peak (PK) Average (AV)
FREQUENCY RANGE	1GHz ~ 40GHz		

ANTENNA POLARITY & TEST DISTANCE: HORIZONTAL AT 3 M

NO.	FREQ. (MHz)	EMISSION LEVEL (dBuV/m)	LIMIT (dBuV/m)	MARGIN (dB)	ANTENNA HEIGHT (m)	TABLE ANGLE (Degree)	RAW VALUE (dBuV)	CORRECTION FACTOR (dB/m)
1	#5646.40	57.8 PK	68.2	-10.4	2.85 H	41	53.4	4.4
2	*5795.00	115.5 PK			2.85 H	41	75.1	40.4
3	*5795.00	104.7 AV			2.85 H	41	64.3	40.4
4	#5944.00	58.9 PK	68.2	-9.3	2.85 H	41	53.5	5.4
5	11590.00	57.2 PK	74.0	-16.8	1.23 H	333	38.3	18.9
6	11590.00	46.8 AV	54.0	-7.2	1.23 H	333	27.9	18.9

ANTENNA POLARITY & TEST DISTANCE: VERTICAL AT 3 M

NO.	FREQ. (MHz)	EMISSION LEVEL (dBuV/m)	LIMIT (dBuV/m)	MARGIN (dB)	ANTENNA HEIGHT (m)	TABLE ANGLE (Degree)	RAW VALUE (dBuV)	CORRECTION FACTOR (dB/m)
1	#5620.00	57.7 PK	68.2	-10.5	3.71 V	250	53.2	4.5
2	*5795.00	108.3 PK			3.71 V	250	67.9	40.4
3	*5795.00	97.7 AV			3.71 V	250	57.3	40.4
4	#5951.20	58.4 PK	68.2	-9.8	3.71 V	250	53.0	5.4
5	11590.00	58.3 PK	74.0	-15.7	2.35 V	277	39.4	18.9
6	11590.00	44.9 AV	54.0	-9.1	2.35 V	277	26.0	18.9

Remarks:

1. Emission Level(dBuV/m) = Raw Value(dBuV) + Correction Factor(dB/m).
2. Correction Factor(dB/m) = Antenna Factor(dB/m) + Cable Factor(dB) – Pre-Amplifier Factor(dB).
3. Margin value = Emission Level – Limit value.
4. The other emission levels were very low against the limit.
5. " * " : Fundamental frequency.
6. " # " : The radiated frequency is out of the restricted band.

802.11ac (VHT80)

CHANNEL	TX Channel 42	DETECTOR FUNCTION	Peak (PK) Average (AV)
FREQUENCY RANGE	1GHz ~ 40GHz		

ANTENNA POLARITY & TEST DISTANCE: HORIZONTAL AT 3 M								
NO.	FREQ. (MHz)	EMISSION LEVEL (dBuV/m)	LIMIT (dBuV/m)	MARGIN (dB)	ANTENNA HEIGHT (m)	TABLE ANGLE (Degree)	RAW VALUE (dBuV)	CORRECTION FACTOR (dB/m)
1	5150.00	58.5 PK	74.0	-15.5	3.23 H	277	54.3	4.2
2	5150.00	44.2 AV	54.0	-9.8	3.23 H	277	40.0	4.2
3	*5210.00	97.3 PK			3.19 H	222	58.1	39.2
4	*5210.00	87.1 AV			3.19 H	222	47.9	39.2
5	5350.00	55.5 PK	74.0	-18.5	3.49 H	239	51.4	4.1
6	5350.00	41.9 AV	54.0	-12.1	3.49 H	239	37.8	4.1
7	#10420.00	56.7 PK	68.2	-11.5	1.69 H	250	38.8	17.9

ANTENNA POLARITY & TEST DISTANCE: VERTICAL AT 3 M								
NO.	FREQ. (MHz)	EMISSION LEVEL (dBuV/m)	LIMIT (dBuV/m)	MARGIN (dB)	ANTENNA HEIGHT (m)	TABLE ANGLE (Degree)	RAW VALUE (dBuV)	CORRECTION FACTOR (dB/m)
1	5150.00	66.5 PK	74.0	-7.5	2.43 V	119	62.3	4.2
2	5150.00	51.2 AV	54.0	-2.8	2.43 V	119	47.0	4.2
3	*5210.00	104.5 PK			2.53 V	123	65.3	39.2
4	*5210.00	95.0 AV			2.53 V	123	55.8	39.2
5	5350.00	55.7 PK	74.0	-18.3	2.13 V	123	51.6	4.1
6	5350.00	42.5 AV	54.0	-11.5	2.13 V	123	38.4	4.1
7	#10420.00	56.2 PK	68.2	-12.0	1.99 V	166	38.3	17.9

Remarks:

1. Emission Level(dBuV/m) = Raw Value(dBuV) + Correction Factor(dB/m).
2. Correction Factor(dB/m) = Antenna Factor(dB/m) + Cable Factor(dB) – Pre-Amplifier Factor(dB).
3. Margin value = Emission Level – Limit value.
4. The other emission levels were very low against the limit.
5. " * ": Fundamental frequency.
6. " # ": The radiated frequency is out of the restricted band.

CHANNEL	TX Channel 155	DETECTOR FUNCTION	Peak (PK) Average (AV)
FREQUENCY RANGE	1GHz ~ 40GHz		

ANTENNA POLARITY & TEST DISTANCE: HORIZONTAL AT 3 M

NO.	FREQ. (MHz)	EMISSION LEVEL (dBuV/m)	LIMIT (dBuV/m)	MARGIN (dB)	ANTENNA HEIGHT (m)	TABLE ANGLE (Degree)	RAW VALUE (dBuV)	CORRECTION FACTOR (dB/m)
1	#5627.20	58.7 PK	68.2	-9.5	3.91 H	244	54.3	4.4
2	#5650.00	57.3 PK	68.2	-10.9	3.63 H	222	52.9	4.4
3	*5775.00	100.9 PK			3.91 H	244	60.7	40.2
4	*5775.00	90.8 AV			3.91 H	244	50.6	40.2
5	#5925.00	57.5 PK	68.2	-10.7	3.54 H	266	52.1	5.4
6	#5955.20	57.3 PK	68.2	-10.9	3.91 H	244	51.9	5.4
7	11550.00	57.7 PK	74.0	-16.3	2.54 H	166	38.5	19.2
8	11550.00	44.8 AV	54.0	-9.2	2.54 H	166	25.6	19.2

ANTENNA POLARITY & TEST DISTANCE: VERTICAL AT 3 M

NO.	FREQ. (MHz)	EMISSION LEVEL (dBuV/m)	LIMIT (dBuV/m)	MARGIN (dB)	ANTENNA HEIGHT (m)	TABLE ANGLE (Degree)	RAW VALUE (dBuV)	CORRECTION FACTOR (dB/m)
1	#5645.60	57.2 PK	68.2	-11.0	2.81 V	42	52.8	4.4
2	#5650.00	65.8 PK	68.2	-2.4	2.85 V	44	61.4	4.4
3	*5775.00	108.0 PK			2.81 V	42	67.8	40.2
4	*5775.00	97.9 AV			2.81 V	42	57.7	40.2
5	#5925.00	60.7 PK	68.2	-7.5	2.97 V	50	55.3	5.4
6	#5928.80	53.8 PK	68.2	-14.4	2.81 V	42	48.4	5.4
7	11550.00	58.7 PK	74.0	-15.3	1.20 V	303	39.5	19.2
8	11550.00	44.5 AV	54.0	-9.5	1.20 V	303	25.3	19.2

Remarks:

1. Emission Level(dBuV/m) = Raw Value(dBuV) + Correction Factor(dB/m).
2. Correction Factor(dB/m) = Antenna Factor(dB/m) + Cable Factor(dB) – Pre-Amplifier Factor(dB).
3. Margin value = Emission Level – Limit value.
4. The other emission levels were very low against the limit.
5. " * ": Fundamental frequency.
6. " # ": The radiated frequency is out of the restricted band.

Below 1GHz Worst-Case Data:

802.11n (HT20)

CHANNEL	TX Channel 40	DETECTOR FUNCTION	Quasi-Peak (QP)
FREQUENCY RANGE	9kHz ~ 1GHz		
TEST MODE	A		

ANTENNA POLARITY & TEST DISTANCE: HORIZONTAL AT 3 M

NO.	FREQ. (MHz)	EMISSION LEVEL (dBuV/m)	LIMIT (dBuV/m)	MARGIN (dB)	ANTENNA HEIGHT (m)	TABLE ANGLE (Degree)	RAW VALUE (dBuV)	CORRECTION FACTOR (dB/m)
1	66.86	33.3 QP	40.0	-6.7	1.50 H	287	43.6	-10.3
2	103.72	27.7 QP	43.5	-15.8	1.00 H	55	40.2	-12.5
3	152.22	29.6 QP	43.5	-13.9	1.50 H	75	38.4	-8.8
4	220.12	31.4 QP	46.0	-14.6	1.00 H	111	42.0	-10.6
5	241.46	29.1 QP	46.0	-16.9	2.00 H	101	38.6	-9.5
6	295.78	25.7 QP	46.0	-20.3	1.00 H	124	33.3	-7.6

Remarks:

1. Emission Level(dBuV/m) = Raw Value(dBuV) + Correction Factor(dB/m)
2. Correction Factor(dB/m) = Antenna Factor(dB/m) + Cable Factor(dB) – Pre-Amplifier Factor(dB)
3. The other emission levels were very low against the limit of frequency range 30MHz ~ 1000MHz
4. Margin value = Emission Level – Limit value
5. The emission levels were very low against the limit of frequency range 9kHz ~ 30MHz: the amplitude of spurious emissions attenuated more than 20 dB below the permissible value to be report

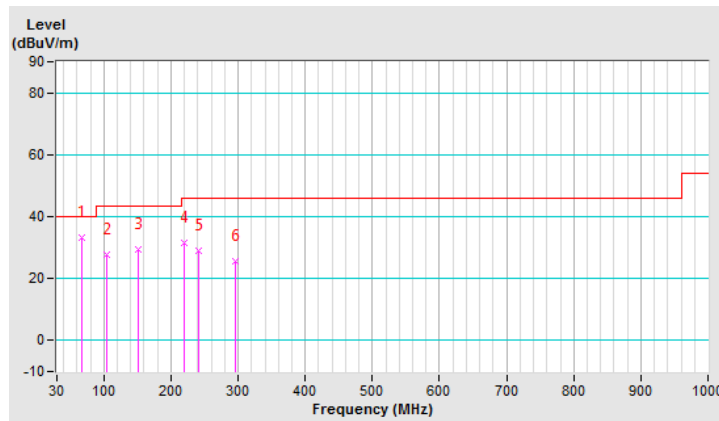

CHANNEL	TX Channel 40	DETECTOR FUNCTION	Quasi-Peak (QP)
FREQUENCY RANGE	9kHz ~ 1GHz		
TEST MODE	A		

ANTENNA POLARITY & TEST DISTANCE: VERTICAL AT 3 M								
NO.	FREQ. (MHz)	EMISSION LEVEL (dBuV/m)	LIMIT (dBuV/m)	MARGIN (dB)	ANTENNA HEIGHT (m)	TABLE ANGLE (Degree)	RAW VALUE (dBuV)	CORRECTION FACTOR (dB/m)
1	76.56	27.0 QP	40.0	-13.0	1.50 V	16	39.6	-12.6
2	103.72	35.7 QP	43.5	-7.8	1.00 V	291	48.2	-12.5
3	138.64	31.5 QP	43.5	-12.0	2.00 V	16	40.7	-9.2
4	158.04	28.0 QP	43.5	-15.5	1.00 V	15	36.6	-8.6
5	224.00	26.4 QP	46.0	-19.6	1.00 V	247	36.9	-10.5
6	295.78	24.1 QP	46.0	-21.9	2.00 V	71	31.7	-7.6

Remarks:

1. Emission Level(dBuV/m) = Raw Value(dBuV) + Correction Factor(dB/m)
2. Correction Factor(dB/m) = Antenna Factor(dB/m) + Cable Factor(dB) – Pre-Amplifier Factor(dB)
3. The other emission levels were very low against the limit of frequency range 30MHz ~ 1000MHz
4. Margin value = Emission Level – Limit value
5. The emission levels were very low against the limit of frequency range 9kHz ~ 30MHz: the amplitude of spurious emissions attenuated more than 20 dB below the permissible value to be report

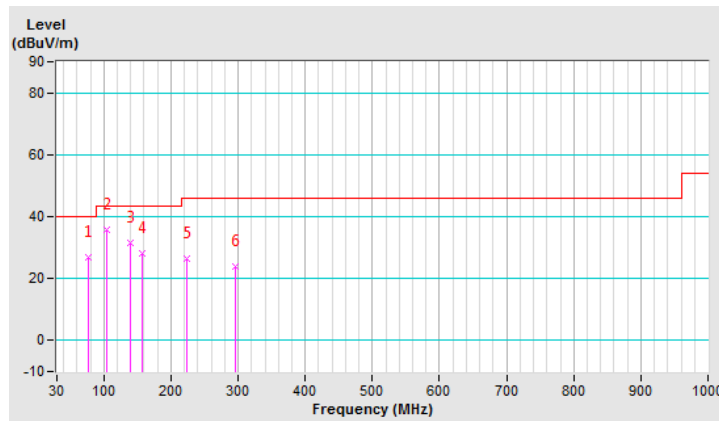

CHANNEL	TX Channel 40	DETECTOR FUNCTION	Quasi-Peak (QP)
FREQUENCY RANGE	9kHz ~ 1GHz		
TEST MODE	B		

ANTENNA POLARITY & TEST DISTANCE: HORIZONTAL AT 3 M								
NO.	FREQ. (MHz)	EMISSION LEVEL (dBuV/m)	LIMIT (dBuV/m)	MARGIN (dB)	ANTENNA HEIGHT (m)	TABLE ANGLE (Degree)	RAW VALUE (dBuV)	CORRECTION FACTOR (dB/m)
1	53.28	31.5 QP	40.0	-8.5	2.00 H	159	40.6	-9.1
2	70.74	26.2 QP	40.0	-13.8	1.00 H	52	37.4	-11.2
3	103.72	27.1 QP	43.5	-16.4	1.50 H	96	39.6	-12.5
4	177.44	32.9 QP	43.5	-10.6	1.00 H	246	42.5	-9.6
5	247.28	31.2 QP	46.0	-14.8	1.50 H	79	40.5	-9.3
6	313.24	29.9 QP	46.0	-16.1	1.00 H	113	36.9	-7.0

Remarks:

1. Emission Level(dBuV/m) = Raw Value(dBuV) + Correction Factor(dB/m)
2. Correction Factor(dB/m) = Antenna Factor(dB/m) + Cable Factor(dB) – Pre-Amplifier Factor(dB)
3. The other emission levels were very low against the limit of frequency range 30MHz ~ 1000MHz
4. Margin value = Emission Level – Limit value
5. The emission levels were very low against the limit of frequency range 9kHz ~ 30MHz: the amplitude of spurious emissions attenuated more than 20 dB below the permissible value to be report

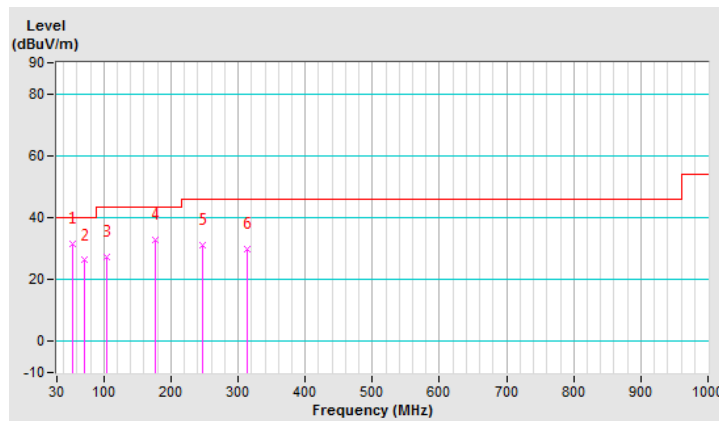

CHANNEL	TX Channel 40	DETECTOR FUNCTION	Quasi-Peak (QP)
FREQUENCY RANGE	9kHz ~ 1GHz		
TEST MODE	B		

ANTENNA POLARITY & TEST DISTANCE: VERTICAL AT 3 M								
NO.	FREQ. (MHz)	EMISSION LEVEL (dBuV/m)	LIMIT (dBuV/m)	MARGIN (dB)	ANTENNA HEIGHT (m)	TABLE ANGLE (Degree)	RAW VALUE (dBuV)	CORRECTION FACTOR (dB/m)
1	132.82	35.8 QP	43.5	-7.7	1.50 V	8	45.5	-9.7
2	256.98	27.1 QP	46.0	-18.9	1.00 V	9	36.1	-9.0
3	288.02	27.8 QP	46.0	-18.2	1.00 V	9	35.5	-7.7
4	317.12	25.4 QP	46.0	-20.6	2.00 V	161	32.3	-6.9
5	573.20	31.6 QP	46.0	-14.4	1.00 V	9	31.4	0.2
6	710.94	36.2 QP	46.0	-9.8	1.50 V	9	34.2	2.0

Remarks:

1. Emission Level(dBuV/m) = Raw Value(dBuV) + Correction Factor(dB/m)
2. Correction Factor(dB/m) = Antenna Factor(dB/m) + Cable Factor(dB) – Pre-Amplifier Factor(dB)
3. The other emission levels were very low against the limit of frequency range 30MHz ~ 1000MHz
4. Margin value = Emission Level – Limit value
5. The emission levels were very low against the limit of frequency range 9kHz ~ 30MHz: the amplitude of spurious emissions attenuated more than 20 dB below the permissible value to be report

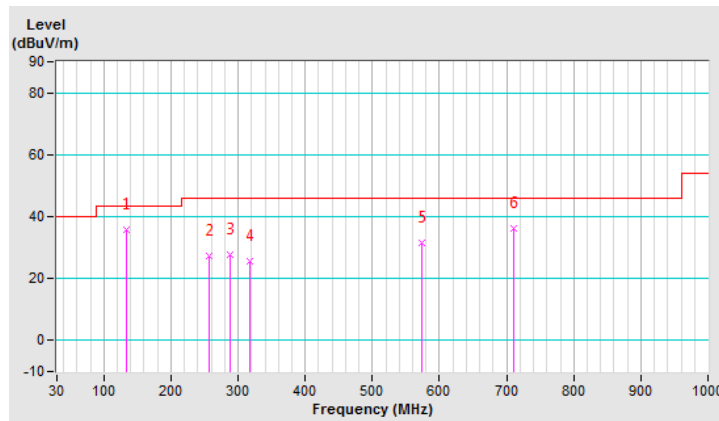

802.11n (HT40)

CHANNEL	TX Channel 159	DETECTOR FUNCTION	Quasi-Peak (QP)
FREQUENCY RANGE	9kHz ~ 1GHz		
TEST MODE	A		

ANTENNA POLARITY & TEST DISTANCE: HORIZONTAL AT 3 M								
NO.	FREQ. (MHz)	EMISSION LEVEL (dBuV/m)	LIMIT (dBuV/m)	MARGIN (dB)	ANTENNA HEIGHT (m)	TABLE ANGLE (Degree)	RAW VALUE (dBuV)	CORRECTION FACTOR (dB/m)
1	70.74	29.5 QP	40.0	-10.5	2.00 H	11	40.7	-11.2
2	113.42	34.0 QP	43.5	-9.5	1.00 H	11	45.6	-11.6
3	152.22	30.4 QP	43.5	-13.1	1.50 H	91	39.2	-8.8
4	218.18	31.7 QP	46.0	-14.3	1.00 H	93	42.3	-10.6
5	340.40	25.2 QP	46.0	-20.8	1.50 H	107	31.6	-6.4
6	425.76	24.5 QP	46.0	-21.5	1.00 H	113	27.9	-3.4

Remarks:

1. Emission Level(dBuV/m) = Raw Value(dBuV) + Correction Factor(dB/m)
2. Correction Factor(dB/m) = Antenna Factor(dB/m) + Cable Factor(dB) – Pre-Amplifier Factor(dB)
3. The other emission levels were very low against the limit of frequency range 30MHz ~ 1000MHz
4. Margin value = Emission Level – Limit value
5. The emission levels were very low against the limit of frequency range 9kHz ~ 30MHz: the amplitude of spurious emissions attenuated more than 20 dB below the permissible value to be report

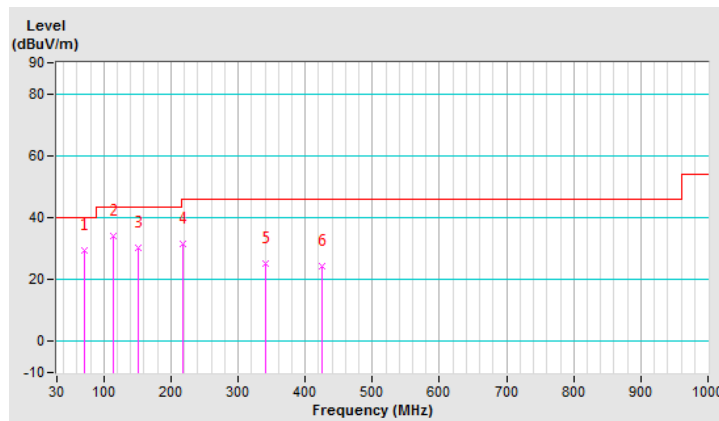

CHANNEL	TX Channel 159	DETECTOR FUNCTION	Quasi-Peak (QP)
FREQUENCY RANGE	9kHz ~ 1GHz		
TEST MODE	A		

ANTENNA POLARITY & TEST DISTANCE: VERTICAL AT 3 M								
NO.	FREQ. (MHz)	EMISSION LEVEL (dBuV/m)	LIMIT (dBuV/m)	MARGIN (dB)	ANTENNA HEIGHT (m)	TABLE ANGLE (Degree)	RAW VALUE (dBuV)	CORRECTION FACTOR (dB/m)
1	103.72	36.0 QP	43.5	-7.5	1.50 V	110	48.5	-12.5
2	138.64	31.5 QP	43.5	-12.0	1.00 V	22	40.7	-9.2
3	158.04	28.1 QP	43.5	-15.4	2.00 V	358	36.7	-8.6
4	218.18	26.2 QP	46.0	-19.8	1.00 V	252	36.8	-10.6
5	295.78	23.9 QP	46.0	-22.1	1.00 V	310	31.5	-7.6
6	416.06	27.5 QP	46.0	-18.5	1.50 V	145	31.3	-3.8

Remarks:

1. Emission Level(dBuV/m) = Raw Value(dBuV) + Correction Factor(dB/m)
2. Correction Factor(dB/m) = Antenna Factor(dB/m) + Cable Factor(dB) – Pre-Amplifier Factor(dB)
3. The other emission levels were very low against the limit of frequency range 30MHz ~ 1000MHz
4. Margin value = Emission Level – Limit value
5. The emission levels were very low against the limit of frequency range 9kHz ~ 30MHz: the amplitude of spurious emissions attenuated more than 20 dB below the permissible value to be report

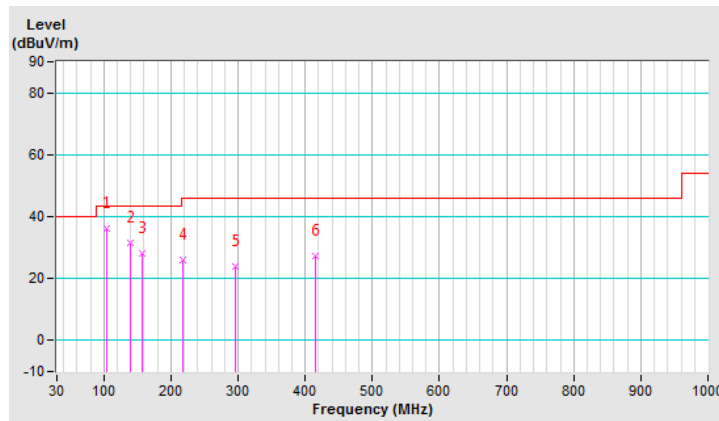

CHANNEL	TX Channel 159	DETECTOR FUNCTION	Quasi-Peak (QP)
FREQUENCY RANGE	9kHz ~ 1GHz		
TEST MODE	B		

ANTENNA POLARITY & TEST DISTANCE: HORIZONTAL AT 3 M

NO.	FREQ. (MHz)	EMISSION LEVEL (dBuV/m)	LIMIT (dBuV/m)	MARGIN (dB)	ANTENNA HEIGHT (m)	TABLE ANGLE (Degree)	RAW VALUE (dBuV)	CORRECTION FACTOR (dB/m)
1	68.80	32.4 QP	40.0	-7.6	1.50 H	336	43.4	-11.0
2	107.60	32.6 QP	43.5	-10.9	1.00 H	3	44.6	-12.0
3	119.24	33.3 QP	43.5	-10.2	2.00 H	3	44.3	-11.0
4	179.38	32.4 QP	43.5	-11.1	1.00 H	79	42.2	-9.8
5	245.34	31.2 QP	46.0	-14.8	1.50 H	107	40.5	-9.3
6	311.30	30.6 QP	46.0	-15.4	1.00 H	110	37.6	-7.0

Remarks:

1. Emission Level(dBuV/m) = Raw Value(dBuV) + Correction Factor(dB/m)
2. Correction Factor(dB/m) = Antenna Factor(dB/m) + Cable Factor(dB) – Pre-Amplifier Factor(dB)
3. The other emission levels were very low against the limit of frequency range 30MHz ~ 1000MHz
4. Margin value = Emission Level – Limit value
5. The emission levels were very low against the limit of frequency range 9kHz ~ 30MHz: the amplitude of spurious emissions attenuated more than 20 dB below the permissible value to be report

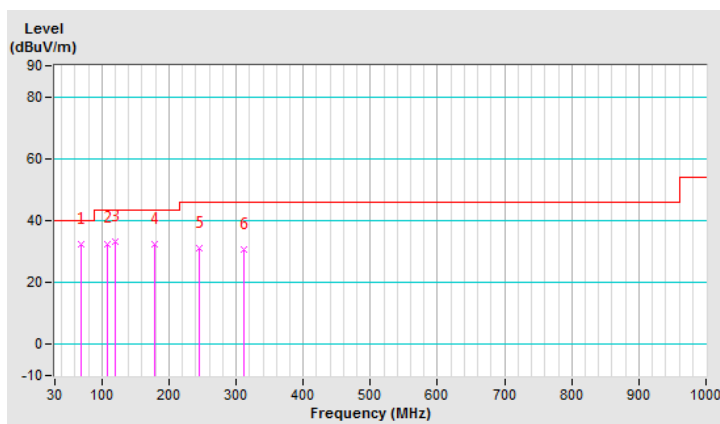

CHANNEL	TX Channel 159	DETECTOR FUNCTION	Quasi-Peak (QP)
FREQUENCY RANGE	9kHz ~ 1GHz		
TEST MODE	B		

ANTENNA POLARITY & TEST DISTANCE: VERTICAL AT 3 M								
NO.	FREQ. (MHz)	EMISSION LEVEL (dBuV/m)	LIMIT (dBuV/m)	MARGIN (dB)	ANTENNA HEIGHT (m)	TABLE ANGLE (Degree)	RAW VALUE (dBuV)	CORRECTION FACTOR (dB/m)
1	103.72	36.1 QP	43.5	-7.4	2.00 V	155	48.6	-12.5
2	117.30	34.0 QP	43.5	-9.5	1.00 V	334	45.3	-11.3
3	138.64	31.8 QP	43.5	-11.7	2.00 V	73	41.0	-9.2
4	169.68	32.4 QP	43.5	-11.1	1.00 V	86	41.4	-9.0
5	200.72	28.7 QP	43.5	-14.8	1.50 V	18	39.7	-11.0
6	505.30	27.3 QP	46.0	-18.7	1.00 V	296	28.7	-1.4

Remarks:

1. Emission Level(dBuV/m) = Raw Value(dBuV) + Correction Factor(dB/m)
2. Correction Factor(dB/m) = Antenna Factor(dB/m) + Cable Factor(dB) – Pre-Amplifier Factor(dB)
3. The other emission levels were very low against the limit of frequency range 30MHz ~ 1000MHz
4. Margin value = Emission Level – Limit value
5. The emission levels were very low against the limit of frequency range 9kHz ~ 30MHz: the amplitude of spurious emissions attenuated more than 20 dB below the permissible value to be report

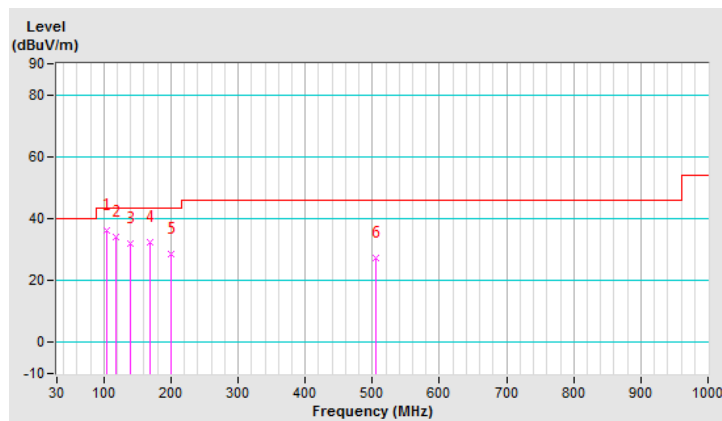

4.2 Conducted Emission Measurement

4.2.1 Limits of Conducted Emission Measurement

Frequency (MHz)	Conducted Limit (dBuV)	
	Quasi-peak	Average
0.15 - 0.5	66 - 56	56 - 46
0.50 - 5.0	56	46
5.0 - 30.0	60	50

Note: 1. The lower limit shall apply at the transition frequencies.

2. The limit decreases in line with the logarithm of the frequency in the range of 0.15 to 0.50MHz.

4.2.2 Test Instruments

Description & Manufacturer	Model No.	Serial No.	Cal. Date	Cal. Due
Test Receiver ROHDE & SCHWARZ	ESCI	100613	Dec. 10, 2018	Dec. 09, 2019
RF signal cable Woken	5D-FB	Cable-cond1-01	Sep. 05, 2019	Sep. 04, 2020
LISN ROHDE & SCHWARZ (EUT)	ENV216	101826	Feb. 21, 2019	Feb. 20, 2020
LISN ROHDE & SCHWARZ (Peripheral)	ESH3-Z5	100311	Aug. 22, 2019	Aug. 21, 2020
Software ADT	BV ADT_Cond_ V7.3.7.4	NA	NA	NA

Note: 1. The calibration interval of the above test instruments is 12 months and the calibrations are traceable to NML/ROC and NIST/USA.

2. The test was performed in HwaYa Shielded Room 1.

3. The VCCI Site Registration No. is C-12040.

4.2.3 Test Procedures

- The EUT was placed 0.4 meters from the conducting wall of the shielded room with EUT being connected to the power mains through a line impedance stabilization network (LISN). Other support units were connected to the power mains through another LISN. The two LISNs provide 50 ohm/ 50uH of coupling impedance for the measuring instrument.
- Both lines of the power mains connected to the EUT were checked for maximum conducted interference.
- The frequency range from 150kHz to 30MHz was searched. Emission levels under (Limit - 20dB) was not recorded.

Note: The resolution bandwidth and video bandwidth of test receiver is 9kHz for quasi-peak detection (QP) and average detection (AV) at frequency 0.15MHz-30MHz.

4.2.4 Deviation from Test Standard

No deviation.

4.2.5 Test Setup

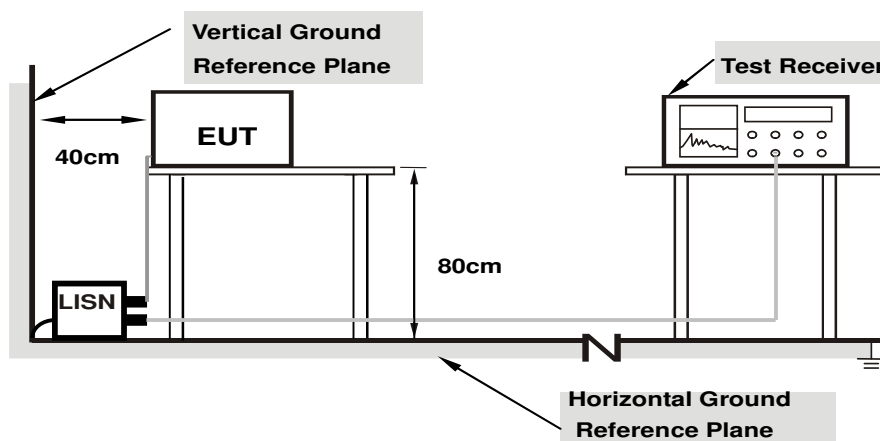

Note: 1.Support units were connected to second LISN.

For the actual test configuration, please refer to the attached file (Test Setup Photo).

4.2.6 EUT Operating Conditions

Same as 4.1.6.

4.2.7 Test Results

Worst-case data:

802.11n (HT20)

Phase	Line (L)	Detector Function	Quasi-Peak (QP) / Average (AV)
Channel	TX Channel 40	Test Mode	A

No	Freq. [MHz]	Corr. Factor (dB)	Reading Value [dB (uV)]		Emission Level [dB (uV)]		Limit [dB (uV)]		Margin (dB)	
			Q.P.	AV.	Q.P.	AV.	Q.P.	AV.	Q.P.	AV.
			1	0.15400	9.71	38.09	27.56	47.80	37.27	65.78
2	0.16200	9.72	34.00	18.51	43.72	28.23	65.36	55.36	-21.64	-27.13
3	0.19989	9.78	32.65	20.07	42.43	29.85	63.62	53.62	-21.19	-23.77
4	0.44999	9.91	24.55	13.31	34.46	23.22	56.88	46.88	-22.42	-23.66
5	1.74200	10.07	22.78	13.30	32.85	23.37	56.00	46.00	-23.15	-22.63
6	8.80600	10.29	30.19	22.67	40.48	32.96	60.00	50.00	-19.52	-17.04

Remarks:

1. Q.P. and AV. are abbreviations of quasi-peak and average individually.
2. The emission levels of other frequencies were very low against the limit.
3. Margin value = Emission level - Limit value
4. Correction factor = Insertion loss + Cable loss
5. Emission Level = Correction Factor + Reading Value.

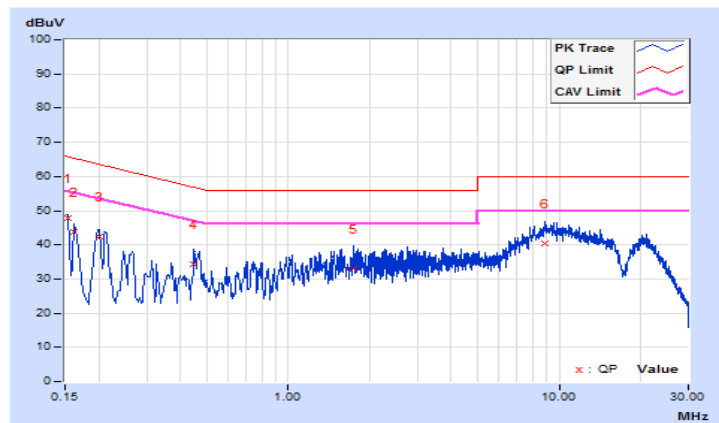

Phase	Neutral (N)	Detector Function	Quasi-Peak (QP) / Average (AV)
Channel	TX Channel 40	Test Mode	A

No	Freq. [MHz]	Corr. Factor (dB)	Reading Value [dB (uV)]		Emission Level [dB (uV)]		Limit [dB (uV)]		Margin (dB)	
			Q.P.	AV.	Q.P.	AV.	Q.P.	AV.	Q.P.	AV.
			1	0.15800	9.70	37.19	23.81	46.89	33.51	65.57
2	0.20523	9.80	32.64	20.91	42.44	30.71	63.40	53.40	-20.96	-22.69
3	0.25800	9.82	27.18	13.79	37.00	23.61	61.50	51.50	-24.50	-27.89
4	0.39400	9.86	20.60	6.84	30.46	16.70	57.98	47.98	-27.52	-31.28
5	1.03000	9.96	16.85	8.69	26.81	18.65	56.00	46.00	-29.19	-27.35
6	9.80200	10.25	28.30	20.36	38.55	30.61	60.00	50.00	-21.45	-19.39

Remarks:

1. Q.P. and AV. are abbreviations of quasi-peak and average individually.
2. The emission levels of other frequencies were very low against the limit.
3. Margin value = Emission level - Limit value
4. Correction factor = Insertion loss + Cable loss
5. Emission Level = Correction Factor + Reading Value.

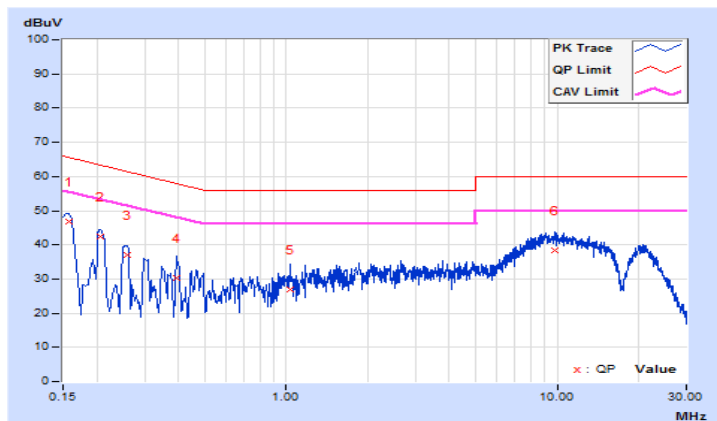

Phase	Line (L)	Detector Function	Quasi-Peak (QP) / Average (AV)
Channel	TX Channel 40	Test Mode	B

No	Freq. [MHz]	Corr. Factor (dB)	Reading Value [dB (uV)]		Emission Level [dB (uV)]		Limit [dB (uV)]		Margin (dB)	
			Q.P.	AV.	Q.P.	AV.	Q.P.	AV.	Q.P.	AV.
1	0.16190	9.67	36.77	23.50	46.44	33.17	65.37	55.37	-18.93	-22.20
2	0.19418	9.66	31.13	18.19	40.79	27.85	63.86	53.86	-23.07	-26.01
3	0.47684	9.70	33.80	28.91	43.50	38.61	56.39	46.39	-12.89	-7.78
4	0.97632	9.73	23.77	19.70	33.50	29.43	56.00	46.00	-22.50	-16.57
5	5.13400	9.86	21.02	15.28	30.88	25.14	60.00	50.00	-29.12	-24.86
6	11.24600	9.94	20.33	15.01	30.27	24.95	60.00	50.00	-29.73	-25.05

Remarks:

1. Q.P. and AV. are abbreviations of quasi-peak and average individually.
2. The emission levels of other frequencies were very low against the limit.
3. Margin value = Emission level - Limit value
4. Correction factor = Insertion loss + Cable loss
5. Emission Level = Correction Factor + Reading Value.

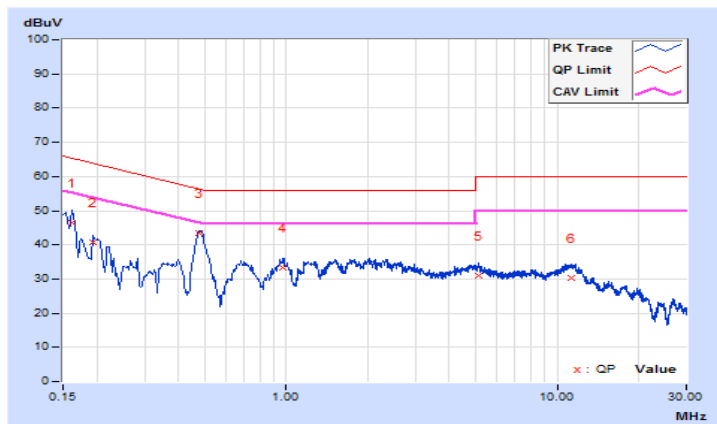

Phase	Neutral (N)	Detector Function	Quasi-Peak (QP) / Average (AV)
Channel	TX Channel 40	Test Mode	B

No	Freq. [MHz]	Corr. Factor (dB)	Reading Value [dB (uV)]		Emission Level [dB (uV)]		Limit [dB (uV)]		Margin (dB)	
			Q.P.	AV.	Q.P.	AV.	Q.P.	AV.	Q.P.	AV.
			1	0.15400	9.64	38.21	24.07	47.85	33.71	65.78
2	0.17384	9.64	34.59	20.26	44.23	29.90	64.77	54.77	-20.54	-24.87
3	0.47810	9.67	33.53	28.40	43.20	38.07	56.37	46.37	-13.17	-8.30
4	0.98667	9.70	21.87	18.41	31.57	28.11	56.00	46.00	-24.43	-17.89
5	5.31000	9.83	17.85	11.51	27.68	21.34	60.00	50.00	-32.32	-28.66
6	11.92600	9.94	17.83	12.59	27.77	22.53	60.00	50.00	-32.23	-27.47

Remarks:

1. Q.P. and AV. are abbreviations of quasi-peak and average individually.
2. The emission levels of other frequencies were very low against the limit.
3. Margin value = Emission level - Limit value
4. Correction factor = Insertion loss + Cable loss
5. Emission Level = Correction Factor + Reading Value.

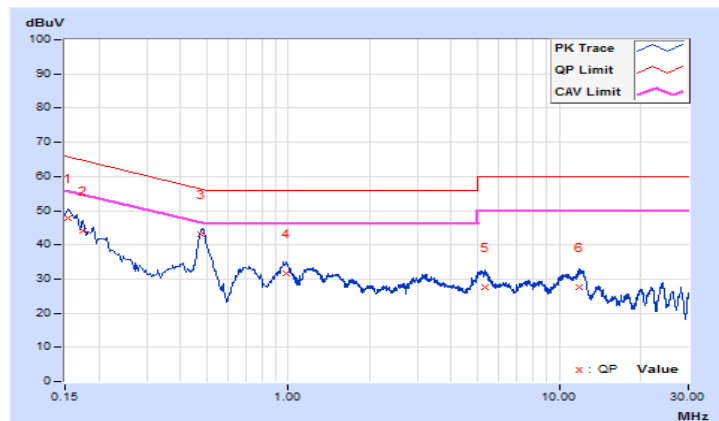

802.11n (HT40)

Phase	Line (L)	Detector Function	Quasi-Peak (QP) / Average (AV)
Channel	TX Channel 159	Test Mode	A

No	Freq. [MHz]	Corr. Factor (dB)	Reading Value [dB (uV)]		Emission Level [dB (uV)]		Limit [dB (uV)]		Margin (dB)	
			Q.P.	AV.	Q.P.	AV.	Q.P.	AV.	Q.P.	AV.
			1	0.15400	9.71	38.55	27.93	48.26	37.64	65.78
2	0.19780	9.78	32.72	18.54	42.50	28.32	63.70	53.70	-21.20	-25.38
3	0.25338	9.81	27.23	14.52	37.04	24.33	61.65	51.65	-24.61	-27.32
4	0.29834	9.84	23.51	11.32	33.35	21.16	60.29	50.29	-26.94	-29.13
5	0.46200	9.91	24.81	13.76	34.72	23.67	56.66	46.66	-21.94	-22.99
6	9.21400	10.30	30.64	22.93	40.94	33.23	60.00	50.00	-19.06	-16.77

Remarks:

1. Q.P. and AV. are abbreviations of quasi-peak and average individually.
2. The emission levels of other frequencies were very low against the limit.
3. Margin value = Emission level - Limit value
4. Correction factor = Insertion loss + Cable loss
5. Emission Level = Correction Factor + Reading Value.

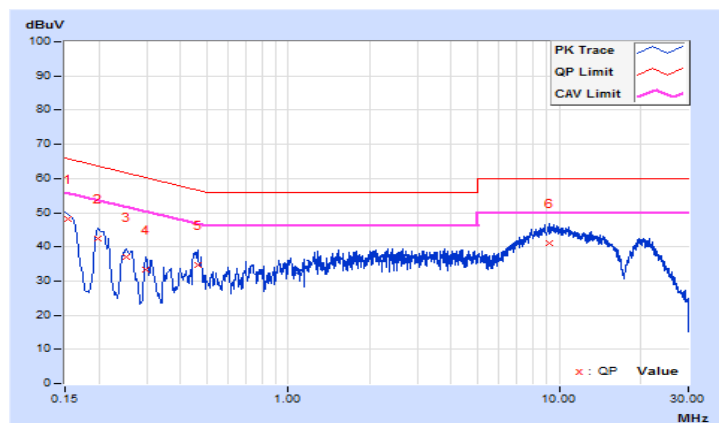

Phase	Neutral (N)	Detector Function	Quasi-Peak (QP) / Average (AV)
Channel	TX Channel 159	Test Mode	A

No	Freq. [MHz]	Corr. Factor (dB)	Reading Value [dB (uV)]		Emission Level [dB (uV)]		Limit [dB (uV)]		Margin (dB)	
			Q.P.	AV.	Q.P.	AV.	Q.P.	AV.	Q.P.	AV.
			1	0.15687	9.70	38.01	25.12	47.71	34.82	65.63
2	0.19832	9.80	32.77	18.36	42.57	28.16	63.68	53.68	-21.11	-25.52
3	0.24614	9.81	26.85	10.73	36.66	20.54	61.89	51.89	-25.23	-31.35
4	0.44999	9.87	19.25	10.38	29.12	20.25	56.88	46.88	-27.76	-26.63
5	9.37800	10.24	28.20	20.12	38.44	30.36	60.00	50.00	-21.56	-19.64
6	20.67800	10.49	24.14	17.21	34.63	27.70	60.00	50.00	-25.37	-22.30

Remarks:

1. Q.P. and AV. are abbreviations of quasi-peak and average individually.
2. The emission levels of other frequencies were very low against the limit.
3. Margin value = Emission level - Limit value
4. Correction factor = Insertion loss + Cable loss
5. Emission Level = Correction Factor + Reading Value.

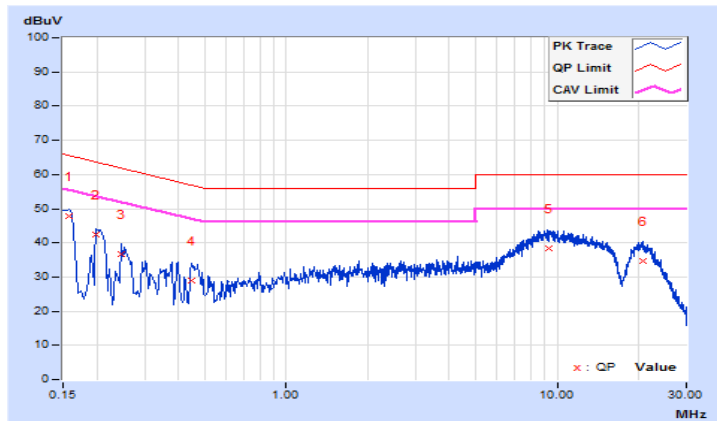

Phase	Line (L)	Detector Function	Quasi-Peak (QP) / Average (AV)
Channel	TX Channel 159	Test Mode	B

No	Freq. [MHz]	Corr. Factor (dB)	Reading Value [dB (uV)]		Emission Level [dB (uV)]		Limit [dB (uV)]		Margin (dB)	
			Q.P.	AV.	Q.P.	AV.	Q.P.	AV.	Q.P.	AV.
			1	0.16148	9.67	37.69	24.00	47.36	33.67	65.39
2	0.18519	9.66	33.41	19.74	43.07	29.40	64.25	54.25	-21.18	-24.85
3	0.20600	9.66	30.17	15.99	39.83	25.65	63.37	53.37	-23.54	-27.72
4	0.25405	9.67	23.96	13.86	33.63	23.53	61.62	51.62	-27.99	-28.09
5	0.47810	9.70	33.98	28.81	43.68	38.51	56.37	46.37	-12.69	-7.86
6	11.13000	9.94	20.73	15.55	30.67	25.49	60.00	50.00	-29.33	-24.51

Remarks:

1. Q.P. and AV. are abbreviations of quasi-peak and average individually.
2. The emission levels of other frequencies were very low against the limit.
3. Margin value = Emission level - Limit value
4. Correction factor = Insertion loss + Cable loss
5. Emission Level = Correction Factor + Reading Value.

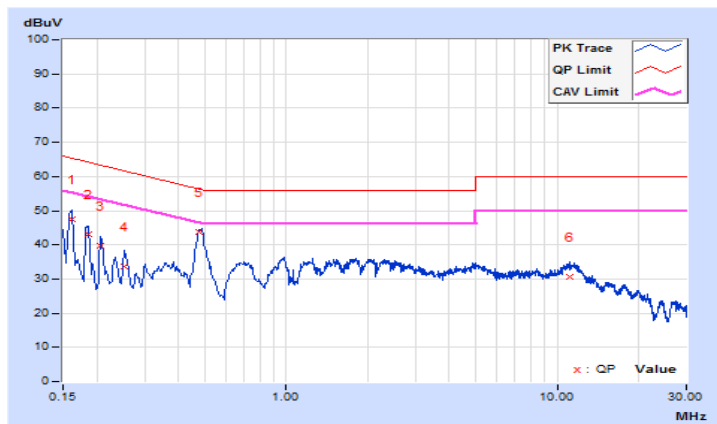

Phase	Neutral (N)	Detector Function	Quasi-Peak (QP) / Average (AV)
Channel	TX Channel 159	Test Mode	B

No	Freq. [MHz]	Corr. Factor (dB)	Reading Value [dB (uV)]		Emission Level [dB (uV)]		Limit [dB (uV)]		Margin (dB)	
			Q.P.	AV.	Q.P.	AV.	Q.P.	AV.	Q.P.	AV.
			1	0.16200	9.64	37.43	23.35	47.07	32.99	65.36
2	0.19400	9.64	31.88	17.52	41.52	27.16	63.86	53.86	-22.34	-26.70
3	0.21406	9.64	29.28	15.38	38.92	25.02	63.05	53.05	-24.13	-28.03
4	0.48572	9.67	33.30	27.48	42.97	37.15	56.24	46.24	-13.27	-9.09
5	5.09400	9.83	17.95	11.18	27.78	21.01	60.00	50.00	-32.22	-28.99
6	12.18213	9.94	18.07	12.97	28.01	22.91	60.00	50.00	-31.99	-27.09

Remarks:

1. Q.P. and AV. are abbreviations of quasi-peak and average individually.
2. The emission levels of other frequencies were very low against the limit.
3. Margin value = Emission level - Limit value
4. Correction factor = Insertion loss + Cable loss
5. Emission Level = Correction Factor + Reading Value.

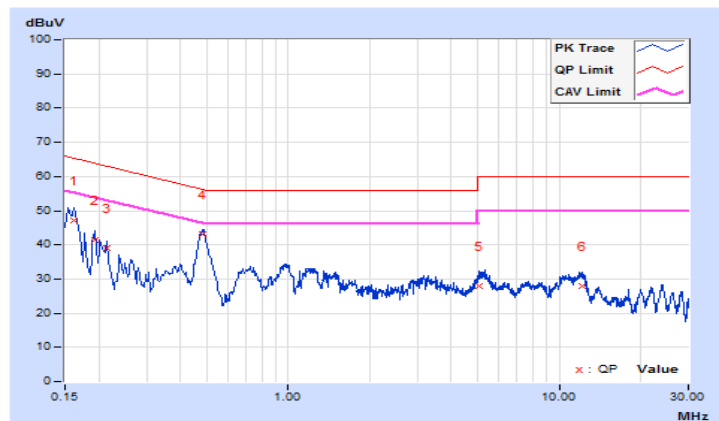

4.3 Transmit Power Measurement

4.3.1 Limits of Transmit Power Measurement

Operation Band	EUT Category		Limit
U-NII-1		Outdoor Access Point	1 Watt (30 dBm) (Max. e.i.r.p \leq 125mW(21 dBm) at any elevation angle above 30 degrees as measured from the horizon)
		Fixed point-to-point Access Point	1 Watt (30 dBm)
	√	Indoor Access Point	1 Watt (30 dBm)
		Mobile and Portable client device	250mW (24 dBm)
U-NII-2A			250mW (24 dBm) or 11 dBm+10 log B*
U-NII-2C			250mW (24 dBm) or 11 dBm+10 log B*
U-NII-3	√		1 Watt (30 dBm)

*B is the 26 dB emission bandwidth in megahertz

Per KDB 662911 Method of conducted output power measurement on IEEE 802.11 devices,

Array Gain = 0 dB (i.e., no array gain) for $N_{ANT} \leq 4$;

Array Gain = 0 dB (i.e., no array gain) for channel widths ≥ 40 MHz for any N_{ANT} ;

Array Gain = $5 \log(N_{ANT}/N_{SS})$ dB or 3 dB, whichever is less for 20-MHz channel widths with $N_{ANT} \geq 5$.

For power measurements on all other devices: Array Gain = $10 \log(N_{ANT}/N_{SS})$ dB.

4.3.2 Test Setup

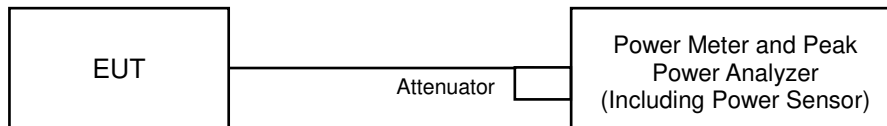

4.3.3 Test Instruments

Refer to section 4.1.2 to get information of above instrument.

4.3.4 Test Procedure

Method PM is used to perform output power measurement, trigger and gating function of wide band power meter is enabled to measure max output power of TX on burst and set the detector to average. Duty factor is not added to measured value.

4.3.5 Deviation from Test Standard

No deviation.

4.3.6 EUT Operating Conditions

The software provided by client to enable the EUT under transmission condition continuously at lowest, middle and highest channel frequencies individually.

4.3.7 Test Result

Power Output:

CDD Mode

802.11a

Chan.	Freq. (MHz)	Maximum Conducted Power (dBm)		Total Power (mW)	Total Power (dBm)	Power Limit (dBm)	Pass / Fail
		Chain 0	Chain 1				
36	5180	16.69	18.44	116.489	20.66	30.00	Pass
40	5200	18.33	19.82	164.017	22.15	30.00	Pass
48	5240	17.15	18.52	123.001	20.90	30.00	Pass
149	5745	20.24	19.67	198.365	22.97	30.00	Pass
157	5785	19.99	19.57	190.343	22.80	30.00	Pass
165	5825	19.69	19.32	178.618	22.52	30.00	Pass

802.11n (HT20)

Chan.	Freq. (MHz)	Maximum Conducted Power (dBm)		Total Power (mW)	Total Power (dBm)	Power Limit (dBm)	Pass / Fail
		Chain 0	Chain 1				
36	5180	16.43	18.02	107.341	20.31	30.00	Pass
40	5200	18.59	20.03	172.970	22.38	30.00	Pass
48	5240	17.05	18.41	120.042	20.79	30.00	Pass
149	5745	20.31	19.71	200.940	23.03	30.00	Pass
157	5785	20.04	19.52	190.461	22.80	30.00	Pass
165	5825	19.68	19.24	176.843	22.48	30.00	Pass

802.11n (HT40)

Chan.	Freq. (MHz)	Maximum Conducted Power (dBm)		Total Power (mW)	Total Power (dBm)	Power Limit (dBm)	Pass / Fail
		Chain 0	Chain 1				
38	5190	14.33	16.07	67.560	18.30	30.00	Pass
46	5230	16.13	18.04	104.700	20.20	30.00	Pass
151	5755	20.26	19.58	196.952	22.94	30.00	Pass
159	5795	20.52	19.85	209.325	23.21	30.00	Pass

802.11ac (VHT80)

Chan.	Freq. (MHz)	Maximum Conducted Power (dBm)		Total Power (mW)	Total Power (dBm)	Power Limit (dBm)	Pass / Fail
		Chain 0	Chain 1				
42	5210	13.78	15.41	58.632	17.68	30.00	Pass
155	5775	17.05	16.22	92.578	19.67	30.00	Pass

Beamforming Mode

802.11n (HT20)

Chan.	Freq. (MHz)	Maximum Conducted Power (dBm)		Total Power (mW)	Total Power (dBm)	Power Limit (dBm)	Pass / Fail
		Chain 0	Chain 1				
36	5180	13.42	15.01	53.675	17.30	27.05	Pass
40	5200	15.58	17.02	86.491	19.37	27.05	Pass
48	5240	14.04	15.40	60.025	17.78	27.05	Pass
149	5745	17.30	16.70	100.477	20.02	27.00	Pass
157	5785	17.03	16.51	95.237	19.79	27.00	Pass
165	5825	16.67	16.23	88.428	19.47	27.00	Pass

Note:

1. For U-NII-1 Band: Directional gain = $5.94\text{dBi} + 10\log(2) = 8.95\text{dBi} > 6\text{dBi}$, so the power limit shall be reduced to $30 - (8.95 - 6) = 27.05\text{dBm}$.
2. For U-NII-3 Band: Directional gain = $5.99\text{dBi} + 10\log(2) = 9.00\text{dBi} > 6\text{dBi}$, so the power limit shall be reduced to $30 - (9.00 - 6) = 27.00\text{dBm}$.

802.11n (HT40)

Chan.	Freq. (MHz)	Maximum Conducted Power (dBm)		Total Power (mW)	Total Power (dBm)	Power Limit (dBm)	Pass / Fail
		Chain 0	Chain 1				
38	5190	11.32	13.06	33.782	15.29	27.05	Pass
46	5230	13.12	15.03	52.354	17.19	27.05	Pass
151	5755	17.25	16.57	98.482	19.93	27.00	Pass
159	5795	17.51	16.84	104.670	20.20	27.00	Pass

Note:

1. For U-NII-1 Band: Directional gain = $5.94\text{dBi} + 10\log(2) = 8.95\text{dBi} > 6\text{dBi}$, so the power limit shall be reduced to $30 - (8.95 - 6) = 27.05\text{dBm}$.
2. For U-NII-3 Band: Directional gain = $5.99\text{dBi} + 10\log(2) = 9.00\text{dBi} > 6\text{dBi}$, so the power limit shall be reduced to $30 - (9.00 - 6) = 27.00\text{dBm}$.

802.11ac (VHT80)

Chan.	Freq. (MHz)	Maximum Conducted Power (dBm)		Total Power (mW)	Total Power (dBm)	Power Limit (dBm)	Pass / Fail
		Chain 0	Chain 1				
42	5210	10.77	12.40	29.318	14.67	27.05	Pass
155	5775	14.04	13.21	46.292	16.66	27.00	Pass

Note:

1. For U-NII-1 Band: Directional gain = $5.94\text{dBi} + 10\log(2) = 8.95\text{dBi} > 6\text{dBi}$, so the power limit shall be reduced to $30 - (8.95 - 6) = 27.05\text{dBm}$.
2. For U-NII-3 Band: Directional gain = $5.99\text{dBi} + 10\log(2) = 9.00\text{dBi} > 6\text{dBi}$, so the power limit shall be reduced to $30 - (9.00 - 6) = 27.00\text{dBm}$.

4.4 Occupied Bandwidth Measurement

4.4.1 Test Setup

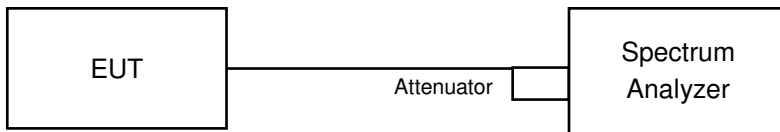

4.4.2 Test Instruments

Refer to section 4.1.2 to get information of above instrument.

4.4.3 Test Procedure

The transmitter output was connected to the spectrum analyzer through an attenuator. The bandwidth of the fundamental frequency was measured by spectrum analyzer with resolution bandwidth in the range of 1% to 5% of the anticipated emission bandwidth, and a video bandwidth at least 3x the resolution bandwidth and set the detector to sampling. The width of a frequency band such that, below the lower and above the upper frequency limits, the mean powers emitted are each equal to a specified percentage 0.5 %of the total mean power of a given emission.

4.4.4 Test Result

802.11a

Chan.	Freq. (MHz)	Occupied Bandwidth (MHz)	
		Chain 0	Chain 1
36	5180	16.68	18.24
40	5200	17.40	29.28
48	5240	16.52	18.52
149	5745	17.31	16.78
157	5785	17.40	16.80
165	5825	17.28	16.80

802.11n (HT20)

Chan.	Freq. (MHz)	Occupied Bandwidth (MHz)	
		Chain 0	Chain 1
36	5180	17.88	18.72
40	5200	18.24	31.68
48	5240	17.64	18.96
149	5745	18.24	17.88
157	5785	18.96	18.00
165	5825	21.84	18.00

802.11n (HT40)

Chan.	Freq. (MHz)	Occupied Bandwidth (MHz)	
		Chain 0	Chain 1
38	5190	36.24	36.24
46	5230	36.24	36.69
151	5755	36.72	36.60
159	5795	36.96	36.60

802.11ac (VHT80)

Chan.	Freq. (MHz)	Occupied Bandwidth (MHz)	
		Chain 0	Chain 1
42	5210	75.60	75.84
155	5775	75.84	75.84



Spectrum Plot of Worst Value

802.11a

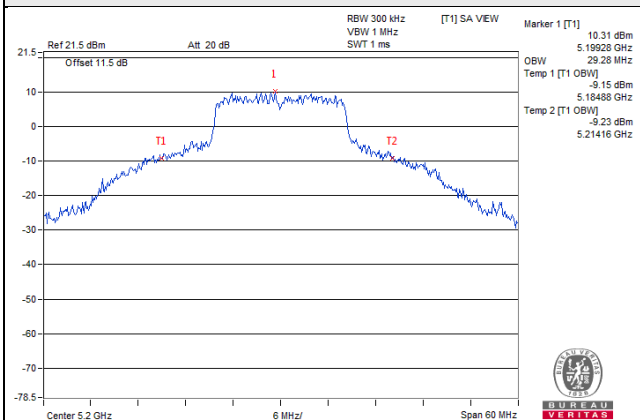

802.11n (HT20)

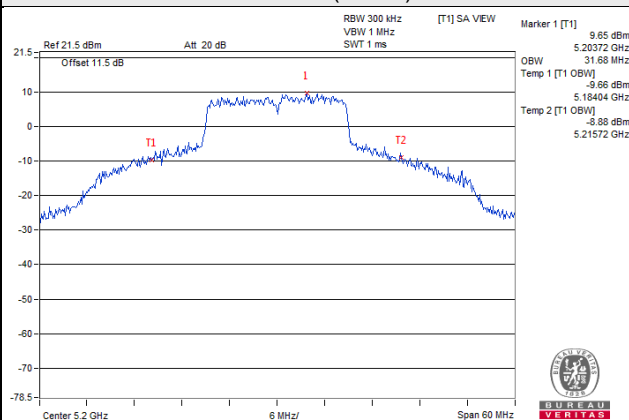

802.11n (HT40)

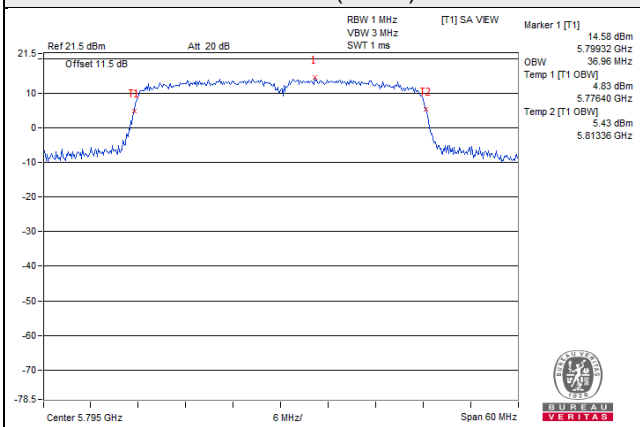

802.11ac (VHT80)

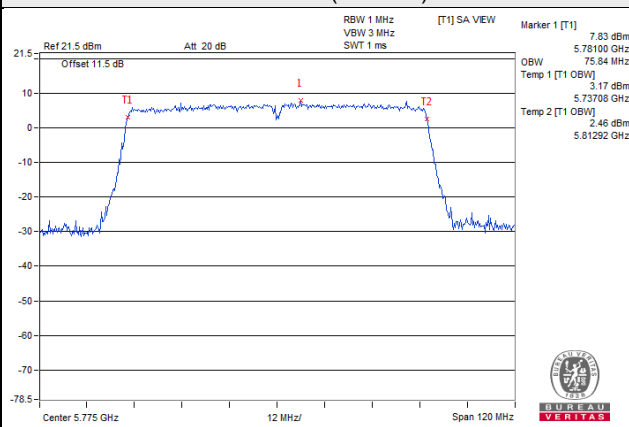

4.5 Peak Power Spectral Density Measurement

4.5.1 Limits of Peak Power Spectral Density Measurement

Operation Band	EUT Category		Limit
U-NII-1		Outdoor Access Point	17dBm/ MHz
		Fixed point-to-point Access Point	
	√	Indoor Access Point	
		Mobile and Portable client device	11dBm/ MHz
U-NII-2A			11dBm/ MHz
U-NII-2C			11dBm/ MHz
U-NII-3	√		30dBm/ 500kHz

4.5.2 Test Setup

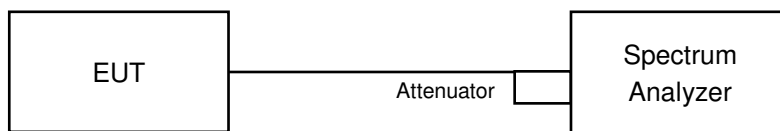

4.5.3 Test Instruments

Refer to section 4.1.2 to get information of above instrument.

4.5.4 Test Procedures

For U-NII-1 band:

Using method SA-2

- Set span to encompass the entire emission bandwidth (EBW) of the signal.
- Set RBW = 1MHz, Set VBW ≥ 3 MHz, Detector = RMS
- Set Channel power measure = 1MHz
- Sweep time = auto, trigger set to "free run".
- Trace average at least 100 traces in power averaging mode.
- Record the max value and add 10 log (1/duty cycle)

For U-NII-3 band:

- Set span to encompass the entire emission bandwidth (EBW) of the signal.
- Set RBW = 300 kHz, Set VBW ≥ 1 MHz, Detector = RMS
- Use the peak marker function to determine the maximum power level in any 300 kHz band segment within the fundamental EBW.
- Scale the observed power level to an equivalent value in 500 kHz by adjusting (reducing) the measured power by a bandwidth correction factor (BWCF) where $BWCF = 10\log(500 \text{ kHz} / 300 \text{ kHz})$
- Sweep time = auto, trigger set to "free run".
- Trace average at least 100 traces in power averaging mode.
- Record the max value and add 10 log (1/duty cycle)

4.5.5 Deviation from Test Standard

No deviation.

4.5.6 EUT Operating Conditions

Same as 4.3.6.

4.5.7 Test Results

For U-NII-1 band:

802.11a

Chan.	Freq. (MHz)	PSD w/o Duty Factor (dBm/MHz)		Duty Factor (dB)	Total PSD with Duty Factor (dBm/MHz)	Max. Limit (dBm/MHz)	Pass / Fail
		Chain 0	Chain 1				
36	5180	2.41	3.36	0.26	6.18	14.05	Pass
40	5200	4.17	5.18	0.26	7.97	14.05	Pass
48	5240	2.39	3.72	0.26	6.38	14.05	Pass

Note:

- Method E) 2) a) of power density measurement of KDB 662911 is using for calculating total power density. Total power density is summing entire spectra across corresponding frequency bins on the various outputs by computer.
- Directional gain = $5.94\text{dBi} + 10\log(2) = 8.95\text{dBi} > 6\text{dBi}$, so the power density limit shall be reduced to $17 - (8.95 - 6) = 14.05\text{dBm}$.
- Refer to section 3.3 for duty cycle spectrum plot.

802.11n (HT20)

Chan.	Freq. (MHz)	PSD w/o Duty Factor (dBm/MHz)		Duty Factor (dB)	Total PSD with Duty Factor (dBm/MHz)	Max. Limit (dBm/MHz)	Pass / Fail
		Chain 0	Chain 1				
36	5180	0.00	3.17	0.10	3.27	14.05	Pass
40	5200	4.22	4.91	0.10	7.69	14.05	Pass
48	5240	1.90	3.39	0.10	5.82	14.05	Pass

Note:

- Method E) 2) a) of power density measurement of KDB 662911 is using for calculating total power density. Total power density is summing entire spectra across corresponding frequency bins on the various outputs by computer.
- Directional gain = $5.94\text{dBi} + 10\log(2) = 8.95\text{dBi} > 6\text{dBi}$, so the power density limit shall be reduced to $17 - (8.95 - 6) = 14.05\text{dBm}$.
- Refer to section 3.3 for duty cycle spectrum plot.

802.11n (HT40)

Chan.	Freq. (MHz)	PSD w/o Duty Factor (dBm/MHz)		Duty Factor (dB)	Total PSD with Duty Factor (dBm/MHz)	Max. Limit (dBm/MHz)	Pass / Fail
		Chain 0	Chain 1				
38	5190	-3.70	-2.77	1.77	1.57	14.05	Pass
46	5230	-1.14	0.09	1.77	4.30	14.05	Pass

Note:

- Method E) 2) a) of power density measurement of KDB 662911 is using for calculating total power density. Total power density is summing entire spectra across corresponding frequency bins on the various outputs by computer.
- Directional gain = $5.94\text{dBi} + 10\log(2) = 8.95\text{dBi} > 6\text{dBi}$, so the power density limit shall be reduced to $17 - (8.95 - 6) = 14.05\text{dBm}$.
- Refer to section 3.3 for duty cycle spectrum plot.

802.11ac (VHT80)

Chan.	Freq. (MHz)	PSD w/o Duty Factor (dBm/MHz)		Duty Factor (dB)	Total PSD with Duty Factor (dBm/MHz)	Max. Limit (dBm/MHz)	Pass / Fail
		Chain 0	Chain 1				
42	5210	-6.76	-6.51	0.58	-3.04	14.05	Pass

Note:

- Method E) 2) a) of power density measurement of KDB 662911 is using for calculating total power density. Total power density is summing entire spectra across corresponding frequency bins on the various outputs by computer.
- Directional gain = $5.94\text{dBi} + 10\log(2) = 8.95\text{dBi} > 6\text{dBi}$, so the power density limit shall be reduced to $17 - (8.95 - 6) = 14.05\text{dBm}$.
- Refer to section 3.3 for duty cycle spectrum plot.

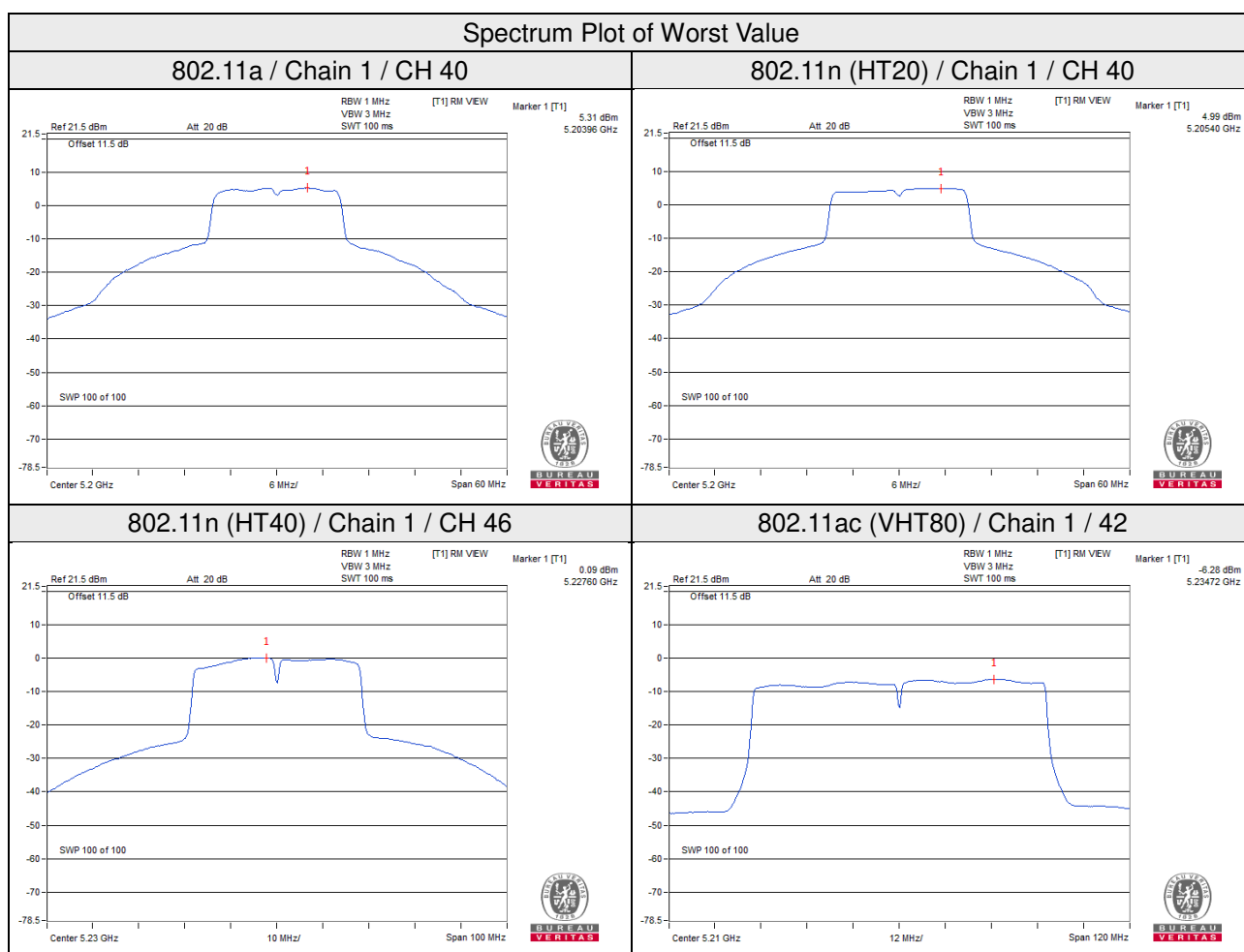

For U-NII-3 band:

802.11a

TX chain	Chan.	Freq. (MHz)	PSD W/O Duty Factor		10 log (N=2) dB	Duty Factor (dB)	Total PSD With Duty Factor (dBm/500kHz)	Limit (dBm/500kHz)	Pass / Fail
			(dBm/300kHz)	(dBm/500kHz)					
0	149	5745	-1.47	0.75	3.01	0.26	4.02	27.00	Pass
	157	5785	-1.94	0.28	3.01	0.26	3.55	27.00	Pass
	165	5825	-2.08	0.14	3.01	0.26	3.41	27.00	Pass
1	149	5745	-2.08	0.14	3.01	0.26	3.41	27.00	Pass
	157	5785	-2.26	-0.04	3.01	0.26	3.23	27.00	Pass
	165	5825	-2.46	-0.24	3.01	0.26	3.03	27.00	Pass

Note:

1. Method E) 2) c) of power density measurement of KDB 662911 is using for calculating total power density, Measure and add $10 \log(N_{ANT})$ dB.
2. Directional gain = $5.99\text{dBi} + 10\log(2) = 9.00\text{dBi} > 6\text{dBi}$, so the power density limit shall be reduced to $30-(9.00-6) = 27.00\text{dBm}$.
3. Refer to section 3.3 for duty cycle spectrum plot.

802.11n (HT20)

TX chain	Chan.	Freq. (MHz)	PSD W/O Duty Factor		10 log (N=2) dB	Duty Factor (dB)	Total PSD With Duty Factor (dBm/500kHz)	Limit (dBm/500kHz)	Pass / Fail
			(dBm/300kHz)	(dBm/500kHz)					
0	149	5745	-1.71	0.51	3.01	0.10	3.62	27.00	Pass
	157	5785	-1.56	0.66	3.01	0.10	3.77	27.00	Pass
	165	5825	-1.63	0.59	3.01	0.10	3.70	27.00	Pass
1	149	5745	-2.34	-0.12	3.01	0.10	2.99	27.00	Pass
	157	5785	-2.35	-0.13	3.01	0.10	2.98	27.00	Pass
	165	5825	-2.54	-0.32	3.01	0.10	2.79	27.00	Pass

Note:

1. Method E) 2) c) of power density measurement of KDB 662911 is using for calculating total power density, Measure and add $10 \log(N_{ANT})$ dB.
2. Directional gain = $5.99\text{dBi} + 10\log(2) = 9.00\text{dBi} > 6\text{dBi}$, so the power density limit shall be reduced to $30-(9.00-6) = 27.00\text{dBm}$.
3. Refer to section 3.3 for duty cycle spectrum plot.

802.11n (HT40)

TX chain	Chan.	Freq. (MHz)	PSD W/O Duty Factor		10 log (N=2) dB	Duty Factor (dB)	Total PSD With Duty Factor (dBm/500kHz)	Limit (dBm/500kHz)	Pass / Fail
			(dBm/300kHz)	(dBm/500kHz)					
0	151	5755	-4.72	-2.50	3.01	1.77	2.28	27.00	Pass
	159	5795	-4.61	-2.39	3.01	1.77	2.39	27.00	Pass
1	151	5755	-5.32	-3.10	3.01	1.77	1.68	27.00	Pass
	159	5795	-5.15	-2.93	3.01	1.77	1.85	27.00	Pass

Note:

- Method E) 2) c) of power density measurement of KDB 662911 is using for calculating total power density, Measure and add $10 \log (N_{ANT})$ dB.
- Directional gain = $5.99\text{dBi} + 10\log(2) = 9.00\text{dBi} > 6\text{dBi}$, so the power density limit shall be reduced to $30 - (9.00 - 6) = 27.00\text{dBm}$.
- Refer to section 3.3 for duty cycle spectrum plot.

802.11ac (VHT80)

TX chain	Chan.	Freq. (MHz)	PSD W/O Duty Factor		10 log (N=2) dB	Duty Factor (dB)	Total PSD With Duty Factor (dBm/500kHz)	Limit (dBm/500kHz)	Pass / Fail
			(dBm/300kHz)	(dBm/500kHz)					
0	155	5775	-11.76	-9.54	3.01	0.58	-5.95	27.00	Pass
1	155	5775	-12.67	-10.45	3.01	0.58	-6.86	27.00	Pass

Note:

- Method E) 2) c) of power density measurement of KDB 662911 is using for calculating total power density, Measure and add $10 \log (N_{ANT})$ dB.
- Directional gain = $5.99\text{dBi} + 10\log(2) = 9.00\text{dBi} > 6\text{dBi}$, so the power density limit shall be reduced to $30 - (9.00 - 6) = 27.00\text{dBm}$.
- Refer to section 3.3 for duty cycle spectrum plot.

Spectrum Plot of Worst Value

802.11a

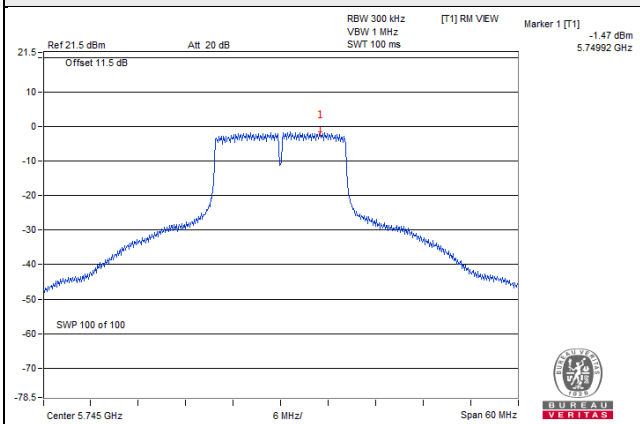

802.11n (HT20)

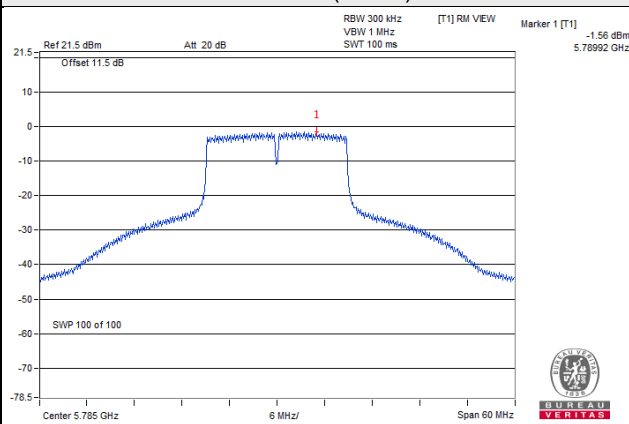

802.11n (HT40)

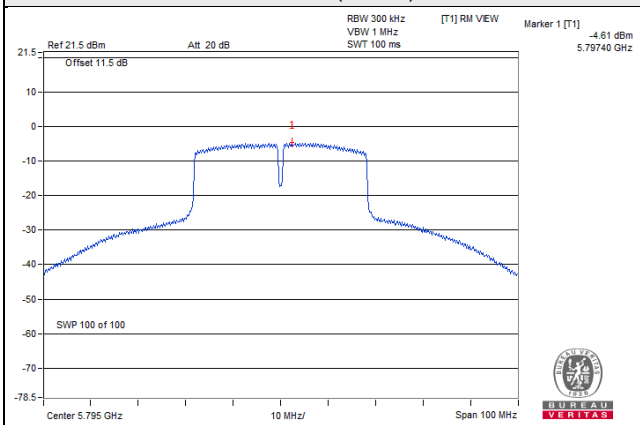

802.11ac (VHT80)

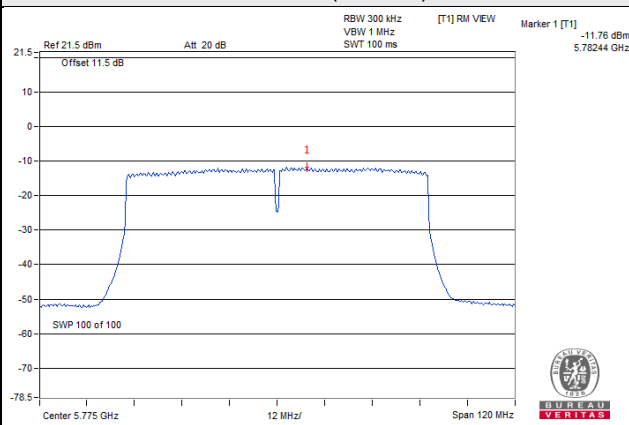

4.6 Frequency Stability

4.6.1 Limits of Frequency Stability Measurement

The frequency of the carrier signal shall be maintained within band of operation

4.6.2 Test Setup

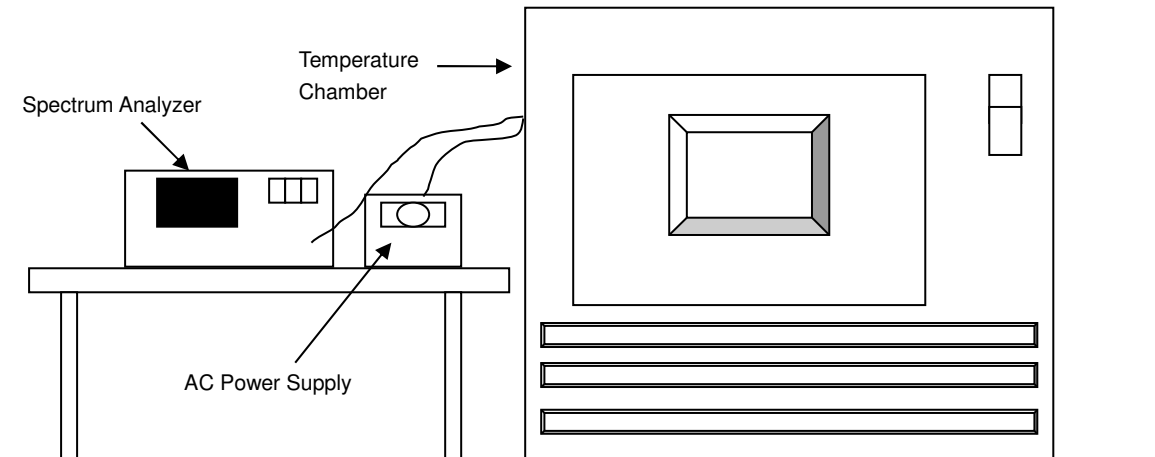

4.6.3 Test Instruments

Description & Manufacturer	Model No.	Serial No.	Cal. Date	Cal. Due
Spectrum Analyzer ROHDE & SCHWARZ	FSP40	100040	Sep. 23, 2019	Sep. 22, 2020
WIT Standard Temperature And Humidity Chamber	TH-4S-C	W981030	Jun. 03, 2019	Jun. 02, 2020
Digital Multimeter Fluke	87-III	70360742	Jun. 28, 2019	Jun. 27, 2020
AC Power Supply Extech	CFW-105	E000603	NA	NA

Note: 1. The calibration interval of the above test instruments is 12 months and the calibrations are traceable to NML/ROC and NIST/USA.

4.6.4 Test Procedure

- The EUT was placed inside the environmental test chamber and powered by nominal AC voltage.
- Turn the EUT on and couple its output to a spectrum analyzer.
- Turn the EUT off and set the chamber to the highest temperature specified.
- Allow sufficient time (approximately 30 min) for the temperature of the chamber to stabilize, turn the EUT on and measure the operating frequency after 2, 5, and 10 minutes.
- Repeat step c and d with every 10 degrees reduction until the lowest temperature achieved.
- The test chamber was allowed to stabilize at +20 degree C for a minimum of 30 minutes. The supply voltage was then adjusted on the EUT from 85% to 115% and the frequency record.

4.6.5 Deviation from Test Standard

No deviation.

4.6.6 EUT Operating Condition

Set the EUT transmit at un-modulation mode to test frequency stability.

4.6.7 Test Results

Frequency Stability Versus Temp.									
Operating Frequency: 5180MHz									
Temp. (°C)	Power Supply (Vac)	0 Minute		2 Minute		5 Minute		10 Minute	
		Measured Frequency (MHz)	Result	Measured Frequency (MHz)	Result	Measured Frequency (MHz)	Result	Measured Frequency (MHz)	Result
50	120	5180.0031	Pass	5180.001	Pass	5179.9989	Pass	5179.9983	Pass
40	120	5179.995	Pass	5179.9933	Pass	5179.9975	Pass	5179.9929	Pass
30	120	5179.9878	Pass	5179.9863	Pass	5179.9844	Pass	5179.9842	Pass
20	120	5180.0224	Pass	5180.0249	Pass	5180.0222	Pass	5180.0232	Pass
10	120	5180.0097	Pass	5180.0132	Pass	5180.0125	Pass	5180.0146	Pass
0	120	5180.0112	Pass	5180.0112	Pass	5180.0069	Pass	5180.0115	Pass
-10	120	5179.9906	Pass	5179.9903	Pass	5179.9921	Pass	5179.9949	Pass
-20	120	5180.0258	Pass	5180.0231	Pass	5180.0241	Pass	5180.0241	Pass
-30	120	5179.9988	Pass	5179.9965	Pass	5179.9977	Pass	5179.9945	Pass

Frequency Stability Versus Voltage									
Operating Frequency: 5180MHz									
Temp. (°C)	Power Supply (Vac)	0 Minute		2 Minute		5 Minute		10 Minute	
		Measured Frequency (MHz)	Result	Measured Frequency (MHz)	Result	Measured Frequency (MHz)	Result	Measured Frequency (MHz)	Result
20	138	5180.0226	Pass	5180.0257	Pass	5180.0227	Pass	5180.0228	Pass
	120	5180.0224	Pass	5180.0249	Pass	5180.0222	Pass	5180.0232	Pass
	102	5180.0214	Pass	5180.0246	Pass	5180.0224	Pass	5180.0241	Pass

4.7 6dB Bandwidth Measurement

4.7.1 Limits of 6dB Bandwidth Measurement

The minimum of 6dB Bandwidth Measurement is 0.5MHz.

4.7.2 Test Setup

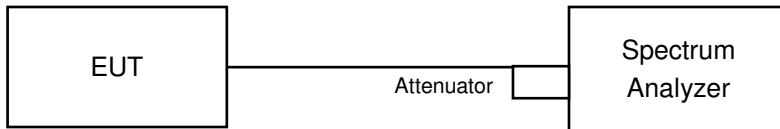

4.7.3 Test Instruments

Refer to section 4.1.2 to get information of above instrument.

4.7.4 Test Procedure

- Set resolution bandwidth (RBW) = 100kHz
- Set the video bandwidth (VBW) $\geq 3 \times$ RBW, Detector = Peak.
- Trace mode = max hold.
- Sweep = auto couple.
- Measure the maximum width of the emission that is constrained by the frequencies associated with the two amplitude points (upper and lower) that are attenuated by 6 dB relative to the maximum level measured in the fundamental emission

4.7.5 Deviation from Test Standard

No deviation.

4.7.6 EUT Operating Condition

The software provided by client to enable the EUT under transmission condition continuously at lowest, middle and highest channel frequencies individually.

4.7.7 Test Results

802.11a

Channel	Frequency (MHz)	6dB Bandwidth (MHz)		Minimum Limit (MHz)	Pass / Fail
		Chain 0	Chain 1		
149	5745	16.36	16.36	0.5	Pass
157	5785	16.39	16.39	0.5	Pass
165	5825	16.41	16.42	0.5	Pass

802.11n (HT20)

Channel	Frequency (MHz)	6dB Bandwidth (MHz)		Minimum Limit (MHz)	Pass / Fail
		Chain 0	Chain 1		
149	5745	17.61	17.63	0.5	Pass
157	5785	17.63	17.64	0.5	Pass
165	5825	17.61	17.63	0.5	Pass

802.11n (HT40)

Channel	Frequency (MHz)	6dB Bandwidth (MHz)		Minimum Limit (MHz)	Pass / Fail
		Chain 0	Chain 1		
151	5755	35.22	35.32	0.5	Pass
159	5795	35.28	35.23	0.5	Pass

802.11ac (VHT80)

Channel	Frequency (MHz)	6dB Bandwidth (MHz)		Minimum Limit (MHz)	Pass / Fail
		Chain 0	Chain 1		
155	5775	76.22	75.98	0.5	Pass

Spectrum Plot of Worst Value

802.11a

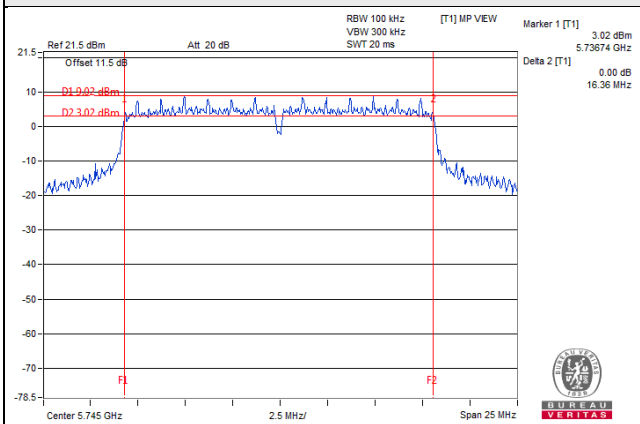

802.11n (HT20)

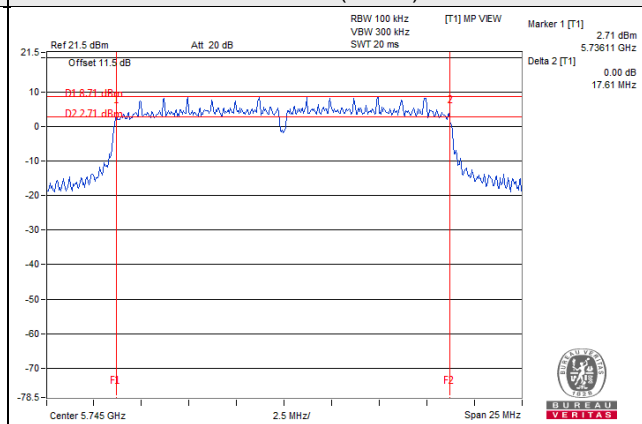

802.11n (HT40)

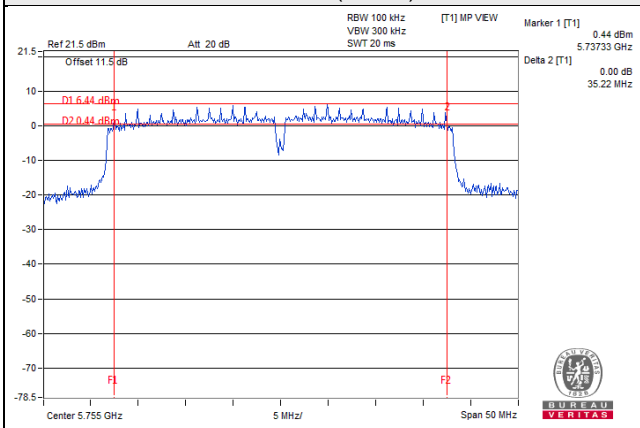

802.11ac (VHT80)

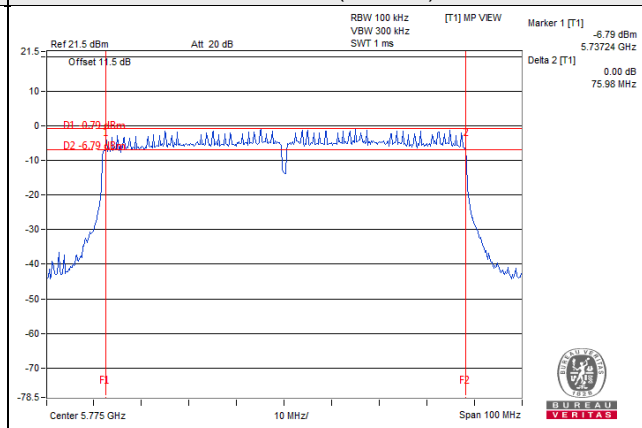

5 Pictures of Test Arrangements

Please refer to the attached file (Test Setup Photo).

Annex A- Radiated Out of Band Emission (OOBE) Measurement (For U-NII-3 band)

802.11a

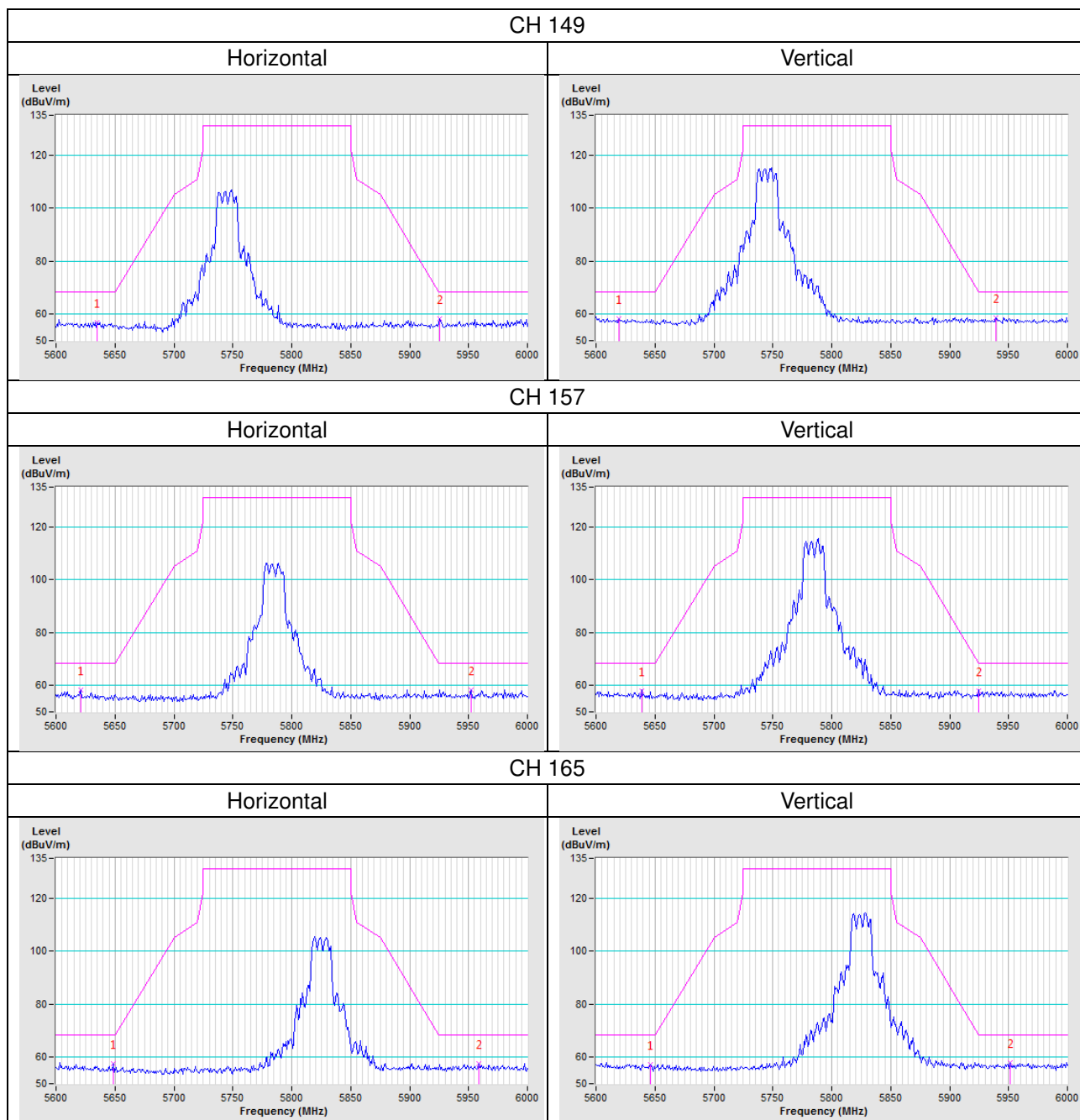

802.11n (HT20)

CH 149

Horizontal

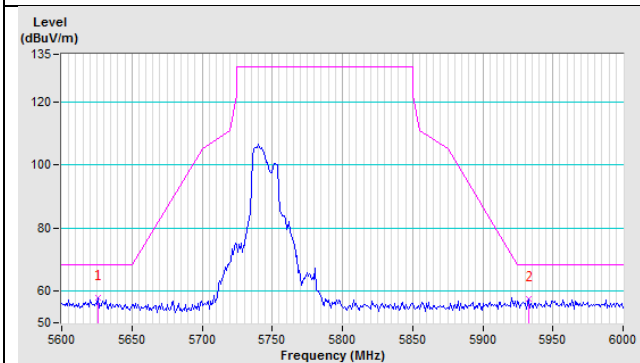

Vertical

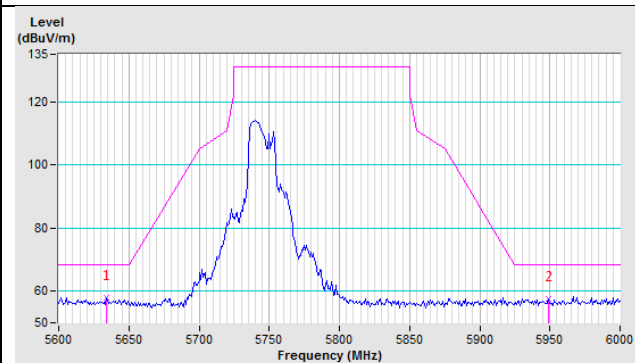

CH 157

Horizontal

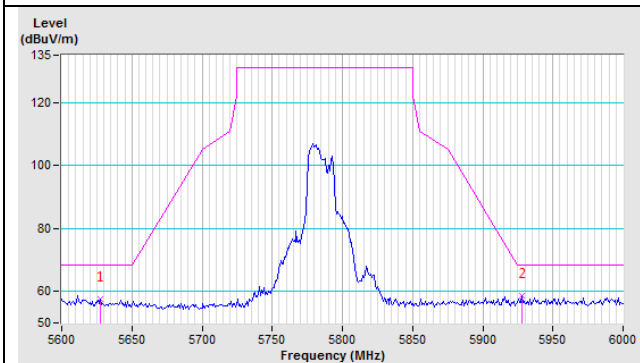

Vertical

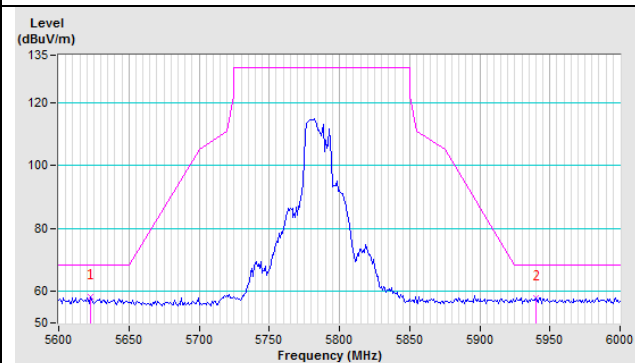

CH 165

Horizontal

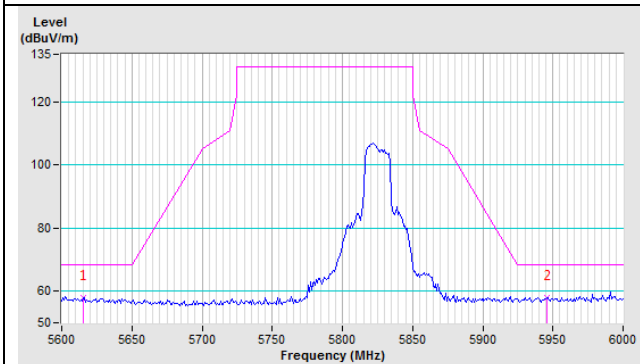

Vertical

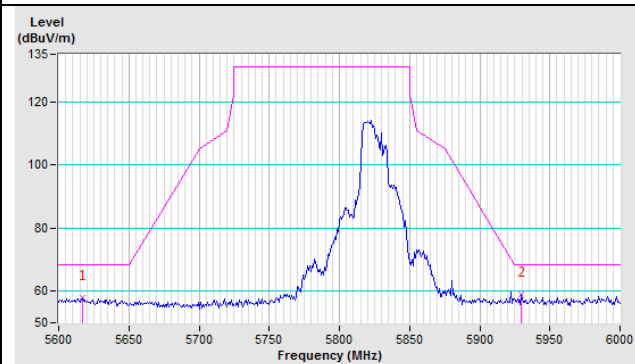

802.11n (HT40)

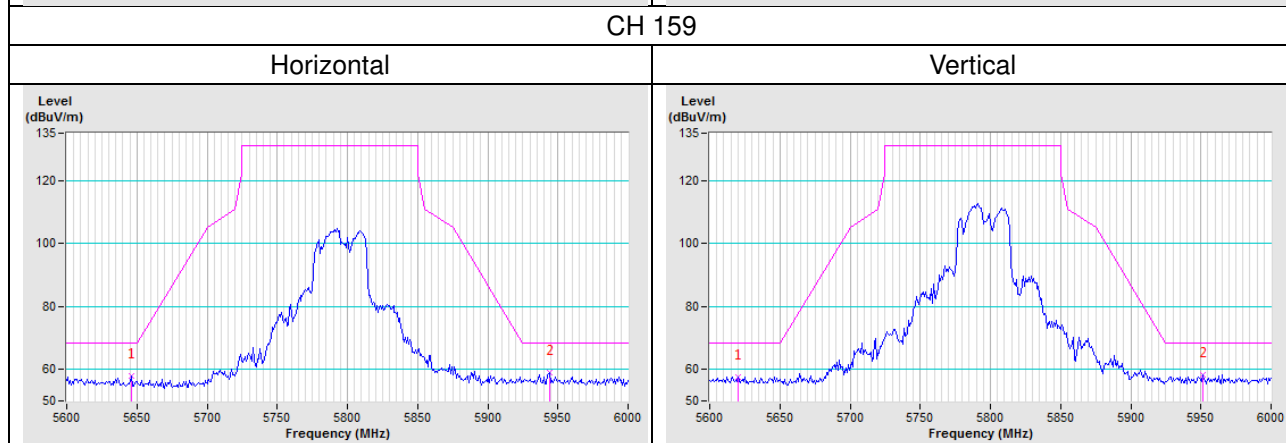
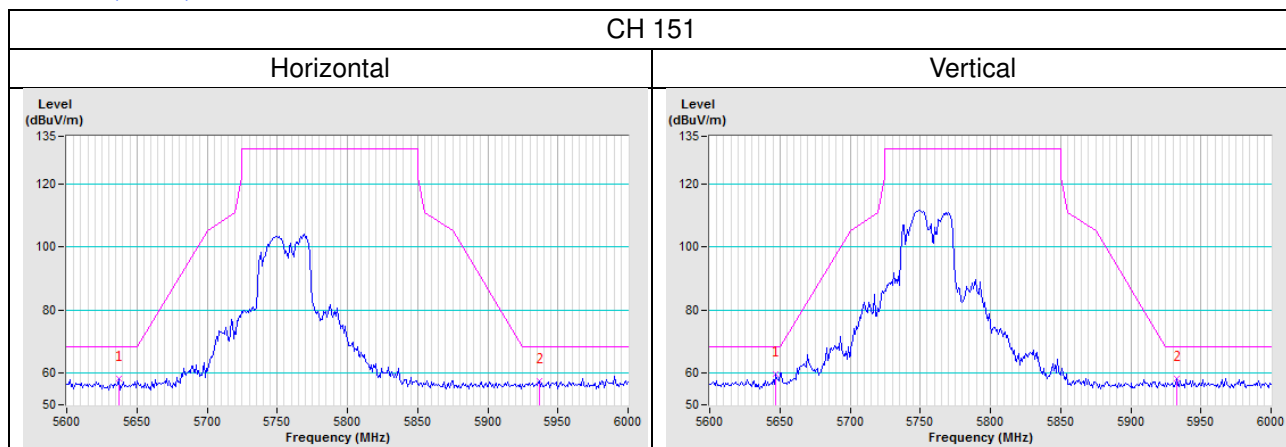

802.11ac (VHT80)

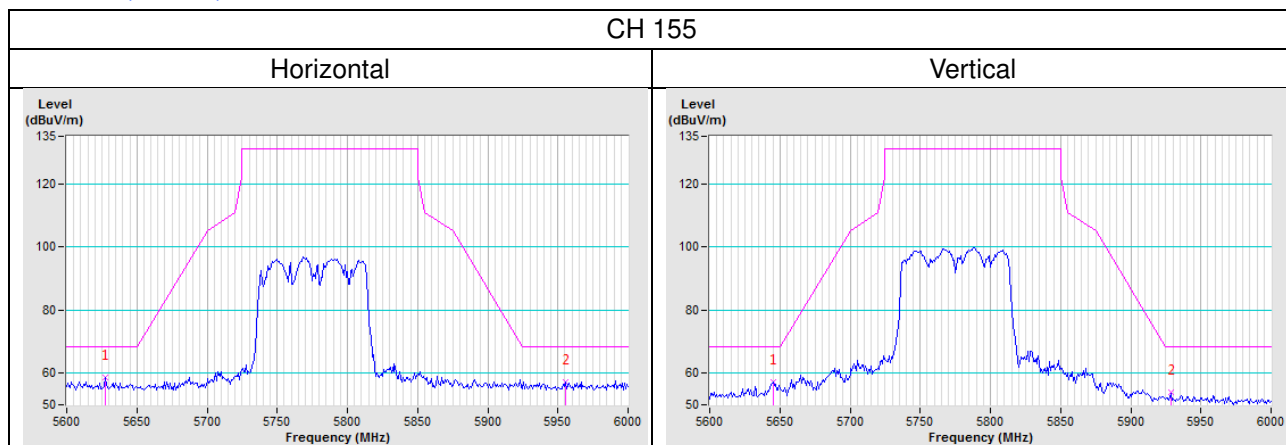

Appendix – Information of the Testing Laboratories

We, Bureau Veritas Consumer Products Services (H.K.) Ltd., Taoyuan Branch, were founded in 1988 to provide our best service in EMC, Radio, Telecom and Safety consultation. Our laboratories are FCC recognized accredited test firms and accredited and approved according to ISO/IEC 17025.

If you have any comments, please feel free to contact us at the following:

Lin Kou EMC/RF Lab

Tel: 886-2-26052180

Fax: 886-2-26051924

Hsin Chu EMC/RF/Telecom Lab

Tel: 886-3-6668565

Fax: 886-3-6668323

Hwa Ya EMC/RF/Safety

Tel: 886-3-3183232

Fax: 886-3-3270892

Email: service.adt@tw.bureauveritas.com

Web Site: www.bureauveritas-adt.com

The address and road map of all our labs can be found in our web site also.

--- END ---