

# FCC Radio Test Report

## FCC ID: 2ASWY19TFTTLW1

This report concerns: Original Grant

**Project No.** : 1903H003  
**Equipment** : GPS Tracker  
**Brand Name** : TOPFLYtech  
**Test Model** : TLW1-10A  
**Series Model** : TLW1-4A、TLW1-8A  
**Applicant** : SHENZHEN TOPFLYTECH CO., LIMITED  
**Address** : Rm409 Scientific Research Building Tsinghua Hi-tech Park Hi-tech Industrial Nanshan District, shenzhen, China  
**Manufacturer** : SHENZHEN TOPFLYTECH CO., LIMITED  
**Address** : Rm409 Scientific Research Building Tsinghua Hi-tech Park Hi-tech Industrial Nanshan District, shenzhen, China  
**Factory** : SHENZHEN TOPFLYTECH CO., LIMITED  
**Address** : Rm409 Scientific Research Building Tsinghua Hi-tech Park Hi-tech Industrial Nanshan District, shenzhen, China  
**Date of Receipt** : Mar. 13, 2019  
**Date of Test** : Mar. 13, 2019~Mar. 03, 2020  
**Issued Date** : Apr. 09, 2020  
**Report Version** : R04  
**Test Sample** : Engineering Sample No.: SH19072225/-1  
**Standard(s)** : FCC Part15, Subpart C (15.247)  
ANSI C63.10-2013  
KDB 558074 D01 15.247 Meas Guidance v05r02

The above equipment has been tested and found compliance with the requirement of the relative standards by BTL Inc.



Prepared by : Iscaa Min

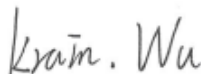

Approved by : Krain Wu



Certificate # 5123. 03

Add: No. 29, Jintang Road, Tangzhen Industry Park, Pudong New Area, Shanghai 201210, China

TEL: +86-021-61765666

Web: [www.newbtl.com](http://www.newbtl.com)

**Declaration**

**BTL** represents to the client that testing is done in accordance with standard procedures as applicable and that test instruments used has been calibrated with standards traceable to international standard(s) and/or national standard(s).

**BTL's** reports apply only to the specific samples tested under conditions. It is manufacture's responsibility to ensure that additional production units of this model are manufactured with the identical electrical and mechanical components. **BTL** shall have no liability for any declarations, inferences or generalizations drawn by the client or others from **BTL** issued reports.

The report must not be used by the client to claim product certification, approval, or endorsement by NVLAP, NIST, A2LA, or any agency of the U.S. Government.

This report is the confidential property of the client. As a mutual protection to the clients, the public and ourselves, the test report shall not be reproduced, except in full, without our written approval.

**BTL's** laboratory quality assurance procedures are in compliance with the **ISO/IEC 17025** requirements, and accredited by the conformity assessment authorities listed in this test report.

**BTL** is not responsible for the sampling stage, so the results only apply to the sample as received.

The information, data and test plan are provided by manufacturer which may affect the validity of results, so it is manufacturer's responsibility to ensure that the apparatus meets the essential requirements of applied standards and in all the possible configurations as representative of its intended use.

**Limitation**

For the use of the authority's logo is limited unless the Test Standard(s)/Scope(s)/Item(s) mentioned in this test report is (are) included in the conformity assessment authorities acceptance respective.

Please note that the measurement uncertainty is provided for informational purpose only and are not use in determining the Pass/Fail results.

<b>Table of Contents</b>	<b>Page</b>
<b>REPORT ISSUED HISTORY</b>	<b>5</b>
<b>1 . SUMMARY OF TEST RESULTS</b>	<b>6</b>
1.1 TEST FACILITY	7
1.2 MEASUREMENT UNCERTAINTY	7
1.3 TEST ENVIRONMENT CONDITIONS	7
<b>2 . GENERAL INFORMATION</b>	<b>8</b>
2.1 GENERAL DESCRIPTION OF EUT	8
2.2 DESCRIPTION OF TEST MODES	10
2.3 PARAMETERS OF TEST SOFTWARE	11
2.4 BLOCK DIAGRAM SHOWING THE CONFIGURATION OF SYSTEM TESTED	12
2.5 SUPPORT UNITS	12
<b>3 . AC POWER LINE CONDUCTED EMISSIONS TEST</b>	<b>13</b>
3.1 LIMIT	13
3.2 TEST PROCEDURE	13
3.3 DEVIATION FROM TEST STANDARD	13
3.4 TEST SETUP	14
3.5 EUT OPERATING CONDITIONS	14
3.6 TEST RESULTS	14
<b>4 . RADIATED EMISSION TEST</b>	<b>15</b>
4.1 LIMIT	15
4.2 TEST PROCEDURE	16
4.3 DEVIATION FROM TEST STANDARD	16
4.4 TEST SETUP	17
4.5 EUT OPERATING CONDITIONS	18
4.6 TEST RESULT – 9 KHZ TO 30 MHZ	18
4.7 TEST RESULT – 30 MHZ TO 1000 MHZ	18
4.8 TEST RESULT – ABOVE 1000 MHZ	18
<b>5 . BANDWIDTH TEST</b>	<b>19</b>
5.1 LIMIT	19
5.2 TEST PROCEDURE	19
5.3 DEVIATION FROM STANDARD	19
5.4 TEST SETUP	19
5.5 EUT OPERATION CONDITIONS	19

<b>Table of Contents</b>	<b>Page</b>
5.6 TEST RESULTS	19
<b>6 . MAXIMUM OUTPUT POWER &amp; E.I.R.P. TEST</b>	<b>20</b>
6.1 LIMIT	20
6.2 TEST PROCEDURE	20
6.3 DEVIATION FROM STANDARD	20
6.4 TEST SETUP	20
6.5 EUT OPERATION CONDITIONS	20
6.6 TEST RESULTS	20
<b>7 . CONDUCTED SPURIOUS EMISSION</b>	<b>21</b>
7.1 LIMIT	21
7.2 TEST PROCEDURE	21
7.3 DEVIATION FROM STANDARD	21
7.4 TEST SETUP	21
7.5 EUT OPERATION CONDITIONS	21
7.6 TEST RESULTS	21
<b>8 . POWER SPECTRAL DENSITY TEST</b>	<b>22</b>
8.1 LIMIT	22
8.2 TEST PROCEDURE	22
8.3 DEVIATION FROM STANDARD	22
8.4 TEST SETUP	22
8.5 EUT OPERATION CONDITIONS	22
8.6 TEST RESULTS	22
<b>9 . MEASUREMENT INSTRUMENTS LIST</b>	<b>23</b>
<b>10 . EUT TEST PHOTO</b>	<b>25</b>
<b>APPENDIX A – AC POWER LINE CONDUCTED EMISSIONS</b>	<b>27</b>
<b>APPENDIX B – RADIATED EMISSION – 9 KHZ TO 30 MHZ</b>	<b>28</b>
<b>APPENDIX C – RADIATED EMISSION – 30 MHZ TO 1000 MHZ</b>	<b>29</b>
<b>APPENDIX D – RADIATED EMISSION – ABOVE 1000 MHZ</b>	<b>34</b>
<b>APPENDIX E – BANDWIDTH</b>	<b>49</b>
<b>APPENDIX F – MAXIMUM OUTPUT POWER &amp; E.I.R.P.</b>	<b>51</b>
<b>APPENDIX G – CONDUCTED SPURIOUS EMISSION</b>	<b>53</b>
<b>APPENDIX H – POWER SPECTRAL DENSITY</b>	<b>55</b>

**REPORT ISSUED HISTORY**

Report Version	Description	Issued Date
R00	Original Issue.	Feb. 24, 2020
R01	Add the co-located radiated spurious emission data in page 32-33 and 47-48.	Mar. 04, 2020
R02	Update the description of Mode 4 in page10.	Mar. 26, 2020
R03	Update the test mode description in page10.	Apr. 08, 2020
R04	Modify the "BT Continue Transmition (1M 2402MHz ) with GSM 850 CH128 link" test data in page 32-33.	Apr. 09, 2020

**1. SUMMARY OF TEST RESULTS**

Test procedures according to the technical standard(s):

FCC Part15, Subpart C (15.247)				
Standard(s) Section	Test Item	Test Result	Judgment	Remark
15.207	AC Power Line Conducted Emissions	APPENDIX A	N/A	-----
15.247(d) 15.205(a) 15.209(a)	Radiated Emissions	APPENDIX B APPENDIX C APPENDIX D	PASS	-----
15.247(a)(2)	Bandwidth	APPENDIX E	PASS	-----
15.247(b)(3)	Maximum Output Power	APPENDIX F	PASS	-----
15.247(d)	Conducted Spurious Emission	APPENDIX G	PASS	-----
15.247(e)	Power Spectral Density	APPENDIX H	PASS	-----
15.203	Antenna Requirement	-----	PASS	-----

Note:

- (1) "N/A" denotes test is not applicable to this device.
- (2) The device what use a permanently attached antenna were considered sufficient to comply with the provisions of 15.203.

### 1.1 TEST FACILITY

The test facilities used to collect the test data in this report is at the location of No. 29, Jintang Road, Tangzhen Industry Park, Pudong New Area, Shanghai 201210, China  
 BTL's Test Firm Registration Number for FCC: 476765  
 BTL's Designation Number for FCC: CN1241

### 1.2 MEASUREMENT UNCERTAINTY

ISO/IEC 17025 requires that an estimate of the measurement uncertainties associated with the emissions test results be included in the report. The measurement uncertainties given below are based on a 95% confidence level (based on a coverage factor (k=2))  
 The BTL measurement uncertainty as below table:

#### A. Radiated emissions test:

Test Site	Method	Measurement Frequency Range	Ant. H / V	U, (dB)
SH-CB01	CISPR	9 KHz~30 MHz	V	3.79
		9 KHz~30 MHz	H	3.57
		30 MHz~200 MHz	V	4.04
		30 MHz~200 MHz	H	3.76
		200 MHz~1,000 MHz	V	4.24
		200 MHz~1,000 MHz	H	3.84
		1 GHz~18 GHz	V	4.46
		1 GHz~18 GHz	H	4.40
		18 GHz~40 GHz	V	3.95
		18 GHz~40 GHz	H	3.95

Note: Unless specifically mentioned, the uncertainty of measurement has not been taken into account to declare the compliance or non-compliance to the specification.

### 1.3 TEST ENVIRONMENT CONDITIONS

Test Item	Temperature	Humidity	Test Voltage	Tested By
Radiated Emissions-30 MHz to 1GHz	17.2°C	49%	DC 12V	Vince Zong
Radiated Emissions-Above 1000 MHz	19°C	41%	DC 12V	Vince Zong
Bandwidth	22°C	54%	DC 12V	Bill Dong
Maximum Output Power & e.i.r.p.	22°C	54%	DC 12V	Bill Dong
Conducted Spurious Emission	22°C	54%	DC 12V	Bill Dong
Power Spectral Density	22°C	54%	DC 12V	Bill Dong

## 2. GENERAL INFORMATION

### 2.1 GENERAL DESCRIPTION OF EUT

Equipment	GPS Tracker					
Brand Name	TOPFLYtech					
Test Model	TLW1-10A					
Series Model	TLW1-4A, TLW1-8A					
Model Difference(s)	Pin	Signal	TLW1-10A	TLW1-8A	TLW1-4A	
	1	Analog input	√			
	2	GND	√	√		
	3	Analog input	√	√		
	4	DC Power	√	√	√	
	5	GND	√	√	√	
	6	Digital input	√	√	√	
	7	Digital output	√	√	√	
	8	SOS button signal	√	√		
	9	GND	√	√		
	10	Digital output	√			
Software Version	V1.0.0					
Hardware Version	V2.2					
Power Source	# 1. DC voltage supplied from external power supply. # 2. Battery supply					
Power Rating	#1 DC 12V #2 DC 3.7V, 200mAh					
Operation Frequency	2402 MHz ~ 2480 MHz					
Modulation Technology	GFSK					
Bit Rate of Transmitter	1Mbps					
Max. Output Power	4.84 dBm (0.0030 W)					

Note:

1. For a more detailed features description, please refer to the manufacturer's specifications or the user's manual.



## 2. Channel List:

Channel	Frequency (MHz)	Channel	Frequency (MHz)
00	2402	20	2442
01	2404	21	2444
02	2406	22	2446
03	2408	23	2448
04	2410	24	2450
05	2412	25	2452
06	2414	26	2454
07	2416	27	2456
08	2418	28	2458
09	2420	29	2460
10	2422	30	2462
11	2424	31	2464
12	2426	32	2466
13	2428	33	2468
14	2430	34	2470
15	2432	35	2472
16	2434	36	2474
17	2436	37	2476
18	2438	38	2478
19	2440	39	2480

## 3. Table for Filed Antenna:

Ant.	Brand	Model Name	Antenna Type	Connector	Gain (dBi)
1	N/A	N/A	Internal	N/A	0.4

## 2.2 DESCRIPTION OF TEST MODES

The test system was pre-tested based on the consideration of all possible combinations of EUT operation mode.

Pretest Mode	Description
Mode 1	TX 2402MHz_CH00_1Mbps
Mode 2	TX 2440MHz_CH19_1Mbps
Mode 3	TX 2480MHz_CH39_1Mbps
Mode 4	BT Continue Transmission with LTE
Mode 5	BT Continue Transmission with GSM link

Following mode(s) as (were) found to be the worst case(s) and selected for the final test.

Radiated emissions test - Below 1GHz	
Final Test Mode	Description
Mode 3	TX 2480MHz_CH39_1Mbps
Mode 5	BT Continue Transmission (1M 2402MHz ) with GSM 850 CH128 link

Radiated emissions test - Above 1GHz	
Final Test Mode	Description
Mode 1	TX 2402MHz_CH00_1Mbps
Mode 2	TX 2440MHz_CH19_1Mbps
Mode 3	TX 2480MHz_CH39_1Mbps
Mode 5	BT Continue Transmission (1M 2402MHz ) with GSM 850 CH128 link

Conducted test	
Final Test Mode	Description
Mode 1	TX 2402MHz_CH00_1Mbps
Mode 2	TX 2440MHz_CH19_1Mbps
Mode 3	TX 2480MHz_CH39_1Mbps

Note:

- (1) For radiated emission above 1 GHz test, 1GHz~26.5GHz have been pre-tested and in this report only recorded the worst case. The remaining spurious points are all below the limit value of 20dB.
- (2) Below 30MHz, The measured value have enough margin over 20dB than the limit, therefore they are not reported.
- (3) For Mode 5, GSM 850 CH128 has the highest power, so tested with BT continue transmission.

### 2.3 PARAMETERS OF TEST SOFTWARE

During testing channel & power controlling software provided by the customer was used to control the operating channel as well as the output power level. The RF output power selection is for the setting of RF output power expected by the customer and is going to be fixed on the firmware of the final end product power parameters of BT LE

Test Software	Meta2_3G_C2K.exe		
Frequency (MHz)	2402	2440	2480
Parameters(1Mbps)	default	default	default

## 2.4 BLOCK DIAGRAM SHOWING THE CONFIGURATION OF SYSTEM TESTED

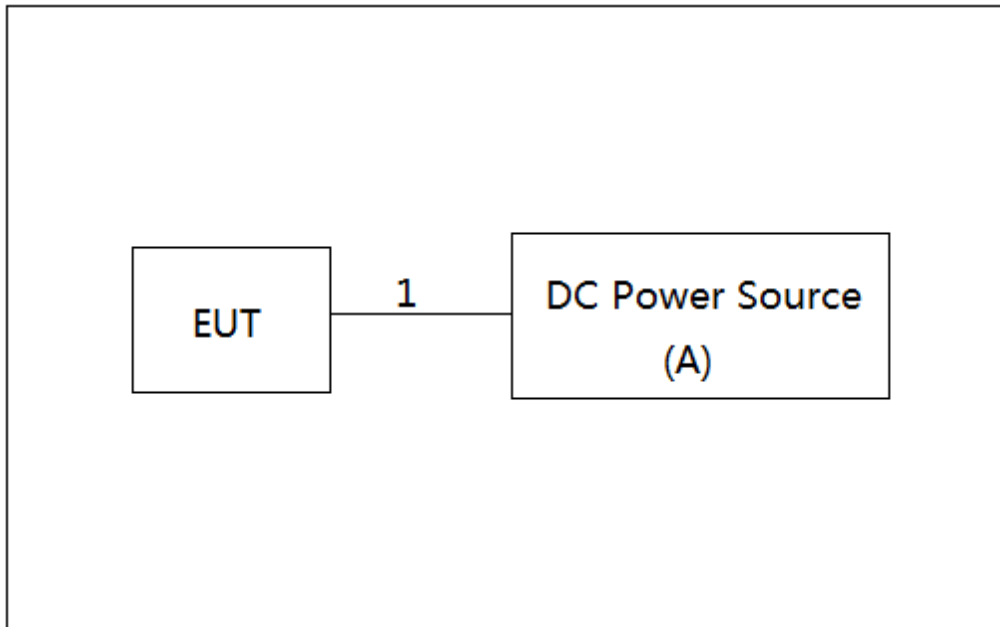

## 2.5 SUPPORT UNITS

Item	Equipment	Brand	Model/Type No.	Series No.
A	DC Power Source	TRUE-POWER	GPC30300N	NA

Item	Cable Type	Shielded Type	Ferrite Core	Length
1	DC cable	N/A	N/A	1.2m

### 3. AC POWER LINE CONDUCTED EMISSIONS TEST

#### 3.1 LIMIT

Frequency of Emission (MHz)	Limit (dB $\mu$ V)	
	Quasi-peak	Average
0.15 - 0.5	66 to 56*	56 to 46*
0.50 - 5.0	56	46
5.0 - 30.0	60	50

Note:

- (1) The tighter limit applies at the band edges.
- (2) The limit of " \* " marked band means the limitation decreases linearly with the logarithm of the frequency in the range.

The following table is the setting of the receiver

Receiver Parameters	Setting
Attenuation	10 dB
Start Frequency	0.15 MHz
Stop Frequency	30 MHz
IF Bandwidth	9 kHz

#### 3.2 TEST PROCEDURE

- a. The EUT was placed 0.8 meters from the horizontal ground plane with EUT being connected to the power mains through a line impedance stabilization network (LISN). All other support equipment powered from additional LISN(s). The LISN provide 50 Ohm/ 50uH of coupling impedance for the measuring instrument.
- b. Interconnecting cables that hang closer than 40 cm to the ground plane shall be folded back and forth in the center forming a bundle 30 to 40 cm long.
- c. I/O cables that are not connected to a peripheral shall be bundled in the center. The end of the cable may be terminated, if required, using the correct terminating impedance. The overall length shall not exceed 1 m.
- d. LISN at least 80 cm from nearest part of EUT chassis.
- e. For the actual test configuration, please refer to the related Item –EUT Test Photos.

#### 3.3 DEVIATION FROM TEST STANDARD

No deviation

### 3.4 TEST SETUP

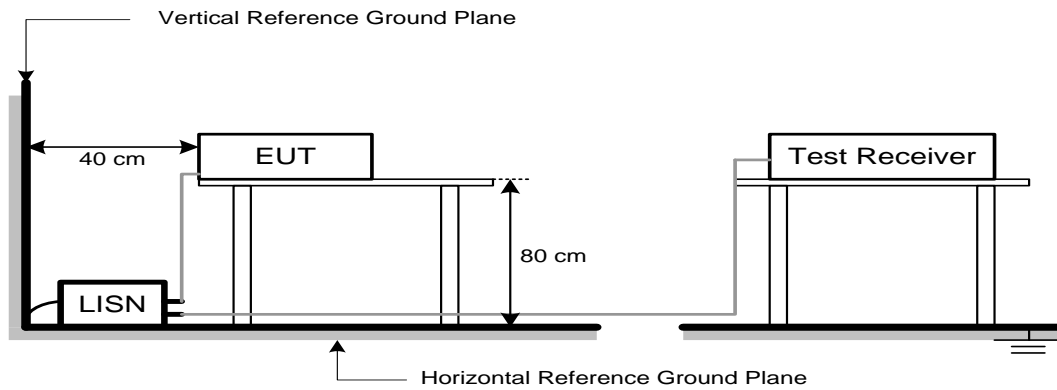

### 3.5 EUT OPERATING CONDITIONS

The EUT was configured for testing in a typical fashion (as a customer would normally use it). The EUT has been programmed to continuously transmit during test. This operating condition was tested and used to collect the included data.

### 3.6 TEST RESULTS

Please refer to the APPENDIX A.

Remark:

- (1) All readings are QP Mode value unless otherwise stated AVG in column of 『Note』 . If the QP Mode Measured value compliance with the QP Limits and lower than AVG Limits, the EUT shall be deemed to meet both QP & AVG Limits and then only QP Mode was measured, but AVG Mode didn't perform. In this case, a “ \* ” marked in AVG Mode column of Interference Voltage Measured.
- (2) Measuring frequency range from 150 kHz to 30 MHz.

**4. RADIATED EMISSION TEST****4.1 LIMIT**

In case the emission fall within the restricted band specified on 15.205(a), then the 15.209(a) limit in the table below has to be followed.

**LIMITS OF RADIATED EMISSION MEASUREMENT (9 kHz-1000 MHz)**

Frequency (MHz)	Field Strength (microvolts/meter)	Measurement Distance (meters)
0.009-0.490	2400/F(kHz)	300
0.490-1.705	24000/F(kHz)	30
1.705-30.0	30	30
30-88	100	3
88-216	150	3
216-960	200	3
Above 960	500	3

**LIMITS OF RADIATED EMISSION MEASUREMENT (Above 1000 MHz)**

Frequency (MHz)	(dBuV/m at 3 m)	
	Peak	Average
Above 1000	74	54

**Note:**

- (1) The limit for radiated test was performed according to FCC PART 15C.
- (2) The tighter limit applies at the band edges.
- (3) Emission level (dBuV/m)=20log Emission level (uV/m).
- (4) The test result calculated as following:  
 Measurement Value = Reading Level + Correct Factor  
 Correct Factor = Antenna Factor + Cable Loss - Amplifier Gain(if use)  
 Margin Level = Measurement Value - Limit Value

Spectrum Parameter	Setting
Attenuation	Auto
Start Frequency	1000 MHz
Stop Frequency	10th carrier harmonic
RBW / VBW (Emission in restricted band)	RBW 1 MHz VBW 3 MHz peak detector for Pk value RMS detector for AV value

Receiver Parameter	Setting
Attenuation	Auto
Start ~ Stop Frequency	9 kHz~90 kHz for PK/AVG detector
Start ~ Stop Frequency	90 kHz~110 kHz for QP detector
Start ~ Stop Frequency	110 kHz~490 kHz for PK/AVG detector
Start ~ Stop Frequency	490 kHz~30 MHz for QP detector
Start ~ Stop Frequency	30 MHz~1000 MHz for QP detector

#### 4.2 TEST PROCEDURE

- a. The measuring distance of 3 m shall be used for measurements. The EUT was placed on the top of a rotating table 0.8 meter above the ground at a 3 meter semi-anechoic chamber. The table was rotated 360 degrees to determine the position of the highest radiation.(below 1 GHz)
- b. The measuring distance of 3 m shall be used for measurements. The EUT was placed on the top of a rotating table 1.5 meter above the ground at a 3 meter semi-anechoic chamber. The table was rotated 360 degrees to determine the position of the highest radiation.(above 1 GHz)
- c. The height of the equipment or of the substitution antenna shall be 0.8m or 1.5m; the height of the test antenna shall vary between 1 m to 4 m. Both horizontal and vertical polarizations of the antenna are set to make the measurement.
- d. For each suspected emission, the EUT was arranged to its worst case and then the antenna was tuned to heights find the maximum reading (used Bore sight function).
- e. The receiver system was set to peak and average detect function and specified bandwidth with maximum hold mode when the test frequency is above 1 GHz.
- f. The initial step in collecting radiated emission data is a receiver peak detector mode pre-scanning the measurement frequency range. Significant peaks are then marked and then Quasi Peak detector mode re-measured.
- g. All readings are Peak unless otherwise stated QP in column of Note. Peak denotes that the Peak reading compliance with the QP Limits and then QP Mode measurement didn't perform.  
(below 1 GHz)
- h. All readings are Peak Mode value unless otherwise stated AVG in column of Note. If the Peak Mode Measured value compliance with the Peak Limits and lower than AVG Limits, the EUT shall be deemed to meet both Peak & AVG Limits and then only Peak Mode was measured, but AVG Mode didn't perform. (above 1 GHz)
- i. For the actual test configuration, please refer to the related Item –EUT Test Photos.

#### 4.3 DEVIATION FROM TEST STANDARD

No deviation

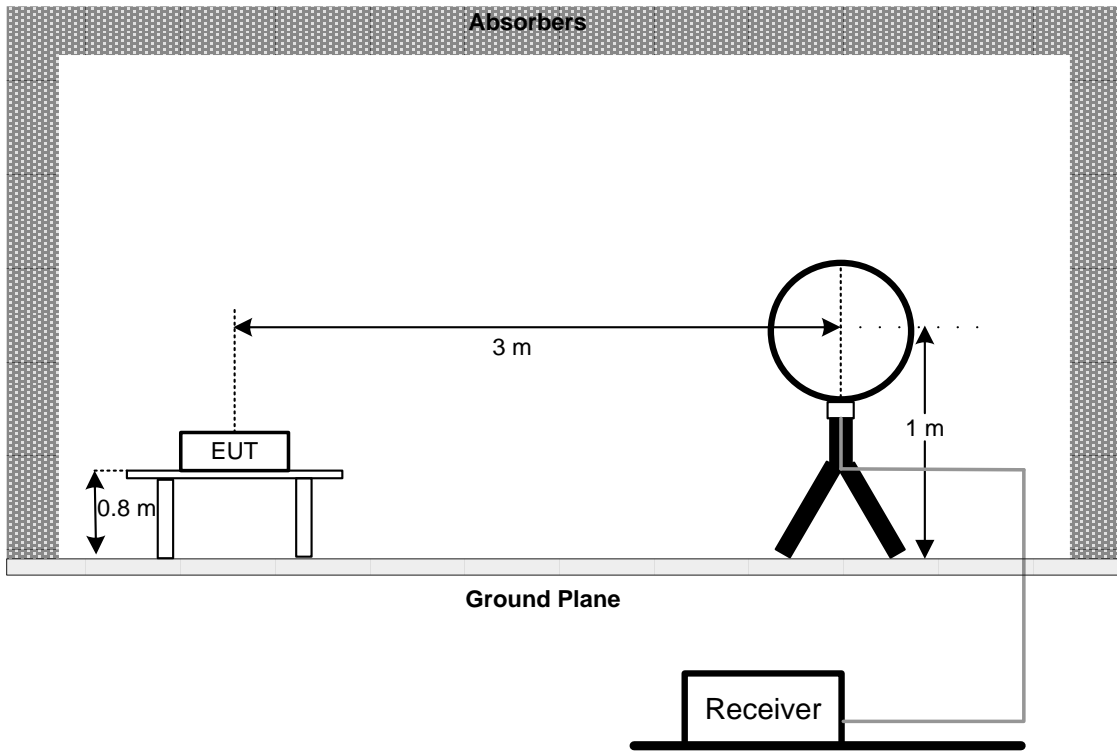
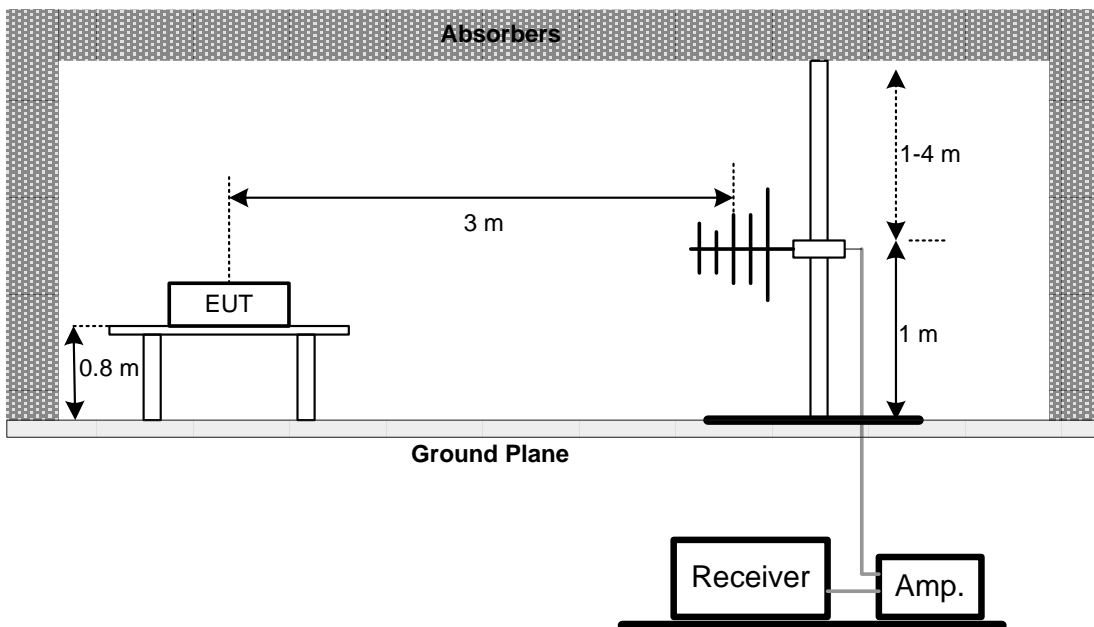

**4.4 TEST SETUP****9 kHz-30 MHz****30 MHz to 1 GHz**

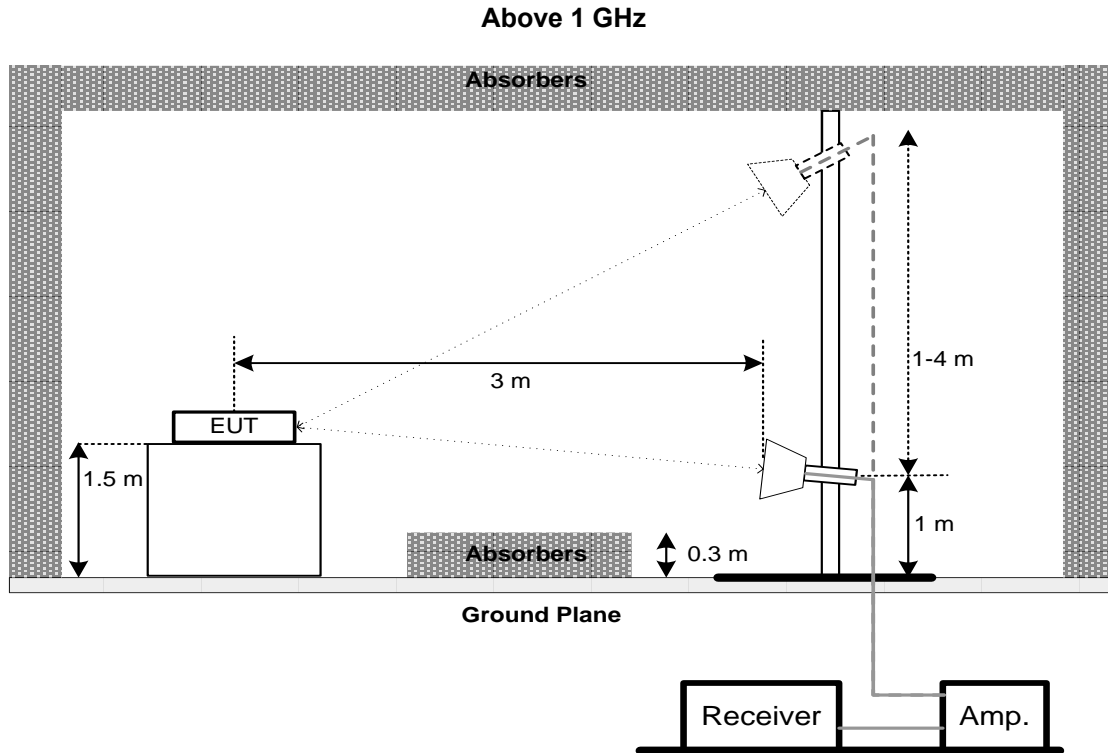

#### 4.5 EUT OPERATING CONDITIONS

The EUT was programmed to be in continuously transmitting mode.

#### 4.6 TEST RESULT - 9 kHz TO 30 MHz

Please refer to the APPENDIX B

Remark:

- (1) Distance extrapolation factor =  $40 \log (\text{specific distance} / \text{test distance})$  (dB).
- (2) Limit line = specific limits (dBuV) + distance extrapolation factor.

#### 4.7 TEST RESULT - 30 MHz TO 1000 MHz

Please refer to the APPENDIX C.

#### 4.8 TEST RESULT - ABOVE 1000 MHz

Please refer to the APPENDIX D.

Remark:

- (1) No limit: This is fundamental signal, the judgment is not applicable.  
For fundamental signal judgment was referred to Peak output test.

**5. BANDWIDTH TEST****5.1 LIMIT**

FCC Part15, Subpart C (15.247)		
Section	Test Item	Limit
15.247(a)(2)	Bandwidth	$\geq 500$ kHz (6 dB bandwidth)

**5.2 TEST PROCEDURE**

- The EUT was directly connected to the spectrum analyzer and antenna output port as show in the block diagram below.
- Spectrum Setting : RBW= 100 kHz, VBW=300 kHz, Sweep time = 2.5 ms.

**5.3 DEVIATION FROM STANDARD**

No deviation.

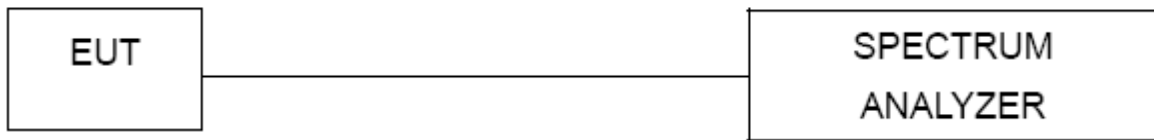
**5.4 TEST SETUP****5.5 EUT OPERATION CONDITIONS**

The EUT tested system was configured as the statements of 3.5 unless otherwise a special operating condition is specified in the follows during the testing.

**5.6 TEST RESULTS**

Please refer to the APPENDIX E.

**6. MAXIMUM OUTPUT POWER****6.1 LIMIT**

FCC Part15, Subpart C (15.247)		
Section	Test Item	Limit
15.247(b)(3)	Maximum Output Power	1 watt or 30 dBm

**6.2 TEST PROCEDURE**

- a. The EUT was directly connected to the spectrum analyzer and antenna output port as show in the block diagram below.
- b. The maximum conducted output power was performed in accordance with method 11.9.1.1 (for peak power) or 11.9.2.2 (for AVG power) of ANSI C63.10-2013.

**6.3 DEVIATION FROM STANDARD**

No deviation.

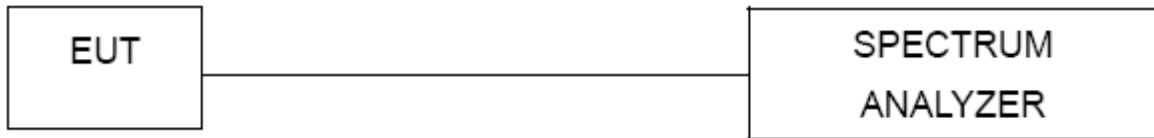
**6.4 TEST SETUP****6.5 EUT OPERATION CONDITIONS**

The EUT tested system was configured as the statements of 3.5 unless otherwise a special operating condition is specified in the follows during the testing.

**6.6 TEST RESULTS**

Please refer to the APPENDIX F.

## 7. CONDUCTED SPURIOUS EMISSION

### 7.1 LIMIT

In any 100 kHz bandwidth outside the frequency band in which the spread spectrum or digitally modulated intentional radiator is operating, the radio frequency power that is produced by the intentional radiator shall be at least 20 dB below that in the 100 kHz bandwidth within the band that contains the highest level of the desired power, based on either an RF conducted or a radiated measurement, provided the transmitter demonstrates compliance with the peak Output Power limits. If the transmitter complies with the Output Power limits based on the use of RMS averaging over a time interval, as permitted under paragraph (b)(3) of this section, the attenuation required under this paragraph shall be 30 dB instead of 20 dB. Attenuation below the general limits specified in Section 15.209(a) is not required.

### 7.2 TEST PROCEDURE

- a. The EUT was directly connected to the spectrum analyzer and antenna output port as show in the block diagram below.
- b. Spectrum Setting : RBW= 100 kHz, VBW=300 kHz, Sweep time = 10 ms.

### 7.3 DEVIATION FROM STANDARD

No deviation.

### 7.4 TEST SETUP

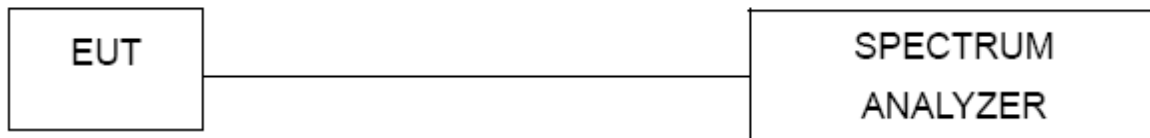

### 7.5 EUT OPERATION CONDITIONS

The EUT tested system was configured as the statements of 3.5 unless otherwise a special operating condition is specified in the follows during the testing.

### 7.6 TEST RESULTS

Please refer to the APPENDIX G.

**8. POWER SPECTRAL DENSITY TEST****8.1 LIMIT**

FCC Part15, Subpart C (15.247)		
Section	Test Item	Limit
15.247(e)	Power Spectral Density	8 dBm (in any 3 kHz)

**8.2 TEST PROCEDURE**

- a. The EUT was directly connected to the spectrum analyzer and antenna output port as show in the block diagram below.
- b. Spectrum Setting: RBW=3 kHz, VBW=10 kHz, Sweep time = auto.

**8.3 DEVIATION FROM STANDARD**

No deviation.

**8.4 TEST SETUP****8.5 EUT OPERATION CONDITIONS**

The EUT tested system was configured as the statements of 3.5 unless otherwise a special operating condition is specified in the follows during the testing.

**8.6 TEST RESULTS**

Please refer to the APPENDIX H.

**9. MEASUREMENT INSTRUMENTS LIST**

Radiated Emissions - 9 kHz to 30 MHz					
Item	Kind of Equipment	Manufacturer	Type No.	Serial No.	Calibrated until
1	Loop Antenna	EMCI	EMCI LPA600	275	Mar. 29, 2020
2	Cable	N/A	EMCRG400-BM-N M-10000	170628	Apr. 17, 2020
3	MXE EMI Receiver	Keysight	N9038A	MY57150106	Mar. 29, 2020
4	Measurement Software	Farad	EZ-EMC Ver.BTL-2ANT-1	N/A	N/A

Radiated Emissions - 30 MHz to 1 GHz					
Item	Kind of Equipment	Manufacturer	Type No.	Serial No.	Calibrated until
1	TRILOG Broadband Antenna	Schwarzbeck	VULB 9168	719	Mar. 29, 2020
2	Pre-Amplifier	emci	EMC9135	980400	Mar. 29, 2020
3	MXE EMI Receiver	Keysight	N9038A	MY57150106	Mar. 29, 2020
4	Test Cable	emci	EMC104-SM-SM-7 000	170330	Apr. 17, 2020
5	Test Cable	emci	EMC104-SM-SM-1 000	170331	Apr. 17, 2020
6	Test Cable	emci	EMC104-SM-NM-3 500	170621	Apr. 17, 2020
7	Measurement Software	Farad	EZ-EMC Ver.NB-03A1-01	N/A	N/A

Radiated Emissions - Above 1 GHz					
Item	Kind of Equipment	Manufacturer	Type No.	Serial No.	Calibrated until
1	Double-Ridged Waveguide Horn Antenna	ETS-Lindgren	9120D	00206960	Mar. 29, 2020
2	Pre-Amplifier	emci	EMC012645SE	980421	Mar. 29, 2020
3	EXA Spectrum Analyzer	Keysight	N9010A	MY56480545	Mar. 29, 2020
4	Test Cable	emci	EMC104-SM-SM-7 000	170330	Apr. 17, 2020
5	Test Cable	emci	EMC104-SM-SM-1 000	170331	Apr. 17, 2020
6	Test Cable	emci	EMC104-SM-NM-3 500	170621	Apr. 17, 2020
7	Measurement Software	Farad	EZ-EMC Ver.NB-03A1-01	N/A	N/A
8	MXE EMI Receiver	Keysight	N9038A	MY57150106	Mar. 29, 2020
9	Double-Ridged Waveguide Horn Antenna	ETS-Lindgren	3116C	00203919	Mar. 29, 2020
10	Pre-Amplifier	emci	EMC184045SE	980409	Mar. 29, 2020
11	EXA Spectrum Analyzer	Keysight	N9010A	MY56480579	Mar. 29, 2020
12	Test Cable	emci	EMC102-KM-KM-8 00	170654	Apr. 17, 2020
13	Test Cable	emci	Super Reliable-40G-SS11- 7000	W0030860001	Apr. 17, 2020
14	Measurement Software	Farad	EZ-EMC Ver.NB-03A1-01	N/A	N/A

Bandwidth					
Item	Kind of Equipment	Manufacturer	Type No.	Serial No.	Calibrated until
1	Spectrum Analyzer	R&S	FSP40	100626	Mar. 29, 2020

Maximum Output Power					
Item	Kind of Equipment	Manufacturer	Type No.	Serial No.	Calibrated until
1	Peak Power Analyzer	Keysight	8990B	MY51000507	Mar. 29, 2020
2	Wideband Power Sensor	Keysight	N9123A	MY58310003	Mar. 29, 2020

Antenna Conducted Spurious Emissions					
Item	Kind of Equipment	Manufacturer	Type No.	Serial No.	Calibrated until
1	Spectrum Analyzer	R&S	FSP40	100626	Mar. 29, 2020

Power Spectral Density					
Item	Kind of Equipment	Manufacturer	Type No.	Serial No.	Calibrated until
1	Spectrum Analyzer	R&S	FSP40	100626	Mar. 29, 2020

Remark: "N/A" denotes no model name, serial no. or calibration specified.

All calibration period of equipment list is one year.

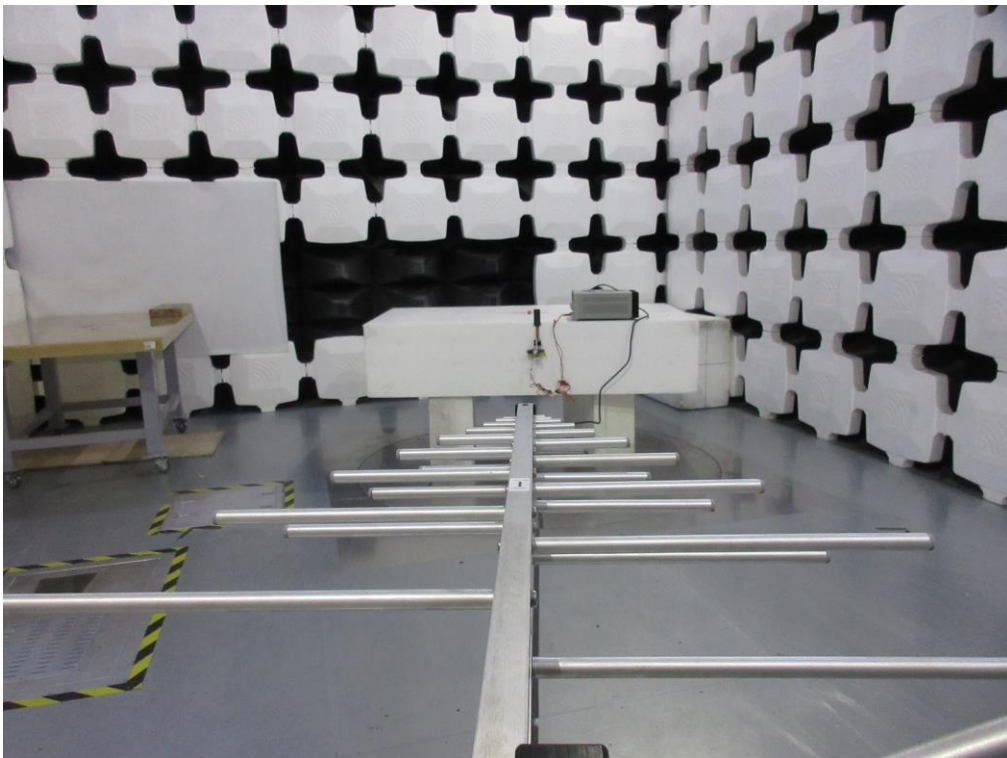

**10. EUT TEST PHOTO****Radiated Emissions Test Photos****30 MHz to 1000 MHz**

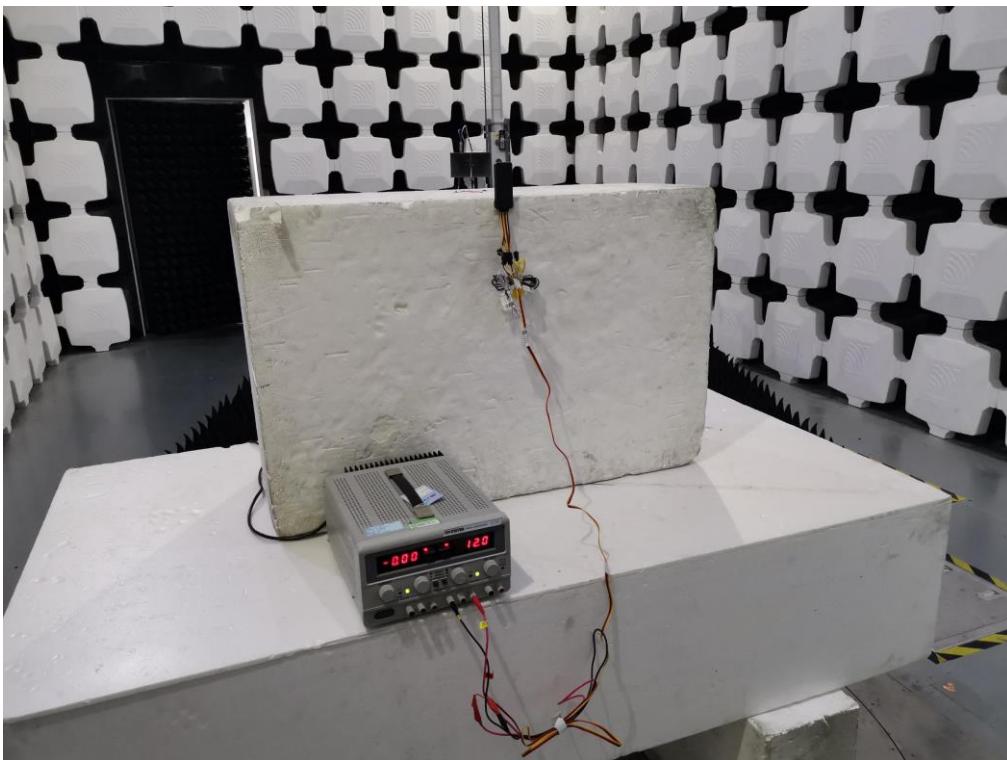
**Radiated Emissions Test Photos****Above 1 GHz**

## **APPENDIX A - AC POWER LINE CONDUCTED EMISSIONS**

Note: Not Applicable, The EUT is DC power supplied.

## **APPENDIX B - RADIATED EMISSION - 9 KHZ TO 30 MHZ**

Note: The measured value have enough margin over 20dB than the limit, therefore they are not reported.

## **APPENDIX C - RADIATED EMISSION - 30 MHZ TO 1000 MHZ**

Test Mode: TX 2480MHz\_CH39\_1Mbps

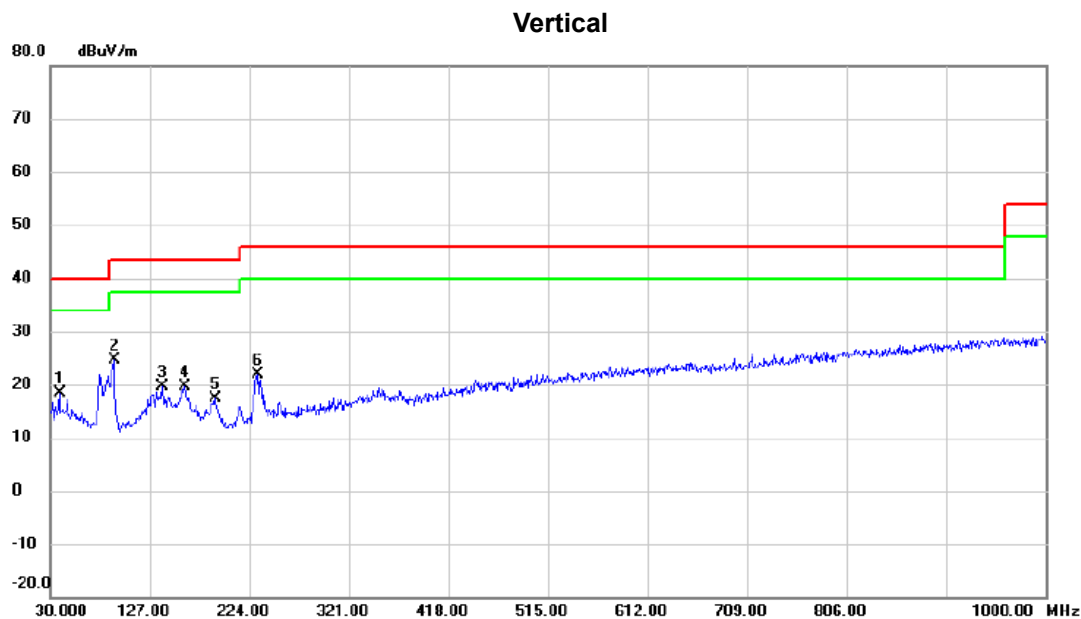

No.	Mk.	Freq. MHz	Reading Level dBuV	Correct Factor dB	Measure- ment dBuV/m	Limit dBuV/m	Margin dB	Detector	Comment
1		39.2150	35.07	-16.67	18.40	40.00	-21.60	peak	
2	*	92.0800	45.15	-20.54	24.61	43.50	-18.89	peak	
3		139.6100	35.91	-16.32	19.59	43.50	-23.91	peak	
4		160.9500	35.40	-15.87	19.53	43.50	-23.97	peak	
5		190.5350	36.66	-19.33	17.33	43.50	-26.17	peak	
6		231.7600	40.04	-18.22	21.82	46.00	-24.18	peak	

**REMARKS:**

- (1) Measurement Value = Reading Level + Correct Factor.
- (2) Margin Level = Measurement Value - Limit Value.

Test Mode: TX 2480MHz\_CH39\_1Mbps

### Horizontal

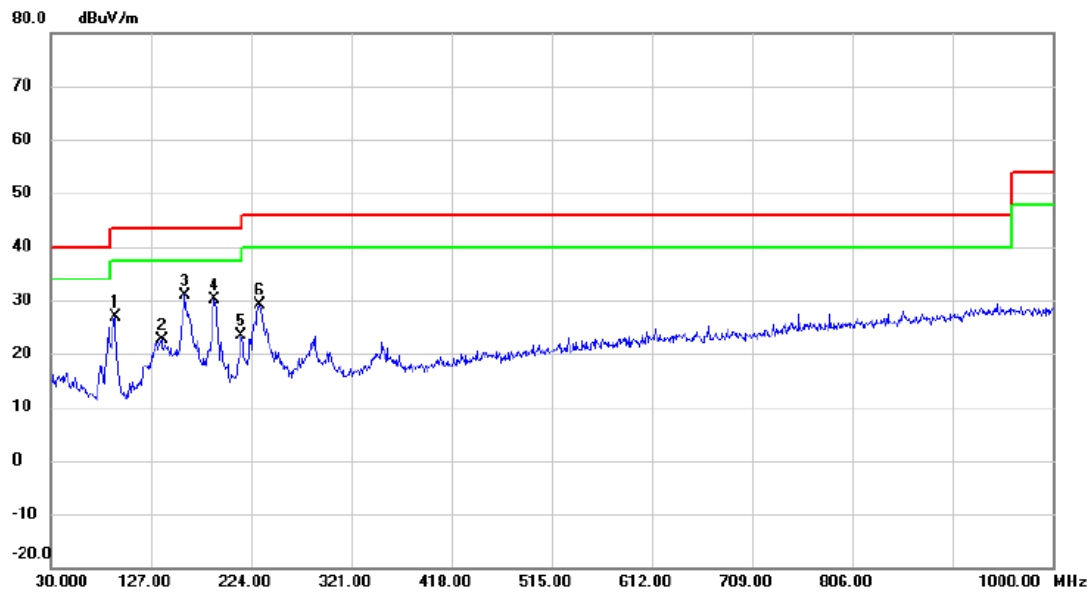

No.	Mk.	Freq. MHz	Reading Level dBuV	Correct Factor dB	Measure- ment dBuV/m	Limit dBuV/m	Margin dB	Detector	Comment
1		92.0800	47.47	-20.54	26.93	43.50	-16.57	peak	
2		137.6700	39.20	-16.51	22.69	43.50	-20.81	peak	
3	*	159.9800	46.81	-15.81	31.00	43.50	-12.50	peak	
4		188.5950	49.24	-19.18	30.06	43.50	-13.44	peak	
5		214.7850	42.50	-19.24	23.26	43.50	-20.24	peak	
6		231.7600	47.40	-18.22	29.18	46.00	-16.82	peak	

**REMARKS:**

- (1) Measurement Value = Reading Level + Correct Factor.
- (2) Margin Level = Measurement Value - Limit Value.

Test Mode: BT Continue Transmition (1M 2402MHz ) with GSM 850 CH128 link

### Vertical

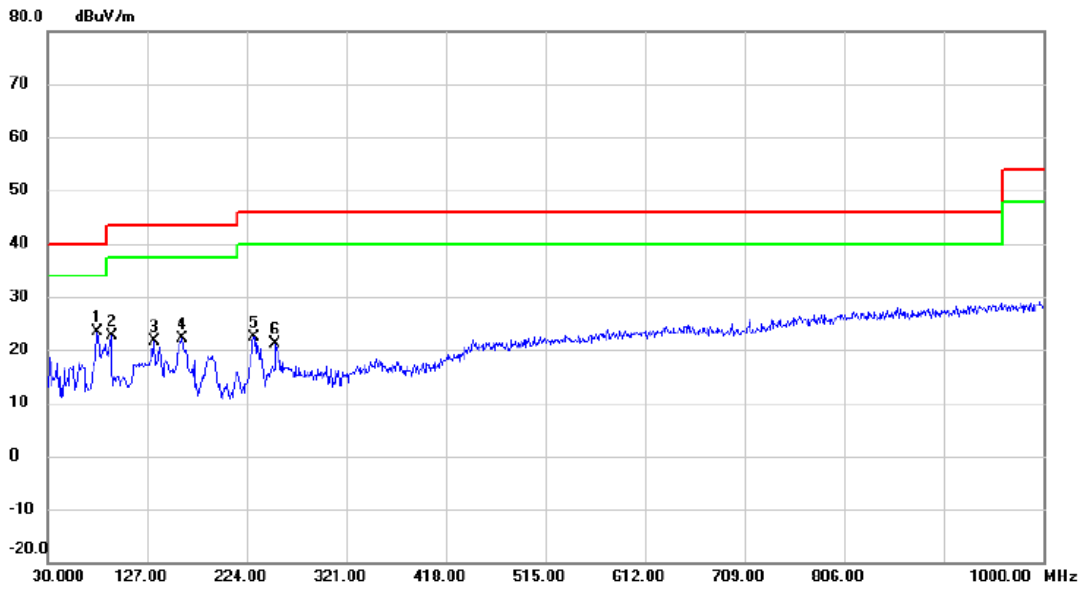

No.	Mk.	Freq. MHz	Reading Level dBuV	Correct Factor dB	Measure- ment dBuV/m	Limit dBuV/m	Margin dB	Detector	Comment
1	*	78.5000	44.25	-20.86	23.39	40.00	-16.61	peak	
2		92.0800	43.15	-20.54	22.61	43.50	-20.89	peak	
3		134.2750	38.55	-16.82	21.73	43.50	-21.77	peak	
4		160.9500	37.90	-15.87	22.03	43.50	-21.47	peak	
5		231.2750	40.63	-18.26	22.37	46.00	-23.63	peak	
6		252.1300	38.46	-17.44	21.02	46.00	-24.98	peak	

**REMARKS:**

- (1) Measurement Value = Reading Level + Correct Factor.
- (2) Margin Level = Measurement Value - Limit Value.



Test Mode: BT Continue Transmition (1M 2402MHz ) with GSM 850 CH128 link

### Horizontal

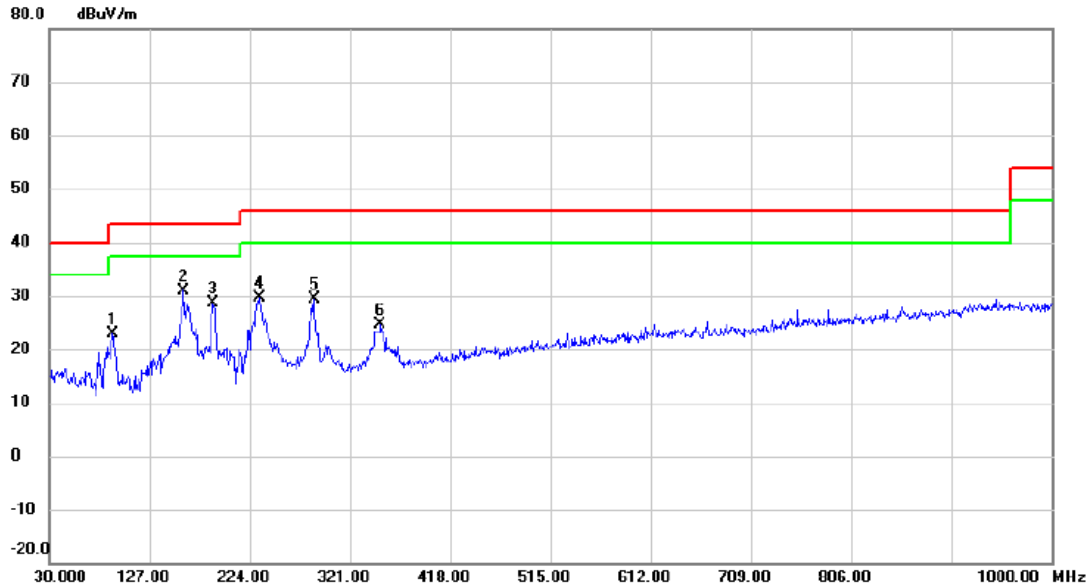

No.	Mk.	Freq. MHz	Reading Level dBuV	Correct Factor dB	Measure- ment dBuV/m	Limit dBuV/m	Margin dB	Detector	Comment
1		91.5950	43.35	-20.57	22.78	43.50	-20.72	peak	
2	*	159.9800	46.81	-15.81	31.00	43.50	-12.50	peak	
3		188.5950	47.74	-19.18	28.56	43.50	-14.94	peak	
4		234.1850	47.58	-18.06	29.52	46.00	-16.48	peak	
5		286.0800	46.00	-16.73	29.27	46.00	-16.73	peak	
6		350.5850	38.46	-13.84	24.62	46.00	-21.38	peak	

REMARKS:  
 (1) Measurement Value = Reading Level + Correct Factor.  
 (2) Margin Level = Measurement Value - Limit Value.

**APPENDIX D - RADIATED EMISSION - ABOVE 1000 MHZ**

Test Mode : TX 2402 MHz \_CH00\_1Mbps

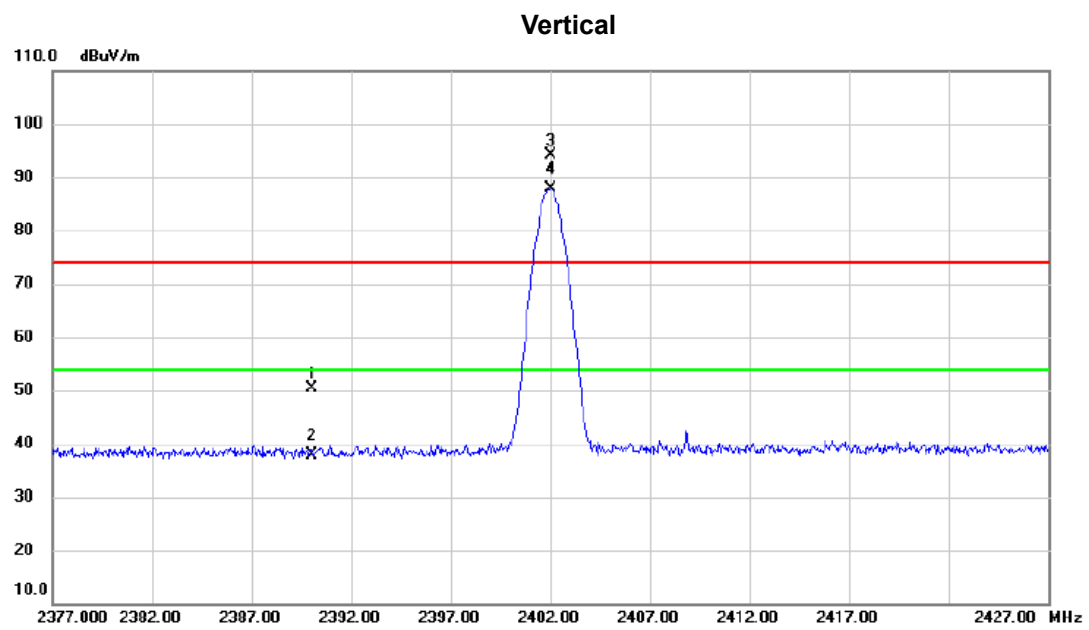

No.	Mk.	Freq. MHz	Reading Level dBuV	Correct Factor dB	Measure- ment dBuV/m	Limit dBuV/m	Margin dB	Detector	Comment
1		2390.000	17.02	33.24	50.26	74.00	-23.74	peak	
2		2390.000	4.63	33.24	37.87	54.00	-16.13	AVG	
3	X	2402.000	60.84	33.28	94.12	74.00	20.12	peak	No limit
4	*	2402.000	54.50	33.28	87.78	54.00	33.78	AVG	No limit

REMARKS:  
 (1) Measurement Value = Reading Level + Correct Factor.  
 (2) Margin Level = Measurement Value - Limit Value.

Test Mode : TX 2402 MHz \_CH00\_1Mbps

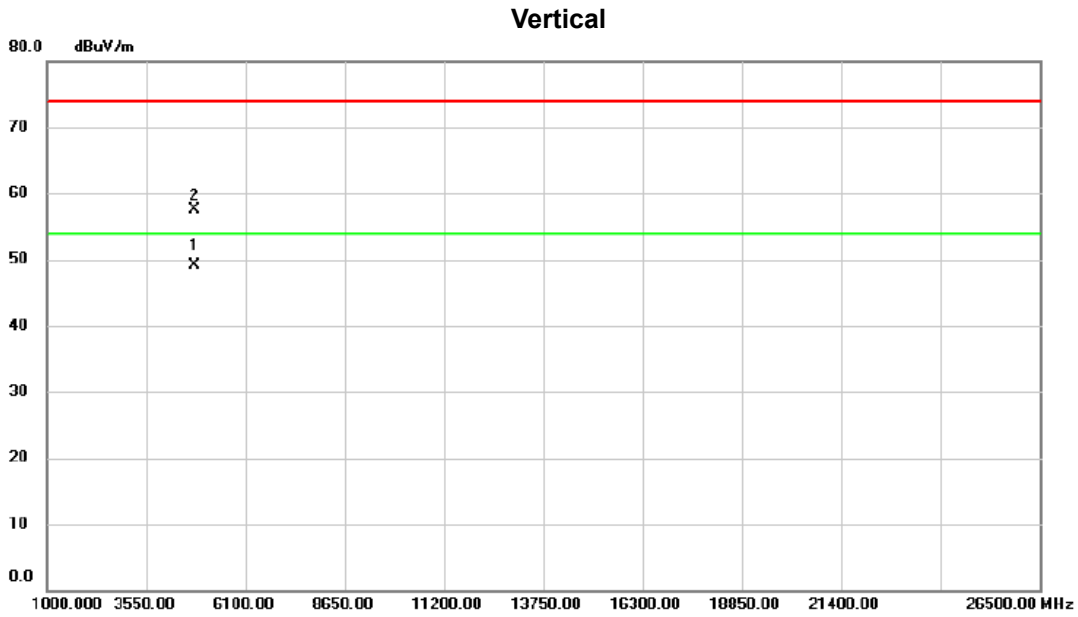

No.	Mk.	Freq. MHz	Reading Level dBuV	Correct Factor dB	Measure- ment dBuV/m	Limit dBuV/m	Margin dB	Detector	Comment
1	*	4804.000	58.24	-9.07	49.17	54.00	-4.83	AVG	
2		4804.010	66.53	-9.07	57.46	74.00	-16.54	peak	

REMARKS:

- (1) Measurement Value = Reading Level + Correct Factor.
- (2) Margin Level = Measurement Value - Limit Value.

Test Mode : TX 2402 MHz \_CH00\_1Mbps

### Horizontal

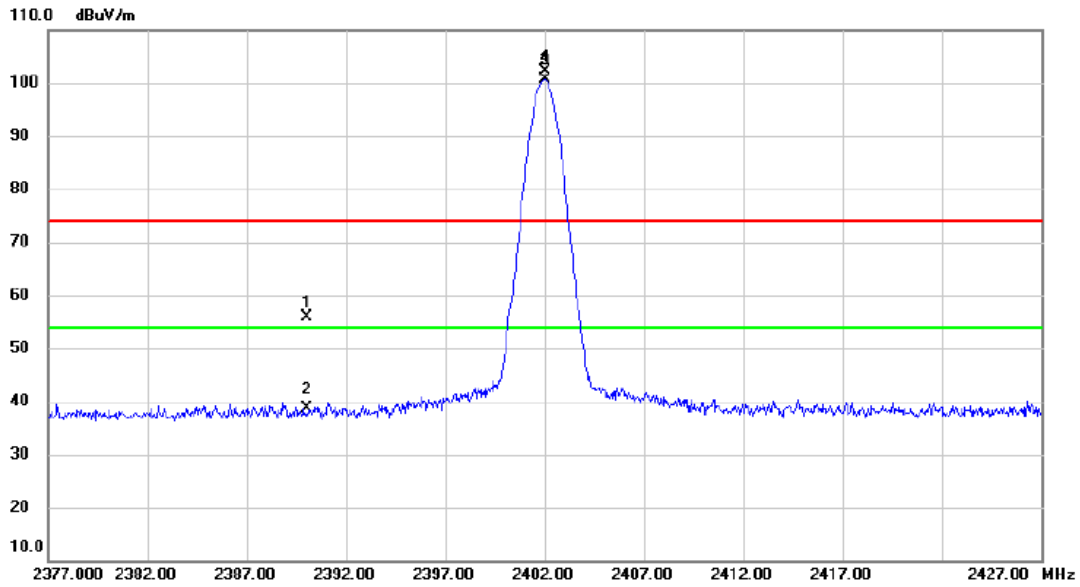

No.	Mk.	Freq. MHz	Reading Level dBuV	Correct Factor dB	Measure- ment dBuV/m	Limit dBuV/m	Margin dB	Detector	Comment
1		2390.000	22.67	33.24	55.91	74.00	-18.09	peak	
2		2390.000	5.47	33.24	38.71	54.00	-15.29	AVG	
3	*	2402.000	67.34	33.28	100.62	54.00	46.62	AVG	No limit
4	X	2402.050	68.97	33.28	102.25	74.00	28.25	peak	No limit

**REMARKS:**

(1) Measurement Value = Reading Level + Correct Factor.

(2) Margin Level = Measurement Value - Limit Value.

Test Mode : TX 2402 MHz \_CH00\_1Mbps

### Horizontal

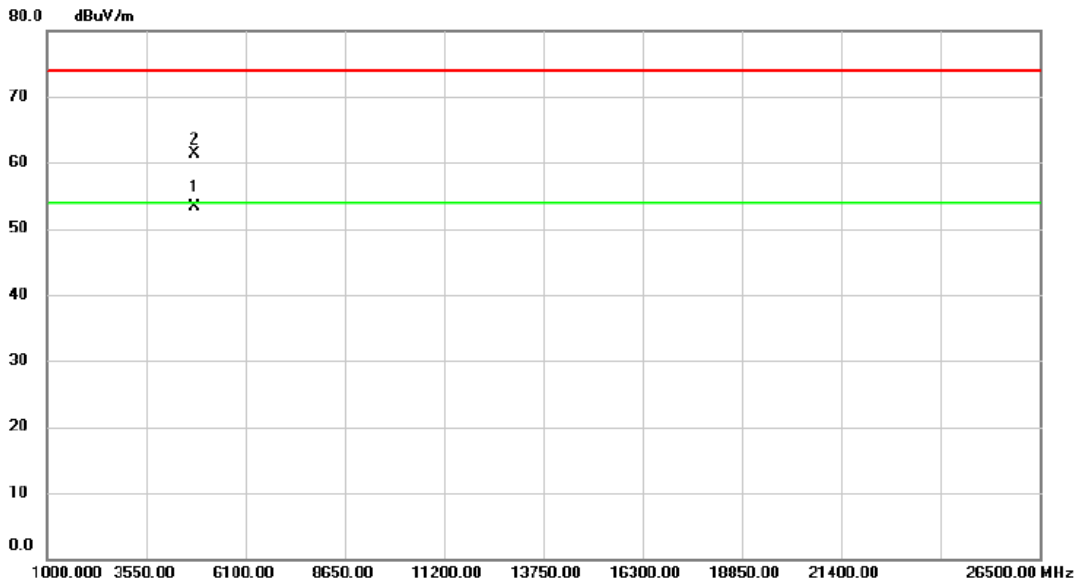

No.	Mk.	Freq.	Reading Level	Correct Factor	Measurement	Limit	Margin	Detector	Comment
		MHz	dBuV	dB	dBuV/m	dBuV/m	dB		
1	*	4804.010	62.46	-9.07	53.39	54.00	-0.61	AVG	
2		4804.050	70.44	-9.07	61.37	74.00	-12.63	peak	

**REMARKS:**

- (1) Measurement Value = Reading Level + Correct Factor.
- (2) Margin Level = Measurement Value - Limit Value.

Test Mode : TX 2440 MHz \_CH19\_ 1Mbps

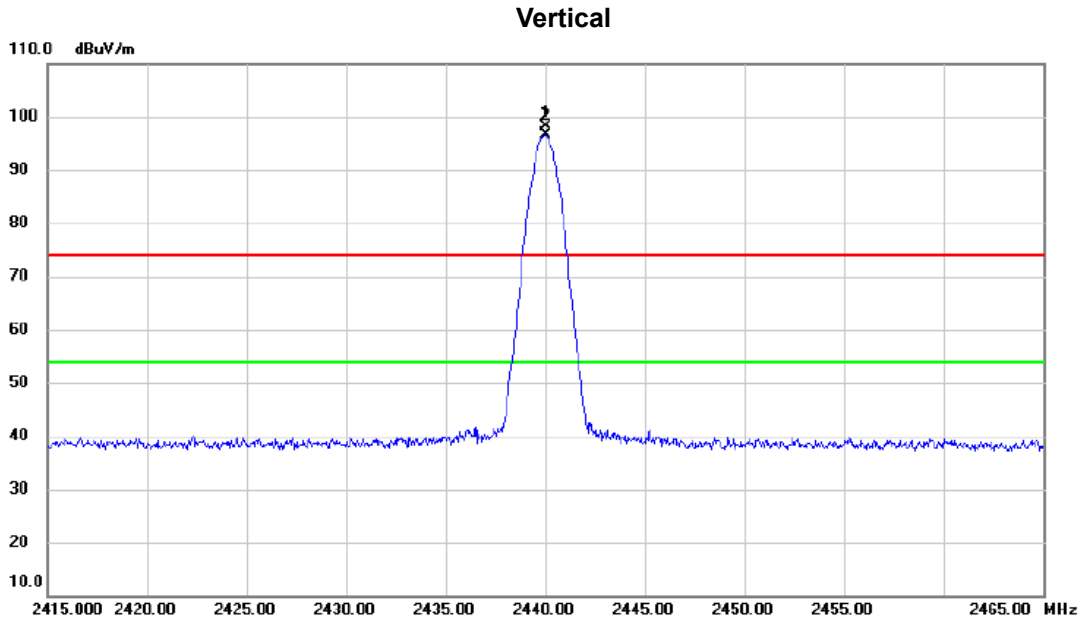

No.	Mk.	Freq. MHz	Reading Level dBuV	Correct Factor dB	Measure- ment dBuV/m	Limit dBuV/m	Margin dB	Detector	Comment
1	X	2440.000	64.84	33.39	98.23	74.00	24.23	peak	No limit
2	*	2440.000	63.21	33.39	96.60	54.00	42.60	AVG	No limit

**REMARKS:**

- (1) Measurement Value = Reading Level + Correct Factor.
- (2) Margin Level = Measurement Value - Limit Value.

Test Mode : TX 2440 MHz \_CH19\_1Mbps

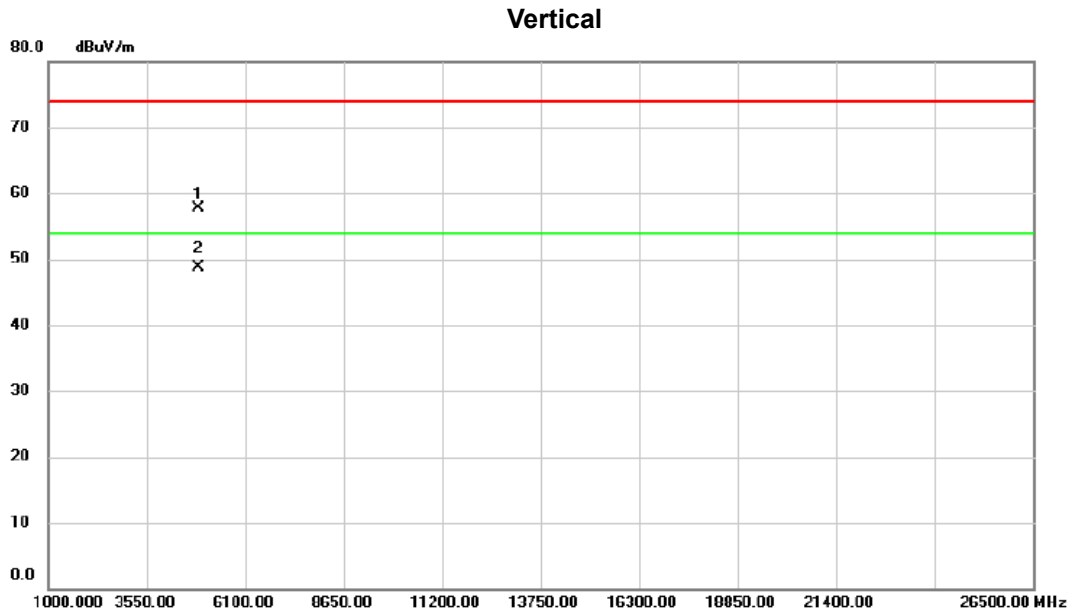

No. Mk.	Freq. MHz	Reading Level dBuV	Correct Factor dB	Measure- ment dBuV/m	Limit dBuV/m	Margin dB	Detector	Comment
1	4879.990	66.55	-8.78	57.77	74.00	-16.23	peak	
2 *	4880.035	57.45	-8.78	48.67	54.00	-5.33	AVG	

**REMARKS:**

- (1) Measurement Value = Reading Level + Correct Factor.
- (2) Margin Level = Measurement Value - Limit Value.



Test Mode : TX 2440 MHz \_CH19\_1Mbps

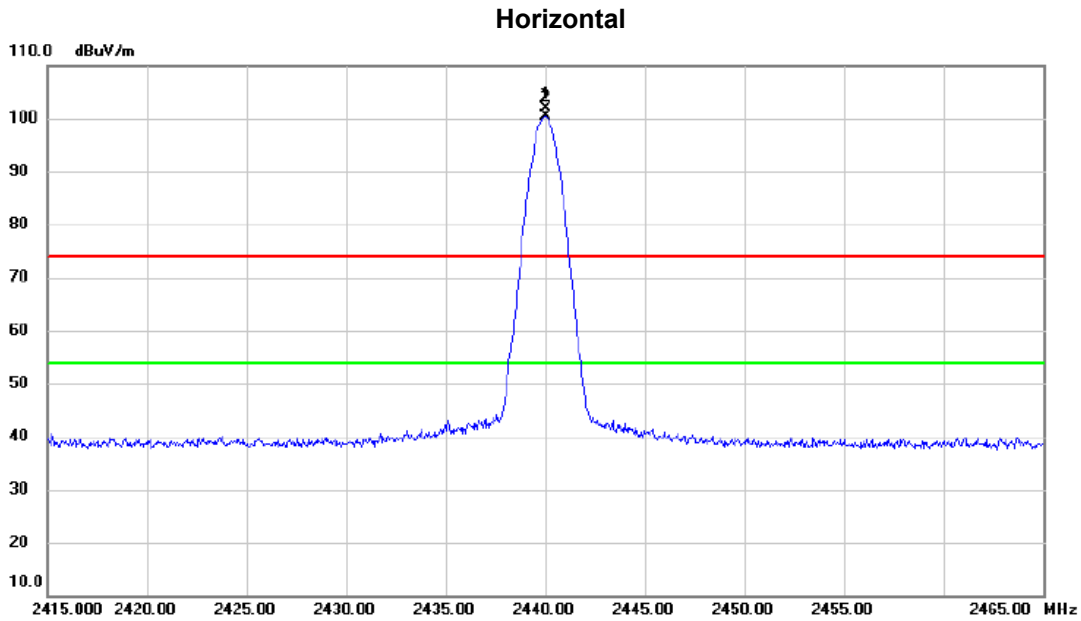

No.	Mk.	Freq. MHz	Reading Level dBuV	Correct Factor dB	Measure- ment dBuV/m	Limit dBuV/m	Margin dB	Detector	Comment
1	X	2440.000	68.56	33.39	101.95	74.00	27.95	peak	No limit
2	*	2440.000	66.92	33.39	100.31	54.00	46.31	AVG	No limit

**REMARKS:**

- (1) Measurement Value = Reading Level + Correct Factor.
- (2) Margin Level = Measurement Value - Limit Value.

Test Mode : TX 2440 MHz \_CH19\_ 1Mbps

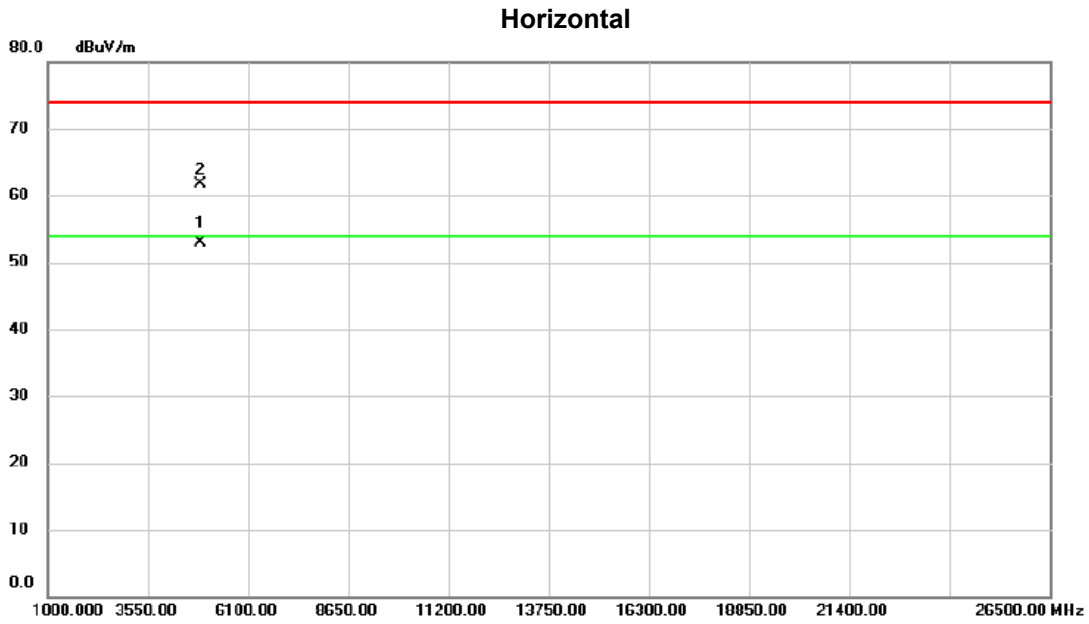

No.	Mk.	Freq. MHz	Reading Level dBuV	Correct Factor dB	Measure- ment dBuV/m	Limit dBuV/m	Margin dB	Detector	Comment
1	*	4879.700	61.62	-8.78	52.84	54.00	-1.16	AVG	
2		4880.035	70.58	-8.78	61.80	74.00	-12.20	peak	

REMARKS:

- (1) Measurement Value = Reading Level + Correct Factor.
- (2) Margin Level = Measurement Value - Limit Value.

Test Mode : TX 2480 MHz \_CH39\_1Mbps

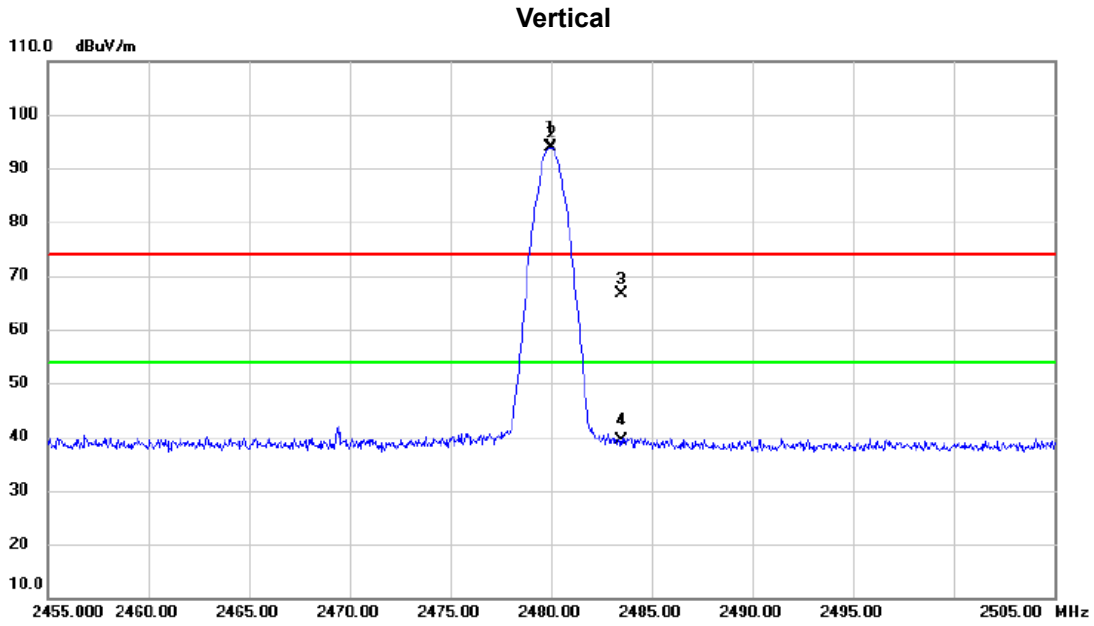

No.	Mk.	Freq. MHz	Reading Level dBuV	Correct Factor dB	Measure- ment dBuV/m	Limit dBuV/m	Margin dB	Detector	Comment
1	*	2479.950	60.41	33.51	93.92	54.00	39.92	AVG	No limit
2	X	2480.000	60.42	33.51	93.93	74.00	19.93	peak	No limit
3		2483.500	33.12	33.51	66.63	74.00	-7.37	peak	
4		2483.500	5.94	33.51	39.45	54.00	-14.55	AVG	

**REMARKS:**

- (1) Measurement Value = Reading Level + Correct Factor.
- (2) Margin Level = Measurement Value - Limit Value.

Test Mode : TX 2480 MHz \_CH39\_1Mbps

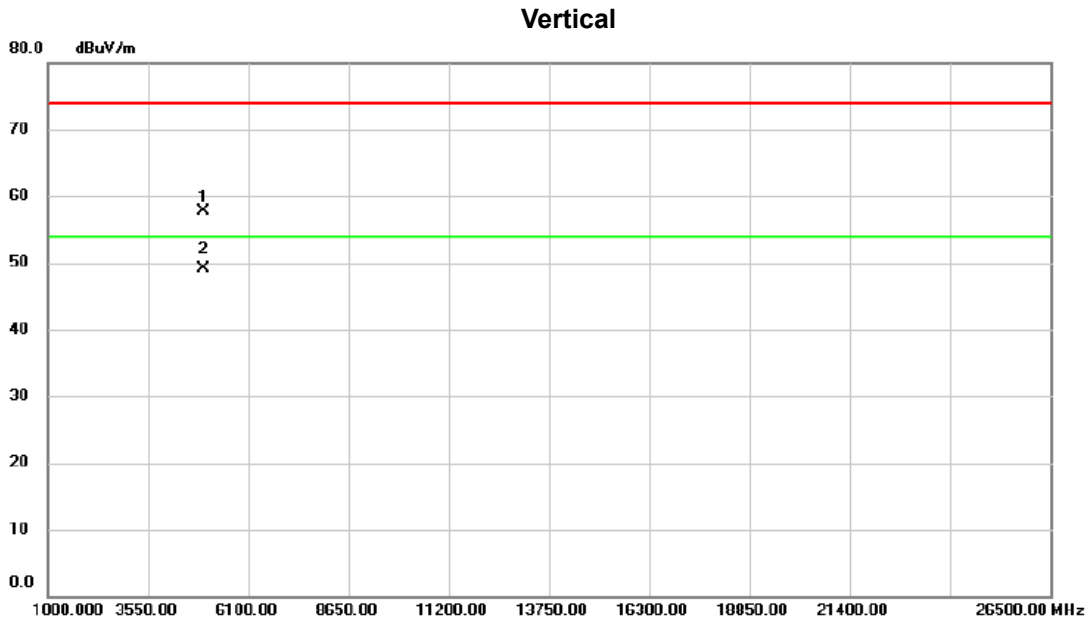

No.	Mk.	Freq. MHz	Reading Level dBuV	Correct Factor dB	Measure- ment dBuV/m	Limit dBuV/m	Margin dB	Detector	Comment
1		4959.880	66.21	-8.47	57.74	74.00	-16.26	peak	
2	*	4960.505	57.48	-8.46	49.02	54.00	-4.98	AVG	

**REMARKS:**

- (1) Measurement Value = Reading Level + Correct Factor.
- (2) Margin Level = Measurement Value - Limit Value.

Test Mode : TX 2480 MHz \_CH39\_1Mbps

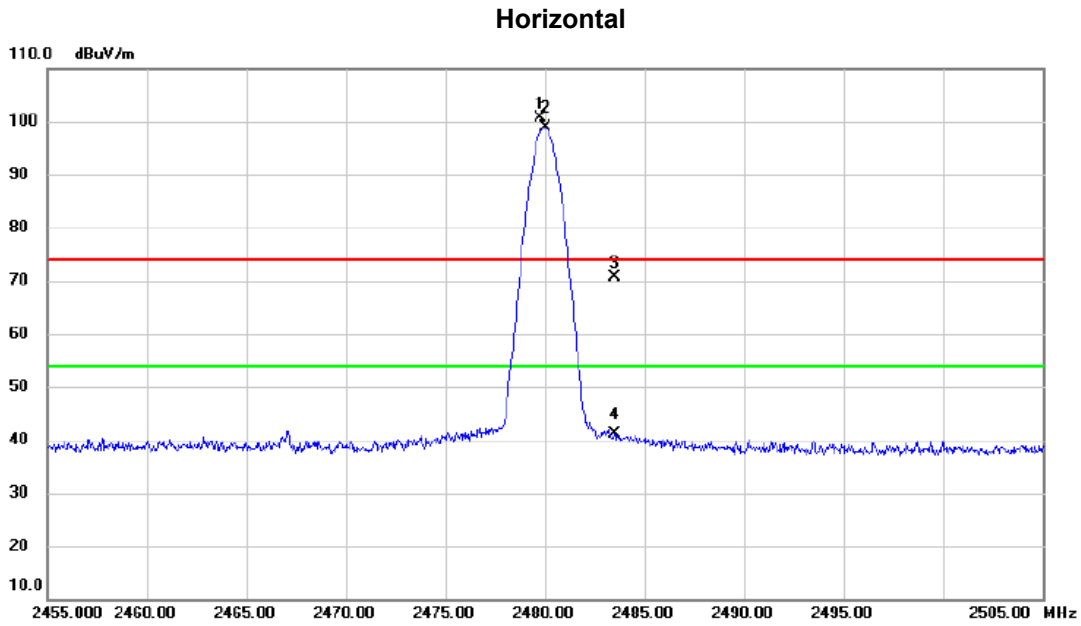

No.	Mk.	Freq. MHz	Reading Level dBuV	Correct Factor dB	Measure- ment dBuV/m	Limit dBuV/m	Margin dB	Detector	Comment
1	X	2479.750	67.08	33.50	100.58	74.00	26.58	peak	No limit
2	*	2480.000	65.42	33.51	98.93	54.00	44.93	AVG	No limit
3		2483.500	37.09	33.51	70.60	74.00	-3.40	peak	
4		2483.500	7.58	33.51	41.09	54.00	-12.91	AVG	

**REMARKS:**

- (1) Measurement Value = Reading Level + Correct Factor.
- (2) Margin Level = Measurement Value - Limit Value.

Test Mode : TX 2480 MHz \_CH39\_1Mbps

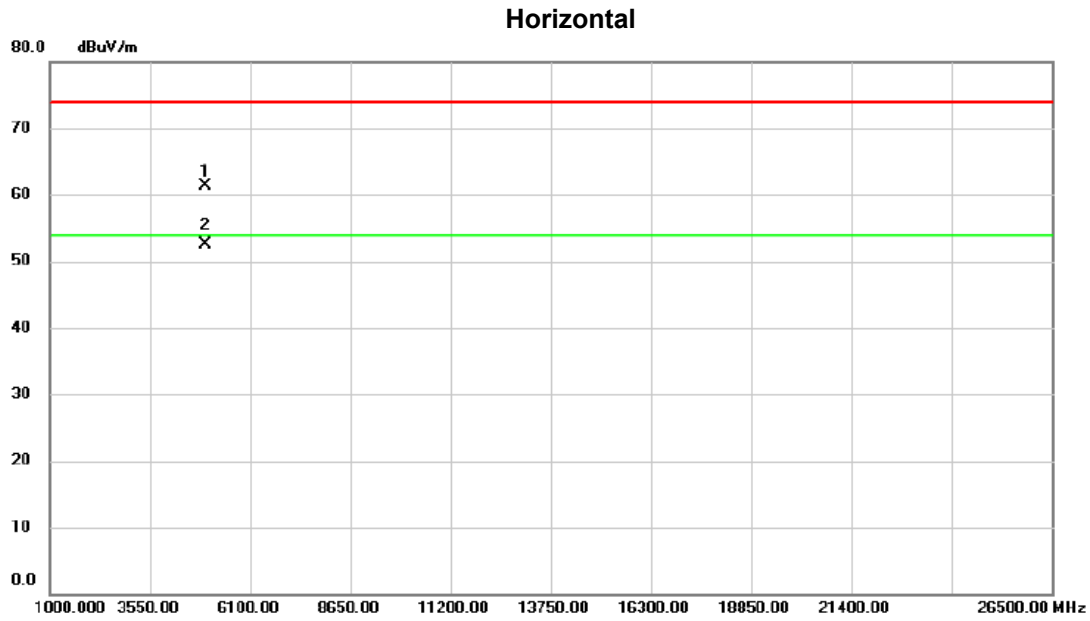

No.	Mk.	Freq. MHz	Reading Level dBuV	Correct Factor dB	Measure- ment dBuV/m	Limit dBuV/m	Margin dB	Detector	Comment
1		4960.010	69.72	-8.47	61.25	74.00	-12.75	peak	
2	*	4960.505	61.03	-8.46	52.57	54.00	-1.43	AVG	

**REMARKS:**

- (1) Measurement Value = Reading Level + Correct Factor.
- (2) Margin Level = Measurement Value - Limit Value.

Test Mode: BT Continue Transmition (1M 2402MHz ) with GSM 850 CH128 link

### Vertical

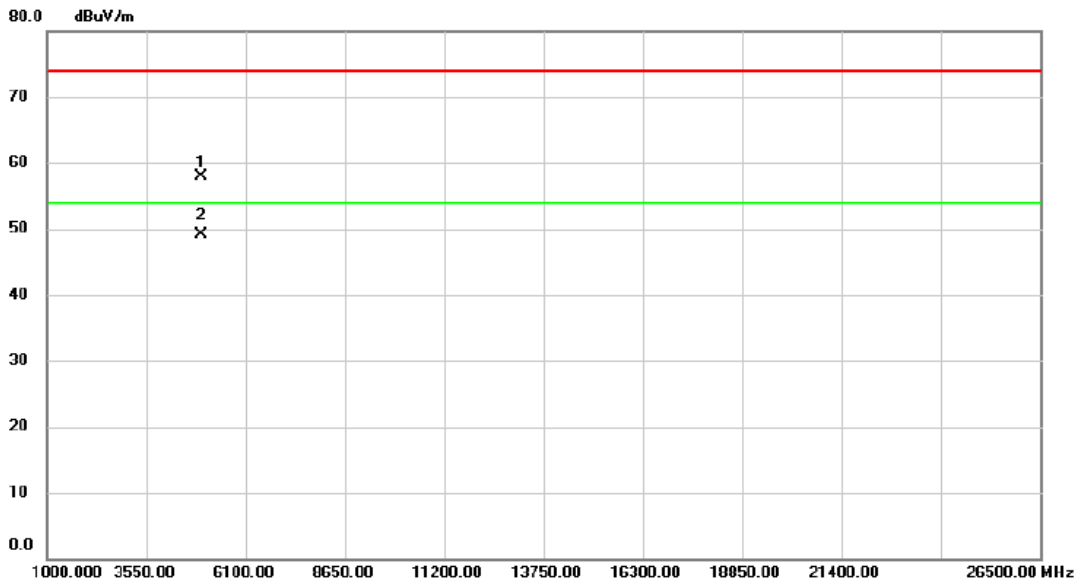

No.	Mk.	Freq. MHz	Reading Level dBuV	Correct Factor dB	Measure- ment dBuV/m	Limit dBuV/m	Margin dB	Detector	Comment
1		4960.380	66.38	-8.46	57.92	74.00	-16.08	peak	
2	*	4960.505	57.66	-8.46	49.20	54.00	-4.80	AVG	

**REMARKS:**

- (1) Measurement Value = Reading Level + Correct Factor.
- (2) Margin Level = Measurement Value - Limit Value.

Test Mode: BT Continue Transmission (1M 2402MHz ) with GSM 850 CH128 link

### Horizontal

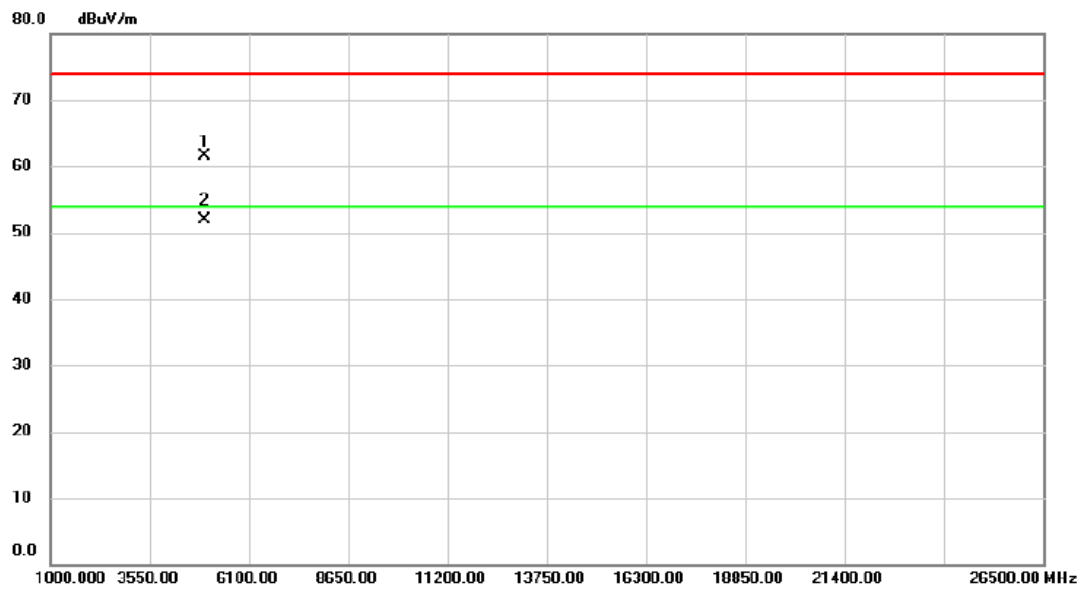

No.	Mk.	Freq. MHz	Reading Level dBuV	Correct Factor dB	Measure- ment dBuV/m	Limit dBuV/m	Margin dB	Detector	Comment
1		4960.230	69.90	-8.46	61.44	74.00	-12.56	peak	
2	*	4960.505	60.42	-8.46	51.96	54.00	-2.04	AVG	

REMARKS:  
 (1) Measurement Value = Reading Level + Correct Factor.  
 (2) Margin Level = Measurement Value - Limit Value.



## APPENDIX E - BANDWIDTH

Test Mode: CH00, CH19 , CH39 - 1Mbps

Channel	Frequency (MHz)	6 dB Bandwidth (MHz)	6 dB Bandwidth Min. Limit (kHz)	Test Result
00	2402	0.708	500	Pass
19	2440	0.708	500	Pass
39	2480	0.728	500	Pass

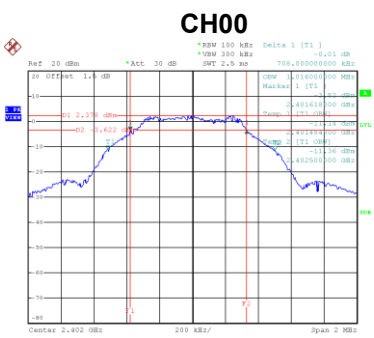

Date: 22\_JUL\_2019 21:47:13

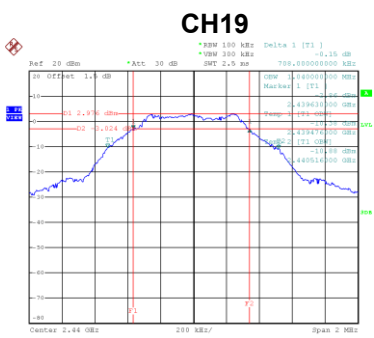

Date: 22\_JUL\_2019 21:51:51

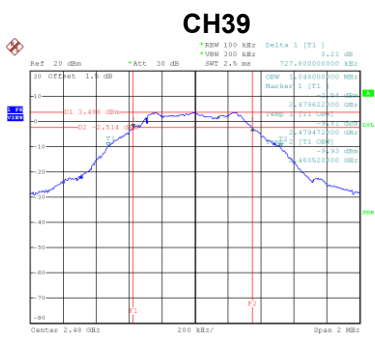

Date: 22\_JUL\_2019 21:53:46

## **APPENDIX F - MAXIMUM OUTPUT POWER**

Test Mode :	CH00, CH19 , CH39 - 1Mbps
-------------	---------------------------

Frequency (MHz)	Output Power (dBm)	Output Power (W)	Max. Limit (dBm)	Max. Limit (W)	Test Result
2402	3.46	0.0022	30.00	1.00	Pass
2440	3.98	0.0025	30.00	1.00	Pass
2480	4.84	0.0030	30.00	1.00	Pass

## **APPENDIX G - CONDUCTED SPURIOUS EMISSION**

Test Mode : CH00, CH19 , CH39 - 1Mbps

### Bandedge CH00 (Lower)

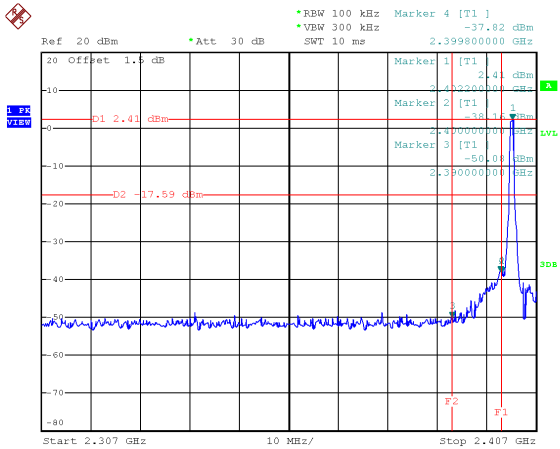

### Bandedge CH39 (Upper)

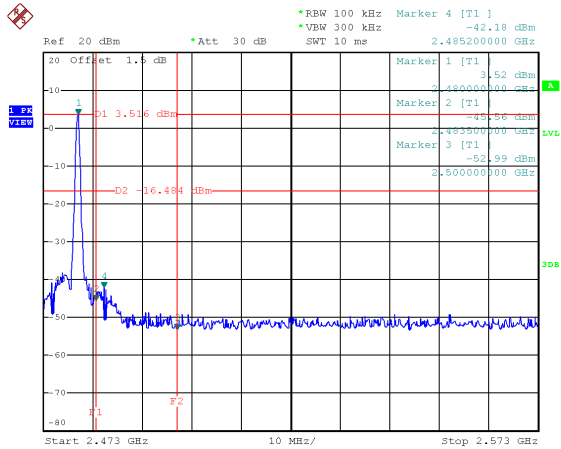

Date: 22.JUL.2019 21:50:15

Date: 22.JUL.2019 21:53:53

### CH00 – 10th Harmonic of the fundamental frequency

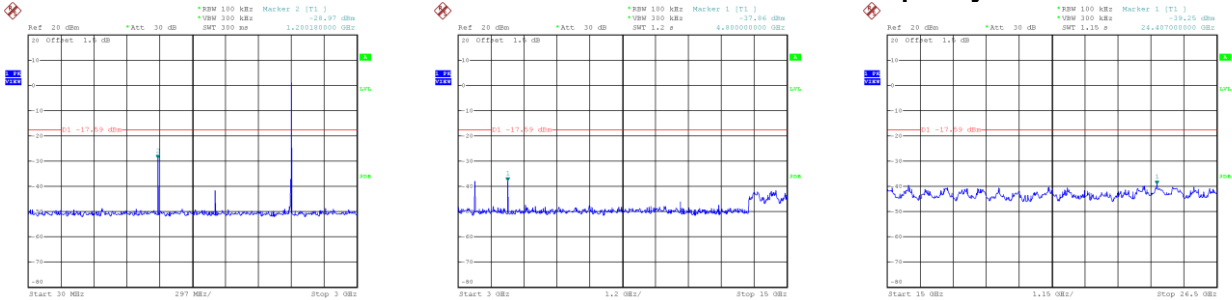

Date: 22.JUL.2019 21:50:28

Date: 22.JUL.2019 21:50:35

Date: 22.JUL.2019 21:50:42

### CH19 – 10th Harmonic of the fundamental frequency

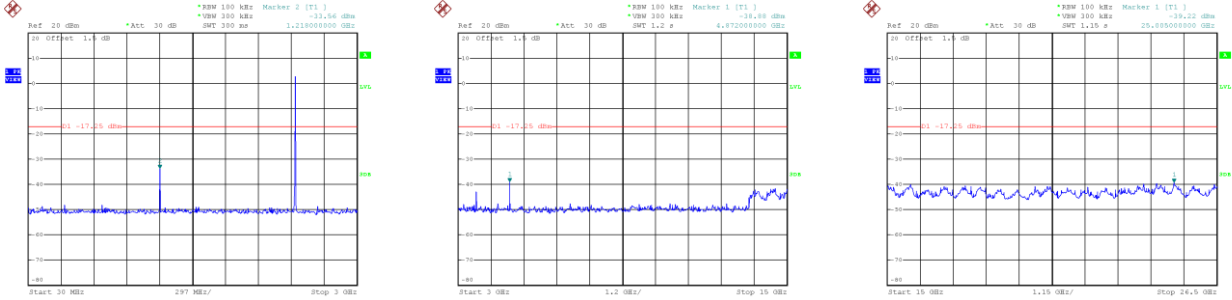

Date: 22.JUL.2019 21:52:12

Date: 22.JUL.2019 21:52:19

Date: 22.JUL.2019 21:52:26

### CH39 – 10th Harmonic of the fundamental frequency

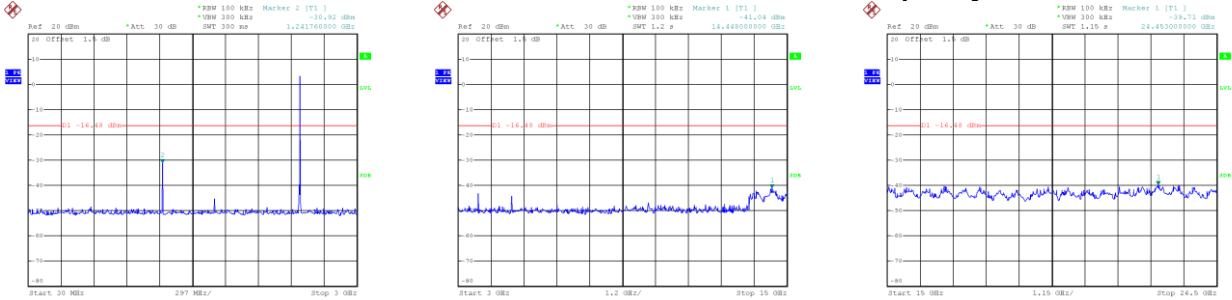

Date: 22.JUL.2019 21:54:06

Date: 22.JUL.2019 21:54:13

Date: 22.JUL.2019 21:54:20

## APPENDIX H - POWER SPECTRAL DENSITY

Test Mode: CH00, CH19 , CH39 - 1Mbps

Channel	Frequency (MHz)	Power Spectral Density (dBm/3 kHz)	Max. Limit (dBm/3 kHz)	Test Result
00	2402	-12.40	8.00	Pass
19	2440	-11.58	8.00	Pass
39	2480	-10.95	8.00	Pass

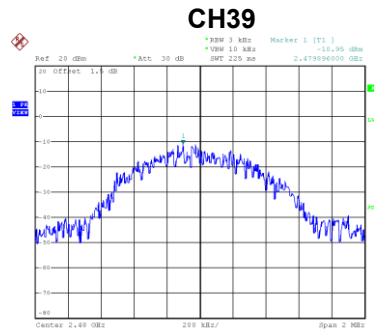
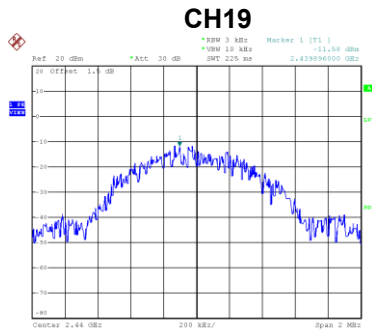
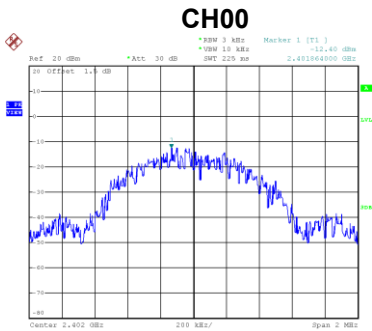

End of Test Report