



# TEST REPORT

For Bluetooth-EDR

Report No. .... : **CHTEW22060007** Report Verification:   
 Project No..... : **SHT2205032403EW**  
 FCC ID..... : **2ASWWCORNP60**  
 Applicant's name..... : **XINCHUANGXIN INTERNATIONAL CO.,LTD**  
 Address..... : **ROOM 605 6/F, FA YUEN COMMERCIAL BUILDING, 75-77 FA YUEN STREET MONGKOK KL**  
 Product Name ..... : **Smart Phone**  
 Trade Mark ..... : **CORN**  
 Model No. .... : **P60**  
 Listed Model(s) ..... : **-**  
 Standard ..... : **FCC CFR Title 47 Part 15 Subpart C Section 15.247**  
 Date of receipt of test sample..... : **May.20, 2022**  
 Date of testing..... : **May.21, 2022-Jun.01, 2022**  
 Date of issue..... : **Jun.02, 2022**  
 Result..... : **PASS**

Compiled by  
 ( position+printedname+signature).... : File administrators Fanghui Zhu

*Fanghui Zhu*

Supervised by  
 (position+printedname+signature).... : Project Engineer Cheng Xiao

*Cheng Xiao*

Approved by  
 (Position+Printed name+Signature): RF Manager Hans Hu

*Hans Hu*

**Testing Laboratory Name ..... : Shenzhen Huatongwei International Inspection Co., Ltd.**

Address..... : **1/F, Bldg 3, Hongfa Hi-tech Industrial Park, Genuyu Road, Tianliao, Gongming, Shenzhen, China**

**Shenzhen Huatongwei International Inspection Co., Ltd. All rights reserved.**

This publication may be reproduced in whole or in part for non-commercial purposes as long as the Shenzhen Huatongwei International Inspection Co., Ltd. is acknowledged as copyright owner and source of the material. Shenzhen Huatongwei International Inspection Co., Ltd. takes no responsibility for and will not assume liability for damages resulting from the reader's interpretation of the reproduced material due to its placement and context.

The test report merely correspond to the test sample.

## Contents

<b>1.</b>	<b>TEST STANDARDS AND REPORT VERSION</b>	<b>3</b>
1.1.	Test Standards	3
1.2.	Report version	3
<b>2.</b>	<b>TEST DESCRIPTION</b>	<b>4</b>
<b>3.</b>	<b>SUMMARY</b>	<b>5</b>
3.1.	Client Information	5
3.2.	Product Description	5
3.3.	Radio Specification Description	5
3.4.	Testing Laboratory Information	6
<b>4.</b>	<b>TEST CONFIGURATION</b>	<b>7</b>
4.1.	Test frequency list	7
4.2.	Descriptions of Test mode	7
4.3.	Test mode	7
4.4.	Test sample information	8
4.5.	Support unit used in test configuration and system	8
4.6.	Testing environmental condition	8
4.7.	Statement of the measurement uncertainty	8
4.8.	Equipment Used during the Test	9
<b>5.</b>	<b>TEST CONDITIONS AND RESULTS</b>	<b>11</b>
5.1.	Antenna Requirement	11
5.2.	AC Conducted Emission	12
5.3.	Peak Output Power	15
5.4.	20 dB Bandwidth	16
5.5.	99% Occupied Bandwidth	17
5.6.	Carrier Frequencies Separation	18
5.7.	Hopping Channel Number	19
5.8.	Dwell Time	20
5.9.	Duty Cycle Correction Factor (DCCF)	21
5.10.	Pseudorandom Frequency Hopping Sequence	22
5.11.	Conducted Band edge and Spurious Emission	23
5.12.	Radiated Band edge Emission	25
5.13.	Radiated Spurious Emission	27
<b>6.</b>	<b>TEST SETUP PHOTOS</b>	<b>33</b>
<b>7.</b>	<b>EXTERNAL AND INTERNAL PHOTOS</b>	<b>34</b>
<b>8.</b>	<b>APPENDIX REPORT</b>	<b>34</b>

# 1. TEST STANDARDS AND REPORT VERSION

## 1.1. Test Standards

The tests were performed according to following standards:

- [FCC Rules Part 15.247](#): Frequency Hopping, Direct Spread Spectrum and Hybrid Systems that are in operation within the bands of 902-928 MHz, 2400-2483.5 MHz, and 5725-5850 MHz
- [ANSI C63.10:2013](#): American National Standard for Testing Unlicensed Wireless Devices
- [KDB 558074 D01 15.247 Meas Guidance v05r02](#): Guidance for Compliance Measurements on Digital Transmission System, Frequency Hopping Spread Spectrum System, and Hybrid System Devices Operating under Section 15.247 of The FCC Rules

## 1.2. Report version

Revision No.	Date of issue	Description
N/A	2022-06-02	Original

## 2. TEST DESCRIPTION

Report clause	Test Items	Standard Requirement	Result	Test Engineer
5.1	Antenna Requirement	15.203/15.247 (c)	PASS	Xiaoqin Li
5.2	AC Conducted Emission	15.207	PASS	Junman Wang
5.3	Peak Output Power	15.247 (b)(1)	PASS	Xiaoqin Li
5.4	20 dB Bandwidth	15.247 (a)(1)	PASS	Xiaoqin Li
5.5	99% Occupied Bandwidth	-	PASS <sup>*1</sup>	Xiaoqin Li
5.6	Carrier Frequency Separation	15.247 (a)(1)	PASS	Xiaoqin Li
5.7	Hopping Channel Number	15.247 (a)(1)	PASS	Xiaoqin Li
5.8	Dwell Time	15.247 (a)(1)	PASS	Xiaoqin Li
5.9	Duty Cycle Correction Factor	-	PASS <sup>*1</sup>	Xiaoqin Li
5.10	Pseudorandom Frequency Hopping Sequence	15.247(b)(4)	PASS	Xiaoqin Li
5.11	Conducted Band Edge and Spurious Emission	15.247(d)/15.205	PASS	Xiaoqin Li
5.12	Radiated Band Edge Emission	15.205/15.209	PASS	Hongbin Zhong
5.13	Radiated Spurious Emission	15.247(d)/15.205/15.209	PASS	Hongbin Zhong

Note:

- The measurement uncertainty is not included in the test result.
- <sup>\*1</sup>: No requirement on standard, only report these test data.

### 3. SUMMARY

#### 3.1. Client Information

Applicant:	XINCHUANGXIN INTERNATIONAL CO.,LTD
Address:	ROOM 605 6/F, FA YUEN COMMERCIAL BUILDING, 75-77 FA YUEN STREET MONGKOK KL
Manufacturer:	Shenzhen Chiteng Technology Co.,LTD
Address:	Second Floor,Area A, Building 4, Huiye Technology Workshop, Guangang Road, Tangjia Community, Gongming Street, Guangming New District, Shenzhen, Guangdong

#### 3.2. Product Description

Main unit information:	
Product Name:	Smart Phone
Trade Mark:	CORN
Model No.:	P60
Listed Model(s):	-
Power supply:	DC 3.8V from Battery
Hardware version:	J527B-31EMB_D3_AF_V1.1
Software version:	CORN_P60_S62301A01_V01_20220531
Accessory unit information:	
Adapter information:	Model: CS001 Input: 100-240Va.c., 50/60Hz 0.15A Output: 5Vd.c., 1A

#### 3.3. Radio Specification Description

Bluetooth version:	V4.0
Support function <sup>*2</sup> :	EDR
Modulation:	GFSK, $\pi/4$ DQPSK, 8DPSK
Operation frequency:	2402MHz~2480MHz
Channel number:	79
Channel separation:	1MHz
Antenna type:	Interna
Antenna gain:	1.1dBi

Note:

\*2: only show the RF function associated with this report.

### 3.4. Testing Laboratory Information

Laboratory Name	Shenzhen Huatongwei International Inspection Co., Ltd.	
Laboratory Location	1/F, Bldg 3, Hongfa Hi-tech Industrial Park, Genyu Road, Tianliao, Gongming, Shenzhen, China	
Connect information:	Phone: 86-755-26715499 E-mail: <a href="mailto:cs@szhtw.com.cn">cs@szhtw.com.cn</a> <a href="http://www.szhtw.com.cn">http://www.szhtw.com.cn</a>	
Qualifications	Type	Accreditation Number
	FCC	762235

## 4. TEST CONFIGURATION

### 4.1. Test frequency list

According to section 15.31(m), regards to the operating frequency range over 10 MHz, must select three channels which were tested. The Lowest frequency, the middle frequency, and the highest frequency of channel were selected to perform the test, please see the below blue front.

Channel	Frequency (MHz)
00	2402
01	2403
⋮	⋮
39	2441
⋮	⋮
77	2479
78	2480

### 4.2. Descriptions of Test mode

Preliminary tests were performed in different data rates and recorded the RF output power in the clause 5.3

Note:

- 1) The manufacturer declare that the maximum power value of the product is set as a default value in the enter test mode software.
- 2) All the test data for each data rate were verified, found 8DPSK Modulation which is worse case mode

### 4.3. Test mode

For RF test items:			
The engineering test program was provided and enabled to make EUT continuous transmitting.			
Test Item	Modulation / Data Rate		
	GFSK 1Mbps	$\pi/4$ DQPSK 2Mbps	8DPSK 3Mbps
Conducted test item	✓	✓	✓
Radiated test item	-	-	✓
Remark:			
<ul style="list-style-type: none"> <li>– For radiated test item, the worst mode data rate 3Mbps was reported only, because this data rate has the highest RF output power at preliminary tests.</li> <li>– The EUT in each of three orthogonal axis emissions had been tested, but only the worst case (X axis) data recorded in the report.</li> </ul>			

#### 4.4. Test sample information

Test item	HTW sample no.
RF Conducted test items	Please refer to the description in the appendix report
RF Radiated test items	YPHT22050324007
EMI test items	YPHT22050324007

Note:

RF Conducted test items: Peak Output Power, 20 dB Bandwidth, 99% Occupied Bandwidth, Carrier Frequency Separation, Hopping Channel Number, Dwell Time, Duty Cycle Correction Factor, Pseudorandom Frequency Hopping Sequence ,Conducted Band Edge and Spurious Emission

RF Radiated test items: Radiated Band Edge Emission, Radiated Spurious Emission

EMI test items: AC Conducted Emission

#### 4.5. Support unit used in test configuration and system

The EUT has been associated with peripherals and configuration operated in a manner tended to maximize its emission characteristics in a typical application.

The following peripheral devices and interface cables were connected during the measurement:

Whether support unit is used?			
✓ No			
Item	Equipment	Trade Name	Model No.
1			
2			

#### 4.6. Testing environmental condition

Type	Requirement	Actual
Temperature:	15~35°C	25°C
Relative Humidity:	25~75%	50%
Air Pressure:	860~1060mbar	1000mbar

#### 4.7. Statement of the measurement uncertainty

Test Item	Measurement Uncertainty
AC Conducted Emission (150kHz~30MHz)	3.00 dB
Radiated Emission (30MHz~1000MHz)	4.36 dB
Radiated Emissions (1GHz~25GHz)	5.10 dB
Peak Output Power	0.77dB
Power Spectral Density	0.77dB
Conducted Spurious Emission	0.77dB
6dB Bandwidth	70Hz for <1GHz 130Hz for >1GHz

This uncertainty represents an expanded uncertainty expressed at approximately the 95% confidence level using a coverage factor of k=1.96.



#### 4.8. Equipment Used during the Test

● Conducted Emission							
Used	Test Equipment	Manufacturer	Equipment No.	Model No.	Serial No.	Last Cal. Date (YY-MM-DD)	Next Cal. Date (YY-MM-DD)
●	Shielded Room	Albatross projects	HTWE0114	N/A	N/A	2018/09/28	2023/09/27
●	EMI Test Receiver	R&S	HTWE0111	ESCI	101247	2021/09/14	2022/09/13
●	Artificial Mains	SCHWARZBECK	HTWE0113	NNLK 8121	573	2021/09/17	2022/09/16
●	Pulse Limiter	R&S	HTWE0193	ESH3-Z2	101447	2021/09/16	2022/09/15
●	RF Connection Cable	HUBER+SUHNER	HTWE0113-02	ENVIROFLE X_142	EF-NM-BNCM-2M	2021/09/17	2022/09/16
●	Test Software	R&S	N/A	ES-K1	N/A	N/A	N/A

○ Radiated emission-6th test site							
Used	Test Equipment	Manufacturer	Equipment No.	Model No.	Serial No.	Last Cal. Date (YY-MM-DD)	Next Cal. Date (YY-MM-DD)
●	Semi-Anechoic Chamber	Albatross projects	HTWE0127	SAC-3m-02	C11121	2018/09/30	2022/09/29
●	EMI Test Receiver	R&S	HTWE0099	ESCI	100900	2021/09/14	2022/09/13
●	Loop Antenna	R&S	HTWE0170	HFH2-Z2	100020	2021/04/06	2024/04/05
●	Ultra-Broadband Antenna	SCHWARZBECK	HTWE0123	VULB9163	538	2021/04/06	2024/04/05
●	Pre-Amplifier	SCHWARZBECK	HTWE0295	BBV 9742	N/A	2021/11/05	2022/11/04
●	RF Connection Cable	HUBER+SUHNER	HTWE0062-01	N/A	N/A	2022/02/25	2023/02/24
●	RF Connection Cable	HUBER+SUHNER	HTWE0062-02	SUCOFLEX104	501184/4	2022/02/25	2023/02/24
●	Test Software	R&S	N/A	ES-K1	N/A	N/A	N/A

● Radiated emission-7th test site							
Used	Test Equipment	Manufacturer	Equipment No.	Model No.	Serial No.	Last Cal. Date (YY-MM-DD)	Next Cal. Date (YY-MM-DD)
●	Semi-Anechoic Chamber	Albatross projects	HTWE0122	SAC-3m-01	C11121	2018/09/27	2022/09/26
●	Spectrum Analyzer	R&S	HTWE0098	FSP40	100597	2021/09/13	2022/09/12
●	Horn Antenna	SCHWARZBECK	HTWE0126	9120D	1011	2020/04/01	2023/03/31
●	Broadband Horn Antenna	SCHWARZBECK	HTWE0103	BBHA9170	BBHA9170472	2020/04/27	2023/04/26
●	Pre-amplifier	CD	HTWE0071	PAP-0102	12004	2021/11/05	2022/11/04
●	Broadband Pre-amplifier	SCHWARZBECK	HTWE0201	BBV 9718	9718-248	2022/02/28	2023/02/27
●	RF Connection Cable	HUBER+SUHNER	HTWE0120-01	6m 18GHz S Serisa	N/A	2022/02/25	2023/02/24
●	RF Connection Cable	HUBER+SUHNER	HTWE0120-02	6m 3GHz RG Serisa	N/A	2022/02/25	2023/02/24
●	RF Connection Cable	HUBER+SUHNER	HTWE0119-05	6m 3GHz RG Serisa	N/A	2022/02/25	2023/02/24
●	RF Connection Cable	HUBER+SUHNER	HTWE0120-04	6m 3GHz RG Serisa	N/A	2022/02/25	2023/02/24
●	Test Software	Audix	N/A	E3	N/A	N/A	N/A

Used	Test Equipment	Manufacturer	Equipment No.	Model No.	Serial No.	Last Cal. Date (YY-MM-DD)	Next Cal. Date (YY-MM-DD)
●	Signal and spectrum Analyzer	R&S	HTWE0242	FSV40	100048	2021/09/13	2022/09/12
●	Signal & Spectrum Analyzer	R&S	HTWE0262	FSW26	103440	2021/09/13	2022/09/12
●	Spectrum Analyzer	Agilent	HTWE0286	N9020A	MY50510187	2021/09/13	2022/09/12
●	Radio communication tester	R&S	HTWE0287	CMW500	137688-Lv	2021/09/13	2022/09/12
●	Test software	Tonscend	N/A	JS1120	N/A	N/A	N/A

## 5. TEST CONDITIONS AND RESULTS

### 5.1. Antenna Requirement

#### REQUIREMENT

##### **FCC CFR Title 47 Part 15 Subpart C Section 15.203:**

An intentional radiator shall be designed to ensure that no antenna other than that furnished by the responsible party shall be used with the device. The use of a permanently attached antenna or of an antenna that uses a unique coupling to the intentional radiator, the manufacturer may design the unit so that a broken antenna can be replaced by the user, but the use of a standard antenna jack or electrical connector is prohibited.

##### **FCC CFR Title 47 Part 15 Subpart C Section 15.247(c) (1)(i):**

(i) Systems operating in the 2400-2483.5 MHz band that is used exclusively for fixed. Point-to-point operations may employ transmitting antennas with directional gain greater than 6 dBi provided the maximum conducted output power of the intentional radiator is reduced by 1 dB for every 3 dB that the directional gain of the antenna exceeds 6 dBi.

#### TEST RESULT

Passed       Not Applicable

The antenna type is a Internal antenna, the directional gain of the antenna less than 6 dBi, please refer to the below antenna photo.

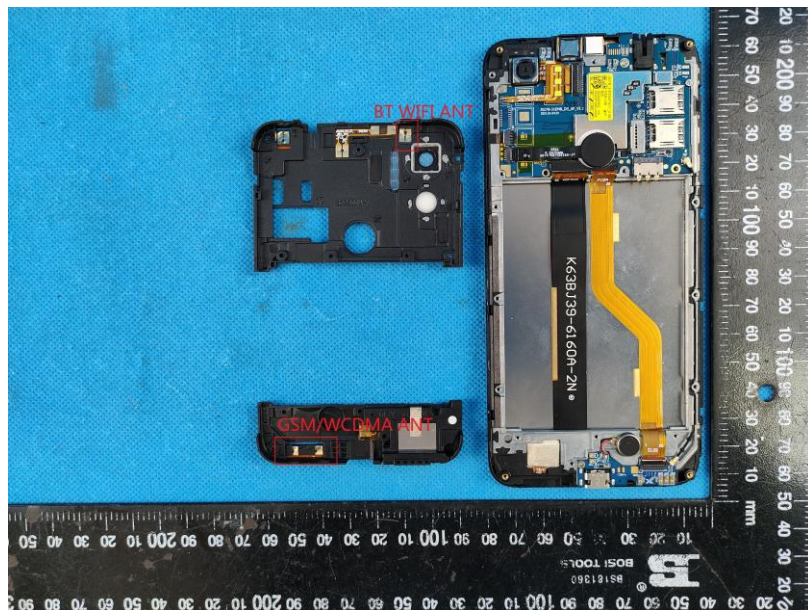

## 5.2. AC Conducted Emission

### LIMIT

#### FCC CFR Title 47 Part 15 Subpart C Section 15.207

Frequency range (MHz)	Limit (dBuV)	
	Quasi-peak	Average
0.15-0.5	66 to 56*	56 to 46*
0.5-5	56	46
5-30	60	50

\* Decreases with the logarithm of the frequency.

### TEST CONFIGURATION

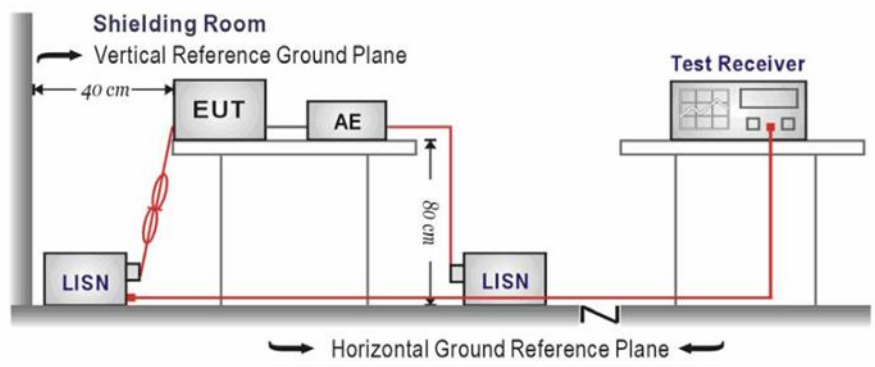

### TEST PROCEDURE

1. The EUT was setup according to ANSI C63.10 requirements.
2. The EUT was placed on a platform of nominal size, 1 m by 1.5 m, raised 80 cm above the conducting ground plane. The vertical conducting plane was located 40 cm to the rear of the EUT. All other surfaces of EUT were at least 80 cm from any other grounded conducting surface.
3. The EUT and simulators are connected to the main power through a line impedances stabilization network (LISN). The LISN provides a 50 ohm /50uH coupling impedance for the measuring equipment.
4. The peripheral devices are also connected to the main power through a LISN. (Please refer to the block diagram of the test setup and photographs)
5. Each current-carrying conductor of the EUT power cord, except the ground (safety) conductor, was individually connected through a LISN to the input power source.
6. The excess length of the power cord between the EUT and the LISN receptacle were folded back and forth at the center of the lead to form a bundle not exceeding 40 cm in length.
7. Conducted emissions were investigated over the frequency range from 0.15MHz to 30MHz using a receiver bandwidth of 9 kHz.
8. During the above scans, the emissions were maximized by cable manipulation.

### TEST MODE

Please refer to the clause 4.3

### TEST RESULT

Passed  Not Applicable

Test Line:

L

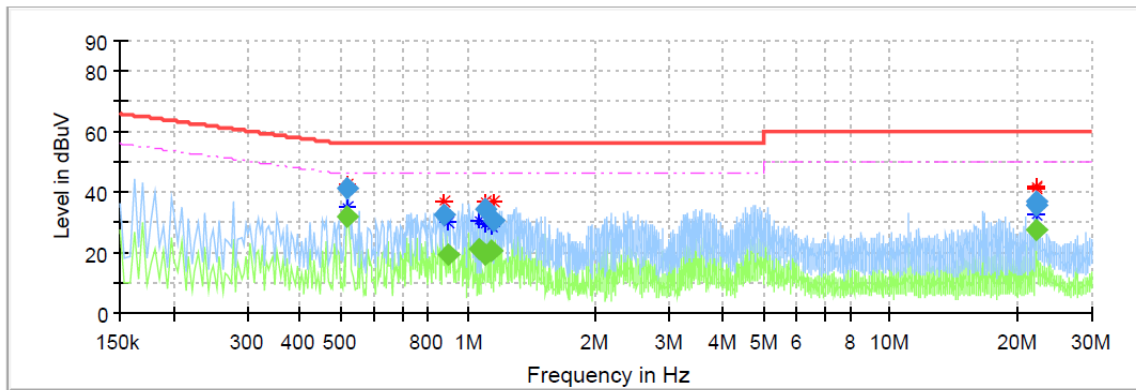

Frequency (MHz)	QuasiPeak (dBuV)	CAverage (dBuV)	Limit (dBuV)	Margin (dB)	Line	Corr. (dB)
0.519500	---	32.05	46.00	13.95	L1	10.1
0.519500	41.16	---	56.00	14.84	L1	10.1
0.875500	32.52	---	56.00	23.48	L1	10.1
0.895500	---	19.31	46.00	26.69	L1	10.1
1.067500	---	21.10	46.00	24.90	L1	10.1
1.095500	---	19.25	46.00	26.75	L1	10.1
1.103500	34.22	---	56.00	21.78	L1	10.1
1.135500	---	20.54	46.00	25.46	L1	10.1
1.143500	30.58	---	56.00	25.42	L1	10.1
22.043500	35.53	---	60.00	24.47	L1	10.9
22.059500	36.77	---	60.00	23.23	L1	10.9
22.063500	---	27.80	50.00	22.20	L1	10.9

Test Line:

N

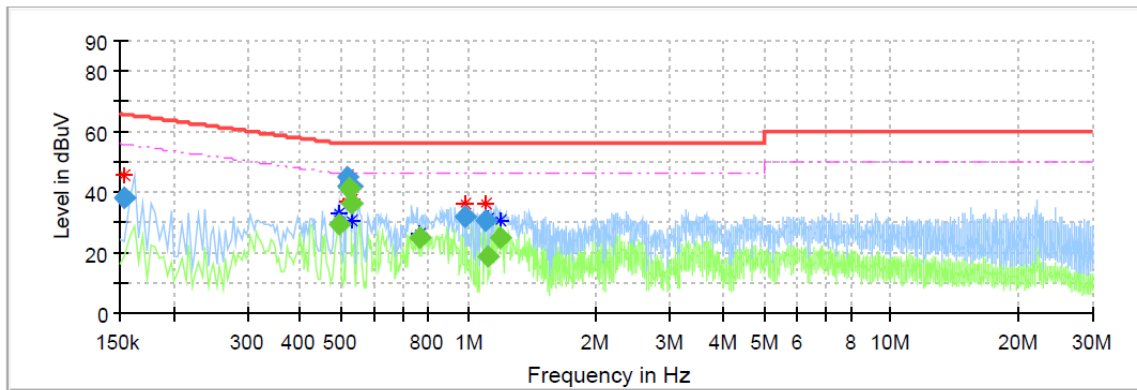

Frequency (MHz)	QuasiPeak (dBuV)	CAverage (dBuV)	Limit (dBuV)	Margin (dB)	Line	Corr. (dB)
0.154000	38.13	---	65.78	27.65	N	10.1
0.495500	---	29.32	46.08	16.75	N	10.1
0.516500	41.80	---	56.00	14.20	N	10.1
0.519500	44.73	---	56.00	11.27	N	10.1
0.523500	---	41.47	46.00	4.53	N	10.1
0.527500	42.04	---	56.00	13.96	N	10.1
0.527500	---	36.54	46.00	9.46	N	10.1
0.763500	---	24.88	46.00	21.12	N	10.2
0.979500	31.90	---	56.00	24.10	N	10.1
1.103500	30.91	---	56.00	25.09	N	10.1
1.115500	---	19.00	46.00	27.00	N	10.1
1.183500	---	24.96	46.00	21.04	N	10.1

### 5.3. Peak Output Power

#### LIMIT

##### **FCC CFR Title 47 Part 15 Subpart C Section 15.247 (b)(1):**

For frequency hopping systems operating in the 2400-2483.5 MHz band employing at least 75 non-overlapping hopping channels, and all frequency hopping systems in the 5725-5850 MHz band: 1 watt.  
For all other frequency hopping systems in the 2400-2483.5 MHz band: 0.125 watts.

#### TEST CONFIGURATION

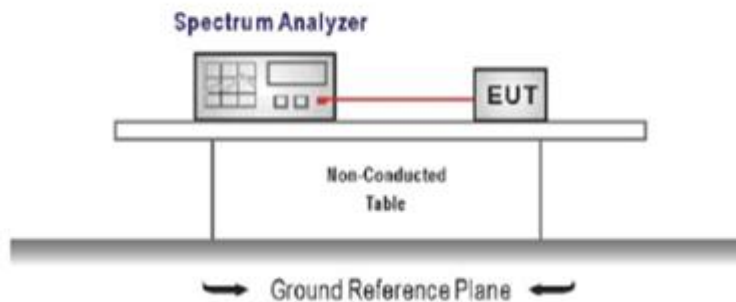

#### TEST PROCEDURE

1. The transmitter output was connected to the spectrum analyzer through an attenuator, the pathloss was compensated to the results for each measurement.
2. Set to the maximum power setting and enable the EUT transmit continuously
3. Use the following spectrum analyzer settings:  
Span = approximately 5 times the 20 dB bandwidth, centered on a hopping channel  
RBW  $\geq$  the 20 dB bandwidth of the emission being measured, VBW  $\geq$  RBW  
Sweep = auto, Detector function = peak, Trace = max hold
4. Measure and record the results in the test report.

#### TEST MODE

Please refer to the clause 4.3

#### TEST RESULT

Passed       Not Applicable

#### TEST DATA

Please refer to appendix A on the appendix report

## 5.4. 20 dB Bandwidth

### LIMIT

N/A

### TEST CONFIGURATION

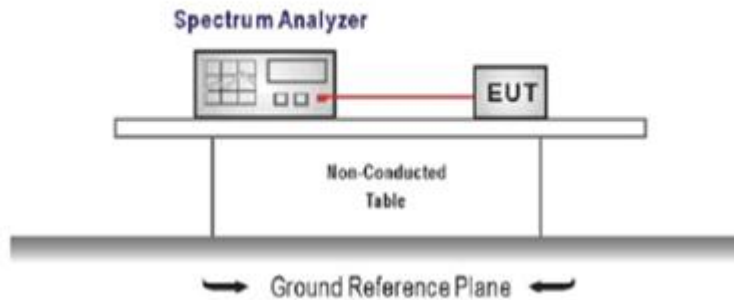

### TEST PROCEDURE

1. The transmitter output was connected to the spectrum analyzer through an attenuator, the path loss was compensated to the results for each measurement.
2. Set to the maximum power setting and enable the EUT transmit continuously
3. Use the following spectrum analyzer settings:  
Span = approximately 2 to 3 times the 20 dB bandwidth, centered on a hopping channel  
RBW  $\geq$  1% of the 20 dB bandwidth, VBW  $\geq$  RBW  
Sweep = auto, Detector function = peak, Trace = max hold
4. Measure and record the results in the test report.

### TEST MODE

Please refer to the clause 4.3

### TEST RESULT

Passed       Not Applicable

### TEST DATA

Please refer to appendix B on the appendix report



## 5.5. 99% Occupied Bandwidth

### LIMIT

N/A

### TEST CONFIGURATION

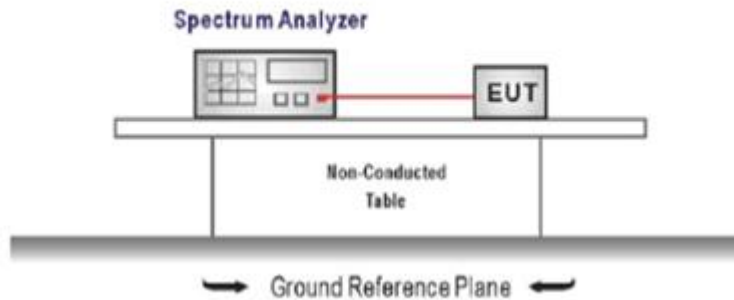

### TEST PROCEDURE

1. Connect the antenna port(s) to the spectrum analyzer input.
2. Configure the spectrum analyzer as shown below (enter all losses between the transmitter output and the spectrum analyzer).  
Center Frequency = channel center frequency  
Span  $\geq 1.5 \times$  OBW  
RBW = 1%~5%OBW  
VBW  $\geq 3 \times$  RBW  
Sweep time = auto couple  
Detector = Peak  
Trace mode = max hold
3. Place the radio in continuous transmit mode, allow the trace to stabilize, view the transmitter waveform on the spectrum analyzer.

### TEST MODE

Please refer to the clause 4.3

### TEST RESULT

Passed       Not Applicable

### TEST DATA

Please refer to appendix C on the appendix report

## 5.6. Carrier Frequencies Separation

### LIMIT

#### **FCC CFR Title 47 Part 15 Subpart C Section 15.247 (a)(1):**

Frequency hopping systems shall have hopping channel carrier frequencies separated by a minimum of 25kHz or the 20 dB bandwidth of the hopping channel, whichever is greater. Alternatively, Frequency hopping systems operating in the 2400-2483.5 MHz band may have hopping channel carrier frequencies that are separated by 25 kHz or two-thirds of the 20 dB bandwidth of the hopping channel, whichever is greater, provided the systems operate with an output power no greater than 125 mW.

### TEST CONFIGURATION

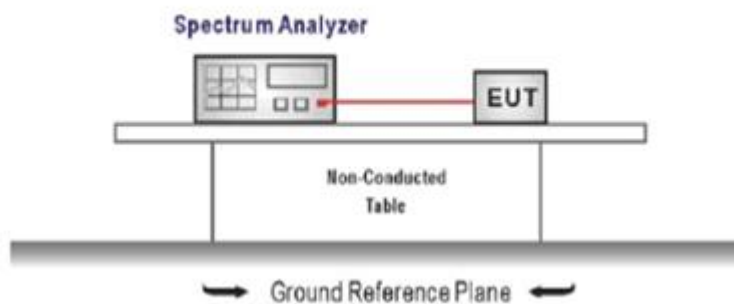

### TEST PROCEDURE

1. The transmitter output was connected to the spectrum analyzer through an attenuator, the path loss was compensated to the results for each measurement.
2. Set to the maximum power setting and enable the EUT transmit continuously
3. Use the following spectrum analyzer settings:
  - Span = wide enough to capture the peaks of two adjacent channels
  - RBW  $\geq$  1% of the span, VBW  $\geq$  RBW
  - Sweep = auto, Detector function = peak, Trace = max hold
4. Measure and record the results in the test report.

### TEST MODE

Please refer to the clause 4.3

### TEST RESULTS

Passed       Not Applicable

### TEST DATA

Please refer to appendix D on the appendix report

## 5.7. Hopping Channel Number

### LIMIT

**FCC CFR Title 47 Part 15 Subpart C Section 15.247 (a)(1):**

Frequency hopping systems in the 2400–2483.5 MHz band shall use at least **15** channels.

### TEST CONFIGURATION

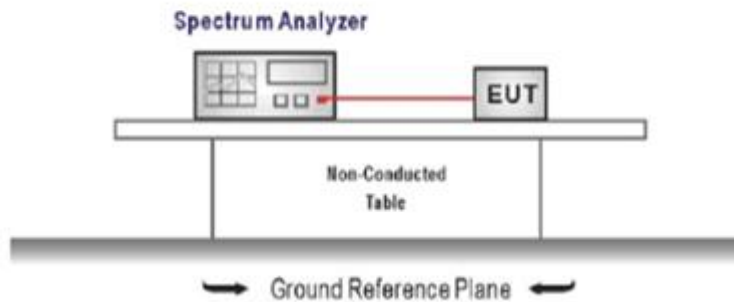

### TEST PROCEDURE

1. The transmitter output was connected to the spectrum analyzer through an attenuator, the path loss was compensated to the results for each measurement.
2. Set to the maximum power setting and enable the EUT transmit continuously
3. Use the following spectrum analyzer settings:  
Span = the frequency band of operation  
RBW  $\geq$  1% of the span, VBW  $\geq$  RBW  
Sweep = auto, Detector function = peak, Trace = max hold
4. Measure and record the results in the test report.

### TEST MODE

Please refer to the clause 4.3

### TEST RESULTS

Passed       Not Applicable

### TEST DATA

Please refer to appendix E on the appendix report

## 5.8. Dwell Time

### LIMIT

FCC CFR Title 47 Part 15 Subpart C Section 15.247 (a)(1):The average time of occupancy on any channel shall not be greater than 0.4 seconds within a pe-riod of 0.4 seconds multiplied by the number of hopping channels employed.

### TEST CONFIGURATION

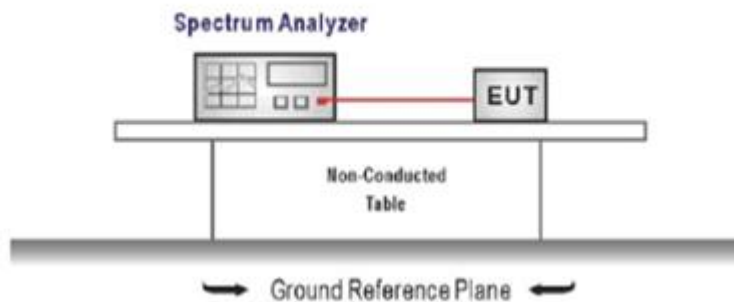

### TEST PROCEDURE

1. The transmitter output was connected to the spectrum analyzer through an attenuator, the path loss was compensated to the results for each measurement.
2. Set to the maximum power setting and enable the EUT transmit continuously
3. Use the following spectrum analyzer settings:  
Span = zero span, centered on a hopping channel, RBW= 1 MHz, VBW  $\geq$  RBW  
Sweep = as necessary to capture the entire dwell time per hopping channel,  
Detector function = peak, Trace = max hold
4. Measure and record the results in the test report.

### TEST MODE

Please refer to the clause 4.3

### TEST RESULTS

Passed       Not Applicable

### TEST DATA

Please refer to appendix F on the appendix report

## 5.9. Duty Cycle Correction Factor (DCCF)

### LIMIT

N/A

### TEST CONFIGURATION

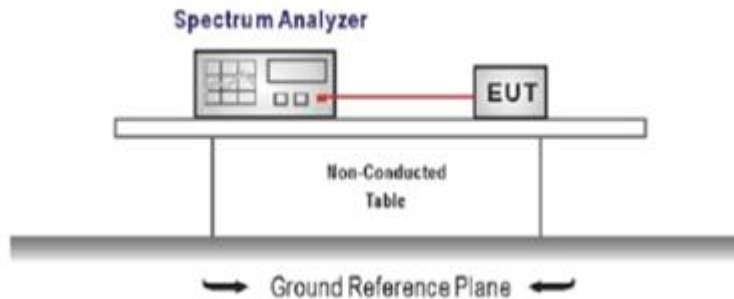

### TEST PROCEDURE

1. The transmitter output was connected to the spectrum analyzer through an attenuator, the path loss was compensated to the results for each measurement.
2. Set to the maximum power setting and enable the EUT transmit continuously
3. Use the following spectrum analyzer settings:  
Span = zero span, centered on a hopping channel, RBW= 1 MHz, VBW  $\geq$  RBW  
Sweep = as necessary to capture the entire dwell time per hopping channel,  
Detector function = peak, Trigger mode
4. Measure and record the duty cycle data

### TEST MODE

Please refer to the clause 4.3

### TEST DATA

Please refer to appendix G on the appendix report

## 5.10. Pseudorandom Frequency Hopping Sequence

### LIMIT

FCC CFR Title 47 Part 15 Subpart C Section 15.247 (a)(1): Frequency hopping systems shall have hopping channel carrier frequencies separated by a minimum of 25 kHz or the 20 dB bandwidth of the hopping channel, whichever is greater. Alternatively, frequency hopping systems operating in the 2400–2483.5 MHz band may have hopping channel carrier frequencies that are separated by 25 kHz or two-thirds of the 20 dB bandwidth of the hopping channel, whichever is greater, provided the systems operate with an output power no greater than 125 mW. The system shall hop to channel frequencies that are selected at the system hopping rate from a pseudo-randomly ordered list of hopping frequencies. Each frequency must be used equally on the average by each transmitter. The system receivers shall have input bandwidths that match the hopping channel bandwidths of their corresponding transmitters and shall shift frequencies in synchronization with the transmitted signals.

### TEST RESULTS

The pseudorandom frequency hopping sequence may be generated in a nine-stage shift register whose 5<sup>th</sup> and 9<sup>th</sup> stage outputs are added in a modulo-two addition stage. And the result is fed back to the input of the first stage. The sequence begins with the first one of 9 consecutive ones, for example: the shift register is initialized with nine ones.

- Number of shift register stages: 9
- Length of pseudo-random sequence:  $2^9 - 1 = 511$  bits
- Longest sequence of zeros: 8 (non-inverted signal)

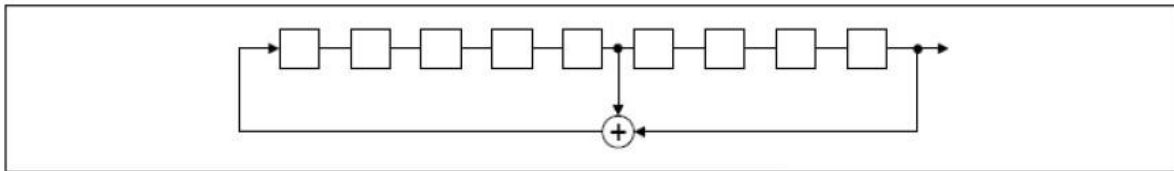

*Linear Feedback Shift Register for Generation of the PRBS sequence*

An example of pseudorandom frequency hopping sequence as follows:

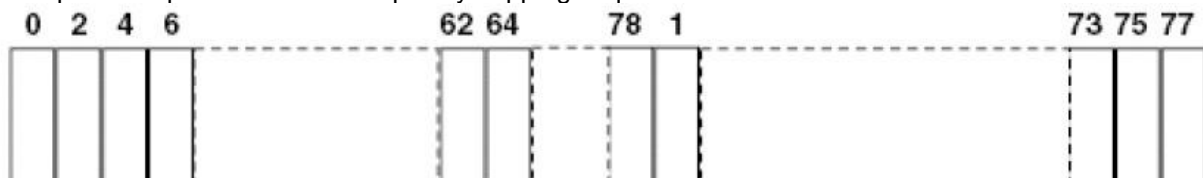

Each frequency used equally on the average by each transmitter.

The system receiver has input bandwidths that match the hopping channel bandwidths of their corresponding transmitter and shifts frequencies in synchronization with the transmitted signals.

## 5.11. Conducted Band edge and Spurious Emission

### LIMIT

**FCC CFR Title 47 Part 15 Subpart C Section 15.247 (d):** In any 100 kHz bandwidth outside the frequency band in which the spread spectrum intentional radiator is operating, the radio frequency power that is produced by the intentional radiator shall be at least 20 dB below that in the 100 kHz bandwidth within the band that contains the highest level of the desired power, based on either an RF conducted or a radiated measurement.

### TEST CONFIGURATION

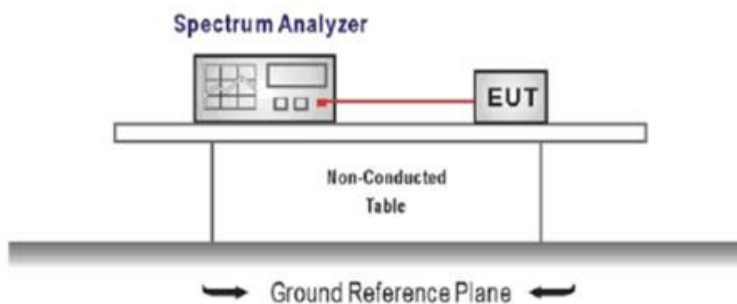

### TEST PROCEDURE

1. Connect the antenna port(s) to the spectrum analyzer input.
2. Emission level measurement  
Set the center frequency and span to encompass frequency range to be measured  
RBW = 100 kHz, VBW  $\geq$  3 x RBW  
Detector = peak, Sweep time = auto couple, Trace mode = max hold  
Allow trace to fully stabilize  
Use the peak marker function to determine the maximum amplitude level.
3. Place the radio in continuous transmit mode, allow the trace to stabilize, view the transmitter waveform on the spectrum analyzer.
4. Ensure that the amplitude of all unwanted emission outside of the authorized frequency band excluding restricted frequency bands) are attenuated by at least the minimum requirements specified (at least 20 dB relative to the maximum in-band peak PSD level in 100 kHz). Report the three highest emission relative to the limit.

### TEST MODE

Please refer to the clause 4.3

**TEST RESULT**

**Passed**       **Not Applicable**

**TEST DATA**

Please refer to appendix H on the appendix report



## 5.12. Radiated Band edge Emission

### LIMIT

#### **FCC CFR Title 47 Part 15 Subpart C Section 15.247 (d):**

In any 100 kHz bandwidth outside the frequency band in which the spread spectrum or digitally modulated intentional radiator is operating, Radiated Emissions which fall in the restricted bands, as defined in §15.205(a), must also comply with the Radiated Emissions limits specified in §15.209(a) (see §15.205(c)).

### TEST CONFIGURATION

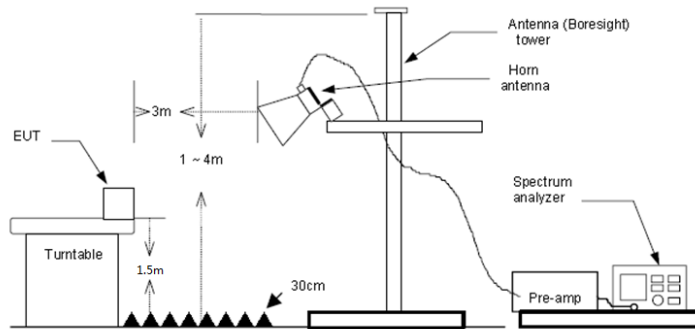

### TEST PROCEDURE

1. The EUT was setup and tested according to ANSI C63.10 .
2. The EUT is placed on a turn table which is 1.5 meter above ground. The turn table is rotated 360 degrees to determine the position of the maximum emission level.
3. The EUT was positioned such that the distance from antenna to the EUT was 3 meters.
4. The antenna is scanned from 1 meter to 4 meters to find out the maximum emission level. This is repeated for both horizontal and vertical polarization of the antenna. In order to find the maximum emission, all of the interface cables were manipulated according to ANSI C63.10 on radiated measurement.
5. Use the following spectrum analyzer settings:
  - a) Span shall wide enough to fully capture the emission being measured
  - b) Set RBW=100kHz for <1GHz, VBW=3\*RBW, Sweep time=auto, Detector=peak, Trace=max hold
  - c) Set RBW=1MHz, VBW=3MHz for >1GHz, Sweep time=auto, Detector=peak, Trace=max hold for Peak measurement

For average measurement: use duty cycle correction factor method (DCCF)

Averager level = Peak level + DCCF

### TEST MODE

Please refer to the clause 4.3

### TEST RESULT

Passed       Not Applicable

Note:

- 1) Level= Reading + Factor; Factor =Antenna Factor+ Cable Loss- Preamp Factor
- 2) Over Limit = Level- Limit
- 3) Average measurement was not performed if peak level is lower than average limit(54 dBuV/m).

Test channel:		CH00			Polarity			Horizontal		
Mark	Frequency MHz	Reading dBuV/m	Antenna dB	Cable dB	Preamp dB	Level dBuV/m	Limit dBuV/m	Over limit	Remark	
1	2310.00	39.86	27.96	5.43	37.56	35.69	74.00	-38.31	Peak	
2	2390.03	39.60	27.72	5.53	37.45	35.40	74.00	-38.60	Peak	

Test channel:		CH00			Polarity			Vertical		
Mark	Frequency MHz	Reading dBuV/m	Antenna dB	Cable dB	Preamp dB	Level dBuV/m	Limit dBuV/m	Over limit	Remark	
1	2310.00	39.88	27.96	5.43	37.56	35.71	74.00	-38.29	Peak	
2	2390.03	42.30	27.72	5.53	37.45	38.10	74.00	-35.90	Peak	

Test channel:		CH78			Polarity			Horizontal		
Mark	Frequency MHz	Reading dBuV/m	Antenna dB	Cable dB	Preamp dB	Level dBuV/m	Limit dBuV/m	Over limit	Remark	
1	2483.50	46.15	27.43	5.64	37.26	41.96	74.00	-32.04	Peak	
2	2483.60	51.14	27.43	5.64	37.26	46.95	74.00	-27.05	Peak	
3	2500.00	39.54	27.40	5.66	37.26	35.34	74.00	-38.66	Peak	

Test channel:		CH78			Polarity			Vertical		
Mark	Frequency MHz	Reading dBuV/m	Antenna dB	Cable dB	Preamp dB	Level dBuV/m	Limit dBuV/m	Over limit	Remark	
1	2483.50	47.12	27.43	5.64	37.26	42.93	74.00	-31.07	Peak	
2	2483.57	52.85	27.43	5.64	37.26	48.66	74.00	-25.34	Peak	
3	2500.00	41.08	27.40	5.66	37.26	36.88	74.00	-37.12	Peak	

### 5.13. Radiated Spurious Emission

#### LIMIT

#### FCC CFR Title 47 Part 15 Subpart C Section 15.209

Frequency	Limit (dBuV/m)	Value
0.009 MHz ~0.49 MHz	2400/F(kHz) @300m	Quasi-peak
0.49 MHz ~ 1.705 MHz	24000/F(kHz) @30m	Quasi-peak
1.705 MHz ~30 MHz	30 @30m	Quasi-peak

Note: Limit dBuV/m @3m = Limit dBuV/m @300m + 40\*log(300/3)= Limit dBuV/m @300m +80,

Limit dBuV/m @3m = Limit dBuV/m @30m +40\*log(30/3)= Limit dBuV/m @30m + 40.

Frequency	Limit (dBuV/m @3m)	Value
30MHz~88MHz	40.00	Quasi-peak
88MHz~216MHz	43.50	Quasi-peak
216MHz~960MHz	46.00	Quasi-peak
960MHz~1GHz	54.00	Quasi-peak
Above 1GHz	54.00	Average
	74.00	Peak

#### TEST CONFIGURATION

- 9 kHz ~ 30 MHz

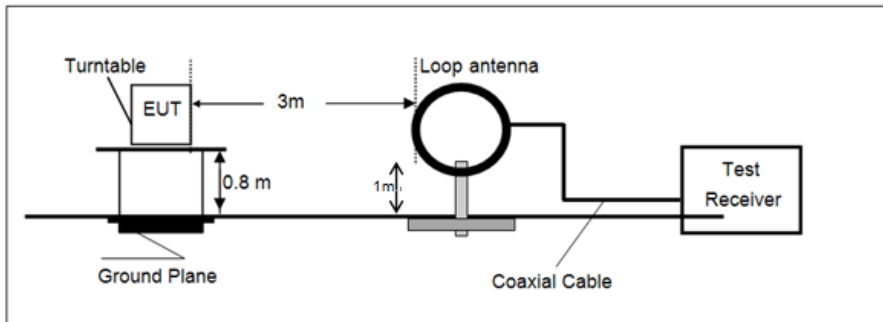

- 30 MHz ~ 1 GHz

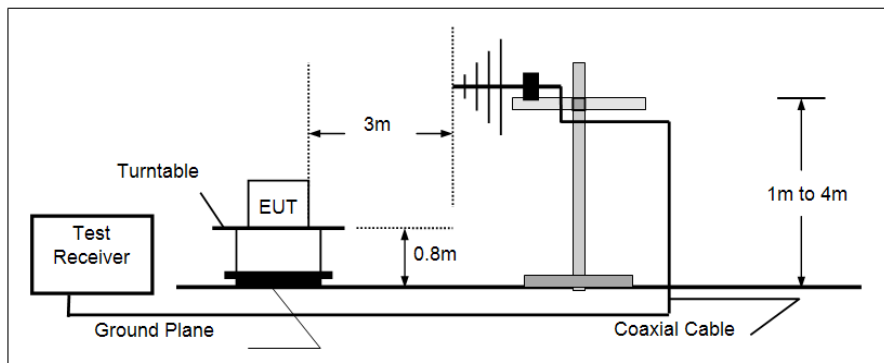

- Above 1 GHz

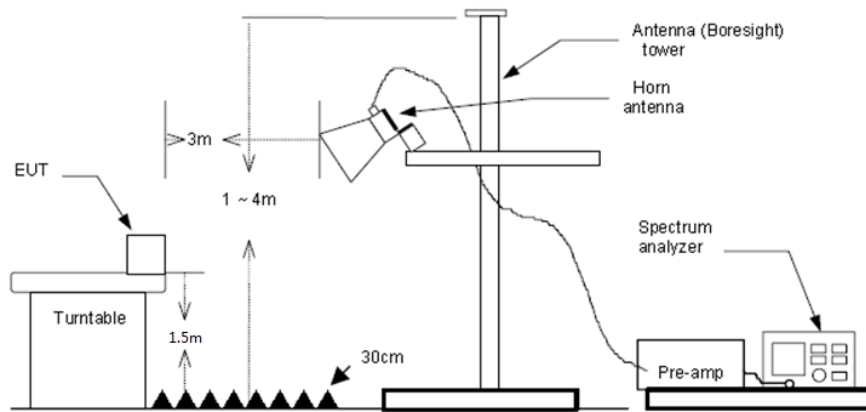

### **TEST PROCEDURE**

1. The EUT was setup and tested according to ANSI C63.10 .
2. The EUT is placed on a turn table which is 0.8 meter above ground for below 1 GHz, and 1.5 m for above 1 GHz. The turn table is rotated 360 degrees to determine the position of the maximum emission level.
3. The EUT was set 3 meters from the receiving antenna, which was mounted on the top of a variable height antenna tower.
4. For each suspected emission, the EUT was arranged to its worst case and then tune the Antenna tower (from 1 m to 4 m) and turntable (from 0 degree to 360 degrees) to find the maximum reading. A pre-amp and a high pass filter are used for the test in order to get better signal level to comply with the guidelines.
5. Set to the maximum power setting and enable the EUT transmit continuously.
6. Use the following spectrum analyzer settings
  - a) Span shall wide enough to fully capture the emission being measured;
  - b) Below 1 GHz:
    - RBW=120 kHz, VBW=300 kHz, Sweep=auto, Detector function=peak, Trace=max hold;
    - If the emission level of the EUT measured by the peak detector is 3 dB lower than the applicable limit, the peak emission level will be reported. Otherwise, the emission measurement will be repeated using the quasi-peak detector and reported.
  - c) Set RBW=1MHz, VBW=3MHz for >1GHz, Sweep time=auto, Detector=peak, Trace=max hold for Peak measurement
    - For average measurement: use duty cycle correction factor method (DCCF)
    - Averager level = Peak level + DCCF

### **TEST MODE**

Please refer to the clause 4.3

### **TEST RESULT**

**Passed**       **Not Applicable**

Note:

- 1) Level= Reading + Factor/Transd; Factor/Transd =Antenna Factor+ Cable Loss- Preamp Factor
- 2) Over Limit = Level- Limit
- 3) Average measurement was not performed if peak level is lower than average limit(54 dBuV/m) for above 1GHz.

**For 9 kHz ~ 30 MHz**

The EUT was pre-scanned this frequency band, found the radiated level 20dB lower than the limit, so don't show data on this report.

**For 30 MHz ~ 1000 MHz**

Have pre-scan all test channel, found CH39 which it was worst case, so only show the worst case's data on this report.

Polarization:

Horizontal

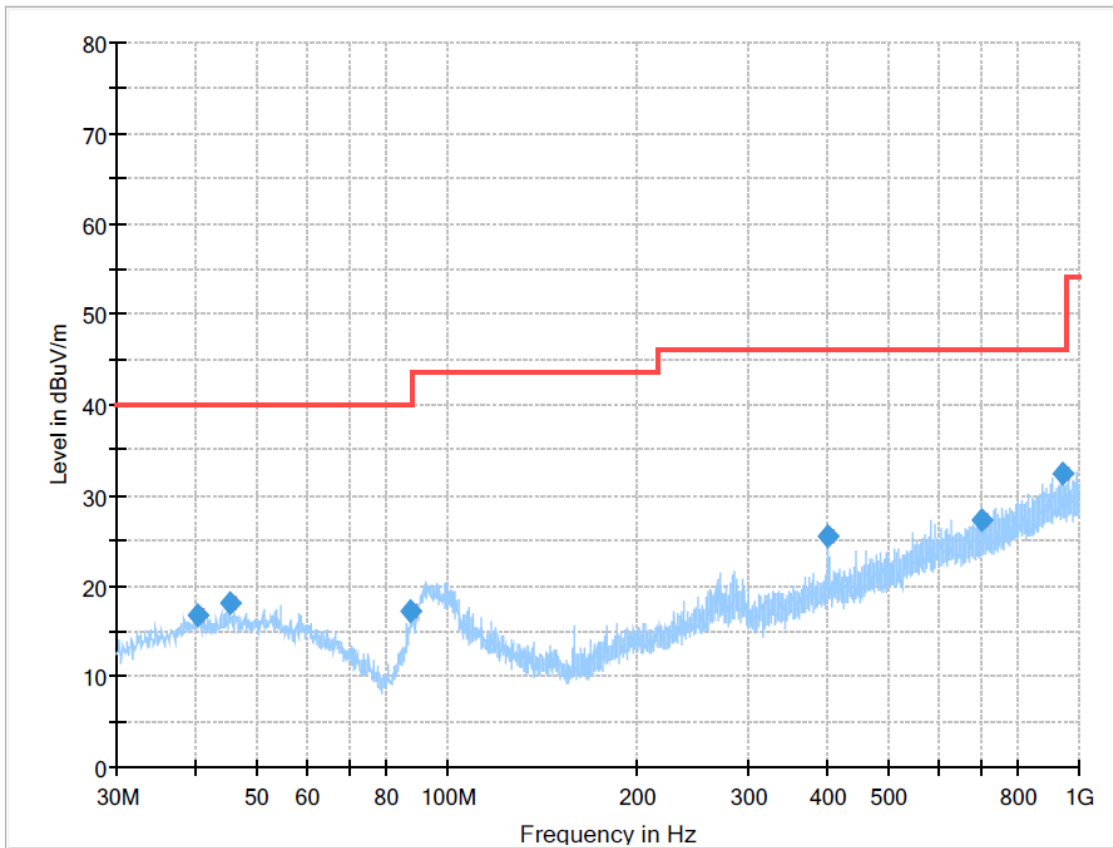

Frequency (MHz)	MaxPeak (dBuV/m)	Limit (dBuV/m)	Margin (dB)	Height (cm)	Pol	Azimuth (deg)	Corr. (dB/m)
40.427500	16.81	40.00	23.19	100.0	H	244.0	-9.7
45.277500	18.04	40.00	21.96	300.0	H	282.0	-9.4
87.715000	17.12	40.00	22.88	300.0	H	138.0	-13.3
400.055000	25.50	46.00	20.50	100.0	H	62.0	-4.2
700.876250	27.37	46.00	18.63	100.0	H	313.0	2.5
945.680000	32.44	46.00	13.56	100.0	H	0.0	7.6

Polarization:

Vertical

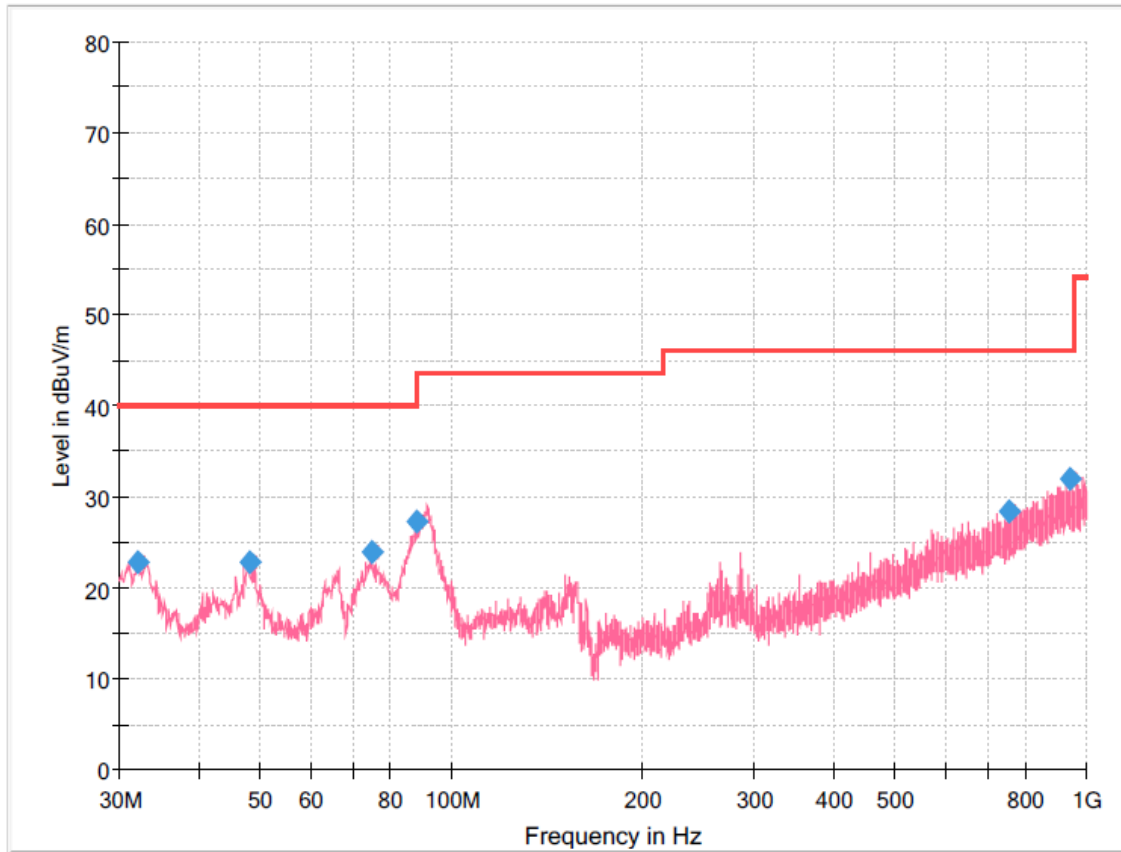

Frequency (MHz)	MaxPeak (dBuV/m)	Limit (dBuV/m)	Margin (dB)	Height (cm)	Pol	Azimuth (deg)	Corr. (dB/m)
32.061250	22.71	40.00	17.29	100.0	V	74.0	-12.0
47.945000	22.80	40.00	17.20	100.0	V	83.0	-9.2
74.741250	23.99	40.00	16.01	100.0	V	164.0	-14.5
87.957500	27.27	40.00	12.73	100.0	V	239.0	-13.3
753.620000	28.39	46.00	17.61	100.0	V	273.0	3.7
941.315000	31.85	46.00	14.15	100.0	V	74.0	7.5

**For 1 GHz ~ 25 GHz**

Test channel		CH00			Polarity		Horizontal		
Mark	Frequency MHz	Reading dBuV/m	Antenna dB	Cable dB	Preamp dB	Level dBuV/m	Limit dBuV/m	Over limit	Remark
1	1149.73	41.60	25.40	3.78	36.78	34.00	74.00	-40.00	Peak
2	2314.84	40.41	27.94	5.43	37.56	36.22	74.00	-37.78	Peak
3	4804.28	40.05	31.40	8.46	35.29	44.62	74.00	-29.38	Peak
4	7210.80	36.61	36.48	10.01	34.01	49.09	74.00	-24.91	Peak

Test channel		CH00			Polarity		Vertical		
Mark	Frequency MHz	Reading dBuV/m	Antenna dB	Cable dB	Preamp dB	Level dBuV/m	Limit dBuV/m	Over limit	Remark
1	2292.06	40.69	28.02	5.41	37.54	36.58	74.00	-37.42	Peak
2	2735.54	40.51	28.14	5.91	37.24	37.32	74.00	-36.68	Peak
3	4804.28	38.68	31.40	8.46	35.29	43.25	74.00	-30.75	Peak
4	7210.80	38.64	36.48	10.01	34.01	51.12	74.00	-22.88	Peak

Test channel		CH39			Polarity		Horizontal		
Mark	Frequency MHz	Reading dBuV/m	Antenna dB	Cable dB	Preamp dB	Level dBuV/m	Limit dBuV/m	Over limit	Remark
1	1149.73	41.60	25.40	3.78	36.78	34.00	74.00	-40.00	Peak
2	2314.84	40.41	27.94	5.43	37.56	36.22	74.00	-37.78	Peak
3	4881.54	40.50	31.40	8.66	35.18	45.38	74.00	-28.62	Peak
4	7326.76	36.31	36.45	10.08	34.09	48.75	74.00	-25.25	Peak

Test channel		CH39			Polarity		Vertical		
Mark	Frequency MHz	Reading dBuV/m	Antenna dB	Cable dB	Preamp dB	Level dBuV/m	Limit dBuV/m	Over limit	Remark
1	2292.06	40.69	28.02	5.41	37.54	36.58	74.00	-37.42	Peak
2	2735.54	40.51	28.14	5.91	37.24	37.32	74.00	-36.68	Peak
3	4881.54	39.10	31.40	8.66	35.18	43.98	74.00	-30.02	Peak
4	7326.76	38.03	36.45	10.08	34.09	50.47	74.00	-23.53	Peak

Test channel		CH78			Polarity		Horizontal		
Mark	Frequency MHz	Reading dBuV/m	Antenna dB	Cable dB	Preamp dB	Level dBuV/m	Limit dBuV/m	Over limit	Remark
1	1149.73	41.60	25.40	3.78	36.78	34.00	74.00	-40.00	Peak
2	2314.84	40.41	27.94	5.43	37.56	36.22	74.00	-37.78	Peak
3	4960.04	38.52	31.58	8.77	35.21	43.66	74.00	-30.34	Peak
4	7444.58	34.98	36.60	10.35	33.97	47.96	74.00	-26.04	Peak

  

Test channel		CH78			Polarity		Vertical		
Mark	Frequency MHz	Reading dBuV/m	Antenna dB	Cable dB	Preamp dB	Level dBuV/m	Limit dBuV/m	Over limit	Remark
1	2292.06	40.69	28.02	5.41	37.54	36.58	74.00	-37.42	Peak
2	2735.54	40.51	28.14	5.91	37.24	37.32	74.00	-36.68	Peak
3	4960.04	37.50	31.58	8.77	35.21	42.64	74.00	-31.36	Peak
4	7444.58	34.39	36.60	10.35	33.97	47.37	74.00	-26.63	Peak



## 6. TEST SETUP PHOTOS

Radiated Emission

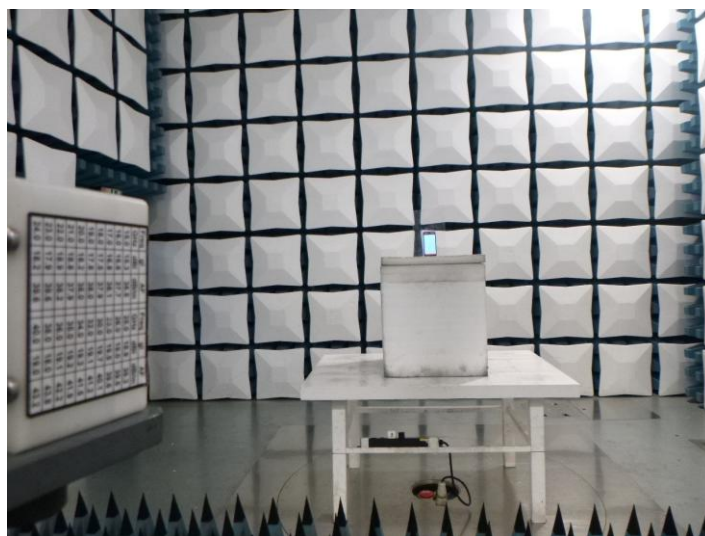
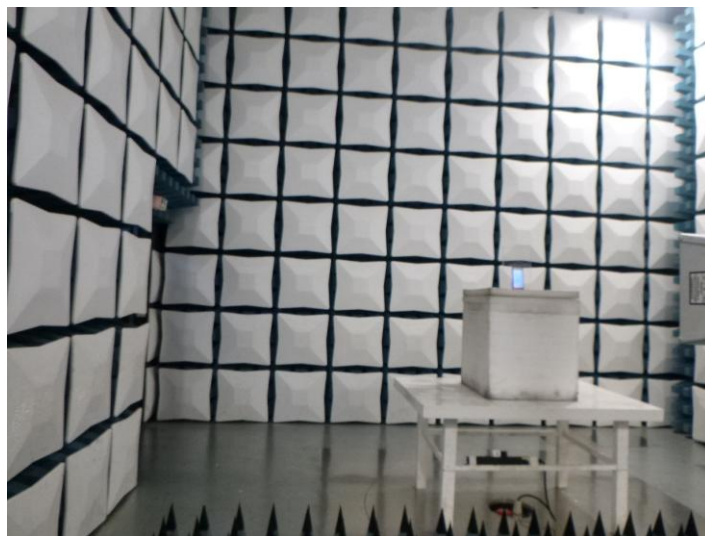

AC Conducted Emission



## **7. EXTERNAL AND INTERNAL PHOTOS**

Refer to the test report No.: CHTEW22060005

## **8. APPENDIX REPORT**