



# TEST REPORT

For Bluetooth-LE

Report No. .... : **CHEW22060008** Report Verification: 

Project No..... : **SHT2205032403EW**

FCC ID..... : **2ASWWCORNP60**

Applicant's name..... : **XINCHUANGXIN INTERNATIONAL CO.,LTD**

Address..... : **ROOM 605 6/F, FA YUEN COMMERCIAL BUILDING, 75-77 FA YUEN STREET MONGKOK KL**

Product Name ..... : **Smart Phone**

Trade Mark ..... : **CORN**

Model No. .... : **P60**

Listed Model(s) ..... : **-**

Standard ..... : **FCC CFR Title 47 Part 15 Subpart C Section 15.247**

Date of receipt of test sample..... : **May.20, 2022**

Date of testing..... : **May.21, 2022-Jun.01, 2022**

Date of issue..... : **Jun.02, 2022**

Result..... : **PASS**

Compiled by  
 ( position+printedname+signature).... : File administrators Fanghui Zhu

*Fanghui Zhu*

Supervised by  
 (position+printedname+signature).... : Project Engineer Cheng Xiao

*Cheng Xiao*

Approved by  
 (Position+Printed name+Signature): RF Manager Hans Hu

*Hans Hu*

Testing Laboratory Name ..... : **Shenzhen Huatongwei International Inspection Co., Ltd.**

Address..... : **1/F, Bldg 3, Hongfa Hi-tech Industrial Park, Genuyu Road, Tianliao, Gongming, Shenzhen, China**

**Shenzhen Huatongwei International Inspection Co., Ltd. All rights reserved.**

This publication may be reproduced in whole or in part for non-commercial purposes as long as the Shenzhen Huatongwei International Inspection Co., Ltd. is acknowledged as copyright owner and source of the material. Shenzhen Huatongwei International Inspection Co., Ltd. takes no responsibility for and will not assume liability for damages resulting from the reader's interpretation of the reproduced material due to its placement and context.

The test report merely correspond to the test sample.

## Contents

|           |  |           |
|-----------|--|-----------|
| <b>1.</b> | <b>TEST STANDARDS AND REPORT VERSION</b>           | <b>3</b>  |
| 1.1.      | Test Standards                                     | 3         |
| 1.2.      | Report version                                     | 3         |
| <b>2.</b> | <b>TEST DESCRIPTION</b>                            | <b>4</b>  |
| <b>3.</b> | <b>SUMMARY</b>                                     | <b>5</b>  |
| 3.1.      | Client Information                                 | 5         |
| 3.2.      | Product Description                                | 5         |
| 3.3.      | Radio Specification Description                    | 5         |
| 3.4.      | Testing Laboratory Information                     | 6         |
| <b>4.</b> | <b>TEST CONFIGURATION</b>                          | <b>7</b>  |
| 4.1.      | Test frequency list                                | 7         |
| 4.2.      | Descriptions of Test mode                          | 7         |
| 4.3.      | Test sample information                            | 7         |
| 4.4.      | Support unit used in test configuration and system | 8         |
| 4.5.      | Testing environmental condition                    | 8         |
| 4.6.      | Statement of the measurement uncertainty           | 8         |
| 4.7.      | Equipment Used during the Test                     | 9         |
| <b>5.</b> | <b>TEST CONDITIONS AND RESULTS</b>                 | <b>11</b> |
| 5.1.      | Antenna Requirement                                | 11        |
| 5.2.      | AC Conducted Emission                              | 12        |
| 5.3.      | Peak Output Power                                  | 15        |
| 5.4.      | Power Spectral Density                             | 16        |
| 5.5.      | 6dB bandwidth                                      | 17        |
| 5.6.      | 99% Occupied Bandwidth                             | 18        |
| 5.7.      | Duty Cycle   | 19        |
| 5.8.      | Conducted Band edge and Spurious Emission          | 20        |
| 5.9.      | Radiated Band edge Emission                        | 21        |
| 5.10.     | Radiated Spurious Emission                         | 23        |
| <b>6.</b> | <b>TEST SETUP PHOTOS</b>                           | <b>29</b> |
| <b>7.</b> | <b>EXTERNAL AND INTERNAL PHOTOS</b>                | <b>30</b> |
| <b>8.</b> | <b>APPENDIX REPORT</b>                             | <b>30</b> |

# 1. TEST STANDARDS AND REPORT VERSION

## 1.1. Test Standards

The tests were performed according to following standards:

- [FCC Rules Part 15.247](#): Frequency Hopping, Direct Spread Spectrum and Hybrid Systems that are in operation within the bands of 902-928 MHz, 2400-2483.5 MHz, and 5725-5850 MHz
- [ANSI C63.10:2013](#): American National Standard for Testing Unlicensed Wireless Devices
- [KDB 558074 D01 15.247 Meas Guidance v05r02](#): Guidance for Compliance Measurements on Digital Transmission System, Frequency Hopping Spread Spectrum System, and Hybrid System Devices Operating under Section 15.247 of The FCC Rules

## 1.2. Report version

| Revision No. | Date of issue | Description |
|--------------|---------------|-------------|
| N/A          | 2022-06-02    | Original    |
|              |               |             |
|              |               |             |
|              |               |             |
|              |               |             |

## 2. TEST DESCRIPTION

| Report clause | Test Items                                | Standard Requirement    | Result             | Test Engineer |
|---------------|---|-------------------------|--------------------|---------------|
| 5.1           | Antenna Requirement                       | 15.203/15.247(c)        | PASS               | Xiaoqin Li    |
| 5.2           | AC Conducted Emission                     | 15.207                  | PASS               | Junman Wang   |
| 5.3           | Peak Output Power                         | 15.247(b)(3)            | PASS               | Xiaoqin Li    |
| 5.4           | Power Spectral Density                    | 15.247(e)               | PASS               | Xiaoqin Li    |
| 5.5           | 6dB Bandwidth                             | 15.247(a)(2)            | PASS               | Xiaoqin Li    |
| 5.6           | 99% Occupied Bandwidth                    | -                       | PASS <sup>*1</sup> | Xiaoqin Li    |
| 5.7           | Duty cycle                                | -                       | PASS <sup>*1</sup> | Xiaoqin Li    |
| 5.8           | Conducted Band Edge and Spurious Emission | 15.247(d)/15.205        | PASS               | Xiaoqin Li    |
| 5.9           | Radiated Band Edge Emission               | 15.205/15.209           | PASS               | Xiaoqin Li    |
| 5.10          | Radiated Spurious Emission                | 15.247(d)/15.205/15.209 | PASS               | Hongbin Zhong |

Note:

- The measurement uncertainty is not included in the test result.
- \*1: No requirement on standard, only report these test data.

### 3. SUMMARY

#### 3.1. Client Information

|               |  |
|---------------|--|
| Applicant:    | XINCHUANGXIN INTERNATIONAL CO.,LTD   |
| Address:      | ROOM 605 6/F, FA YUEN COMMERCIAL BUILDING, 75-77 FA YUEN STREET MONGKOK KL   |
| Manufacturer: | Shenzhen Chiteng Technology Co.,LTD  |
| Address:      | Second Floor,Area A, Building 4, Huiye Technology Workshop, Guangang Road, Tangjia Community, Gongming Street, Guangming New District, Shenzhen, Guangdong |

#### 3.2. Product Description

| Main unit information:      |  |
|-----------------------------|--|
| Product Name:               | Smart Phone  |
| Trade Mark:                 | CORN   |
| Model No.:                  | P60  |
| Listed Model(s):            | -  |
| Power supply:               | DC 3.8V from Battery   |
| Hardware version:           | J527B-31EMB_D3_AF_V1.1   |
| Software version:           | CORN_P60_S62301A01_V01_20220531  |
| Accessory unit information: |  |
| Adapter information:        | Model: CS001<br>Input: 100-240Va.c., 50/60Hz 0.15A<br>Output: 5Vd.c., 1A |

#### 3.3. Radio Specification Description

|                                  |                 |
|----------------------------------|-----------------|
| Bluetooth version:               | V4.0            |
| Support function <sup>*2</sup> : | BLE             |
| Modulation:                      | GFSK            |
| Operation frequency:             | 2402MHz~2480MHz |
| Channel number:                  | 40              |
| Channel separation:              | 2MHz            |
| Antenna type:                    | Interna         |
| Antenna gain:                    | 1.1dBi          |

Note:

\*2: only show the RF function associated with this report.

### 3.4. Testing Laboratory Information

| Laboratory Name      | Shenzhen Huatongwei International Inspection Co., Ltd.  |                      |
|----------------------|---|----------------------|
| Laboratory Location  | 1/F, Bldg 3, Hongfa Hi-tech Industrial Park, Genyu Road, Tianliao, Gongming, Shenzhen, China  |                      |
| Connect information: | Phone: 86-755-26715499<br>E-mail: <a href="mailto:cs@szhtw.com.cn">cs@szhtw.com.cn</a><br><a href="http://www.szhtw.com.cn">http://www.szhtw.com.cn</a> |                      |
| Qualifications       | Type  | Accreditation Number |
|                      | FCC   | 762235               |

## 4. TEST CONFIGURATION

### 4.1. Test frequency list

According to section 15.31(m), regards to the operating frequency range over 10 MHz, must select three channels which were tested. The Lowest frequency, the middle frequency, and the highest frequency of channel were selected to perform the test, please see the below blue front.

| Channel | Frequency (MHz) |
|---------|-----------------|
| 00      | 2402            |
| 01      | 2404            |
| . . .   | . . .           |
| 19      | 2440            |
| . . .   | . . .           |
| 38      | 2478            |
| 39      | 2480            |

### 4.2. Descriptions of Test mode

|   |
|---|
| For RF test items   |
| The engineering test program was provided and enabled to make EUT continuous transmit.  |
| For Radiated spurious emissions:  |
| The engineering test program was provided and enabled to make EUT continuous transmit.<br>The EUT in each of three orthogonal axis emissions had been tested, but only the worst case (X axis) data Recorded in the report. |

### 4.3. Test sample information

| Test item               | HTW sample no.   |
|-------------------------|--|
| RF Conducted test items | Please refer to the description in the appendix report |
| RF Radiated test items  | YPHT22050324007  |
| EMI test items          | YPHT22050324007  |

Note:

RF Conducted test items: Peak Output Power, Power Spectral Density, 6dB Bandwidth, 99% Occupied Bandwidth, Duty cycle, Conducted Band Edge and Spurious Emission

RF Radiated test items: Radiated Band Edge Emission, Radiated Spurious Emission

EMI test items: AC Conducted Emission

#### 4.4. Support unit used in test configuration and system

The EUT has been associated with peripherals and configuration operated in a manner tended to maximize its emission characteristics in a typical application.

The following peripheral devices and interface cables were connected during the measurement:

| Whether support unit is used? |           |            |           |
|-------------------------------|-----------|------------|-----------|
| ✓ No                          |           |            |           |
| Item                          | Equipment | Trade Name | Model No. |
| 1                             |           |            |           |
| 2                             |           |            |           |

#### 4.5. Testing environmental condition

| Type               | Requirement  | Actual   |
|--------------------|--------------|----------|
| Temperature:       | 15~35°C      | 25°C     |
| Relative Humidity: | 25~75%       | 50%      |
| Air Pressure:      | 860~1060mbar | 1000mbar |

#### 4.6. Statement of the measurement uncertainty

| Test Item                            | Measurement Uncertainty           |
|--------------------------------------|-----------------------------------|
| AC Conducted Emission (150kHz~30MHz) | 3.00 dB                           |
| Radiated Emission (30MHz~1000MHz)    | 4.36 dB                           |
| Radiated Emissions (1GHz~25GHz)      | 5.10 dB                           |
| Peak Output Power                    | 0.77dB                            |
| Power Spectral Density               | 0.77dB                            |
| Conducted Spurious Emission          | 0.77dB                            |
| 6dB Bandwidth                        | 70Hz for <1GHz<br>130Hz for >1GHz |

This uncertainty represents an expanded uncertainty expressed at approximately the 95% confidence level using a coverage factor of k=1.96.



#### 4.7. Equipment Used during the Test

| ● Conducted Emission |                     |                    |               |                 |               |                           |                           |
|----------------------|---------------------|--------------------|---------------|-----------------|---------------|---------------------------|---------------------------|
| Used                 | Test Equipment      | Manufacturer       | Equipment No. | Model No.       | Serial No.    | Last Cal. Date (YY-MM-DD) | Next Cal. Date (YY-MM-DD) |
| ●                    | Shielded Room       | Albatross projects | HTWE0114      | N/A             | N/A           | 2018/09/28                | 2023/09/27                |
| ●                    | EMI Test Receiver   | R&S                | HTWE0111      | ESCI            | 101247        | 2021/09/14                | 2022/09/13                |
| ●                    | Artificial Mains    | SCHWARZBECK        | HTWE0113      | NNLK 8121       | 573           | 2021/09/17                | 2022/09/16                |
| ●                    | Pulse Limiter       | R&S                | HTWE0193      | ESH3-Z2         | 101447        | 2021/09/16                | 2022/09/15                |
| ●                    | RF Connection Cable | HUBER+SUHNER       | HTWE0113-02   | ENVIROFLE X_142 | EF-NM-BNCM-2M | 2021/09/17                | 2022/09/16                |
| ●                    | Test Software       | R&S                | N/A           | ES-K1           | N/A           | N/A                       | N/A                       |

| ○ Radiated emission-6th test site |                         |                    |               |             |            |                           |                           |
|-----------------------------------|-------------------------|--------------------|---------------|-------------|------------|---------------------------|---------------------------|
| Used                              | Test Equipment          | Manufacturer       | Equipment No. | Model No.   | Serial No. | Last Cal. Date (YY-MM-DD) | Next Cal. Date (YY-MM-DD) |
| ●                                 | Semi-Anechoic Chamber   | Albatross projects | HTWE0127      | SAC-3m-02   | C11121     | 2018/09/30                | 2022/09/29                |
| ●                                 | EMI Test Receiver       | R&S                | HTWE0099      | ESCI        | 100900     | 2021/09/14                | 2022/09/13                |
| ●                                 | Loop Antenna            | R&S                | HTWE0170      | HFH2-Z2     | 100020     | 2021/04/06                | 2024/04/05                |
| ●                                 | Ultra-Broadband Antenna | SCHWARZBECK        | HTWE0123      | VULB9163    | 538        | 2021/04/06                | 2024/04/05                |
| ●                                 | Pre-Amplifier           | SCHWARZBECK        | HTWE0295      | BBV 9742    | N/A        | 2021/11/05                | 2022/11/04                |
| ●                                 | RF Connection Cable     | HUBER+SUHNER       | HTWE0062-01   | N/A         | N/A        | 2022/02/25                | 2023/02/24                |
| ●                                 | RF Connection Cable     | HUBER+SUHNER       | HTWE0062-02   | SUCOFLEX104 | 501184/4   | 2022/02/25                | 2023/02/24                |
| ●                                 | Test Software           | R&S                | N/A           | ES-K1       | N/A        | N/A                       | N/A                       |

| ● Radiated emission-7th test site |                         |                    |               |                   |             |                           |                           |
|-----------------------------------|-------------------------|--------------------|---------------|-------------------|-------------|---------------------------|---------------------------|
| Used                              | Test Equipment          | Manufacturer       | Equipment No. | Model No.         | Serial No.  | Last Cal. Date (YY-MM-DD) | Next Cal. Date (YY-MM-DD) |
| ●                                 | Semi-Anechoic Chamber   | Albatross projects | HTWE0122      | SAC-3m-01         | C11121      | 2018/09/27                | 2022/09/26                |
| ●                                 | Spectrum Analyzer       | R&S                | HTWE0098      | FSP40             | 100597      | 2021/09/13                | 2022/09/12                |
| ●                                 | Horn Antenna            | SCHWARZBECK        | HTWE0126      | 9120D             | 1011        | 2020/04/01                | 2023/03/31                |
| ●                                 | Broadband Horn Antenna  | SCHWARZBECK        | HTWE0103      | BBHA9170          | BBHA9170472 | 2020/04/27                | 2023/04/26                |
| ●                                 | Pre-amplifier           | CD                 | HTWE0071      | PAP-0102          | 12004       | 2021/11/05                | 2022/11/04                |
| ●                                 | Broadband Pre-amplifier | SCHWARZBECK        | HTWE0201      | BBV 9718          | 9718-248    | 2022/02/28                | 2023/02/27                |
| ●                                 | RF Connection Cable     | HUBER+SUHNER       | HTWE0120-01   | 6m 18GHz S Serisa | N/A         | 2022/02/25                | 2023/02/24                |
| ●                                 | RF Connection Cable     | HUBER+SUHNER       | HTWE0120-02   | 6m 3GHz RG Serisa | N/A         | 2022/02/25                | 2023/02/24                |
| ●                                 | RF Connection Cable     | HUBER+SUHNER       | HTWE0119-05   | 6m 3GHz RG Serisa | N/A         | 2022/02/25                | 2023/02/24                |
| ●                                 | RF Connection Cable     | HUBER+SUHNER       | HTWE0120-04   | 6m 3GHz RG Serisa | N/A         | 2022/02/25                | 2023/02/24                |
| ●                                 | Test Software           | Audix              | N/A           | E3                | N/A         | N/A                       | N/A                       |

| Used | Test Equipment               | Manufacturer | Equipment No. | Model No. | Serial No. | Last Cal. Date (YY-MM-DD) | Next Cal. Date (YY-MM-DD) |
|------|------------------------------|--------------|---------------|-----------|------------|---------------------------|---------------------------|
| ●    | Signal and spectrum Analyzer | R&S          | HTWE0242      | FSV40     | 100048     | 2021/09/13                | 2022/09/12                |
| ●    | Signal & Spectrum Analyzer   | R&S          | HTWE0262      | FSW26     | 103440     | 2021/09/13                | 2022/09/12                |
| ●    | Spectrum Analyzer            | Agilent      | HTWE0286      | N9020A    | MY50510187 | 2021/09/13                | 2022/09/12                |
| ●    | Radio communication tester   | R&S          | HTWE0287      | CMW500    | 137688-Lv  | 2021/09/13                | 2022/09/12                |
| ●    | Test software                | Tonscend     | N/A           | JS1120    | N/A        | N/A                       | N/A                       |

## 5. TEST CONDITIONS AND RESULTS

### 5.1. Antenna Requirement

#### REQUIREMENT

##### **FCC CFR Title 47 Part 15 Subpart C Section 15.203:**

An intentional radiator shall be designed to ensure that no antenna other than that furnished by the responsible party shall be used with the device. The use of a permanently attached antenna or of an antenna that uses a unique coupling to the intentional radiator, the manufacturer may design the unit so that a broken antenna can be replaced by the user, but the use of a standard antenna jack or electrical connector is prohibited.

##### **FCC CFR Title 47 Part 15 Subpart C Section 15.247(c) (1)(i):**

(i) Systems operating in the 2400-2483.5 MHz band that is used exclusively for fixed. Point-to-point operations may employ transmitting antennas with directional gain greater than 6 dBi provided the maximum conducted output power of the intentional radiator is reduced by 1 dB for every 3 dB that the directional gain of the antenna exceeds 6 dBi.

#### TEST RESULT

**Passed**       **Not Applicable**

The antenna type is a Interna antenna, the directional gain of the antenna less than 6 dBi, please refer to the below antenna photo.

!

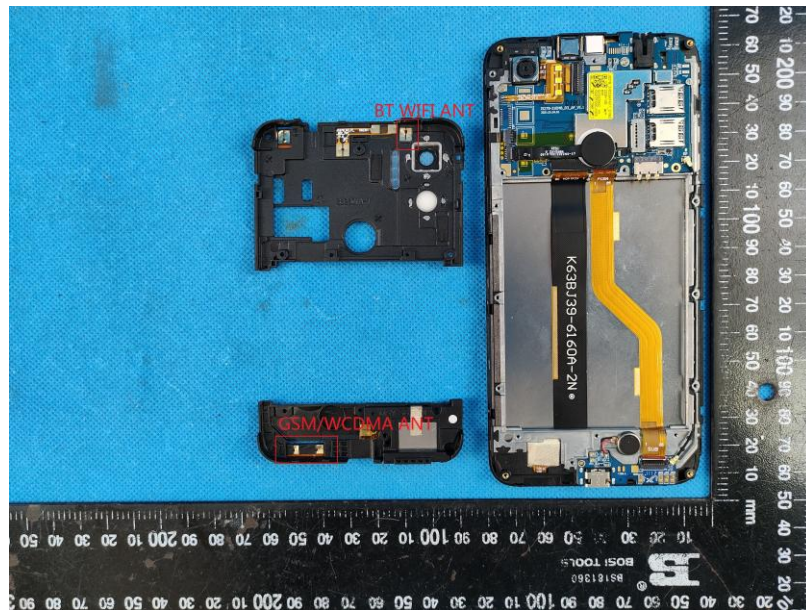

## 5.2. AC Conducted Emission

### LIMIT

#### FCC CFR Title 47 Part 15 Subpart C Section 15.207

| Frequency range (MHz) | Limit (dBuV) |           |
|-----------------------|--------------|-----------|
|                       | Quasi-peak   | Average   |
| 0.15-0.5              | 66 to 56*    | 56 to 46* |
| 0.5-5                 | 56           | 46        |
| 5-30                  | 60           | 50        |

\* Decreases with the logarithm of the frequency.

### TEST CONFIGURATION

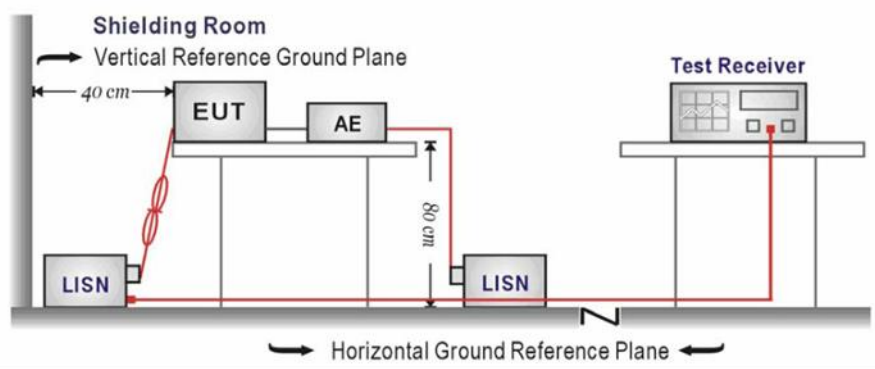

### TEST PROCEDURE

1. The EUT was setup according to ANSI C63.10 requirements.
2. The EUT was placed on a platform of nominal size, 1 m by 1.5 m, raised 80 cm above the conducting ground plane. The vertical conducting plane was located 40 cm to the rear of the EUT. All other surfaces of EUT were at least 80 cm from any other grounded conducting surface.
3. The EUT and simulators are connected to the main power through a line impedances stabilization network (LISN). The LISN provides a 50 ohm /50uH coupling impedance for the measuring equipment.
4. The peripheral devices are also connected to the main power through a LISN. (Please refer to the block diagram of the test setup and photographs)
5. Each current-carrying conductor of the EUT power cord, except the ground (safety) conductor, was individually connected through a LISN to the input power source.
6. The excess length of the power cord between the EUT and the LISN receptacle were folded back and forth at the center of the lead to form a bundle not exceeding 40 cm in length.
7. Conducted emissions were investigated over the frequency range from 0.15MHz to 30MHz using a receiver bandwidth of 9 kHz.
8. During the above scans, the emissions were maximized by cable manipulation.

### TEST MODE

Please refer to the clause 4.2

### TEST RESULT

Passed       Not Applicable

Test Line:

L

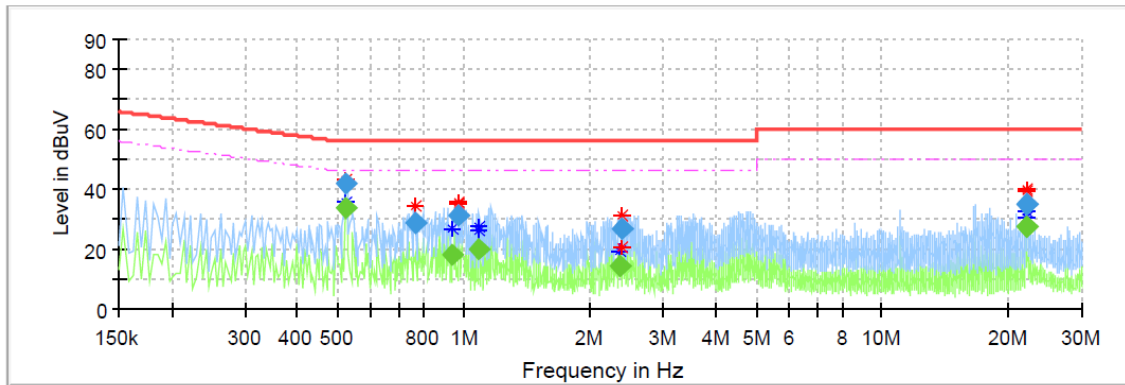

| Frequency (MHz) | QuasiPeak (dBuV) | CAverage (dBuV) | Limit (dBuV) | Margin (dB) | Line | Corr. (dB) |
|-----------------|------------------|-----------------|--------------|-------------|------|------------|
| 0.523500        | 41.73            | ---             | 56.00        | 14.27       | L1   | 10.1       |
| 0.523500        | ---              | 33.59           | 46.00        | 12.41       | L1   | 10.1       |
| 0.763500        | 28.68            | ---             | 56.00        | 27.32       | L1   | 10.2       |
| 0.939500        | ---              | 18.29           | 46.00        | 27.71       | L1   | 10.1       |
| 0.967500        | 31.34            | ---             | 56.00        | 24.66       | L1   | 10.1       |
| 1.091500        | ---              | 20.11           | 46.00        | 25.89       | L1   | 10.1       |
| 2.367500        | ---              | 14.37           | 46.00        | 31.63       | L1   | 10.2       |
| 2.399500        | 26.62            | ---             | 56.00        | 29.38       | L1   | 10.2       |
| 22.051500       | 34.82            | ---             | 60.00        | 25.18       | L1   | 10.9       |
| 22.055500       | ---              | 27.40           | 50.00        | 22.60       | L1   | 10.9       |
| 22.059500       | ---              | 27.62           | 50.00        | 22.38       | L1   | 10.9       |
| 22.071500       | 35.13            | ---             | 60.00        | 24.87       | L1   | 10.9       |

Test Line:

N

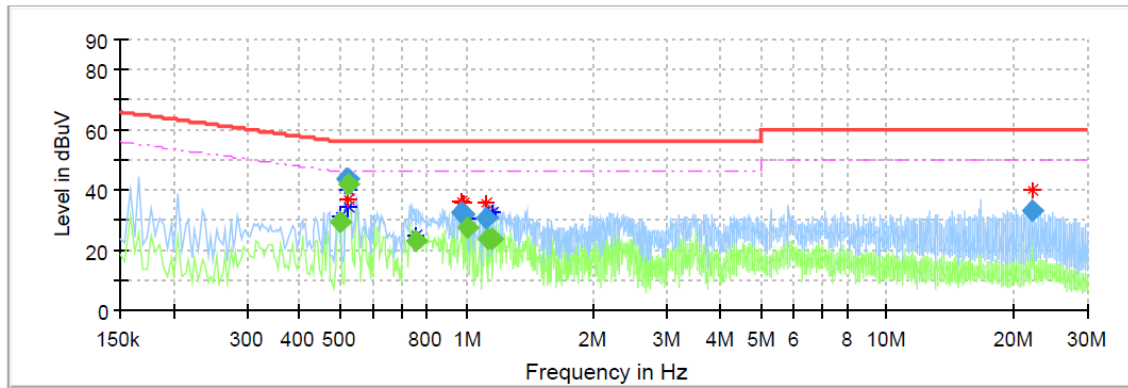

| Frequency (MHz) | QuasiPeak (dBuV) | CAverage (dBuV) | Limit (dBuV) | Margin (dB) | Line | Corr. (dB) |
|-----------------|------------------|-----------------|--------------|-------------|------|------------|
| 0.499500        | ---              | 29.35           | 46.01        | 16.66       | N    | 10.1       |
| 0.519500        | 43.88            | ---             | 56.00        | 12.12       | N    | 10.1       |
| 0.523500        | 43.90            | ---             | 56.00        | 12.10       | N    | 10.1       |
| 0.523500        | ---              | 41.61           | 46.00        | 4.39        | N    | 10.1       |
| 0.755500        | ---              | 23.18           | 46.00        | 22.82       | N    | 10.2       |
| 0.971500        | 32.57            | ---             | 56.00        | 23.43       | N    | 10.1       |
| 0.979500        | 31.98            | ---             | 56.00        | 24.02       | N    | 10.1       |
| 0.999500        | ---              | 27.51           | 46.00        | 18.49       | N    | 10.1       |
| 1.115500        | 30.75            | ---             | 56.00        | 25.25       | N    | 10.1       |
| 1.123500        | ---              | 23.72           | 46.00        | 22.28       | N    | 10.1       |
| 1.152500        | ---              | 23.89           | 46.00        | 22.11       | N    | 10.1       |
| 22.051500       | 33.11            | ---             | 60.00        | 26.89       | N    | 10.7       |

### 5.3. Peak Output Power

#### LIMIT

FCC CFR Title 47 Part 15 Subpart C Section 15.247 (b)(3): 30dBm

#### TEST CONFIGURATION

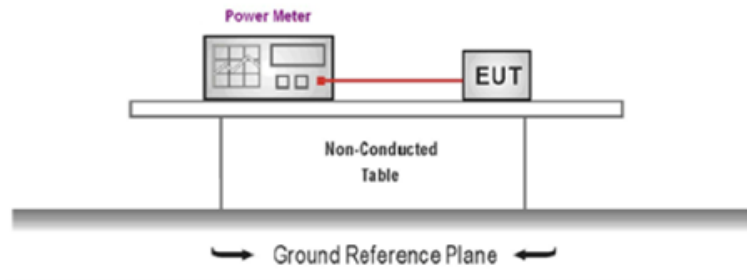

#### TEST PROCEDURE

1. The EUT was tested according to ANSI C63.10 and KDB 558074 D01 requirements.
2. The maximum peak conducted output power may be measured using a broadband peak RF power meter.
3. The power meter shall have a video bandwidth that is greater than or equal to the DTS bandwidth and shall utilize a fast-responding diode detector.
4. Record the measurement data.

#### TEST MODE

Please refer to the clause 4.2

#### TEST RESULT

Passed       Not Applicable

#### TEST DATA

Please refer to appendix A on the appendix report

## 5.4. Power Spectral Density

### LIMIT

#### FCC CFR Title 47 Part 15 Subpart C Section 15.247 (e):

For digitally modulated systems, the power spectral density conducted from the intentional radiator to the antenna shall not be greater than 8dBm in any 3 kHz band during any time interval of continuous transmission.

### TEST CONFIGURATION

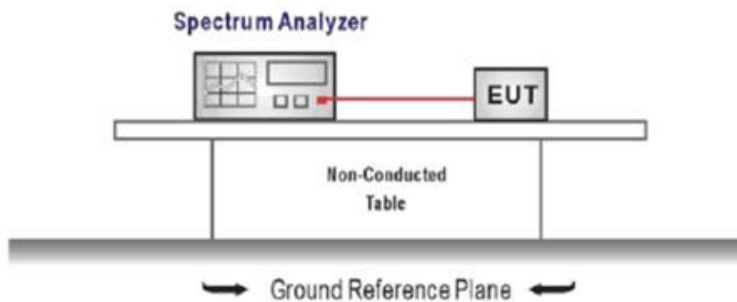

### TEST PROCEDURE

1. Connect the antenna port(s) to the spectrum analyzer input,
2. Configure the spectrum analyzer as shown below:  
Center frequency=DTS channel center frequency  
Span =1.5 times the DTS bandwidth  
RBW = 3 kHz ≤ RBW ≤ 100 kHz, VBW ≥ 3 × RBW  
Sweep time = auto couple  
Detector = peak  
Trace mode = max hold
3. Place the radio in continuous transmit mode, allow the trace to stabilize, view the transmitter wave form on the spectrum analyzer.
4. Use the peak marker function to determine the maximum amplitude level within the RBW.
5. If measured value exceeds limit, reduce RBW (no less than 3 kHz) and repeat.

### TEST MODE

Please refer to the clause 4.2

### TEST RESULT

Passed       Not Applicable

### TEST DATA

Please refer to appendix B on the appendix report



## 5.5. 6dB bandwidth

### LIMIT

#### FCC CFR Title 47 Part 15 Subpart C Section 15.247 (a)(2):

For digital modulation systems, the minimum 6 dB bandwidth shall be at least 500 kHz.

### TEST CONFIGURATION

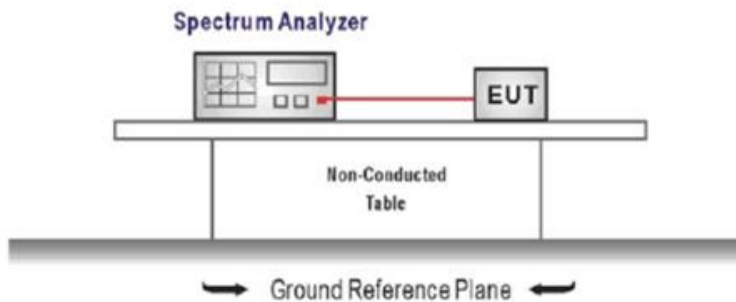

### TEST PROCEDURE

1. Connect the antenna port(s) to the spectrum analyzer input.
2. Configure the spectrum analyzer as shown below (enter all losses between the transmitter output and the spectrum analyzer).  
Center Frequency =DTS channel center frequency  
Span=2 x DTS bandwidth  
RBW = 100 kHz, VBW  $\geq$  3 x RBW  
Sweep time= auto couple  
Detector = Peak  
Trace mode = max hold
3. Place the radio in continuous transmit mode, allow the trace to stabilize, view the transmitter waveform on the spectrum analyzer.
4. Measure the maximum width of the emission that is constrained by the frequencies associated with the two outermost amplitude points (upper and lower frequencies) that are attenuated by 6 dB relative to the maximum level measured in the fundamental emission, and record the pertinent measurements.

### TEST MODE

Please refer to the clause 4.2

### TEST RESULT

Passed       Not Applicable

### TEST DATA

Please refer to appendix C on the appendix report

## 5.6. 99% Occupied Bandwidth

### LIMIT

N/A

### TEST CONFIGURATION

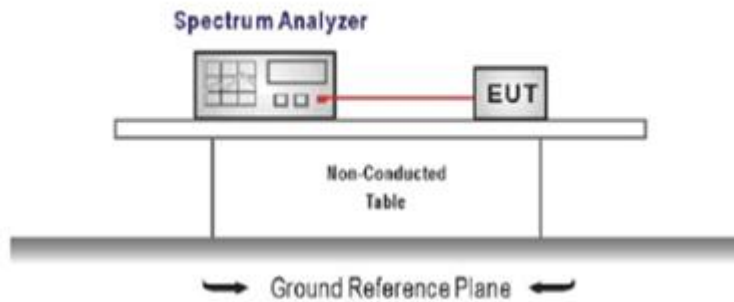

### TEST PROCEDURE

1. Connect the antenna port(s) to the spectrum analyzer input.
2. Configure the spectrum analyzer as shown below (enter all losses between the transmitter output and the spectrum analyzer).  
Center Frequency = channel center frequency  
Span  $\geq 1.5 \times$  OBW  
RBW = 1%~5%OBW  
VBW  $\geq 3 \times$  RBW  
Sweep time = auto couple  
Detector = Peak  
Trace mode = max hold
3. Place the radio in continuous transmit mode, allow the trace to stabilize, view the transmitter waveform on the spectrum analyzer.

### TEST MODE

Please refer to the clause 4.2

### TEST RESULT

Passed       Not Applicable

### TEST DATA

Please refer to appendix D on the appendix report

## 5.7. Duty Cycle

### LIMIT

N/A

### TEST CONFIGURATION

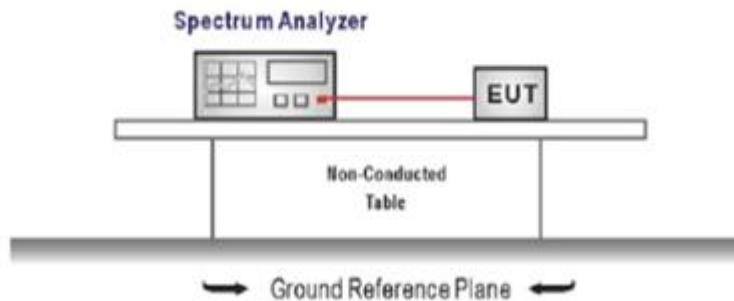

### TEST PROCEDURE

1. The transmitter output was connected to the spectrum analyzer through an attenuator, the path loss was compensated to the results for each measurement.
2. Set to the maximum power setting and enable the EUT transmit continuously
3. Use the following spectrum analyzer settings:  
Span=zero span, Frequency=centered channel, RBW= 1 MHz, VBW  $\geq$  RBW  
Sweep=as necessary to capture the entire dwell time,  
Detector function = peak, Trigger mode
4. Measure and record the duty cycle data

### TEST MODE

Please refer to the clause 4.2

### TEST DATA

Please refer to appendix E on the appendix report

## 5.8. Conducted Band edge and Spurious Emission

### LIMIT

**FCC CFR Title 47 Part 15 Subpart C Section 15.247 (d):** In any 100 kHz bandwidth outside the frequency band in which the spread spectrum intentional radiator is operating, the radio frequency power that is produced by the intentional radiator shall be at least 20 dB below that in the 100 kHz bandwidth within the band that contains the highest level of the desired power, based on either an RF conducted or a radiated measurement.

### TEST CONFIGURATION

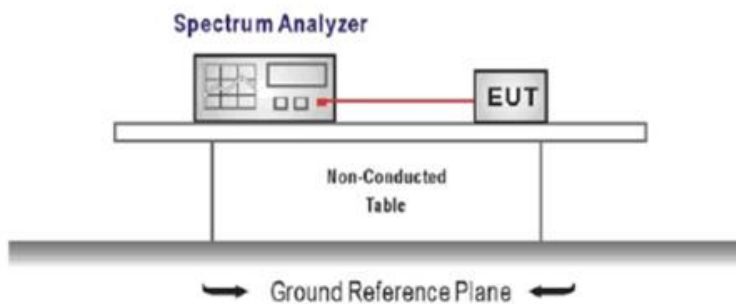

### TEST PROCEDURE

1. Connect the antenna port(s) to the spectrum analyzer input.
2. Emission level measurement  
Set the center frequency and span to encompass frequency range to be measured  
RBW = 100 kHz, VBW  $\geq 3 \times$  RBW  
Detector = peak, Sweep time = auto couple, Trace mode = max hold  
Allow trace to fully stabilize  
Use the peak marker function to determine the maximum amplitude level.
3. Place the radio in continuous transmit mode, allow the trace to stabilize, view the transmitter waveform on the spectrum analyzer.
4. Ensure that the amplitude of all unwanted emission outside of the authorized frequency band excluding restricted frequency bands) are attenuated by at least the minimum requirements specified (at least 20 dB relative to the maximum in-band peak PSD level in 100 kHz). Report the three highest emission relative to the limit.

### TEST MODE

Please refer to the clause 4.2

### TEST RESULT

Passed       Not Applicable

### TEST DATA

Please refer to appendix F on the appendix report

## 5.9. Radiated Band edge Emission

### LIMIT

#### FCC CFR Title 47 Part 15 Subpart C Section 15.247 (d):

In any 100 kHz bandwidth outside the frequency band in which the spread spectrum or digitally modulated intentional radiator is operating, Radiated Emissions which fall in the restricted bands, as defined in §15.205(a), must also comply with the Radiated Emissions limits specified in §15.209(a) (see §15.205(c)).

### TEST CONFIGURATION

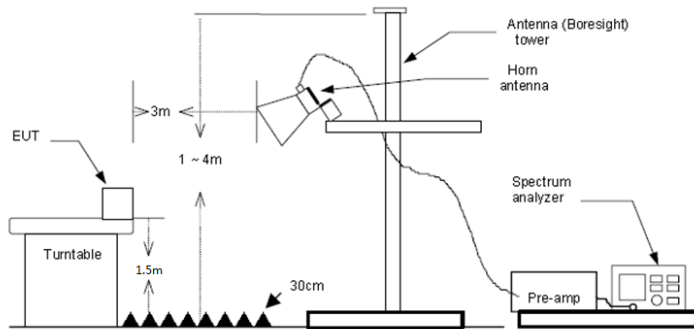

### TEST PROCEDURE

1. The EUT was setup and tested according to ANSI C63.10 .
2. The EUT is placed on a turn table which is 1.5 meter above ground. The turn table is rotated 360 degrees to determine the position of the maximum emission level.
3. The EUT was positioned such that the distance from antenna to the EUT was 3 meters.
4. The antenna is scanned from 1 meter to 4 meters to find out the maximum emission level. This is repeated for both horizontal and vertical polarization of the antenna. In order to find the maximum emission, all of the interface cables were manipulated according to ANSI C63.10 on radiated measurement.
5. Use the following spectrum analyzer settings:
  - a) Span shall wide enough to fully capture the emission being measured
  - b) Set RBW=100kHz for <1GHz, VBW=3\*RBW, Sweep time=auto, Detector=peak, Trace=max hold
  - c) Set RBW=1MHz, VBW=3MHz for >1GHz, Sweep time=auto, Detector=peak, Trace=max hold for Peak measurement

For average measurement:

  - VBW=10Hz, When duty cycle is no less than 98 percent
  - VBW $\geq$ 1/T, when duty cycle is less than 98 percent where T is the minimum transmission duration over which the transmitter is on and is transmitting at its maximum power control level for the tested mode of operation, so refer to this clause 5.6 duty cycle.

### TEST MODE

Please refer to the clause 4.2

### TEST RESULT

Passed       Not Applicable

Note:

- 1) Level= Reading + Factor; Factor =Antenna Factor+ Cable Loss- Preamp Factor
- 2) Over Limit = Level- Limit
- 3) Average measurement was not performed if peak level is lower than average limit(54 dBuV/m).

| Test channel |                  | CH00              |               |             | Polarity     |                 |                 | Horizontal    |        |  |
|--------------|------------------|-------------------|---------------|-------------|--------------|-----------------|-----------------|---------------|--------|--|
| Mark         | Frequency<br>MHz | Reading<br>dBuV/m | Antenna<br>dB | Cable<br>dB | Preamp<br>dB | Level<br>dBuV/m | Limit<br>dBuV/m | Over<br>limit | Remark |  |
| 1            | 2310.00          | 39.70             | 27.96         | 5.43        | 37.56        | 35.53           | 74.00           | -38.47        | Peak   |  |
| 2            | 2390.03          | 39.68             | 27.72         | 5.53        | 37.45        | 35.48           | 74.00           | -38.52        | Peak   |  |

| Test channel |                  | CH00              |               |             | Polarity     |                 |                 | Vertical      |        |  |
|--------------|------------------|-------------------|---------------|-------------|--------------|-----------------|-----------------|---------------|--------|--|
| Mark         | Frequency<br>MHz | Reading<br>dBuV/m | Antenna<br>dB | Cable<br>dB | Preamp<br>dB | Level<br>dBuV/m | Limit<br>dBuV/m | Over<br>limit | Remark |  |
| 1            | 2310.00          | 39.45             | 27.96         | 5.43        | 37.56        | 35.28           | 74.00           | -38.72        | Peak   |  |
| 2            | 2390.03          | 40.19             | 27.72         | 5.53        | 37.45        | 35.99           | 74.00           | -38.01        | Peak   |  |

| Test channel |                  | CH39              |               |             | Polarity     |                 |                 | Horizontal    |        |  |
|--------------|------------------|-------------------|---------------|-------------|--------------|-----------------|-----------------|---------------|--------|--|
| Mark         | Frequency<br>MHz | Reading<br>dBuV/m | Antenna<br>dB | Cable<br>dB | Preamp<br>dB | Level<br>dBuV/m | Limit<br>dBuV/m | Over<br>limit | Remark |  |
| 1            | 2483.50          | 47.96             | 27.43         | 5.64        | 37.26        | 43.77           | 74.00           | -30.23        | Peak   |  |
| 2            | 2500.00          | 39.35             | 27.40         | 5.66        | 37.26        | 35.15           | 74.00           | -38.85        | Peak   |  |

| Test channel |                  | CH39              |               |             | Polarity     |                 |                 | Vertical      |        |  |
|--------------|------------------|-------------------|---------------|-------------|--------------|-----------------|-----------------|---------------|--------|--|
| Mark         | Frequency<br>MHz | Reading<br>dBuV/m | Antenna<br>dB | Cable<br>dB | Preamp<br>dB | Level<br>dBuV/m | Limit<br>dBuV/m | Over<br>limit | Remark |  |
| 1            | 2483.50          | 52.54             | 27.43         | 5.64        | 37.26        | 48.35           | 74.00           | -25.65        | Peak   |  |
| 2            | 2500.00          | 40.69             | 27.40         | 5.66        | 37.26        | 36.49           | 74.00           | -37.51        | Peak   |  |

### 5.10. Radiated Spurious Emission

**LIMIT**

**FCC CFR Title 47 Part 15 Subpart C Section 15.209**

| Frequency            | Limit (dBuV/m)    | Value      |
|----------------------|-------------------|------------|
| 0.009 MHz ~0.49 MHz  | 2400/F(kHz) @300m | Quasi-peak |
| 0.49 MHz ~ 1.705 MHz | 24000/F(kHz) @30m | Quasi-peak |
| 1.705 MHz ~30 MHz    | 30 @30m           | Quasi-peak |

Note: Limit dBuV/m @3m = Limit dBuV/m @300m + 40\*log(300/3)= Limit dBuV/m @300m +80,  
 Limit dBuV/m @3m = Limit dBuV/m @30m +40\*log(30/3)= Limit dBuV/m @30m + 40.

| Frequency     | Limit (dBuV/m @3m) | Value      |
|---------------|--------------------|------------|
| 30MHz~88MHz   | 40.00              | Quasi-peak |
| 88MHz~216MHz  | 43.50              | Quasi-peak |
| 216MHz~960MHz | 46.00              | Quasi-peak |
| 960MHz~1GHz   | 54.00              | Quasi-peak |
| Above 1GHz    | 54.00              | Average    |
|               | 74.00              | Peak       |

**TEST CONFIGURATION**

- 9 kHz ~ 30 MHz

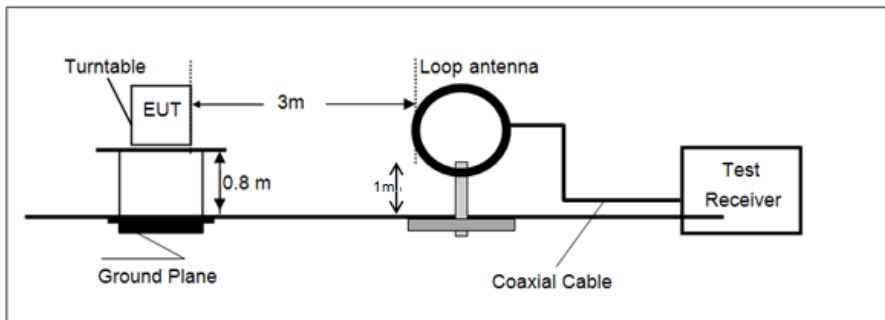

- 30 MHz ~ 1 GHz

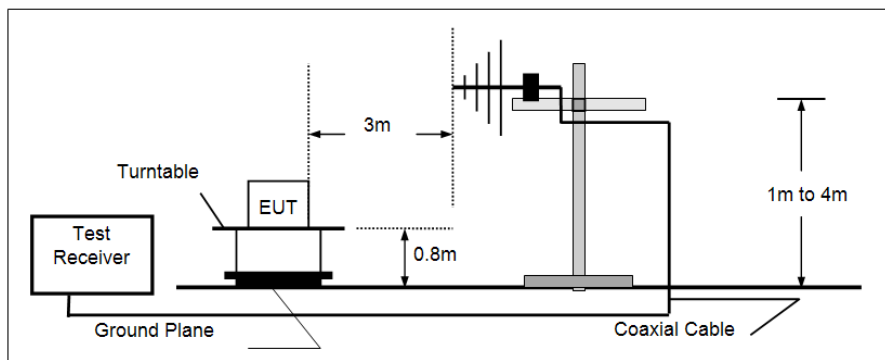

- Above 1 GHz

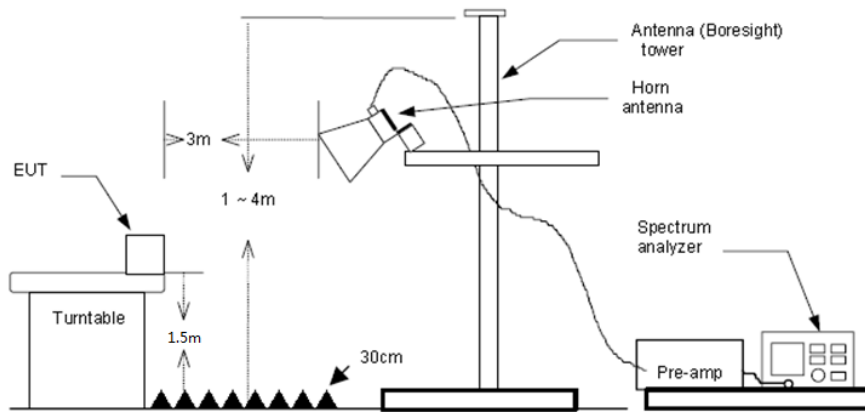

### **TEST PROCEDURE**

1. The EUT was setup and tested according to ANSI C63.10 .
2. The EUT is placed on a turn table which is 0.8 meter above ground for below 1 GHz, and 1.5 m for above 1 GHz. The turn table is rotated 360 degrees to determine the position of the maximum emission level.
3. The EUT was set 3 meters from the receiving antenna, which was mounted on the top of a variable height antenna tower.
4. For each suspected emission, the EUT was arranged to its worst case and then tune the Antenna tower (from 1 m to 4 m) and turntable (from 0 degree to 360 degrees) to find the maximum reading. A pre-amp and a high pass filter are used for the test in order to get better signal level to comply with the guidelines.
5. Set to the maximum power setting and enable the EUT transmit continuously.
6. Use the following spectrum analyzer settings
  - a) Span shall wide enough to fully capture the emission being measured;
  - b) Below 1 GHz:
    - RBW=120 kHz, VBW=300 kHz, Sweep=auto, Detector function=peak, Trace=max hold;
    - If the emission level of the EUT measured by the peak detector is 3 dB lower than the applicable limit, the peak emission level will be reported. Otherwise, the emission measurement will be repeated using the quasi-peak detector and reported.
  - c) Set RBW=1MHz, VBW=3MHz for >1GHz, Sweep time=auto, Detector=peak, Trace=max hold for Peak measurement
    - For average measurement:
      - VBW=10Hz, When duty cycle is no less than 98 percent
      - $VBW \geq 1/T$ , when duty cycle is less than 98 percent where T is the minimum transmission duration over which the transmitter is on and is transmitting at its maximum power control level for the tested mode of operation, so refer to this clause 5.6 duty cycle.

### **TEST MODE**

Please refer to the clause 4.2

### **TEST RESULT**

**Passed**       **Not Applicable**

Note:

- 1) Level= Reading + Factor/Transd; Factor/Transd =Antenna Factor+ Cable Loss- Preamp Factor
- 2) Over Limit = Level– Limit
- 3) Average measurement was not performed if peak level is lower than average limit(54 dBuV/m) for above 1GHz.



**For 9 kHz ~ 30 MHz**

The EUT was pre-scanned this frequency band, found the radiated level 20dB lower than the limit, so don't show data on this report.

**For 30 MHz ~ 1000 MHz**

Have pre-scan all test channel, found CH39 which it was worst case, so only show the worst case's data on this report.

Polarization:

Horizontal

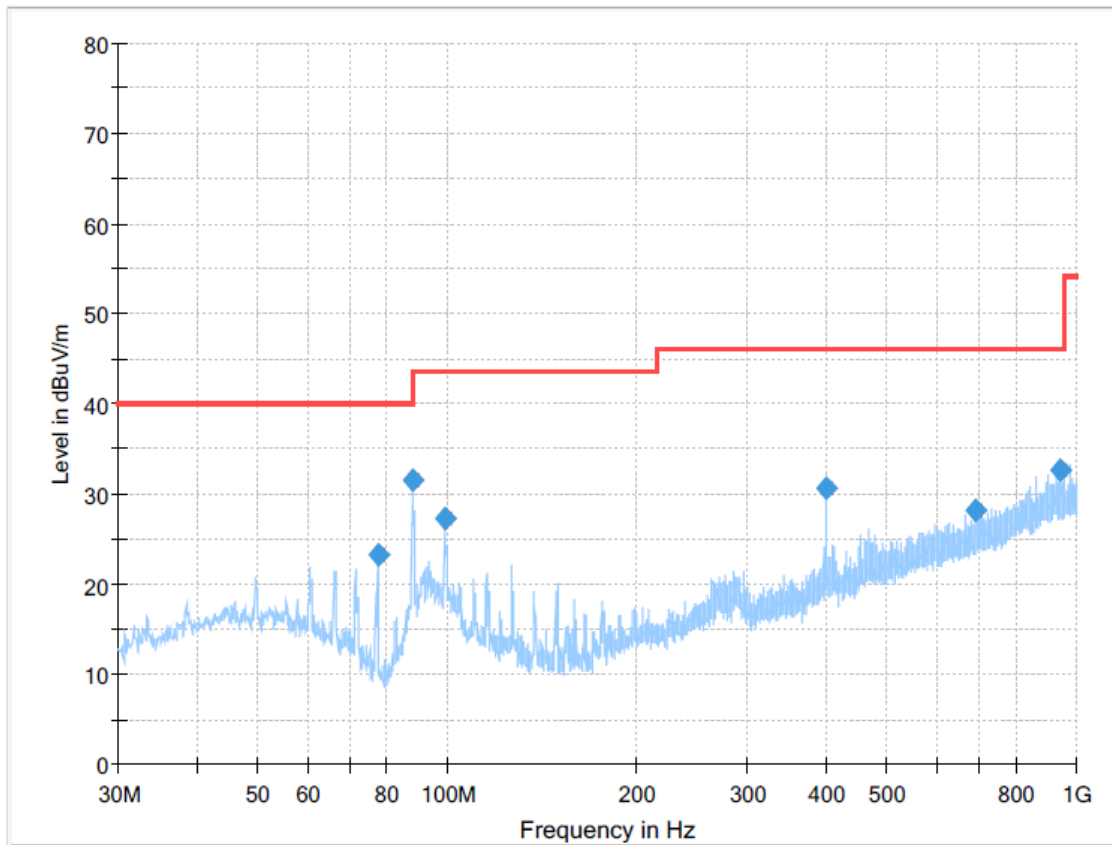

| Frequency (MHz) | QP (dBuV/m) | Limit (dBuV/m) | Margin (dB) | Height (cm) | Pol | Azimuth (deg) | Corr. (dB/m) |
|-----------------|-------------|----------------|-------------|-------------|-----|---------------|--------------|
| 77.530000       | 23.16       | 40.00          | 16.84       | 300.0       | H   | 274.0         | -15.2        |
| 87.957500       | 31.59       | 40.00          | 8.41        | 300.0       | H   | 156.0         | -13.3        |
| 98.991250       | 27.27       | 43.50          | 16.23       | 300.0       | H   | 156.0         | -10.9        |
| 400.055000      | 30.62       | 46.00          | 15.38       | 100.0       | H   | 359.0         | -4.2         |
| 690.448750      | 28.16       | 46.00          | 17.84       | 100.0       | H   | 36.0          | 2.3          |
| 940.708750      | 32.52       | 46.00          | 13.48       | 300.0       | H   | 338.0         | 7.5          |

Polarization:

Vertical

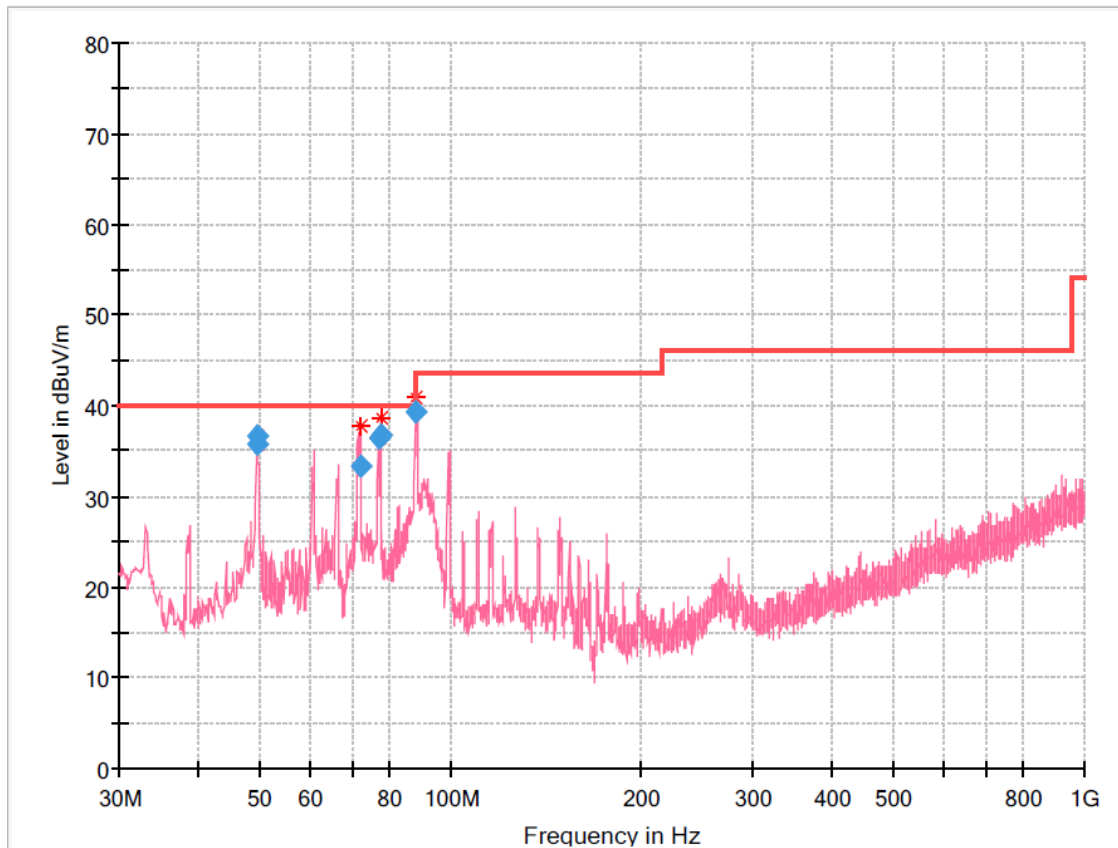

| Frequency (MHz) | QP (dBuV/m) | Limit (dBuV/m) | Margin (dB) | Height (cm) | Pol | Azimuth (deg) | Corr. (dB/m) |
|-----------------|-------------|----------------|-------------|-------------|-----|---------------|--------------|
| 49.400000       | 35.82       | 40.00          | 4.18        | 100.0       | V   | 359.0         | -9.1         |
| 49.521250       | 36.59       | 40.00          | 3.41        | 100.0       | V   | 359.0         | -9.1         |
| 71.952500       | 33.44       | 40.00          | 6.56        | 100.0       | V   | 239.0         | -13.7        |
| 76.923750       | 36.42       | 40.00          | 3.58        | 100.0       | V   | 279.0         | -15.1        |
| 77.530000       | 36.46       | 40.00          | 3.54        | 100.0       | V   | 279.0         | -15.2        |
| 87.957500       | 39.11       | 40.00          | 4.39        | 100.0       | V   | 254.0         | -13.3        |

**For 1 GHz ~ 25 GHz**

| Test channel |               | CH00           |            |          | Polarity  |              | Horizontal   |            |        |
|--------------|---------------|----------------|------------|----------|-----------|--------------|--------------|------------|--------|
| Mark         | Frequency MHz | Reading dBuV/m | Antenna dB | Cable dB | Preamp dB | Level dBuV/m | Limit dBuV/m | Over limit | Remark |
| 1            | 2252.13       | 39.10          | 28.10      | 5.37     | 37.42     | 35.15        | 74.00        | -38.85     | Peak   |
| 2            | 2839.65       | 39.49          | 28.56      | 6.08     | 37.31     | 36.82        | 74.00        | -37.18     | Peak   |
| 3            | 4804.28       | 37.41          | 31.40      | 8.46     | 35.29     | 41.98        | 74.00        | -32.02     | Peak   |
| 4            | 7586.26       | 33.51          | 36.43      | 10.39    | 33.29     | 47.04        | 74.00        | -26.96     | Peak   |

| Test channel |               | CH00           |            |          | Polarity  |              | Vertical     |            |        |
|--------------|---------------|----------------|------------|----------|-----------|--------------|--------------|------------|--------|
| Mark         | Frequency MHz | Reading dBuV/m | Antenna dB | Cable dB | Preamp dB | Level dBuV/m | Limit dBuV/m | Over limit | Remark |
| 1            | 2332.71       | 40.04          | 27.87      | 5.46     | 37.54     | 35.83        | 74.00        | -38.17     | Peak   |
| 2            | 2905.93       | 39.42          | 28.61      | 6.13     | 37.40     | 36.76        | 74.00        | -37.24     | Peak   |
| 3            | 5054.44       | 36.00          | 32.20      | 8.88     | 35.39     | 41.69        | 74.00        | -32.31     | Peak   |
| 4            | 7423.01       | 33.32          | 36.60      | 10.31    | 33.99     | 46.24        | 74.00        | -27.76     | Peak   |

| Test channel |               | CH19           |            |          | Polarity  |              | Horizontal   |            |        |
|--------------|---------------|----------------|------------|----------|-----------|--------------|--------------|------------|--------|
| Mark         | Frequency MHz | Reading dBuV/m | Antenna dB | Cable dB | Preamp dB | Level dBuV/m | Limit dBuV/m | Over limit | Remark |
| 1            | 2252.13       | 39.10          | 28.10      | 5.37     | 37.42     | 35.15        | 74.00        | -38.85     | Peak   |
| 2            | 2839.65       | 39.49          | 28.56      | 6.08     | 37.31     | 36.82        | 74.00        | -37.18     | Peak   |
| 3            | 4881.54       | 37.61          | 31.40      | 8.66     | 35.18     | 42.49        | 74.00        | -31.51     | Peak   |
| 4            | 7992.86       | 34.25          | 37.07      | 10.90    | 33.31     | 48.91        | 74.00        | -25.09     | Peak   |

| Test channel |               | CH19           |            |          | Polarity  |              | Vertical     |            |        |
|--------------|---------------|----------------|------------|----------|-----------|--------------|--------------|------------|--------|
| Mark         | Frequency MHz | Reading dBuV/m | Antenna dB | Cable dB | Preamp dB | Level dBuV/m | Limit dBuV/m | Over limit | Remark |
| 1            | 2332.71       | 40.04          | 27.87      | 5.46     | 37.54     | 35.83        | 74.00        | -38.17     | Peak   |
| 2            | 2905.93       | 39.42          | 28.61      | 6.13     | 37.40     | 36.76        | 74.00        | -37.24     | Peak   |
| 3            | 5538.00       | 36.05          | 31.82      | 9.37     | 35.26     | 41.98        | 74.00        | -32.02     | Peak   |
| 4            | 8074.41       | 34.02          | 37.20      | 11.12    | 33.32     | 49.02        | 74.00        | -24.98     | Peak   |

| Test channel |               | CH39           |            |          | Polarity  |              | Horizontal   |            |        |
|--------------|---------------|----------------|------------|----------|-----------|--------------|--------------|------------|--------|
| Mark         | Frequency MHz | Reading dBuV/m | Antenna dB | Cable dB | Preamp dB | Level dBuV/m | Limit dBuV/m | Over limit | Remark |
| 1            | 2252.13       | 39.10          | 28.10      | 5.37     | 37.42     | 35.15        | 74.00        | -38.85     | Peak   |
| 2            | 2839.65       | 39.49          | 28.56      | 6.08     | 37.31     | 36.82        | 74.00        | -37.18     | Peak   |
| 3            | 4960.04       | 36.42          | 31.58      | 8.77     | 35.21     | 41.56        | 74.00        | -32.44     | Peak   |
| 4            | 8039.36       | 34.14          | 37.18      | 11.01    | 33.31     | 49.02        | 74.00        | -24.98     | Peak   |

| Test channel |               | CH39           |            |          | Polarity  |              | Vertical     |            |        |
|--------------|---------------|----------------|------------|----------|-----------|--------------|--------------|------------|--------|
| Mark         | Frequency MHz | Reading dBuV/m | Antenna dB | Cable dB | Preamp dB | Level dBuV/m | Limit dBuV/m | Over limit | Remark |
| 1            | 2332.71       | 40.04          | 27.87      | 5.46     | 37.54     | 35.83        | 74.00        | -38.17     | Peak   |
| 2            | 2905.93       | 39.42          | 28.61      | 6.13     | 37.40     | 36.76        | 74.00        | -37.24     | Peak   |
| 3            | 5032.50       | 36.59          | 32.10      | 8.85     | 35.33     | 42.21        | 74.00        | -31.79     | Peak   |
| 4            | 8016.07       | 33.85          | 37.13      | 10.93    | 33.31     | 48.60        | 74.00        | -25.40     | Peak   |

## 6. TEST SETUP PHOTOS

Radiated Emission

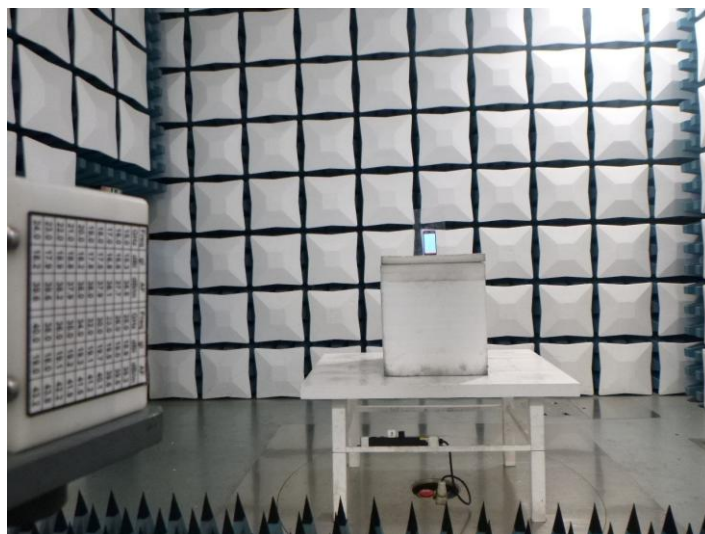
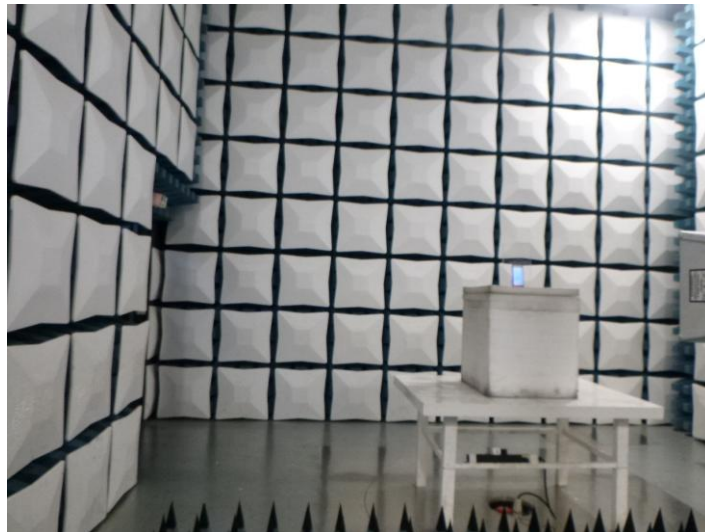

AC Conducted Emission



## **7. EXTERNAL AND INTERNAL PHOTOS**

Refer to the test report No.: CHTEW22060005

## **8. APPENDIX REPORT**

# APPENDIX REPORT

|                 |                 |                     |               |
|-----------------|-----------------|---------------------|---------------|
| Project No.     | SHT2205032403EW | Radio Specification | Bluetooth BLE |
| Test sample No. | YPHT22050324006 | Model No.           | P60           |
| Start test date | 2022-05-26      | Finish date         | 2022-05-26    |
| Temperature     | 25.1℃           | Humidity            | 37%           |
| Test Engineer   | Xiaoqin Li      | Auditor             | Xiaodong Zhao |

| Appendix clause | Test item                                    | Result |
|-----------------|--|--------|
| A               | Peak Output Power                            | PASS   |
| B               | Power Spectral Density                       | PASS   |
| C               | 6 dB Bandwidth                               | PASS   |
| D               | 99% Occupied Bandwidth                       | PASS   |
| E               | Duty cycle                                   | PASS   |
| F               | Band edge and Spurious Emissions (conducted) | PASS   |

**Appendix A: Peak Output Power**

| Type   | Channel | Peak Output power (dBm) | Average Output power (dBm) | Limit (dBm) | Result |
|--------|---------|-------------------------|----------------------------|-------------|--------|
| BT-BLE | 00      | -0.53                   | -0.58                      | ≤ 30.00     | Pass   |
|        | 19      | 0.11                    | 0.04                       |             |        |
|        | 39      | -0.33                   | -0.39                      |             |        |



CH00

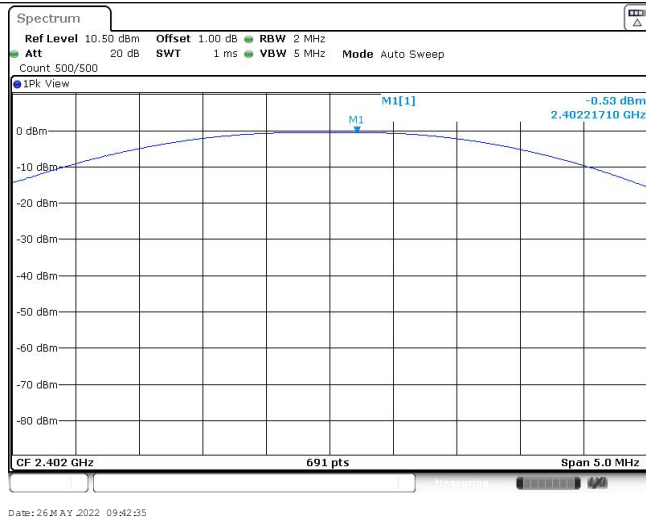

CH19

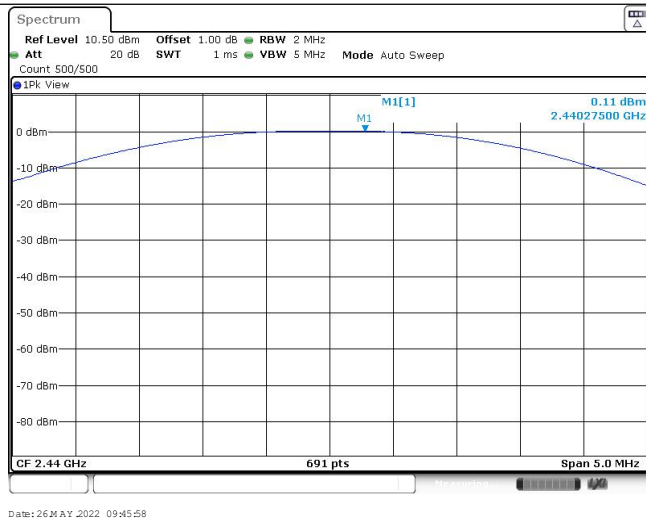

CH39

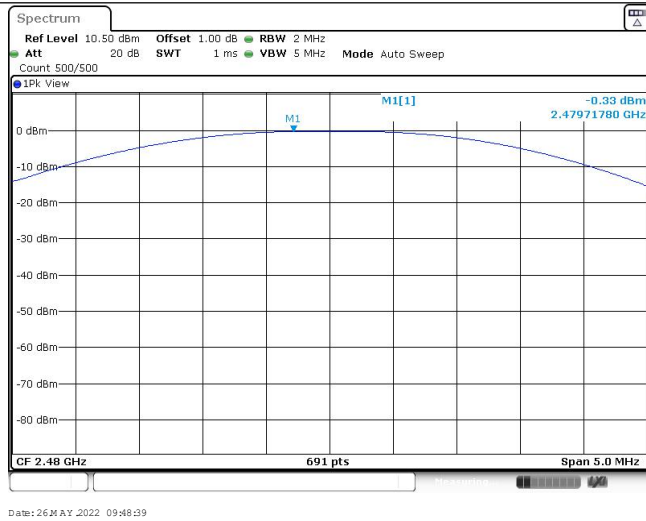

**Appendix B: Power Spectral Density**

| Type   | Channel | Power Spectral Density(dBm/3KHz) | Limit (dBm/3KHz) | Result |
|--------|---------|----------------------------------|------------------|--------|
| BT-BLE | 00      | -16.53                           | ≤8.00            | Pass   |
|        | 19      | -15.85                           |                  |        |
|        | 39      | -16.32                           |                  |        |

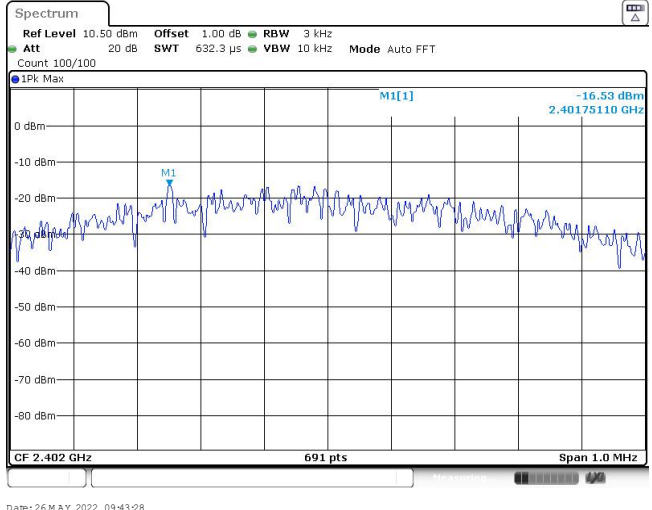
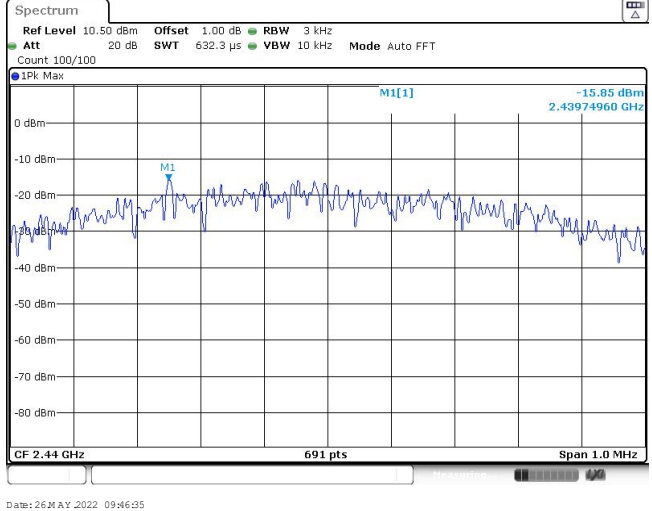
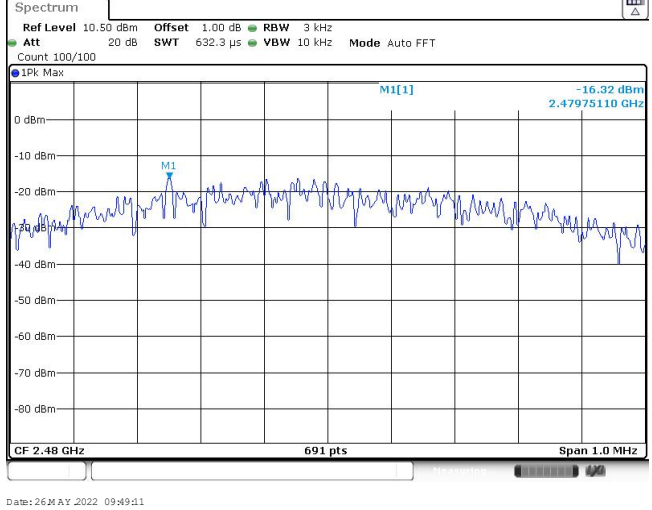
|             |  |
|-------------|--|
| <p>CH00</p> |  <p>Date: 26 MAY 2022 09:43:28</p>   |
| <p>CH19</p> |  <p>Date: 26 MAY 2022 09:46:25</p>  |
| <p>CH39</p> |  <p>Date: 26 MAY 2022 09:49:11</p> |

**Appendix C: 6dB bandwidth**

| Type   | Channel | 6dB Bandwidth(kHz) | Limit (kHz) | Result |
|--------|---------|--------------------|-------------|--------|
| BT-BLE | 00      | 666.00             | ≥500        | Pass   |
|        | 19      | 668.00             |             |        |
|        | 39      | 666.00             |             |        |

CH00

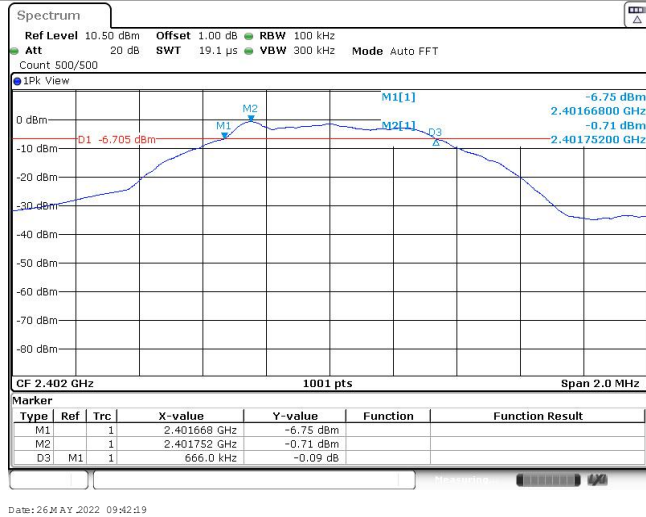

CH19

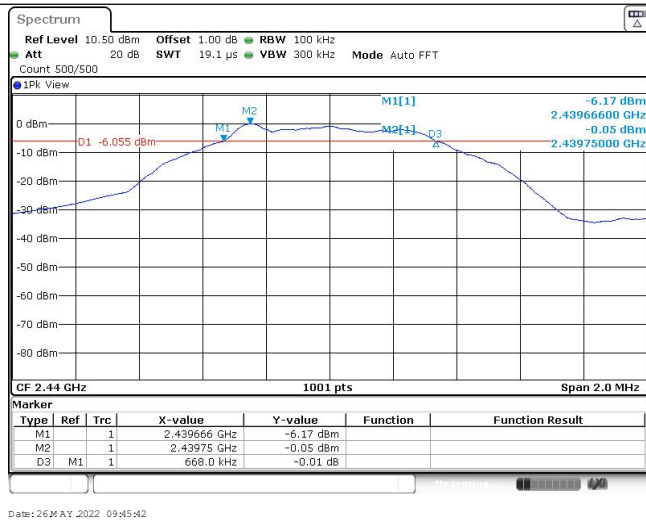

CH39

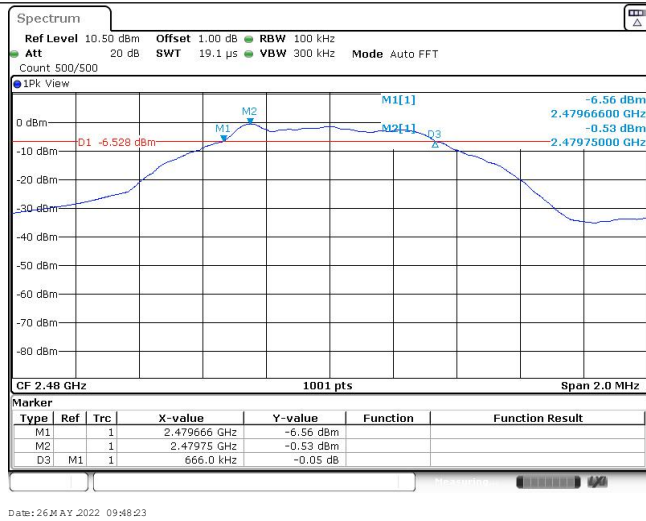

**Appendix D: 99% Occupied Bandwidth**

| Type   | Channel | 99% Occupied Bandwidth(MHz) | Limit (kHz) | Result |
|--------|---------|-----------------------------|-------------|--------|
| BT-BLE | 00      | 1.02                        | -           | Pass   |
|        | 19      | 1.02                        |             |        |
|        | 39      | 1.02                        |             |        |

CH00



Date: 26 MAY 2022 09:42:27

CH19



Date: 26 MAY 2022 09:45:49

CH39

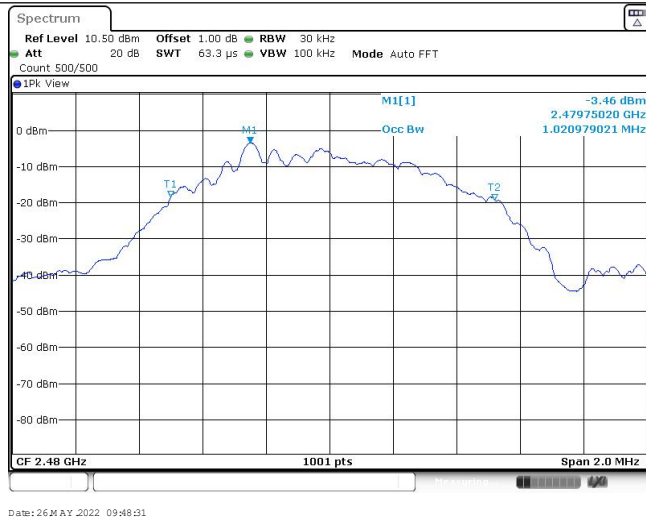

Date: 26 MAY 2022 09:48:31

### Appendix E: Duty cycle

| Test Frequency (MHz) | T <sub>on</sub> time for single burst (ms) | T <sub>period</sub> (ms) | Duty cycle | 1/T <sub>on</sub> time (kHz) |
|----------------------|--|--------------------------|------------|------------------------------|
| 2440                 | 0.39                                       | 0.62                     | 62.9%      | 2.56                         |

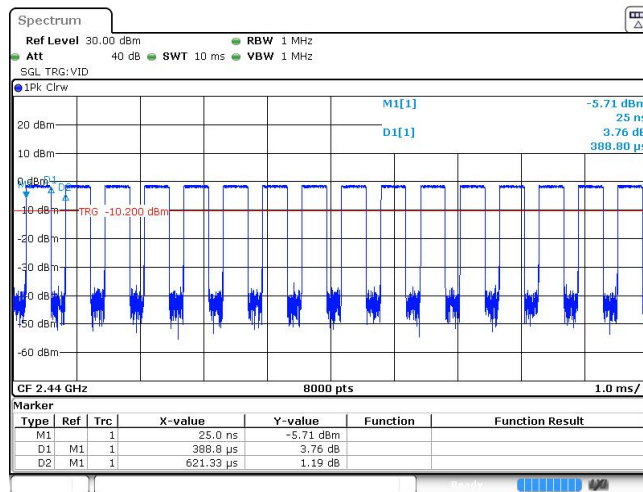

Date: 26 MAY 2022 09:45:29

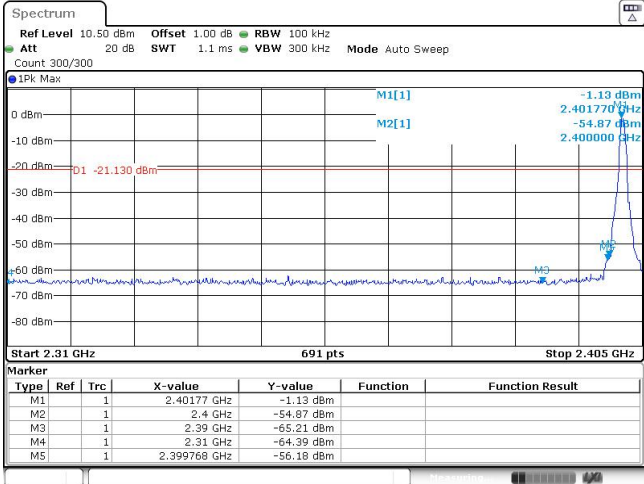
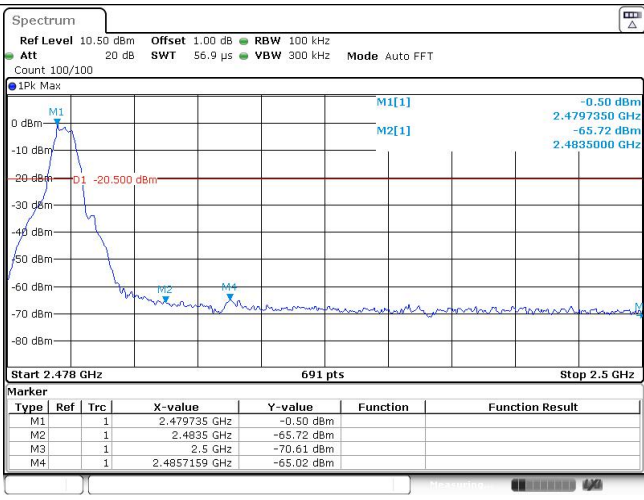

### Appendix F: Band edge and Spurious Emissions (conducted)

| Test Item:                              | Band edge   |      |               |            |          |                 |          |                 |    |   |  |              |           |  |  |    |   |  |            |            |  |  |    |   |  |          |            |  |  |    |   |  |               |            |  |  |    |   |  |              |            |  |  |
|---|---|------|---------------|------------|----------|-----------------|----------|-----------------|----|---|--|--------------|-----------|--|--|----|---|--|------------|------------|--|--|----|---|--|----------|------------|--|--|----|---|--|---------------|------------|--|--|----|---|--|--------------|------------|--|--|
| <p style="text-align: center;">CH00</p> |  <p><b>Marker Table:</b></p> <table border="1"> <thead> <tr> <th>Type</th> <th>Ref</th> <th>Trc</th> <th>X-value</th> <th>Y-value</th> <th>Function</th> <th>Function Result</th> </tr> </thead> <tbody> <tr> <td>M1</td> <td>1</td> <td></td> <td>2.40177 GHz</td> <td>-1.13 dBm</td> <td></td> <td></td> </tr> <tr> <td>M2</td> <td>1</td> <td></td> <td>2.4 GHz</td> <td>-54.87 dBm</td> <td></td> <td></td> </tr> <tr> <td>M3</td> <td>1</td> <td></td> <td>2.39 GHz</td> <td>-65.21 dBm</td> <td></td> <td></td> </tr> <tr> <td>M4</td> <td>1</td> <td></td> <td>2.31 GHz</td> <td>-64.39 dBm</td> <td></td> <td></td> </tr> <tr> <td>M5</td> <td>1</td> <td></td> <td>2.399768 GHz</td> <td>-56.18 dBm</td> <td></td> <td></td> </tr> </tbody> </table> <p>Date: 26 MAY 2022 09:43:37</p> | Type | Ref           | Trc        | X-value  | Y-value         | Function | Function Result | M1 | 1 |  | 2.40177 GHz  | -1.13 dBm |  |  | M2 | 1 |  | 2.4 GHz    | -54.87 dBm |  |  | M3 | 1 |  | 2.39 GHz | -65.21 dBm |  |  | M4 | 1 |  | 2.31 GHz      | -64.39 dBm |  |  | M5 | 1 |  | 2.399768 GHz | -56.18 dBm |  |  |
| Type                                    | Ref   | Trc  | X-value       | Y-value    | Function | Function Result |          |                 |    |   |  |              |           |  |  |    |   |  |            |            |  |  |    |   |  |          |            |  |  |    |   |  |               |            |  |  |    |   |  |              |            |  |  |
| M1                                      | 1   |      | 2.40177 GHz   | -1.13 dBm  |          |                 |          |                 |    |   |  |              |           |  |  |    |   |  |            |            |  |  |    |   |  |          |            |  |  |    |   |  |               |            |  |  |    |   |  |              |            |  |  |
| M2                                      | 1   |      | 2.4 GHz       | -54.87 dBm |          |                 |          |                 |    |   |  |              |           |  |  |    |   |  |            |            |  |  |    |   |  |          |            |  |  |    |   |  |               |            |  |  |    |   |  |              |            |  |  |
| M3                                      | 1   |      | 2.39 GHz      | -65.21 dBm |          |                 |          |                 |    |   |  |              |           |  |  |    |   |  |            |            |  |  |    |   |  |          |            |  |  |    |   |  |               |            |  |  |    |   |  |              |            |  |  |
| M4                                      | 1   |      | 2.31 GHz      | -64.39 dBm |          |                 |          |                 |    |   |  |              |           |  |  |    |   |  |            |            |  |  |    |   |  |          |            |  |  |    |   |  |               |            |  |  |    |   |  |              |            |  |  |
| M5                                      | 1   |      | 2.399768 GHz  | -56.18 dBm |          |                 |          |                 |    |   |  |              |           |  |  |    |   |  |            |            |  |  |    |   |  |          |            |  |  |    |   |  |               |            |  |  |    |   |  |              |            |  |  |
| <p style="text-align: center;">CH39</p> |  <p><b>Marker Table:</b></p> <table border="1"> <thead> <tr> <th>Type</th> <th>Ref</th> <th>Trc</th> <th>X-value</th> <th>Y-value</th> <th>Function</th> <th>Function Result</th> </tr> </thead> <tbody> <tr> <td>M1</td> <td>1</td> <td></td> <td>2.479735 GHz</td> <td>-0.50 dBm</td> <td></td> <td></td> </tr> <tr> <td>M2</td> <td>1</td> <td></td> <td>2.4835 GHz</td> <td>-65.72 dBm</td> <td></td> <td></td> </tr> <tr> <td>M3</td> <td>1</td> <td></td> <td>2.5 GHz</td> <td>-70.61 dBm</td> <td></td> <td></td> </tr> <tr> <td>M4</td> <td>1</td> <td></td> <td>2.4857159 GHz</td> <td>-65.02 dBm</td> <td></td> <td></td> </tr> </tbody> </table> <p>Date: 26 MAY 2022 09:49:20</p>  | Type | Ref           | Trc        | X-value  | Y-value         | Function | Function Result | M1 | 1 |  | 2.479735 GHz | -0.50 dBm |  |  | M2 | 1 |  | 2.4835 GHz | -65.72 dBm |  |  | M3 | 1 |  | 2.5 GHz  | -70.61 dBm |  |  | M4 | 1 |  | 2.4857159 GHz | -65.02 dBm |  |  |    |   |  |              |            |  |  |
| Type                                    | Ref   | Trc  | X-value       | Y-value    | Function | Function Result |          |                 |    |   |  |              |           |  |  |    |   |  |            |            |  |  |    |   |  |          |            |  |  |    |   |  |               |            |  |  |    |   |  |              |            |  |  |
| M1                                      | 1   |      | 2.479735 GHz  | -0.50 dBm  |          |                 |          |                 |    |   |  |              |           |  |  |    |   |  |            |            |  |  |    |   |  |          |            |  |  |    |   |  |               |            |  |  |    |   |  |              |            |  |  |
| M2                                      | 1   |      | 2.4835 GHz    | -65.72 dBm |          |                 |          |                 |    |   |  |              |           |  |  |    |   |  |            |            |  |  |    |   |  |          |            |  |  |    |   |  |               |            |  |  |    |   |  |              |            |  |  |
| M3                                      | 1   |      | 2.5 GHz       | -70.61 dBm |          |                 |          |                 |    |   |  |              |           |  |  |    |   |  |            |            |  |  |    |   |  |          |            |  |  |    |   |  |               |            |  |  |    |   |  |              |            |  |  |
| M4                                      | 1   |      | 2.4857159 GHz | -65.02 dBm |          |                 |          |                 |    |   |  |              |           |  |  |    |   |  |            |            |  |  |    |   |  |          |            |  |  |    |   |  |               |            |  |  |    |   |  |              |            |  |  |

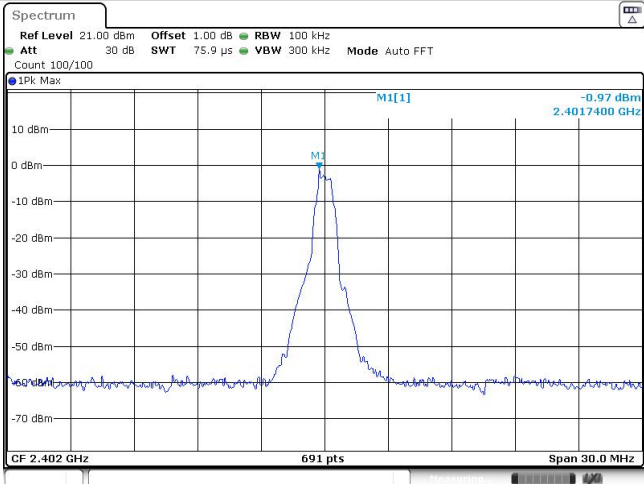
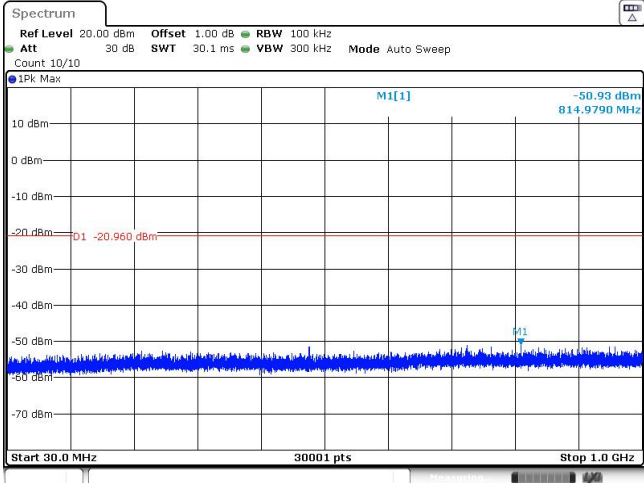
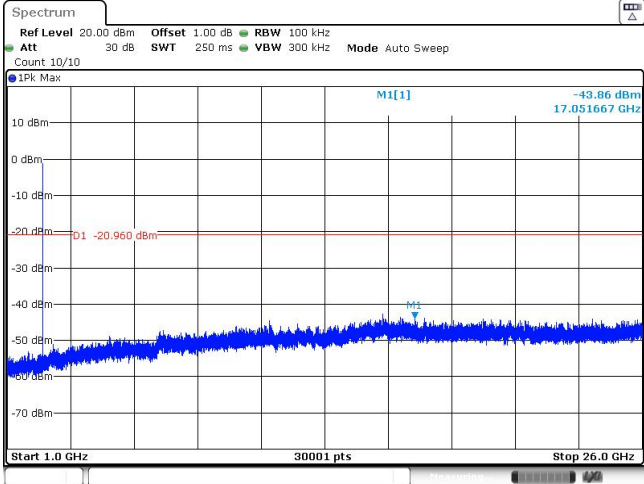
| Test Item:                      | SE  |
|---------------------------------|---|
| <p>CH00<br/>Reference level</p> |  <p>CF 2.402 GHz 691 pts Span 30.0 MHz</p> <p>Date: 26 MAY 2022 09:43:45</p>      |
| <p>CH00<br/>30MHz~1000MHz</p>   |  <p>Start 30.0 MHz 30001 pts Stop 1.0 GHz</p> <p>Date: 26 MAY 2022 09:44:00</p>  |
| <p>CH00<br/>1GHz~26GHz</p>      |  <p>Start 1.0 GHz 30001 pts Stop 26.0 GHz</p> <p>Date: 26 MAY 2022 09:44:16</p> |

|                                 |                                   |
|---------------------------------|-----------------------------------|
| <p>CH19<br/>Reference level</p> | <p>Date: 26 MAY 2022 09:46:41</p> |
| <p>CH19<br/>30MHz~1000MHz</p>   | <p>Date: 26 MAY 2022 09:46:56</p> |
| <p>CH19<br/>1GHz~26GHz</p>      | <p>Date: 26 MAY 2022 09:47:11</p> |

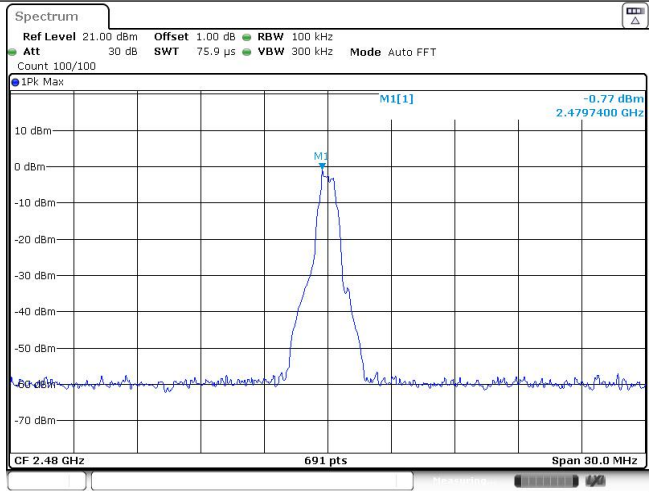
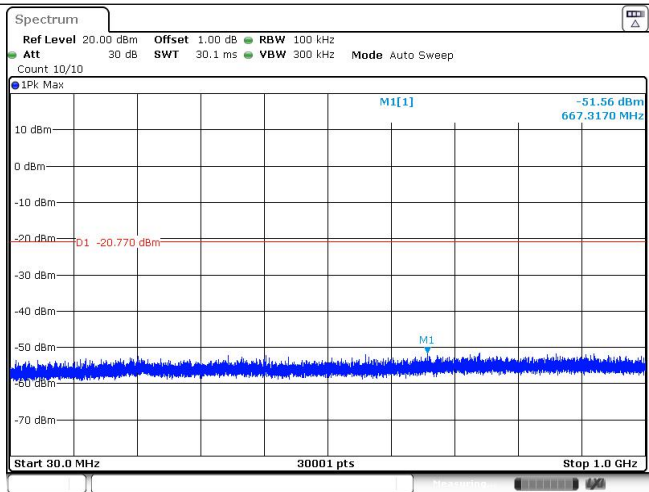
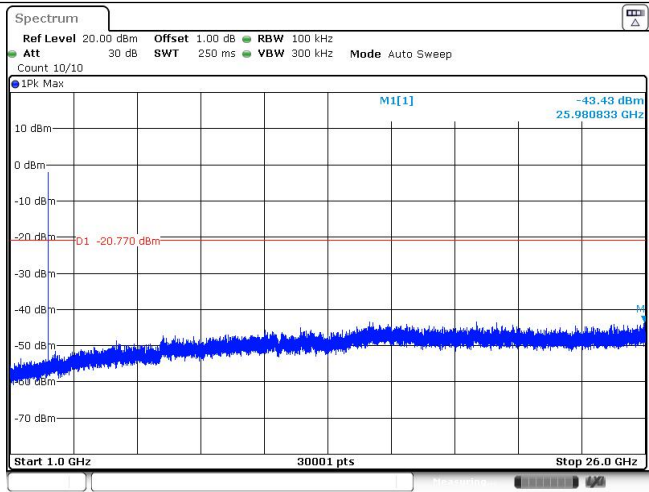
|                                 |  |
|---------------------------------|--|
| <p>CH39<br/>Reference level</p> |  <p>Date: 26 MAY 2022 09:49:45</p>   |
| <p>CH39<br/>30MHz~1000MHz</p>   |  <p>Date: 26 MAY 2022 09:50:00</p>  |
| <p>CH39<br/>1GHz~26GHz</p>      |  <p>Date: 26 MAY 2022 09:50:15</p> |

-----End of Report-----