

FCC REPORT

For WCDMA

Report No.	CHTEW22060006	Report Verification:
Project No.	SHT2205032403EW	 <small>Report No: CHTEW22060006</small>
FCC ID	2ASWWCORNP60	
Applicant	XINCHUANGXIN INTERNATIONAL CO.,LTD	
Address	ROOM 605 6/F, FA YUEN COMMERCIAL BUILDING, 75-77 FA YUEN STREET MONGKOK KL	
Product Name	Smart Phone	
Trade Mark	CORN	
Model No.	P60	
Listed Model(s)	-	
Standard	FCC CFR Title 47 Part 2 FCC CFR Title 47 Part 22 FCC CFR Title 47 Part 24	
Date of receipt of test sample	May.20, 2022	
Date of testing	May.21, 2022-Jun.01, 2022	
Date of issue	Jun.02, 2022	
Result	Pass	

Compiled by
 (position+printedname+signature)....: File administrators Fanghui Zhu



Supervised by
 (position+printedname+signature)....: Project Engineer Cheng Xiao



Approved by
 (position+printedname+signature)....: Manager Hans Hu



Testing Laboratory Name : **Shenzhen Huatongwei International Inspection Co., Ltd.**
 Address.....: 1/F, Bldg 3, Hongfa Hi-tech Industrial Park, Genyu Road, Tianliao, Gongming, Shenzhen, China

Shenzhen Huatongwei International Inspection Co., Ltd. All rights reserved.

This publication may be reproduced in whole or in part for non-commercial purposes as long as the Shenzhen Huatongwei International Inspection Co., Ltd. is acknowledged as copyright owner and source of the material. Shenzhen Huatongwei International Inspection Co., Ltd. takes no responsibility for and will not assume liability for damages resulting from the reader's interpretation of the reproduced material due to its placement and context.

The test report merely correspond to the test sample.

Contents

1.	<u>TEST STANDARDS AND REPORT VERSION</u>	3
1.1.	Applicable Standards	3
1.2.	Report version information	3
2.	<u>TEST DESCRIPTION</u>	4
3.	<u>SUMMARY</u>	5
3.1.	Client Information	5
3.2.	Product Description	5
3.3.	Radio Specification Description	5
3.4.	Testing Laboratory Information	6
4.	<u>TEST CONFIGURATION</u>	7
4.1.	Test frequency list	7
4.2.	Descriptions of Test mode	7
4.3.	Test sample information	7
4.4.	Support unit used in test configuration and system	7
4.5.	Testing environmental condition	8
4.6.	Statement of the measurement uncertainty	8
4.7.	Equipments Used during the Test	9
5.	<u>TEST CONDITIONS AND RESULTS</u>	10
5.1.	Conducted Output Power	10
5.2.	Peak-Average Ratio	11
5.3.	99% Occupied Bandwidth & 26 dB Bandwidth	12
5.4.	Band Edge	13
5.5.	Conducted Spurious Emissions	14
5.6.	Frequency stability VS Temperature measurement	15
5.7.	Frequency stability VS Voltage measurement	16
5.8.	ERP and EIRP	17
5.9.	Radiated Spurious Emission	18
6.	<u>TEST SETUP PHOTOS OF THE EUT</u>	26
7.	<u>EXTERNAL AND INTERNAL PHOTOS OF THE EUT</u>	26
8.	<u>APPENDIX REPORT</u>	26

1. TEST STANDARDS AND REPORT VERSION

1.1. Applicable Standards

The tests were performed according to following standards:

[FCC Rules Part 2](#): FREQUENCY ALLOCATIONS AND RADIO TREATY MATTERS; GENERAL RULES AND REGULATIONS

[FCC Rules Part 22](#): PUBLIC MOBILE SERVICES

[FCC Rules Part 24](#): PERSONAL COMMUNICATIONS SERVICES

[TIA/EIA 603 E March 2016](#): Land Mobile FM or PM Communications Equipment Measurement and Performance Standards.

[ANSI C63.26: 2015](#): American National Standard for Compliance Testing of Transmitters Used in Licensed Radio Services

[KDB 971168 D01 Power Meas License Digital Systems v03](#): MEASUREMENT GUIDANCE FOR CERTIFICATION OF LICENSED DIGITAL TRANSMITTERS

1.2. Report version information

Revision No.	Date of issue	Description
N/A	2022-06-02	Original

2. TEST DESCRIPTION

Section	Test Item	Section in CFR 47	Result #1	Test Engineer
5.1	Conducted Output Power	Part 2.1046 Part 22.913(a) Part 24.232(c)	Pass	Tiancheng Huang
5.2	Peak-to-Average Ratio	Part 24.232	Pass	Tiancheng Huang
5.3	99% Occupied Bandwidth & 26 dB Bandwidth	Part 2.1049 Part 22.917(b) Part 24.238(b)	Pass	Tiancheng Huang
5.4	Band Edge	Part 2.1051 Part 22.917 Part 24.238	Pass	Tiancheng Huang
5.5	Conducted Spurious Emissions	Part 2.1051 Part 22.917 Part 24.238	Pass	Tiancheng Huang
5.6	Frequency stability vs temperature	Part 2.1055(a)(1)(b) Part 22.355 Part 24.235	Pass	Tiancheng Huang
5.7	Frequency stability vs voltage	Part 2.1055(d)(1)(2) Part 22.355 Part 24.235	Pass	Tiancheng Huang
5.8	ERP and EIRP	Part 22.913(a) Part 24.232(b)	Pass	Tiancheng Huang
5.9	Radiated Spurious Emissions	Part 2.1053 Part 22.917 Part 24.238	Pass	Pan Xie

Note:

#1: The test result does not include measurement uncertainty value

3. SUMMARY

3.1. Client Information

Applicant:	XINCHUANGXIN INTERNATIONAL CO.,LTD
Address:	ROOM 605 6/F, FA YUEN COMMERCIAL BUILDING, 75-77 FA YUEN STREET MONGKOK KL
Manufacturer:	Shenzhen Chiteng Technology Co.,LTD
Address:	Second Floor,Area A, Building 4, Huiye Technology Workshop, Guanguang Road, Tangjia Community, Gongming Street, Guangming New District, Shenzhen, Guangdong

3.2. Product Description

Main unit information:	
Product Name:	Smart Phone
Trade Mark:	CORN
Model No.:	P60
Listed Model(s):	-
Power supply:	DC 3.8V from Battery
Hardware version:	J527B-31EMB_D3_AF_V1.1
Software version:	CORN_P60_S62301A01_V01_20220531
Accessory unit information:	
Adapter information:	Model: CS001 Input: 100-240Va.c., 50/60Hz 0.15A Output: 5Vd.c., 1A

3.3. Radio Specification Description

Support Operating Band:	<input checked="" type="checkbox"/> Band II <input type="checkbox"/> Band IV <input checked="" type="checkbox"/> Band V
Operating Frequency Range:	Please refer to note #2
Support Type:	<input checked="" type="checkbox"/> WCDMA <input checked="" type="checkbox"/> HSDPA <input checked="" type="checkbox"/> HSUPA <input type="checkbox"/> DC-HSUPA
Modulation Type:	<input checked="" type="checkbox"/> QPSK <input type="checkbox"/> 16QAM
Power Class:	<input checked="" type="checkbox"/> Class 3 <input type="checkbox"/> Class 4
Antenna type:	Interna
Antenna gain #3:	Band II: 1.2dBi Band V: 0.6dBi

Note:

- : means that this feature is supported; : means that this feature is not supported
- #2: Operating frequency range is as follow:

WCDMA Band	Uplink frequency	Downlink frequency
Band II	1852.40~1907.60MHz	1932.40~1987.60MHz
Band V	826.40~846.60MHz	871.40~891.60MHz

- #3: The antenna gain is provided by the applicant, and the applicant should be responsible for its authenticity, HTW lab has not verified the authenticity of its information

3.4. Testing Laboratory Information

Laboratory Name	Shenzhen Huatongwei International Inspection Co., Ltd.	
Laboratory Location	1/F, Bldg 3, Hongfa Hi-tech Industrial Park, Genyu Road, Tianliao, Gongming, Shenzhen, China	
Connect information:	Tel: 86-755-26715499 E-mail: cs@szhtw.com.cn http://www.szhtw.com.cn	
Qualifications	Type	Accreditation Number
	FCC	762235

4. TEST CONFIGURATION

4.1. Test frequency list

FDD Band II		FDD Band V	
Channel	Frequency (MHz)	Channel	Frequency (MHz)
9262	1852.40	4132	826.40
9400	1880.00	4182	836.40
9538	1907.60	4233	846.60

4.2. Descriptions of Test mode

Antenna port conducted and radiated test items were performed according to KDB 971168 D01 Power Meas. License Digital Systems and ANSI C63.26 with maximum output power.

Radiated measurements were performed with rotating EUT in different three orthogonal test planes to find the maximum emission.

All modes and data rates and positions were investigated, test modes are chosen to be reported as the worst case configuration below:

Band	Radiated test items	Conducted test items
WCDMA Band II	RMC 12.2Kbps Link	RMC 12.2Kbps Link
WCDMA Band V	RMC 12.2Kbps Link	RMC 12.2Kbps Link

4.3. Test sample information

Test item	HTW sample no.
Conducted test items	Please refer to the description in the appendix report
Radiated test items	YPHT22050324007

Note:

Conducted test items: Conducted Output Power, Peak-Average Ratio, 99% Occupied Bandwidth & 26 dB Bandwidth, Band Edge, Conducted Spurious Emissions, Frequency stability, ERP and EIRP

Radiated test items: Radiated Spurious Emission

4.4. Support unit used in test configuration and system

The EUT has been associated with peripherals and configuration operated in a manner tended to maximize its emission characteristics in a typical application.

The following peripheral devices and interface cables were connected during the measurement:

Whether support unit is used?				
✓ No				
Item	Equipment	Trade Name	Model No.	Other
1				
2				

4.5. Testing environmental condition

Voltage	VN=Nominal Voltage	DC 3.8V
	VL=Lower Voltage	DC 3.6V
	VH=Higher Voltage	DC 4.35
Temperature	TN=Normal Temperature	25 °C
	Extreme Temperature	From -30°C to + 50°C
Humidity	30~60 %	
Air Pressure	950-1050 hPa	

4.6. Statement of the measurement uncertainty

Test Items	Measurement Uncertainty
Radio frequency	<1GHz: 0.022ppm >1GHz: 0.64ppm
Conducted output power	0.65 dB
ERP and EIRP	0.65 dB
Conducted spurious emission	0.65 dB
Radiated spurious emission	<1GHz: 2.85dB >1GHz: 3.66dB
99% Occupied Bandwidth & 26 dB Bandwidth	<1GHz: 0.022ppm >1GHz: 0.64ppm

This uncertainty represents an expanded uncertainty expressed at approximately the 95% confidence level using a coverage factor of k=1.96.

4.7. Equipments Used during the Test

Used	Test Equipment	Manufacturer	Equipment No.	Model No.	Serial No.	Last Cal. Date (YY-MM-DD)	Next Cal. Date (YY-MM-DD)
●	Signal and spectrum Analyzer	R&S	HTWE0242	FSV40	100048	2021/09/13	2022/09/12
●	Signal & Spectrum Analyzer	R&S	HTWE0262	FSW26	103440	2021/09/13	2022/09/12
●	Spectrum Analyzer	Agilent	HTWE0286	N9020A	MY50510187	2021/09/13	2022/09/12
●	Radio communication tester	R&S	HTWE0287	CMW500	137688-Lv	2021/09/13	2022/09/12
●	Test software	Tonscend	N/A	JS1120	N/A	N/A	N/A

● Radiated Spurious Emission

Used	Test Equipment	Manufacturer	Equipment No.	Model No.	Serial No.	Last Cal. Date (YY-MM-DD)	Next Cal. Date (YY-MM-DD)
●	Semi-Anechoic Chamber	Albatross projects	HTWE0122	SAC-3m-01	N/A	2018/09/27	2022/09/26
●	Spectrum Analyzer	R&S	HTWE0098	FSP40	100597	2021/09/13	2022/09/12
●	Loop Antenna	R&S	HTWE0170	HFH2-Z2	100020	2021/04/06	2024/04/05
●	Broadband Horn Antenna	SCHWARZBECK	HTWE0103	BBHA9170	BBHA9170472	2020/04/27	2023/04/26
●	Ultra-Broadband Antenna	SCHWARZBECK	HTWE0123	VULB9163	538	2021/04/06	2024/04/05
●	Horn Antenna	SCHWARZBECK	HTWE0126	9120D	1011	2020/04/01	2023/03/31
●	Pre-amplifier	CD	HTWE0071	PAP-0102	12004	2021/11/05	2022/11/04
●	Broadband Preamplifier	SCHWARZBECK	HTWE0201	BBV 9718	9718-248	2022/02/28	2023/02/27
●	RF Connection Cable	HUBER+SUHNER	HTWE0120-01	6m 18GHz S Serisa	N/A	2022/02/25	2023/02/24
●	RF Connection Cable	HUBER+SUHNER	HTWE0120-02	6m 3GHz RG Serisa	N/A	2022/02/25	2023/02/24
●	RF Connection Cable	HUBER+SUHNER	HTWE0120-03	6m 3GHz RG Serisa	N/A	2022/02/25	2023/02/24
●	RF Connection Cable	HUBER+SUHNER	HTWE0120-04	6m 3GHz RG Serisa	N/A	2022/02/25	2023/02/24
●	RF Connection Cable	HUBER+SUHNER	HTWE0121-01	6m 18GHz S Serisa	N/A	2018/09/27	2022/09/26
●	EMI Test Software	Audix	N/A	E3	N/A	N/A	N/A

● Auxiliary Equipment

Used	Test Equipment	Manufacturer	Equipment No.	Model No.	Serial No.	Last Cal. Date (YY-MM-DD)	Next Cal. Date (YY-MM-DD)
●	Climate chamber	ESPEC	HTWE0254	GPL-2	N/A	2021/09/14	2022/09/13
●	DC Power Supply	Gwinstek	HTWE0274	SPS-2415	GER835793	N/A	N/A

5. TEST CONDITIONS AND RESULTS

5.1. Conducted Output Power

LIMIT

N/A

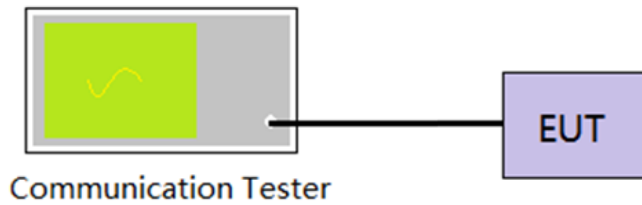
TEST CONFIGURATION**TEST PROCEDURE**

1. The EUT output port was connected to communication tester.
2. Set EUT at maximum power through communication tester.
3. Select lowest, middle, and highest channels for each band and different modulation.
4. Measure the maximum burst average power.

TEST MODE:

Please refer to the clause 4.2

TEST RESULTS **Passed** **Not Applicable**

Refer to appendix A on the section 8 appendix report

5.2. Peak-Average Ratio

LIMIT

13dB

TEST CONFIGURATION

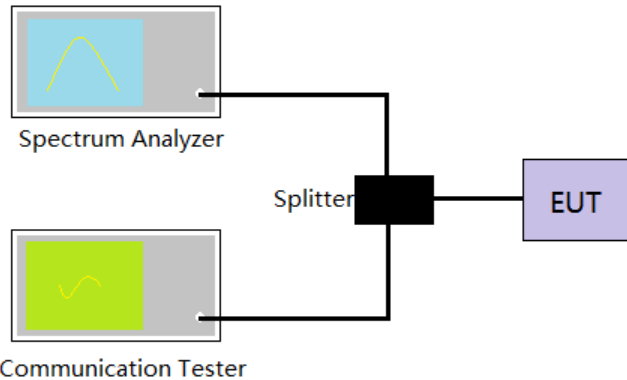

TEST PROCEDURE

1. The EUT was connected to the spectrum analyzer and communication tester via a power splitter
2. Set EUT in maximum power output.
3. Center Frequency = Carrier frequency, RBW > Emission bandwidth of signal
4. The signal analyzer was set to collect one million samples to generate the CCDF curve
5. The measurement interval was set depending on the type of signal analyzed.
 - i. For continuous signals (>98% duty cycle), the measurement interval was set to 1ms.
 - ii. For burst transmissions, the spectrum analyzer is set to use an internal "RF Burst" trigger that is synced with an incoming pulse and the measurement interval is set to less than the duration of the "on time" of one burst to ensure that energy is only captured during a time in which the transmitter is operating at maximum power
6. Record the maximum PAPR level associated with a probability of 0.1%.

TEST MODE:

Please refer to the clause 4.2

TEST RESULTS

Passed Not Applicable

Refer to appendix B on the section 8 appendix report

5.3. 99% Occupied Bandwidth & 26 dB Bandwidth

LIMIT

N/A

TEST CONFIGURATION**TEST PROCEDURE**

1. The EUT was connected to the spectrum analyzer and communication tester via a power splitter
2. Set EUT in maximum power output.
3. Spectrum analyzer setting as follow:
Center Frequency= Carrier frequency, RBW=1% to 5% of anticipated OBW, VBW= 3 * RBW, Detector=Peak, Trace maximum hold.
4. Record the value of 99% Occupied bandwidth and -26dB bandwidth.

TEST MODE:

Please refer to the clause 4.2

TEST RESULTS **Passed** **Not Applicable**

Refer to appendix C on the section 8 appendix report

5.4. Band Edge

LIMIT

Part 24.238 and Part 22.917 and Part 27.53 specify that the power of any emission outside of the authorized operating frequency ranges must be attenuated below the transmitting power (P) by a factor of at least $43 + 10 \log(P)$ dB.

The specification that emissions shall be attenuated below the transmitter power (P) by at least $43 + 10 \log(P)$ dB, translates in the relevant power range (1 to 0.001 W) to -13 dBm. At 1 W the specified minimum attenuation becomes 43 dB and relative to a 30 dBm (1 W) carrier becomes a limit of -13 dBm. At 0.001 W (0 dBm) the minimum attenuation is 13 dB, which again yields a limit of -13 dBm. In this way a translation of the specification from relative to absolute terms is carried out.

TEST CONFIGURATION

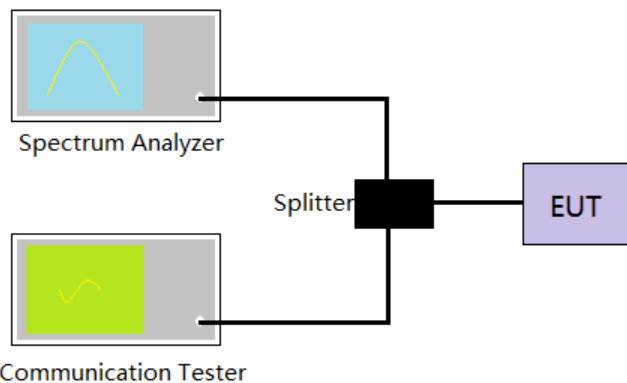

TEST PROCEDURE

1. The EUT was connected to the spectrum analyzer and communication tester via a power splitter
2. Set EUT in maximum power output.
3. The band edges of low and high channels were measured.
4. Spectrum analyzer setting as follow:
RBW=100KHz, VBW = 300KHz, Sweep time= Auto
5. Record the test plot.

TEST MODE:

Please refer to the clause 4.2

TEST RESULTS

Passed Not Applicable

Refer to appendix D on the section 8 appendix report

5.5. Conducted Spurious Emissions

LIMIT

Part 24.238 and Part 22.917 and Part 27.53 specify that the power of any emission outside of the authorized operating frequency ranges must be attenuated below the transmitting power (P) by a factor of at least $43 + 10 \log(P)$ dB.

The specification that emissions shall be attenuated below the transmitter power (P) by at least $43 + 10 \log(P)$ dB, translates in the relevant power range (1 to 0.001 W) to -13 dBm. At 1 W the specified minimum attenuation becomes 43 dB and relative to a 30 dBm (1 W) carrier becomes a limit of -13 dBm. At 0.001 W (0 dBm) the minimum attenuation is 13 dB, which again yields a limit of -13 dBm. In this way a translation of the specification from relative to absolute terms is carried out.

TEST CONFIGURATION

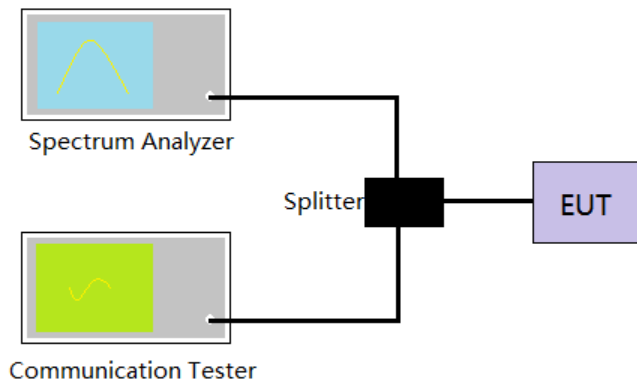

TEST PROCEDURE

1. The EUT was connected to the spectrum analyzer and communication tester via a power splitter
2. Set EUT in maximum power output.
3. Spectrum analyzer setting as follow:
Below 1GHz, RBW=100KHz, VBW = 300KHz, Detector=Peak, Sweep time= Auto
Above 1GHz, RBW=1MHz, VBW=3MHz, Detector=Peak, Sweep time= Auto
Scan frequency range up to 10th harmonic.
4. Record the test plot.

TEST MODE:

Please refer to the clause 4.2

TEST RESULTS

Passed Not Applicable

Refer to appendix E on the section 8 appendix report

5.6. Frequency stability VS Temperature measurement

LIMIT

2.5ppm

TEST CONFIGURATION

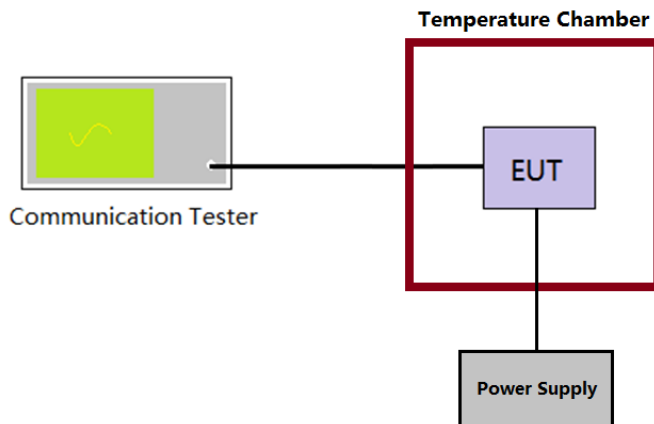

TEST PROCEDURE

1. The equipment under test was connected to an external DC power supply and input rated voltage.
2. The EUT output port was connected to communication tester.
3. The EUT was placed inside the temperature chamber.
4. Turn EUT off and set the chamber temperature to -30°C . After the temperature stabilized for approximately 30 minutes recorded the frequency.
5. Repeat step 4 measure with 10°C increased per stage until the highest temperature of $+50^{\circ}\text{C}$ reached.

TEST MODE:

Please refer to the clause 4.2

TEST RESULTS

Passed Not Applicable

Refer to appendix F on the section 8 appendix report

5.7. Frequency stability VS Voltage measurement

LIMIT

2.5ppm

TEST CONFIGURATION

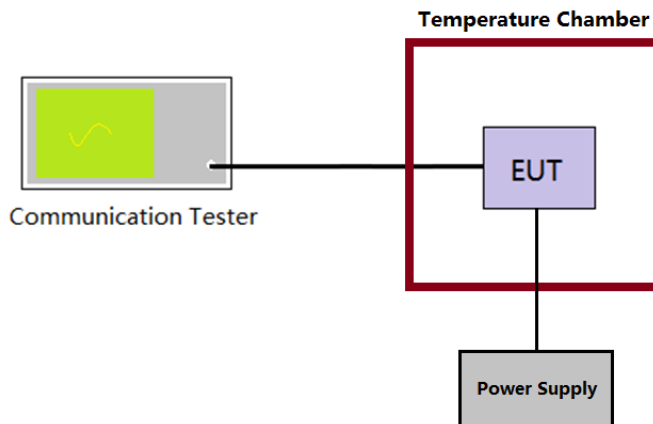

TEST PROCEDURE

1. The equipment under test was connected to an external DC power supply and input rated voltage.
2. The EUT output port was connected to communication tester.
3. The EUT was placed inside the temperature chamber at 25°C
4. The power supply voltage to the EUT was varied $\pm 15\%$ of the nominal value measured at the input to the EUT
5. Record the maximum frequency change.

TEST MODE:

Please refer to the clause 4.2

TEST RESULTS

Passed Not Applicable

Refer to appendix F on the section 8 appendix report

5.8. ERP and EIRP

LIMIT

WCDMA Band V: 7W (38.45dBm) ERP

WCDMA Band II: 2W (33dBm) EIRP

WCDMA Band IV: 1W (30dBm) EIRP

TEST PROCEDURE

1. According to the power tested in section 5.1, select the maximum power in each mode, and use the following formula to calculate the corresponding ERP/EIRP.
2. ERP = conducted power + Gain(dBd)
3. EIRP = conducted power + Gain(dBi)

$$\text{ERP} = \text{EIRP} - 2.15$$

TEST RESULTS

Passed **Not Applicable**

Refer to appendix G on the section 8 appendix report

5.9. Radiated Spurious Emission

LIMIT

-13dBm

TEST CONFIGURATION

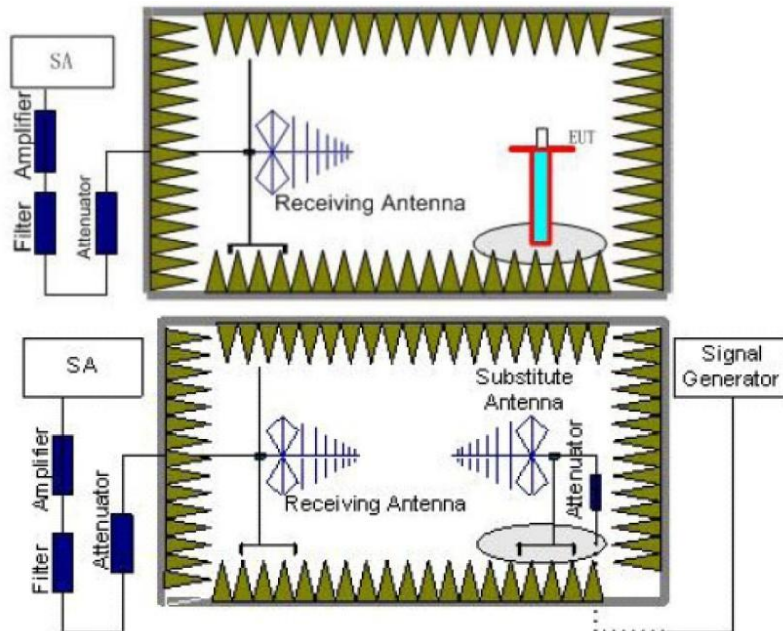

TEST PROCEDURE

1. Place the EUT in the center of the turntable.
 - a) For radiated emissions measurements performed at frequencies less than or equal to 1 GHz, the EUT shall be placed on a RF-transparent table at a nominal height of 80 cm above the reference ground plane
 - b) For radiated measurements performed at frequencies above 1 GHz, the EUT shall be placed on an RF transparent table at a nominal height of 1.5 m above the ground plane.
2. Unless the EUT uses an integral antenna, the EUT shall be terminated with a non-radiating transmitter load. In cases where the EUT uses an adjustable antenna, the antenna shall be adjusted through typical positions and lengths to maximize emissions levels.
3. The EUT shall be tested while operating on the frequency per manufacturer specification. Set the transmitter to operate in continuous transmit mode.
4. Receiver or Spectrum set as follow:
 Below 1GHz, RBW=100kHz, VBW=300kHz, Detector=Peak, Sweep time=Auto
 Above 1GHz, RBW=1MHz, VBW=3MHz, Detector=Peck, Sweep time=Auto
5. Each emission under consideration shall be evaluated:
 - a) Raise and lower the measurement antenna from 1 m to 4 m, as necessary to enable detection of the maximum emission amplitude relative to measurement antenna height.
 - b) Rotate the EUT through 360° to determine the maximum emission level relative to the axial position.
 - c) Return the turntable to the azimuth where the highest emission amplitude level was observed.
 - d) Vary the measurement antenna height again through 1 m to 4 m again to find the height associated with the maximum emission amplitude.
 - e) Record the measured emission amplitude level and frequency
6. Repeat step 5 for each emission frequency with the measurement antenna oriented in both the horizontal and vertical polarizations to determine the orientation that gives the maximum emissions amplitude.
7. Set-up the substitution measurement with the reference point of the substitution antenna located as near as possible to where the center of the EUT radiating element was located during the initial EUT measurement.
8. Maintain the previous measurement instrument settings and test set-up, with the exception that the EUT is removed and replaced by the substitution antenna.
9. Connect a signal generator to the substitution antenna; locate the signal generator so as to minimize any potential influences on the measurement results. Set the signal generator to the frequency where emissions are detected, and set an output power level such that the radiated signal can be detected by

- the measurement instrument, with sufficient dynamic range relative to the noise floor.
10. For each emission that was detected and measured in the initial test
 - a) Vary the measurement antenna height between 1 m to 4 m to maximize the received (measured) signal amplitude.
 - b) Adjust the signal generator output power level until the amplitude detected by the measurement instrument equals the amplitude level of the emission previously measured directly in step 5 and step 6.
 - c) Record the output power level of the signal generator when equivalence is achieved in step b).
 11. Repeat step 8 through step 10 with the measurement antenna oriented in the opposite polarization.
 12. Calculate the emission power in dBm referenced to a half-wave dipole using the following equation:
$$P_e = P_s(\text{dBm}) - \text{cable loss (dB)} + \text{antenna gain (dBd)}$$
where
 P_e = equivalent emission power in dBm
 P_s = source (signal generator) power in dBm
NOTE—dBd refers to the measured antenna gain in decibels relative to a half-wave dipole.
 13. Correct the antenna gain of the substitution antenna if necessary to reference the emission power to a half-wave dipole. When using measurement antennas with the gain specified in dBi, the equivalent dipole-referenced gain can be determined from:
 $\text{gain (dBd)} = \text{gain (dBi)} - 2.15 \text{ dB}.$
If necessary, the antenna gain can be calculated from calibrated antenna factor information
 14. Provide the complete measurement results as a part of the test report.

TEST MODE:

Please refer to the clause 4.2

TEST RESULTS

Passed **Not Applicable**

WCDMA Band II

Test channel: 9262 Polarization: Horizontal

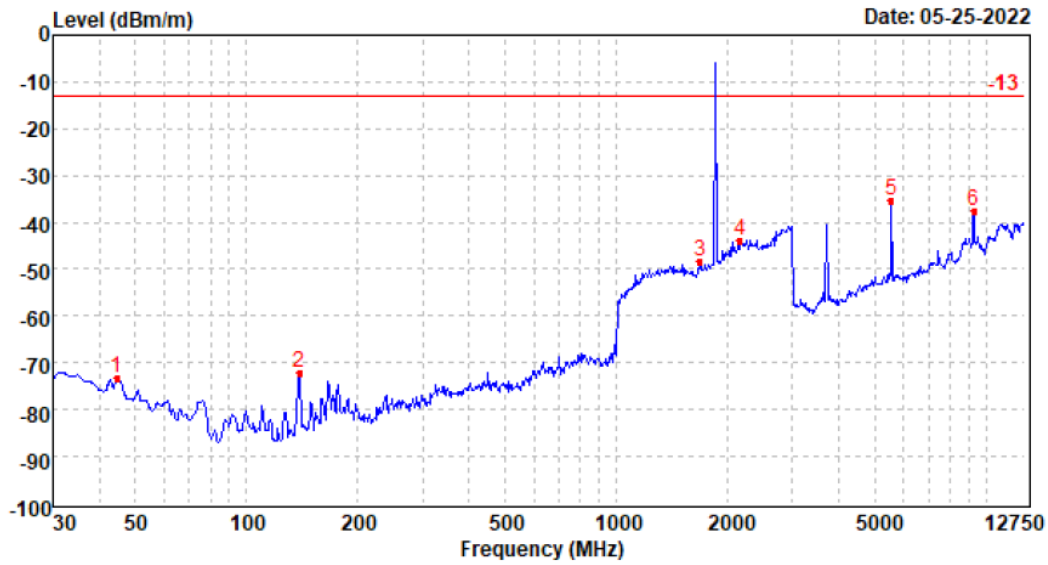

Mark	Frequency MHz	Reading dBm	Antenna dB	Cable dB	Preamp dB	Level dBm	Limit dBm	Over limit	Remark
1	44.64	-75.11	25.69	6.99	30.92	-73.35	-13.00	-60.35	Peak
2	138.99	-66.40	17.34	7.79	30.71	-71.98	-13.00	-58.98	Peak
3	1688.83	-68.00	36.31	12.85	29.35	-48.19	-13.00	-35.19	Peak
4	2167.17	-69.20	40.68	13.95	29.36	-43.93	-13.00	-30.93	Peak
5	5554.08	-55.54	43.80	9.39	32.79	-35.14	-13.00	-22.14	Peak
6	9267.14	-67.64	49.50	11.71	31.17	-37.60	-13.00	-24.60	Peak

Test channel: 9262 Polarization: Vertical

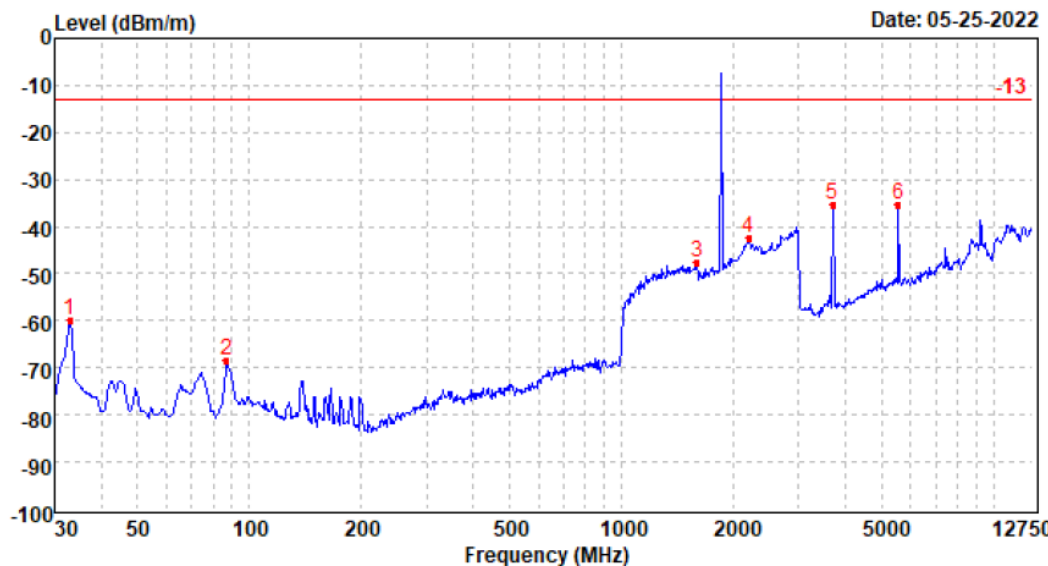

Mark	Frequency MHz	Reading dBm	Antenna dB	Cable dB	Preamp dB	Level dBm	Limit dBm	Over limit	Remark
1	32.99	-54.74	18.92	6.85	30.92	-59.89	-13.00	-46.89	Peak
2	86.76	-69.45	24.46	7.39	30.84	-68.44	-13.00	-55.44	Peak
3	1596.81	-68.58	37.76	12.64	29.44	-47.62	-13.00	-34.62	Peak
4	2198.35	-68.67	41.70	14.03	29.44	-42.38	-13.00	-29.38	Peak
5	3700.48	-47.63	42.31	7.01	37.16	-35.47	-13.00	-22.47	Peak
6	5554.08	-55.71	43.95	9.39	32.79	-35.16	-13.00	-22.16	Peak

Test channel:	9400	Polarization:	Horizontal
---------------	------	---------------	------------

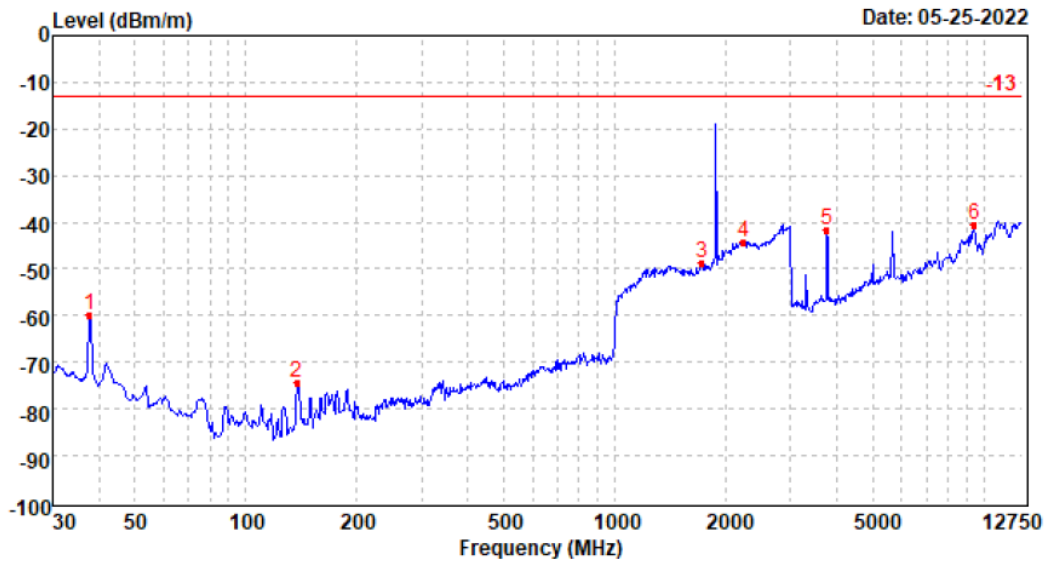

Mark	Frequency MHz	Reading dBm	Antenna dB	Cable dB	Preamp dB	Level dBm	Limit dBm	Over limit	Remark
1	37.84	-63.50	27.46	6.90	30.86	-60.00	-13.00	-47.00	Peak
2	138.01	-68.53	17.22	7.78	30.72	-74.25	-13.00	-61.25	Peak
3	1720.67	-68.65	36.43	12.92	29.33	-48.63	-13.00	-35.63	Peak
4	2234.87	-69.52	40.76	14.12	29.52	-44.16	-13.00	-31.16	Peak
5	3754.53	-53.82	42.23	7.07	37.01	-41.53	-13.00	-28.53	Peak
6	9416.16	-70.12	50.01	11.85	32.24	-40.50	-13.00	-27.50	Peak

Test channel:	9400	Polarization:	Vertical
---------------	------	---------------	----------

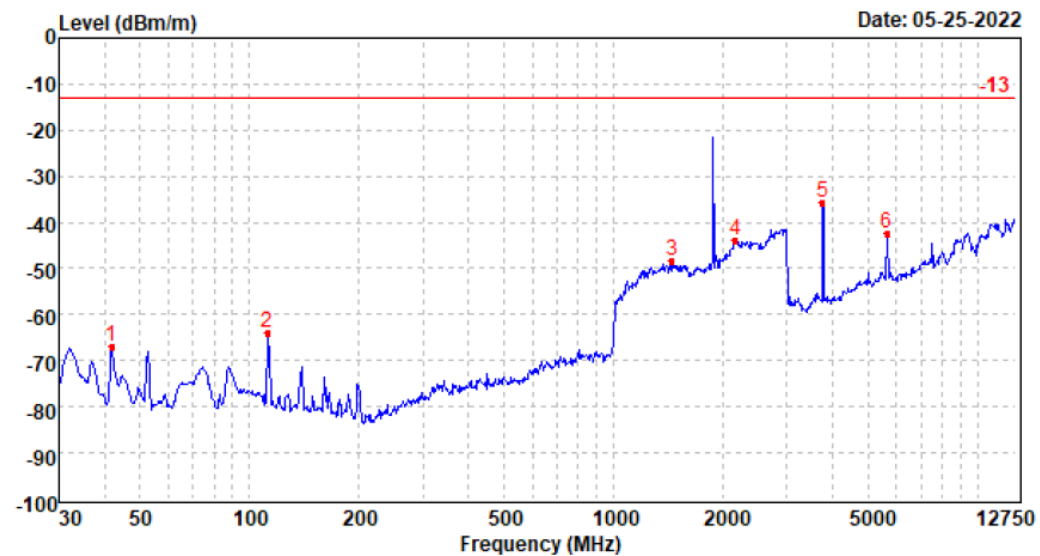

Mark	Frequency MHz	Reading dBm	Antenna dB	Cable dB	Preamp dB	Level dBm	Limit dBm	Over limit	Remark
1	41.75	-64.42	21.29	6.95	30.87	-67.05	-13.00	-54.05	Peak
2	112.16	-64.66	23.91	7.61	30.96	-64.10	-13.00	-51.10	Peak
3	1454.45	-69.39	37.76	12.30	29.16	-48.49	-13.00	-35.49	Peak
4	2169.55	-69.70	41.23	13.95	29.36	-43.88	-13.00	-30.88	Peak
5	3754.53	-47.76	42.15	7.07	37.01	-35.55	-13.00	-22.55	Peak
6	5635.22	-62.56	43.94	9.46	33.38	-42.54	-13.00	-29.54	Peak

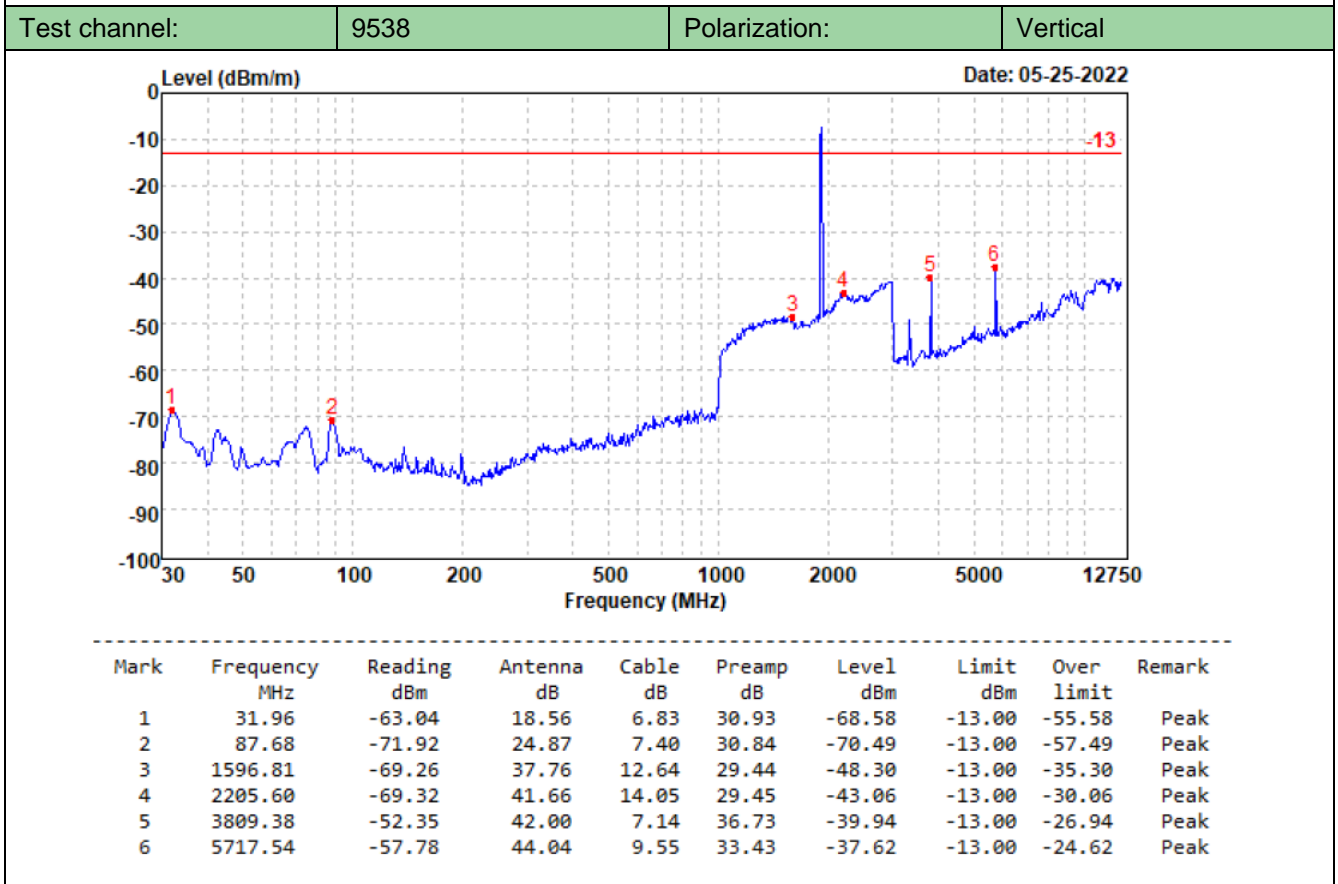
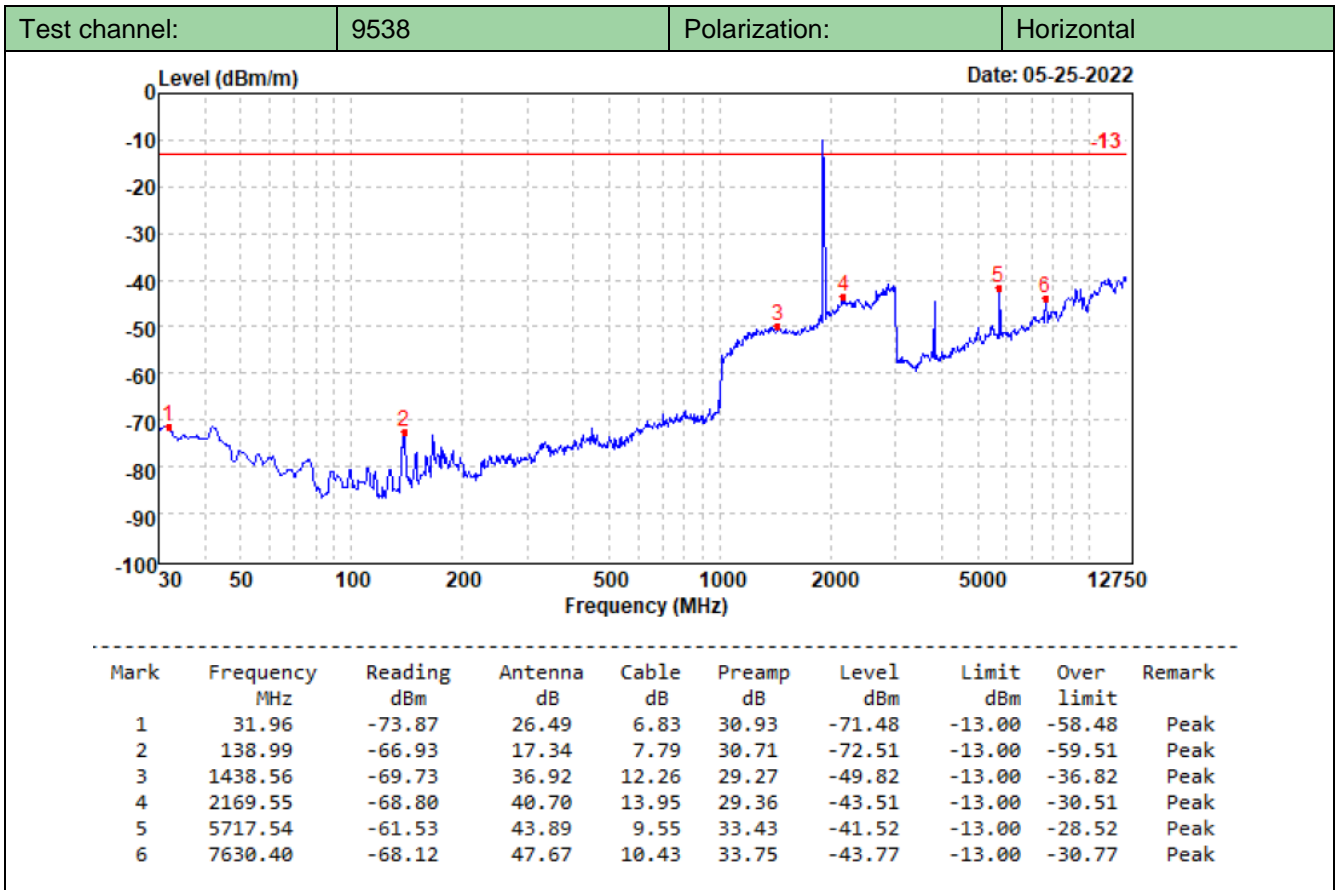

Remark:

1. The emission behaviour belongs to narrowband spurious emission.
2. The emission levels of not record in the report are very lower than the limit and not show in test report.

WCDMA Band V

Test channel: 4132 Polarization: Horizontal

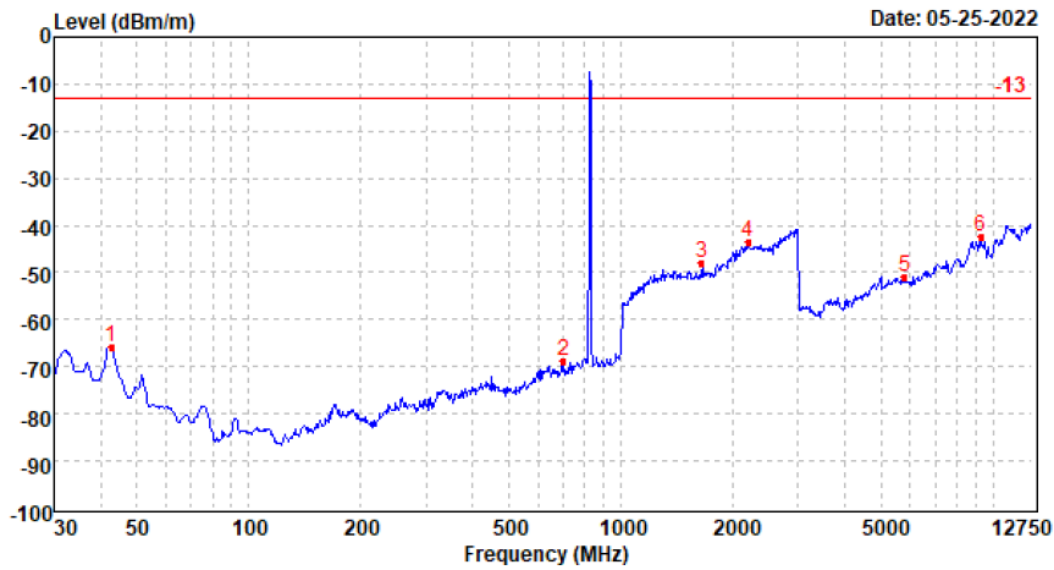

Mark	Frequency MHz	Reading dBm	Antenna dB	Cable dB	Preamp dB	Level dBm	Limit dBm	Over limit	Remark
1	42.79	-68.42	26.49	6.96	30.89	-65.86	-13.00	-52.86	Peak
2	700.64	-77.33	28.21	10.26	30.10	-68.96	-13.00	-55.96	Peak
3	1652.13	-67.13	36.17	12.76	29.57	-47.77	-13.00	-34.77	Peak
4	2203.18	-68.98	40.95	14.04	29.45	-43.44	-13.00	-30.44	Peak
5	5792.66	-71.13	43.99	9.59	33.24	-50.79	-13.00	-37.79	Peak
6	9280.59	-72.49	49.55	11.75	31.19	-42.38	-13.00	-29.38	Peak

Test channel: 4132 Polarization: Vertical



Mark	Frequency MHz	Reading dBm	Antenna dB	Cable dB	Preamp dB	Level dBm	Limit dBm	Over limit	Remark
1	31.96	-62.10	18.56	6.83	30.93	-67.64	-13.00	-54.64	Peak
2	87.68	-71.77	24.87	7.40	30.84	-70.34	-13.00	-57.34	Peak
3	1652.13	-62.62	36.12	12.76	29.57	-43.31	-13.00	-30.31	Peak
4	2234.87	-68.39	41.29	14.12	29.52	-42.50	-13.00	-29.50	Peak
5	5775.88	-69.00	44.10	9.58	33.34	-48.66	-13.00	-35.66	Peak
6	8821.27	-72.86	49.44	11.94	30.75	-42.23	-13.00	-29.23	Peak

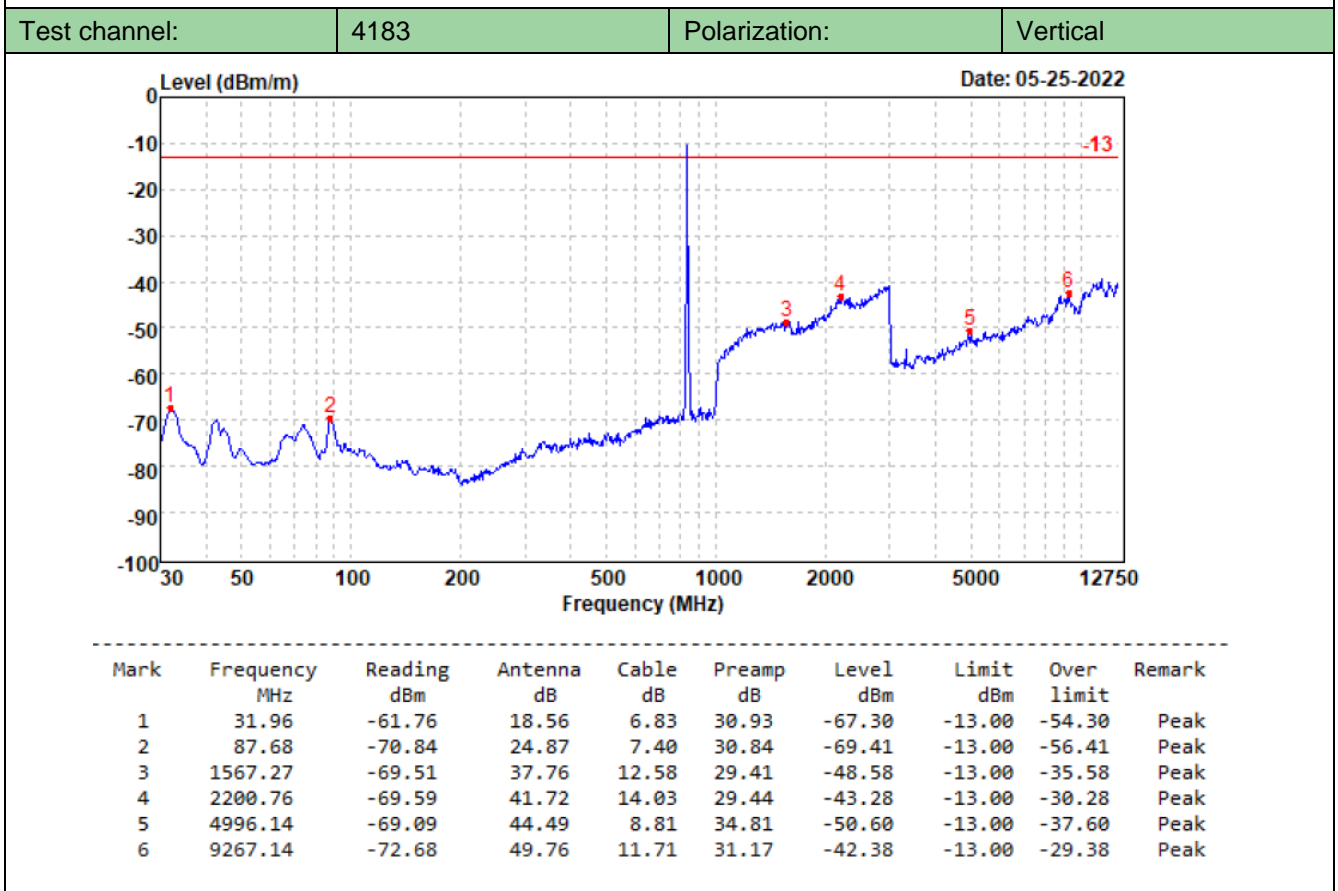
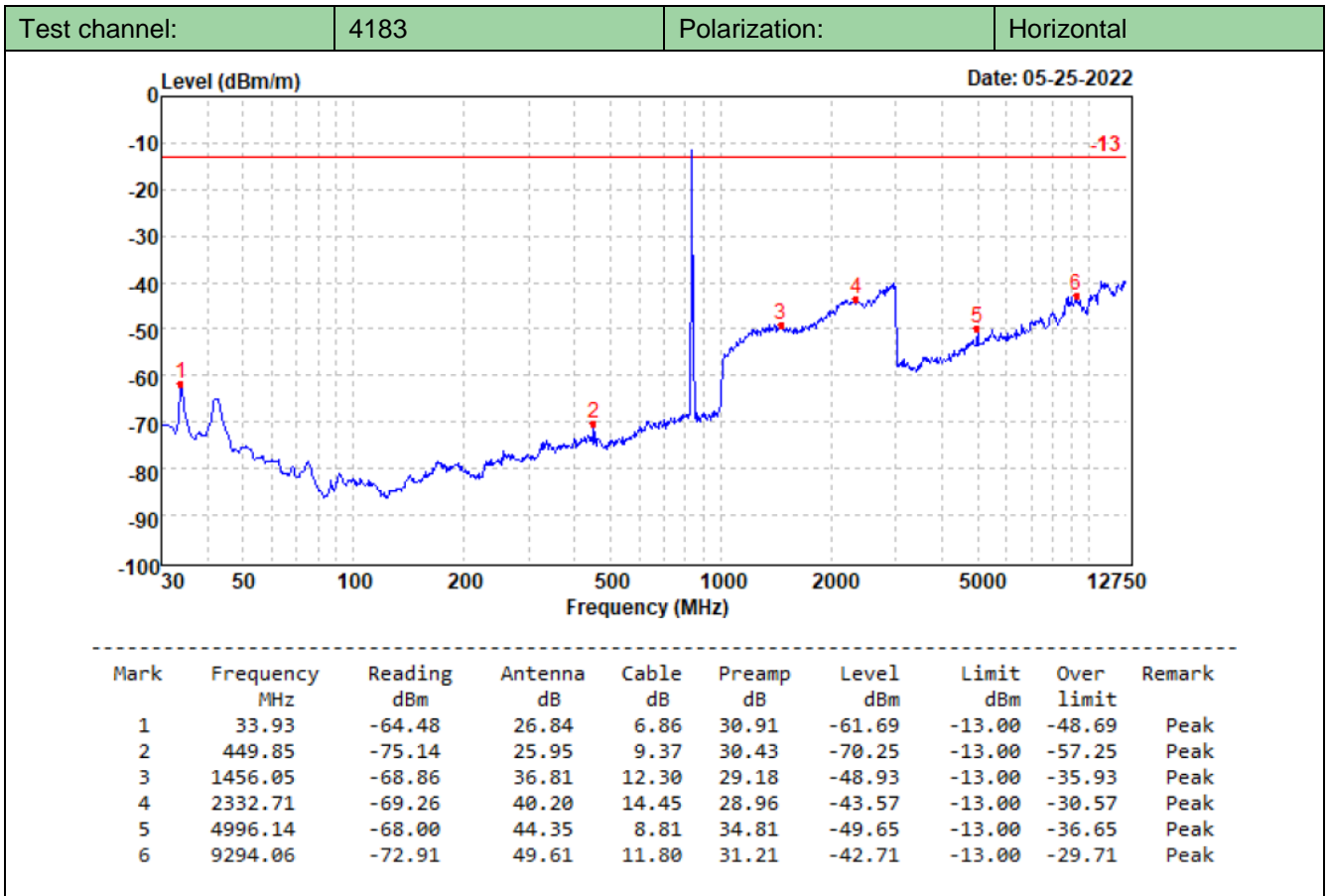

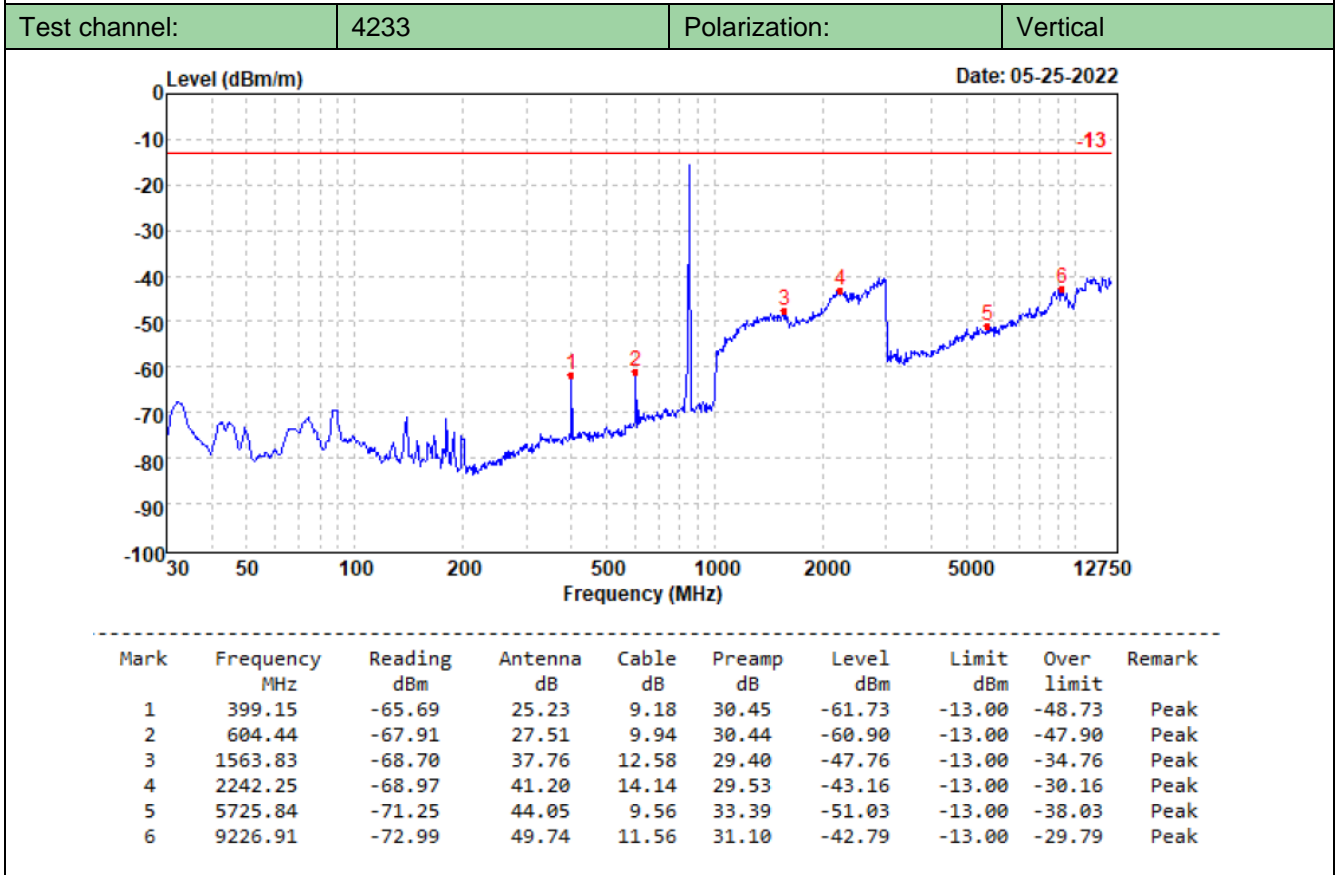
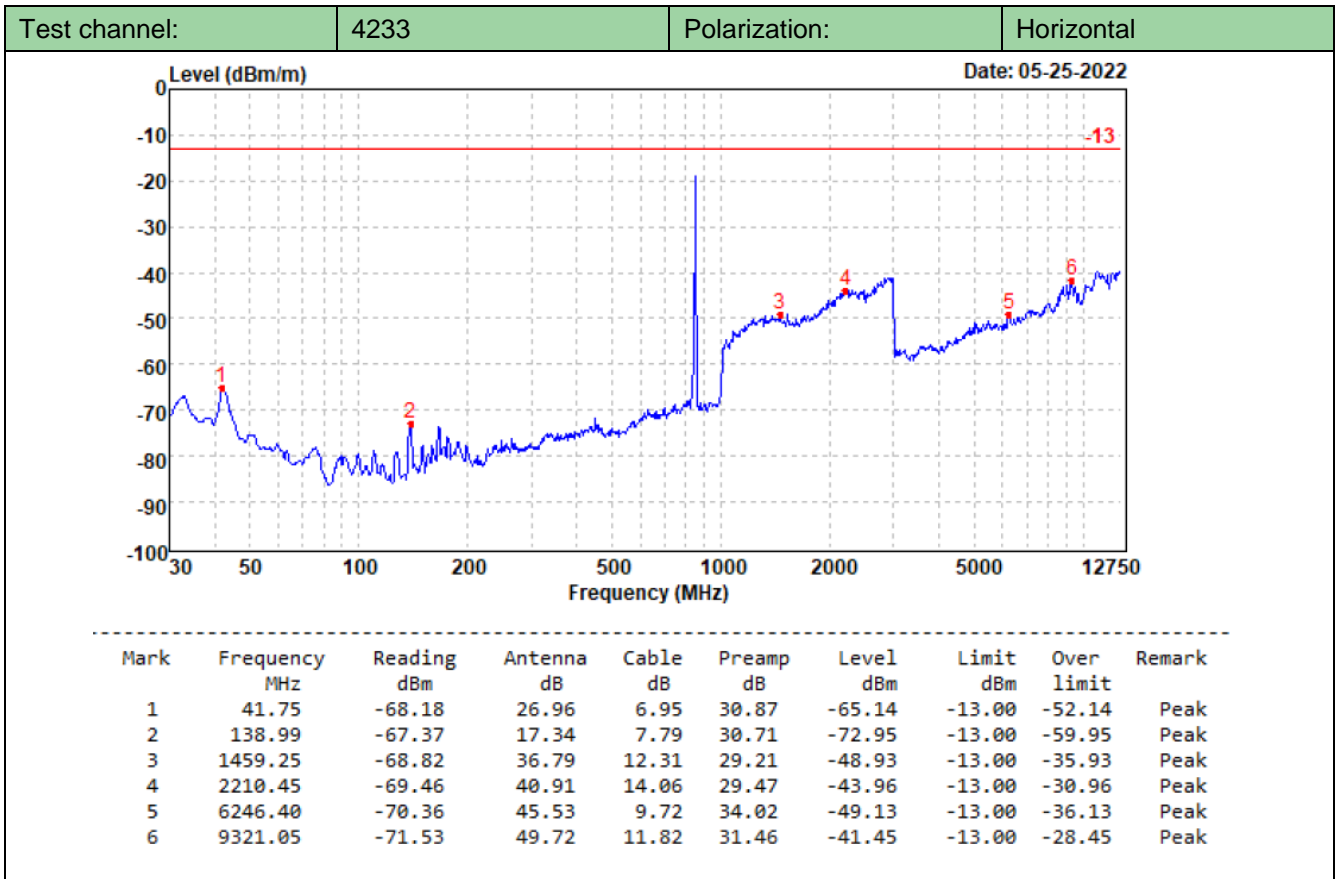

Remark:

1. The emission behaviour belongs to narrowband spurious emission.
2. The emission levels of not record in the report are very lower than the limit and not show in test report.

6. TEST SETUP PHOTOS OF THE EUT

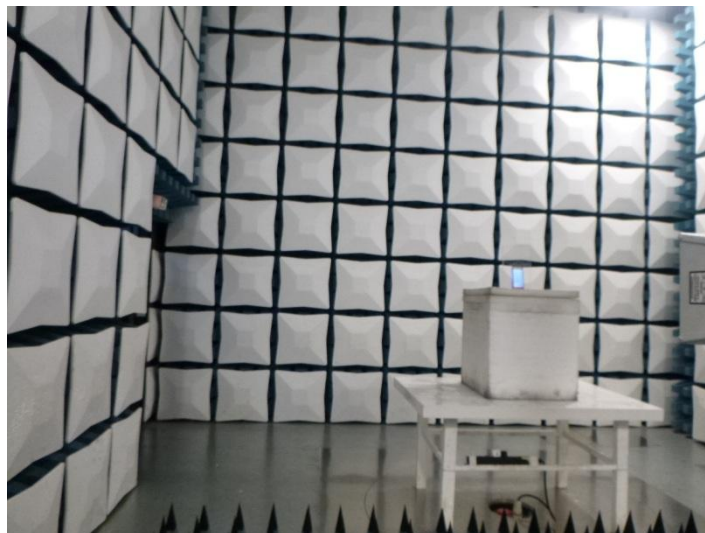
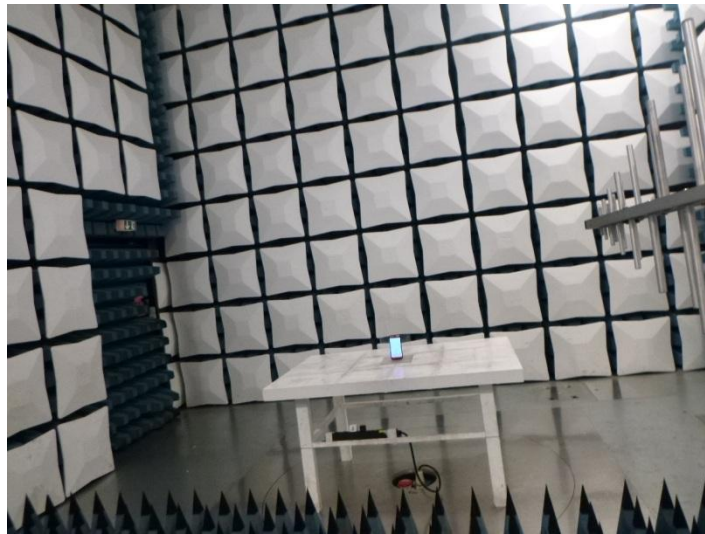

7. EXTERNAL AND INTERNAL PHOTOS OF THE EUT

Refer to the test report No.: CHTEW22060005

8. APPENDIX REPORT

APPENDIX REPORT

Project No.	SHT2205032403EW	Radio Specification	WCDMA
Test sample No.	YPHT22050324006	Model No.	P60
Start test date	2022/5/25	Finish date	2022/5/25
Temperature	24°C	Humidity	38%
Test Engineer	Tiancheng.Huang	Auditor	<i>Xiaodong Zhe</i>

Appendix clause	Test item	Result
A	Conducted Output Power	PASS
B	Peak-to-Average Ratio	PASS
C	26 dB Bandwidth and Occupied Bandwidth	PASS
D	Band edge	PASS
E	Conducted Spurious Emission	PASS
F	Frequency Stability	PASS
G	ERP and EIRP	PASS

8.1 Appendix A: Conducted Output Power

Test Result

Band	Channel	Power(dBm)	Limit(dBm)	Verdict
Band II	9262	23.88	33	PASS
Band II	9400	24.01	33	PASS
Band II	9538	23.99	33	PASS
Band V	4132	24.29	38.5	PASS
Band V	4182	24.26	38.5	PASS
Band V	4233	23.98	38.5	PASS

Band	Channel	SubTest	Power(dBm)	Limit(dBm)	Verdict
Band II	9262	HSDPA_Sub1	22.55	33	PASS
Band II	9262	HSDPA_Sub2	22.11	33	PASS
Band II	9262	HSDPA_Sub3	21.74	33	PASS
Band II	9262	HSDPA_Sub4	21.52	33	PASS
Band II	9400	HSDPA_Sub1	23.95	33	PASS
Band II	9400	HSDPA_Sub2	23.45	33	PASS
Band II	9400	HSDPA_Sub3	23.17	33	PASS
Band II	9400	HSDPA_Sub4	22.97	33	PASS
Band II	9538	HSDPA_Sub1	23.23	33	PASS
Band II	9538	HSDPA_Sub2	22.83	33	PASS
Band II	9538	HSDPA_Sub3	22.51	33	PASS
Band II	9538	HSDPA_Sub4	22.36	33	PASS
Band V	4132	HSDPA_Sub1	23.14	38.5	PASS
Band V	4132	HSDPA_Sub2	23.46	38.5	PASS
Band V	4132	HSDPA_Sub3	22.59	38.5	PASS
Band V	4132	HSDPA_Sub4	22.58	38.5	PASS
Band V	4182	HSDPA_Sub1	23.51	38.5	PASS
Band V	4182	HSDPA_Sub2	23.70	38.5	PASS
Band V	4182	HSDPA_Sub3	22.98	38.5	PASS
Band V	4182	HSDPA_Sub4	22.90	38.5	PASS
Band V	4233	HSDPA_Sub1	22.56	38.5	PASS
Band V	4233	HSDPA_Sub2	22.86	38.5	PASS
Band V	4233	HSDPA_Sub3	22.00	38.5	PASS
Band V	4233	HSDPA_Sub4	22.02	38.5	PASS

Band	Channel	SubTest	Power(dBm)	Limit(dBm)	Verdict
Band II	9262	HSUPA_Sub1	19.55	33	PASS
Band II	9262	HSUPA_Sub2	19.67	33	PASS
Band II	9262	HSUPA_Sub3	19.45	33	PASS
Band II	9262	HSUPA_Sub4	19.71	33	PASS
Band II	9262	HSUPA_Sub5	22.71	33	PASS
Band II	9400	HSUPA_Sub1	20.88	33	PASS
Band II	9400	HSUPA_Sub2	21.05	33	PASS
Band II	9400	HSUPA_Sub3	20.79	33	PASS
Band II	9400	HSUPA_Sub4	21.11	33	PASS
Band II	9400	HSUPA_Sub5	24.02	33	PASS
Band II	9538	HSUPA_Sub1	20.48	33	PASS
Band II	9538	HSUPA_Sub2	20.66	33	PASS
Band II	9538	HSUPA_Sub3	20.34	33	PASS
Band II	9538	HSUPA_Sub4	20.73	33	PASS
Band II	9538	HSUPA_Sub5	23.49	33	PASS
Band V	4132	HSUPA_Sub1	19.90	38.5	PASS
Band V	4132	HSUPA_Sub2	20.02	38.5	PASS
Band V	4132	HSUPA_Sub3	20.21	38.5	PASS
Band V	4132	HSUPA_Sub4	20.10	38.5	PASS
Band V	4132	HSUPA_Sub5	23.78	38.5	PASS
Band V	4182	HSUPA_Sub1	19.81	38.5	PASS
Band V	4182	HSUPA_Sub2	20.02	38.5	PASS
Band V	4182	HSUPA_Sub3	20.24	38.5	PASS
Band V	4182	HSUPA_Sub4	20.06	38.5	PASS
Band V	4182	HSUPA_Sub5	23.78	38.5	PASS
Band V	4233	HSUPA_Sub1	19.23	38.5	PASS
Band V	4233	HSUPA_Sub2	19.36	38.5	PASS
Band V	4233	HSUPA_Sub3	19.57	38.5	PASS
Band V	4233	HSUPA_Sub4	19.48	38.5	PASS
Band V	4233	HSUPA_Sub5	23.05	38.5	PASS

8.2 Appendix B: Peak-to-Average Ratio

Test Result

Band	Channel	Peak-to-Average Ratio(dB)	Limit(dB)	Verdict
Band II	9262	2.65	13	PASS
Band II	9400	2.94	13	PASS
Band II	9538	2.63	13	PASS
Band V	4132	3.07	13	PASS
Band V	4182	2.76	13	PASS
Band V	4233	2.95	13	PASS

Test Graphs

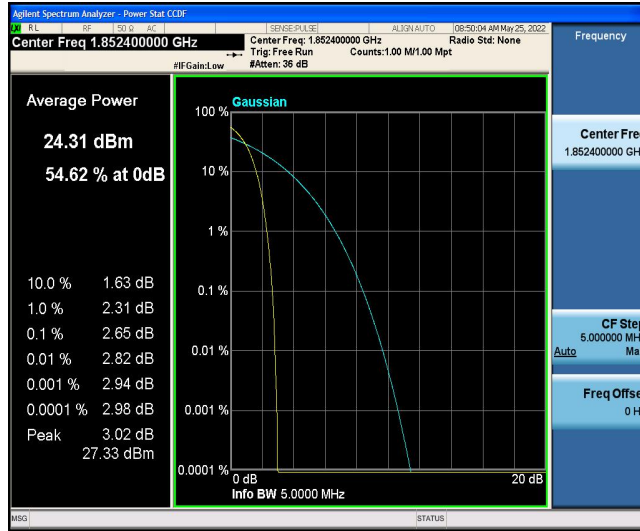

Band II_9262

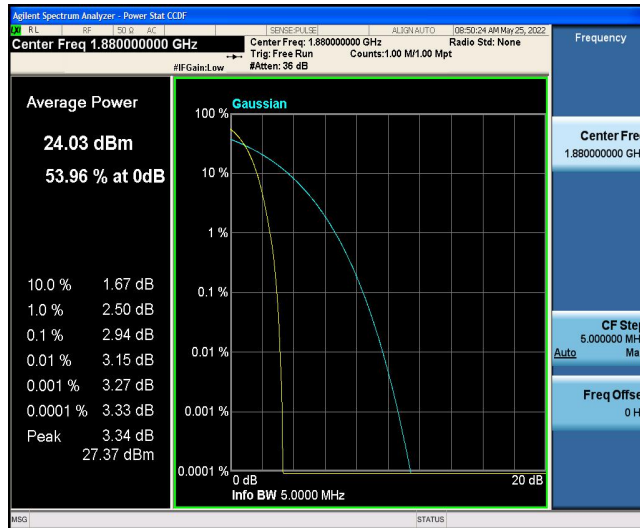

Band II_9400

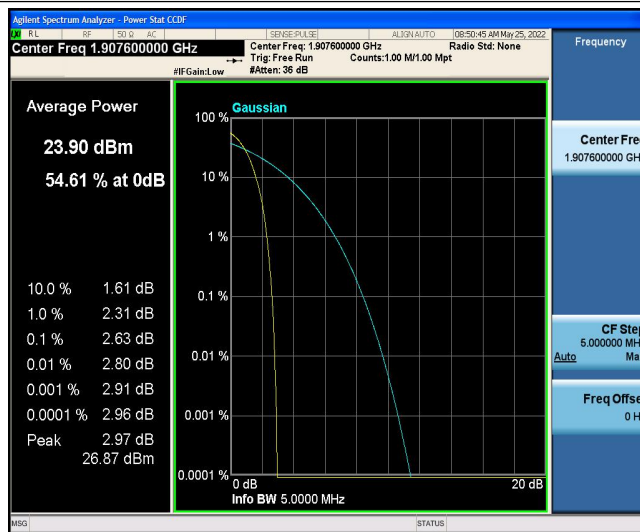

Band II_9538



Band V_4132



Band V_4182

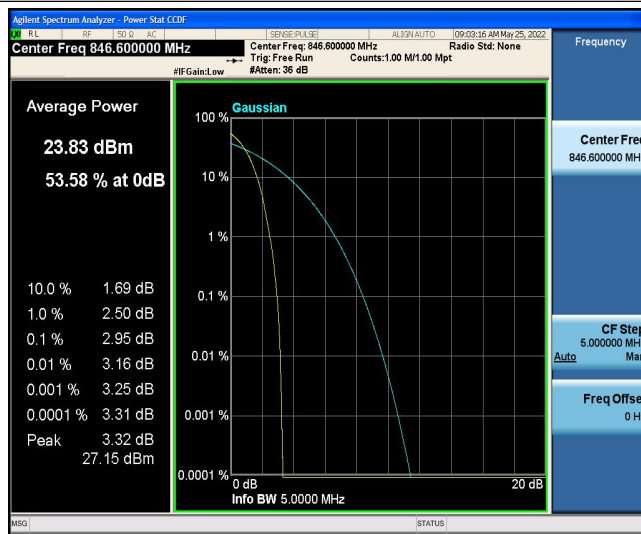

Band V_4233

8.3 Appendix C: 26dB Bandwidth and Occupied Bandwidth

Test Result

Band	Channel	Occupied Bandwidth (kHz)	26dB Bandwidth (kHz)	Limit(kHz)	Verdict
Band II	9262	4160.9	4720	---	PASS
Band II	9400	4143.3	4682	---	PASS
Band II	9538	4129.3	4679	---	PASS
Band V	4132	4157.8	4663	---	PASS
Band V	4182	4154.8	4687	---	PASS
Band V	4233	4155.5	4677	---	PASS

Test Graphs



Band II_9262

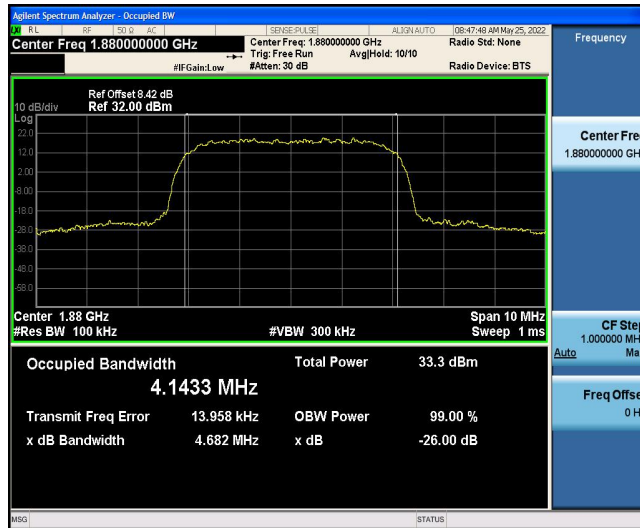

Band II_9400

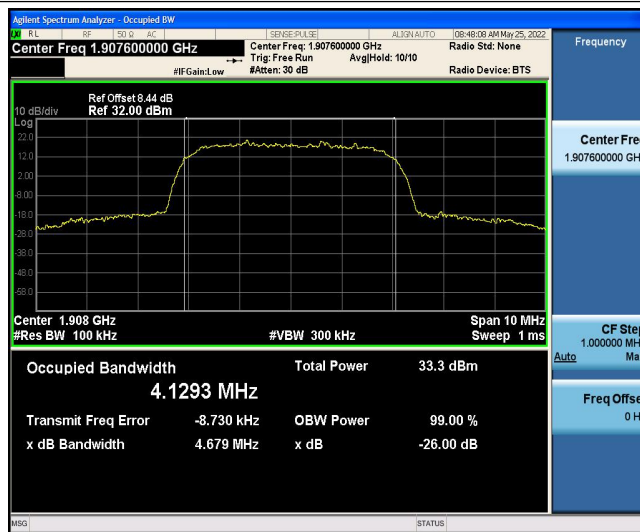

Band II_9538

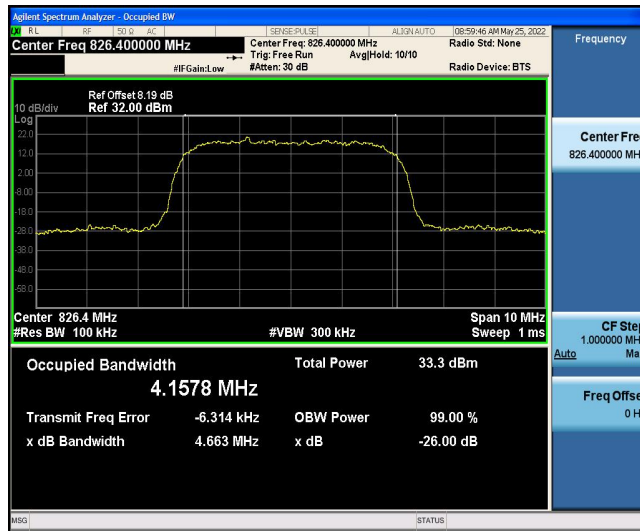

Band V_4132



Band V_4182

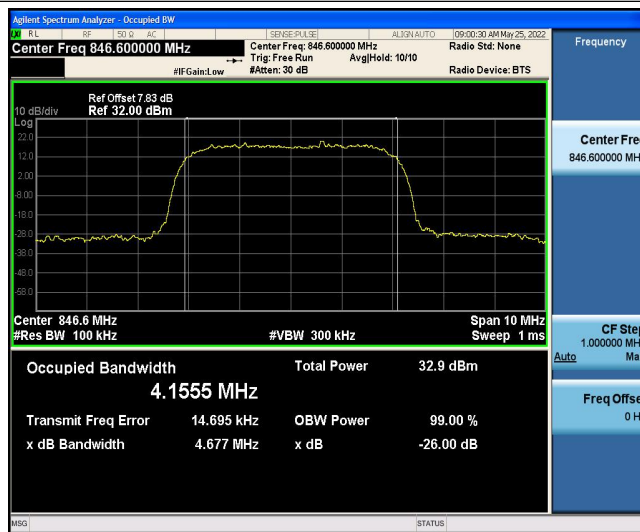

Band V_4233

8.4 Appendix D: Band Edge

Test Result

Band	Channel	Value(dBm)	Limit(dBm)	Verdict
Band II	9262	-20.15	-13	PASS
Band II	9538	-21.73	-13	PASS
Band V	4132	-24.44	-13	PASS
Band V	4233	-24.98	-13	PASS

Test Graphs



Band II_9262



Band II_9538



Band V_4132



Band V_4233

8.5 Appendix E: Conducted Spurious Emission

Test Result

Band	Channel	Frequency Rang(Mhz)	Value(dBm)	Limit(dBm)	Verdict
Band II	9262	30~1000	-46.79	-13	PASS
Band II	9262	1000~20000	-25.83	-13	PASS
Band II	9400	30~1000	-46.35	-13	PASS
Band II	9400	1000~20000	-25.65	-13	PASS
Band II	9538	30~1000	-46.21	-13	PASS
Band II	9538	1000~20000	-25.74	-13	PASS
Band V	4132	30~1000	-46.52	-13	PASS
Band V	4132	1000~10000	-32.25	-13	PASS
Band V	4182	30~1000	-46.53	-13	PASS
Band V	4182	1000~10000	-32.37	-13	PASS
Band V	4233	30~1000	-46.77	-13	PASS
Band V	4233	1000~10000	-32.04	-13	PASS

Test Graphs

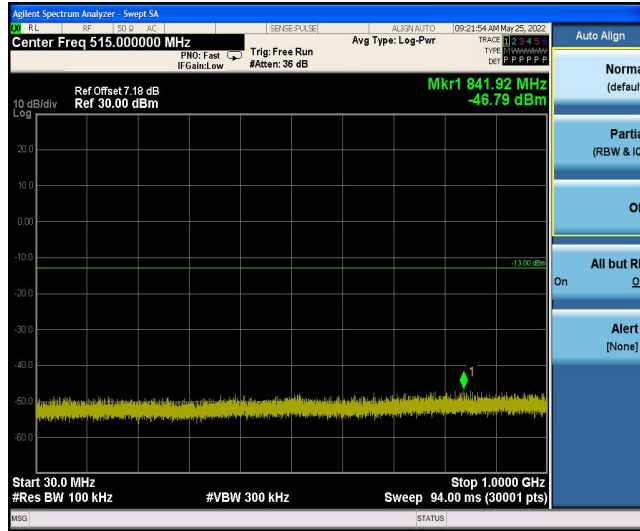

Band II_9262



Band II_9262

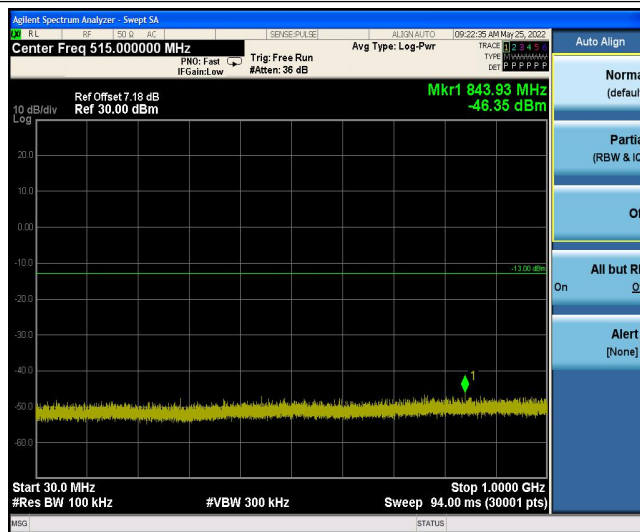

Band II_9400



Band II_9400

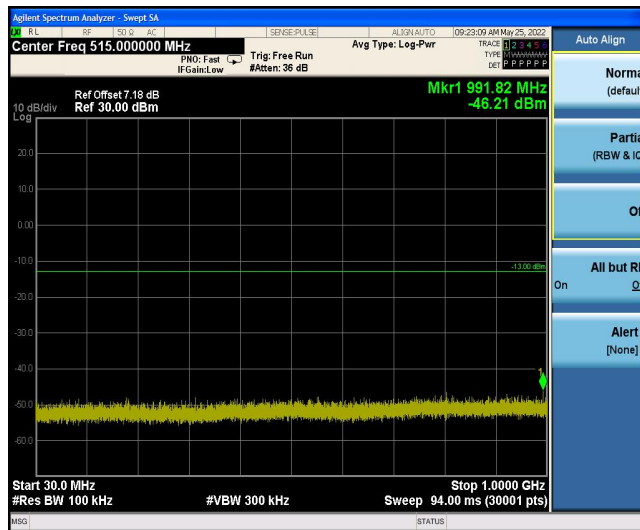

Band II_9538

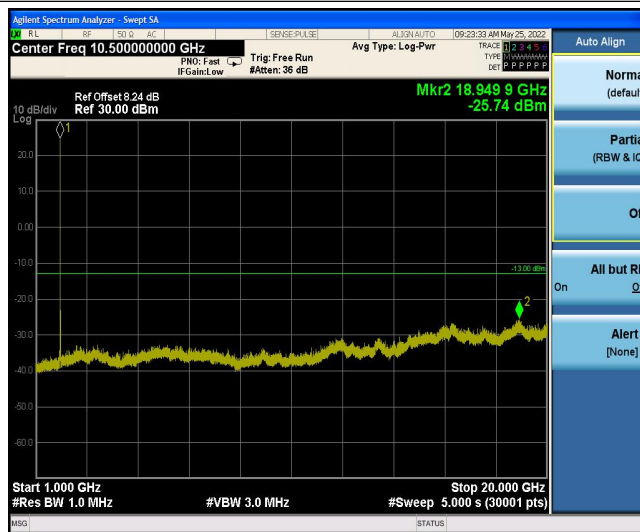

Band II_9538



Band V_4132



Band V_4132

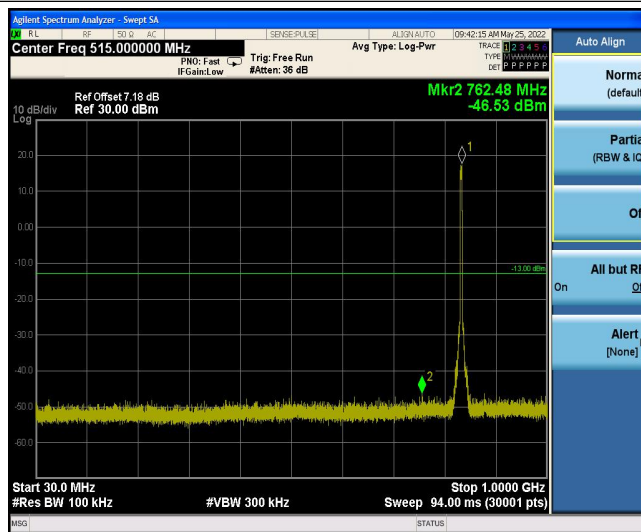

Band V_4182



Band V_4182



Band V_4233

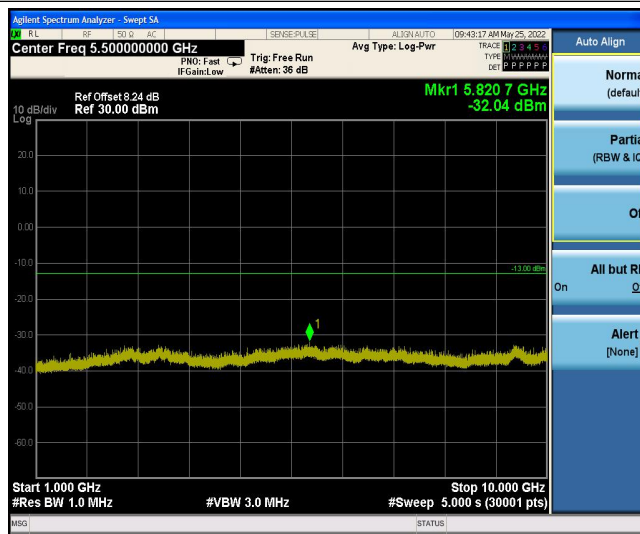

Band V_4233

8.6 Appendix F: Frequency Stability

Test Result

Voltage							
Band	Channel	Voltage (Vdc)	Temperature (°C)	Deviation (Hz)	Deviation (ppm)	Limit (ppm)	Verdict
Band II	9262	VL	TN	-2.65	-0.001431	2.5	PASS
Band II	9262	VN	TN	-1.60	-0.000864	2.5	PASS
Band II	9262	VH	TN	-1.09	-0.000588	2.5	PASS
Band II	9400	VL	TN	2.17	0.001154	2.5	PASS
Band II	9400	VN	TN	0.96	0.000511	2.5	PASS
Band II	9400	VH	TN	2.09	0.001112	2.5	PASS
Band II	9538	VL	TN	2.40	0.001258	2.5	PASS
Band II	9538	VN	TN	-2.96	-0.001552	2.5	PASS
Band II	9538	VH	TN	-1.53	-0.000802	2.5	PASS
Band V	4132	VL	TN	-12.08	-0.014618	2.5	PASS
Band V	4132	VN	TN	2.71	0.003279	2.5	PASS
Band V	4132	VH	TN	-12.01	-0.014533	2.5	PASS
Band V	4182	VL	TN	5.91	0.007066	2.5	PASS
Band V	4182	VN	TN	-2.65	-0.003168	2.5	PASS
Band V	4182	VH	TN	0.72	0.000861	2.5	PASS
Band V	4233	VL	TN	-1.02	-0.001205	2.5	PASS
Band V	4233	VN	TN	-0.38	-0.000449	2.5	PASS
Band V	4233	VH	TN	2.06	0.002433	2.5	PASS

Temperature							
Band	Channel	Voltage (Vdc)	Temperature (°C)	Deviation (Hz)	Deviation (ppm)	Limit (ppm)	Verdict
Band II	9262	VN	-30	2.32	0.001252	2.5	PASS
Band II	9262	VN	-20	0.37	0.000200	2.5	PASS
Band II	9262	VN	-10	1.10	0.000594	2.5	PASS
Band II	9262	VN	0	-1.29	-0.000696	2.5	PASS
Band II	9262	VN	10	-3.12	-0.001684	2.5	PASS
Band II	9262	VN	20	-5.41	-0.002921	2.5	PASS
Band II	9262	VN	30	-4.30	-0.002321	2.5	PASS
Band II	9262	VN	40	1.63	0.000880	2.5	PASS
Band II	9262	VN	50	-0.30	-0.000162	2.5	PASS
Band II	9400	VN	-30	1.72	0.000915	2.5	PASS
Band II	9400	VN	-20	1.98	0.001053	2.5	PASS
Band II	9400	VN	-10	0.53	0.000282	2.5	PASS
Band II	9400	VN	0	-1.88	-0.001000	2.5	PASS
Band II	9400	VN	10	1.95	0.001037	2.5	PASS
Band II	9400	VN	20	-0.62	-0.000330	2.5	PASS
Band II	9400	VN	30	1.19	0.000633	2.5	PASS
Band II	9400	VN	40	-1.28	-0.000681	2.5	PASS
Band II	9400	VN	50	4.22	0.002245	2.5	PASS
Band II	9538	VN	-30	1.41	0.000739	2.5	PASS
Band II	9538	VN	-20	1.70	0.000891	2.5	PASS
Band II	9538	VN	-10	2.20	0.001153	2.5	PASS
Band II	9538	VN	0	0.38	0.000199	2.5	PASS
Band II	9538	VN	10	1.49	0.000781	2.5	PASS
Band II	9538	VN	20	-0.10	-0.000052	2.5	PASS
Band II	9538	VN	30	0.30	0.000157	2.5	PASS
Band II	9538	VN	40	-2.25	-0.001179	2.5	PASS
Band II	9538	VN	50	-1.42	-0.000744	2.5	PASS
Band V	4132	VN	-30	-1.47	-0.001779	2.5	PASS
Band V	4132	VN	-20	-8.33	-0.010080	2.5	PASS
Band V	4132	VN	-10	-0.74	-0.000895	2.5	PASS
Band V	4132	VN	0	-4.06	-0.004913	2.5	PASS
Band V	4132	VN	10	-5.34	-0.006462	2.5	PASS
Band V	4132	VN	20	12.02	0.014545	2.5	PASS
Band V	4132	VN	30	1.95	0.002360	2.5	PASS
Band V	4132	VN	40	7.77	0.009402	2.5	PASS
Band V	4132	VN	50	3.89	0.004707	2.5	PASS
Band V	4182	VN	-30	-9.84	-0.011765	2.5	PASS
Band V	4182	VN	-20	-10.25	-0.012255	2.5	PASS
Band V	4182	VN	-10	-9.68	-0.011573	2.5	PASS
Band V	4182	VN	0	-6.00	-0.007174	2.5	PASS
Band V	4182	VN	10	-11.23	-0.013427	2.5	PASS
Band V	4182	VN	20	-6.34	-0.007580	2.5	PASS
Band V	4182	VN	30	-3.60	-0.004304	2.5	PASS
Band V	4182	VN	40	-4.66	-0.005571	2.5	PASS
Band V	4182	VN	50	-2.49	-0.002977	2.5	PASS
Band V	4233	VN	-30	-2.22	-0.002622	2.5	PASS

Band V	4233	VN	-20	0.46	0.000543	2.5	PASS
Band V	4233	VN	-10	0.47	0.000555	2.5	PASS
Band V	4233	VN	0	-0.23	-0.000272	2.5	PASS
Band V	4233	VN	10	-0.98	-0.001158	2.5	PASS
Band V	4233	VN	20	-0.11	-0.000130	2.5	PASS
Band V	4233	VN	30	1.07	0.001264	2.5	PASS
Band V	4233	VN	40	-1.91	-0.002256	2.5	PASS
Band V	4233	VN	50	0.44	0.000520	2.5	PASS

8.7 Appendix G: ERP and EIRP

Test Result

Band	Mode	Conducted Power (dBm)	Antenna Gain (dBi)	EIRP		Limit (W)	Verdict
				(dBm)	(W)		
Band II	WCMDA	24.01	1.20	25.21	0.3319	2	PASS
	HSDPA	23.95	1.20	25.15	0.3273	2	PASS
	HSUPA	24.02	1.20	25.22	0.3327	2	PASS

Band	Mode	Conducted Power (dBm)	Antenna Gain (dBi)	ERP		Limit (W)	Verdict
				(dBm)	(W)		
Band V	WCMDA	24.29	0.60	22.74	0.1879	7	PASS
	HSDPA	23.70	0.60	22.15	0.1641	7	PASS
	HSUPA	23.78	0.60	22.23	0.1671	7	PASS

-----End of the Report -----