

TEST REPORT

For Bluetooth-EDR



Report No. : **CHTEW23120049** Report Verification:

Project No...... : **SHT2310062301EW**

FCC ID..... : **2ASWW-STAR10PRO**

Applicant's name..... : **XINCHUANGXIN INTERNATIONAL CO. LTD**

Address..... : **ROOM 605 6/F, FA YUEN COMMERCIAL BUILDING, 75-77 FA YUEN STREET MONGKOK KL**

Product Name : **Tablet**

Trade Mark : **CORN**

Model No. : **Star10 Pro**

Listed Model(s) : **-**

Standard : **FCC CFR Title 47 Part 15 Subpart C § 15.247**

Date of receipt of test sample..... : **Nov. 01, 2023**

Date of testing..... : **Nov. 02, 2023- Dec. 20, 2023**

Date of issue..... : **Dec. 21, 2023**

Result..... : **PASS**

Compiled by
 (Position+Printed name+Signature): **File administrators Xiaodong Zhao** *Xiaodong Zhao*

Supervised by
 (Position+Printed name+Signature): **Project Engineer Xiaodong Zhao** *Xiaodong Zhao*

Approved by
 (Position+Printed name+Signature): **Manager Xu Yang** *Xu Yang*

Testing Laboratory Name : **Shenzhen Huatongwei International Inspection Co., Ltd.**

Address..... : **Building 7, Baiwang Idea Factory, No.1051, Songbai Road, Yangguang Community, Xili Subdistrict, Nanshan District, Shenzhen, Guangdong, China**

Shenzhen Huatongwei International Inspection Co., Ltd. All rights reserved.

This publication may be reproduced in whole or in part for non-commercial purposes as long as the Shenzhen Huatongwei International Inspection Co., Ltd. is acknowledged as copyright owner and source of the material. Shenzhen Huatongwei International Inspection Co., Ltd. takes no responsibility for and will not assume liability for damages resulting from the reader's interpretation of the reproduced material due to its placement and context. The test report merely correspond to the test sample.

Contents

1.	TEST STANDARDS AND REPORT VERSION	3
1.1.	Test Standards	3
1.2.	Report version	3
2.	TEST DESCRIPTION	4
3.	SUMMARY	5
3.1.	Client Information	5
3.2.	Product Description	5
3.3.	Radio Specification Description	5
3.4.	Testing Laboratory Information	6
4.	TEST CONFIGURATION	7
4.1.	Test frequency list	7
4.2.	Descriptions of Test mode	7
4.3.	Test mode	7
4.4.	Test sample information	8
4.5.	Support unit used in test configuration and system	8
4.6.	Testing environmental condition	8
4.7.	Statement of the measurement uncertainty	9
4.8.	Equipment Used during the Test	10
5.	TEST CONDITIONS AND RESULTS	12
5.1.	Antenna Requirement	12
5.2.	AC Conducted Emission	13
5.3.	Peak Output Power	16
5.4.	20 dB Bandwidth	17
5.5.	99% Occupied Bandwidth	18
5.6.	Carrier Frequencies Separation	19
5.7.	Hopping Channel Number	20
5.8.	Dwell Time	21
5.9.	Duty Cycle Correction Factor (DCCF)	22
5.10.	Pseudorandom Frequency Hopping Sequence	23
5.11.	Conducted Band edge and Spurious Emission	24
5.12.	Radiated Band edge Emission	26
5.13.	Radiated Spurious Emission	28
6.	TEST SETUP PHOTOS	33
7.	EXTERNAL AND INTERNAL PHOTOS	35
8.	APPENDIX REPORT	35

1. TEST STANDARDS AND REPORT VERSION

1.1. Test Standards

The tests were performed according to following standards:

- [FCC CFR Title 47 Part 15 Subpart C § 15.247](#): Operation within the bands 902-928 MHz, 2400-2483.5 MHz, and 5725-5850 MHz
- [ANSI C63.10:2020](#): American National Standard for Testing Unlicensed Wireless Devices
- [KDB 558074 D01 15.247 Meas Guidance v05r02](#): Guidance for Compliance Measurements on Digital Transmission System, Frequency Hopping Spread Spectrum System, and Hybrid System Devices Operating under Section 15.247 of The FCC Rules

1.2. Report version

Revision No.	Date of issue	Description
N/A	2023-12-21	Original

2. TEST DESCRIPTION

Report clause	Test Items	Standard Requirement	Result	Test Engineer
5.1	Antenna Requirement	15.203/15.247 (c)	PASS	Xiaodong Zhao
5.2	AC Conducted Emission	15.207	PASS	Junman Wang
5.3	Peak Output Power	15.247 (b)(1)	PASS	Xiangyu Wei
5.4	20 dB Bandwidth	15.247 (a)(1)	PASS	Xiangyu Wei
5.5	99% Occupied Bandwidth	-	PASS ^{*1}	Xiangyu Wei
5.6	Carrier Frequency Separation	15.247 (a)(1)	PASS	Xiangyu Wei
5.7	Hopping Channel Number	15.247 (a)(1)	PASS	Xiangyu Wei
5.8	Dwell Time	15.247 (a)(1)	PASS	Xiangyu Wei
5.9	Duty Cycle Correction Factor	-	PASS ^{*1}	Xiangyu Wei
5.10	Pseudorandom Frequency Hopping Sequence	15.247(b)(4)	PASS	Xiangyu Wei
5.11	Conducted Band Edge and Spurious Emission	15.247(d)/15.205	PASS	Xiangyu Wei
5.12	Radiated Band Edge Emission	15.205/15.209	PASS	Yifan Wang
5.13	Radiated Spurious Emission	15.247(d)/15.205/15.209	PASS	Yifan Wang

Note:

- The measurement uncertainty is not included in the test result.
- ^{*1}: No requirement on standard, only report these test data.

3. SUMMARY

3.1. Client Information

Applicant:	XINCHUANGXIN INTERNATIONAL CO. LTD
Address:	ROOM 605 6/F, FA YUEN COMMERCIAL BUILDING, 75-77 FA YUEN STREET MONGKOK KL
Manufacturer:	Shenzhen Chiteng Technology Co.,LTD
Address:	Second Floor,Area A, Building 4, Huiye Technology Workshop, Guanguang Road, Tangjia Community, Gongming Street, Guangming New District, Shenzhen, Guangdong

3.2. Product Description

Main unit information:	
Product Name:	Tablet
Trade Mark:	CORN
Model No.:	Star10 Pro
Listed Model(s):	-
Power supply:	DC 3.8V from Battery
Hardware version:	T30-T616-V2.0-230725-LU
Software version:	CORN_Star10_Pro_V01
Accessory unit information:	
Battery information:	JJY 3092142/3.8V/24 6000mAh /22.8Wh /DI
Adapter information:	Model: ENGY Pro 24 INPUT: 100~240V-50/60Hz 0.35A OUTPUT: DC 5.0V 2A

3.3. Radio Specification Description

Bluetooth version:	V5.0
Support function:	EDR
Modulation:	GFSK, $\pi/4$ DQPSK, 8DPSK
Operation frequency:	2402MHz~2480MHz
Channel number:	79
Channel separation:	1MHz
Antenna type:	PIFA
Antenna gain:	2.6dBi

3.4. Testing Laboratory Information

Laboratory Name	Shenzhen Huatongwei International Inspection Co., Ltd.	
Laboratory Location	Building 7, Baiwang Idea Factory, No.1051, Songbai Road, Yangguang Community, Xili Subdistrict, Nanshan District, Shenzhen, Guangdong, China	
Contact information:	Tel: 86-755-26715499 E-mail: cs@szhtw.com.cn http://www.szhtw.com.cn	
Qualifications:	Type	Accreditation Number
	FCC Registration Number	762235
	FCC Designation Number	CN1181

4. TEST CONFIGURATION

4.1. Test frequency list

According to section 15.31(m), regards to the operating frequency range over 10 MHz, must select three channels which were tested. The Lowest frequency, the middle frequency, and the highest frequency of channel were selected to perform the test, please see the below blue front.

Channel	Frequency (MHz)
00	2402
01	2403
:	:
39	2441
:	:
77	2479
78	2480

4.2. Descriptions of Test mode

Preliminary tests were performed in different data rates and recorded the RF output power in the clause 5.3

Note:

- 1) The manufacturer declare that the maximum power value of the product is set as a default value in the enter test mode software.
- 2) All the test data for each data rate were verified, found 8DPSK Modulation which is worse case mode

4.3. Test mode

For RF test items:			
The engineering test program was provided and enabled to make EUT continuous transmitting.			
Test Item	Modulation / Data Rate		
	GFSK 1Mbps	$\pi/4$ DQPSK 2Mbps	8DPSK 3Mbps
Conducted test item	✓	✓	✓
Radiated test item	-	-	✓
Remark:			
<ul style="list-style-type: none"> – For radiated test item, the worst mode data rate 3Mbps was reported only, because this data rate has the highest RF output power at preliminary tests. – The EUT in each of three orthogonal axis emissions had been tested, but only the worst case (X axis) data recorded in the report. 			

4.4. Test sample information

Test item	HTW sample no.
RF Conducted test items	Refer to the description in the appendix report
RF Radiated test items	YPHT23100623001
EMI test items	YPHT23100623001

Note:

RF Conducted test items: Peak Output Power, 20 dB Bandwidth, 99% Occupied Bandwidth, Carrier Frequency Separation, Hopping Channel Number, Dwell Time, Duty Cycle Correction Factor, Pseudorandom Frequency Hopping Sequence, Conducted Band Edge and Spurious Emission

RF Radiated test items: Radiated Band Edge Emission, Radiated Spurious Emission

EMI test items: AC Conducted Emission

4.5. Support unit used in test configuration and system

The EUT has been associated with peripherals and configuration operated in a manner tended to maximize its emission characteristics in a typical application.

The following peripheral devices and interface cables were connected during the measurement:

Whether support unit is used?			
✓ No			
Item	Equipment	Trade Name	Model No.
1			
2			

4.6. Testing environmental condition

Type	Requirement	Actual
Temperature:	15~35°C	25°C
Relative Humidity:	25~75%	50%
Air Pressure:	860~1060mbar	1000mbar

4.7. Statement of the measurement uncertainty

No.	Test Items	Measurement Uncertainty
1	AC Conducted Emission	3.21dB
2	Peak Output Power	1.07
3	Power Spectral Density	1.07
4	6dB Bandwidth	0.002%
5	99% Occupied Bandwidth	0.002%
6	Duty cycle	-
7	Conducted Band Edge and Spurious Emission	1.68dB
8	Radiated Band Edge Emission	4.54dB for 30MHz-1GHz 5.10dB for above 1GHz
9	Radiated Spurious Emission	4.54dB for 30MHz-1GHz 5.10dB for above 1GHz

This uncertainty represents an expanded uncertainty expressed at approximately the 95% confidence level using a coverage factor of $k=1.96$.

4.8. Equipment Used during the Test

● Conducted Emission							
Used	Test Equipment	Manufacturer	Equipment No.	Model No.	Serial No.	Last Cal. Date (YY-MM-DD)	Next Cal. Date (YY-MM-DD)
●	EMI Test Receiver	R&S	HTWE0111	ESCI	101247	2023/8/22	2024/8/21
●	Artificial Mains	SCHWARZBECK	HTWE0113	NNLK 8121	573	2023/8/18	2024/8/17
●	Protection Network	SCHWARZBECK	HTWE0567	VTSD9561FN	00899	2023/8/18	2024/8/17
●	ISN	FCC	HTWE0148	FCC-TLISN-T2-02	20371	2023/8/18	2024/8/17
●	ISN	FCC	HTWE0150	FCC-TLISN-T8-02	20375	2023/8/18	2024/8/17
●	Test Software	R&S	N/A	EMC32	N/A	N/A	N/A

● RF Conducted test item							
Used	Test Equipment	Manufacturer	Equipment No.	Model No.	Serial No.	Last Cal. Date (YY-MM-DD)	Next Cal. Date (YY-MM-DD)
●	Signal and spectrum Analyzer	R&S	HTWE0242	FSV40	100048	2023/08/22	2024/08/21
●	Signal & Spectrum Analyzer	R&S	HTWE0262	FSW26	103440	2023/08/22	2024/08/21
●	Vector signal generator	R&S	HTWE0244	SMBV100A	260790	2023/05/23	2024/05/22
●	Test software	Tonscend	N/A	JS1120	N/A	N/A	N/A

● Radiated emission- 9kHz~30MHz							
Used	Test Equipment	Manufacturer	Equipment No.	Model No.	Serial No.	Last Cal. Date (YY-MM-DD)	Next Cal. Date (YY-MM-DD)
●	Semi-Anechoic Chamber	Albatross projects	HTWE0127	SAC-3m-02	C11121	2023/4/6	2026/4/5
●	EMI Test Receiver	R&S	HTWE0099	ESCI 7	100900	2023/08/22	2024/08/21
●	Loop Antenna	R&S	HTWE0170	HFH2-Z2	100020	2021/4/6	2024/4/5
●	Test Software	R&S	N/A	EMC32	N/A	N/A	N/A

● Radiated emission- 30MHz~1GHz							
Used	Test Equipment	Manufacturer	Equipment No.	Model No.	Serial No.	Last Cal. Date (YY-MM-DD)	Next Cal. Date (YY-MM-DD)
●	Semi-Anechoic Chamber	Albatross projects	HTWE0127	SAC-3m-02	C11121	2023/4/6	2026/4/5
●	EMI Test Receiver	R&S	HTWE0099	ESCI 7	100900	2023/08/22	2024/08/21
●	Ultra-Broadband Antenna	SCHWARZBECK	HTWE0119	VULB9163	546	2023/2/22	2026/2/21
●	Pre-Amplifier	SCHWARZBECK	HTWE0295	BBV 9742	/	2023/5/25	2024/5/24
●	Test Software	R&S	N/A	EMC32	N/A	N/A	N/A

● Radiated emission- Above 1GHz							
Used	Test Equipment	Manufacturer	Equipment No.	Model No.	Serial No.	Last Cal. Date (YY-MM-DD)	Next Cal. Date (YY-MM-DD)
●	Semi-Anechoic Chamber	Albatross projects	HTWE0122	SAC-3m-01	C11121	2023/4/17	2026/4/16
●	Spectrum Analyzer	R&S	HTWE0098	FSP40	100597	2023/08/22	2024/08/21
●	Spectrum Analyzer	R&S	HTWE0385	N9020A	MY54486658	2023/08/22	2024/08/21
●	Horn Antenna	SCHWARZBECK	HTWE0126	BBHA 9120D	1011	2023/2/14	2026/2/13
●	Pre-Amplifier	CD	HTWE0071	PAP-0102	12004	2023/5/25	2024/5/24
●	Broadband Pre-amplifier	SCHWARZBECK	HTWE0201	BBV 9718	9718-248	2023/5/25	2024/5/24
●	Test Software	Audix	N/A	E3	N/A	N/A	N/A

5. TEST CONDITIONS AND RESULTS

5.1. Antenna Requirement

REQUIREMENT

FCC CFR Title 47 Part 15 Subpart C Section 15.203:

An intentional radiator shall be designed to ensure that no antenna other than that furnished by the responsible party shall be used with the device. The use of a permanently attached antenna or of an antenna that uses a unique coupling to the intentional radiator, the manufacturer may design the unit so that a broken antenna can be replaced by the user, but the use of a standard antenna jack or electrical connector is prohibited.

TEST RESULT

Passed **Not Applicable**

The antenna type is a PIFA antenna, Refer to the below antenna photo.



5.2. AC Conducted Emission

LIMIT

FCC CFR Title 47 Part 15 Subpart C Section 15.207

Frequency range (MHz)	Limit (dBuV)	
	Quasi-peak	Average
0.15-0.5	66 to 56*	56 to 46*
0.5-5	56	46
5-30	60	50

* Decreases with the logarithm of the frequency.

TEST CONFIGURATION

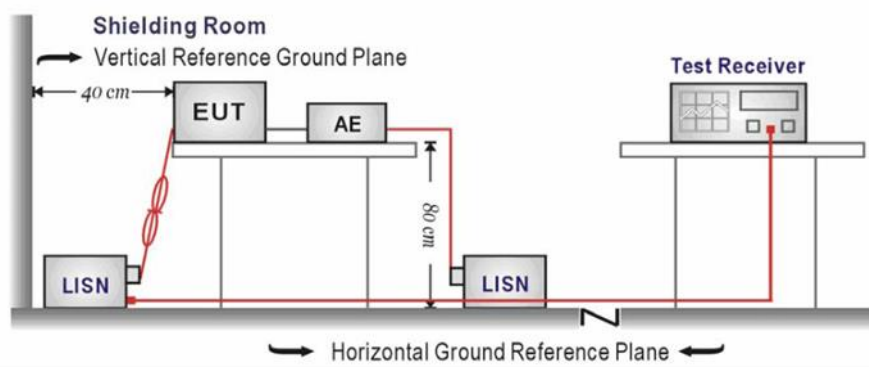

TEST PROCEDURE

1. The EUT was setup according to ANSI C63.10 requirements.
2. The EUT was placed on a platform of nominal size, 1 m by 1.5 m, raised 80 cm above the conducting ground plane. The vertical conducting plane was located 40 cm to the rear of the EUT. All other surfaces of EUT were at least 80 cm from any other grounded conducting surface.
3. The EUT and simulators are connected to the main power through a line impedances stabilization network (LISN). The LISN provides a 50 ohm /50uH coupling impedance for the measuring equipment.
4. The peripheral devices are also connected to the main power through a LISN. (Refer to the block diagram of the test setup and photographs)
5. Each current-carrying conductor of the EUT power cord, except the ground (safety) conductor, was individually connected through a LISN to the input power source.
6. The excess length of the power cord between the EUT and the LISN receptacle were folded back and forth at the center of the lead to form a bundle not exceeding 40 cm in length.
7. Conducted emissions were investigated over the frequency range from 0.15MHz to 30MHz using a receiver bandwidth of 9 kHz.
8. During the above scans, the emissions were maximized by cable manipulation.

TEST MODE

Refer to the clause 4.3

TEST RESULT

Passed Not Applicable

Test Line:

L

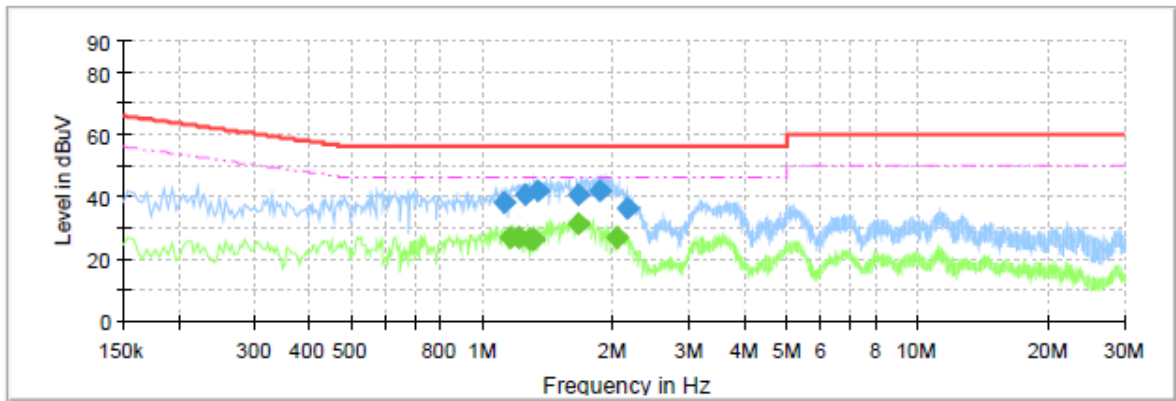

Final Result

Frequency (MHz)	QuasiPeak (dBuV)	CAverage (dBuV)	Limit (dBuV)	Margin (dB)	Line	Corr. (dB)
1.1275	38.28	---	56.00	17.72	L1	11.0
1.1635	---	27.01	46.00	18.99	L1	11.0
1.2115	---	27.05	46.00	18.95	L1	11.0
1.2565	40.62	---	56.00	15.38	L1	11.0
1.2795	---	26.01	46.00	19.99	L1	11.0
1.3115	---	26.36	46.00	19.64	L1	11.0
1.3435	41.72	---	56.00	14.28	L1	11.0
1.6645	---	31.02	46.00	14.98	L1	11.0
1.6675	40.36	---	56.00	15.64	L1	11.0
1.8595	41.61	---	56.00	14.39	L1	11.0
2.0475	---	27.14	46.00	18.86	L1	11.0
2.1475	36.49	---	56.00	19.51	L1	11.0

Test Line:

N

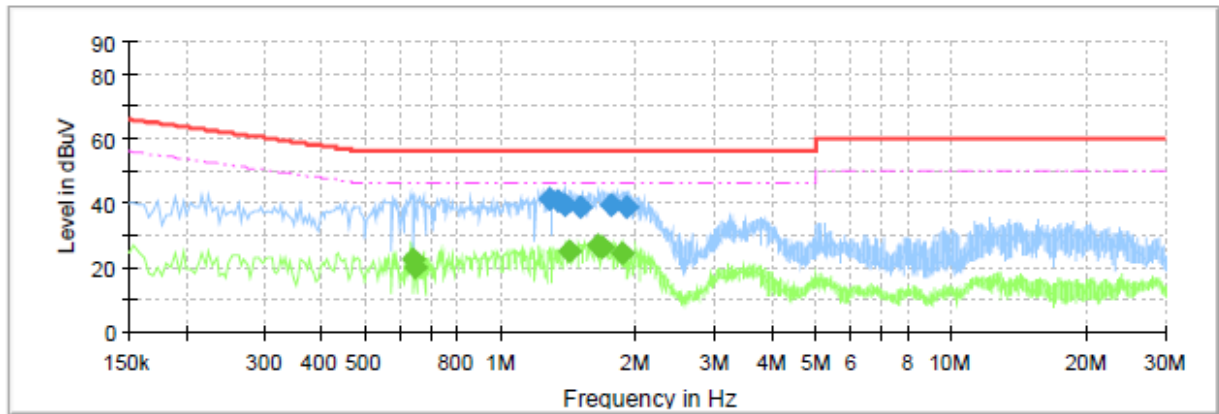

Final Result

Frequency (MHz)	QuasiPeak (dBuV)	CAverage (dBuV)	Limit (dBuV)	Margin (dB)	Line	Corr. (dB)
0.6395	---	22.62	46.00	23.38	N	10.8
0.6475	---	20.27	46.00	25.73	N	10.8
1.2795	41.30	---	56.00	14.70	N	10.8
1.3435	40.83	---	56.00	15.17	N	10.8
1.3875	39.37	---	56.00	16.63	N	10.8
1.4235	---	25.21	46.00	20.79	N	10.8
1.4995	38.74	---	56.00	17.26	N	10.8
1.6555	---	26.82	46.00	19.18	N	10.8
1.6835	---	26.48	46.00	19.52	N	10.8
1.7635	39.39	---	56.00	16.61	N	10.8
1.8595	---	24.16	46.00	21.84	N	10.8
1.9115	38.82	---	56.00	17.18	N	10.8

5.3. Peak Output Power

LIMIT

FCC CFR Title 47 Part 15 Subpart C Section 15.247 (b)(1):

For frequency hopping systems operating in the 2400-2483.5 MHz band employing at least 75 non-overlapping hopping channels, and all frequency hopping systems in the 5725-5850 MHz band: 1 watt.
For all other frequency hopping systems in the 2400-2483.5 MHz band: 0.125 watts.

TEST CONFIGURATION

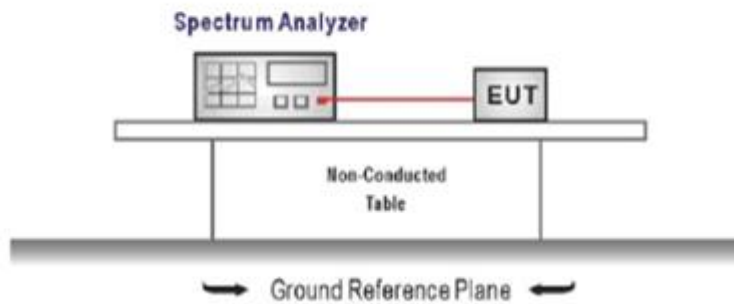

TEST PROCEDURE

1. The transmitter output was connected to the spectrum analyzer through an attenuator, the pathloss was compensated to the results for each measurement.
2. Set to the maximum power setting and enable the EUT transmit continuously
3. Use the following spectrum analyzer settings:
Span = approximately 5 times the 20 dB bandwidth, centered on a hopping channel
RBW \geq the 20 dB bandwidth of the emission being measured, VBW \geq RBW
Sweep = auto, Detector function = peak, Trace = max hold
4. Measure and record the results in the test report.

TEST MODE

Refer to the clause 4.3

TEST RESULT

Passed Not Applicable

TEST DATA

Refer to the appendix report

5.4. 20 dB Bandwidth

LIMIT

N/A

TEST CONFIGURATION

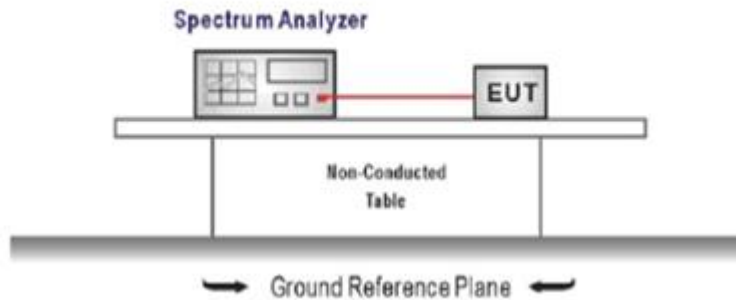

TEST PROCEDURE

1. The transmitter output was connected to the spectrum analyzer through an attenuator, the path loss was compensated to the results for each measurement.
2. Set to the maximum power setting and enable the EUT transmit continuously
3. Use the following spectrum analyzer settings:
Span = approximately 2 to 3 times the 20 dB bandwidth, centered on a hopping channel
RBW \geq 1% of the 20 dB bandwidth, VBW \geq RBW
Sweep = auto, Detector function = peak, Trace = max hold
4. Measure and record the results in the test report.

TEST MODE

Refer to the clause 4.3

TEST RESULT

Passed Not Applicable

TEST DATA

Refer to the appendix report

5.5. 99% Occupied Bandwidth

LIMIT

N/A

TEST CONFIGURATION

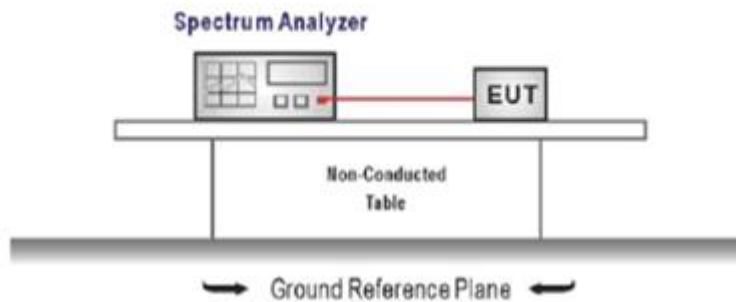

TEST PROCEDURE

1. Connect the antenna port(s) to the spectrum analyzer input.
2. Configure the spectrum analyzer as shown below (enter all losses between the transmitter output and the spectrum analyzer).
Center Frequency = channel center frequency
Span $\geq 1.5 \times$ OBW
RBW = 1%~5%OBW
VBW $\geq 3 \times$ RBW
Sweep time = auto couple
Detector = Peak
Trace mode = max hold
3. Place the radio in continuous transmit mode, allow the trace to stabilize, view the transmitter waveform on the spectrum analyzer.

TEST MODE

Refer to the clause 4.3

TEST RESULT

Passed Not Applicable

TEST DATA

Refer to the appendix report

5.6. Carrier Frequencies Separation

LIMIT

FCC CFR Title 47 Part 15 Subpart C Section 15.247 (a)(1):

Frequency hopping systems shall have hopping channel carrier frequencies separated by a minimum of 25kHz or the 20 dB bandwidth of the hopping channel, whichever is greater. Alternatively, Frequency hopping systems operating in the 2400-2483.5 MHz band may have hopping channel carrier frequencies that are separated by 25 kHz or two-thirds of the 20 dB bandwidth of the hopping channel, whichever is greater, provided the systems operate with an output power no greater than 125 mW.

TEST CONFIGURATION

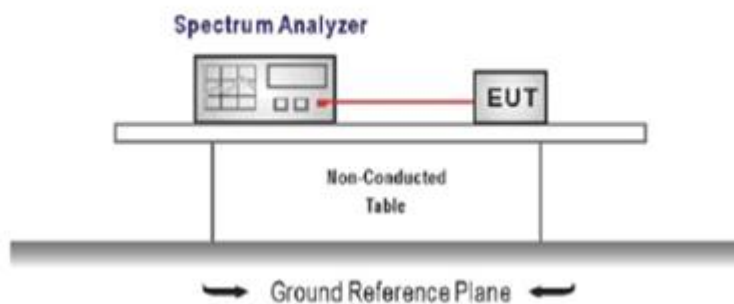

TEST PROCEDURE

1. The transmitter output was connected to the spectrum analyzer through an attenuator, the path loss was compensated to the results for each measurement.
2. Set to the maximum power setting and enable the EUT transmit continuously
3. Use the following spectrum analyzer settings:
 - Span = wide enough to capture the peaks of two adjacent channels
 - RBW \geq 1% of the span, VBW \geq RBW
 - Sweep = auto, Detector function = peak, Trace = max hold
4. Measure and record the results in the test report.

TEST MODE

Refer to the clause 4.3

TEST RESULTS

Passed Not Applicable

TEST DATA

Refer to the appendix report

5.7. Hopping Channel Number

LIMIT

FCC CFR Title 47 Part 15 Subpart C Section 15.247 (a)(1):

Frequency hopping systems in the 2400–2483.5 MHz band shall use at least **15** channels.

TEST CONFIGURATION

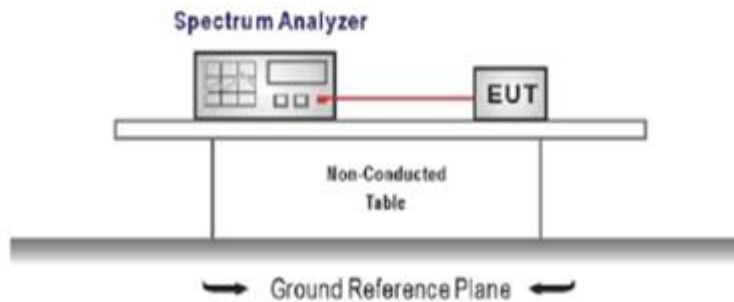

TEST PROCEDURE

1. The transmitter output was connected to the spectrum analyzer through an attenuator, the path loss was compensated to the results for each measurement.
2. Set to the maximum power setting and enable the EUT transmit continuously
3. Use the following spectrum analyzer settings:
Span = the frequency band of operation
RBW \geq 1% of the span, VBW \geq RBW
Sweep = auto, Detector function = peak, Trace = max hold
4. Measure and record the results in the test report.

TEST MODE

Refer to the clause 4.3

TEST RESULTS

Passed Not Applicable

TEST DATA

Refer to the appendix report

5.8. Dwell Time

LIMIT

FCC CFR Title 47 Part 15 Subpart C Section 15.247 (a)(1):The average time of occupancy on any channel shall not be greater than 0.4 seconds within a pe-riod of 0.4 seconds multiplied by the number of hopping channels employed.

TEST CONFIGURATION

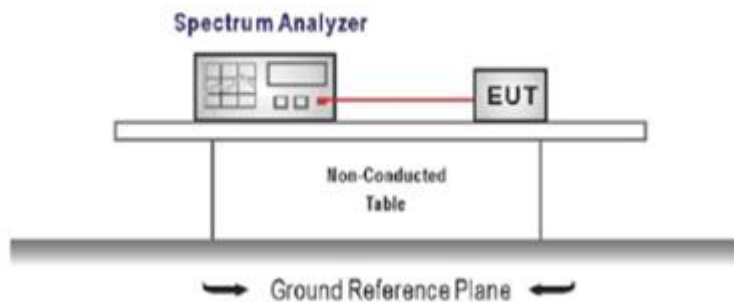

TEST PROCEDURE

1. The transmitter output was connected to the spectrum analyzer through an attenuator, the path loss was compensated to the results for each measurement.
2. Set to the maximum power setting and enable the EUT transmit continuously
3. Use the following spectrum analyzer settings:
Span = zero span, centered on a hopping channel, RBW= 1 MHz, VBW \geq RBW
Sweep = as necessary to capture the entire dwell time per hopping channel,
Detector function = peak, Trace = max hold
4. Measure and record the results in the test report.

TEST MODE

Refer to the clause 4.3

TEST RESULTS

Passed Not Applicable

TEST DATA

Refer to the appendix report

5.9. Duty Cycle Correction Factor (DCCF)

LIMIT

N/A

TEST CONFIGURATION

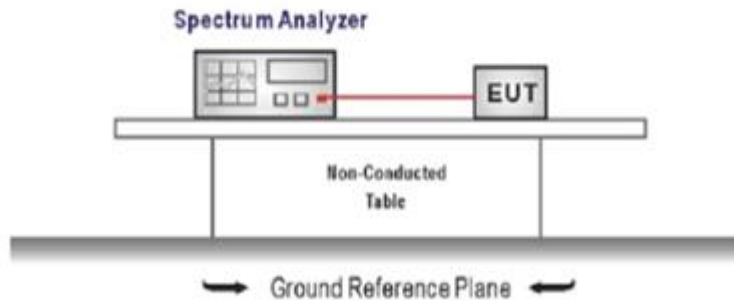

TEST PROCEDURE

1. The transmitter output was connected to the spectrum analyzer through an attenuator, the path loss was compensated to the results for each measurement.
2. Set to the maximum power setting and enable the EUT transmit continuously
3. Use the following spectrum analyzer settings:
Span = zero span, centered on a hopping channel, RBW= 1 MHz, VBW \geq RBW
Sweep = as necessary to capture the entire dwell time per hopping channel,
Detector function = peak, Trigger mode
4. Measure and record the duty cycle data

TEST MODE

Refer to the clause 4.3

TEST DATA

Refer to the appendix report

5.10. Pseudorandom Frequency Hopping Sequence

LIMIT

FCC CFR Title 47 Part 15 Subpart C Section 15.247 (a)(1):Frequency hopping systems shall have hopping channel carrier frequencies separated by a minimum of 25 kHz or the 20 dB bandwidth of the hopping channel, whichever is greater. Alternatively, frequency hopping systems operating in the 2400–2483.5 MHz band may have hopping channel carrier frequencies that are separated by 25 kHz or two-thirds of the 20 dB bandwidth of the hopping channel, whichever is greater, provided the systems operate with an output power no greater than 125 mW. The system shall hop to channel frequencies that are selected at the system hopping rate from a pseudo-randomly ordered list of hopping frequencies. Each frequency must be used equally on the average by each transmitter. The system receivers shall have input bandwidths that match the hopping channel bandwidths of their corresponding transmitters and shall shift frequencies in synchronization with the transmitted signals.

TEST RESULTS

The pseudorandom frequency hopping sequence may be generated in a nine-stage shift register whose 5th and 9th stage outputs are added in a modulo-two addition stage. And the result is fed back to the input of the first stage. The sequence begins with the first one of 9 consecutive ones, for example: the shift register is initialized with nine ones.

- Number of shift register stages: 9
- Length of pseudo-random sequence: $2^9 - 1 = 511$ bits
- Longest sequence of zeros: 8 (non-inverted signal)

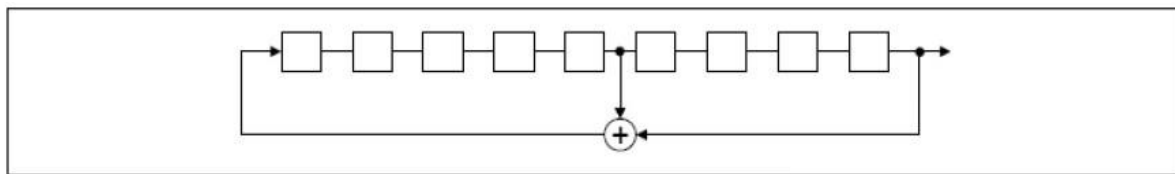

Linear Feedback Shift Register for Generation of the PRBS sequence

An example of pseudorandom frequency hopping sequence as follows:

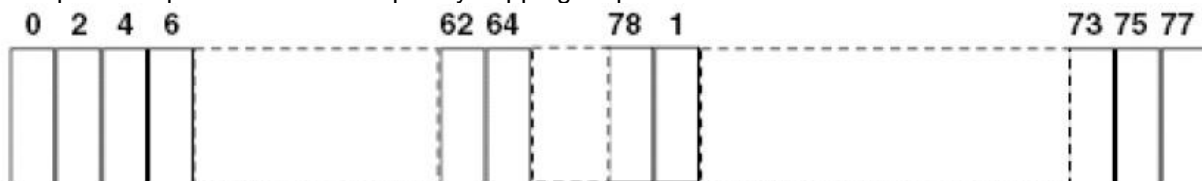

Each frequency used equally on the average by each transmitter. The system receiver has input bandwidths that match the hopping channel bandwidths of their corresponding transmitter and shifts frequencies in synchronization with the transmitted signals.

5.11. Conducted Band edge and Spurious Emission

LIMIT

FCC CFR Title 47 Part 15 Subpart C Section 15.247 (d): In any 100 kHz bandwidth outside the frequency band in which the spread spectrum intentional radiator is operating, the radio frequency power that is produced by the intentional radiator shall be at least 20 dB below that in the 100 kHz bandwidth within the band that contains the highest level of the desired power, based on either an RF conducted or a radiated measurement.

TEST CONFIGURATION

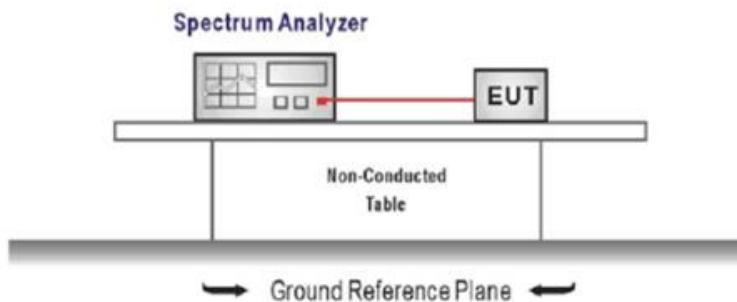

TEST PROCEDURE

1. Connect the antenna port(s) to the spectrum analyzer input.
2. Emission level measurement
Set the center frequency and span to encompass frequency range to be measured
RBW = 100 kHz, VBW \geq 3 x RBW
Detector = peak, Sweep time = auto couple, Trace mode = max hold
Allow trace to fully stabilize
Use the peak marker function to determine the maximum amplitude level.
3. Place the radio in continuous transmit mode, allow the trace to stabilize, view the transmitter waveform on the spectrum analyzer.
4. Ensure that the amplitude of all unwanted emission outside of the authorized frequency band excluding restricted frequency bands) are attenuated by at least the minimum requirements specified (at least 20 dB relative to the maximum in-band peak PSD level in 100 kHz). Report the three highest emission relative to the limit.

TEST MODE

Refer to the clause 4.3

TEST RESULT

Passed **Not Applicable**

TEST DATA

Refer to the appendix report

5.12. Radiated Band edge Emission

LIMIT

FCC CFR Title 47 Part 15 Subpart C Section 15.247 (d):

In any 100 kHz bandwidth outside the frequency band in which the spread spectrum or digitally modulated intentional radiator is operating, Radiated Emissions which fall in the restricted bands, as defined in §15.205(a), must also comply with the Radiated Emissions limits specified in §15.209(a) (see §15.205(c)).

TEST CONFIGURATION

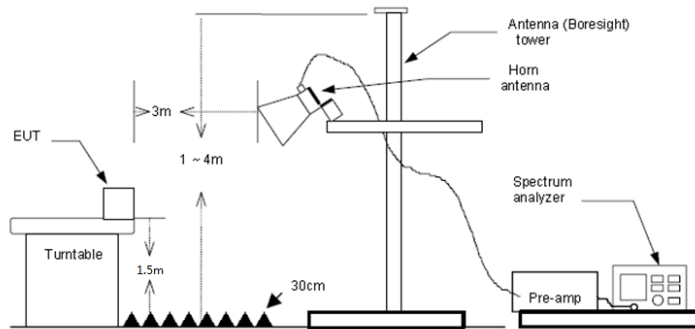

TEST PROCEDURE

1. The EUT was setup and tested according to ANSI C63.10 .
2. The EUT is placed on a turn table which is 1.5 meter above ground. The turn table is rotated 360 degrees to determine the position of the maximum emission level.
3. The EUT was positioned such that the distance from antenna to the EUT was 3 meters.
4. The antenna is scanned from 1 meter to 4 meters to find out the maximum emission level. This is repeated for both horizontal and vertical polarization of the antenna. In order to find the maximum emission, all of the interface cables were manipulated according to ANSI C63.10 on radiated measurement.
5. Use the following spectrum analyzer settings:
 - a) Span shall wide enough to fully capture the emission being measured
 - b) Set RBW=100kHz for <1GHz, VBW=3*RBW, Sweep time=auto, Detector=peak, Trace=max hold
 - c) Set RBW=1MHz, VBW=3MHz for >1GHz, Sweep time=auto, Detector=peak, Trace=max hold for Peak measurement

For average measurement: use duty cycle correction factor method (DCCF)
 Averager level = Peak level + DCCF

TEST MODE

Refer to the clause 4.3

TEST RESULT

Passed Not Applicable

Note:

- 1) Level= Reading + Factor; Factor =Antenna Factor+ Cable Loss- Preamp Factor
- 2) Over Limit = Level- Limit
- 3) Average measurement was not performed if peak level is lower than average limit(54 dBuV/m).

Test channel:		CH00			Polarity			Horizontal		
Mark	Frequency MHz	Reading dBuV/m	Antenna dB	Cable dB	Preamp dB	Level dBuV/m	Limit dBuV/m	Over limit	Remark	
1	2310.00	57.00	27.86	4.01	41.80	47.07	74.00	-26.93	Peak	
2	2390.03	56.56	27.54	4.31	41.80	46.61	74.00	-27.39	Peak	

Test channel:		CH00			Polarity			Vertical		
Mark	Frequency MHz	Reading dBuV/m	Antenna dB	Cable dB	Preamp dB	Level dBuV/m	Limit dBuV/m	Over limit	Remark	
1	2310.00	55.65	27.86	4.01	41.80	45.72	74.00	-28.28	Peak	
2	2390.03	56.51	27.54	4.31	41.80	46.56	74.00	-27.44	Peak	

Test channel:		CH78			Polarity			Horizontal		
Mark	Frequency MHz	Reading dBuV/m	Antenna dB	Cable dB	Preamp dB	Level dBuV/m	Limit dBuV/m	Over limit	Remark	
1	2483.50	65.59	27.33	4.18	41.80	55.30	74.00	-18.70	Peak	
2	2484.82	68.20	27.33	4.18	41.80	57.91	74.00	-16.09	Peak	
3	2500.00	56.09	27.30	4.19	41.80	45.78	74.00	-28.22	Peak	

Fundamental of Average							
No.	Freq. [MHz]	PK level [dB μ V/m]	DCCF [dB]	Level [dB μ V/m]	Limit [dB μ V/m]	Over Limit [dB]	Polarity
1	2483.50	55.30	-30.84	24.46	54.00	-29.54	Horizontal
2	2484.82	57.91	-30.84	27.07	54.00	-26.93	Horizontal

Test channel:		CH78			Polarity			Vertical		
Mark	Frequency MHz	Reading dBuV/m	Antenna dB	Cable dB	Preamp dB	Level dBuV/m	Limit dBuV/m	Over limit	Remark	
1	2483.50	59.54	27.33	4.18	41.80	49.25	74.00	-24.75	Peak	
2	2483.80	64.16	27.33	4.18	41.80	53.87	74.00	-20.13	Peak	
3	2500.00	56.13	27.30	4.19	41.80	45.82	74.00	-28.18	Peak	

5.13. Radiated Spurious Emission

LIMIT

FCC CFR Title 47 Part 15 Subpart C Section 15.209

Frequency	Limit (dBuV/m)	Value
0.009 MHz ~0.49 MHz	2400/F(kHz) @300m	Quasi-peak
0.49 MHz ~ 1.705 MHz	24000/F(kHz) @30m	Quasi-peak
1.705 MHz ~30 MHz	30 @30m	Quasi-peak

Note: Limit dBuV/m @3m = Limit dBuV/m @300m + 40*log(300/3)= Limit dBuV/m @300m +80,

Limit dBuV/m @3m = Limit dBuV/m @30m +40*log(30/3)= Limit dBuV/m @30m + 40.

Frequency	Limit (dBuV/m @3m)	Value
30MHz~88MHz	40.00	Quasi-peak
88MHz~216MHz	43.50	Quasi-peak
216MHz~960MHz	46.00	Quasi-peak
960MHz~1GHz	54.00	Quasi-peak
Above 1GHz	54.00	Average
	74.00	Peak

TEST CONFIGURATION

- 9 kHz ~ 30 MHz

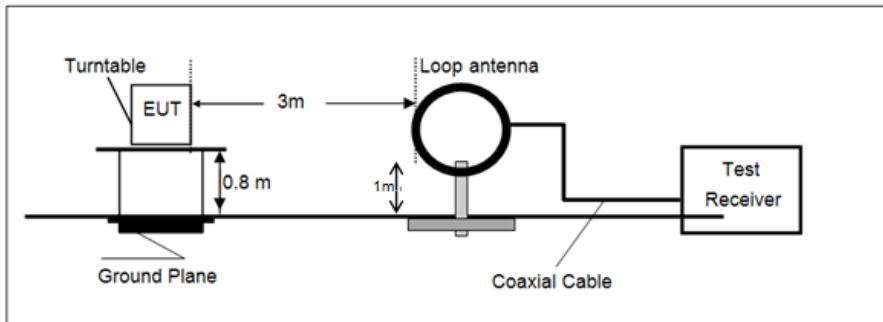

- 30 MHz ~ 1 GHz

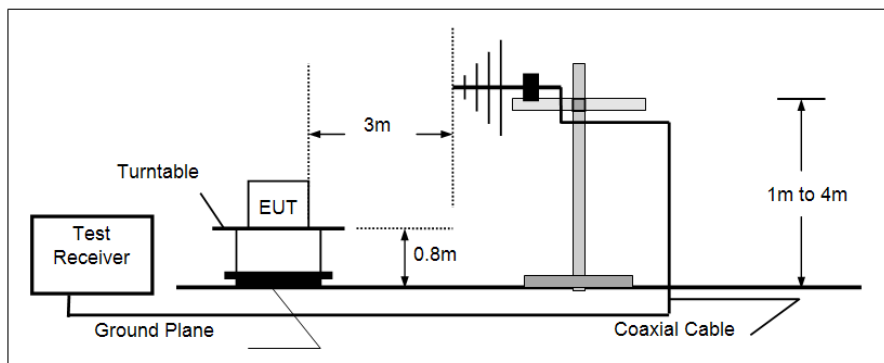

- Above 1 GHz

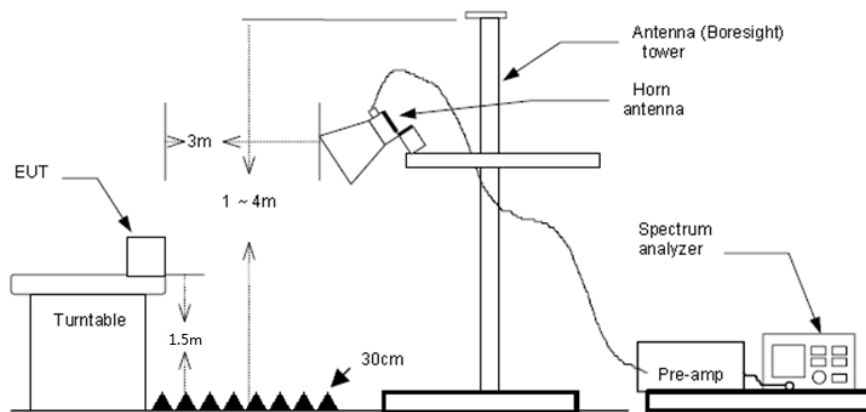

TEST PROCEDURE

1. The EUT was setup and tested according to ANSI C63.10.
2. The EUT is placed on a turn table which is 0.8 meter above ground for below 1 GHz, and 1.5 m for above 1 GHz. The turn table is rotated 360 degrees to determine the position of the maximum emission level.
3. The EUT was set 3 meters from the receiving antenna, which was mounted on the top of a variable height antenna tower.
4. For each suspected emission, the EUT was arranged to its worst case and then tune the Antenna tower (from 1 m to 4 m) and turntable (from 0 degree to 360 degrees) to find the maximum reading. A pre-amp and a high pass filter are used for the test in order to get better signal level to comply with the guidelines.
5. Set to the maximum power setting and enable the EUT transmit continuously.
6. Use the following spectrum analyzer settings
 - a) Span shall wide enough to fully capture the emission being measured;
 - b) Below 1 GHz:
 - RBW=120 kHz, VBW=300 kHz, Sweep=auto, Detector function=peak, Trace=max hold;
 - If the emission level of the EUT measured by the peak detector is 3 dB lower than the applicable limit, the peak emission level will be reported. Otherwise, the emission measurement will be repeated using the quasi-peak detector and reported.
 - c) Set RBW=1MHz, VBW=3MHz for >1GHz, Sweep time=auto, Detector=peak, Trace=max hold for Peak measurement

For average measurement: use duty cycle correction factor method (DCCF)
 Averager level = Peak level + DCCF

TEST MODE

Refer to the clause 4.3

TEST RESULT

Passed **Not Applicable**

Note:

- 1) Level= Reading + Factor/Transd; Factor/Transd =Antenna Factor+ Cable Loss- Preamp Factor
- 2) Over Limit = Level- Limit
- 3) Average measurement was not performed if peak level is lower than average limit(54 dBuV/m) for above 1GHz.

For 9 kHz ~ 30 MHz

The EUT was pre-scanned this frequency band, found the radiated level 20dB lower than the limit, so don't show data on this report.

For 30 MHz ~ 1000 MHz

Have pre-scan all test channel, found **CH39** which it was worst case, so only show the worst case's data on this report.

Polarization:

Horizontal

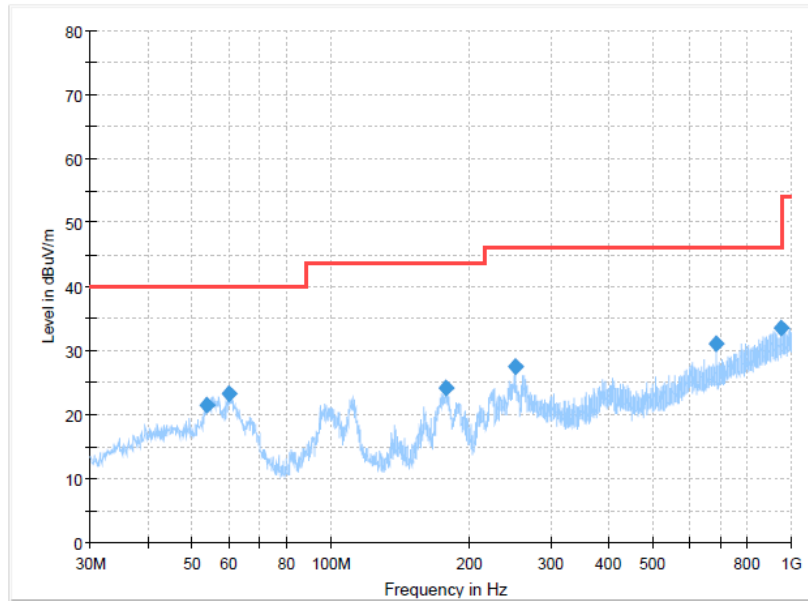

Final Result

Frequency (MHz)	MaxPeak (dBuV/m)	Limit (dBuV/m)	Margin (dB)	Height (cm)	Pol	Azimuth (deg)	Corr. (dB/m)
53.7650	21.46	40.00	18.54	300.0	H	4.0	-9.1
59.8275	23.31	40.00	16.69	300.0	H	0.0	-9.9
177.3188	24.17	43.50	19.33	100.0	H	247.0	-12.7
251.7663	27.51	46.00	18.49	100.0	H	215.0	-8.8
687.5388	31.05	46.00	14.95	100.0	H	207.0	2.1
948.5900	33.45	46.00	12.55	300.0	H	325.0	7.1

Polarization:

Vertical

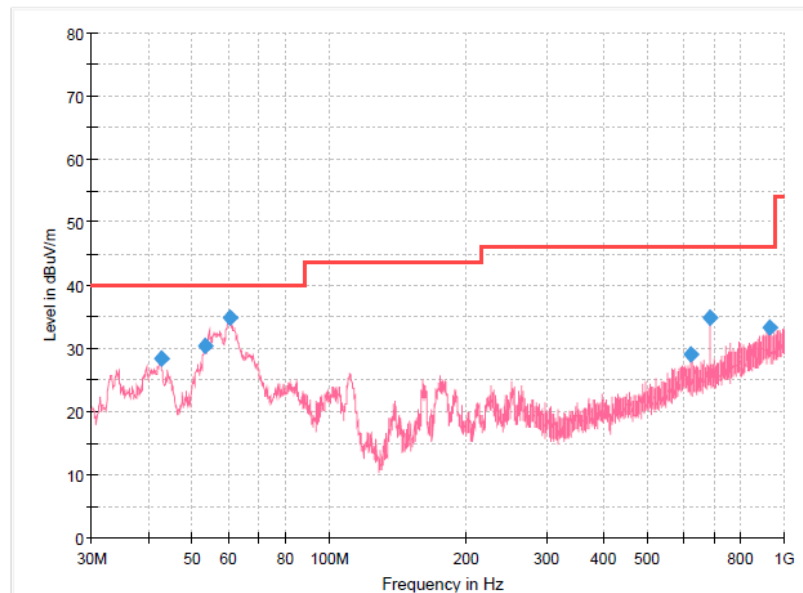

Final Result

Frequency (MHz)	MaxPeak (dBuV/m)	Limit (dBuV/m)	Margin (dB)	Height (cm)	Pol	Azimuth (deg)	Corr. (dB/m)
42.6100	28.30	40.00	11.70	100.0	V	161.0	-9.3
53.2800	30.40	40.00	9.60	100.0	V	130.0	-9.0
60.4338	34.87	40.00	5.13	100.0	V	98.0	-10.1
621.5788	29.09	46.00	16.91	100.0	V	0.0	1.3
687.5388	34.75	46.00	11.25	100.0	V	341.0	2.1
928.2200	33.30	46.00	12.70	100.0	V	0.0	7.0

For 1 GHz ~ 25 GHz

Test channel		CH00			Polarity		Horizontal		
Mark	Frequency MHz	Reading dBuV/m	Antenna dB	Cable dB	Preamp dB	Level dBuV/m	Limit dBuV/m	Over limit	Remark
1	2935.15	43.96	28.50	4.62	41.69	35.39	74.00	-38.61	Peak
2	5546.36	40.61	31.71	6.49	40.79	38.02	74.00	-35.98	Peak
3	8022.46	41.07	37.00	8.07	40.76	45.38	74.00	-28.62	Peak
4	10374.42	39.45	39.82	9.69	40.65	48.31	74.00	-25.69	Peak

Test channel		CH00			Polarity		Vertical		
Mark	Frequency MHz	Reading dBuV/m	Antenna dB	Cable dB	Preamp dB	Level dBuV/m	Limit dBuV/m	Over limit	Remark
1	3041.64	44.63	28.58	4.65	41.62	36.24	74.00	-37.76	Peak
2	5448.41	40.78	31.79	6.59	40.85	38.31	74.00	-35.69	Peak
3	7981.72	40.68	36.96	7.99	40.85	44.78	74.00	-29.22	Peak
4	10507.31	39.55	40.00	9.76	40.95	48.36	74.00	-25.64	Peak

Test channel		CH39			Polarity		Horizontal		
Mark	Frequency MHz	Reading dBuV/m	Antenna dB	Cable dB	Preamp dB	Level dBuV/m	Limit dBuV/m	Over limit	Remark
1	2854.11	41.33	28.41	4.56	41.75	32.55	74.00	-41.45	Peak
2	5448.41	39.57	31.79	6.59	40.85	37.10	74.00	-36.90	Peak
3	9204.60	38.39	38.83	9.30	41.00	45.52	74.00	-28.48	Peak
4	12148.02	38.71	39.55	10.81	42.18	46.89	74.00	-27.11	Peak

Test channel		CH39			Polarity		Vertical		
Mark	Frequency MHz	Reading dBuV/m	Antenna dB	Cable dB	Preamp dB	Level dBuV/m	Limit dBuV/m	Over limit	Remark
1	4096.88	41.40	29.90	5.52	41.41	35.41	74.00	-38.59	Peak
2	5718.40	39.97	31.84	6.68	40.73	37.76	74.00	-36.24	Peak
3	9465.98	38.34	38.97	9.37	40.94	45.74	74.00	-28.26	Peak
4	11515.68	38.71	40.47	10.37	42.30	47.25	74.00	-26.75	Peak

Test channel		CH78			Polarity		Horizontal		
Mark	Frequency MHz	Reading dBuV/m	Antenna dB	Cable dB	Preamp dB	Level dBuV/m	Limit dBuV/m	Over limit	Remark
1	3266.35	43.83	28.50	4.81	41.60	35.54	74.00	-38.46	Peak
2	5448.41	40.93	31.79	6.59	40.85	38.46	74.00	-35.54	Peak
3	8104.56	40.65	36.98	8.11	40.59	45.15	74.00	-28.85	Peak
4	10860.83	40.39	40.42	9.93	42.10	48.64	74.00	-25.36	Peak

Test channel		CH78			Polarity		Vertical		
Mark	Frequency MHz	Reading dBuV/m	Antenna dB	Cable dB	Preamp dB	Level dBuV/m	Limit dBuV/m	Over limit	Remark
1	3507.65	42.94	29.03	5.11	41.60	35.48	74.00	-38.52	Peak
2	5462.30	41.08	31.80	6.60	40.84	38.64	74.00	-35.36	Peak
3	8002.06	41.12	37.00	8.00	40.81	45.31	74.00	-28.69	Peak
4	10427.37	39.89	39.93	9.72	40.69	48.85	74.00	-25.15	Peak

6. TEST SETUP PHOTOS

Radiated Emission

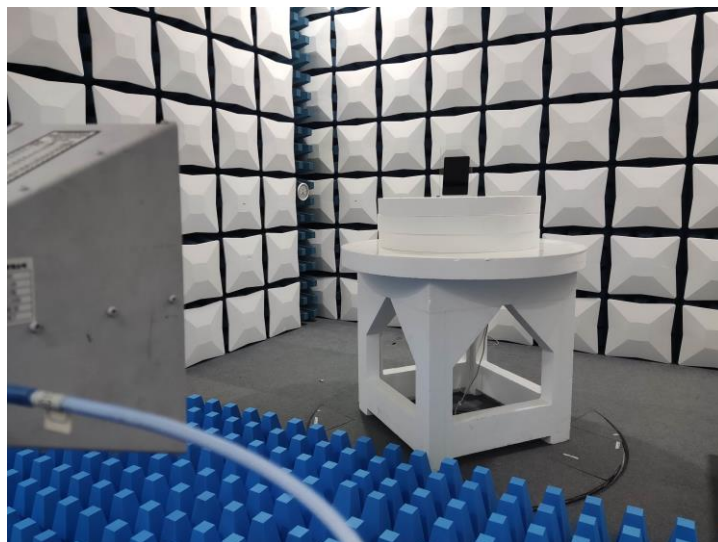
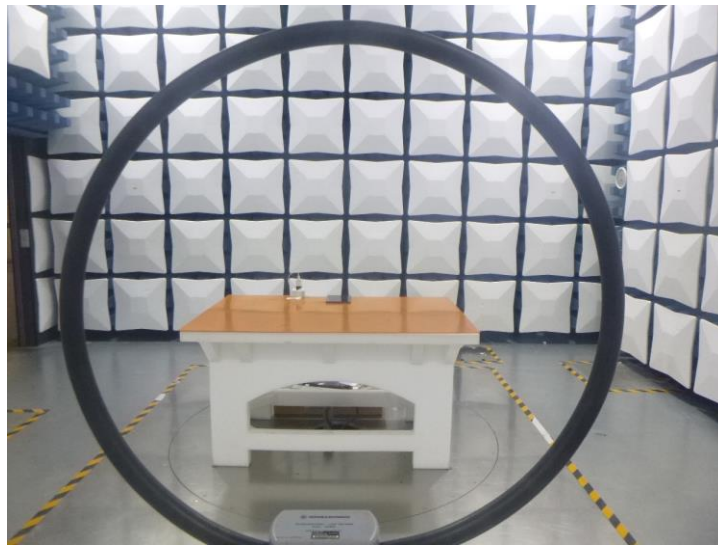

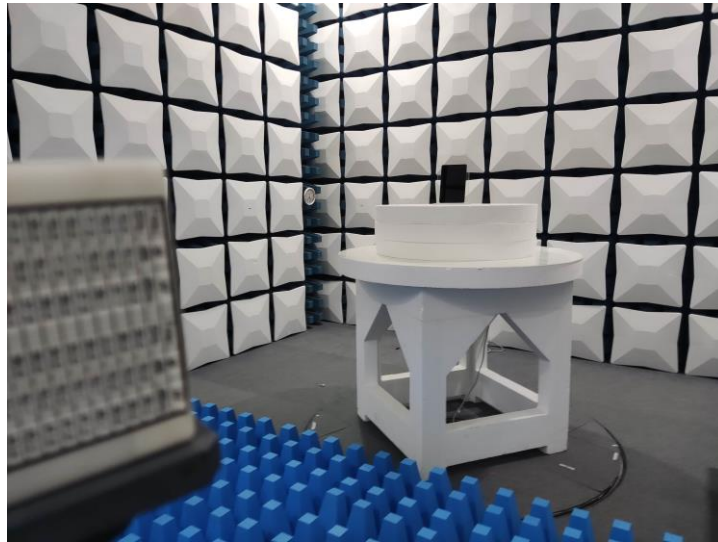

AC Conducted Emission



7. EXTERNAL AND INTERNAL PHOTOS

Refer to the test report No.: CHTEW23120046

8. APPENDIX REPORT

APPENDIX REPORT

Project No.	SHT2310062301EW	Radio Specification	Bluetooth EDR
Test sample No.	YPHT23100623001	Model No.	Star10 Pro
Start test date	2023-11-3	Finish date	2023-12-20
Temperature	25°C	Humidity	49%
Test Engineer	Xiangyu Wei	Auditor	Xiaodong Zheo

Appendix clause	Test item	Result
A	Peak Output Power	PASS
B	20 dB Bandwidth	PASS
C	99% Occupied Bandwidth	PASS
D	Carrier Frequencies Separation	PASS
E	Hopping Channel Number	PASS
F	Dwell Time	PASS
G	Duty Cycle Correction Factor (DCCF)	PASS
H	Band edge and Spurious Emissions(coducted)	PASS

Appendix A: Peak Output Power

Modulation type	Channel	Peak Output power (dBm)	Average Output power (dBm)	Limit (dBm)	Result
GFSK	00	7.81	7.79	≤ 30.00	Pass
	39	8.24	8.22		
	78	7.01	6.98		
π/4DQPSK	00	8.26	8.22	≤ 21.00	Pass
	39	8.55	8.5		
	78	7.72	7.70		
8DPSK	00	8.27	8.2	≤ 21.00	Pass
	39	8.58	8.5		
	78	7.72	7.68		

Modulation Type:

GFSK

CH00

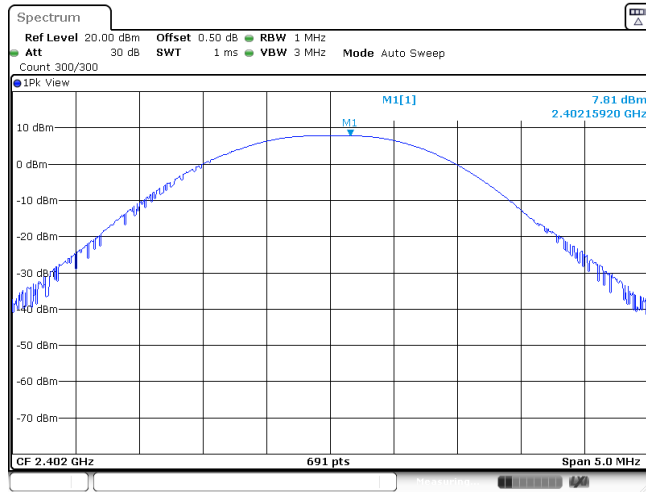

Date: 3 NOV 2023 08:44:17

CH39

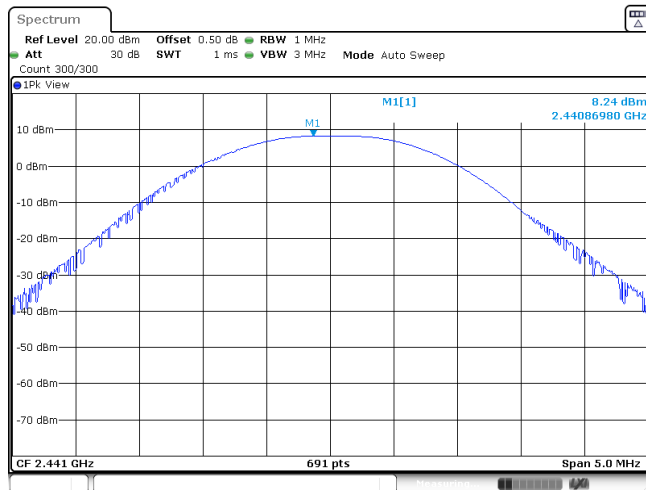

Date: 3 NOV 2023 08:41:22

CH78

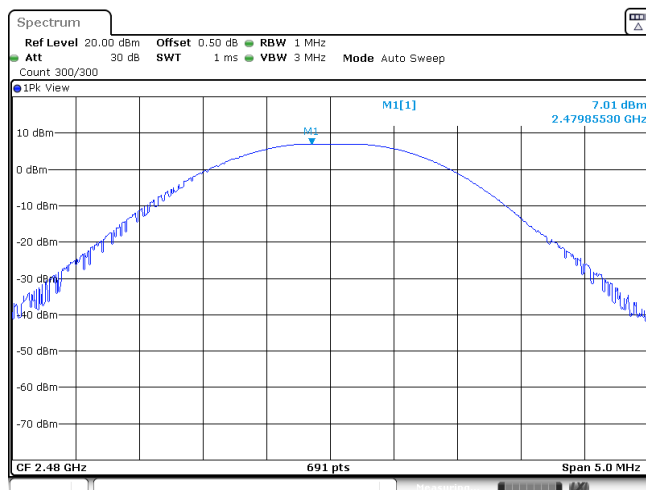

Date: 3 NOV 2023 08:43:11

Modulation Type:

$\pi/4$ DQPSK

CH00

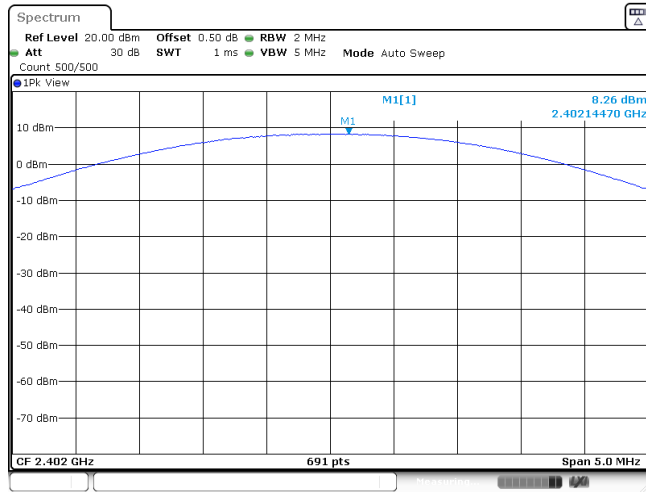

Date: 3 NOV 2023 08:45:31

CH39

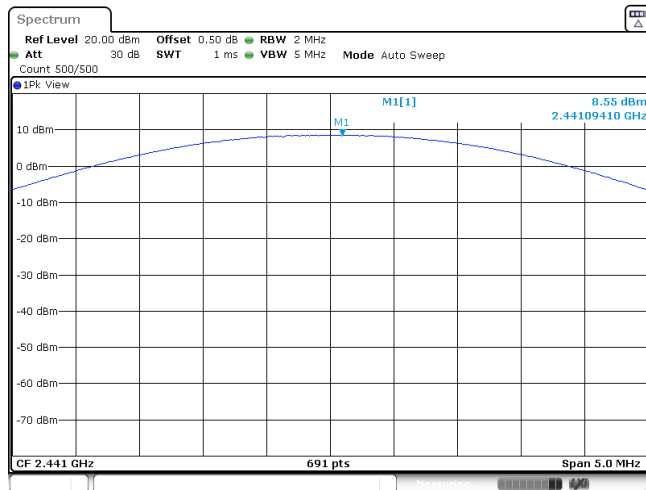

Date: 3 NOV 2023 08:47:28

CH78

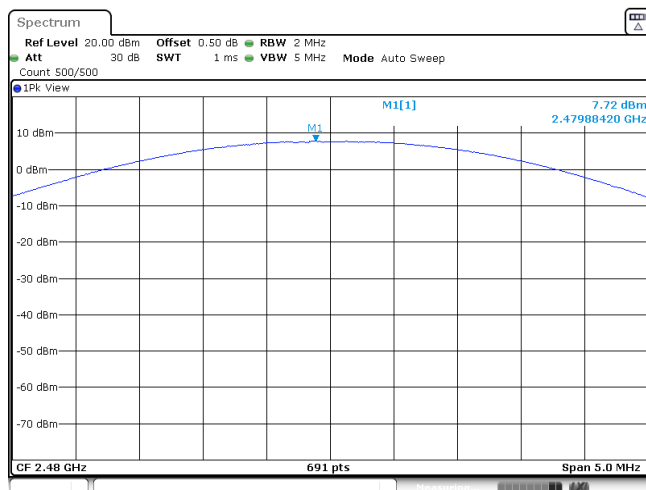

Date: 3 NOV 2023 08:48:50

Modulation Type:

8DPSK

CH00

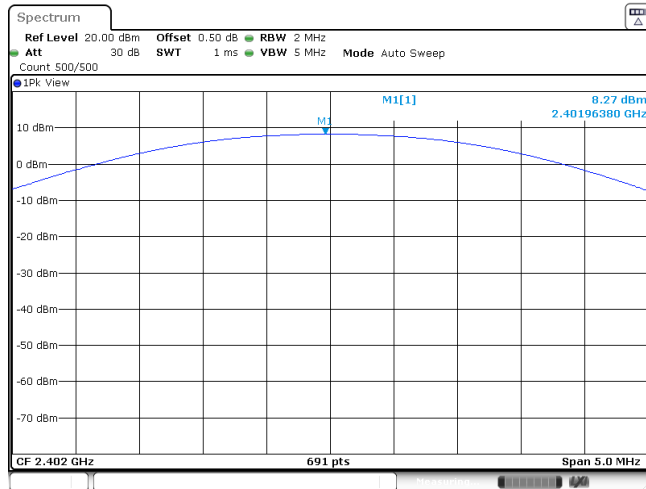

Date: 3 NOV 2023 08:48:04

CH39

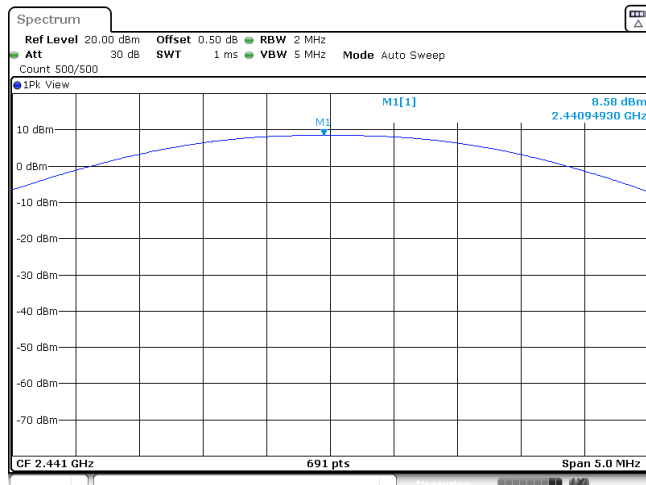

Date: 3 NOV 2023 08:49:33

CH78

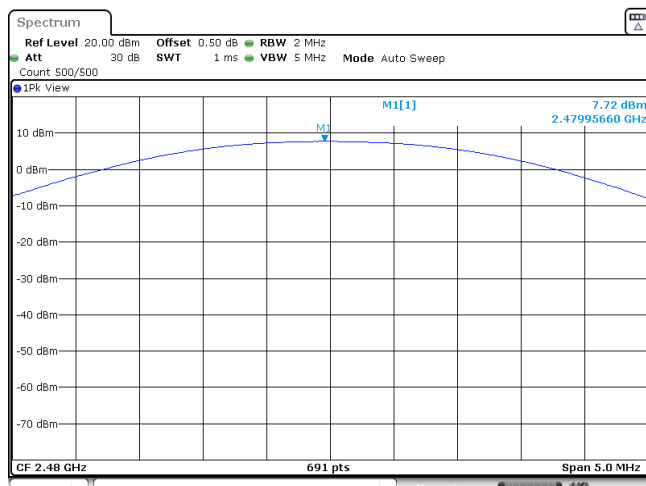

Date: 3 NOV 2023 08:54:40

Appendix B : 20 dB Bandwidth

Modulation type	Channel	20 dB Bandwidth (kHz)	Limit (kHz)	Result
GFSK	00	925.00	-	Pass
	39	925.00		
	78	925.00		
$\pi/4$ DQPSK	00	1288.00	-	Pass
	39	1285.00		
	78	1285.00		
8DPSK	00	1295.00	-	Pass
	39	1295.00		
	78	1295.00		

Modulation Type:

GFSK

CH00

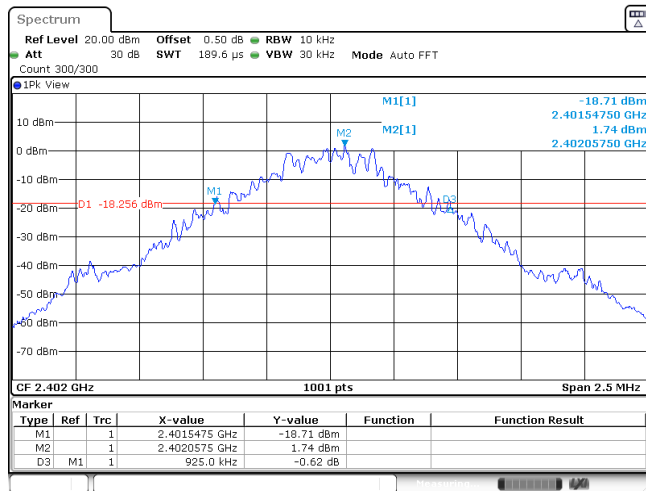

Date: 3 NOV 2023 08:48:57

CH39

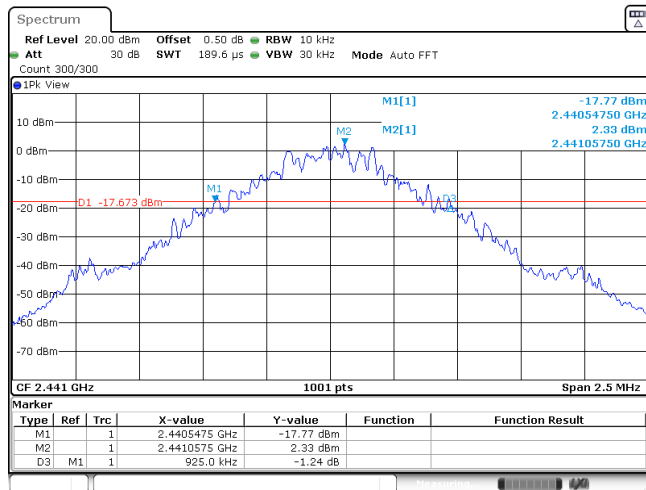

Date: 3 NOV 2023 08:41:06

CH78

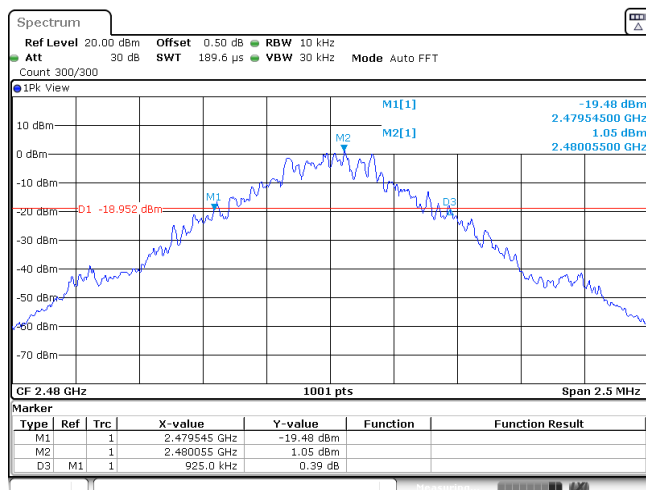

Date: 3 NOV 2023 08:42:55

Modulation Type:

$\pi/4$ DQPSK

CH00

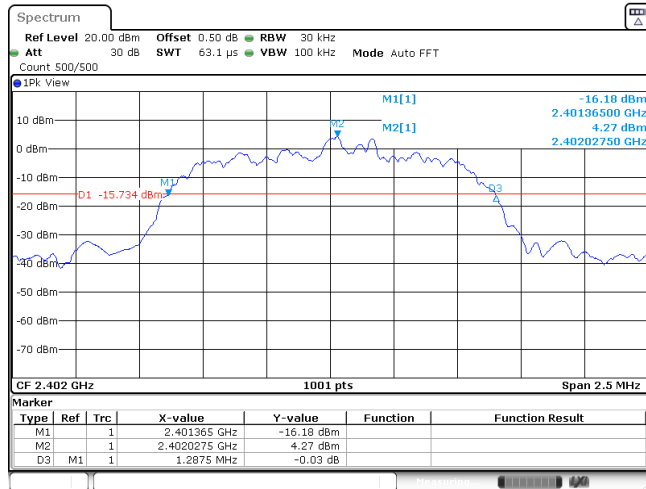

Date: 3 NOV 2023 08:45:15

CH39

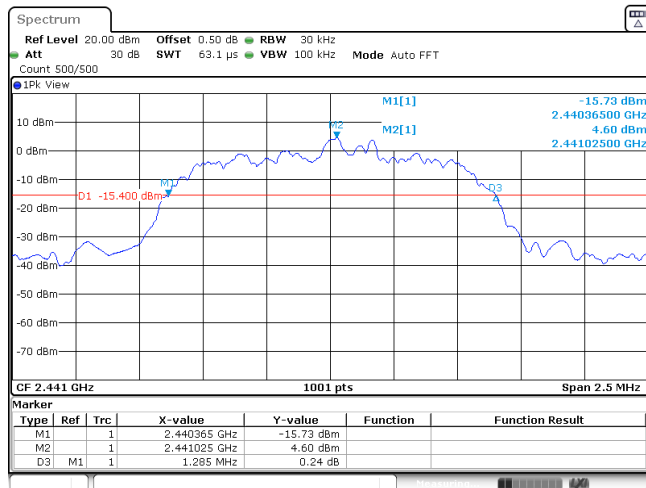

Date: 3 NOV 2023 08:47:13

CH78

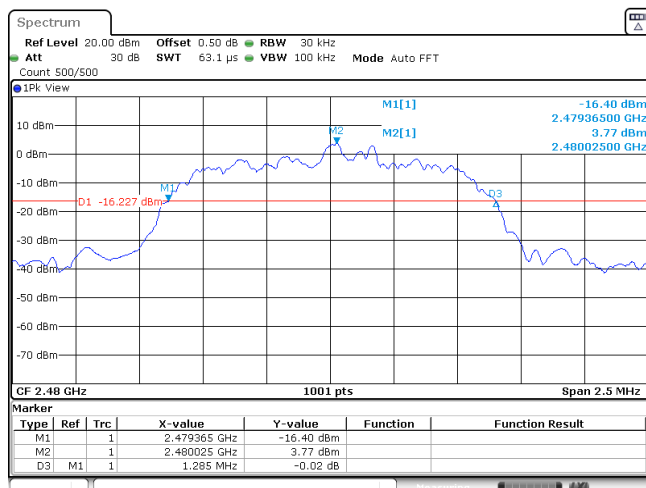

Date: 3 NOV 2023 08:48:54

Modulation Type:

8DPSK

CH00

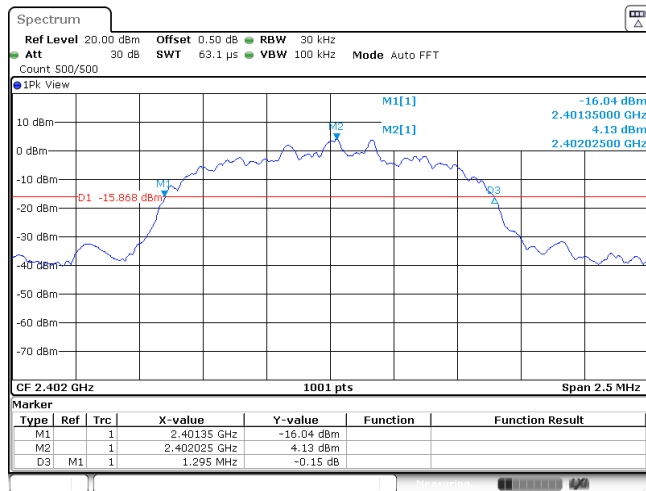

CH39

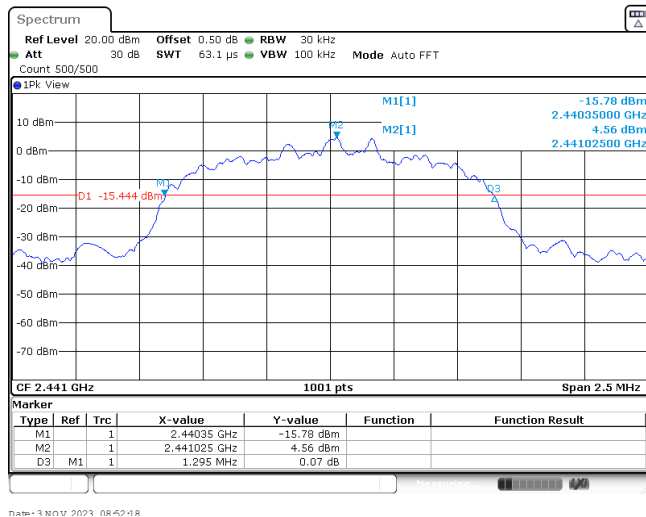

CH78

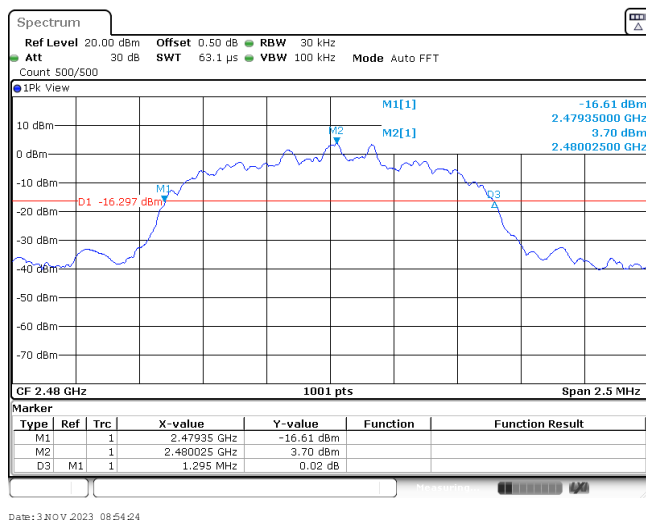

Appendix C: 99% Occupied Bandwidth

Modulation type	Channel	99% Occupied Bandwidth (MHz)	Limit (MHz)	Result
GFSK	00	0.87	-	Pass
	39	0.87		
	78	0.87		
$\pi/4$ DQPSK	00	1.18	-	Pass
	39	1.18		
	78	1.18		
8DPSK	00	1.18	-	Pass
	39	1.18		
	78	1.18		

Modulation Type:		GFSK
CH00		
CH39		
CH78		

Modulation Type: $\pi/4$ DQPSK

CH00



CH39

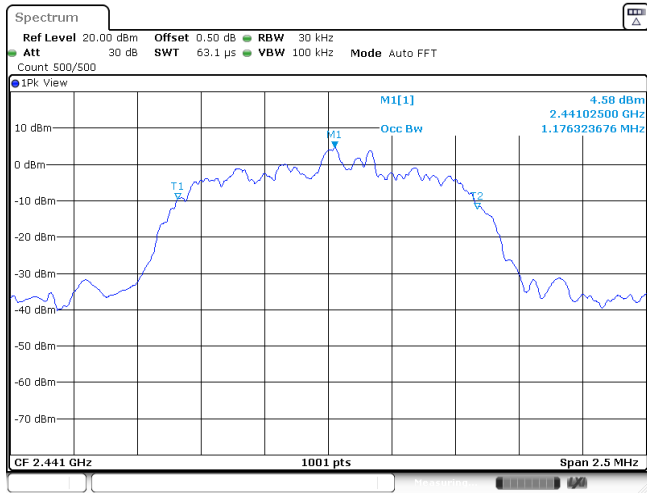

CH78

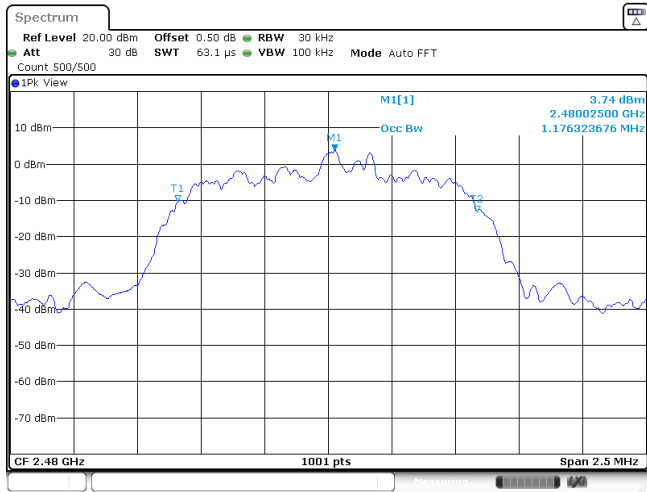

Modulation Type:

8DPSK

CH00

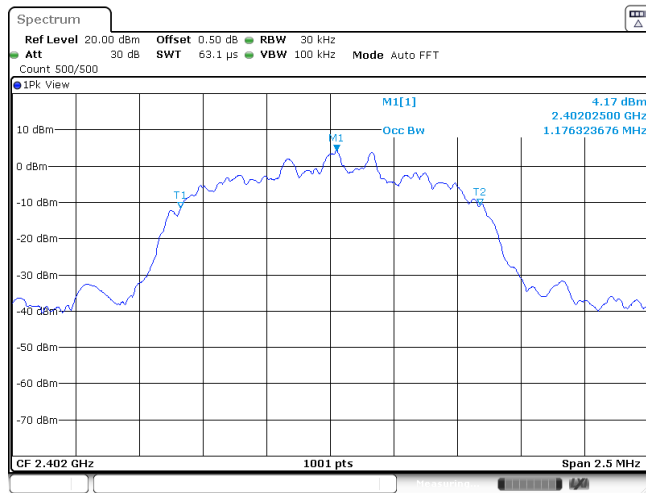

Ham:3 NOV 2023 09:38:46

CH39

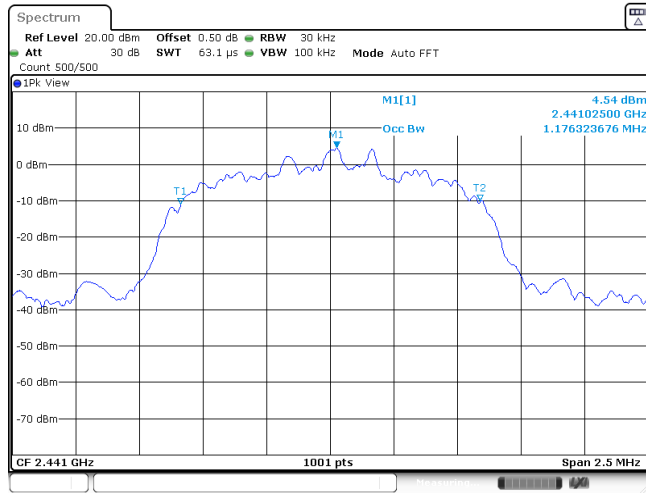

Ham:3 NOV 2023 08:52:05

CH78

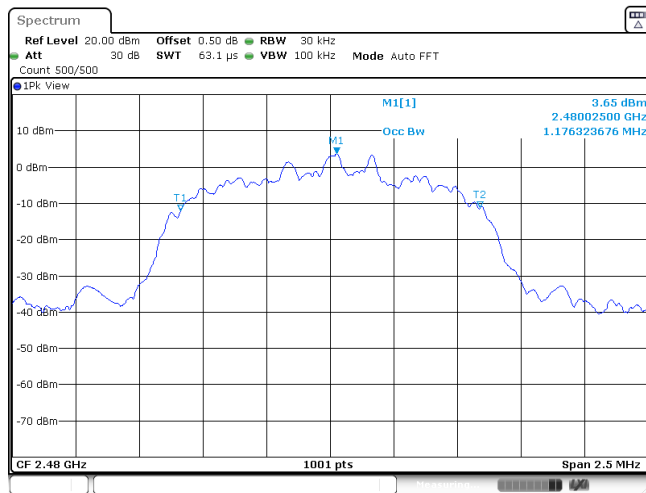

Ham:3 NOV 2023 08:54:31

Appendix D: Carrier Frequencies Separation

Modulation type	Channel	Carrier Frequencies Separation (MHz)	Limit (kHz) *	Result
GFSK	39	1.00	≥925	Pass
π/4DQPSK	39	1.00	≥818.67	Pass
8DPSK	39	1.14	≥863.33	Pass

Note:

*: GFSK limit = The maximum 20 dB Bandwidth for GFSK modulation on the appendix B.

π/4DQPSK limit = 2/3 * The maximum 20 dB Bandwidth for π/4DQPSK modulation on the appendix B.

8DPSK limit = 2/3 * The maximum 20 dB Bandwidth for 8DPSK modulation on the appendix B

GFSK

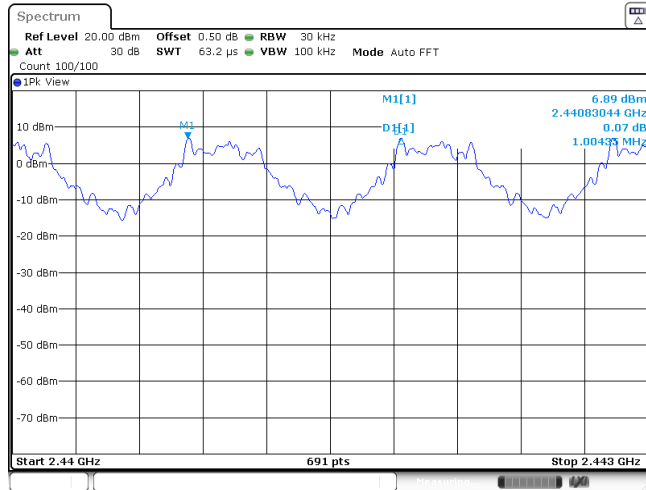

Date: 3 NOV 2023 09:43:18

π /4DQPSK

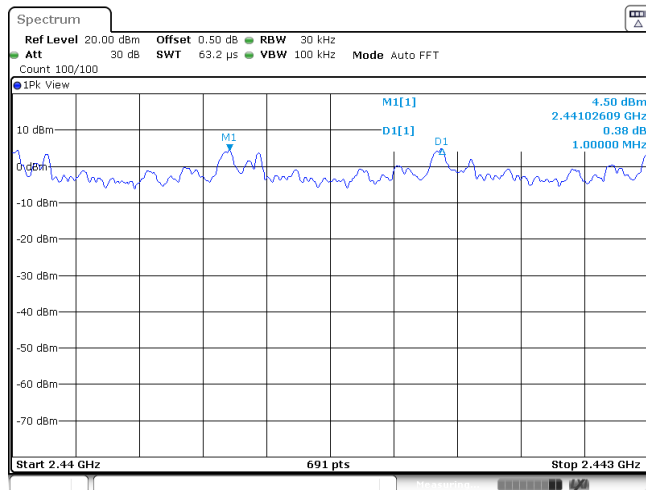

Date: 3 NOV 2023 09:45:49

8DPSK

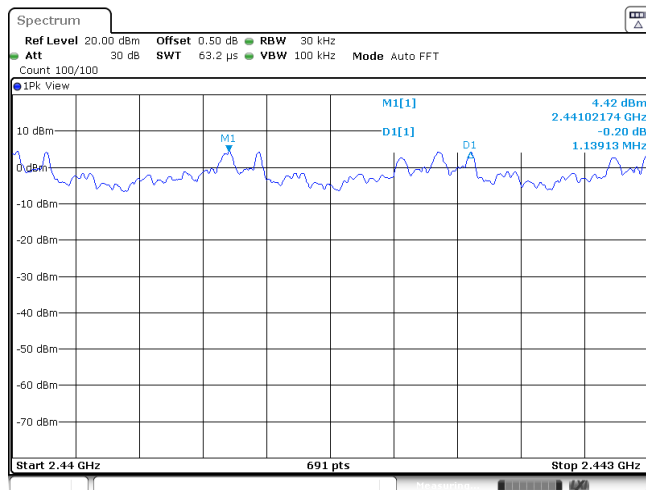

Date: 3 NOV 2023 09:40:52

Appendix E: Hopping Channel Number

Modulation type	Channel number	Limit	Result
GFSK	79	≥15.00	Pass
π/4DQPSK	79		
8DPSK	79		

GFSK

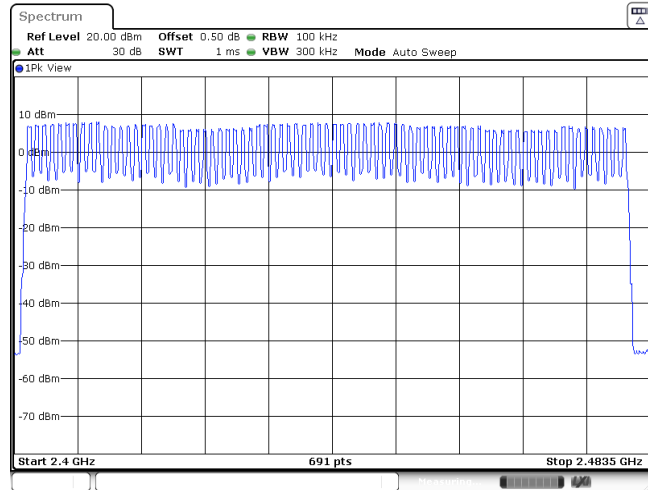

Date: 3 NOV 2023 09:04:10

$\pi/4$ DQPSK

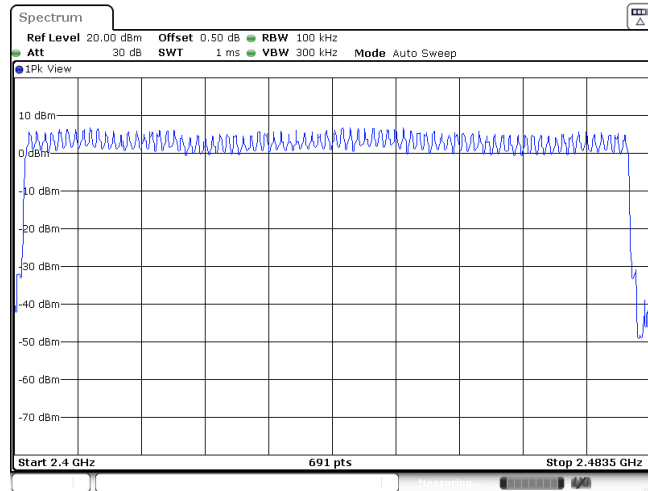

Date: 3 NOV 2023 09:06:09

8DPSK

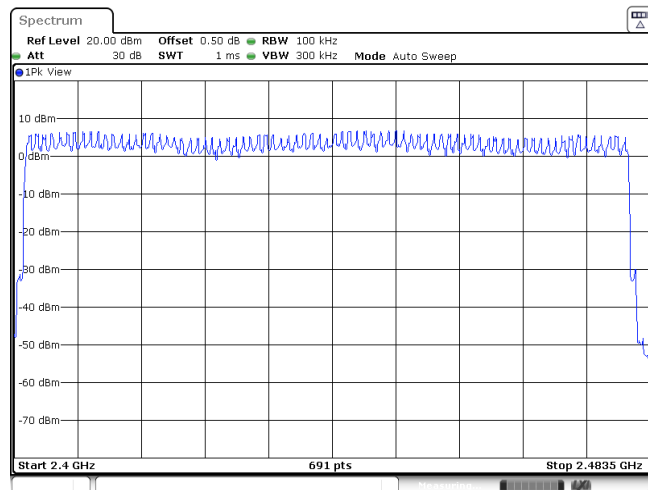

Date: 3 NOV 2023 09:11:03

Appendix F: Dwell Time

Modulation type	Packet	Burst Width [ms]	Total Hops[hop*ch]	Dwell time (Second)	Limit (Second)	Result
GFSK	DH1	0.40	319.00	0.13	≤ 0.40	Pass
	DH3	1.66	160.00	0.27		
	DH5	2.91	105.00	0.31		
π/4DQPSK	2DH1	0.40	319.00	0.13	≤ 0.40	Pass
	2DH3	1.65	160.00	0.26		
	2DH5	2.90	118.00	0.34		
8DPSK	3DH1	0.39	320.00	0.13	≤ 0.40	Pass
	3DH3	1.65	163.00	0.27		
	3DH5	2.90	105.00	0.30		

Modulation Type:

GFSK

DH1
Burst width

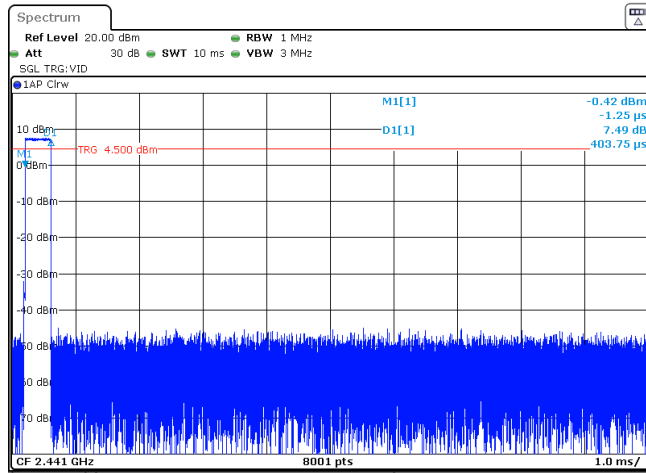

name: 3 Nov 2023_09:43:08

DH1
Burst number

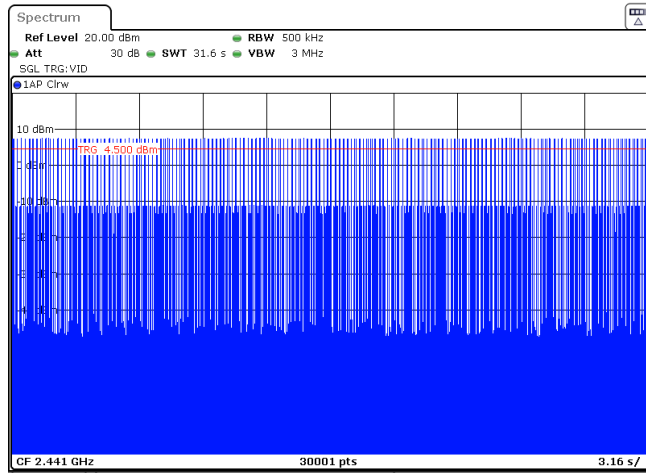

name: 3 Nov 2023_09:43:41

DH3
Burst width

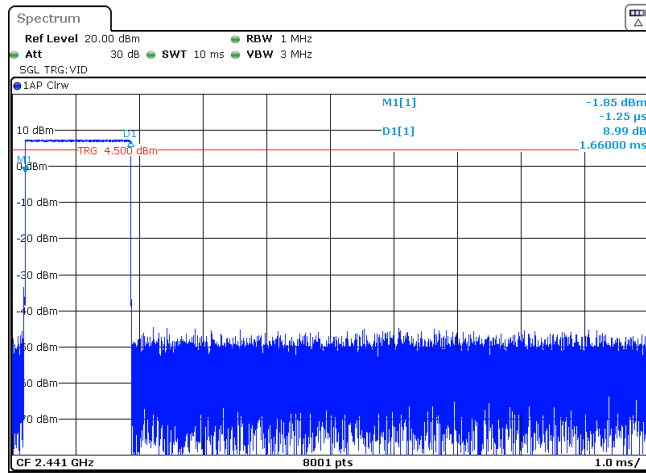

name: 3 Nov 2023_09:44:01

DH3
Burst number

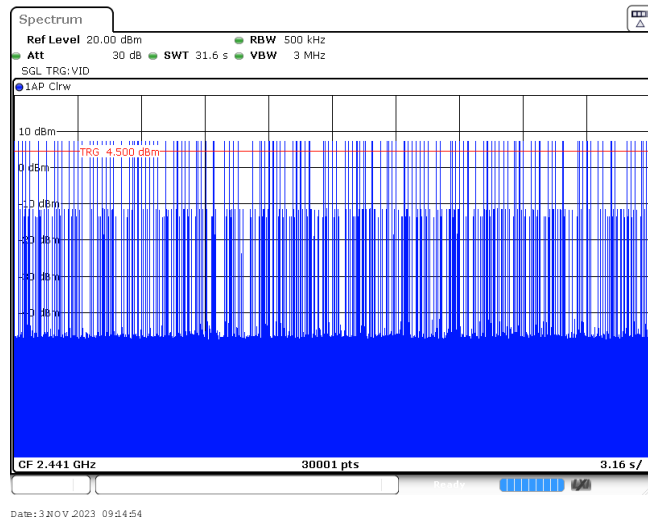

DH5
Burst width

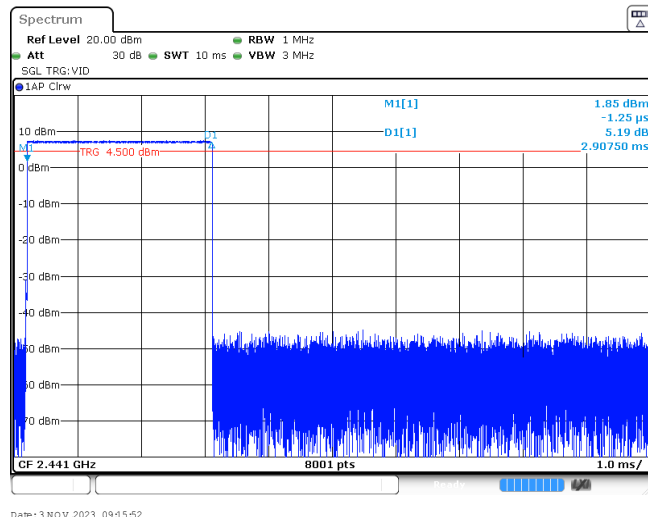

DH5
Burst number

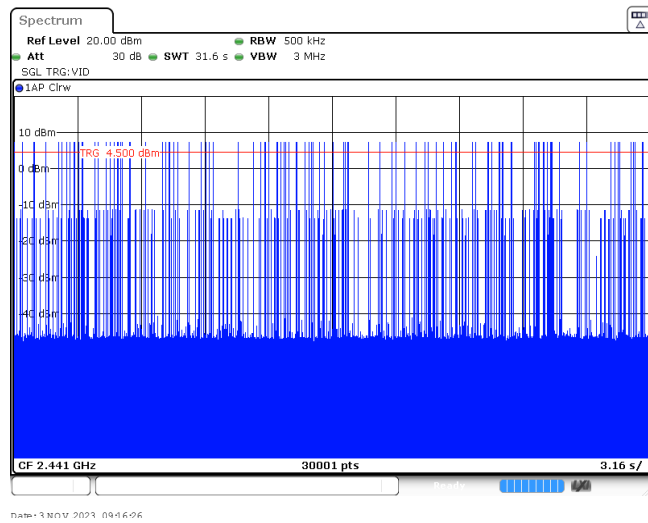

Modulation Type: $\pi/4$ DQPSK

2DH1
Burst width

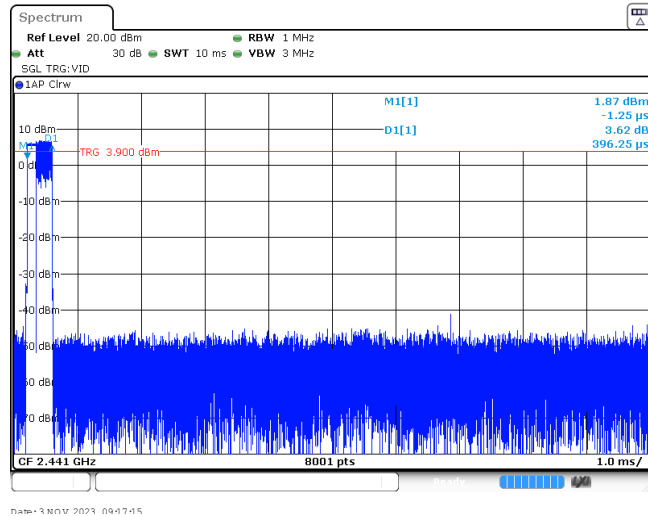

2DH1
Burst number

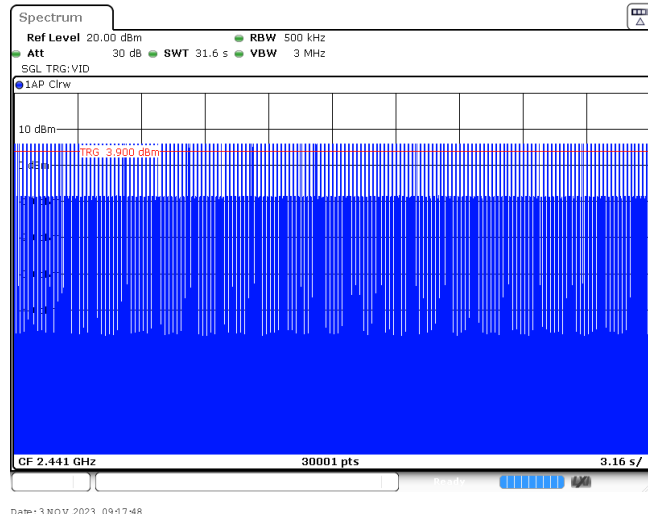

2DH3
Burst width

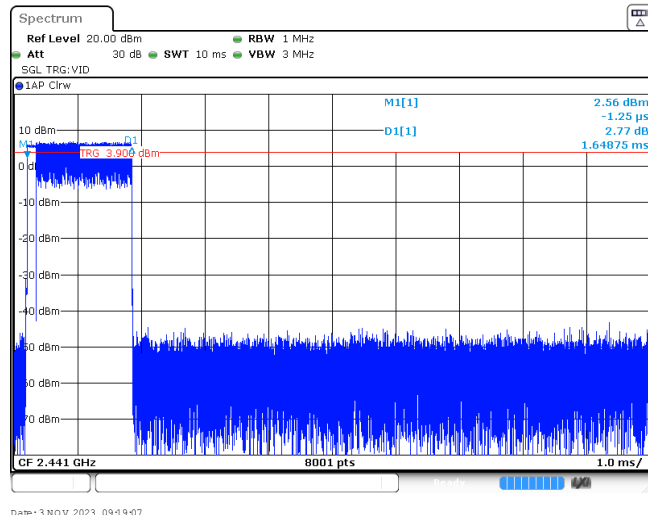

2DH3
Burst number

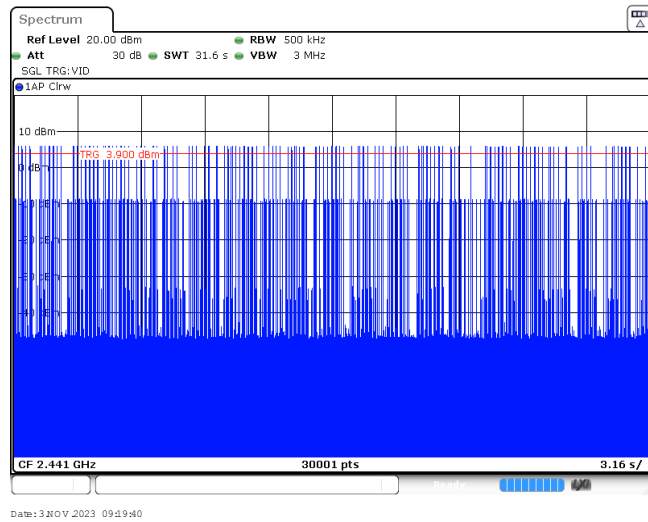

2DH5
Burst width

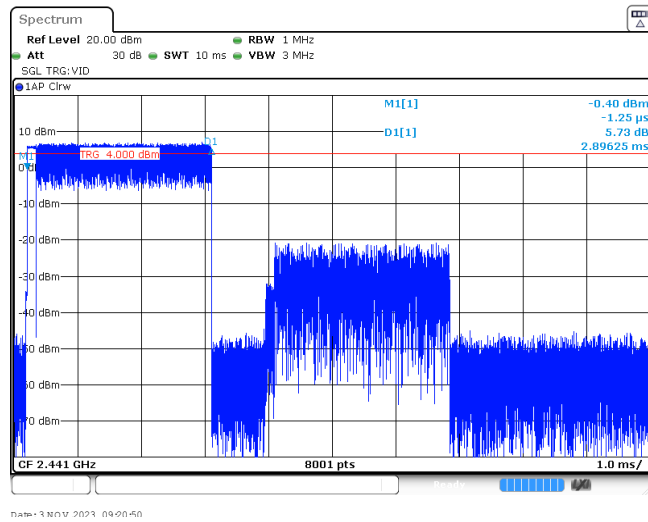

2DH5
Burst number

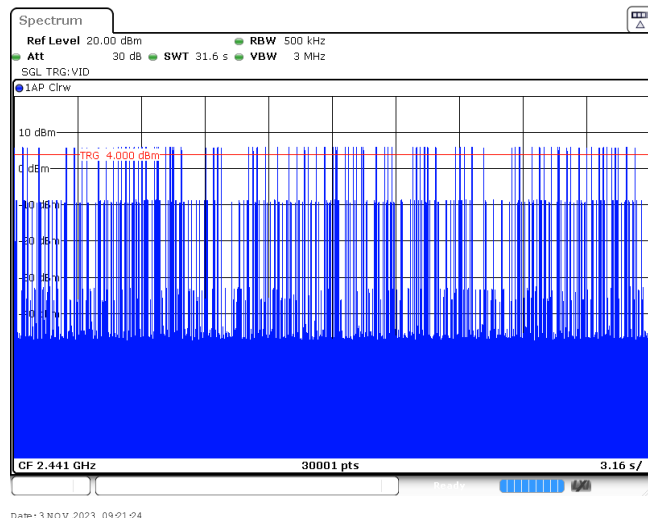

Modulation Type:

8DPSK

3DH1
Burst width

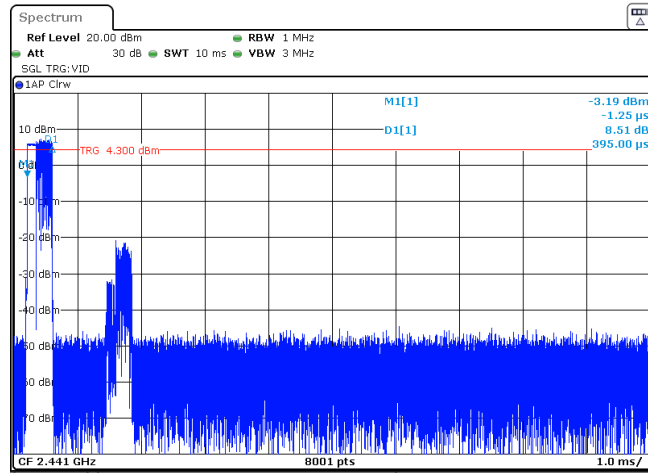

name: 3 Nov 2023 09:02:07

3DH1
Burst number

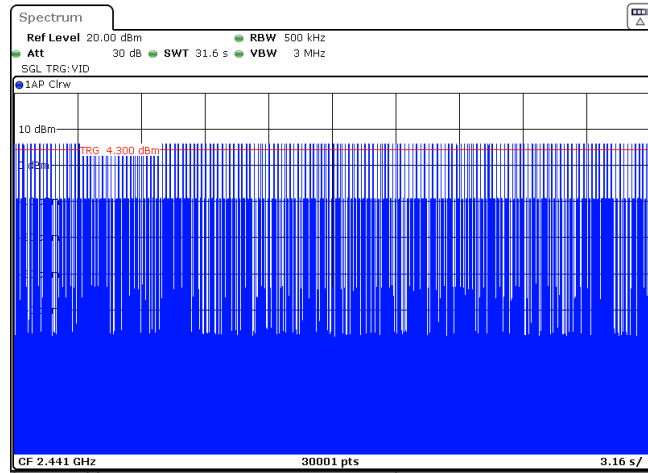

name: 3 Nov 2023 09:03:00

3DH3
Burst width

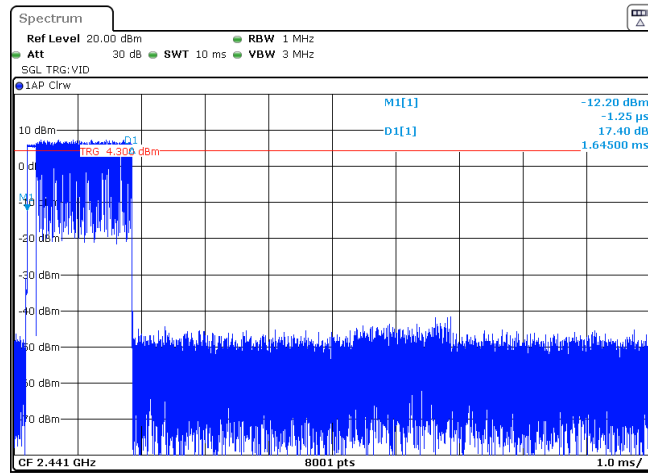

name: 3 Nov 2023 09:03:33

3DH3
Burst number

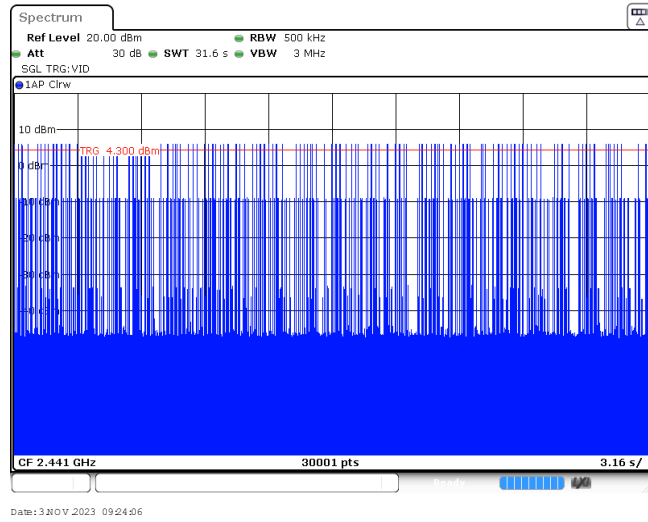

3DH5
Burst width

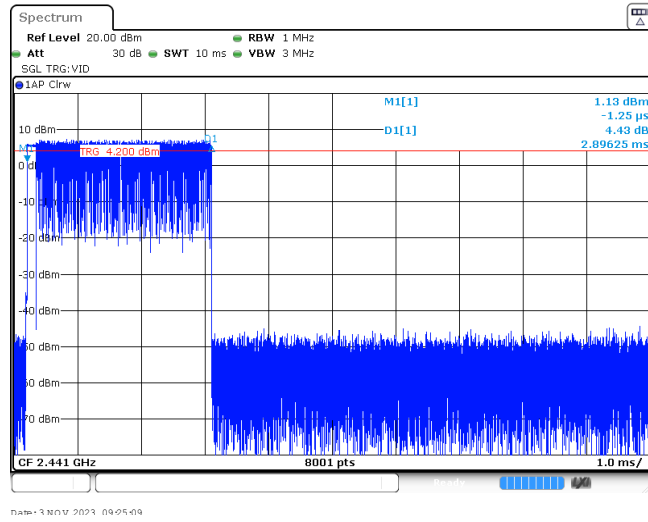

3DH5
Burst number

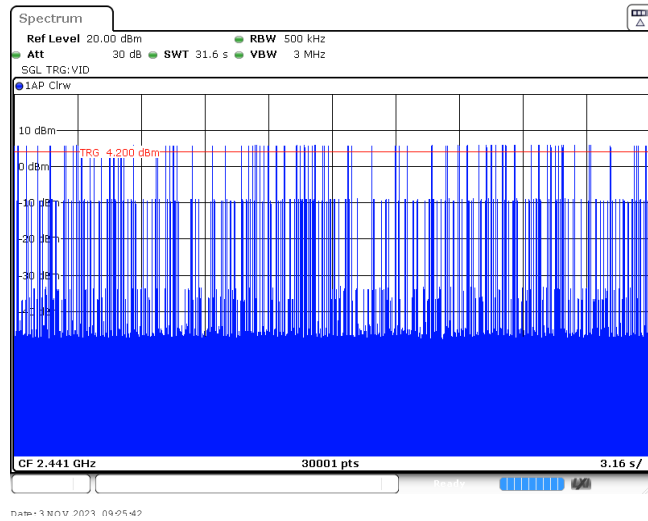

Appendix G: Duty Cycle Correction Factor (DCCF)

DCCF Calculate Formula					
DCCF=20 * Log(duty cycle) = 20 * Log($T_{on\ time} / T_{period}$)					
Modulation type	Test Frequency (MHz)	$T_{on\ time}$ for single burst [ms]	T_{period} [ms]	Burst Quantity	DCCF [dB]
GFSK	2441	2.89	100	1.00	-30.78
$\pi/4$ DQPSK	2441	1.62	100	1.00	-35.81
8DPSK	2441	2.87	100	1.00	-30.84

GFSK

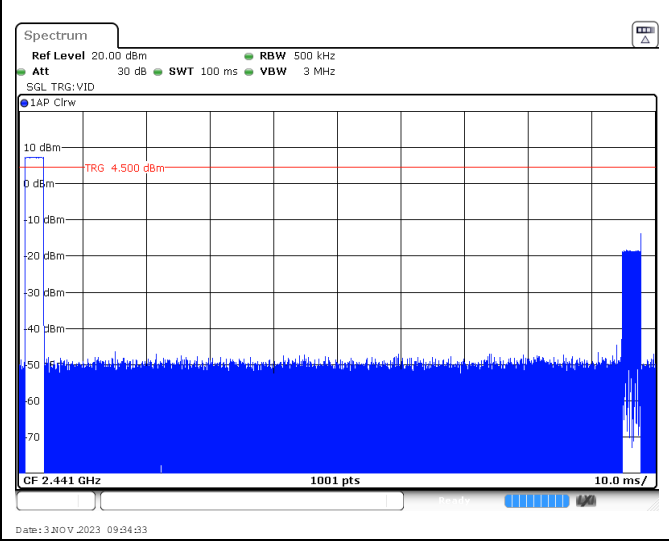
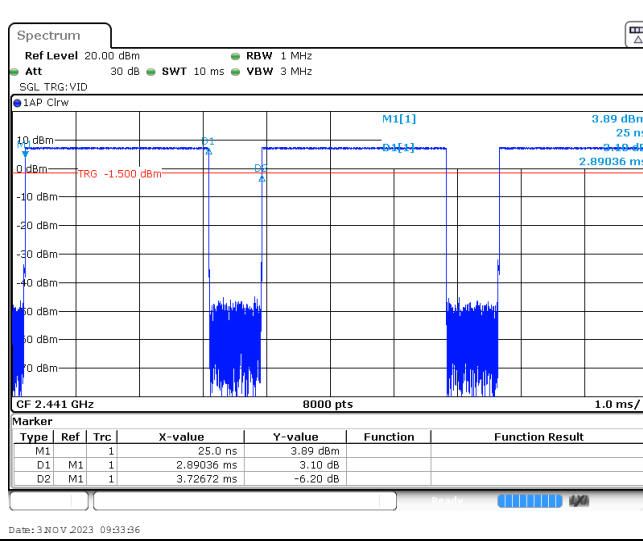

Ton time for single burst

Burst Quantity

$\pi/4$ DQPSK

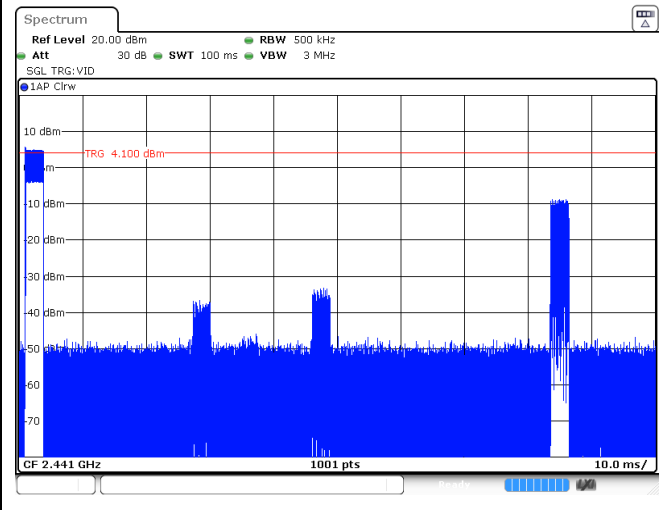
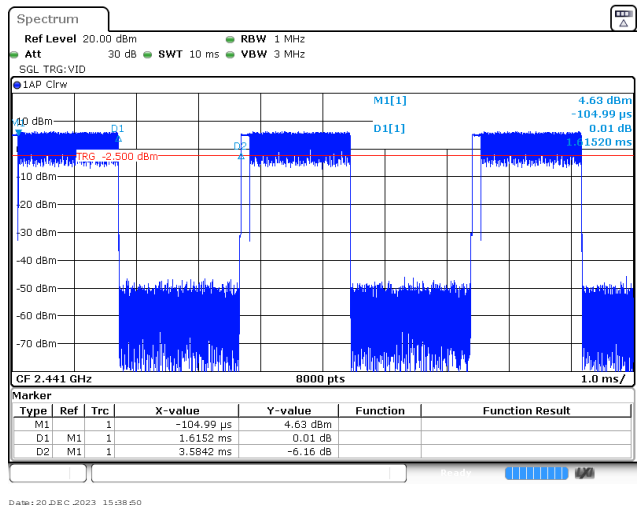

Ton time for single burst

Burst Quantity

8DPSK

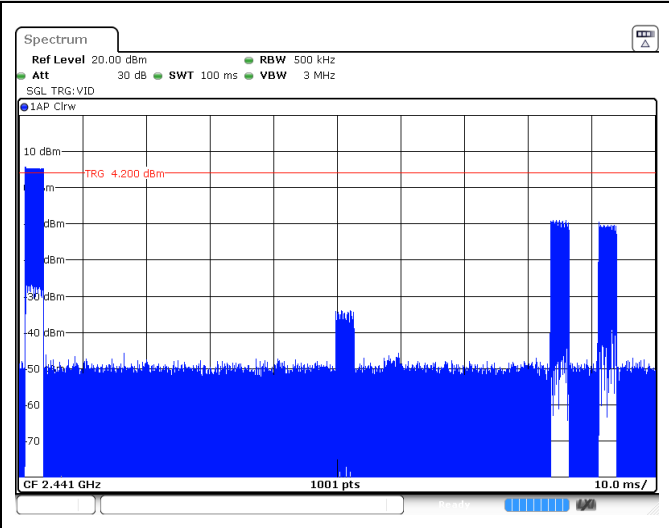
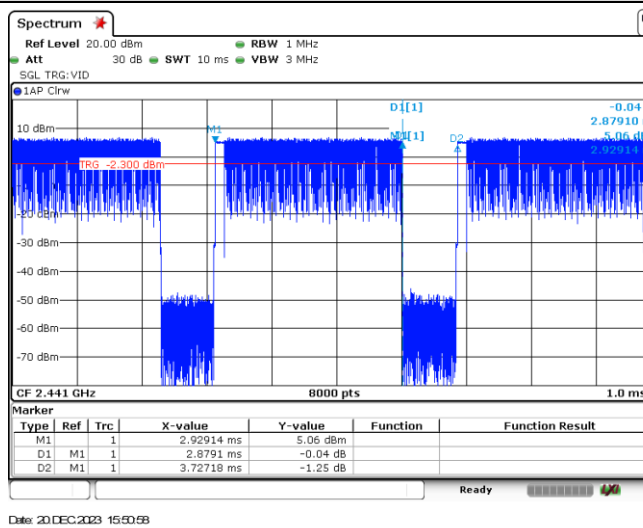

Ton time for single burst

Burst Quantity

Appendix H: Band edge and Spurious Emissions (conducted)

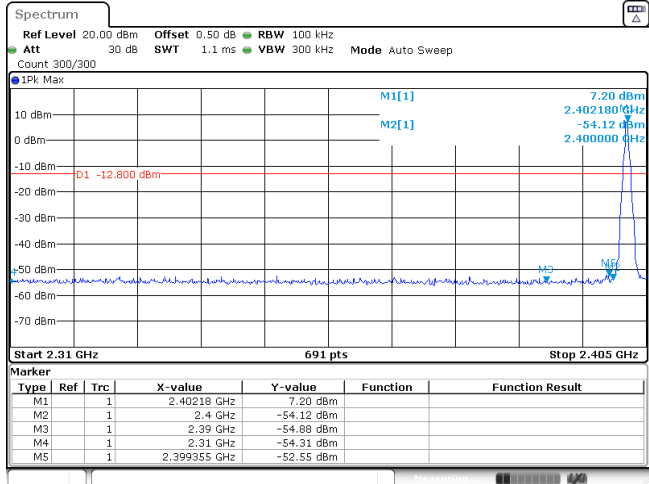
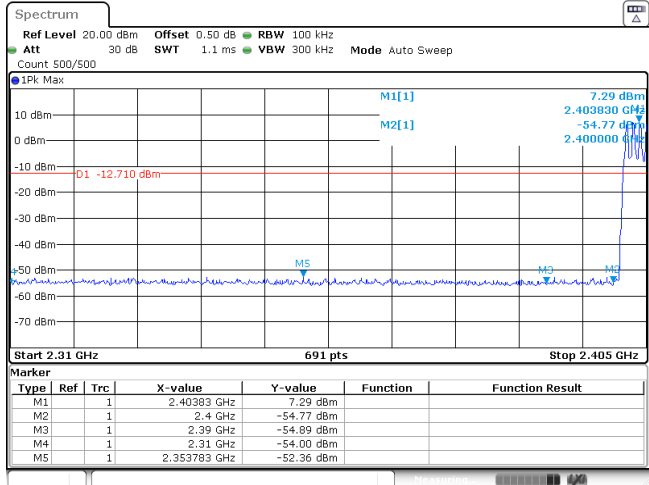
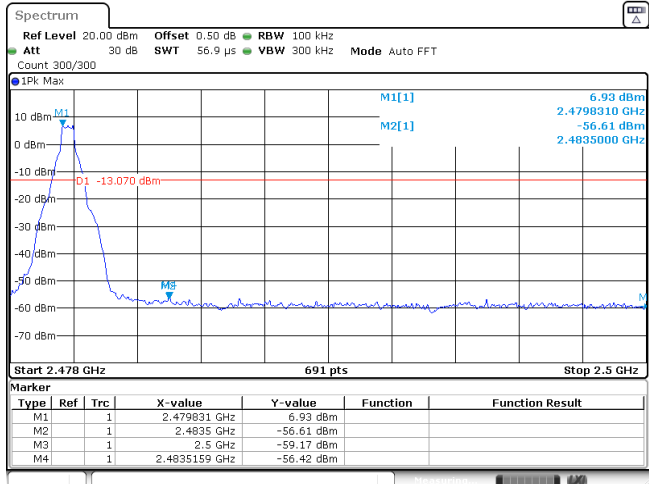
Test Item:	Band edge	Modulation type:	GFSK																																																
<p>CH00 No hopping mode</p>	 <table border="1" data-bbox="683 734 1334 840"> <thead> <tr> <th>Marker</th> <th>Type</th> <th>Ref</th> <th>Trc</th> <th>X-value</th> <th>Y-value</th> <th>Function</th> <th>Function Result</th> </tr> </thead> <tbody> <tr> <td>M1</td> <td>1</td> <td></td> <td>1</td> <td>2.40218 GHz</td> <td>7.20 dBm</td> <td></td> <td></td> </tr> <tr> <td>M2</td> <td>1</td> <td></td> <td>1</td> <td>2.4 GHz</td> <td>-54.12 dBm</td> <td></td> <td></td> </tr> <tr> <td>M3</td> <td>1</td> <td></td> <td>1</td> <td>2.39 GHz</td> <td>-54.89 dBm</td> <td></td> <td></td> </tr> <tr> <td>M4</td> <td>1</td> <td></td> <td>1</td> <td>2.31 GHz</td> <td>-54.31 dBm</td> <td></td> <td></td> </tr> <tr> <td>M5</td> <td>1</td> <td></td> <td>1</td> <td>2.399355 GHz</td> <td>-52.55 dBm</td> <td></td> <td></td> </tr> </tbody> </table> <p>Date: 3 NOV 2023 08:39:50</p>			Marker	Type	Ref	Trc	X-value	Y-value	Function	Function Result	M1	1		1	2.40218 GHz	7.20 dBm			M2	1		1	2.4 GHz	-54.12 dBm			M3	1		1	2.39 GHz	-54.89 dBm			M4	1		1	2.31 GHz	-54.31 dBm			M5	1		1	2.399355 GHz	-52.55 dBm		
Marker	Type	Ref	Trc	X-value	Y-value	Function	Function Result																																												
M1	1		1	2.40218 GHz	7.20 dBm																																														
M2	1		1	2.4 GHz	-54.12 dBm																																														
M3	1		1	2.39 GHz	-54.89 dBm																																														
M4	1		1	2.31 GHz	-54.31 dBm																																														
M5	1		1	2.399355 GHz	-52.55 dBm																																														
<p>CH00 Hopping mode</p>	 <table border="1" data-bbox="683 1281 1334 1386"> <thead> <tr> <th>Marker</th> <th>Type</th> <th>Ref</th> <th>Trc</th> <th>X-value</th> <th>Y-value</th> <th>Function</th> <th>Function Result</th> </tr> </thead> <tbody> <tr> <td>M1</td> <td>1</td> <td></td> <td>1</td> <td>2.40383 GHz</td> <td>7.29 dBm</td> <td></td> <td></td> </tr> <tr> <td>M2</td> <td>1</td> <td></td> <td>1</td> <td>2.4 GHz</td> <td>-54.77 dBm</td> <td></td> <td></td> </tr> <tr> <td>M3</td> <td>1</td> <td></td> <td>1</td> <td>2.39 GHz</td> <td>-54.89 dBm</td> <td></td> <td></td> </tr> <tr> <td>M4</td> <td>1</td> <td></td> <td>1</td> <td>2.31 GHz</td> <td>-54.00 dBm</td> <td></td> <td></td> </tr> <tr> <td>M5</td> <td>1</td> <td></td> <td>1</td> <td>2.353783 GHz</td> <td>-52.36 dBm</td> <td></td> <td></td> </tr> </tbody> </table> <p>Date: 3 NOV 2023 09:04:53</p>			Marker	Type	Ref	Trc	X-value	Y-value	Function	Function Result	M1	1		1	2.40383 GHz	7.29 dBm			M2	1		1	2.4 GHz	-54.77 dBm			M3	1		1	2.39 GHz	-54.89 dBm			M4	1		1	2.31 GHz	-54.00 dBm			M5	1		1	2.353783 GHz	-52.36 dBm		
Marker	Type	Ref	Trc	X-value	Y-value	Function	Function Result																																												
M1	1		1	2.40383 GHz	7.29 dBm																																														
M2	1		1	2.4 GHz	-54.77 dBm																																														
M3	1		1	2.39 GHz	-54.89 dBm																																														
M4	1		1	2.31 GHz	-54.00 dBm																																														
M5	1		1	2.353783 GHz	-52.36 dBm																																														
<p>CH78 No hopping mode</p>	 <table border="1" data-bbox="683 1850 1334 1933"> <thead> <tr> <th>Marker</th> <th>Type</th> <th>Ref</th> <th>Trc</th> <th>X-value</th> <th>Y-value</th> <th>Function</th> <th>Function Result</th> </tr> </thead> <tbody> <tr> <td>M1</td> <td>1</td> <td></td> <td>1</td> <td>2.479831 GHz</td> <td>6.93 dBm</td> <td></td> <td></td> </tr> <tr> <td>M2</td> <td>1</td> <td></td> <td>1</td> <td>2.4835 GHz</td> <td>-56.61 dBm</td> <td></td> <td></td> </tr> <tr> <td>M3</td> <td>1</td> <td></td> <td>1</td> <td>2.5 GHz</td> <td>-59.17 dBm</td> <td></td> <td></td> </tr> <tr> <td>M4</td> <td>1</td> <td></td> <td>1</td> <td>2.4835159 GHz</td> <td>-56.42 dBm</td> <td></td> <td></td> </tr> </tbody> </table> <p>Date: 3 NOV 2023 08:43:24</p>			Marker	Type	Ref	Trc	X-value	Y-value	Function	Function Result	M1	1		1	2.479831 GHz	6.93 dBm			M2	1		1	2.4835 GHz	-56.61 dBm			M3	1		1	2.5 GHz	-59.17 dBm			M4	1		1	2.4835159 GHz	-56.42 dBm										
Marker	Type	Ref	Trc	X-value	Y-value	Function	Function Result																																												
M1	1		1	2.479831 GHz	6.93 dBm																																														
M2	1		1	2.4835 GHz	-56.61 dBm																																														
M3	1		1	2.5 GHz	-59.17 dBm																																														
M4	1		1	2.4835159 GHz	-56.42 dBm																																														

CH78
Hopping mode

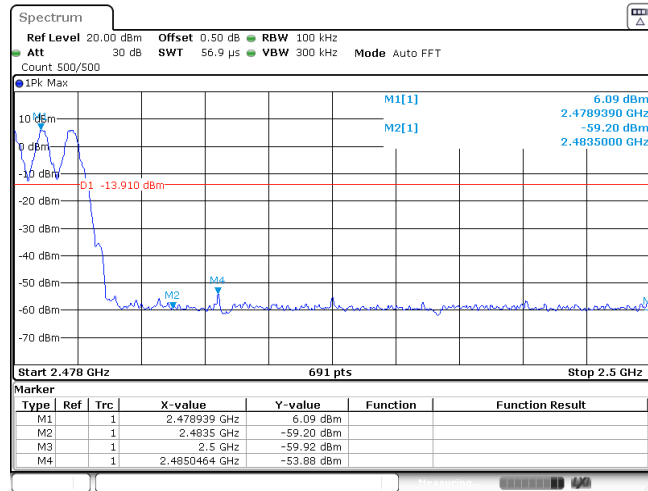

Date: 3 NOV 2023 09:04:37

Test Item:	Band edge	Modulation type:	$\pi/4$ DQPSK																																										
<p>CH00 No hopping mode</p>	<p>Ref Level 20.00 dBm Offset 0.50 dB RBW 100 kHz Att 30 dB SWT 1.1 ms VBW 300 kHz Mode Auto Sweep Count 500/500</p> <p>1PK Max</p> <table border="1"> <thead> <tr> <th>Type</th> <th>Ref</th> <th>Trc</th> <th>X-value</th> <th>Y-value</th> <th>Function</th> <th>Function Result</th> </tr> </thead> <tbody> <tr> <td>M1</td> <td>1</td> <td></td> <td>2.40204 GHz</td> <td>5.73 dBm</td> <td></td> <td></td> </tr> <tr> <td>M2</td> <td>1</td> <td></td> <td>2.4 GHz</td> <td>-47.29 dBm</td> <td></td> <td></td> </tr> <tr> <td>M3</td> <td>1</td> <td></td> <td>2.39 GHz</td> <td>-55.15 dBm</td> <td></td> <td></td> </tr> <tr> <td>M4</td> <td>1</td> <td></td> <td>2.31 GHz</td> <td>-54.14 dBm</td> <td></td> <td></td> </tr> <tr> <td>M5</td> <td>1</td> <td></td> <td>2.39963 GHz</td> <td>-44.62 dBm</td> <td></td> <td></td> </tr> </tbody> </table> <p>Start 2.31 GHz 691 pts Stop 2.405 GHz</p> <p>Date: 3 NOV 2023 08:45:44</p>			Type	Ref	Trc	X-value	Y-value	Function	Function Result	M1	1		2.40204 GHz	5.73 dBm			M2	1		2.4 GHz	-47.29 dBm			M3	1		2.39 GHz	-55.15 dBm			M4	1		2.31 GHz	-54.14 dBm			M5	1		2.39963 GHz	-44.62 dBm		
Type	Ref	Trc	X-value	Y-value	Function	Function Result																																							
M1	1		2.40204 GHz	5.73 dBm																																									
M2	1		2.4 GHz	-47.29 dBm																																									
M3	1		2.39 GHz	-55.15 dBm																																									
M4	1		2.31 GHz	-54.14 dBm																																									
M5	1		2.39963 GHz	-44.62 dBm																																									
<p>CH00 Hopping mode</p>	<p>Ref Level 20.00 dBm Offset 0.50 dB RBW 100 kHz Att 30 dB SWT 1.1 ms VBW 300 kHz Mode Auto Sweep Count 500/500</p> <p>1PK Max</p> <table border="1"> <thead> <tr> <th>Type</th> <th>Ref</th> <th>Trc</th> <th>X-value</th> <th>Y-value</th> <th>Function</th> <th>Function Result</th> </tr> </thead> <tbody> <tr> <td>M1</td> <td>1</td> <td></td> <td>2.40314 GHz</td> <td>4.64 dBm</td> <td></td> <td></td> </tr> <tr> <td>M2</td> <td>1</td> <td></td> <td>2.4 GHz</td> <td>-49.16 dBm</td> <td></td> <td></td> </tr> <tr> <td>M3</td> <td>1</td> <td></td> <td>2.39 GHz</td> <td>-54.79 dBm</td> <td></td> <td></td> </tr> <tr> <td>M4</td> <td>1</td> <td></td> <td>2.31 GHz</td> <td>-53.78 dBm</td> <td></td> <td></td> </tr> <tr> <td>M5</td> <td>1</td> <td></td> <td>2.399768 GHz</td> <td>-47.51 dBm</td> <td></td> <td></td> </tr> </tbody> </table> <p>Start 2.31 GHz 691 pts Stop 2.405 GHz</p> <p>Date: 3 NOV 2023 08:46:22</p>			Type	Ref	Trc	X-value	Y-value	Function	Function Result	M1	1		2.40314 GHz	4.64 dBm			M2	1		2.4 GHz	-49.16 dBm			M3	1		2.39 GHz	-54.79 dBm			M4	1		2.31 GHz	-53.78 dBm			M5	1		2.399768 GHz	-47.51 dBm		
Type	Ref	Trc	X-value	Y-value	Function	Function Result																																							
M1	1		2.40314 GHz	4.64 dBm																																									
M2	1		2.4 GHz	-49.16 dBm																																									
M3	1		2.39 GHz	-54.79 dBm																																									
M4	1		2.31 GHz	-53.78 dBm																																									
M5	1		2.399768 GHz	-47.51 dBm																																									
<p>CH78 No hopping mode</p>	<p>Ref Level 20.00 dBm Offset 0.50 dB RBW 100 kHz Att 30 dB SWT 56.9 μs VBW 300 kHz Mode Auto FFT Count 500/500</p> <p>1PK Max</p> <table border="1"> <thead> <tr> <th>Type</th> <th>Ref</th> <th>Trc</th> <th>X-value</th> <th>Y-value</th> <th>Function</th> <th>Function Result</th> </tr> </thead> <tbody> <tr> <td>M1</td> <td>1</td> <td></td> <td>2.47999 GHz</td> <td>5.83 dBm</td> <td></td> <td></td> </tr> <tr> <td>M2</td> <td>1</td> <td></td> <td>2.4835 GHz</td> <td>-56.78 dBm</td> <td></td> <td></td> </tr> <tr> <td>M3</td> <td>1</td> <td></td> <td>2.5 GHz</td> <td>-59.25 dBm</td> <td></td> <td></td> </tr> <tr> <td>M4</td> <td>1</td> <td></td> <td>2.484058 GHz</td> <td>-55.82 dBm</td> <td></td> <td></td> </tr> </tbody> </table> <p>Start 2.478 GHz 691 pts Stop 2.5 GHz</p> <p>Date: 3 NOV 2023 08:49:02</p>			Type	Ref	Trc	X-value	Y-value	Function	Function Result	M1	1		2.47999 GHz	5.83 dBm			M2	1		2.4835 GHz	-56.78 dBm			M3	1		2.5 GHz	-59.25 dBm			M4	1		2.484058 GHz	-55.82 dBm									
Type	Ref	Trc	X-value	Y-value	Function	Function Result																																							
M1	1		2.47999 GHz	5.83 dBm																																									
M2	1		2.4835 GHz	-56.78 dBm																																									
M3	1		2.5 GHz	-59.25 dBm																																									
M4	1		2.484058 GHz	-55.82 dBm																																									

CH78
Hopping mode

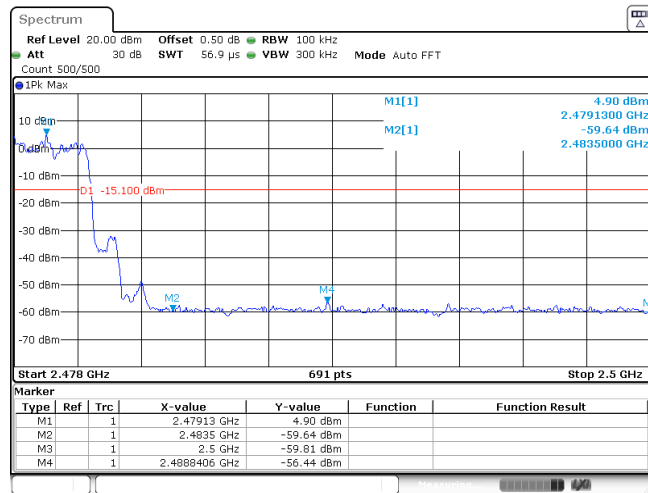

Date: 3 NOV 2023 09:06:36

Test Item:	Band edge	Modulation type:	8DPSK
-------------------	------------------	-------------------------	--------------

CH00
No hopping mode

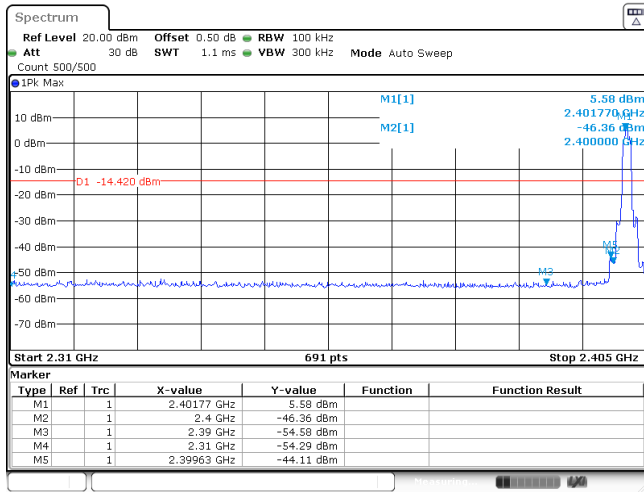

Date: 3 NOV 2023 09:48:37

CH00
Hopping mode

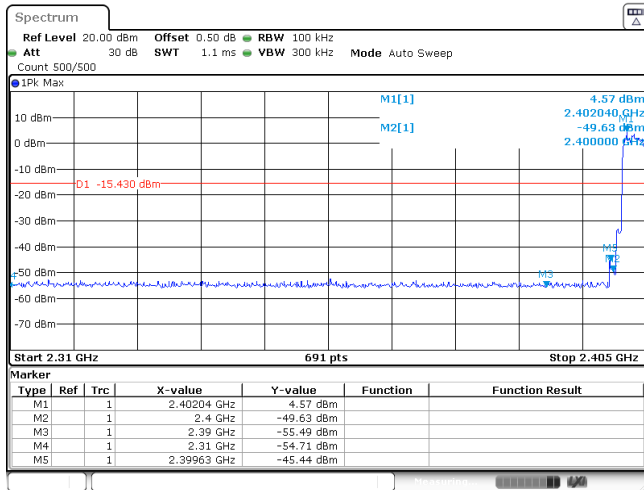

Date: 3 NOV 2023 09:41:46

CH78
No hopping mode

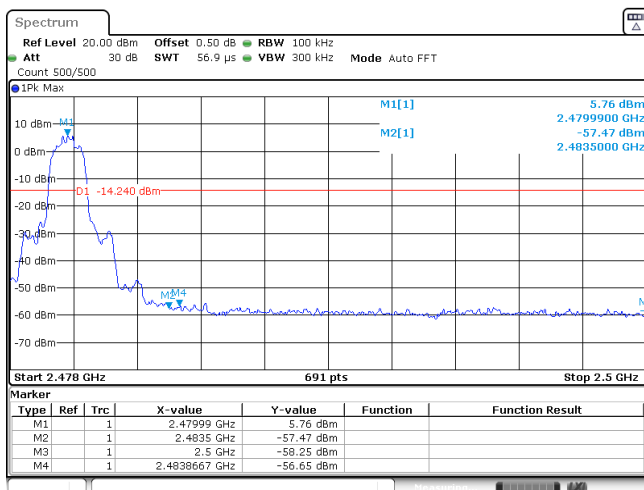

Date: 3 NOV 2023 08:54:52

CH78
Hoppig mode

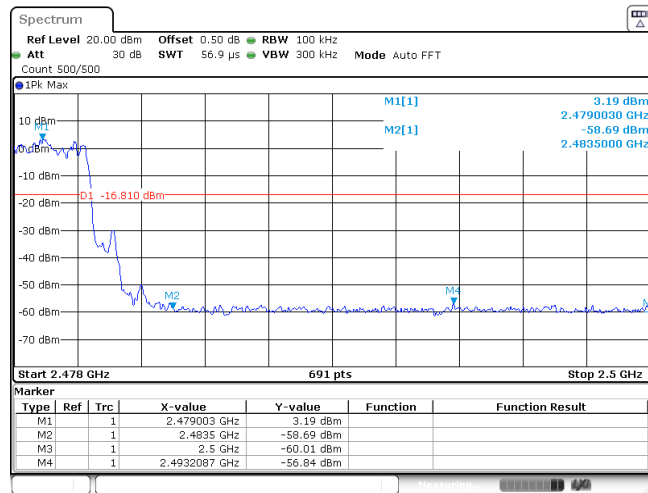

Date: 3 NOV 2023 09:11:30

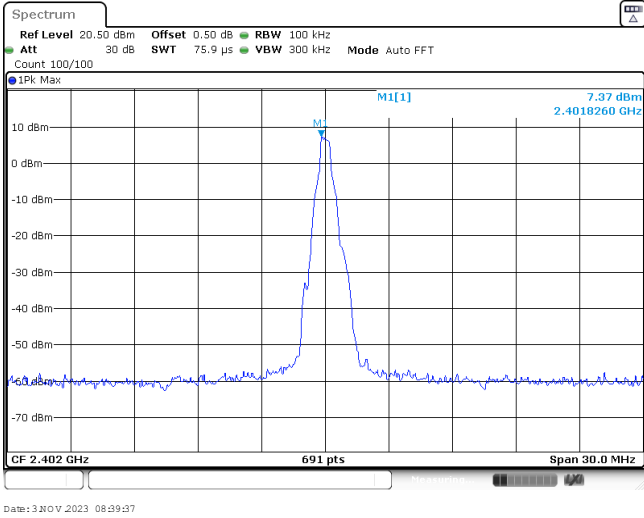
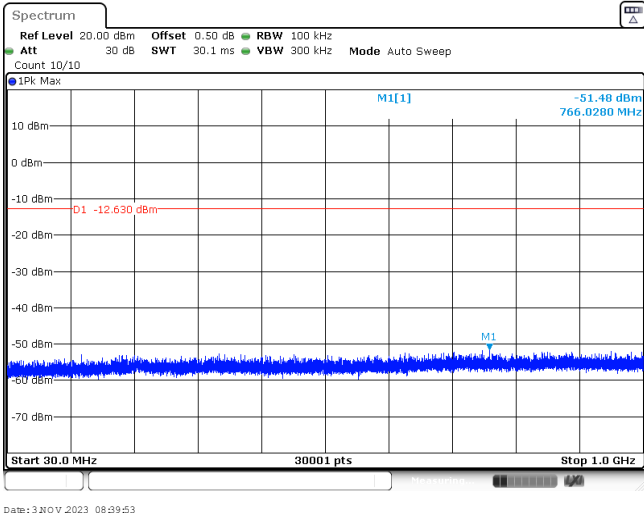
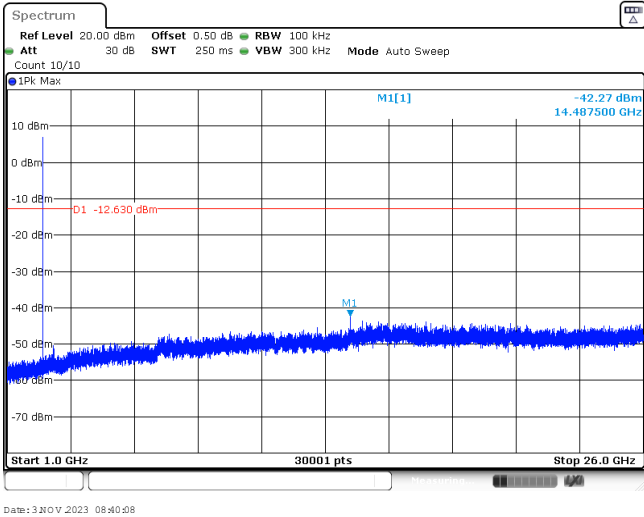
Test Item:	Spurious Emission	Modulation type:	GFSK
<p>CH00 Reference level</p>			
<p>CH00 30MHz~1000MHz</p>			
<p>CH00 1GHz~26GHz</p>			

CH39
Reference level

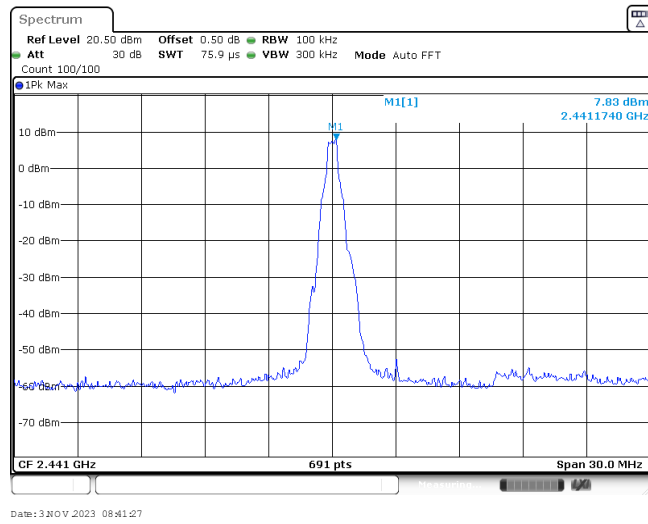

CH39
30MHz~1000MHz

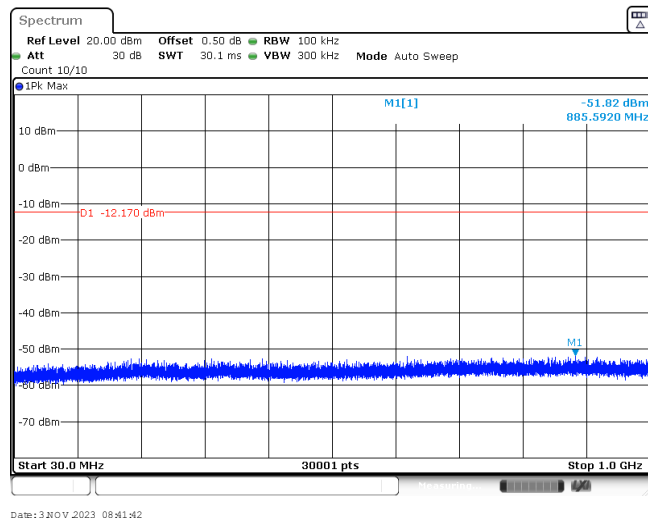

CH39
1GHz~26GHz

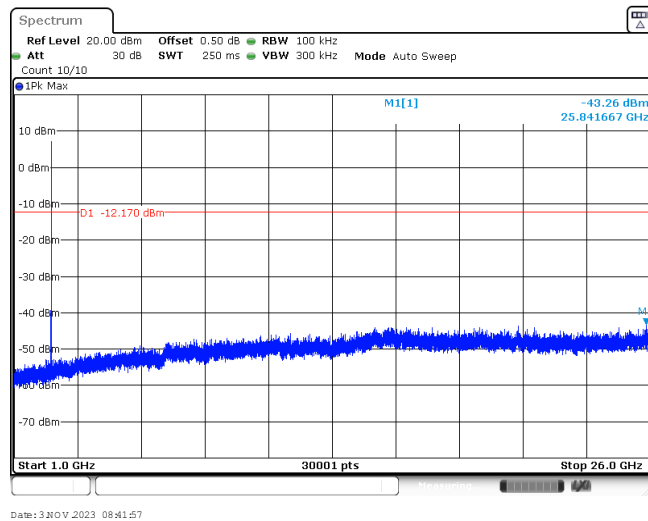

CH78
Reference level

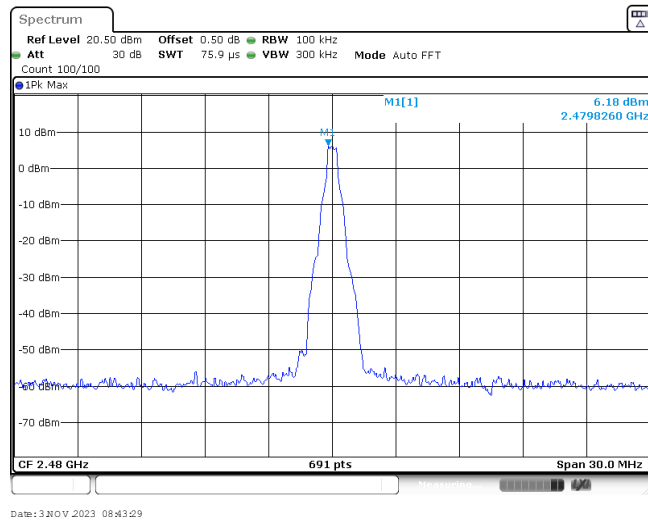

CH78
30MHz~1000MHz

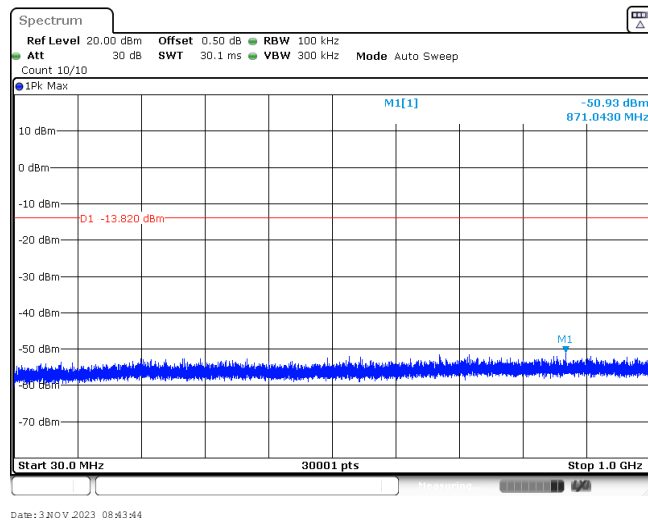

CH78
1GHz~26GHz

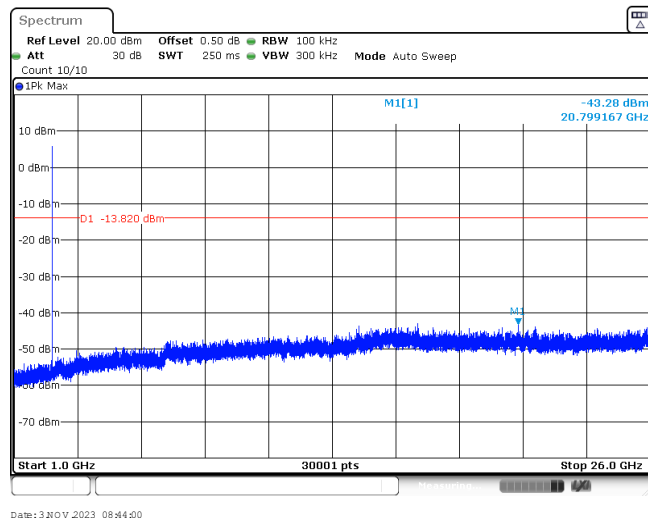

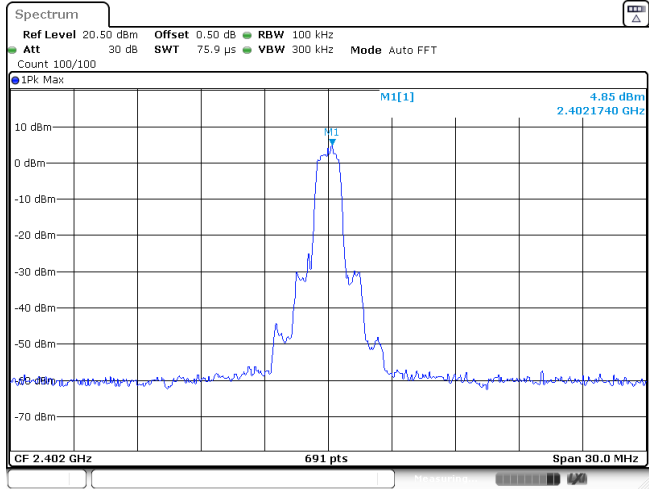
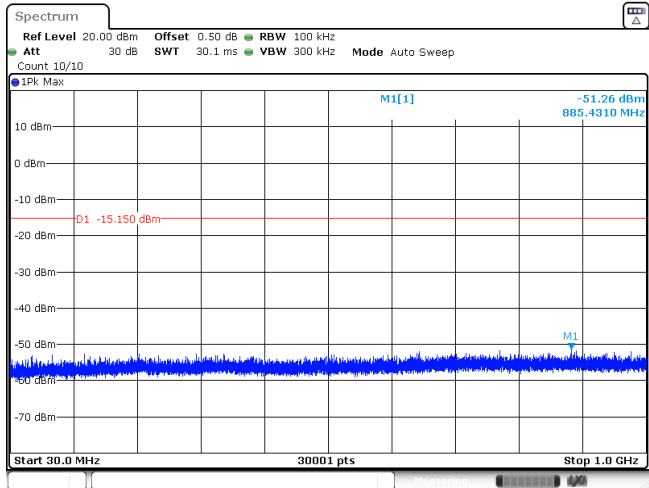
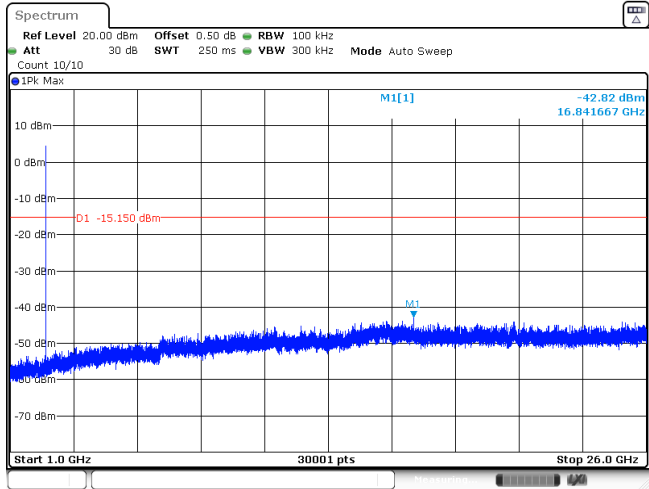
Test Item:	Spurious Emission	Modulation type:	π/4DQPSK
<p>CH00 Reference level</p>	 <p>Spectrum Ref Level 20.50 dBm Offset 0.50 dB RBW 100 kHz Att 30 dB SWT 75.9 μs VBW 300 kHz Mode Auto FFT Count 100/100 1Pk Max M1[1] 4.85 dBm 2.4021740 GHz CF 2.402 GHz 691 pts Span 30.0 MHz Date: 3 NOV 2023 08:45:49</p>		
<p>CH00 30MHz~1000MHz</p>	 <p>Spectrum Ref Level 20.00 dBm Offset 0.50 dB RBW 100 kHz Att 30 dB SWT 30.1 ms VBW 300 kHz Mode Auto Sweep Count 10/10 1Pk Max M1[1] -51.26 dBm 885.4310 MHz D1 -15.150 dBm M1 Start 30.0 MHz 30001 pts Stop 1.0 GHz Date: 3 NOV 2023 08:46:04</p>		
<p>CH00 1GHz~26GHz</p>	 <p>Spectrum Ref Level 20.00 dBm Offset 0.50 dB RBW 100 kHz Att 30 dB SWT 250 ms VBW 300 kHz Mode Auto Sweep Count 10/10 1Pk Max M1[1] -42.82 dBm 16.841667 GHz D1 -15.150 dBm M1 Start 1.0 GHz 30001 pts Stop 26.0 GHz Date: 3 NOV 2023 08:46:20</p>		

CH39
Reference level

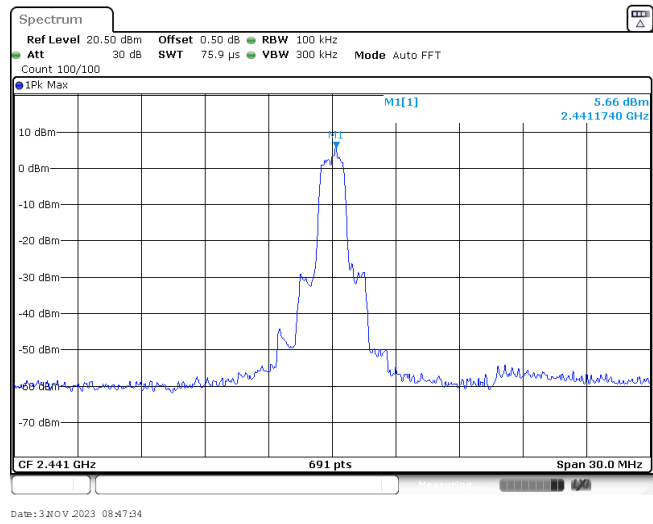

CH39
30MHz~1000MHz

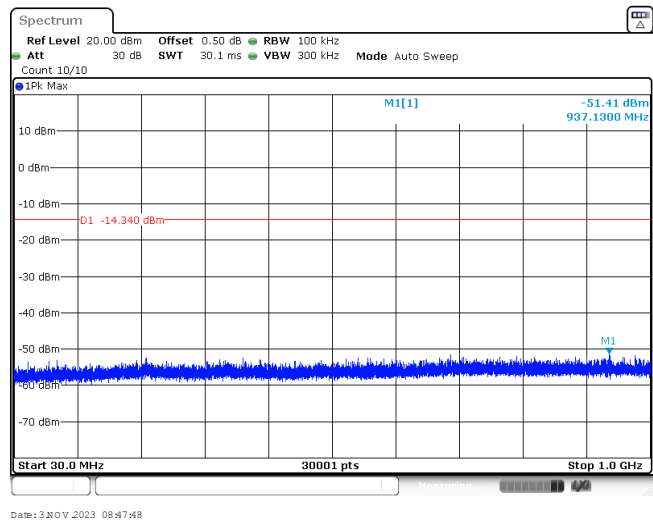

CH39
1GHz~26GHz

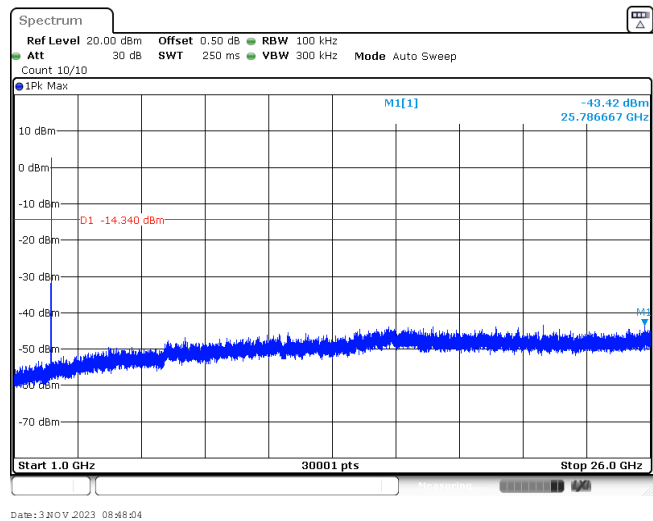

CH78
Reference level

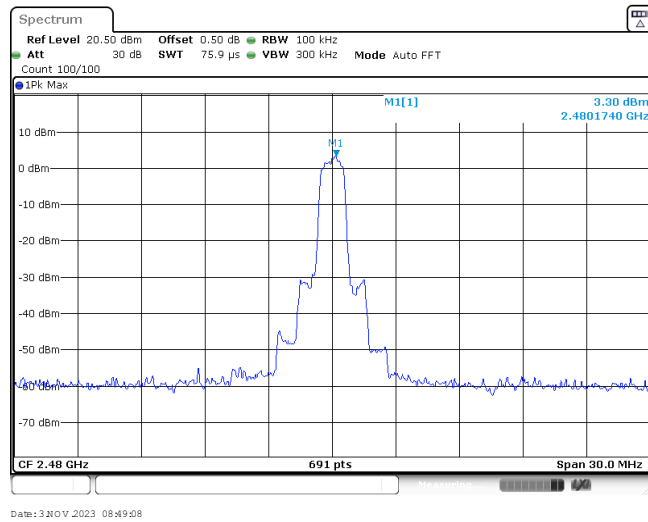

CH78
30MHz~1000MHz

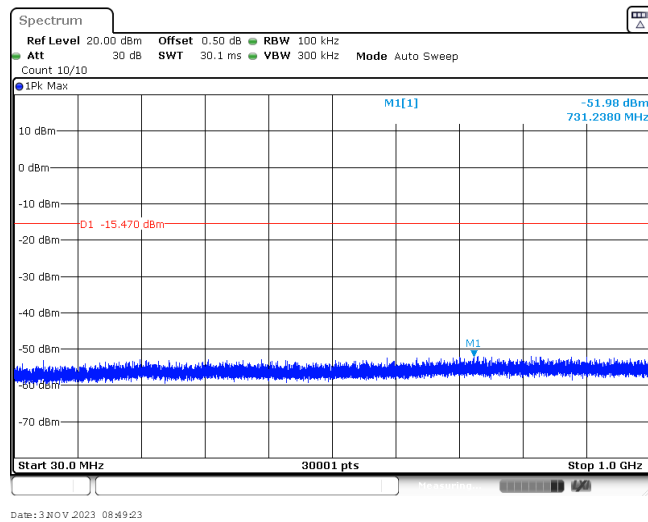

CH78
1GHz~26GHz

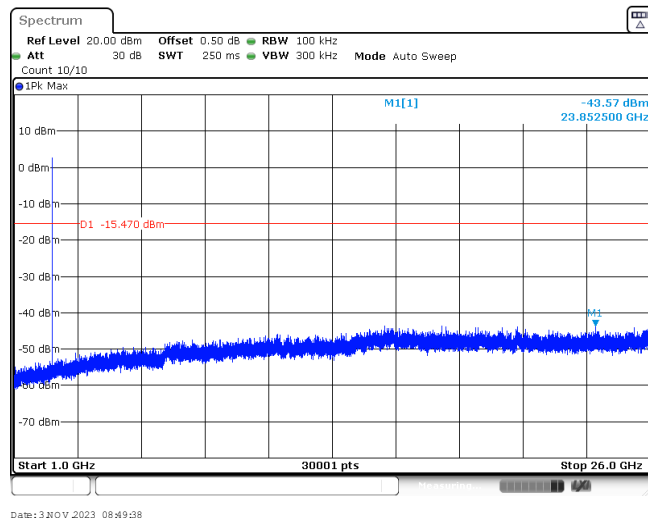

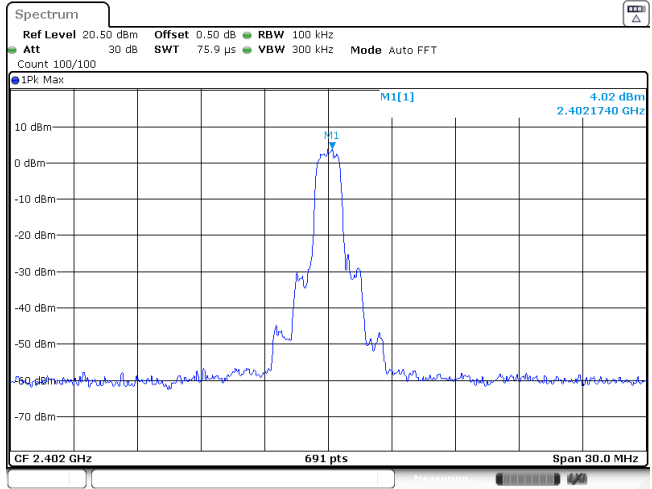
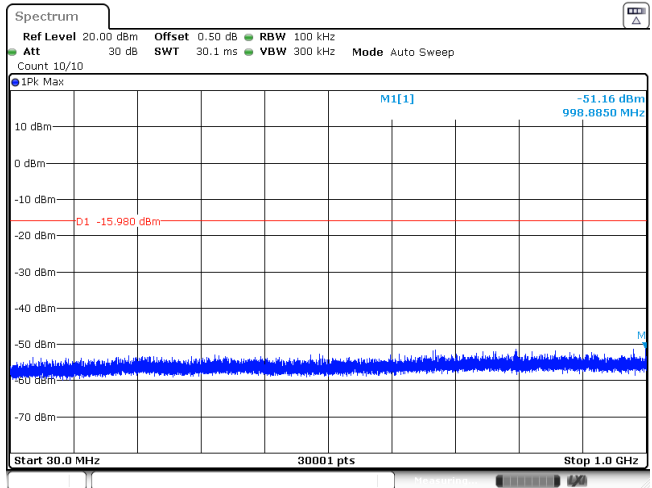
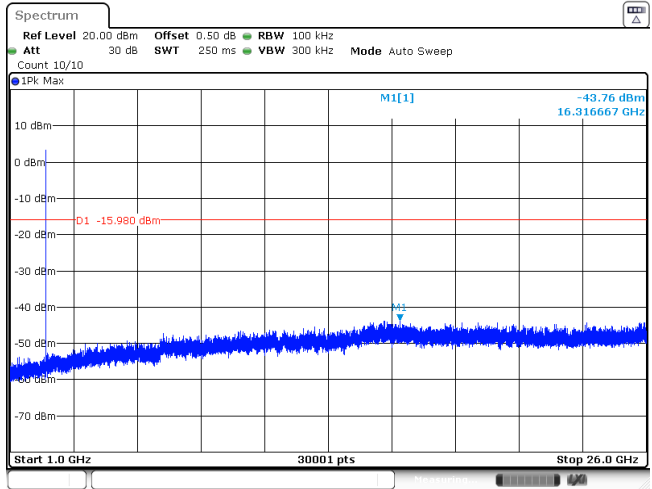
Test Item:	Spurious Emission	Modulation type:	8DPSK
<p>CH00 Reference level</p>	 <p>Ref Level 20.50 dBm Offset 0.50 dB RBW 100 kHz Att 30 dB SWT 75.9 μs VBW 300 kHz Mode Auto FFT Count 100/100 1Pk Max M1[1] 4.02 dBm 2.4021740 GHz CF 2.402 GHz 691 pts Span 30.0 MHz Date: 3 NOV 2023 09:48:42</p>		
<p>CH00 30MHz~1000MHz</p>	 <p>Ref Level 20.00 dBm Offset 0.50 dB RBW 100 kHz Att 30 dB SWT 30.1 ms VBW 300 kHz Mode Auto Sweep Count 10/10 1Pk Max M1[1] -51.16 dBm 998.8850 MHz D1 -15.980 dBm Start 30.0 MHz 30001 pts Stop 1.0 GHz Date: 3 NOV 2023 09:48:57</p>		
<p>CH00 1GHz~26GHz</p>	 <p>Ref Level 20.00 dBm Offset 0.50 dB RBW 100 kHz Att 30 dB SWT 250 ms VBW 300 kHz Mode Auto Sweep Count 10/10 1Pk Max M1[1] -43.76 dBm 16.316667 GHz D1 -15.980 dBm Start 1.0 GHz 30001 pts Stop 26.0 GHz Date: 3 NOV 2023 09:49:13</p>		

CH39
Reference level

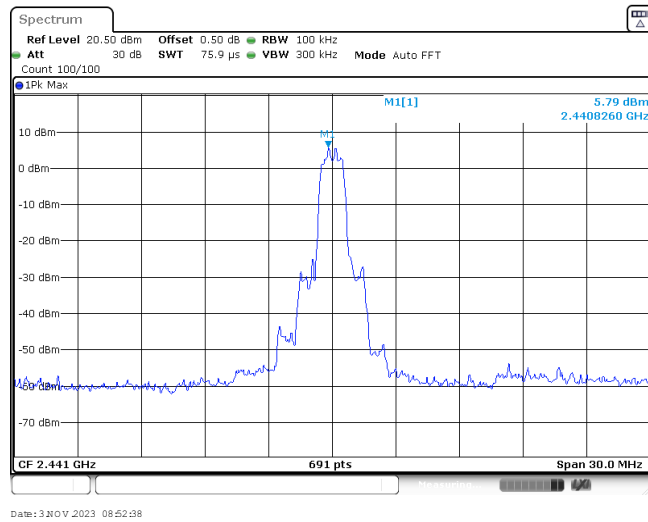

CH39
30MHz~1000MHz

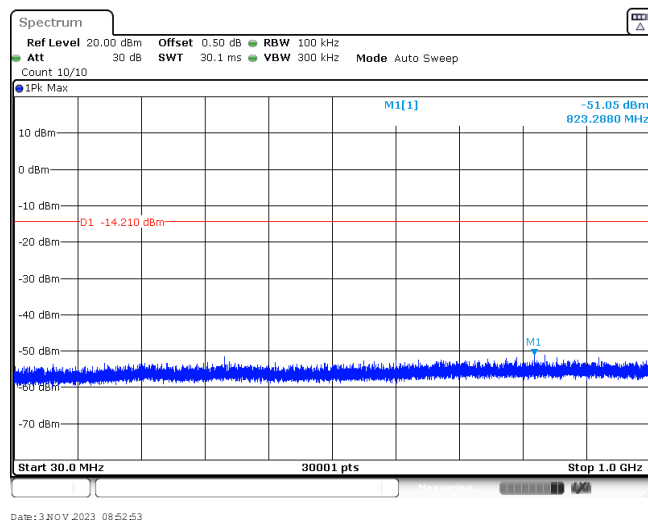

CH39
1GHz~26GHz

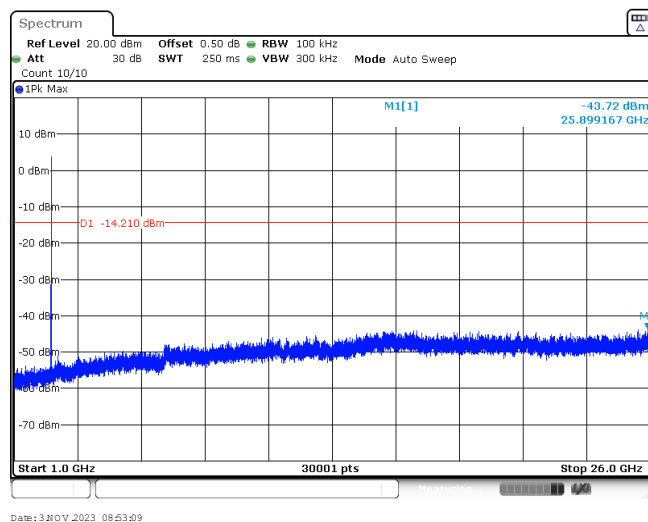

CH78
Reference level

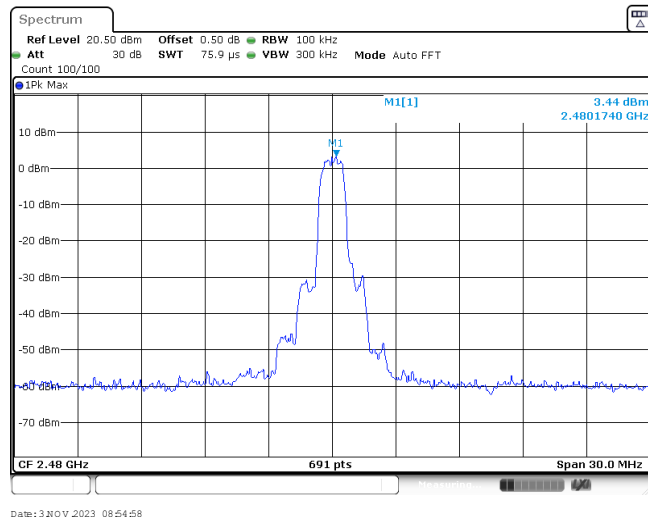

CH78
30MHz~1000MHz

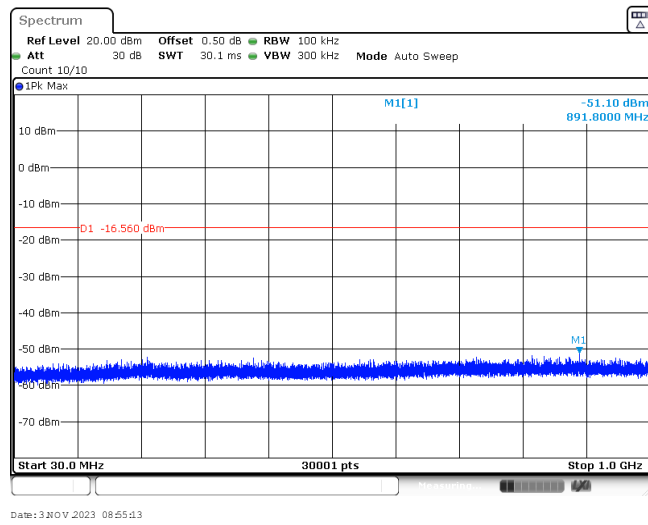

CH78
1GHz~26GHz

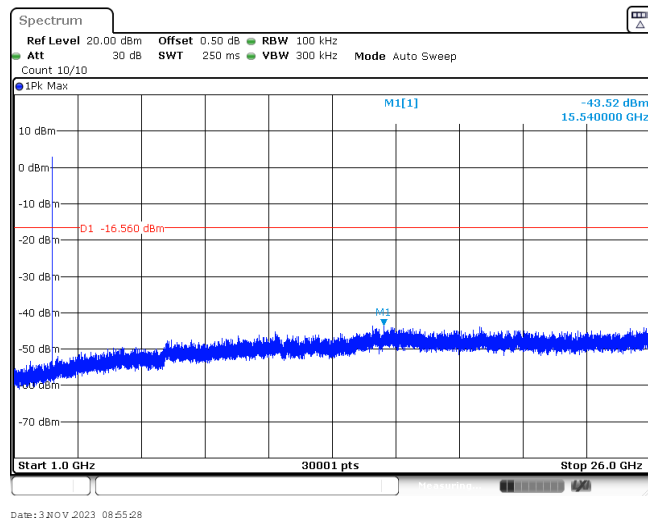

-----End of Report-----