



TEST REPORT

For GSM

Report No. : **CHTEW22080130** Report Verification: 

Project No..... : **SHT2206102301EW**

FCC ID..... : **2ASWW-STAR103G**

Applicant : **XINCHUANGXIN INTERNATIONAL CO.,LTD**

Address..... : **ROOM 605 6/F, FA YUEN COMMERCIAL BUILDING, 75-77 FA YUEN STREET MONGKOK KL**

Product Name : **Tablet**

Trade Mark : **CORN**

Model No. : **Star10 3G**

Listed Model(s) : **-**

Standard : **FCC CFR Title 47 Part 2
FCC CFR Title 47 Part 22
FCC CFR Title 47 Part 24**

Date of receipt of test sample..... : **Jul.11, 2022**

Date of testing..... : **Jul.11, 2022- Aug.01, 2022**

Date of issue..... : **Aug.02, 2022**

Result..... : **Pass**

Compiled by
 (position+printedname+signature).... : File administrators: Fanghui Zhu

Fanghui Zhu

Supervised by
 (position+printedname+signature)..... : Project Engineer Caspar Chen

Caspar Chen

Approved by
 (position+printedname+signature)..... : Manager Hans Hu

Hans Hu

Testing Laboratory Name : **Shenzhen Huatongwei International Inspection Co., Ltd.**

Address..... : **1/F, Bldg 3, Hongfa Hi-tech Industrial Park, Genyu Road, Tianliao, Gongming, Shenzhen, China**

Shenzhen Huatongwei International Inspection Co., Ltd. All rights reserved.

This publication may be reproduced in whole or in part for non-commercial purposes as long as the Shenzhen Huatongwei International Inspection Co., Ltd. is acknowledged as copyright owner and source of the material. Shenzhen Huatongwei International Inspection Co., Ltd. takes no responsibility for and will not assume liability for damages resulting from the reader's interpretation of the reproduced material due to its placement and context.

The test report merely correspond to the test sample.

Contents

| | | |
|-----------|---|-----------|
| 1. | <u>TEST STANDARDS AND REPORT VERSION</u> | 3 |
| 1.1. | Applicable Standards | 3 |
| 1.2. | Report version information | 3 |
| 2. | <u>TEST DESCRIPTION</u> | 4 |
| 3. | <u>SUMMARY</u> | 5 |
| 3.1. | Client Information | 5 |
| 3.2. | Product Description | 5 |
| 3.3. | Radio Specification Description | 5 |
| 3.4. | Testing Laboratory Information | 6 |
| 4. | <u>TEST CONFIGURATION</u> | 7 |
| 4.1. | Test frequency list | 7 |
| 4.2. | Descriptions of Test mode | 7 |
| 4.3. | Test sample information | 7 |
| 4.4. | Support unit used in test configuration and system | 7 |
| 4.5. | Testing environmental condition | 8 |
| 4.6. | Statement of the measurement uncertainty | 8 |
| 4.7. | Equipments Used during the Test | 9 |
| 5. | <u>TEST CONDITIONS AND RESULTS</u> | 10 |
| 5.1. | Conducted Output Power | 10 |
| 5.2. | Peak-to-Average Ratio | 11 |
| 5.3. | 99% Occupied Bandwidth & 26 dB Bandwidth | 12 |
| 5.4. | Band Edge | 13 |
| 5.5. | Conducted Spurious Emissions | 14 |
| 5.6. | Frequency stability VS Temperature measurement | 15 |
| 5.7. | Frequency stability VS Voltage measurement | 16 |
| 5.8. | ERP and EIRP | 17 |
| 5.9. | Radiated Spurious Emission | 18 |
| 6. | <u>TEST SETUP PHOTOS OF THE EUT</u> | 26 |
| 7. | <u>EXTERNAL AND INTERNAL PHOTOS OF THE EUT</u> | 27 |
| 7.1. | External photos | 27 |
| 7.2. | Internal photos | 30 |
| 8. | <u>APPENDIX REPORT</u> | 32 |

1. TEST STANDARDS AND REPORT VERSION

1.1. Applicable Standards

The tests were performed according to following standards:

[FCC Rules Part 2](#): FREQUENCY ALLOCATIONS AND RADIO TREATY MATTERS; GENERAL RULES AND REGULATIONS

[FCC Rules Part 22](#): PUBLIC MOBILE SERVICES

[FCC Rules Part 24](#): PERSONAL COMMUNICATIONS SERVICES

[TIA/EIA 603 E March 2016](#): Land Mobile FM or PM Communications Equipment Measurement and Performance Standards.

[ANSI C63.26-2015](#): American National Standard for Compliance Testing of Transmitters Used in Licensed Radio Services

[KDB 971168 D01 Power Meas License Digital Systems v03](#): MEASUREMENT GUIDANCE FOR CERTIFICATION OF LICENSED DIGITAL TRANSMITTERS

1.2. Report version information

| Revision No. | Date of issue | Description |
|--------------|---------------|-------------|
| N/A | 2022-08-02 | Original |
| | | |
| | | |
| | | |
| | | |

2. TEST DESCRIPTION

| Section | Test Item | Section in CFR 47 | Result #1 | Test Engineer |
|---------|--|--|-----------|-----------------|
| 5.1 | Conducted Output Power | Part 2.1046 Part 22.913(a) Part 24.232(c) | Pass | Tiancheng Huang |
| 5.2 | Peak-to-Average Ratio | Part 24.232 | Pass | Tiancheng Huang |
| 5.3 | 99% Occupied Bandwidth & 26 dB Bandwidth | Part 2.1049 Part 22.917(b) Part 24.238(b) | Pass | Tiancheng Huang |
| 5.4 | Band Edge | Part 2.1051 Part 22.917 Part 24.238 | Pass | Tiancheng Huang |
| 5.5 | Conducted Spurious Emissions | Part 2.1051 Part 22.917 Part 24.238 | Pass | Tiancheng Huang |
| 5.6 | Frequency stability vs temperature | Part 2.1055(a)(1)(b) Part 22.355 Part 24.235 | Pass | Tiancheng Huang |
| 5.7 | Frequency stability vs voltage | Part 2.1055(d)(1)(2) Part 22.355 Part 24.235 | Pass | Tiancheng Huang |
| 5.8 | ERP and EIRP | Part 22.913(a) Part 24.232(b) | Pass | Tiancheng Huang |
| 5.9 | Radiated Spurious Emissions | Part 2.1053 Part 22.917 Part 24.238 | Pass | Yifan Wang |

Note:

#1: The test result does not include measurement uncertainty value

3. SUMMARY

3.1. Client Information

| | |
|---------------|--|
| Applicant: | XINCHUANGXIN INTERNATIONAL CO.,LTD |
| Address: | ROOM 605 6/F, FA YUEN COMMERCIAL BUILDING, 75-77 FA YUEN STREET MONGKOK KL |
| Manufacturer: | Shenzhen Chiteng Technology Co.,LTD |
| Address: | Second Floor,Area A, Building 4, Huiye Technology Workshop, Guangang Road, Tangjia Community, Gongming Street, Guangming New District, Shenzhen, Guangdong |

3.2. Product Description

| Main unit information: | |
|------------------------|-----------------------------|
| Product Name: | Tablet |
| Trade Mark: | CORN |
| Model No.: | Star10 3G |
| Listed Model(s): | - |
| Power supply: | DC 3.7V from Battery |
| Hardware version: | P30-7731E- V1.0 |
| Software version: | CORN_Star10_3G_V01_20220708 |

3.3. Radio Specification Description

| | |
|----------------------------|---|
| Support Operating Band: | <input checked="" type="checkbox"/> GSM850 <input checked="" type="checkbox"/> PCS1900 |
| Operating Frequency Range: | Please refer to note #2 |
| Support Network: | <input checked="" type="checkbox"/> GSM <input checked="" type="checkbox"/> GPRS |
| Modulation type: | <input checked="" type="checkbox"/> GMSK |
| GPRS Multislot Class: | <input type="checkbox"/> 8 <input type="checkbox"/> 10 <input checked="" type="checkbox"/> 12 <input type="checkbox"/> 33 |
| Antenna type: | Interna |
| Antenna gain #3: | GSM850:-0.3dbi PCS1900:0.6dbi |

Note:

- : means that this feature is supported; : means that this feature is not supported
- #2: Operating frequency range is as follow:

| Band | Uplink frequency | Downlink frequency |
|---------|---------------------|---------------------|
| GSM850 | 824.20 - 848.80MHz | 869.20 - 893.80MHz |
| PCS1900 | 1850.20 -1909.80MHz | 1930.20 -1989.80MHz |

- #3: The antenna gain is provided by the applicant, and the applicant should be responsible for its authenticity, HTW lab has not verified the authenticity of its information

3.4. Testing Laboratory Information

| Laboratory Name | Shenzhen Huatongwei International Inspection Co., Ltd. | |
|----------------------|---|----------------------|
| Laboratory Location | 1/F, Bldg 3, Hongfa Hi-tech Industrial Park, Genyu Road, Tianliao, Gongming, Shenzhen, China | |
| Connect information: | Tel: 86-755-26715499 E-mail: cs@szhtw.com.cn http://www.szhtw.com.cn | |
| Qualifications | Type | Accreditation Number |
| | FCC | 762235 |

4. TEST CONFIGURATION

4.1. Test frequency list

| GSM850 | | PCS1900 | |
|---------|-----------------|---------|-----------------|
| Channel | Frequency (MHz) | Channel | Frequency (MHz) |
| 128 | 824.20 | 512 | 1850.20 |
| 190 | 836.60 | 661 | 1880.00 |
| 251 | 848.80 | 810 | 1909.80 |

4.2. Descriptions of Test mode

- 1) Antenna port conducted and radiated test items were performed according to KDB 971168 D01 Power Meas. License Digital Systems and ANSI C63.26 with maximum output power.
- 2) Radiated measurements were performed with rotating EUT in different three orthogonal test planes to find the maximum emission.

All modes and data rates and positions were investigated, test modes are chosen to be reported as the worst case configuration below:

| Band | Radiated test items | Conducted test items |
|----------|--|---|
| GSM 850 | <ul style="list-style-type: none"> ■ GSM link | <ul style="list-style-type: none"> ■ GSM link ■ GPRS Class 8 link |
| PCS 1900 | <ul style="list-style-type: none"> ■ GSM link | <ul style="list-style-type: none"> ■ GSM link ■ GPRS Class 8 link |

4.3. Test sample information

| Test item | HTW sample no. |
|----------------------|--|
| Conducted test items | Please refer to the description in the appendix report |
| Radiated test items | YPHT22061023001 |

Note:

Conducted test items: Conducted Output Power, Peak-Average Ratio, 99% Occupied Bandwidth & 26 dB Bandwidth, Band Edge, Conducted Spurious Emissions, Frequency stability, ERP and EIRP

Radiated test items: Radiated Spurious Emission

4.4. Support unit used in test configuration and system

The EUT has been associated with peripherals and configuration operated in a manner tended to maximize its emission characteristics in a typical application.

The following peripheral devices and interface cables were connected during the measurement:

| Whether support unit is used? | | | | |
|-------------------------------|-----------|------------|-----------|-------|
| ✓ No | | | | |
| Item | Equipment | Trade Name | Model No. | Other |
| 1 | | | | |
| 2 | | | | |

4.5. Testing environmental condition

| | | |
|--------------|-----------------------|----------------------|
| Voltage | VN=Nominal Voltage | DC 3.7V |
| | VL=Lower Voltage | DC 3.6V |
| | VH=Higher Voltage | DC 4.2V |
| Temperature | TN=Normal Temperature | 25 °C |
| | Extreme Temperature | From -30°C to + 50°C |
| Humidity | 30~60 % | |
| Air Pressure | 950-1050 hPa | |

4.6. Statement of the measurement uncertainty

| Test Items | Measurement Uncertainty |
|--|-----------------------------------|
| Radio frequency | <1GHz: 0.022ppm >1GHz: 0.64ppm |
| Conducted output power | 0.65 dB |
| ERP and EIRP | 0.65 dB |
| Conducted spurious emission | 0.65 dB |
| Radiated spurious emission | <1GHz: 2.85dB >1GHz: 3.66dB |
| 99% Occupied Bandwidth & 26 dB Bandwidth | <1GHz: 0.022ppm >1GHz: 0.64ppm |

This uncertainty represents an expanded uncertainty expressed at approximately the 95% confidence level using a coverage factor of k=1.96.

4.7. Equipments Used during the Test

| ● Conducted test item | | | | | | | |
|-----------------------|------------------------------|--------------|---------------|-----------|------------|---------------------------|---------------------------|
| Used | Test Equipment | Manufacturer | Equipment No. | Model No. | Serial No. | Last Cal. Date (YY-MM-DD) | Next Cal. Date (YY-MM-DD) |
| ○ | Signal and spectrum Analyzer | R&S | HTWE0242 | FSV40 | 100048 | 2021/09/13 | 2022/09/12 |
| ○ | Signal & Spectrum Analyzer | R&S | HTWE0262 | FSW26 | 103440 | 2021/09/13 | 2022/09/12 |
| ● | Spectrum Analyzer | Agilent | HTWE0286 | N9020A | MY50510187 | 2021/09/13 | 2022/09/12 |
| ● | Radio communication tester | R&S | HTWE0287 | CMW500 | 137688-Lv | 2021/09/13 | 2022/09/12 |
| ● | Test software | Tonscend | N/A | JS1120 | N/A | N/A | N/A |

| ● Radiated Spurious Emission | | | | | | | |
|------------------------------|-------------------------|--------------------|---------------|-------------------|-------------|---------------------------|---------------------------|
| Used | Test Equipment | Manufacturer | Equipment No. | Model No. | Serial No. | Last Cal. Date (YY-MM-DD) | Next Cal. Date (YY-MM-DD) |
| ● | Semi-Anechoic Chamber | Albatross projects | HTWE0122 | SAC-3m-01 | N/A | 2018/09/27 | 2022/09/26 |
| ● | Spectrum Analyzer | R&S | HTWE0098 | FSP40 | 100597 | 2021/09/13 | 2022/09/12 |
| ● | Loop Antenna | R&S | HTWE0170 | HFH2-Z2 | 100020 | 2021/04/06 | 2024/04/05 |
| ● | Broadband Horn Antenna | SCHWARZBECK | HTWE0103 | BBHA9170 | BBHA9170472 | 2020/04/27 | 2023/04/26 |
| ● | Ultra-Broadband Antenna | SCHWARZBECK | HTWE0123 | VULB9163 | 538 | 2021/04/06 | 2024/04/05 |
| ● | Horn Antenna | SCHWARZBECK | HTWE0126 | 9120D | 1011 | 2020/04/01 | 2023/03/31 |
| ● | Pre-amplifier | CD | HTWE0071 | PAP-0102 | 12004 | 2021/11/05 | 2022/11/04 |
| ● | Broadband Preamplifier | SCHWARZBECK | HTWE0201 | BBV 9718 | 9718-248 | 2022/02/28 | 2023/02/27 |
| ● | RF Connection Cable | HUBER+SUHNER | HTWE0120-01 | 6m 18GHz S Serisa | N/A | 2022/02/25 | 2023/02/24 |
| ● | RF Connection Cable | HUBER+SUHNER | HTWE0120-02 | 6m 3GHz RG Serisa | N/A | 2022/02/25 | 2023/02/24 |
| ● | RF Connection Cable | HUBER+SUHNER | HTWE0120-03 | 6m 3GHz RG Serisa | N/A | 2022/02/25 | 2023/02/24 |
| ● | RF Connection Cable | HUBER+SUHNER | HTWE0120-04 | 6m 3GHz RG Serisa | N/A | 2022/02/25 | 2023/02/24 |
| ● | RF Connection Cable | HUBER+SUHNER | HTWE0121-01 | 6m 18GHz S Serisa | N/A | 2018/09/27 | 2022/09/26 |
| ● | EMI Test Software | Audix | N/A | E3 | N/A | N/A | N/A |

| ● Auxiliary Equipment | | | | | | | |
|-----------------------|-----------------|--------------|---------------|-----------|------------|---------------------------|---------------------------|
| Used | Test Equipment | Manufacturer | Equipment No. | Model No. | Serial No. | Last Cal. Date (YY-MM-DD) | Next Cal. Date (YY-MM-DD) |
| ● | Climate chamber | ESPEC | HTWE0254 | GPL-2 | N/A | 2021/09/14 | 2022/09/13 |
| ● | DC Power Supply | Gwinstek | HTWE0274 | SPS-2415 | GER835793 | N/A | N/A |

5. TEST CONDITIONS AND RESULTS

5.1. Conducted Output Power

LIMIT

N/A

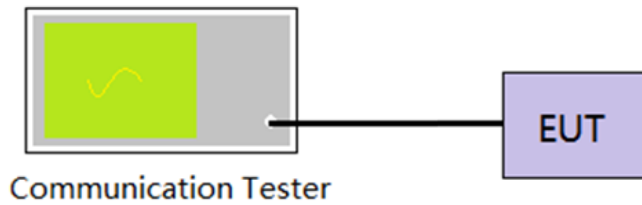
TEST CONFIGURATION**TEST PROCEDURE**

1. The EUT output port was connected to communication tester.
2. Set EUT at maximum power through communication tester.
3. Select lowest, middle, and highest channels for each band and different modulation.
4. Measure the maximum burst average power.

TEST MODE:

Please refer to the clause 4.2

TEST RESULTS **Passed** **Not Applicable**

Refer to appendix A on the section 8 appendix report

5.2. Peak-to-Average Ratio

LIMIT

13dB

TEST CONFIGURATION

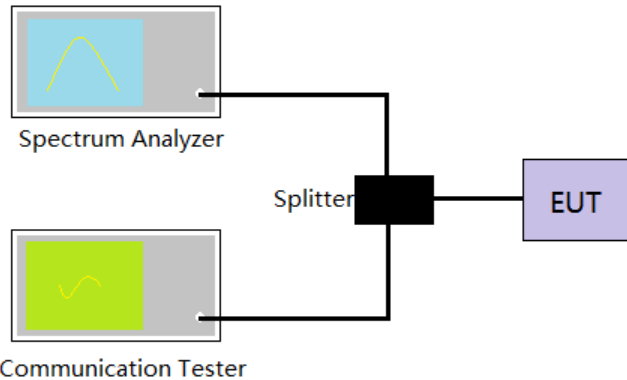

TEST PROCEDURE

1. The EUT was connected to the spectrum analyzer and communication tester via a power splitter
2. Set EUT in maximum power output.
3. Center Frequency = Carrier frequency, RBW > Emission bandwidth of signal
4. The signal analyzer was set to collect one million samples to generate the CCDF curve
5. The measurement interval was set depending on the type of signal analyzed.
 - i. For continuous signals (>98% duty cycle), the measurement interval was set to 1ms.
 - ii. For burst transmissions, the spectrum analyzer is set to use an internal "RF Burst" trigger that is synced with an incoming pulse and the measurement interval is set to less than the duration of the "on time" of one burst to ensure that energy is only captured during a time in which the transmitter is operating at maximum power
6. Record the maximum PAPR level associated with a probability of 0.1%.

TEST MODE:

Please refer to the clause 4.2

TEST RESULTS

Passed Not Applicable

Refer to appendix B on the section 8 appendix report

5.3. 99% Occupied Bandwidth & 26 dB Bandwidth

LIMIT

N/A

TEST CONFIGURATION



TEST PROCEDURE

1. The EUT was connected to the spectrum analyzer and communication tester via a power splitter
2. Set EUT in maximum power output.
3. Spectrum analyzer setting as follow:
Center Frequency= Carrier frequency, RBW=1% to 5% of anticipated OBW, VBW= 3 * RBW, Detector=Peak, Trace maximum hold.
4. Record the value of 99% Occupied bandwidth and -26dB bandwidth.

TEST MODE:

Please refer to the clause 4.2

TEST RESULTS

Passed Not Applicable

Refer to appendix C on the section 8 appendix report

5.4. Band Edge

LIMIT

Part 24.238 and Part 22.917 specify that the power of any emission outside of the authorized operating frequency ranges must be attenuated below the transmitting power (P) by a factor of at least $43 + 10 \log(P)$ dB.

The specification that emissions shall be attenuated below the transmitter power (P) by at least $43 + 10 \log(P)$ dB, translates in the relevant power range (1 to 0.001 W) to -13 dBm. At 1 W the specified minimum attenuation becomes 43 dB and relative to a 30 dBm (1 W) carrier becomes a limit of -13 dBm. At 0.001 W (0 dBm) the minimum attenuation is 13 dB, which again yields a limit of -13 dBm. In this way a translation of the specification from relative to absolute terms is carried out.

TEST CONFIGURATION

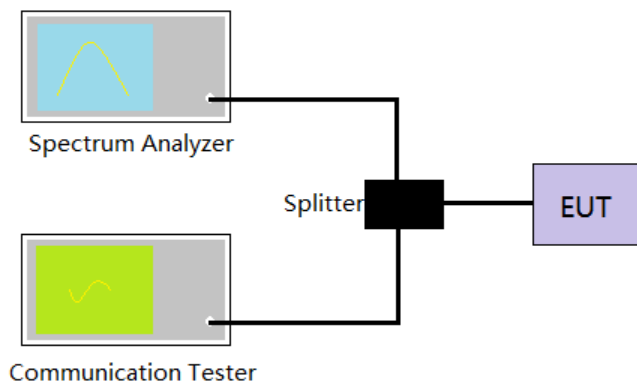

TEST PROCEDURE

1. The EUT was connected to the spectrum analyzer and communication tester via a power splitter
2. Set EUT in maximum power output.
3. The band edges of low and high channels were measured.
4. Spectrum analyzer setting as follow:
RBW=3KHz, VBW = 10KHz, Sweep time= Auto
5. Record the test plot.

TEST MODE:

Please refer to the clause 4.2

TEST RESULTS

Passed Not Applicable

Refer to appendix D on the section 8 appendix report

5.5. Conducted Spurious Emissions

LIMIT

Part 24.238 and Part 22.917 specify that the power of any emission outside of the authorized operating frequency ranges must be attenuated below the transmitting power (P) by a factor of at least $43 + 10 \log(P)$ dB.

The specification that emissions shall be attenuated below the transmitter power (P) by at least $43 + 10 \log(P)$ dB, translates in the relevant power range (1 to 0.001 W) to -13 dBm. At 1 W the specified minimum attenuation becomes 43 dB and relative to a 30 dBm (1 W) carrier becomes a limit of -13 dBm. At 0.001 W (0 dBm) the minimum attenuation is 13 dB, which again yields a limit of -13 dBm. In this way a translation of the specification from relative to absolute terms is carried out.

TEST CONFIGURATION

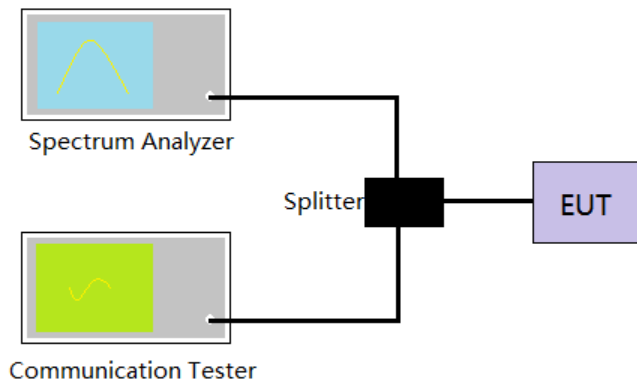

TEST PROCEDURE

1. The EUT was connected to the spectrum analyzer and communication tester via a power splitter
2. Set EUT in maximum power output.
3. Spectrum analyzer setting as follow:
Below 1GHz, RBW=100KHz, VBW = 300KHz, Detector=Peak, Sweep time= Auto
Above 1GHz, RBW=1MHz, VBW=3MHz, Detector=Peak, Sweep time= Auto
Scan frequency range up to 10th harmonic.
4. Record the test plot.

TEST MODE:

Please refer to the clause 4.2

TEST RESULTS

Passed Not Applicable

Refer to appendix E on the section 8 appendix report

5.6. Frequency stability VS Temperature measurement

LIMIT

2.5ppm

TEST CONFIGURATION

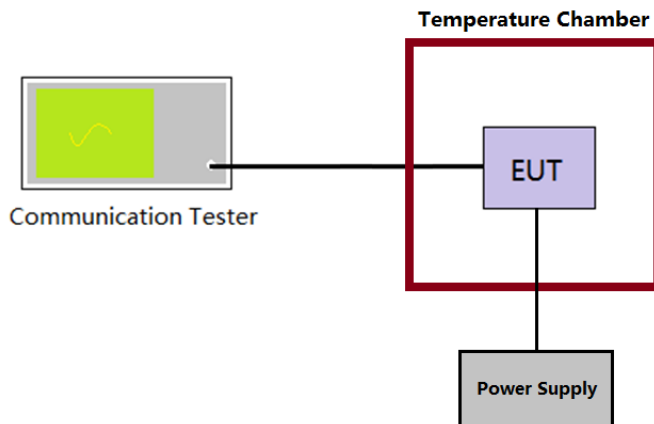

TEST PROCEDURE

1. The equipment under test was connected to an external DC power supply and input rated voltage.
2. The EUT output port was connected to communication tester.
3. The EUT was placed inside the temperature chamber.
4. Turn EUT off and set the chamber temperature to -30°C . After the temperature stabilized for approximately 30 minutes recorded the frequency.
5. Repeat step 4 measure with 10°C increased per stage until the highest temperature of $+50^{\circ}\text{C}$ reached.

TEST MODE:

Please refer to the clause 4.2

TEST RESULTS

Passed Not Applicable

Refer to appendix F on the section 8 appendix report

5.7. Frequency stability VS Voltage measurement

LIMIT

2.5ppm

TEST CONFIGURATION

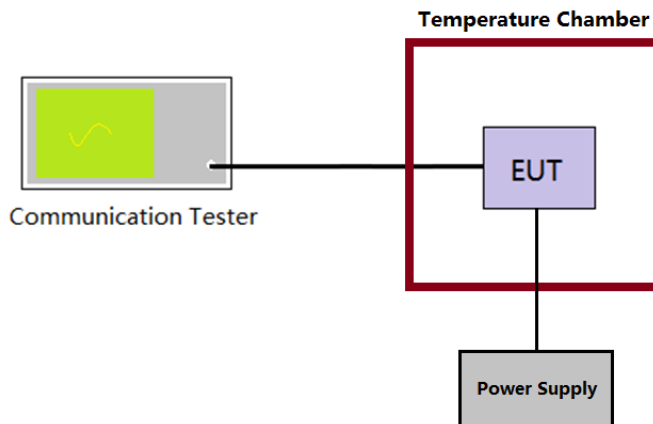

TEST PROCEDURE

1. The equipment under test was connected to an external DC power supply and input rated voltage.
2. The EUT output port was connected to communication tester.
3. The EUT was placed inside the temperature chamber at 25°C
4. The power supply voltage to the EUT was varied $\pm 15\%$ of the nominal value measured at the input to the EUT
5. Record the maximum frequency change.

TEST MODE:

Please refer to the clause 4.2

TEST RESULTS

Passed Not Applicable

Refer to appendix F on the section 8 appendix report

5.8. ERP and EIRP

LIMIT

GSM850: 7W (38.45dBm) ERP

PCS1900: 2W (33dBm) EIRP

TEST PROCEDURE

1. According to the power tested in section 5.1, select the maximum power in each mode, and use the following formula to calculate the corresponding ERP/EIRP.
2. $ERP = \text{conducted power} + \text{Gain(dBd)}$
3. $EIRP = \text{conducted power} + \text{Gain(dBi)}$
 $ERP = EIRP - 2.15$

TEST RESULTS

Passed **Not Applicable**

Refer to appendix G on the section 8 appendix report

5.9. Radiated Spurious Emission

LIMIT

-13dBm

TEST CONFIGURATION

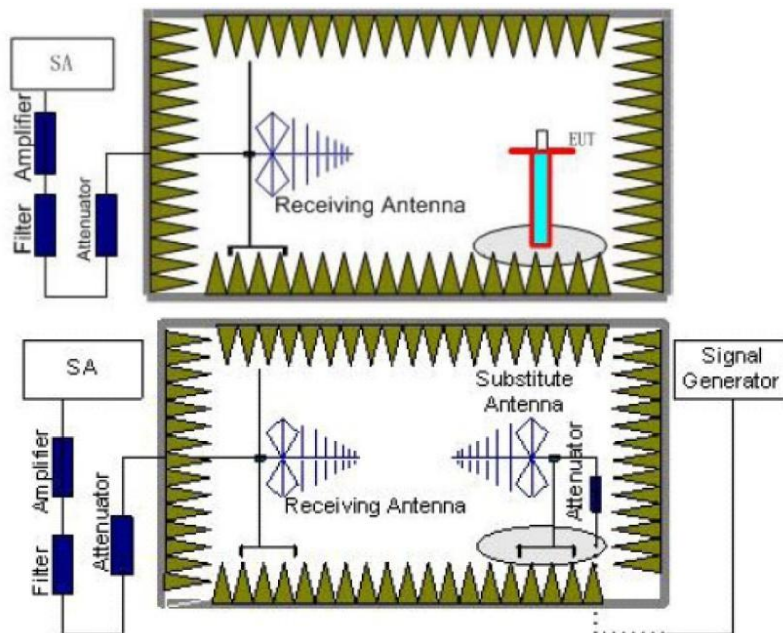

TEST PROCEDURE

1. Place the EUT in the center of the turntable.
 - a) For radiated emissions measurements performed at frequencies less than or equal to 1 GHz, the EUT shall be placed on a RF-transparent table at a nominal height of 80 cm above the reference ground plane
 - b) For radiated measurements performed at frequencies above 1 GHz, the EUT shall be placed on an RF transparent table at a nominal height of 1.5 m above the ground plane.
2. Unless the EUT uses an integral antenna, the EUT shall be terminated with a non-radiating transmitter load. In cases where the EUT uses an adjustable antenna, the antenna shall be adjusted through typical positions and lengths to maximize emissions levels.
3. The EUT shall be tested while operating on the frequency per manufacturer specification. Set the transmitter to operate in continuous transmit mode.
4. Receiver or Spectrum set as follow:
 Below 1GHz, RBW=100kHz, VBW=300kHz, Detector=Peak, Sweep time=Auto
 Above 1GHz, RBW=1MHz, VBW=3MHz, Detector=Peck, Sweep time=Auto
5. Each emission under consideration shall be evaluated:
 - a) Raise and lower the measurement antenna from 1 m to 4 m, as necessary to enable detection of the maximum emission amplitude relative to measurement antenna height.
 - b) Rotate the EUT through 360° to determine the maximum emission level relative to the axial position.
 - c) Return the turntable to the azimuth where the highest emission amplitude level was observed.
 - d) Vary the measurement antenna height again through 1 m to 4 m again to find the height associated with the maximum emission amplitude.
 - e) Record the measured emission amplitude level and frequency
6. Repeat step 5 for each emission frequency with the measurement antenna oriented in both the horizontal and vertical polarizations to determine the orientation that gives the maximum emissions amplitude.
7. Set-up the substitution measurement with the reference point of the substitution antenna located as near as possible to where the center of the EUT radiating element was located during the initial EUT measurement.
8. Maintain the previous measurement instrument settings and test set-up, with the exception that the EUT is removed and replaced by the substitution antenna.
9. Connect a signal generator to the substitution antenna; locate the signal generator so as to minimize any potential influences on the measurement results. Set the signal generator to the frequency where emissions are detected, and set an output power level such that the radiated signal can be detected by the measurement instrument, with sufficient dynamic range relative to the noise floor.

10. For each emission that was detected and measured in the initial test
 - a) Vary the measurement antenna height between 1 m to 4 m to maximize the received (measured) signal amplitude.
 - b) Adjust the signal generator output power level until the amplitude detected by the measurement instrument equals the amplitude level of the emission previously measured directly in step 5 and step 6.
 - c) Record the output power level of the signal generator when equivalence is achieved in step b).
11. Repeat step 8 through step 10 with the measurement antenna oriented in the opposite polarization.
12. Calculate the emission power in dBm referenced to a half-wave dipole using the following equation:
$$P_e = P_s(\text{dBm}) - \text{cable loss (dB)} + \text{antenna gain (dBd)}$$
where
 P_e = equivalent emission power in dBm
 P_s = source (signal generator) power in dBm
NOTE—dBd refers to the measured antenna gain in decibels relative to a half-wave dipole.
13. Correct the antenna gain of the substitution antenna if necessary to reference the emission power to a half-wave dipole. When using measurement antennas with the gain specified in dBi, the equivalent dipole-referenced gain can be determined from:
$$\text{gain (dBd)} = \text{gain (dBi)} - 2.15 \text{ dB.}$$
If necessary, the antenna gain can be calculated from calibrated antenna factor information
14. Provide the complete measurement results as a part of the test report.

TEST MODE:

Please refer to the clause 4.2

TEST RESULTS

Passed **Not Applicable**

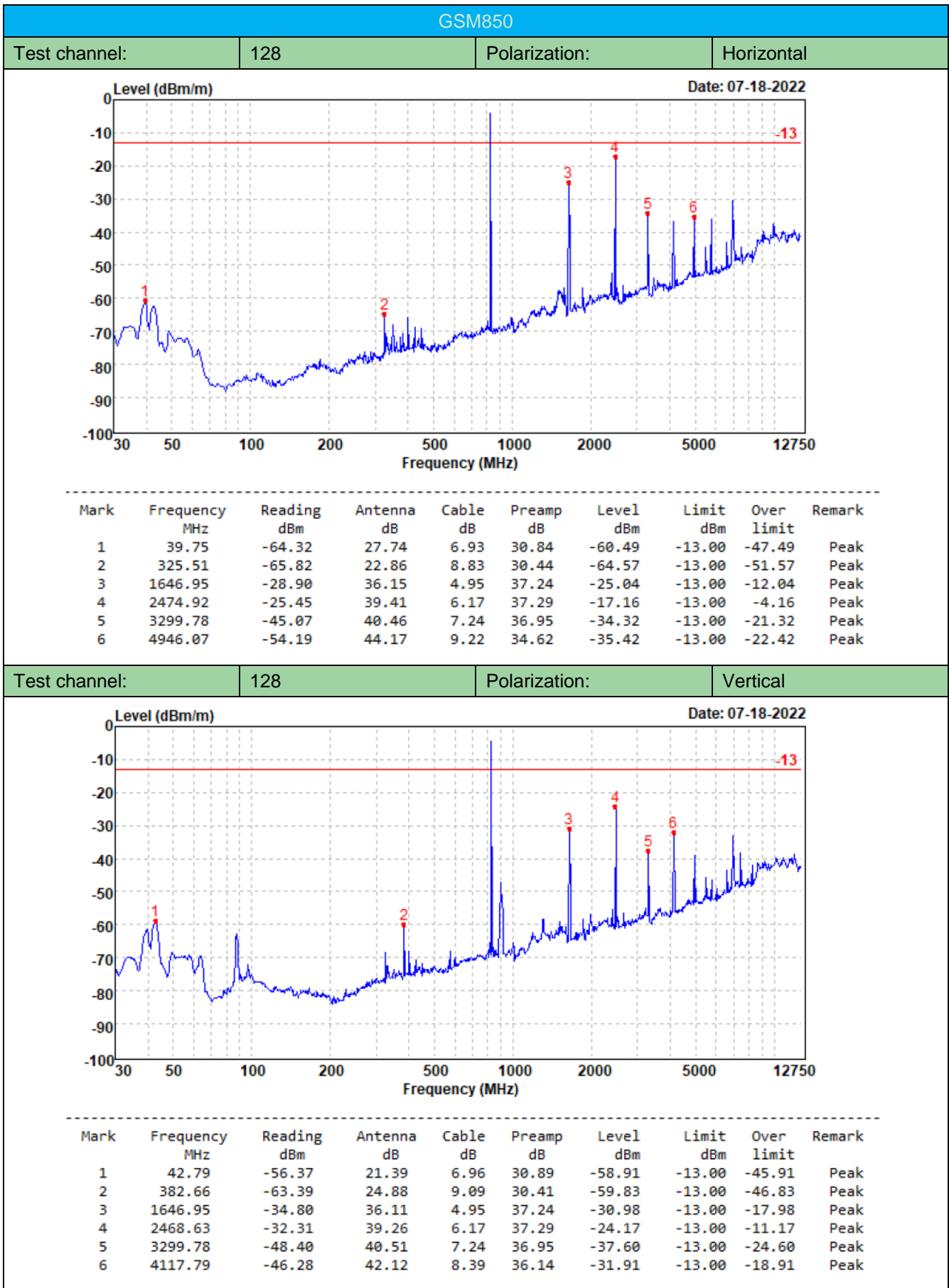

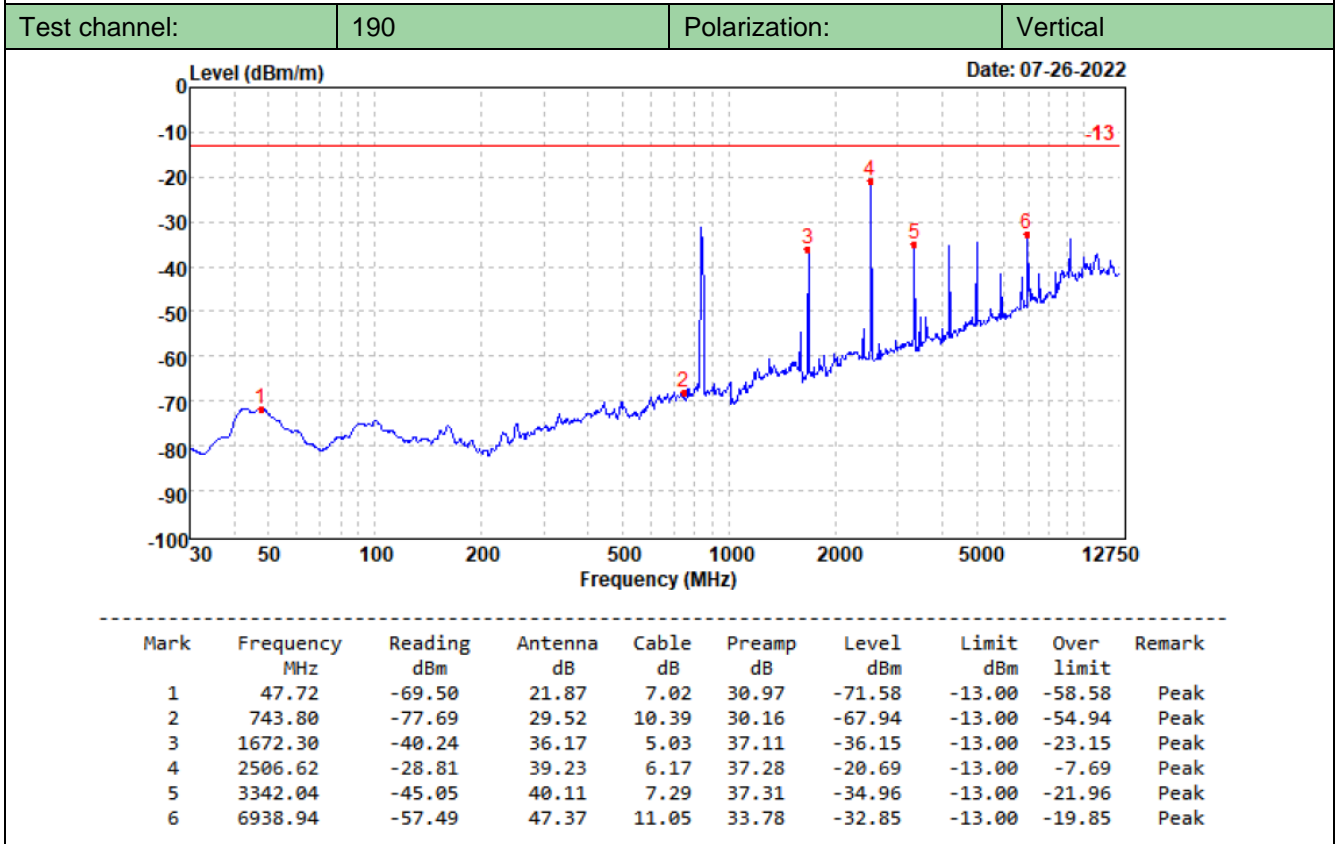
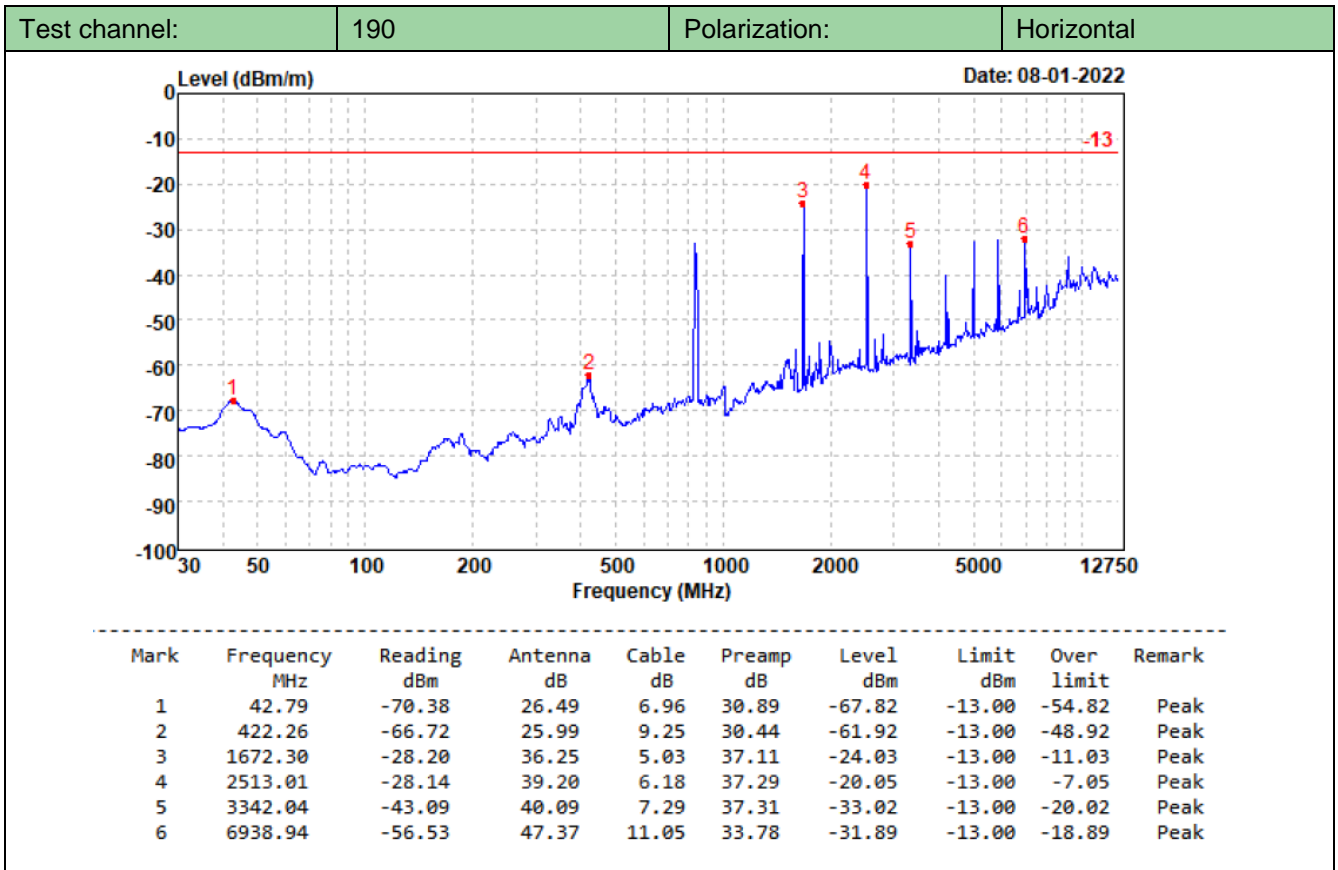

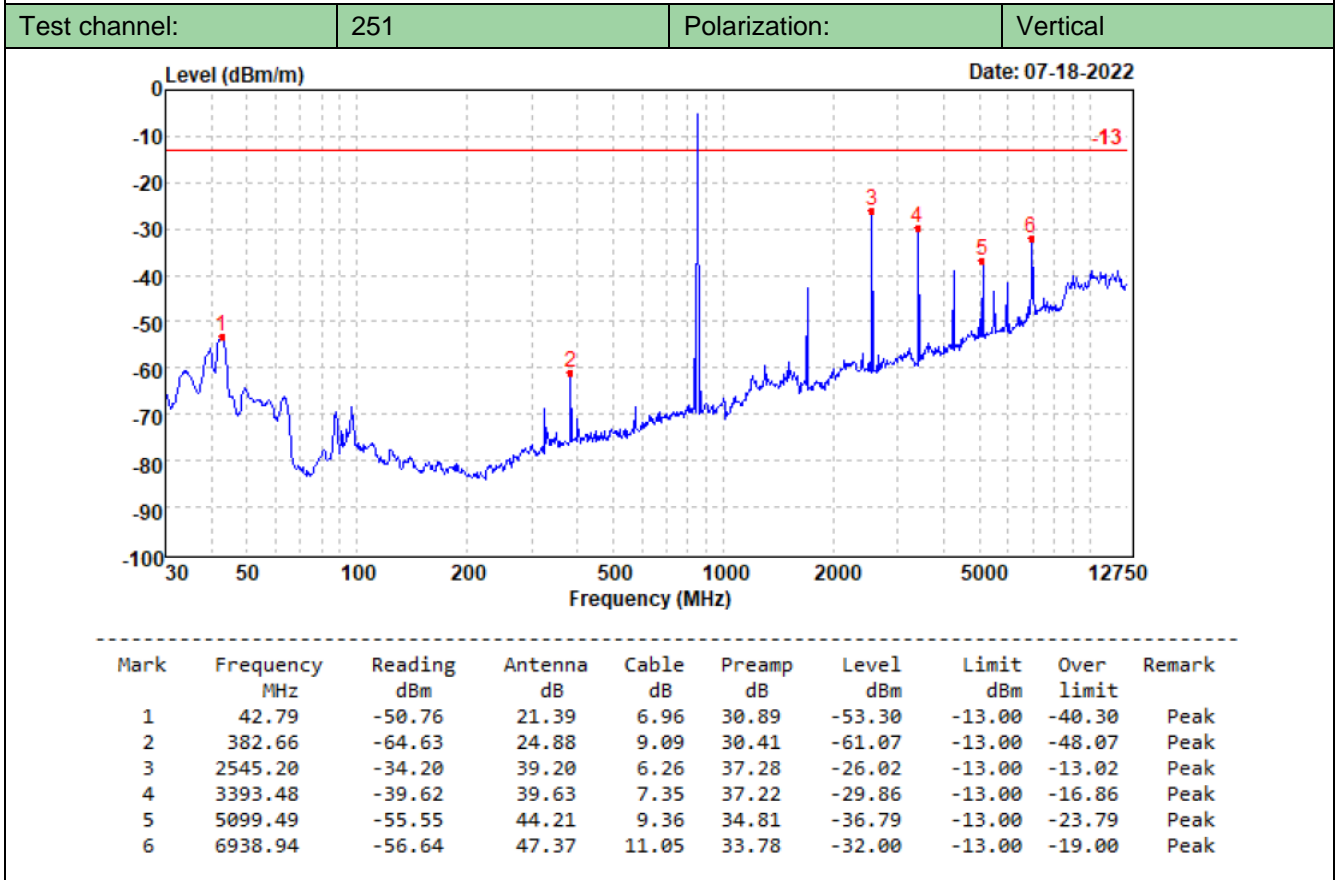
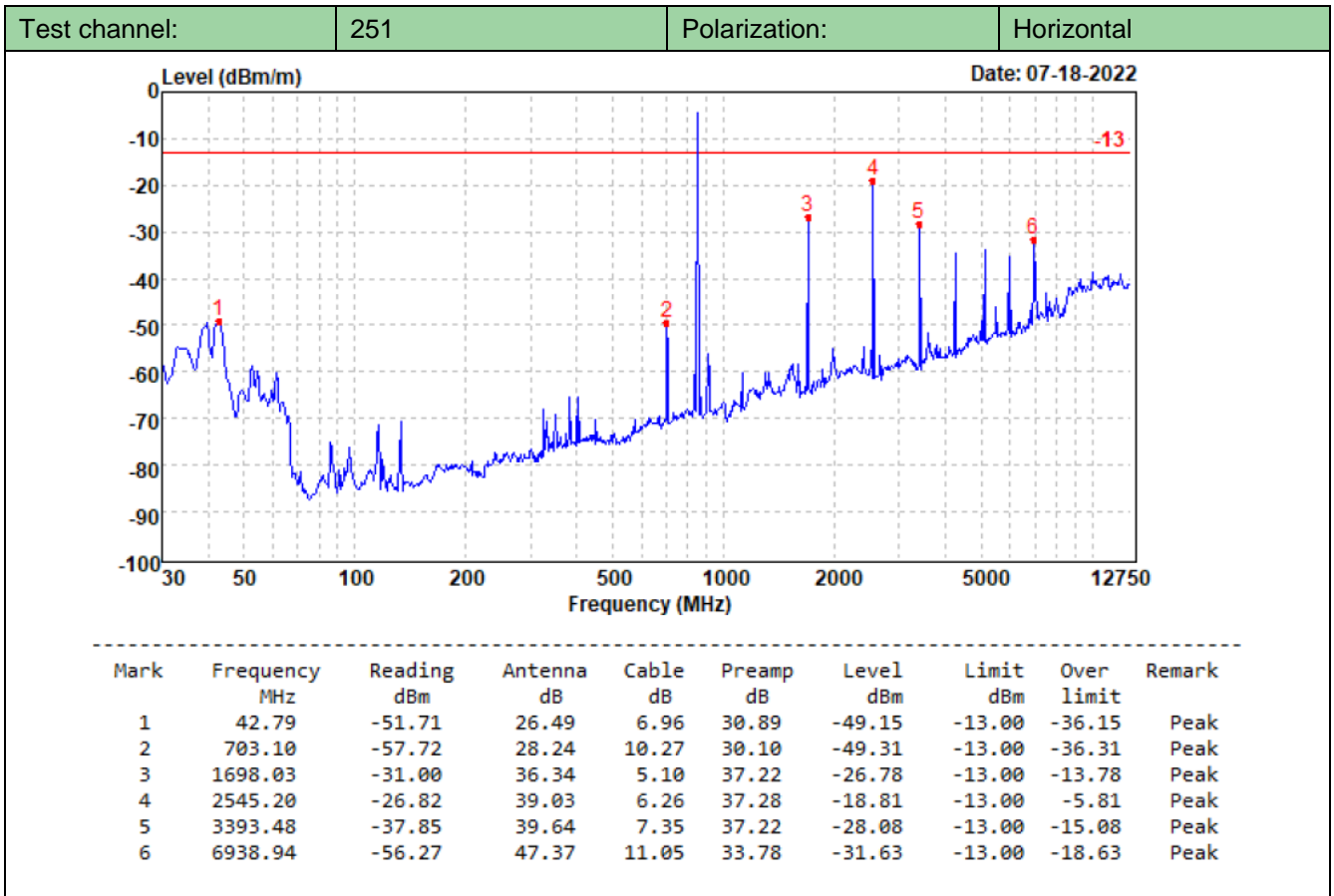

PCS1900

Test channel: 512 Polarization: Horizontal

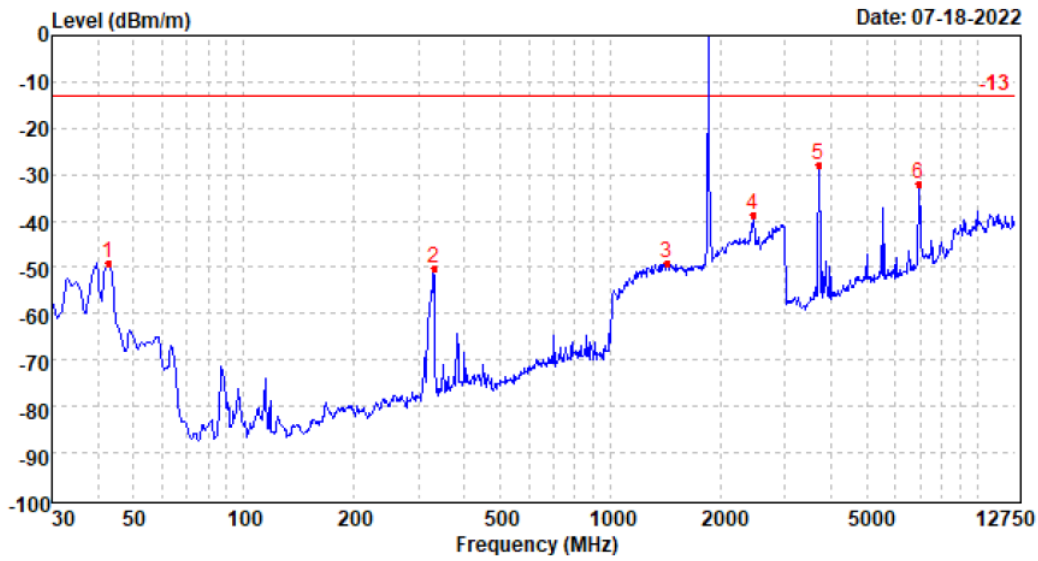

| Mark | Frequency MHz | Reading dBm | Antenna dB | Cable dB | Preamp dB | Level dBm | Limit dBm | Over limit | Remark |
|------|---------------|-------------|------------|----------|-----------|-----------|-----------|------------|--------|
| 1 | 42.79 | -51.59 | 26.49 | 6.96 | 30.89 | -49.03 | -13.00 | -36.03 | Peak |
| 2 | 330.12 | -51.96 | 23.20 | 8.85 | 30.42 | -50.33 | -13.00 | -37.33 | Peak |
| 3 | 1427.54 | -69.08 | 36.98 | 12.24 | 29.36 | -49.22 | -13.00 | -36.22 | Peak |
| 4 | 2448.24 | -64.90 | 39.55 | 15.03 | 28.20 | -38.52 | -13.00 | -25.52 | Peak |
| 5 | 3700.48 | -40.64 | 42.29 | 7.68 | 37.16 | -27.83 | -13.00 | -14.83 | Peak |
| 6 | 6933.90 | -56.43 | 47.35 | 11.04 | 33.82 | -31.86 | -13.00 | -18.86 | Peak |

Test channel: 512 Polarization: Vertical

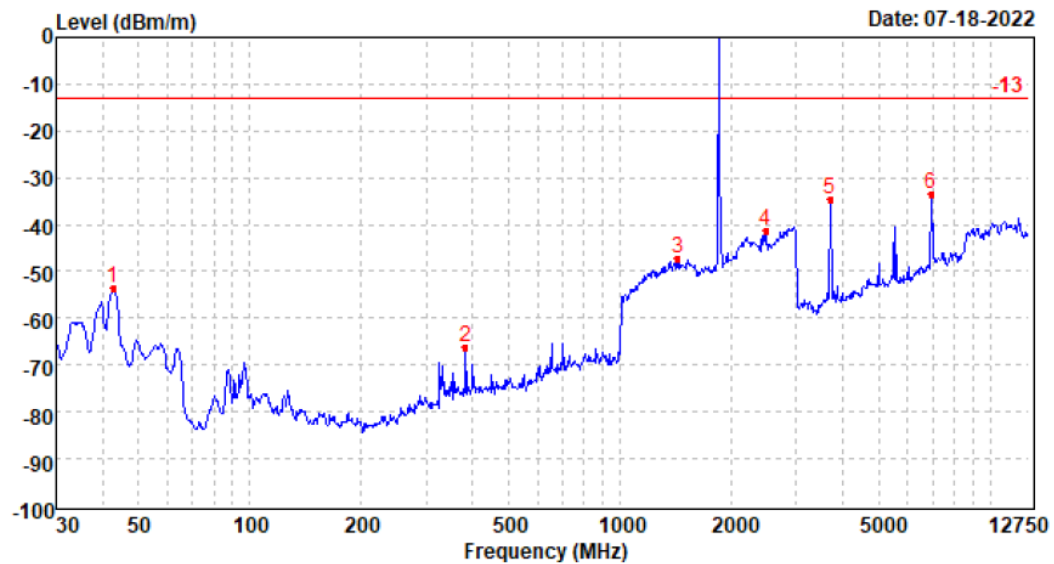

| Mark | Frequency MHz | Reading dBm | Antenna dB | Cable dB | Preamp dB | Level dBm | Limit dBm | Over limit | Remark |
|------|---------------|-------------|------------|----------|-----------|-----------|-----------|------------|--------|
| 1 | 42.79 | -51.12 | 21.39 | 6.96 | 30.89 | -53.66 | -13.00 | -40.66 | Peak |
| 2 | 382.66 | -69.89 | 24.88 | 9.09 | 30.41 | -66.33 | -13.00 | -53.33 | Peak |
| 3 | 1435.40 | -68.10 | 37.76 | 12.26 | 29.29 | -47.37 | -13.00 | -34.37 | Peak |
| 4 | 2475.28 | -67.66 | 39.25 | 15.13 | 28.04 | -41.32 | -13.00 | -28.32 | Peak |
| 5 | 3700.48 | -47.47 | 42.31 | 7.68 | 37.16 | -34.64 | -13.00 | -21.64 | Peak |
| 6 | 6923.86 | -58.07 | 47.37 | 11.03 | 33.90 | -33.57 | -13.00 | -20.57 | Peak |

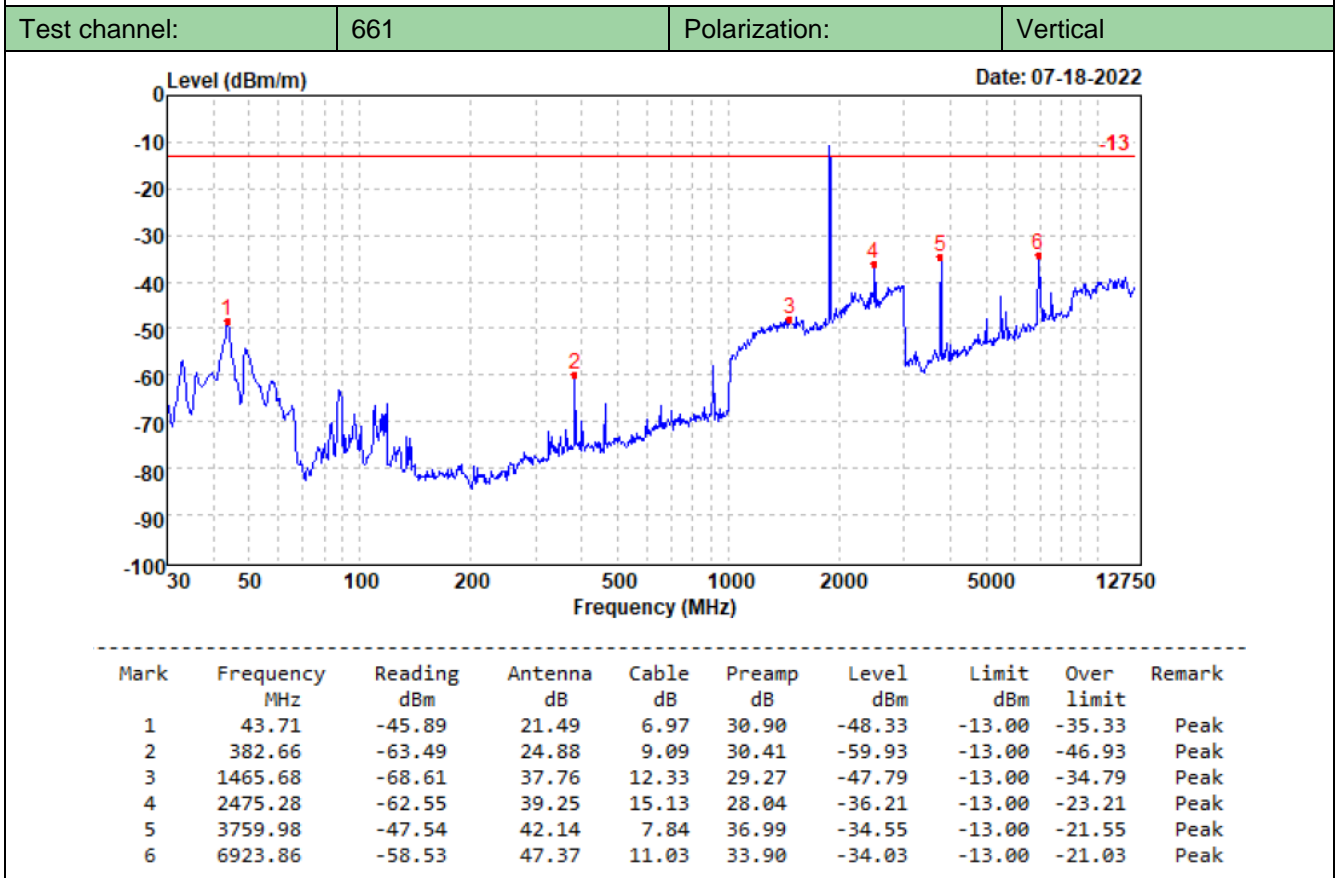
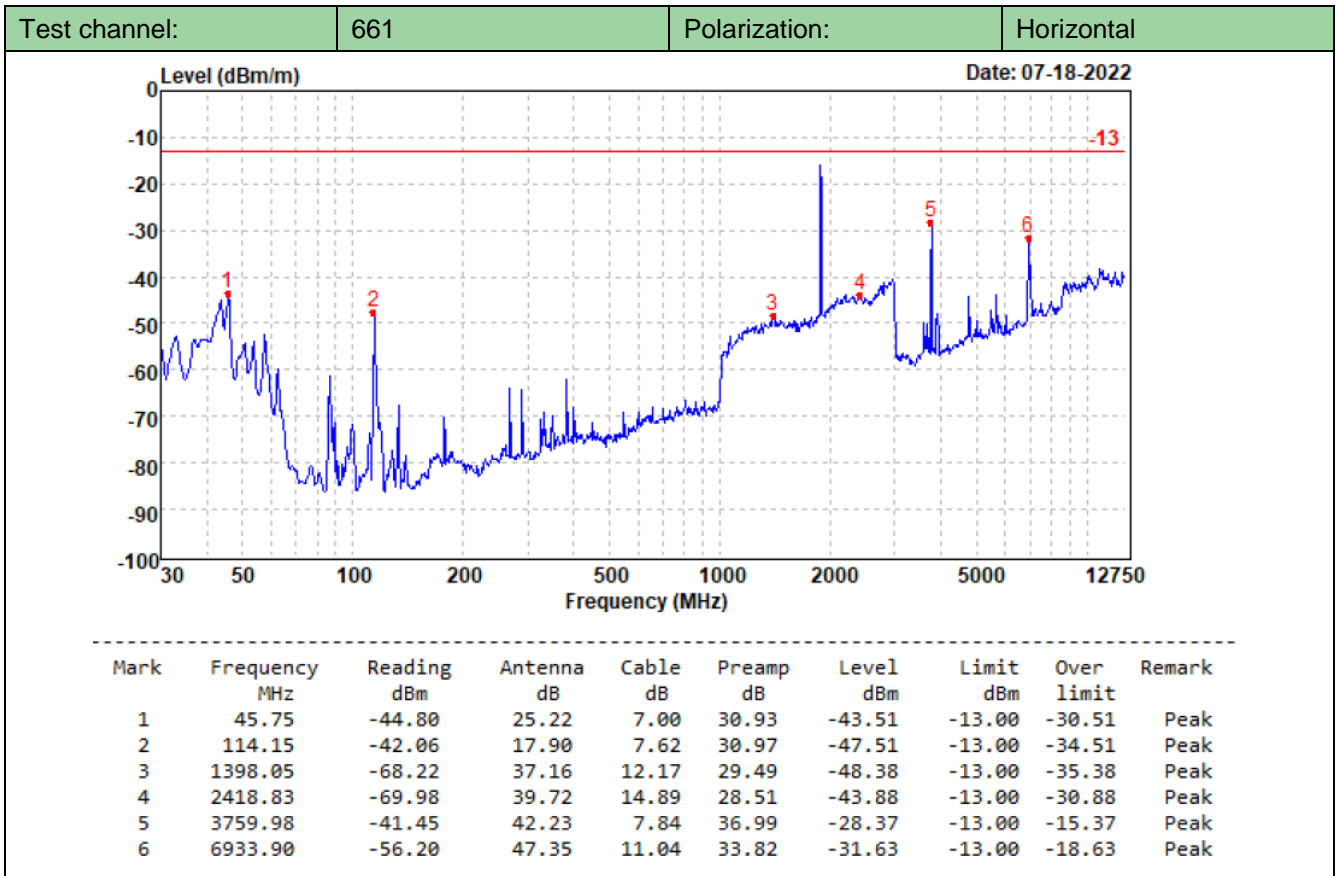

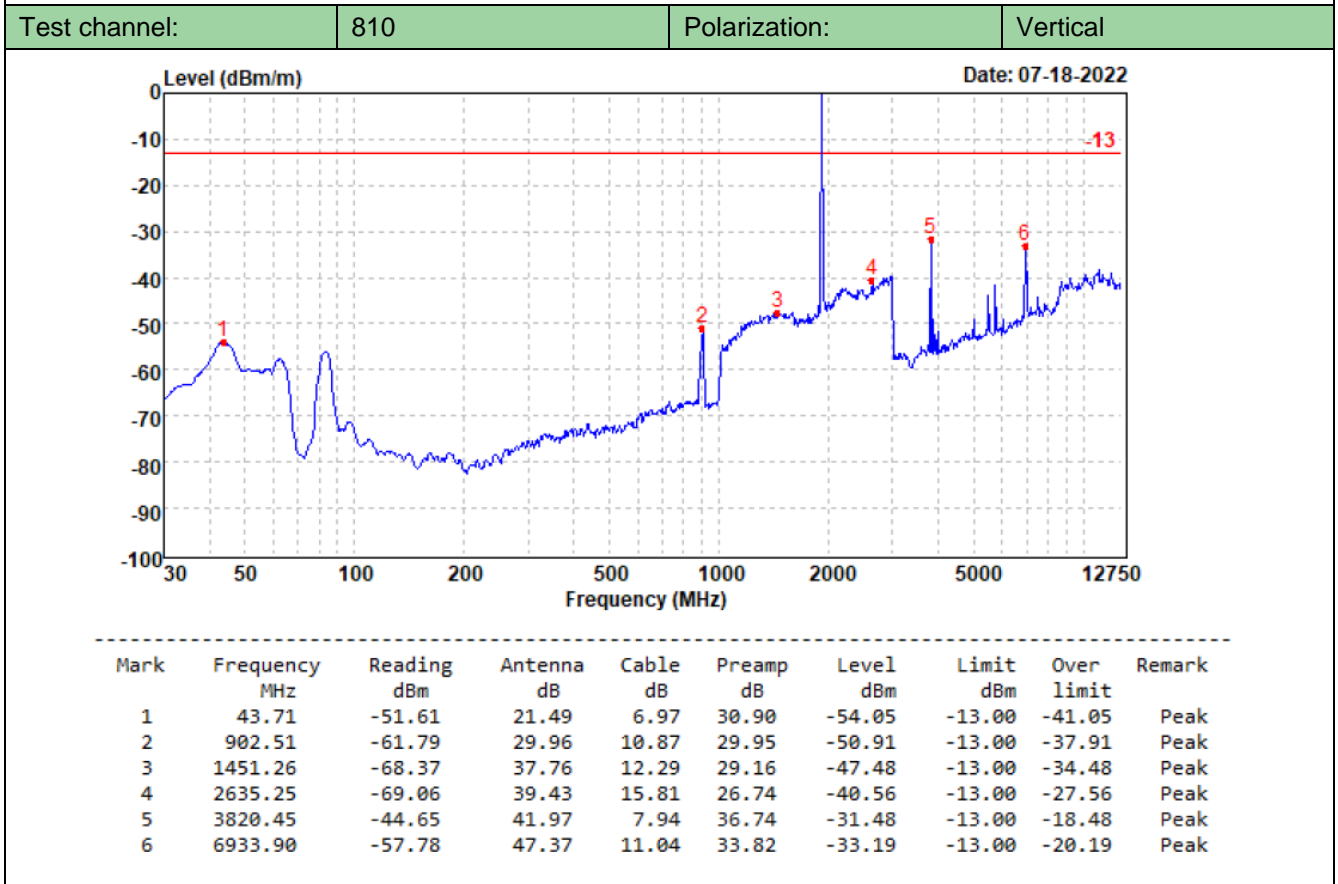
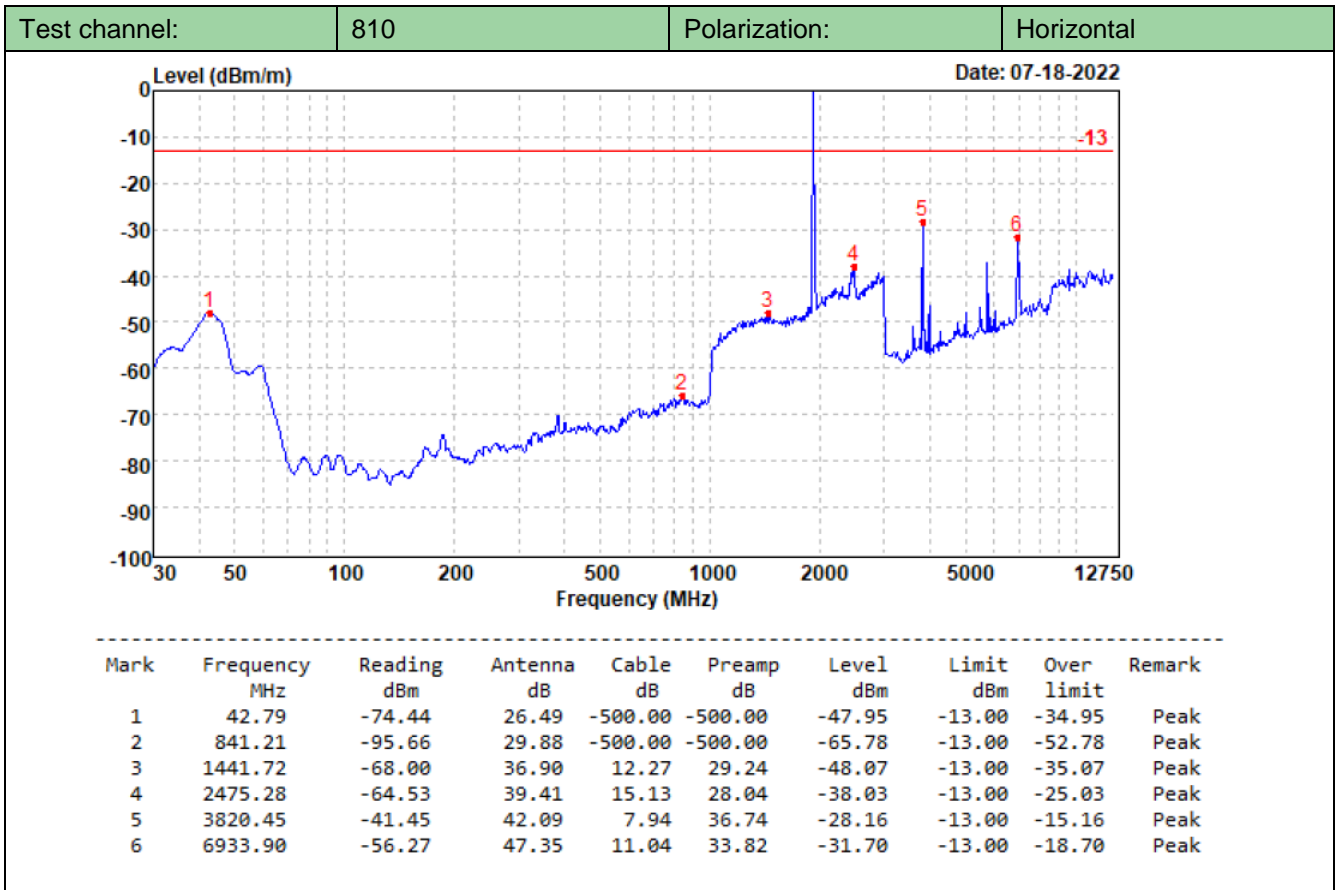

6. TEST SETUP PHOTOS OF THE EUT

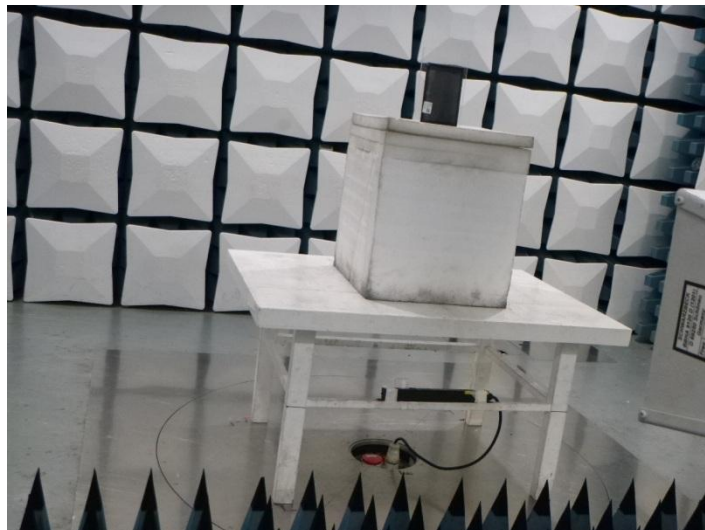
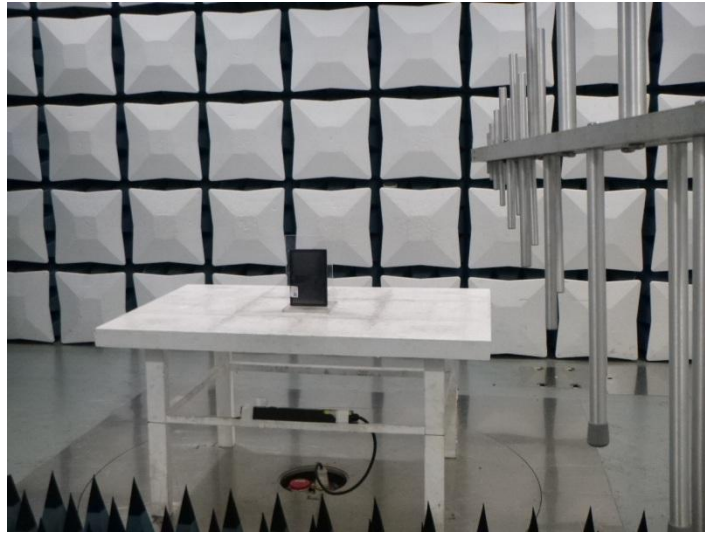

7. EXTERNAL AND INTERNAL PHOTOS OF THE EUT

7.1. External photos

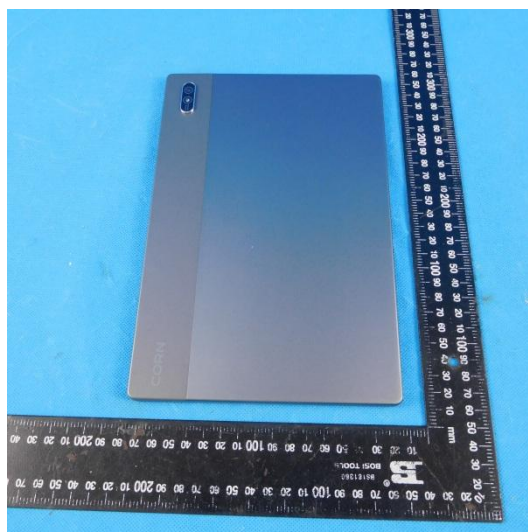
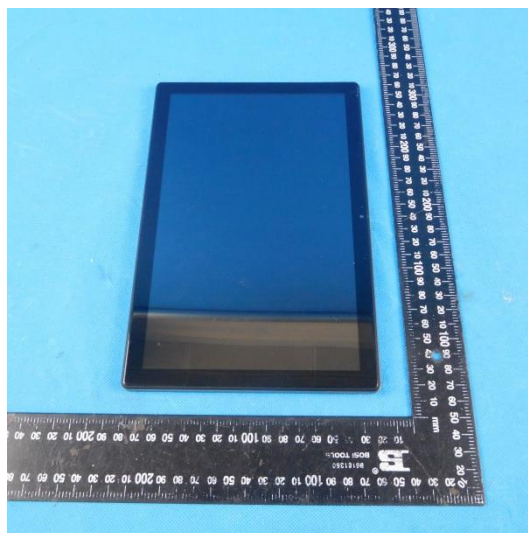
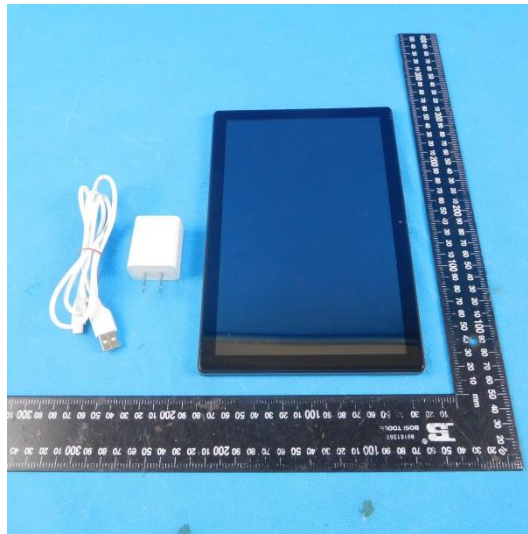

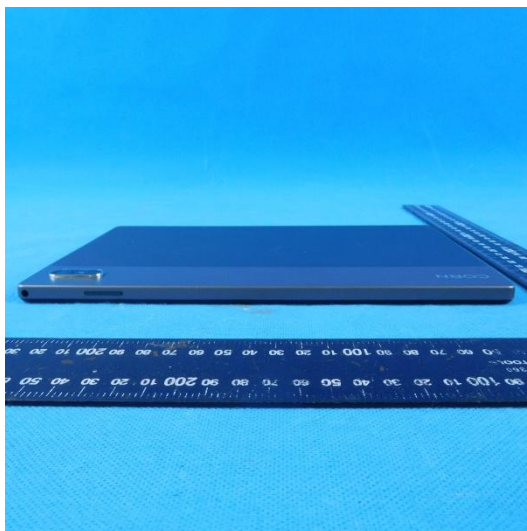
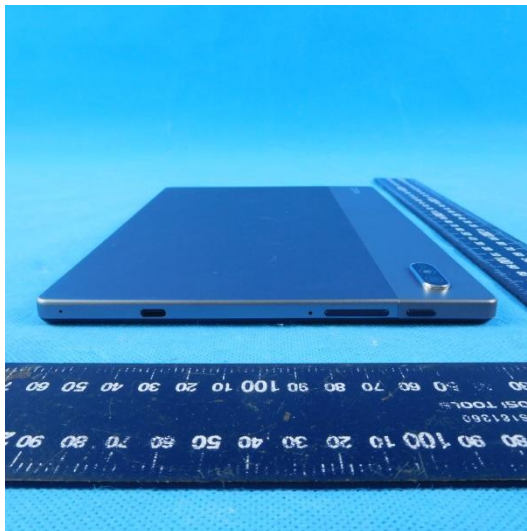
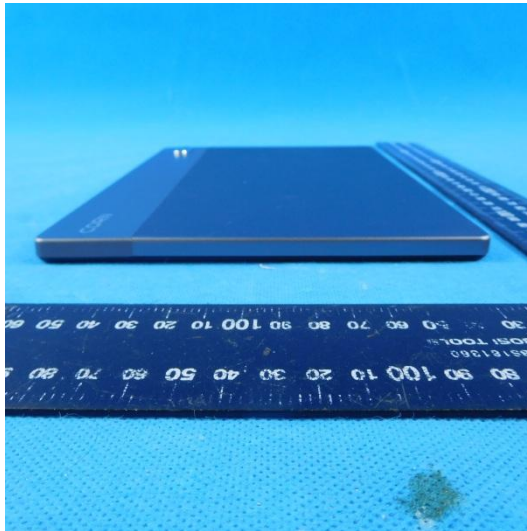



7.2. Internal photos

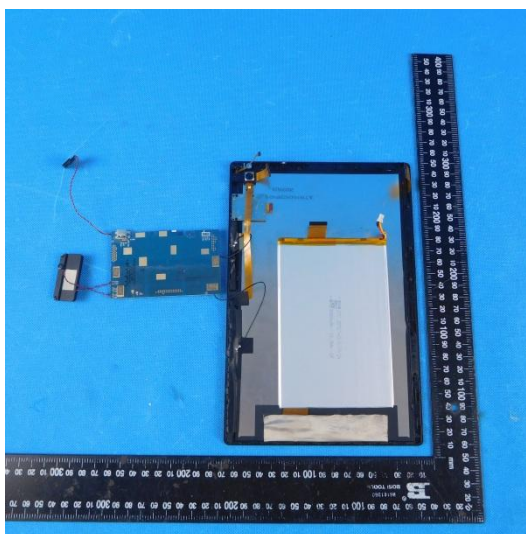
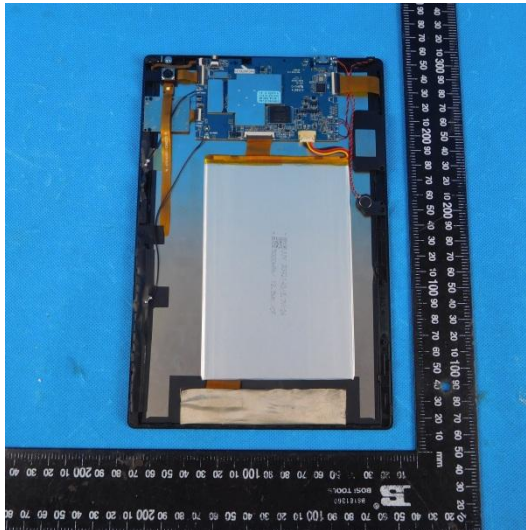
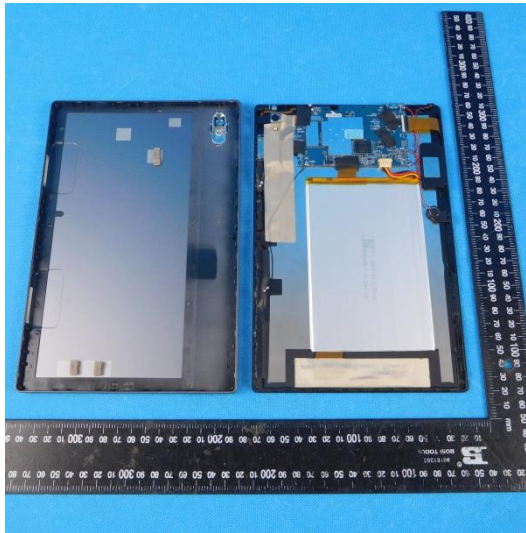

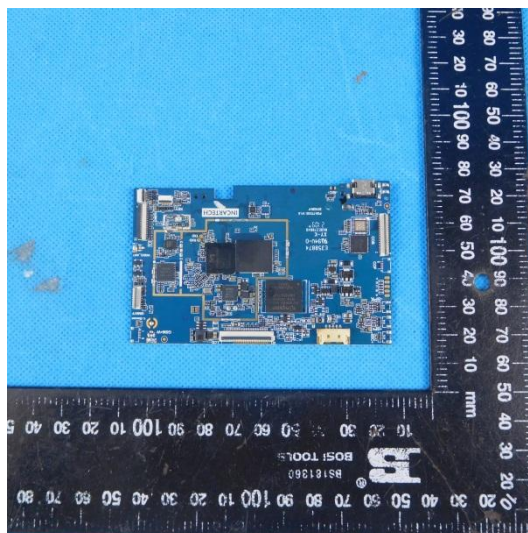
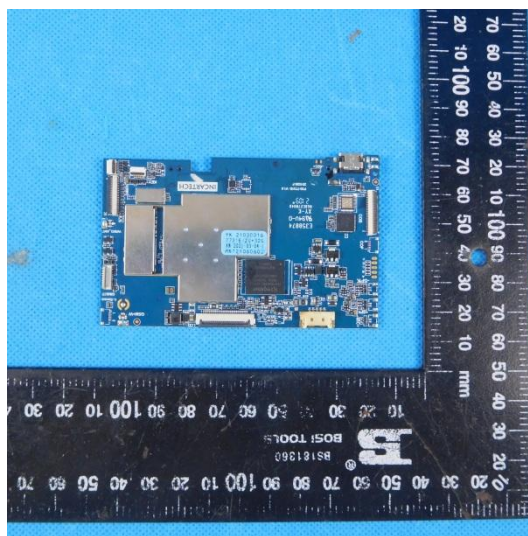
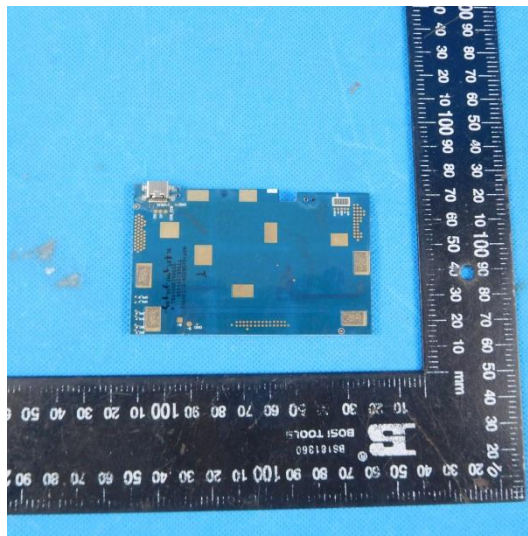

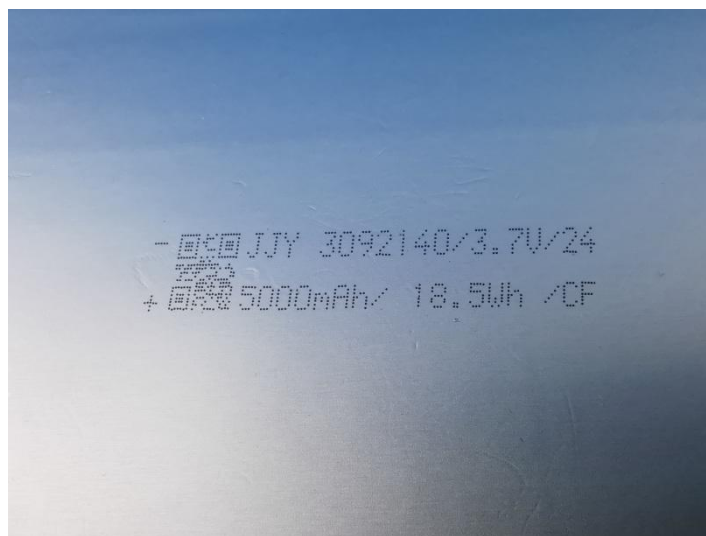

8. APPENDIX REPORT