

TEST REPORT

For Bluetooth-EDR



Report No. : **CHTW24030035** Report Verification:

Project No...... : **SHT2403015402W**

FCC ID..... : **2ASWW-GT40**

Applicant's name..... : **XINCHUANGXIN INTERNATIONAL CO. LTD**

Address..... : **ROOM 605 6/F, FA YUEN COMMERCIAL BUILDING, 75-77 FA YUEN STREET MONGKOK KL**

Product Name : **Feature phone**

Trade Mark : **CORN**

Model No. : **GT40**

Listed Model(s) : **-**

Standard : **FCC CFR Title 47 Part 15 Subpart C § 15.247**

Date of receipt of test sample..... : **Mar. 05, 2024**

Date of testing..... : **Mar. 06, 2024- Mar. 22, 2024**

Date of issue..... : **Mar. 27, 2024**

Result..... : **PASS**

| | | |
|---|-----------------------------------|----------------------|
| Compiled by (Position+Printed name+Signature): | File administrators Xiaodong Zhao | <i>Xiaodong Zhao</i> |
| Supervised by (Position+Printed name+Signature): | Project Engineer Xiaodong Zhao | <i>Xiaodong Zhao</i> |
| Approved by (Position+Printed name+Signature): | Manager Xu Yang | <i>Xu Yang</i> |

Testing Laboratory Name : **Shenzhen Huatongwei International Inspection Co., Ltd.**

Address..... : **Building 7, Baiwang Idea Factory, No.1051, Songbai Road, Yangguang Community, Xili Subdistrict, Nanshan District, Shenzhen, Guangdong, China**

Shenzhen Huatongwei International Inspection Co., Ltd. All rights reserved.

This publication may be reproduced in whole or in part for non-commercial purposes as long as the Shenzhen Huatongwei International Inspection Co., Ltd. is acknowledged as copyright owner and source of the material. Shenzhen Huatongwei International Inspection Co., Ltd. takes no responsibility for and will not assume liability for damages resulting from the reader's interpretation of the reproduced material due to its placement and context. The test report merely correspond to the test sample.

Contents

| | | |
|-----------|--|-----------|
| 1. | TEST STANDARDS AND REPORT VERSION | 3 |
| 1.1. | Test Standards | 3 |
| 1.2. | Report version | 3 |
| 2. | TEST DESCRIPTION | 4 |
| 3. | SUMMARY | 5 |
| 3.1. | Client Information | 5 |
| 3.2. | Product Description | 5 |
| 3.3. | Radio Specification Description | 5 |
| 3.4. | Testing Laboratory Information | 6 |
| 4. | TEST CONFIGURATION | 7 |
| 4.1. | Test frequency list | 7 |
| 4.2. | Descriptions of Test mode | 7 |
| 4.3. | Test mode | 7 |
| 4.4. | Test sample information | 8 |
| 4.5. | Support unit used in test configuration and system | 8 |
| 4.6. | Testing environmental condition | 8 |
| 4.7. | Statement of the measurement uncertainty | 9 |
| 4.8. | Equipment Used during the Test | 10 |
| 5. | TEST CONDITIONS AND RESULTS | 12 |
| 5.1. | Antenna Requirement | 12 |
| 5.2. | AC Conducted Emission | 13 |
| 5.3. | Peak Output Power | 16 |
| 5.4. | 20 dB Bandwidth | 17 |
| 5.5. | 99% Occupied Bandwidth | 18 |
| 5.6. | Carrier Frequencies Separation | 19 |
| 5.7. | Hopping Channel Number | 20 |
| 5.8. | Dwell Time | 21 |
| 5.9. | Duty Cycle Correction Factor (DCCF) | 22 |
| 5.10. | Pseudorandom Frequency Hopping Sequence | 23 |
| 5.11. | Conducted Band edge and Spurious Emission | 24 |
| 5.12. | Radiated Band edge Emission | 25 |
| 5.13. | Radiated Spurious Emission | 27 |
| 6. | TEST SETUP PHOTOS | 32 |
| 7. | EXTERNAL AND INTERNAL PHOTOS | 34 |
| 8. | APPENDIX REPORT | 34 |

1. TEST STANDARDS AND REPORT VERSION

1.1. Test Standards

The tests were performed according to following standards:

- [FCC CFR Title 47 Part 15 Subpart C § 15.247](#): Operation within the bands 902-928 MHz, 2400-2483.5 MHz, and 5725-5850 MHz
- [ANSI C63.10:2020](#): American National Standard for Testing Unlicensed Wireless Devices
- [KDB 558074 D01 15.247 Meas Guidance v05r02](#): Guidance for Compliance Measurements on Digital Transmission System, Frequency Hopping Spread Spectrum System, and Hybrid System Devices Operating under Section 15.247 of The FCC Rules

1.2. Report version

| Revision No. | Date of issue | Description |
|--------------|---------------|-------------|
| N/A | 2024-03-27 | Original |
| | | |
| | | |
| | | |
| | | |

2. TEST DESCRIPTION

| Report clause | Test Items | Standard Requirement | Result | Test Engineer |
|---------------|---|-------------------------|--------|---------------|
| 5.1 | Antenna Requirement | 15.203/15.247 (c) | PASS | Xiaodong Zhao |
| 5.2 | AC Conducted Emission | 15.207 | PASS | Junman Wang |
| 5.3 | Peak Output Power | 15.247 (b)(1) | PASS | Xiangyu Wei |
| 5.4 | 20 dB Bandwidth | 15.247 (a)(1) | PASS | Xiangyu Wei |
| 5.5 | 99% Occupied Bandwidth | - | PASS*1 | Xiangyu Wei |
| 5.6 | Carrier Frequency Separation | 15.247 (a)(1) | PASS | Xiangyu Wei |
| 5.7 | Hopping Channel Number | 15.247 (a)(1) | PASS | Xiangyu Wei |
| 5.8 | Dwell Time | 15.247 (a)(1) | PASS | Xiangyu Wei |
| 5.9 | Duty Cycle Correction Factor | - | PASS*1 | Xiangyu Wei |
| 5.10 | Pseudorandom Frequency Hopping Sequence | 15.247(b)(4) | PASS | Xiangyu Wei |
| 5.11 | Conducted Band Edge and Spurious Emission | 15.247(d)/15.205 | PASS | Xiangyu Wei |
| 5.12 | Radiated Band Edge Emission | 15.205/15.209 | PASS | Yifan Wang |
| 5.13 | Radiated Spurious Emission | 15.247(d)/15.205/15.209 | PASS | Yifan Wang |

Note:

- The measurement uncertainty is not included in the test result.
- *1: No requirement on standard, only report these test data.

3. SUMMARY

3.1. Client Information

| | |
|---------------|--|
| Applicant: | XINCHUANGXIN INTERNATIONAL CO. LTD |
| Address: | ROOM 605 6/F, FA YUEN COMMERCIAL BUILDING, 75-77 FA YUEN STREET MONGKOK KL |
| Manufacturer: | Shenzhen Chiteng Technology Co.,LTD |
| Address: | Second Floor,Area A, Building 4, Huiye Technology Workshop, Guangang Road, Tangjia Community, Gongming Street, Guangming New District, Shenzhen, Guangdong |

3.2. Product Description

| Main unit information: | |
|-----------------------------|---|
| Product Name: | Feature phone |
| Trade Mark: | CORN |
| Model No.: | GT40 |
| Listed Model(s): | - |
| Power supply: | DC 3.7V from Li-ion Battery |
| Hardware version: | ZS621TF_MB_V1.0 |
| Software version: | ZS621TF_48X128_240320_B24410TF_3_GT40_CORN_EnFrPoSp_V01_20240314 |
| Accessory unit information: | |
| Battery information: | BL-19A Voltage: 3.7V Capacity: 1800mAh 3.7V Li-ion BATTERY 6.66Wh |
| Adapter information: | Input: AC100-240V 50/60Hz 150mA Output: DC 5.2V, 500mA |

3.3. Radio Specification Description

| | |
|----------------------|----------------------------|
| Bluetooth version: | V5.0 |
| Support function: | EDR |
| Modulation: | GFSK, $\pi/4$ DQPSK, 8DPSK |
| Operation frequency: | 2402MHz~2480MHz |
| Channel number: | 79 |
| Channel separation: | 1MHz |
| Antenna type: | PIFA |
| Antenna gain: | -0.73dBi |

3.4. Testing Laboratory Information

| | | |
|----------------------|---|----------------------|
| Laboratory Name | Shenzhen Huatongwei International Inspection Co., Ltd. | |
| Laboratory Location | Building 7, Baiwang Idea Factory, No.1051, Songbai Road, Yangguang Community, Xili Subdistrict, Nanshan District, Shenzhen, Guangdong, China | |
| Contact information: | Tel: 86-755-26715499 E-mail: cs@szhtw.com.cn http://www.szhtw.com.cn | |
| Qualifications: | Type | Accreditation Number |
| | FCC Registration Number | 762235 |
| | FCC Designation Number | CN1181 |

4. TEST CONFIGURATION

4.1. Test frequency list

According to section 15.31(m), regards to the operating frequency range over 10 MHz, must select three channels which were tested. The Lowest frequency, the middle frequency, and the highest frequency of channel were selected to perform the test, please see the below blue front.

| Channel | Frequency (MHz) |
|---------|-----------------|
| 00 | 2402 |
| 01 | 2403 |
| : | : |
| 39 | 2441 |
| : | : |
| 77 | 2479 |
| 78 | 2480 |

4.2. Descriptions of Test mode

Preliminary tests were performed in different data rates and recorded the RF output power in the clause 5.3

Note:

- 1) The manufacturer declare that the maximum power value of the product is set as a default value in the enter test mode software.
- 2) All the test data for each data rate were verified, found 8DPSK Modulation which is worse case mode

4.3. Test mode

| For RF test items: | | | |
|---|------------------------|------------------------|----------------|
| The engineering test program was provided and enabled to make EUT continuous transmitting. | | | |
| Test Item | Modulation / Data Rate | | |
| | GFSK 1Mbps | $\pi/4$ DQPSK 2Mbps | 8DPSK 3Mbps |
| Conducted test item | ✓ | ✓ | ✓ |
| Radiated test item | - | - | ✓ |
| Remark: | | | |
| <ul style="list-style-type: none"> – For radiated test item, the worst mode data rate 3Mbps was reported only, because this data rate has the highest RF output power at preliminary tests. – The EUT in each of three orthogonal axis emissions had been tested, but only the worst case (X axis) data recorded in the report. | | | |

4.4. Test sample information

| Test item | HTW sample no. |
|-------------------------|---|
| RF Conducted test items | Refer to the description in the appendix report |
| RF Radiated test items | YPHT24030154001_02 |
| EMI test items | YPHT24030154001_02 |

Note:

RF Conducted test items: Peak Output Power, 20 dB Bandwidth, 99% Occupied Bandwidth, Carrier Frequency Separation, Hopping Channel Number, Dwell Time, Duty Cycle Correction Factor, Pseudorandom Frequency Hopping Sequence, Conducted Band Edge and Spurious Emission

RF Radiated test items: Radiated Band Edge Emission, Radiated Spurious Emission

EMI test items: AC Conducted Emission

4.5. Support unit used in test configuration and system

The EUT has been associated with peripherals and configuration operated in a manner tended to maximize its emission characteristics in a typical application.

The following peripheral devices and interface cables were connected during the measurement:

| Whether support unit is used? | | | |
|-------------------------------|-----------|------------|-----------|
| ✓ No | | | |
| Item | Equipment | Trade Name | Model No. |
| 1 | | | |
| 2 | | | |

4.6. Testing environmental condition

| Type | Requirement | Actual |
|--------------------|--------------|----------|
| Temperature: | 15~35°C | 25°C |
| Relative Humidity: | 25~75% | 50% |
| Air Pressure: | 860~1060mbar | 1000mbar |

4.7. Statement of the measurement uncertainty

| No. | Test Items | Measurement Uncertainty |
|-----|---|--|
| 1 | AC Conducted Emission | 3.21dB |
| 2 | Peak Output Power | 1.07 |
| 3 | Power Spectral Density | 1.07 |
| 4 | 6dB Bandwidth | 0.002% |
| 5 | 99% Occupied Bandwidth | 0.002% |
| 6 | Duty cycle | - |
| 7 | Conducted Band Edge and Spurious Emission | 1.68dB |
| 8 | Radiated Band Edge Emission | 4.54dB for 30MHz-1GHz 5.10dB for above 1GHz |
| 9 | Radiated Spurious Emission | 4.54dB for 30MHz-1GHz 5.10dB for above 1GHz |

This uncertainty represents an expanded uncertainty expressed at approximately the 95% confidence level using a coverage factor of $k=1.96$.

4.8. Equipment Used during the Test

| ● Conducted Emission | | | | | | | |
|----------------------|--------------------|--------------|---------------|-----------------|------------|---------------------------|---------------------------|
| Used | Test Equipment | Manufacturer | Equipment No. | Model No. | Serial No. | Last Cal. Date (YY-MM-DD) | Next Cal. Date (YY-MM-DD) |
| ● | EMI Test Receiver | R&S | HTWE0111 | ESCI | 101247 | 2023/08/22 | 2024/08/21 |
| ● | Artificial Mains | SCHWARZBECK | HTWE0113 | NNLK 8121 | 573 | 2023/08/18 | 2024/08/17 |
| ● | Protection Network | SCHWARZBECK | HTWE0567 | VTSD9561FN | 00899 | 2023/08/18 | 2024/08/17 |
| ● | ISN | FCC | HTWE0148 | FCC-TLISN-T2-02 | 20371 | 2023/08/18 | 2024/08/17 |
| ● | ISN | FCC | HTWE0150 | FCC-TLISN-T8-02 | 20375 | 2023/08/18 | 2024/08/17 |
| ● | Test Software | R&S | N/A | EMC32 | N/A | N/A | N/A |

| ● RF Conducted test item | | | | | | | |
|--------------------------|------------------------------|--------------|---------------|-----------|------------|---------------------------|---------------------------|
| Used | Test Equipment | Manufacturer | Equipment No. | Model No. | Serial No. | Last Cal. Date (YY-MM-DD) | Next Cal. Date (YY-MM-DD) |
| ● | Signal and spectrum Analyzer | R&S | HTWE0242 | FSV40 | 100048 | 2023/08/22 | 2024/08/21 |
| ● | Signal & Spectrum Analyzer | R&S | HTWE0262 | FSW26 | 103440 | 2023/08/22 | 2024/08/21 |
| ● | Vector signal generator | R&S | HTWE0244 | SMBV100A | 260790 | 2023/05/23 | 2024/05/22 |
| ● | Test software | Tonscend | N/A | JS1120 | N/A | N/A | N/A |

| ● Radiated emission- 9kHz~30MHz | | | | | | | |
|---------------------------------|-----------------------|--------------------|---------------|-----------|------------|---------------------------|---------------------------|
| Used | Test Equipment | Manufacturer | Equipment No. | Model No. | Serial No. | Last Cal. Date (YY-MM-DD) | Next Cal. Date (YY-MM-DD) |
| ● | Semi-Anechoic Chamber | Albatross projects | HTWE0127 | SAC-3m-02 | C11121 | 2023/04/06 | 2026/04/05 |
| ● | EMI Test Receiver | R&S | HTWE0099 | ESCI 7 | 100900 | 2023/08/22 | 2024/08/21 |
| ● | Loop Antenna | R&S | HTWE0170 | HFH2-Z2 | 100020 | 2021/04/06 | 2024/04/05 |
| ● | Test Software | R&S | N/A | EMC32 | N/A | N/A | N/A |

| ● Radiated emission- 30MHz~1GHz | | | | | | | |
|---------------------------------|-------------------------|--------------------|---------------|-----------|------------|---------------------------|---------------------------|
| Used | Test Equipment | Manufacturer | Equipment No. | Model No. | Serial No. | Last Cal. Date (YY-MM-DD) | Next Cal. Date (YY-MM-DD) |
| ● | Semi-Anechoic Chamber | Albatross projects | HTWE0127 | SAC-3m-02 | C11121 | 2023/04/06 | 2026/04/05 |
| ● | EMI Test Receiver | R&S | HTWE0099 | ESCI 7 | 100900 | 2023/08/22 | 2024/08/21 |
| ● | Ultra-Broadband Antenna | SCHWARZBECK | HTWE0119 | VULB9163 | 546 | 2023/2/22 | 2026/2/21 |
| ● | Pre-Amplifier | SCHWARZBECK | HTWE0295 | BBV 9742 | / | 2023/5/25 | 2024/5/24 |
| ● | Test Software | R&S | N/A | EMC32 | N/A | N/A | N/A |

| ● Radiated emission- Above 1GHz | | | | | | | |
|---------------------------------|-------------------------|--------------------|---------------|------------|------------|---------------------------|---------------------------|
| Used | Test Equipment | Manufacturer | Equipment No. | Model No. | Serial No. | Last Cal. Date (YY-MM-DD) | Next Cal. Date (YY-MM-DD) |
| ● | Semi-Anechoic Chamber | Albatross projects | HTWE0122 | SAC-3m-01 | C11121 | 2023/04/17 | 2026/04/16 |
| ● | Spectrum Analyzer | R&S | HTWE0098 | FSP40 | 100597 | 2023/08/22 | 2024/08/21 |
| ● | Spectrum Analyzer | R&S | HTWE0385 | N9020A | MY54486658 | 2023/08/22 | 2024/08/21 |
| ● | Horn Antenna | SCHWARZBECK | HTWE0126 | BBHA 9120D | 1011 | 2023/02/14 | 2026/02/13 |
| ● | Pre-Amplifier | CD | HTWE0071 | PAP-0102 | 12004 | 2023/05/25 | 2024/05/24 |
| ● | Broadband Pre-amplifier | SCHWARZBECK | HTWE0201 | BBV 9718 | 9718-248 | 2023/05/25 | 2024/05/24 |
| ● | Test Software | Audix | N/A | E3 | N/A | N/A | N/A |

5. TEST CONDITIONS AND RESULTS

5.1. Antenna Requirement

REQUIREMENT

FCC CFR Title 47 Part 15 Subpart C Section 15.203:

An intentional radiator shall be designed to ensure that no antenna other than that furnished by the responsible party shall be used with the device. The use of a permanently attached antenna or of an antenna that uses a unique coupling to the intentional radiator, the manufacturer may design the unit so that a broken antenna can be replaced by the user, but the use of a standard antenna jack or electrical connector is prohibited.

TEST RESULT

Passed Not Applicable

The antenna type is a PIFA antenna, Refer to the below antenna photo.



5.2. AC Conducted Emission

LIMIT

FCC CFR Title 47 Part 15 Subpart C Section 15.207

| Frequency range (MHz) | Limit (dBuV) | |
|-----------------------|--------------|-----------|
| | Quasi-peak | Average |
| 0.15-0.5 | 66 to 56* | 56 to 46* |
| 0.5-5 | 56 | 46 |
| 5-30 | 60 | 50 |

* Decreases with the logarithm of the frequency.

TEST CONFIGURATION

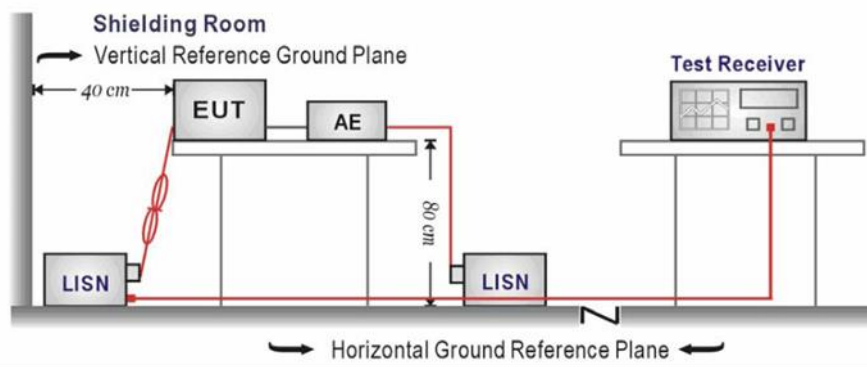

TEST PROCEDURE

1. The EUT was setup according to ANSI C63.10 requirements.
2. The EUT was placed on a platform of nominal size, 1 m by 1.5 m, raised 80 cm above the conducting ground plane. The vertical conducting plane was located 40 cm to the rear of the EUT. All other surfaces of EUT were at least 80 cm from any other grounded conducting surface.
3. The EUT and simulators are connected to the main power through a line impedances stabilization network (LISN). The LISN provides a 50 ohm /50uH coupling impedance for the measuring equipment.
4. The peripheral devices are also connected to the main power through a LISN. (Refer to the block diagram of the test setup and photographs)
5. Each current-carrying conductor of the EUT power cord, except the ground (safety) conductor, was individually connected through a LISN to the input power source.
6. The excess length of the power cord between the EUT and the LISN receptacle were folded back and forth at the center of the lead to form a bundle not exceeding 40 cm in length.
7. Conducted emissions were investigated over the frequency range from 0.15MHz to 30MHz using a receiver bandwidth of 9 kHz.
8. During the above scans, the emissions were maximized by cable manipulation.

TEST MODE

Refer to the clause 4.3

TEST RESULT

Passed Not Applicable

Test Line:

L

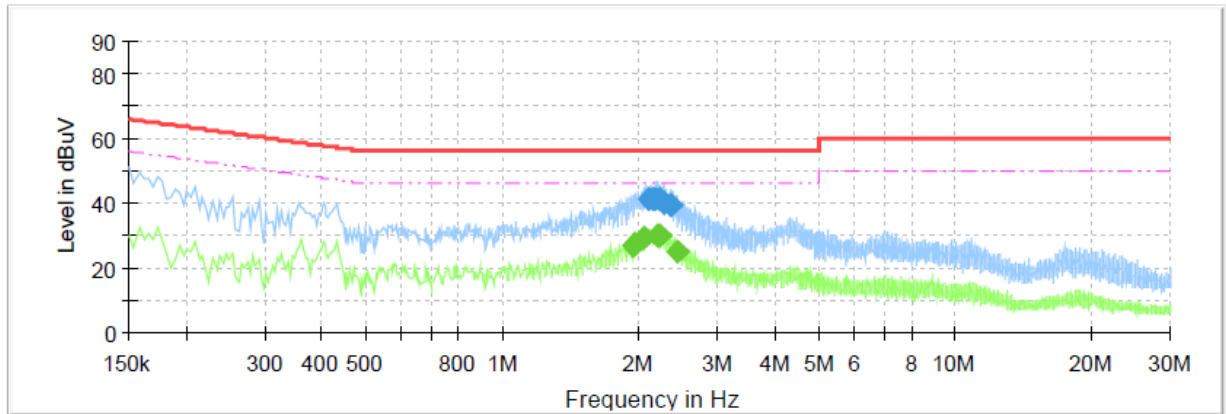

Final Result

| Frequency (MHz) | QuasiPeak (dBuV) | CAverage (dBuV) | Limit (dBuV) | Margin (dB) | Line | Corr. (dB) |
|-----------------|------------------|-----------------|--------------|-------------|------|------------|
| 1.9395 | --- | 26.75 | 46.00 | 19.25 | L1 | 11.0 |
| 1.9675 | --- | 27.37 | 46.00 | 18.63 | L1 | 11.0 |
| 2.0675 | --- | 29.29 | 46.00 | 16.71 | L1 | 11.0 |
| 2.1115 | 41.07 | --- | 56.00 | 14.93 | L1 | 11.0 |
| 2.1515 | 41.07 | --- | 56.00 | 14.93 | L1 | 11.0 |
| 2.1835 | 41.31 | --- | 56.00 | 14.69 | L1 | 11.0 |
| 2.2035 | --- | 30.15 | 46.00 | 15.85 | L1 | 11.0 |
| 2.2315 | 41.01 | --- | 56.00 | 14.99 | L1 | 11.0 |
| 2.2395 | --- | 29.76 | 46.00 | 16.24 | L1 | 11.0 |
| 2.2875 | 39.76 | --- | 56.00 | 16.24 | L1 | 11.0 |
| 2.3475 | 39.07 | --- | 56.00 | 16.93 | L1 | 11.0 |
| 2.4475 | --- | 25.03 | 46.00 | 20.97 | L1 | 11.0 |

Test Line:

N

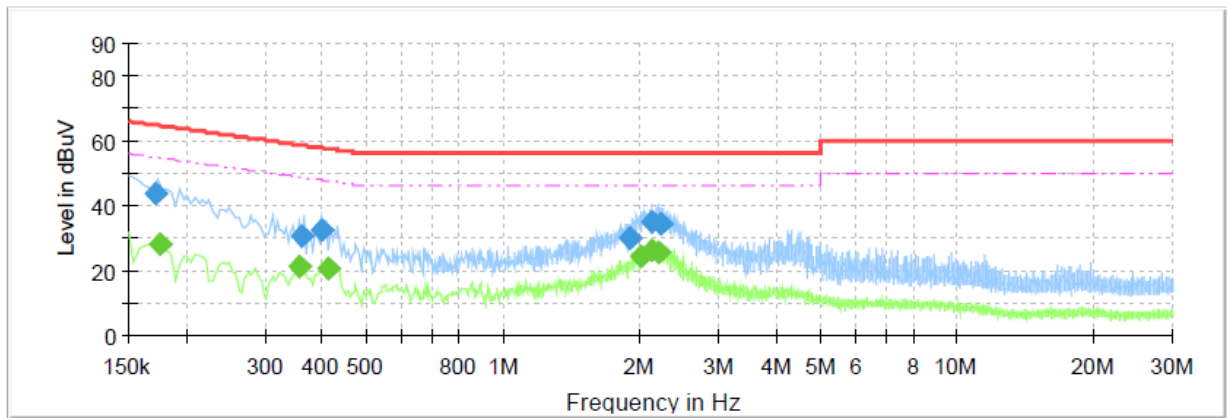

Final Result

| Frequency (MHz) | QuasiPeak (dBuV) | CAverage (dBuV) | Limit (dBuV) | Margin (dB) | Line | Corr. (dB) |
|-----------------|------------------|-----------------|--------------|-------------|------|------------|
| 0.1715 | 43.60 | --- | 64.89 | 21.28 | N | 10.7 |
| 0.1755 | --- | 27.99 | 54.70 | 26.70 | N | 10.7 |
| 0.3555 | --- | 21.16 | 48.83 | 27.67 | N | 10.7 |
| 0.3595 | 30.54 | --- | 58.74 | 28.20 | N | 10.7 |
| 0.3995 | 32.40 | --- | 57.86 | 25.46 | N | 10.6 |
| 0.4115 | --- | 20.37 | 47.62 | 27.25 | N | 10.7 |
| 1.8965 | 29.90 | --- | 56.00 | 26.10 | N | 10.8 |
| 2.0275 | --- | 24.30 | 46.00 | 21.70 | N | 10.8 |
| 2.1315 | 35.01 | --- | 56.00 | 20.99 | N | 10.8 |
| 2.1405 | --- | 26.01 | 46.00 | 19.99 | N | 10.8 |
| 2.2035 | --- | 25.88 | 46.00 | 20.12 | N | 10.8 |
| 2.2245 | 34.48 | --- | 56.00 | 21.52 | N | 10.8 |

5.3. Peak Output Power

LIMIT

FCC CFR Title 47 Part 15 Subpart C Section 15.247 (b)(1):

For frequency hopping systems operating in the 2400-2483.5 MHz band employing at least 75 non-overlapping hopping channels, and all frequency hopping systems in the 5725-5850 MHz band: 1 watt.
For all other frequency hopping systems in the 2400-2483.5 MHz band: 0.125 watts.

TEST CONFIGURATION

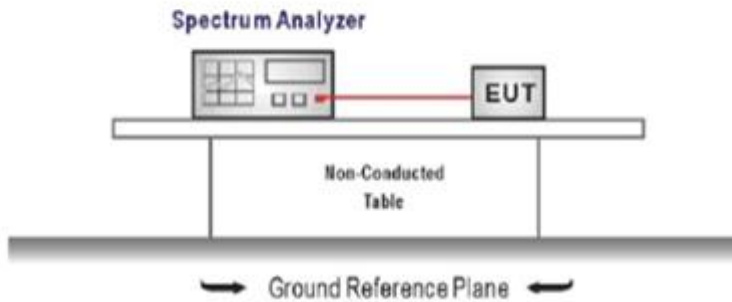

TEST PROCEDURE

1. The transmitter output was connected to the spectrum analyzer through an attenuator, the pathloss was compensated to the results for each measurement.
2. Set to the maximum power setting and enable the EUT transmit continuously
3. Use the following spectrum analyzer settings:
Span = approximately 5 times the 20 dB bandwidth, centered on a hopping channel
RBW \geq the 20 dB bandwidth of the emission being measured, VBW \geq RBW
Sweep = auto, Detector function = peak, Trace = max hold
4. Measure and record the results in the test report.

TEST MODE

Refer to the clause 4.3

TEST RESULT

Passed Not Applicable

TEST DATA

Refer to the appendix report

5.4. 20 dB Bandwidth

LIMIT

N/A

TEST CONFIGURATION

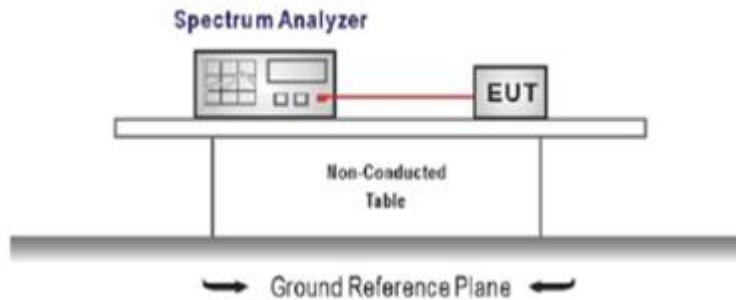

TEST PROCEDURE

1. The transmitter output was connected to the spectrum analyzer through an attenuator, the path loss was compensated to the results for each measurement.
2. Set to the maximum power setting and enable the EUT transmit continuously
3. Use the following spectrum analyzer settings:
Span = approximately 2 to 3 times the 20 dB bandwidth, centered on a hopping channel
RBW \geq 1% of the 20 dB bandwidth, VBW \geq RBW
Sweep = auto, Detector function = peak, Trace = max hold
4. Measure and record the results in the test report.

TEST MODE

Refer to the clause 4.3

TEST RESULT

Passed Not Applicable

TEST DATA

Refer to the appendix report

5.5. 99% Occupied Bandwidth

LIMIT

N/A

TEST CONFIGURATION

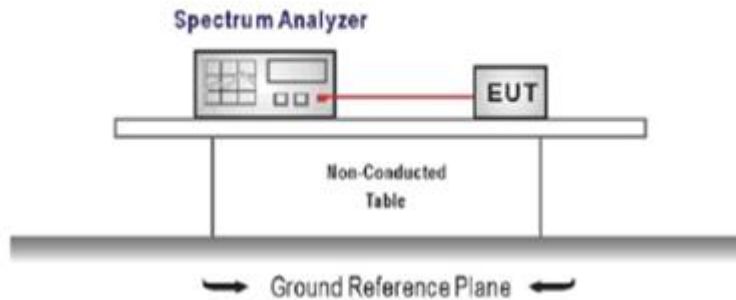

TEST PROCEDURE

1. Connect the antenna port(s) to the spectrum analyzer input.
2. Configure the spectrum analyzer as shown below (enter all losses between the transmitter output and the spectrum analyzer).
Center Frequency = channel center frequency
Span $\geq 1.5 \times$ OBW
RBW = 1%~5%OBW
VBW $\geq 3 \times$ RBW
Sweep time = auto couple
Detector = Peak
Trace mode = max hold
3. Place the radio in continuous transmit mode, allow the trace to stabilize, view the transmitter waveform on the spectrum analyzer.

TEST MODE

Refer to the clause 4.3

TEST RESULT

Passed Not Applicable

TEST DATA

Refer to the appendix report

5.6. Carrier Frequencies Separation

LIMIT

FCC CFR Title 47 Part 15 Subpart C Section 15.247 (a)(1):

Frequency hopping systems shall have hopping channel carrier frequencies separated by a minimum of 25kHz or the 20 dB bandwidth of the hopping channel, whichever is greater. Alternatively, Frequency hopping systems operating in the 2400-2483.5 MHz band may have hopping channel carrier frequencies that are separated by 25 kHz or two-thirds of the 20 dB bandwidth of the hopping channel, whichever is greater, provided the systems operate with an output power no greater than 125 mW.

TEST CONFIGURATION

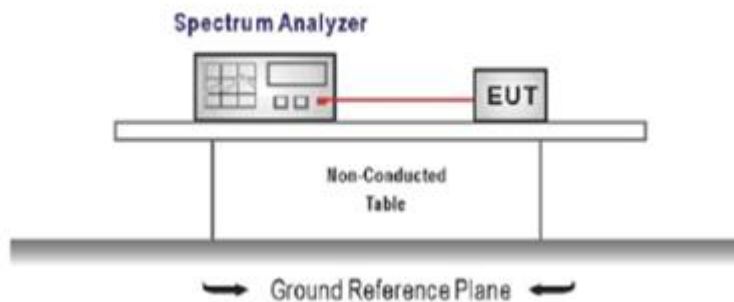

TEST PROCEDURE

1. The transmitter output was connected to the spectrum analyzer through an attenuator, the path loss was compensated to the results for each measurement.
2. Set to the maximum power setting and enable the EUT transmit continuously
3. Use the following spectrum analyzer settings:
 - Span = wide enough to capture the peaks of two adjacent channels
 - RBW \geq 1% of the span, VBW \geq RBW
 - Sweep = auto, Detector function = peak, Trace = max hold
4. Measure and record the results in the test report.

TEST MODE

Refer to the clause 4.3

TEST RESULTS

Passed Not Applicable

TEST DATA

Refer to the appendix report

5.7. Hopping Channel Number

LIMIT

FCC CFR Title 47 Part 15 Subpart C Section 15.247 (a)(1):

Frequency hopping systems in the 2400–2483.5 MHz band shall use at least **15** channels.

TEST CONFIGURATION

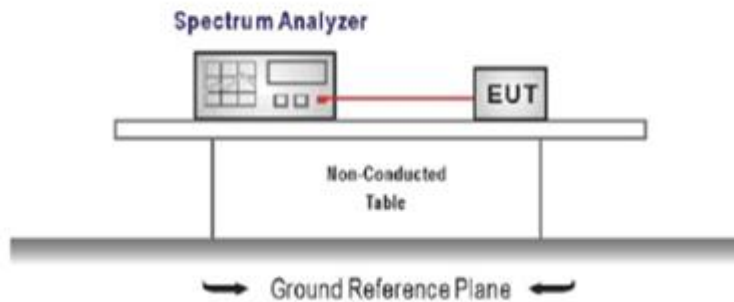

TEST PROCEDURE

1. The transmitter output was connected to the spectrum analyzer through an attenuator, the path loss was compensated to the results for each measurement.
2. Set to the maximum power setting and enable the EUT transmit continuously
3. Use the following spectrum analyzer settings:
Span = the frequency band of operation
RBW \geq 1% of the span, VBW \geq RBW
Sweep = auto, Detector function = peak, Trace = max hold
4. Measure and record the results in the test report.

TEST MODE

Refer to the clause 4.3

TEST RESULTS

Passed Not Applicable

TEST DATA

Refer to the appendix report

5.8. Dwell Time

LIMIT

FCC CFR Title 47 Part 15 Subpart C Section 15.247 (a)(1):The average time of occupancy on any channel shall not be greater than 0.4 seconds within a pe-riod of 0.4 seconds multiplied by the number of hopping channels employed.

TEST CONFIGURATION

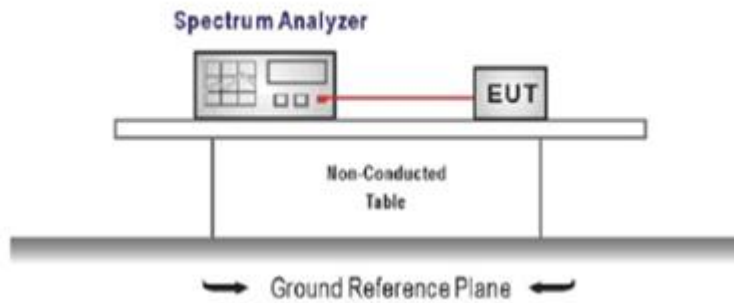

TEST PROCEDURE

1. The transmitter output was connected to the spectrum analyzer through an attenuator, the path loss was compensated to the results for each measurement.
2. Set to the maximum power setting and enable the EUT transmit continuously
3. Use the following spectrum analyzer settings:
Span = zero span, centered on a hopping channel, RBW= 1 MHz, VBW \geq RBW
Sweep = as necessary to capture the entire dwell time per hopping channel,
Detector function = peak, Trace = max hold
4. Measure and record the results in the test report.

TEST MODE

Refer to the clause 4.3

TEST RESULTS

Passed Not Applicable

TEST DATA

Refer to the appendix report

5.9. Duty Cycle Correction Factor (DCCF)

LIMIT

N/A

TEST CONFIGURATION

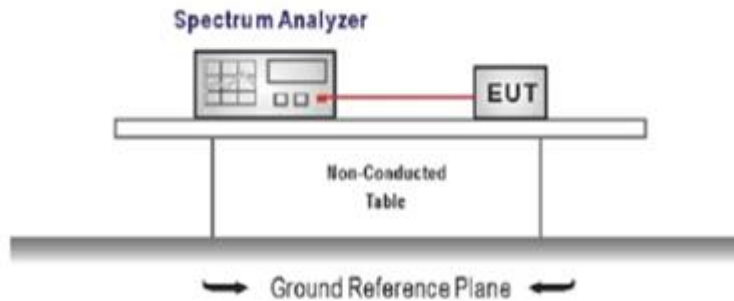

TEST PROCEDURE

1. The transmitter output was connected to the spectrum analyzer through an attenuator, the path loss was compensated to the results for each measurement.
2. Set to the maximum power setting and enable the EUT transmit continuously
3. Use the following spectrum analyzer settings:
Span = zero span, centered on a hopping channel, RBW= 1 MHz, VBW \geq RBW
Sweep = as necessary to capture the entire dwell time per hopping channel,
Detector function = peak, Trigger mode
4. Measure and record the duty cycle data

TEST MODE

Refer to the clause 4.3

TEST DATA

Refer to the appendix report

5.10. Pseudorandom Frequency Hopping Sequence

LIMIT

FCC CFR Title 47 Part 15 Subpart C Section 15.247 (a)(1):Frequency hopping systems shall have hopping channel carrier frequencies separated by a minimum of 25 kHz or the 20 dB bandwidth of the hopping channel, whichever is greater. Alternatively, frequency hopping systems operating in the 2400–2483.5 MHz band may have hopping channel carrier frequencies that are separated by 25 kHz or two-thirds of the 20 dB bandwidth of the hopping channel, whichever is greater, provided the systems operate with an output power no greater than 125 mW. The system shall hop to channel frequencies that are selected at the system hopping rate from a pseudo-randomly ordered list of hopping frequencies. Each frequency must be used equally on the average by each transmitter. The system receivers shall have input bandwidths that match the hopping channel bandwidths of their corresponding transmitters and shall shift frequencies in synchronization with the transmitted signals.

TEST RESULTS

The pseudorandom frequency hopping sequence may be generated in a nine-stage shift register whose 5th and 9th stage outputs are added in a modulo-two addition stage. And the result is fed back to the input of the first stage. The sequence begins with the first one of 9 consecutive ones, for example: the shift register is initialized with nine ones.

- Number of shift register stages: 9
- Length of pseudo-random sequence: $2^9 - 1 = 511$ bits
- Longest sequence of zeros: 8 (non-inverted signal)

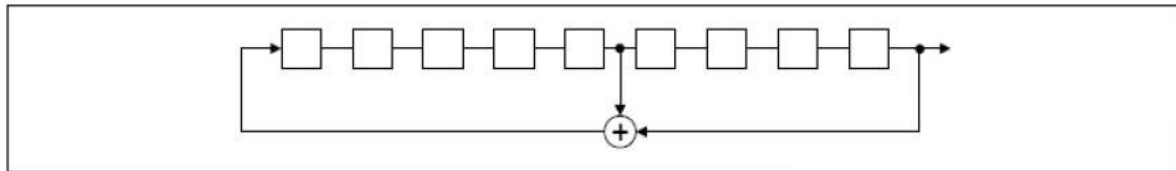

Linear Feedback Shift Register for Generation of the PRBS sequence

An example of pseudorandom frequency hopping sequence as follows:

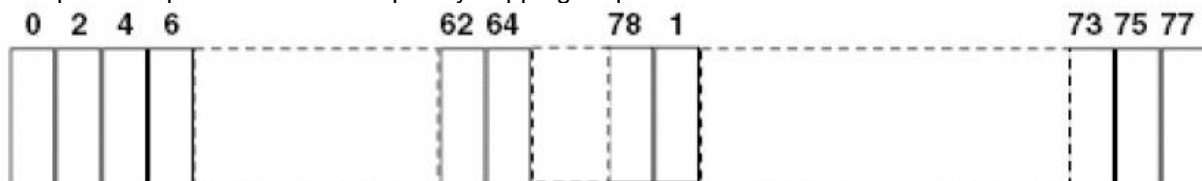

Each frequency used equally on the average by each transmitter. The system receiver has input bandwidths that match the hopping channel bandwidths of their corresponding transmitter and shifts frequencies in synchronization with the transmitted signals.

5.11. Conducted Band edge and Spurious Emission

LIMIT

FCC CFR Title 47 Part 15 Subpart C Section 15.247 (d): In any 100 kHz bandwidth outside the frequency band in which the spread spectrum intentional radiator is operating, the radio frequency power that is produced by the intentional radiator shall be at least 20 dB below that in the 100 kHz bandwidth within the band that contains the highest level of the desired power, based on either an RF conducted or a radiated measurement.

TEST CONFIGURATION

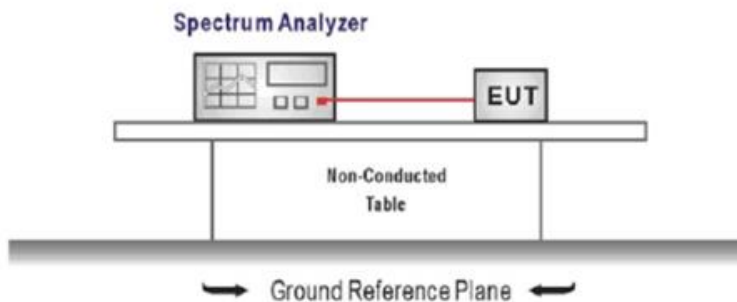

TEST PROCEDURE

1. Connect the antenna port(s) to the spectrum analyzer input.
2. Emission level measurement
Set the center frequency and span to encompass frequency range to be measured
RBW = 100 kHz, VBW \geq 3 x RBW
Detector = peak, Sweep time = auto couple, Trace mode = max hold
Allow trace to fully stabilize
Use the peak marker function to determine the maximum amplitude level.
3. Place the radio in continuous transmit mode, allow the trace to stabilize, view the transmitter waveform on the spectrum analyzer.
4. Ensure that the amplitude of all unwanted emission outside of the authorized frequency band excluding restricted frequency bands) are attenuated by at least the minimum requirements specified (at least 20 dB relative to the maximum in-band peak PSD level in 100 kHz). Report the three highest emission relative to the limit.

TEST MODE

Refer to the clause 4.3

TEST RESULT

Passed Not Applicable

TEST DATA

Refer to the appendix report

5.12. Radiated Band edge Emission

LIMIT

FCC CFR Title 47 Part 15 Subpart C Section 15.247 (d):

In any 100 kHz bandwidth outside the frequency band in which the spread spectrum or digitally modulated intentional radiator is operating, Radiated Emissions which fall in the restricted bands, as defined in §15.205(a), must also comply with the Radiated Emissions limits specified in §15.209(a) (see §15.205(c)).

TEST CONFIGURATION

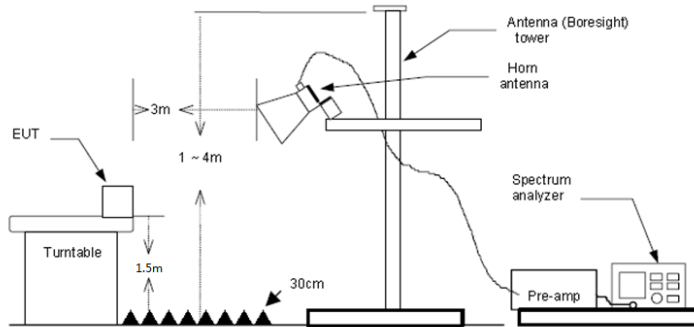

TEST PROCEDURE

1. The EUT was setup and tested according to ANSI C63.10 .
2. The EUT is placed on a turn table which is 1.5 meter above ground. The turn table is rotated 360 degrees to determine the position of the maximum emission level.
3. The EUT was positioned such that the distance from antenna to the EUT was 3 meters.
4. The antenna is scanned from 1 meter to 4 meters to find out the maximum emission level. This is repeated for both horizontal and vertical polarization of the antenna. In order to find the maximum emission, all of the interface cables were manipulated according to ANSI C63.10 on radiated measurement.
5. Use the following spectrum analyzer settings:
 - a) Span shall wide enough to fully capture the emission being measured
 - b) Set RBW=100kHz for <1GHz, VBW=3*RBW, Sweep time=auto, Detector=peak, Trace=max hold
 - c) Set RBW=1MHz, VBW=3MHz for >1GHz, Sweep time=auto, Detector=peak, Trace=max hold for Peak measurement

For average measurement: use duty cycle correction factor method (DCCF)
 Averager level = Peak level + DCCF

TEST MODE

Refer to the clause 4.3

TEST RESULT

Passed Not Applicable

Note:

- 1) Level= Reading + Factor; Factor =Antenna Factor+ Cable Loss- Preamp Factor
- 2) Over Limit = Level- Limit
- 3) Average measurement was not performed if peak level is lower than average limit(54 dBuV/m).

| Test channel: | | CH00 | | | Polarity | | | Horizontal | | |
|---------------|------------------|-------------------|---------------|-------------|--------------|-----------------|-----------------|---------------|--------|--|
| Mark | Frequency MHz | Reading dBuV/m | Antenna dB | Cable dB | Preamp dB | Level dBuV/m | Limit dBuV/m | Over limit | Remark | |
| 1 | 2310.00 | 47.28 | 27.86 | 4.01 | 41.80 | 37.35 | 74.00 | -36.65 | Peak | |
| 2 | 2390.03 | 46.97 | 27.54 | 4.31 | 41.80 | 37.02 | 74.00 | -36.98 | Peak | |

| Test channel: | | CH00 | | | Polarity | | | Vertical | | |
|---------------|------------------|-------------------|---------------|-------------|--------------|-----------------|-----------------|---------------|--------|--|
| Mark | Frequency MHz | Reading dBuV/m | Antenna dB | Cable dB | Preamp dB | Level dBuV/m | Limit dBuV/m | Over limit | Remark | |
| 1 | 2310.00 | 47.28 | 27.86 | 4.01 | 41.80 | 37.35 | 74.00 | -36.65 | Peak | |
| 2 | 2390.03 | 46.97 | 27.54 | 4.31 | 41.80 | 37.02 | 74.00 | -36.98 | Peak | |

| Test channel: | | CH78 | | | Polarity | | | Horizontal | | |
|---------------|------------------|-------------------|---------------|-------------|--------------|-----------------|-----------------|---------------|--------|--|
| Mark | Frequency MHz | Reading dBuV/m | Antenna dB | Cable dB | Preamp dB | Level dBuV/m | Limit dBuV/m | Over limit | Remark | |
| 1 | 2483.50 | 52.59 | 27.33 | 4.18 | 41.80 | 42.30 | 74.00 | -31.70 | Peak | |
| 2 | 2500.00 | 46.69 | 27.30 | 4.19 | 41.80 | 36.38 | 74.00 | -37.62 | Peak | |

| Test channel: | | CH78 | | | Polarity | | | Vertical | | |
|---------------|------------------|-------------------|---------------|-------------|--------------|-----------------|-----------------|---------------|--------|--|
| Mark | Frequency MHz | Reading dBuV/m | Antenna dB | Cable dB | Preamp dB | Level dBuV/m | Limit dBuV/m | Over limit | Remark | |
| 1 | 2483.50 | 49.14 | 27.33 | 4.18 | 41.80 | 38.85 | 74.00 | -35.15 | Peak | |
| 2 | 2500.00 | 47.14 | 27.30 | 4.19 | 41.80 | 36.83 | 74.00 | -37.17 | Peak | |

5.13. Radiated Spurious Emission

LIMIT

FCC CFR Title 47 Part 15 Subpart C Section 15.209

| Frequency | Limit (dBuV/m) | Value |
|----------------------|-------------------|------------|
| 0.009 MHz ~0.49 MHz | 2400/F(kHz) @300m | Quasi-peak |
| 0.49 MHz ~ 1.705 MHz | 24000/F(kHz) @30m | Quasi-peak |
| 1.705 MHz ~30 MHz | 30 @30m | Quasi-peak |

Note: Limit dBuV/m @3m = Limit dBuV/m @300m + 40*log(300/3)= Limit dBuV/m @300m +80,

Limit dBuV/m @3m = Limit dBuV/m @30m +40*log(30/3)= Limit dBuV/m @30m + 40.

| Frequency | Limit (dBuV/m @3m) | Value |
|---------------|--------------------|------------|
| 30MHz~88MHz | 40.00 | Quasi-peak |
| 88MHz~216MHz | 43.50 | Quasi-peak |
| 216MHz~960MHz | 46.00 | Quasi-peak |
| 960MHz~1GHz | 54.00 | Quasi-peak |
| Above 1GHz | 54.00 | Average |
| | 74.00 | Peak |

TEST CONFIGURATION

- 9 kHz ~ 30 MHz

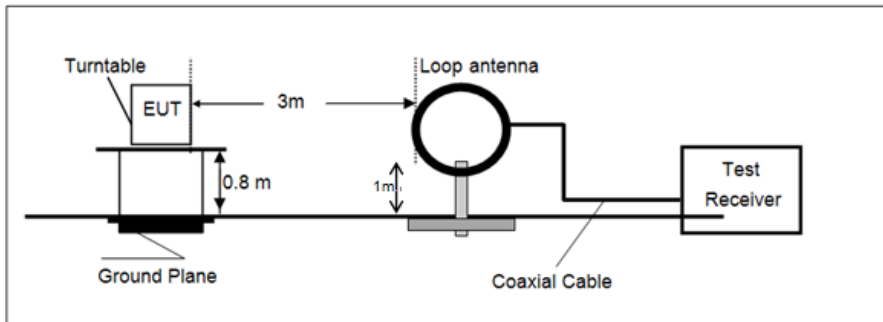

- 30 MHz ~ 1 GHz

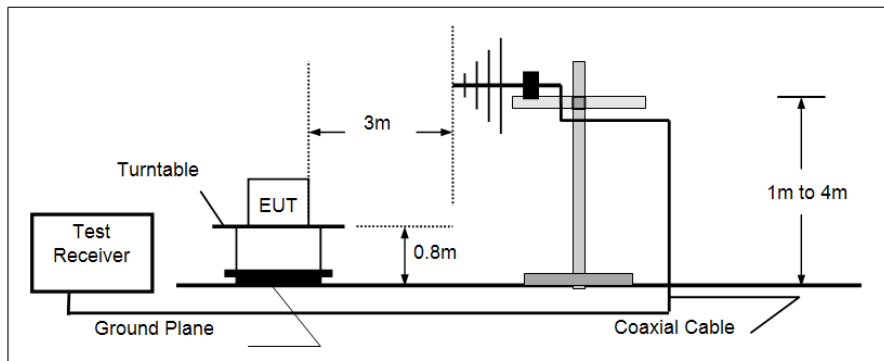

- Above 1 GHz

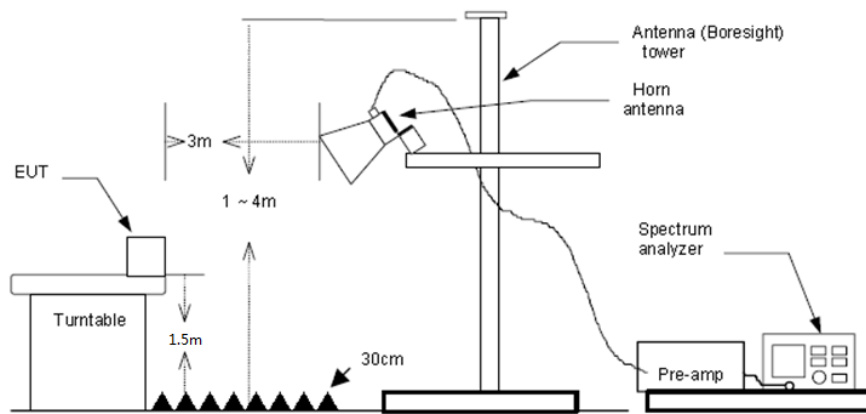

TEST PROCEDURE

1. The EUT was setup and tested according to ANSI C63.10.
2. The EUT is placed on a turn table which is 0.8 meter above ground for below 1 GHz, and 1.5 m for above 1 GHz. The turn table is rotated 360 degrees to determine the position of the maximum emission level.
3. The EUT was set 3 meters from the receiving antenna, which was mounted on the top of a variable height antenna tower.
4. For each suspected emission, the EUT was arranged to its worst case and then tune the Antenna tower (from 1 m to 4 m) and turntable (from 0 degree to 360 degrees) to find the maximum reading. A pre-amp and a high pass filter are used for the test in order to get better signal level to comply with the guidelines.
5. Set to the maximum power setting and enable the EUT transmit continuously.
6. Use the following spectrum analyzer settings
 - a) Span shall wide enough to fully capture the emission being measured;
 - b) Below 1 GHz:
 - RBW=120 kHz, VBW=300 kHz, Sweep=auto, Detector function=peak, Trace=max hold;
 - If the emission level of the EUT measured by the peak detector is 3 dB lower than the applicable limit, the peak emission level will be reported. Otherwise, the emission measurement will be repeated using the quasi-peak detector and reported.
 - c) Set RBW=1MHz, VBW=3MHz for >1GHz, Sweep time=auto, Detector=peak, Trace=max hold for Peak measurement
 - For average measurement: use duty cycle correction factor method (DCCF)
 - Averager level = Peak level + DCCF

TEST MODE

Refer to the clause 4.3

TEST RESULT

Passed **Not Applicable**

Note:

- 1) Level= Reading + Factor/Transd; Factor/Transd =Antenna Factor+ Cable Loss- Preamp Factor
- 2) Over Limit = Level- Limit
- 3) Average measurement was not performed if peak level is lower than average limit(54 dBuV/m) for above 1GHz.

For 9 kHz ~ 30 MHz

The EUT was pre-scanned this frequency band, found the radiated level 20dB lower than the limit, so don't show data on this report.

For 30 MHz ~ 1000 MHz

Have pre-scan all test channel, found **CH39** which it was worst case, so only show the worst case's data on this report.

Polarization:

Horizontal

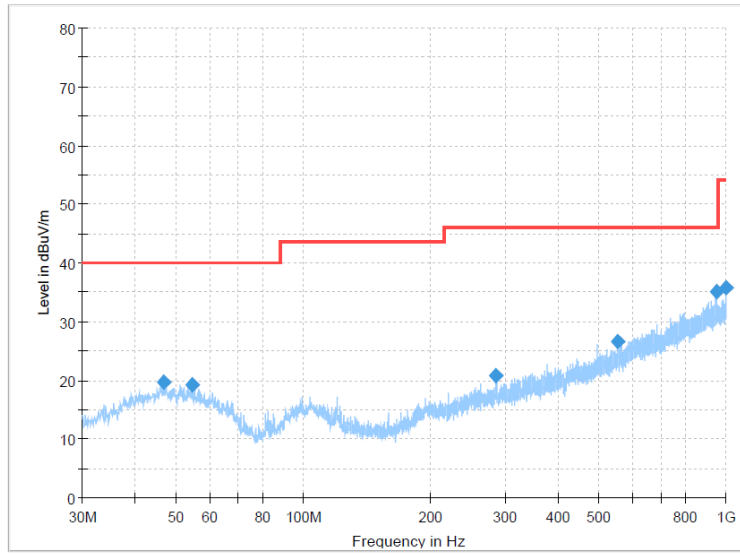

Final Result

| Frequency (MHz) | MaxPeak (dBuV/m) | Limit (dBuV/m) | Margin (dB) | Height (cm) | Pol | Azimuth (deg) | Corr. (dB/m) |
|-----------------|------------------|----------------|-------------|-------------|-----|---------------|--------------|
| 46.8538 | 19.60 | 40.00 | 20.40 | 100.0 | H | 0.0 | -8.8 |
| 54.6138 | 19.26 | 40.00 | 20.74 | 300.0 | H | 11.0 | -9.1 |
| 285.8375 | 20.85 | 46.00 | 25.15 | 300.0 | H | 326.0 | -7.8 |
| 554.8913 | 26.53 | 46.00 | 19.47 | 100.0 | H | 291.0 | -0.8 |
| 947.2563 | 35.10 | 46.00 | 10.90 | 300.0 | H | 319.0 | 7.1 |
| 996.4838 | 35.75 | 54.00 | 18.25 | 100.0 | H | 20.0 | 7.9 |

Polarization:

Vertical

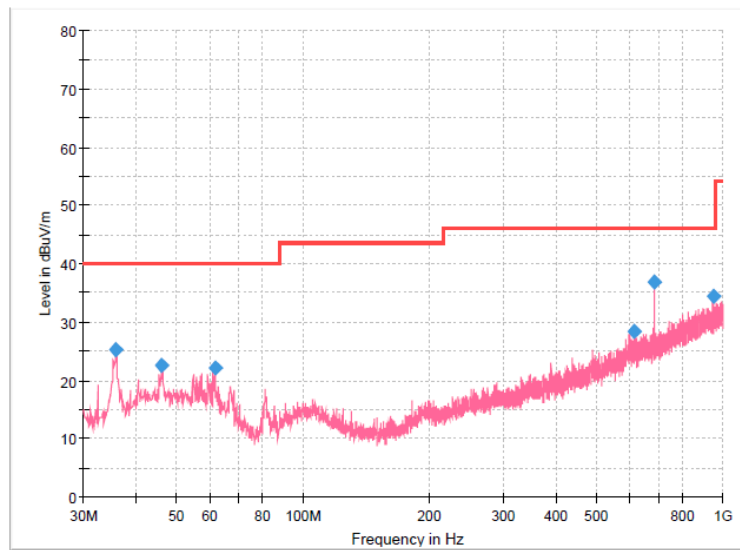

Final Result

| Frequency (MHz) | MaxPeak (dBuV/m) | Limit (dBuV/m) | Margin (dB) | Height (cm) | Pol | Azimuth (deg) | Corr. (dB/m) |
|-----------------|------------------|----------------|-------------|-------------|-----|---------------|--------------|
| 35.9413 | 25.31 | 40.00 | 14.69 | 100.0 | V | 81.0 | -11.4 |
| 46.1263 | 22.48 | 40.00 | 17.52 | 100.0 | V | 334.0 | -8.8 |
| 61.6463 | 22.05 | 40.00 | 17.95 | 100.0 | V | 58.0 | -10.4 |
| 615.8800 | 28.48 | 46.00 | 17.52 | 100.0 | V | 144.0 | 1.3 |
| 687.5388 | 36.90 | 46.00 | 9.10 | 100.0 | V | 101.0 | 2.1 |
| 946.6500 | 34.35 | 46.00 | 11.65 | 100.0 | V | 144.0 | 7.1 |

For 1 GHz ~ 25 GHz

| Test channel | | CH00 | | | Polarity | | Horizontal | | |
|--------------|------------------|-------------------|---------------|-------------|--------------|-----------------|-----------------|---------------|--------|
| Mark | Frequency MHz | Reading dBuV/m | Antenna dB | Cable dB | Preamp dB | Level dBuV/m | Limit dBuV/m | Over limit | Remark |
| 1 | 3151.99 | 44.74 | 28.90 | 4.70 | 41.60 | 36.74 | 74.00 | -37.26 | Peak |
| 2 | 5204.40 | 42.65 | 31.58 | 6.31 | 41.02 | 39.52 | 74.00 | -34.48 | Peak |
| 3 | 8083.96 | 41.85 | 37.00 | 8.13 | 40.64 | 46.34 | 74.00 | -27.66 | Peak |
| 4 | 11574.46 | 41.52 | 40.35 | 10.41 | 42.30 | 49.98 | 74.00 | -24.02 | Peak |

| Test channel | | CH00 | | | Polarity | | Vertical | | |
|--------------|------------------|-------------------|---------------|-------------|--------------|-----------------|-----------------|---------------|--------|
| Mark | Frequency MHz | Reading dBuV/m | Antenna dB | Cable dB | Preamp dB | Level dBuV/m | Limit dBuV/m | Over limit | Remark |
| 1 | 3489.84 | 43.90 | 28.94 | 5.04 | 41.60 | 36.28 | 74.00 | -37.72 | Peak |
| 2 | 5462.30 | 41.18 | 31.80 | 6.60 | 40.84 | 38.74 | 74.00 | -35.26 | Peak |
| 3 | 8042.90 | 41.53 | 37.00 | 8.19 | 40.72 | 46.00 | 74.00 | -28.00 | Peak |
| 4 | 11486.41 | 41.10 | 40.49 | 10.35 | 42.30 | 49.64 | 74.00 | -24.36 | Peak |

| Test channel | | CH39 | | | Polarity | | Horizontal | | |
|--------------|------------------|-------------------|---------------|-------------|--------------|-----------------|-----------------|---------------|--------|
| Mark | Frequency MHz | Reading dBuV/m | Antenna dB | Cable dB | Preamp dB | Level dBuV/m | Limit dBuV/m | Over limit | Remark |
| 1 | 2972.75 | 45.23 | 28.50 | 4.72 | 41.67 | 36.78 | 74.00 | -37.22 | Peak |
| 2 | 5703.86 | 42.13 | 31.81 | 6.63 | 40.73 | 39.84 | 74.00 | -34.16 | Peak |
| 3 | 8083.96 | 41.85 | 37.00 | 8.13 | 40.64 | 46.34 | 74.00 | -27.66 | Peak |
| 4 | 11574.46 | 41.52 | 40.35 | 10.41 | 42.30 | 49.98 | 74.00 | -24.02 | Peak |

| Test channel | | CH39 | | | Polarity | | Vertical | | |
|--------------|------------------|-------------------|---------------|-------------|--------------|-----------------|-----------------|---------------|--------|
| Mark | Frequency MHz | Reading dBuV/m | Antenna dB | Cable dB | Preamp dB | Level dBuV/m | Limit dBuV/m | Over limit | Remark |
| 1 | 2995.54 | 44.72 | 28.50 | 4.75 | 41.65 | 36.32 | 74.00 | -37.68 | Peak |
| 2 | 5588.88 | 40.43 | 31.62 | 6.58 | 40.77 | 37.86 | 74.00 | -36.14 | Peak |
| 3 | 8527.85 | 40.85 | 37.26 | 8.51 | 41.61 | 45.01 | 74.00 | -28.99 | Peak |
| 4 | 11515.68 | 41.02 | 40.47 | 10.37 | 42.30 | 49.56 | 74.00 | -24.44 | Peak |

| Test channel | | CH78 | | | Polarity | | Horizontal | | |
|--------------|------------------|-------------------|---------------|-------------|--------------|-----------------|-----------------|---------------|--------|
| Mark | Frequency MHz | Reading dBuV/m | Antenna dB | Cable dB | Preamp dB | Level dBuV/m | Limit dBuV/m | Over limit | Remark |
| 1 | 3913.39 | 41.36 | 29.70 | 5.32 | 41.50 | 34.88 | 74.00 | -39.12 | Peak |
| 2 | 5448.41 | 40.66 | 31.79 | 6.59 | 40.85 | 38.19 | 74.00 | -35.81 | Peak |
| 3 | 8022.46 | 39.89 | 37.00 | 8.07 | 40.76 | 44.20 | 74.00 | -29.80 | Peak |
| 4 | 11545.04 | 39.79 | 40.41 | 10.39 | 42.30 | 48.29 | 74.00 | -25.71 | Peak |

| Test channel | | CH78 | | | Polarity | | Vertical | | |
|--------------|------------------|-------------------|---------------|-------------|--------------|-----------------|-----------------|---------------|--------|
| Mark | Frequency MHz | Reading dBuV/m | Antenna dB | Cable dB | Preamp dB | Level dBuV/m | Limit dBuV/m | Over limit | Remark |
| 1 | 3854.08 | 42.07 | 29.61 | 5.35 | 41.54 | 35.49 | 74.00 | -38.51 | Peak |
| 2 | 5204.40 | 41.09 | 31.58 | 6.31 | 41.02 | 37.96 | 74.00 | -36.04 | Peak |
| 3 | 8083.96 | 40.25 | 37.00 | 8.13 | 40.64 | 44.74 | 74.00 | -29.26 | Peak |
| 4 | 10534.09 | 39.65 | 40.00 | 9.77 | 41.04 | 48.38 | 74.00 | -25.62 | Peak |

6. TEST SETUP PHOTOS

Radiated Emission

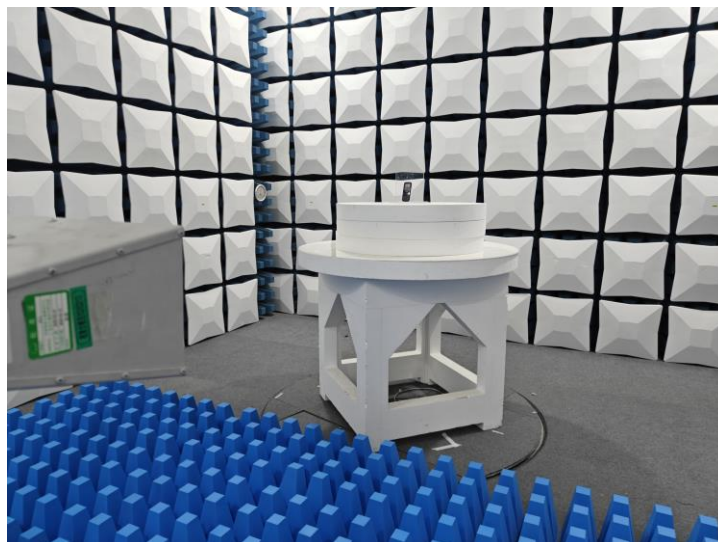
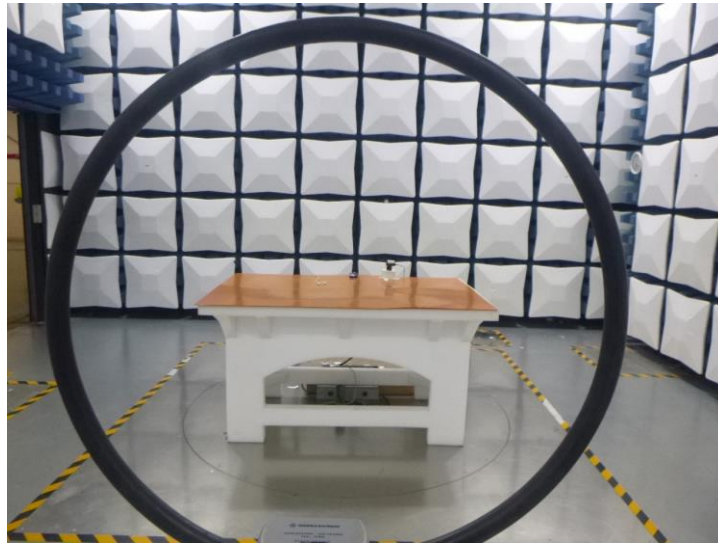

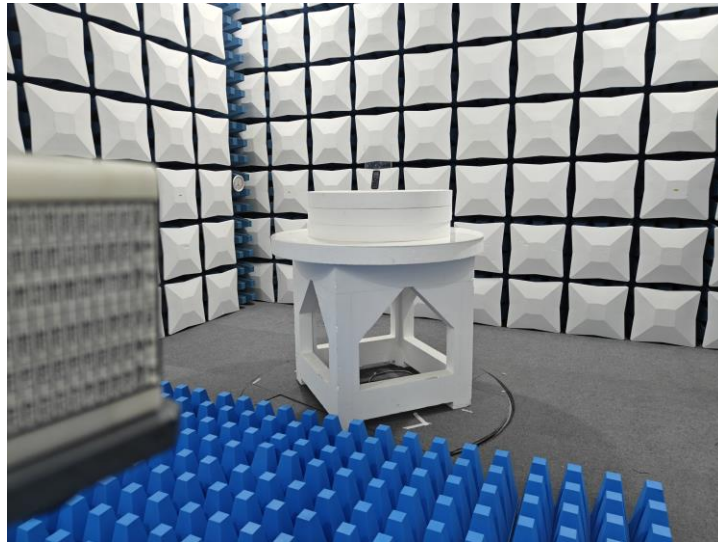

AC Conducted Emission



7. EXTERNAL AND INTERNAL PHOTOS

Refer to the test report No.: CHTW24030032

8. APPENDIX REPORT