

FCC TEST REPORT

FCC ID: 2ASVQ-W009

Report Number. : ZKT-220707L4649

Date of Test : Jul. 01, 2022 -- Jul. 15, 2022

Date of issue : Jul. 15, 2022

Total number of pages..... : 69

Test Result : PASS

Testing Laboratory..... : Shenzhen ZKT Technology Co., Ltd.

Address : 1/F, No. 101, Building B, No. 6, Tangwei Community Industrial Avenue, Fuhai Street, Bao'an District, Shenzhen, China

Applicant's name : MAYFLASH LIMITED

Address : 3/F, Buiding No.1, TingWei Industrial Park, LiuFang Rd, No.67, BaoAn, Shenzhen,China

Manufacturer's name : MAYFLASH LIMITED

Address : 3/F, Buiding No.1, TingWei Industrial Park, LiuFang Rd, No.67, BaoAn, Shenzhen,China

Test specification:

Standard : FCC CFR Title 47 Part 15 Subpart C Section 15.247
ANSI C63.10:2013

Test procedure..... : /
KDB558074 D0115.247 Meas Guidance v 05r02

Non-standard test method : N/A

Test Report Form No. : TRF-EL-112_V0

Test Report Form(s) Originator : ZKT Testing

Master TRF : Dated: 2020-01-06

This device described above has been tested by ZKT, and the test results show that the equipment under test (EUT) is in compliance with the FCC requirements. And it is applicable only to the tested sample identified in the report.

This report shall not be reproduced except in full, without the written approval of ZKT, this document may be altered or revised by ZKT, personal only, and shall be noted in the revision of the document.

Product name..... : W009

Trademark : /

Model/Type reference..... : W009

Ratings..... : DC 5.0V from adapter or others

Testing procedure and testing location:

Testing Laboratory: **Shenzhen ZKT Technology Co., Ltd.**

Address

1/F, No. 101, Building B, No. 6, Tangwei Community
Industrial Avenue, Fuhai Street, Bao'an District,
Shenzhen, China

Tested by (name + signature).....: Alen He

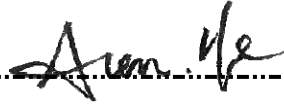

Reviewer (name + signature).....: Joe Liu



Approved (name + signature): Lake Xie



Table of Contents

| | Page |
|---|-----------|
| 1. VERSION | 5 |
| 2. TEST SUMMARY | 6 |
| 2.1 TEST FACILITY | 6 |
| 2.2 MEASUREMENT UNCERTAINTY | 7 |
| 3. GENERAL INFORMATION | 8 |
| 3.1 GENERAL DESCRIPTION OF EUT | 8 |
| 3.2 Test Setup Configuration | 9 |
| 3.3 Support Equipment | 9 |
| 3.4 Test Mode | 10 |
| 3.5 EQUIPMENTS LIST FOR ALL TEST ITEMS | 11 |
| 4. EMC EMISSION TEST | 12 |
| 4.1 Conducted emissions | 12 |
| 4.1.1 POWER LINE CONDUCTED EMISSION Limits | 12 |
| 4.1.2 TEST PROCEDURE | 12 |
| 4.1.3 DEVIATION FROM TEST STANDARD | 12 |
| 4.1.4 TEST SETUP | 13 |
| 4.1.5 EUT OPERATING CONDITIONS | 13 |
| 4.1.6 Test Result | 13 |
| 4.2 Radiated emissions | 16 |
| 4.2.1 Radiated Emission Limits | 16 |
| 4.2.2 TEST PROCEDURE | 16 |
| 4.2.3 DEVIATION FROM TEST STANDARD | 17 |
| 4.2.4 TEST SETUP | 17 |
| 4.2.5 EUT OPERATING CONDITIONS | 18 |
| 4.2.6 TEST RESULTS | 19 |
| 5. RADIATED BAND EMISSION MEASUREMENT | 26 |
| 5.1 Test Requirement: | 26 |
| 5.2 TEST PROCEDURE | 26 |
| 5.3 DEVIATION FROM TEST STANDARD | 27 |
| 5.4 TEST SETUP | 27 |
| 5.5 EUT OPERATING CONDITIONS | 27 |
| 5.6 TEST RESULT | 28 |
| 6. CONDUCTED BAND EDGE AND SPURIOUS EMISSION | 30 |
| 6.1 Limit | 30 |
| 6.2 Test Setup | 30 |
| 6.3 Test procedure | 30 |
| 6.4 DEVIATION FROM STANDARD | 30 |
| 6.5 Test Result | 30 |
| 7. 20DB BANDWIDTH | 46 |
| 7.1 Test Setup | 46 |
| 7.2 Limit | 46 |
| 7.3 Test procedure | 46 |
| 7.4 DEVIATION FROM STANDARD | 46 |
| 7.5 Test Result | 46 |
| 8. MAXIMUM PEAK OUTPUT POWER | 50 |
| 8.1 Block Diagram Of Test Setup | 50 |
| 8.2 Limit | 50 |

| | |
|--|-----------|
| 8.3 Test procedure | 50 |
| 8.4 DEVIATION FROM STANDARD | 50 |
| 8.5 Test Result | 50 |
| 9.1 Test Setup | 51 |
| 9.2 Test procedure | 51 |
| 9.3 DEVIATION FROM STANDARD | 51 |
| 9.4 Test Result | 51 |
| 10. NUMBER OF HOPPING FREQUENCY | 55 |
| 10.1 Test Setup | 55 |
| 10.2 Test procedure | 55 |
| 10.3 DEVIATION FROM STANDARD | 55 |
| 10.4 Test Result | 56 |
| 11. DWELL TIME | 58 |
| 11.1 Test Setup | 58 |
| 11.2 Test procedure | 58 |
| 11.3 DEVIATION FROM STANDARD | 58 |
| 11.4 Test Result | 59 |
| 12. ANTENNA REQUIREMENT | 63 |
| 13. TEST SETUP PHOTO | 64 |
| 14. EUT CONSTRUCTIONAL DETAILS | 66 |

1. VERSION

| Report No. | Version | Description | Approved |
|-----------------|---------|-------------------------|---------------|
| ZKT-220707L4649 | Rev.01 | Initial issue of report | Jul. 15, 2022 |
| | | | |
| | | | |

2. TEST SUMMARY

Test procedures according to the technical standards:

| FCC Part15 (15.247) , Subpart C | | | |
|---------------------------------|----------------------------------|--------|--------|
| Standard Section | Test Item | Result | Remark |
| 15.203/15.247 (c) | Antenna Requirement | PASS | |
| 15.207 | AC Power Line Conducted Emission | PASS | |
| 15.247 (b)(1) | Conducted Peak Output Power | PASS | |
| 15.247 (a)(1) | 20dB Occupied Bandwidth | PASS | |
| 15.247 (a)(1) | Carrier Frequencies Separation | PASS | |
| 15.247 (a)(1)(iii) | Hopping Channel Number | PASS | |
| 15.247 (a)(1)(iii) | Dwell Time | PASS | |
| 15.205/15.209 | Radiated Emission | PASS | |
| 15.247(d) | Band Edge | PASS | |

NOTE:

(1) "N/A" denotes test is not applicable in this Test Report

2.1 TEST FACILITY

Shenzhen ZKT Technology Co., Ltd.
Add. : 1/F, No. 101, Building B, No. 6, Tangwei Community Industrial Avenue, Fuhai Street,
Bao'an District, Shenzhen, China

FCC Test Firm Registration Number: 692225
Designation Number: CN1299
IC Registered No.: 27033

2.2 MEASUREMENT UNCERTAINTY

The reported uncertainty of measurement $y \pm U$, where expanded uncertainty U is based on a standard uncertainty multiplied by a coverage factor of $k=2$, providing a level of confidence of approximately 95%.

| No. | Item | Uncertainty |
|-----|------------------------------|---------------------|
| 1 | Conducted Emission Test | $\pm 1.38\text{dB}$ |
| 2 | RF power conducted | $\pm 0.16\text{dB}$ |
| 3 | Spurious emissions conducted | $\pm 0.21\text{dB}$ |
| 4 | All emissions radiated(<1G) | $\pm 4.68\text{dB}$ |
| 5 | All emissions radiated(>1G) | $\pm 4.89\text{dB}$ |
| 6 | Temperature | $\pm 0.5\text{C}$ |
| 7 | Humidity | $\pm 2\%$ |

3. GENERAL INFORMATION

3.1 GENERAL DESCRIPTION OF EUT

| | |
|------------------------|--------------------------------|
| Product Name: | W009 |
| Model No.: | W009 |
| Serial No.: | / |
| Hardware Version: | V1.03 |
| Software Version: | V1.2 |
| Sample(s) Status: | Engineer sample |
| Channel numbers: | 79 |
| Channel separation: | 2402MHz~2480MHz |
| Modulation technology: | GFSK, $\pi/4$ DQPSK, 8DPSK |
| Antenna Type: | PCB antenna |
| Antenna gain: | 0 dBi |
| Power supply: | DC 5.0V from adapter or others |

| Operation Frequency each of channel | | | | | | | |
|-------------------------------------|-----------|---------|-----------|---------|-----------|---------|-----------|
| Channel | Frequency | Channel | Frequency | Channel | Frequency | Channel | Frequency |
| 1 | 2402MHz | 21 | 2422MHz | 41 | 2442MHz | 61 | 2462MHz |
| 2 | 2403MHz | 22 | 2423MHz | 42 | 2443MHz | 62 | 2463MHz |
| 3 | 2404MHz | 23 | 2424MHz | 43 | 2444MHz | 63 | 2464MHz |
| 4 | 2405MHz | 24 | 2425MHz | 44 | 2445MHz | 64 | 2465MHz |
| 5 | 2406MHz | 25 | 2426MHz | 45 | 2446MHz | 65 | 2466MHz |
| 6 | 2407MHz | 26 | 2427MHz | 46 | 2447MHz | 66 | 2467MHz |
| 7 | 2408MHz | 27 | 2428MHz | 47 | 2448MHz | 67 | 2468MHz |
| 8 | 2409MHz | 28 | 2429MHz | 48 | 2449MHz | 68 | 2469MHz |
| 9 | 2410MHz | 29 | 2430MHz | 49 | 2450MHz | 69 | 2470MHz |
| 10 | 2411MHz | 30 | 2431MHz | 50 | 2451MHz | 70 | 2471MHz |
| 11 | 2412MHz | 31 | 2432MHz | 51 | 2452MHz | 71 | 2472MHz |
| 12 | 2413MHz | 32 | 2433MHz | 52 | 2453MHz | 72 | 2473MHz |
| 13 | 2414MHz | 33 | 2434MHz | 53 | 2454MHz | 73 | 2474MHz |
| 14 | 2415MHz | 34 | 2435MHz | 54 | 2455MHz | 74 | 2475MHz |
| 15 | 2416MHz | 35 | 2436MHz | 55 | 2456MHz | 75 | 2476MHz |
| 16 | 2417MHz | 36 | 2437MHz | 56 | 2457MHz | 76 | 2477MHz |
| 17 | 2418MHz | 37 | 2438MHz | 57 | 2458MHz | 77 | 2478MHz |
| 18 | 2419MHz | 38 | 2439MHz | 58 | 2459MHz | 78 | 2479MHz |
| 19 | 2420MHz | 39 | 2440MHz | 59 | 2460MHz | 79 | 2480MHz |
| 20 | 2421MHz | 40 | 2441MHz | 60 | 2461MHz | | |

Note:

In section 15.31(m), regards to the operating frequency range over 10 MHz, the Lowest frequency, the middle frequency, and the highest frequency of channel were selected to perform the test, and the selected channel see below:

| Test channel | Frequency |
|---------------------|-----------|
| The lowest channel | 2402MHz |
| The middle channel | 2441MHz |
| The Highest channel | 2480MHz |

3.2 Test Setup Configuration

Conducted Emission

adapter

| |
|-----|
| EUT |
|-----|

Radiated Emission

adapter

| |
|-----|
| EUT |
|-----|

Conducted Spurious

adapter

| |
|-----|
| EUT |
|-----|

3.3 Support Equipment

The EUT has been tested as an independent unit together with other necessary accessories or support units. The following support units or accessories were used to form a representative test configuration during the tests.

| Item | Equipment | Mfr/Brand | Model/Type No. | Series No. | Note |
|------|-----------|-----------|----------------|------------|----------------|
| 1 | Adapter | HUAWEI | HW-100400C01 | / | Provide by lab |
| | | | | | |
| | | | | | |

| Item | Shielded Type | Ferrite Core | Length | Note |
|------|---------------|--------------|--------|------|
| | | | | |
| | | | | |
| | | | | |

Note:

- (1) The support equipment was authorized by Declaration of Confirmation.
- (2) For detachable type I/O cable should be specified the length in cm in 『Length』 column.

3.4 Test Mode

| | |
|--|---|
| Transmitting mode | Keep the EUT in continuously transmitting mode. |
| <p>Remark: During the test, the test voltage was tuned from 85% to 115% of the nominal rated supply voltage, and found that the worst case was under the nominal rated supply condition. So the report just shows that condition's data.</p> | |

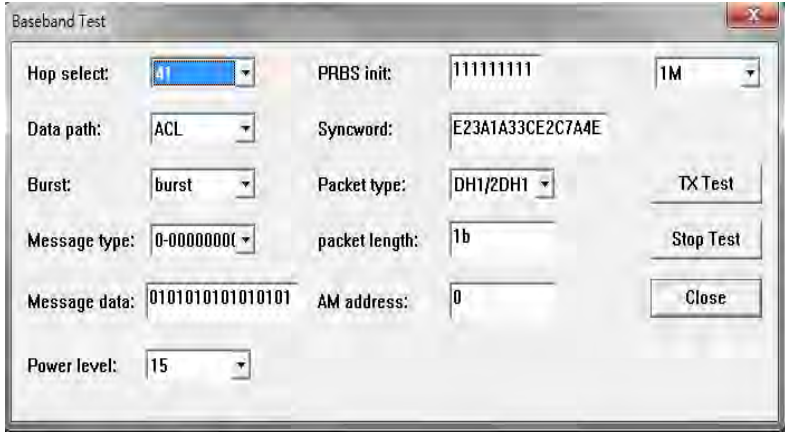
| | |
|-------------------|---|
| Test Software | <p>BT Test Tool</p>  |
| Power level setup | <10dBm |

3.5 EQUIPMENTS LIST FOR ALL TEST ITEMS

Radiation Test equipment

| Item | Equipment | Manufacturer | Type No. | Serial No. | Last calibration | Calibrated until |
|------|----------------------------------|----------------|-----------------|------------|------------------|------------------|
| 1 | Spectrum Analyzer (9kHz-26.5GHz) | KEYSIGHT | 9020A | MY45109572 | Sep. 21, 2021 | Sep. 22, 2022 |
| 2 | Spectrum Analyzer (1GHz-40GHz) | Agilent | E4446A | 100363 | Sep. 21, 2021 | Sep. 22, 2022 |
| 3 | Test Receiver (9kHz-7GHz) | R&S | ESC17 | 101169 | Sep. 21, 2021 | Sep. 22, 2022 |
| 4 | Bilog Antenna (30MHz-1400MHz) | Schwarzbeck | VULB9168 | 00877 | Sep. 21, 2021 | Sep. 22, 2022 |
| 5 | Horn Antenna (1GHz-18GHz) | SCHWARZBECK | BBHA9120D | 1541 | Sep. 21, 2021 | Sep. 22, 2022 |
| 6 | Horn Antenna (18GHz-40GHz) | A.H. System | SAS-574 | 588 | Sep. 21, 2021 | Sep. 22, 2022 |
| 7 | Amplifier (30-1000MHz) | EM Electronics | EM330 Amplifier | N/A | Sep. 21, 2021 | Sep. 22, 2022 |
| 8 | Amplifier (1GHz-40GHz) | QUANJUDA | DLE-161 | 097 | Sep. 21, 2021 | Sep. 22, 2022 |
| 9 | Loop Antenna (9kHz-30MHz) | SCHWARZBECK | FMZB1519B | 014 | Sep. 21, 2021 | Sep. 22, 2022 |
| 10 | RF cables1 (9kHz-30MHz) | N/A | 9kHz-30MHz | N/A | Sep. 21, 2021 | Sep. 22, 2022 |
| 11 | RF cables2 (30MHz-1GHz) | N/A | 30MHz-1GHz | N/A | Sep. 21, 2021 | Sep. 22, 2022 |
| 12 | RF cables3 (1GHz-40GHz) | N/A | 1GHz-40GHz | N/A | Sep. 21, 2021 | Sep. 22, 2022 |
| 13 | CMW500 Test | R&S | CMW500 | 106504 | Sep. 21, 2021 | Sep. 22, 2022 |
| 14 | ESG Signal Generator | Agilent | E4421B | GB40051203 | Sep. 21, 2021 | Sep. 22, 2022 |
| 15 | Signal Generator | Agilent | N5182A | MY47420215 | Sep. 21, 2021 | Sep. 22, 2022 |
| 16 | D.C. Power Supply | LongWei | TPR-6405D | \ | \ | \ |
| 17 | Software | Frad | EZ-EMC | FA-03A2 RE | \ | \ |

Conduction Test equipment

| Item | Kind of Equipment | Manufacturer | Type No. | Serial No. | Last calibration | Calibrated until |
|------|-------------------|--------------|----------|-------------|------------------|------------------|
| 1 | LISN | R&S | ENV216 | 101471 | Sep. 21, 2021 | Sep. 22, 2022 |
| 2 | LISN | CYBERTEK | EM5040A | E1850400149 | Sep. 21, 2021 | Sep. 22, 2022 |
| 3 | Test Cable | N/A | C01 | N/A | Sep. 21, 2021 | Sep. 22, 2022 |
| 4 | Test Cable | N/A | C02 | N/A | Sep. 21, 2021 | Sep. 22, 2022 |
| 5 | EMI Test Receiver | R&S | ESRP3 | 101946 | Sep. 21, 2021 | Sep. 22, 2022 |
| 6 | Absorbing Clamp | DZ | ZN23201 | N/A | Sep. 21, 2021 | Sep. 22, 2022 |

4. EMC EMISSION TEST

4.1 Conducted emissions

| | |
|-----------------------|--------------------------------------|
| Test Requirement: | FCC Part15 C Section 15.207 |
| Test Method: | ANSI C63.10:2013 |
| Test Frequency Range: | 150KHz to 30MHz |
| Receiver setup: | RBW=9KHz, VBW=30KHz, Sweep time=auto |

4.1.1 POWER LINE CONDUCTED EMISSION Limits

| FREQUENCY (MHz) | Limit (dBuV) | | Standard |
|-----------------|--------------|-----------|----------|
| | Quasi-peak | Average | |
| 0.15 -0.5 | 66 - 56 * | 56 - 46 * | FCC |
| 0.50 -5.0 | 56.00 | 46.00 | FCC |
| 5.0 -30.0 | 60.00 | 50.00 | FCC |

Note:

(1) *Decreases with the logarithm of the frequency.

4.1.2 TEST PROCEDURE

- a. The EUT was placed 0.1 meters from the horizontal ground plane with EUT being connected to the power mains through a line impedance stabilization network (LISN). All other support equipments powered from additional LISN(s). The LISN provide 50 Ohm/ 50uH of coupling impedance for the measuring instrument.
- b. Interconnecting cables that hang closer than 40 cm to the ground plane shall be folded back and forth in the center forming a bundle 30 to 40 cm long.
- c. I/O cables that are not connected to a peripheral shall be bundled in the center. The end of the cable may be terminated, if required, using the correct terminating impedance. The overall length shall not exceed 1 m.
- d. LISN at least 80 cm from nearest part of EUT chassis.
- e. For the actual test configuration, please refer to the related Item –EUT Test Photos.

4.1.3 DEVIATION FROM TEST STANDARD

No deviation

4.1.4 TEST SETUP

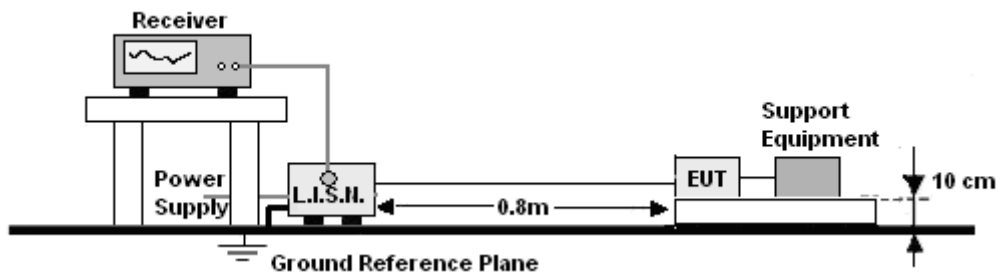

4.1.5 EUT OPERATING CONDITIONS

The EUT was configured for testing in a typical fashion (as a customer would normally use it). The EUT has been programmed to continuously transmit during test. This operating condition was tested and used to collect the included data.

4.1.6 Test Result

| | | | |
|----------------|--------------|---------------------|-----|
| Temperature : | 26°C | Relative Humidity : | 54% |
| Pressure : | 101kPa | Phase : | L |
| Test Voltage : | AC 120V/60Hz | | |

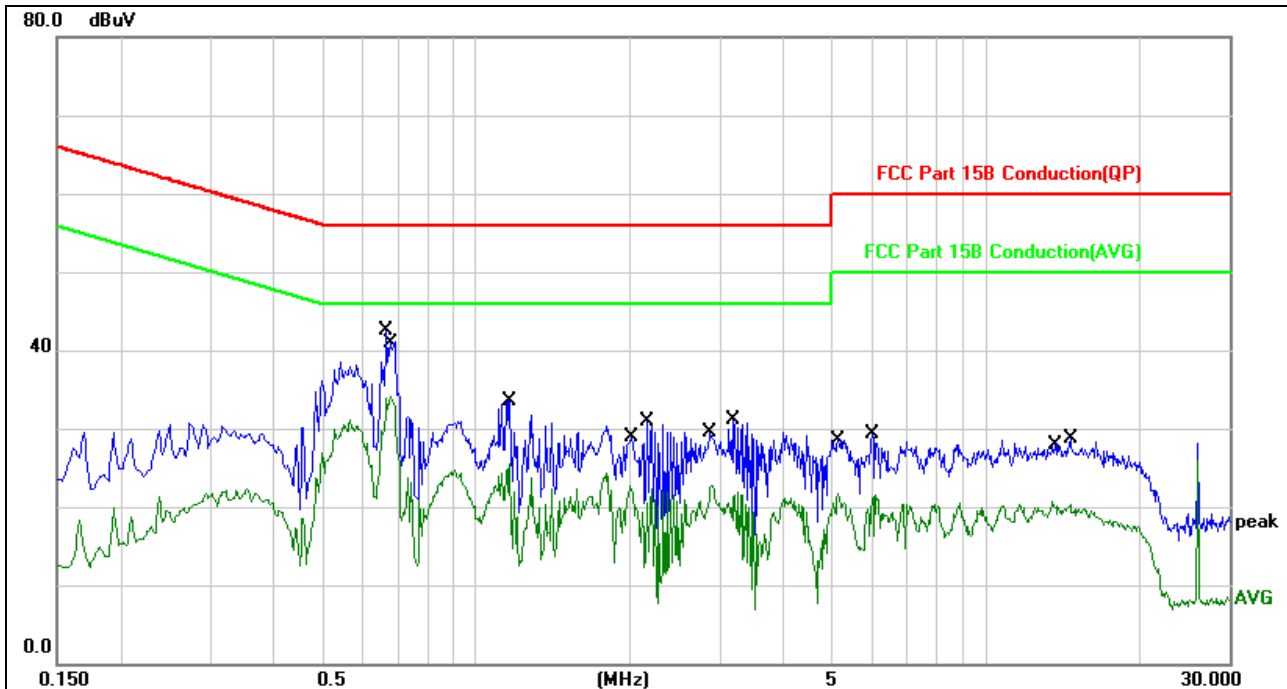

| No. | Mk. | Freq. MHz | Reading Level dBuV | Correct Factor dB | Measure- ment dBuV | Limit dBuV | Over dB | Detector | Comment |
|-----|-----|--------------|--------------------------|-------------------------|--------------------------|---------------|------------|----------|---------|
| 1 | | 0.6660 | 32.62 | 9.83 | 42.45 | 56.00 | -13.55 | QP | |
| 2 | * | 0.6820 | 24.24 | 9.82 | 34.06 | 46.00 | -11.94 | AVG | |
| 3 | | 1.1620 | 23.81 | 9.74 | 33.55 | 56.00 | -22.45 | QP | |
| 4 | | 1.1620 | 15.69 | 9.74 | 25.43 | 46.00 | -20.57 | AVG | |
| 5 | | 2.0020 | 13.09 | 9.65 | 22.74 | 46.00 | -23.28 | AVG | |
| 6 | | 2.1580 | 21.20 | 9.64 | 30.84 | 56.00 | -25.16 | QP | |
| 7 | | 2.9100 | 12.93 | 9.70 | 22.63 | 46.00 | -23.37 | AVG | |
| 8 | | 3.1780 | 21.48 | 9.70 | 31.18 | 56.00 | -24.82 | QP | |
| 9 | | 5.1260 | 12.03 | 9.66 | 21.69 | 50.00 | -28.31 | AVG | |
| 10 | | 5.9820 | 19.60 | 9.64 | 29.24 | 60.00 | -30.76 | QP | |
| 11 | | 13.5060 | 10.91 | 9.73 | 20.64 | 50.00 | -29.36 | AVG | |
| 12 | | 14.6660 | 18.94 | 9.68 | 28.62 | 60.00 | -31.38 | QP | |

Notes:

1. An initial pre-scan was performed on the line and neutral lines with peak detector.
2. Quasi-Peak and Average measurement were performed at the frequencies with maximized peak emission.
3. Measurement Level = Reading level + Correct Factor

| | | | |
|----------------|--------------|---------------------|-----|
| Temperature : | 26°C | Relative Humidity : | 54% |
| Pressure : | 101kPa | Phase : | N |
| Test Voltage : | AC 120V/60Hz | | |

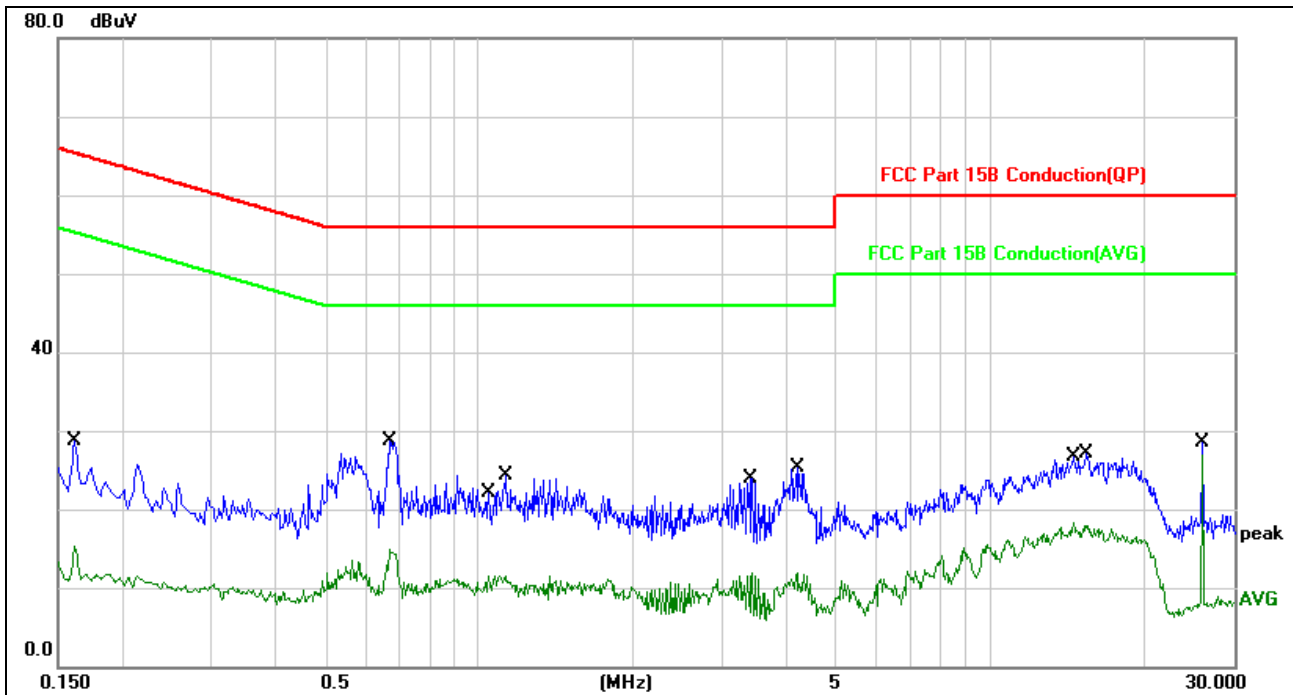

| No. | Mk. | Freq. MHz | Reading Level dBuV | Correct Factor dB | Measure- ment dBuV | Limit dBuV | Over dB | Detector | Comment |
|-----|-----|--------------|--------------------------|-------------------------|--------------------------|---------------|------------|----------|---------|
| 1 | | 0.1620 | 18.95 | 9.75 | 28.70 | 65.36 | -36.66 | QP | |
| 2 | | 0.1620 | 5.61 | 9.75 | 15.36 | 55.36 | -40.00 | AVG | |
| 3 | | 0.6700 | 18.80 | 9.83 | 28.63 | 56.00 | -27.37 | QP | |
| 4 | | 0.6700 | 5.01 | 9.83 | 14.84 | 46.00 | -31.16 | AVG | |
| 5 | | 1.0460 | 1.72 | 9.75 | 11.47 | 46.00 | -34.53 | AVG | |
| 6 | | 1.1340 | 14.62 | 9.74 | 24.36 | 56.00 | -31.64 | QP | |
| 7 | | 3.4300 | 2.17 | 9.69 | 11.86 | 46.00 | -34.14 | AVG | |
| 8 | | 4.1979 | 15.65 | 9.68 | 25.33 | 56.00 | -30.67 | QP | |
| 9 | | 14.5500 | 8.62 | 9.68 | 18.30 | 50.00 | -31.70 | AVG | |
| 10 | | 15.4180 | 17.42 | 9.65 | 27.07 | 60.00 | -32.93 | QP | |
| 11 | | 26.0020 | 19.11 | 9.45 | 28.56 | 60.00 | -31.44 | QP | |
| 12 | * | 26.0020 | 17.44 | 9.45 | 26.89 | 50.00 | -23.11 | AVG | |

Notes:

1. An initial pre-scan was performed on the line and neutral lines with peak detector.
2. Quasi-Peak and Average measurement were performed at the frequencies with maximized peak emission.
3. Measurement Level = Reading level + Correct Factor
4. when charging, BT can not transmit

4.2 Radiated emissions

| | | | | | |
|-----------------------|-----------------------------|------------|--------|--------|------------|
| Test Requirement: | FCC Part15 C Section 15.209 | | | | |
| Test Method: | ANSI C63.10:2013 | | | | |
| Test Frequency Range: | 9kHz to 25GHz | | | | |
| Test site: | Measurement Distance: 3m | | | | |
| Receiver setup: | Frequency | Detector | RBW | VBW | Value |
| | 9KHz-150KHz | Quasi-peak | 200Hz | 600Hz | Quasi-peak |
| | 150KHz-30MHz | Quasi-peak | 9KHz | 30KHz | Quasi-peak |
| | 30MHz-1GHz | Quasi-peak | 120KHz | 300KHz | Quasi-peak |
| | Above 1GHz | Peak | 1MHz | 3MHz | Peak |
| | | Peak | 1MHz | 10Hz | Average |

4.2.1 Radiated Emission Limits

| Frequencies (MHz) | Field Strength (micovolts/meter) | Measurement Distance (meters) |
|-------------------|----------------------------------|-------------------------------|
| 0.009~0.490 | 2400/F(KHz) | 300 |
| 0.490~1.705 | 24000/F(KHz) | 30 |
| 1.705~30.0 | 30 | 30 |
| 30~88 | 100 | 3 |
| 88~216 | 150 | 3 |
| 216~960 | 200 | 3 |
| Above 960 | 500 | 3 |

LIMITS OF RADIATED EMISSION MEASUREMENT

| FREQUENCY (MHz) | Limit (dBuV/m) (at 3M) | |
|-----------------|------------------------|---------|
| | PEAK | AVERAGE |
| Above 1000 | 74 | 54 |

Notes:

- (1) The limit for radiated test was performed according to FCC PART 15C.
- (2) The tighter limit applies at the band edges.
- (3) Emission level (dBuV/m)=20log Emission level (uV/m).

4.2.2 TEST PROCEDURE

Below 1GHz test procedure as below:

- a. The EUT was placed on the top of a rotating table 0.1 meters above the ground at a 3 meter semi-anechoic chamber. The table was rotated 360 degrees to determine the position of the highest radiation.
- b. The EUT was set 3 meters away from the interference-receiving antenna, which was mounted on the top of a variable-height antenna tower.
- c. The antenna height is varied from one meter to four meters above the ground to determine the maximum value of the field strength. Both horizontal and vertical polarizations of the antenna are set to make the measurement.

- d. For each suspected emission, the EUT was arranged to its worst case and then the antenna was tuned to heights from 1 meter to 4 meters (for the test frequency of below 30MHz, the antenna was tuned to heights 1 meter) and the rotatable table was turned from 0 degrees to 360 degrees to find the maximum reading.
- e. The test-receiver system was set to Peak Detect Function and Specified Bandwidth with Maximum Hold Mode.
- f. If the emission level of the EUT in peak mode was 10dB lower than the limit specified, then testing could be stopped and the peak values of the EUT would be reported. Otherwise the emissions that did not have 10dB margin would be re-tested one by one using peak, quasi-peak or average method as specified and then reported in a data sheet.

Above 1GHz test procedure as below:

- g. Different between above is the test site, change from Semi- Anechoic Chamber to fully Anechoic Chamber and change form table 0.8 metre to 1.5 metre(Above 18GHz the distance is 1 meter and table is 1.5 metre).
- h. Test the EUT in the lowest channel ,the middle channel ,the Highest channel

Note:

Both horizontal and vertical antenna polarities were tested and performed pretest to three orthogonal axis. The worst case emissions were reported

4.2.3 DEVIATION FROM TEST STANDARD

No deviation

4.2.4 TEST SETUP

(A) Radiated Emission Test-Up Frequency Below 30MHz

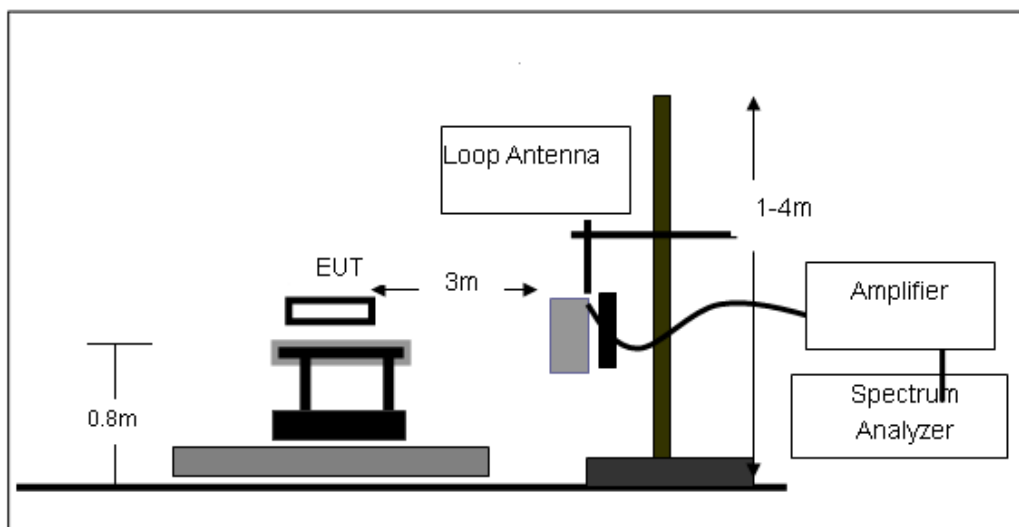

(B) Radiated Emission Test-Up Frequency 30MHz~1GHz

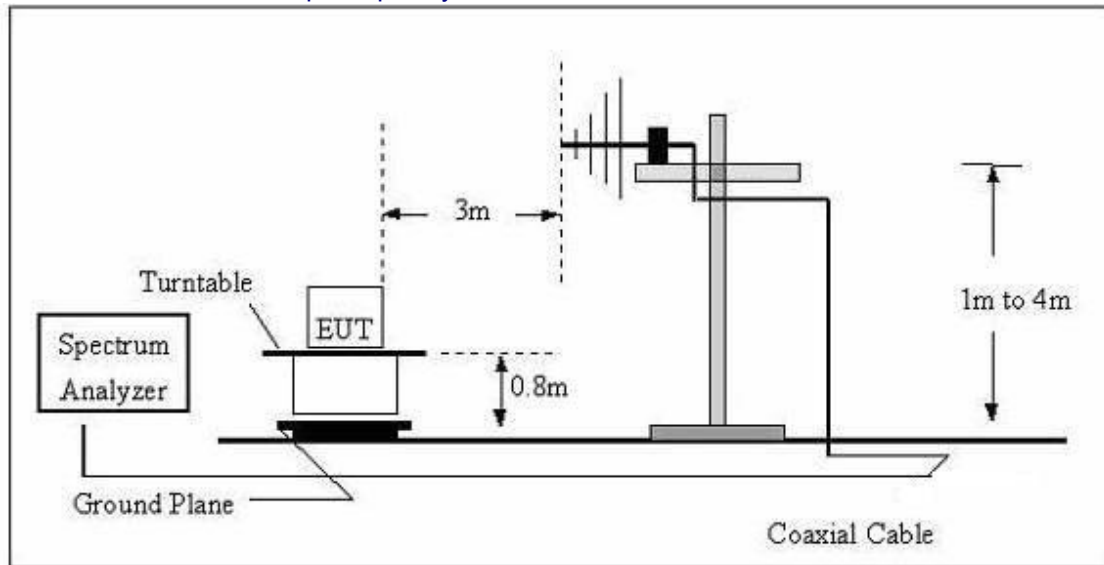

(C) Radiated Emission Test-Up Frequency Above 1GHz

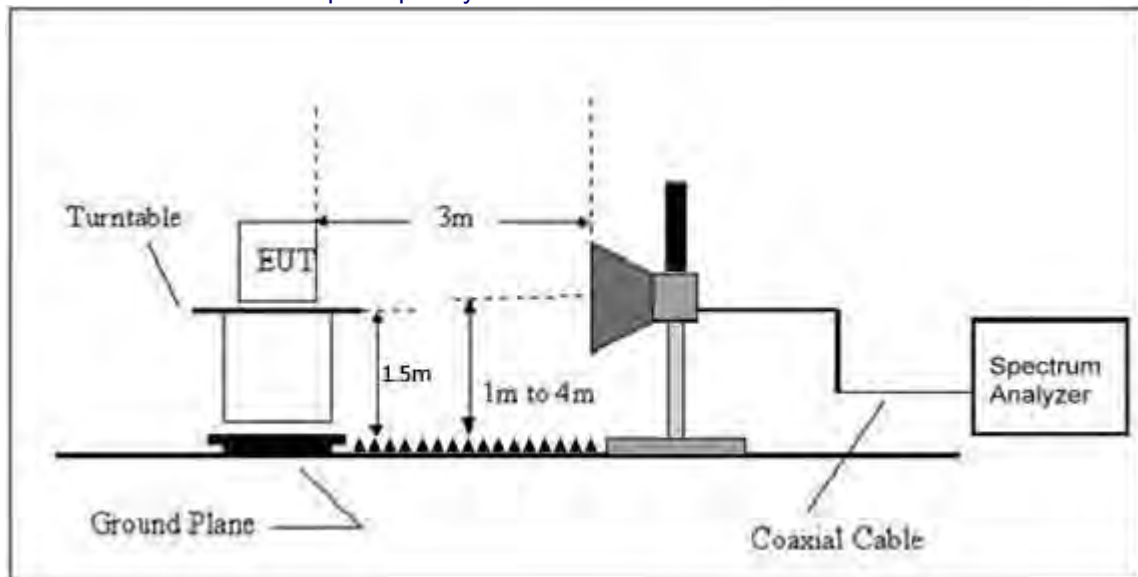

4.2.5 EUT OPERATING CONDITIONS

The EUT tested system was configured as the statements of 2.4 Unless otherwise a special operating condition is specified in the follows during the testing.

4.2.6 TEST RESULTS

Between 9KHz – 30MHz

The emission from 9 kHz to 30MHz was pre-tested and found the result was 20dB lower than the limit, and according to 15.31(o) & RSS-Gen 6.13, the test result no need to reported.

Between 30MHz – 1GHz

| | | | |
|---------------|--------|--------------------|------------|
| Temperature: | 26°C | Relative Humidity: | 54% |
| Pressure: | 101kPa | Polarization: | Horizontal |
| Test Voltage: | DC5.0V | Test mode | BT |

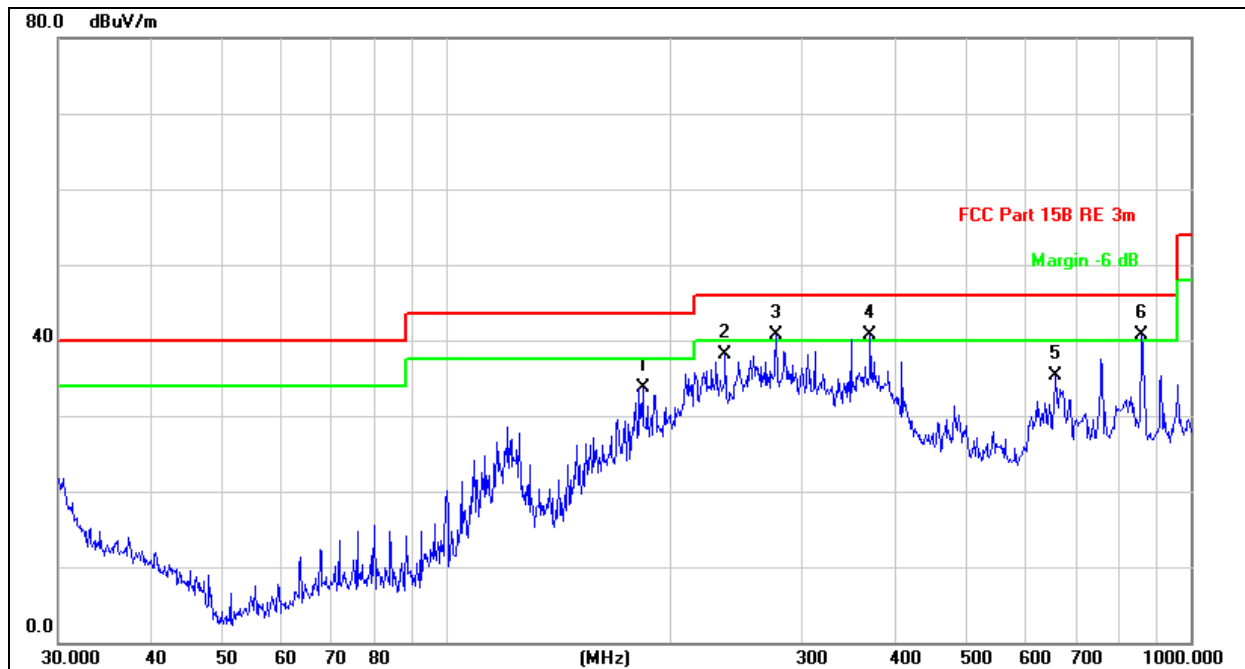

| No. | Mk. | Freq. | Reading Level | Correct Factor | Measurement | Limit | Over | Antenna Height | Table Degree | |
|-----|-----|----------|---------------|----------------|-------------|--------|--------|----------------|--------------|---------|
| | | MHz | dBuV | dB/m | dBuV/m | dBuV/m | dB | cm | degree | Comment |
| 1 | | 183.2005 | 40.79 | -7.16 | 33.63 | 43.50 | -9.87 | QP | 100 | 360 |
| 2 | | 236.6447 | 44.22 | -6.14 | 38.08 | 46.00 | -7.92 | QP | 100 | 360 |
| 3 | ! | 277.0935 | 44.99 | -4.33 | 40.66 | 46.00 | -5.34 | QP | 100 | 360 |
| 4 | * | 370.7023 | 43.34 | -2.57 | 40.77 | 46.00 | -5.23 | QP | 100 | 360 |
| 5 | | 658.8362 | 35.70 | -0.49 | 35.21 | 46.00 | -10.79 | QP | 100 | 360 |
| 6 | ! | 860.0352 | 33.85 | 6.88 | 40.73 | 46.00 | -5.27 | QP | 100 | 360 |

| | | | |
|---------------|---------|--------------------|----------|
| Temperature: | 26°C | Relative Humidity: | 54% |
| Pressure: | 101kPa | Polarization: | Vertical |
| Test Voltage: | DC 5.0V | Test mode | BT |

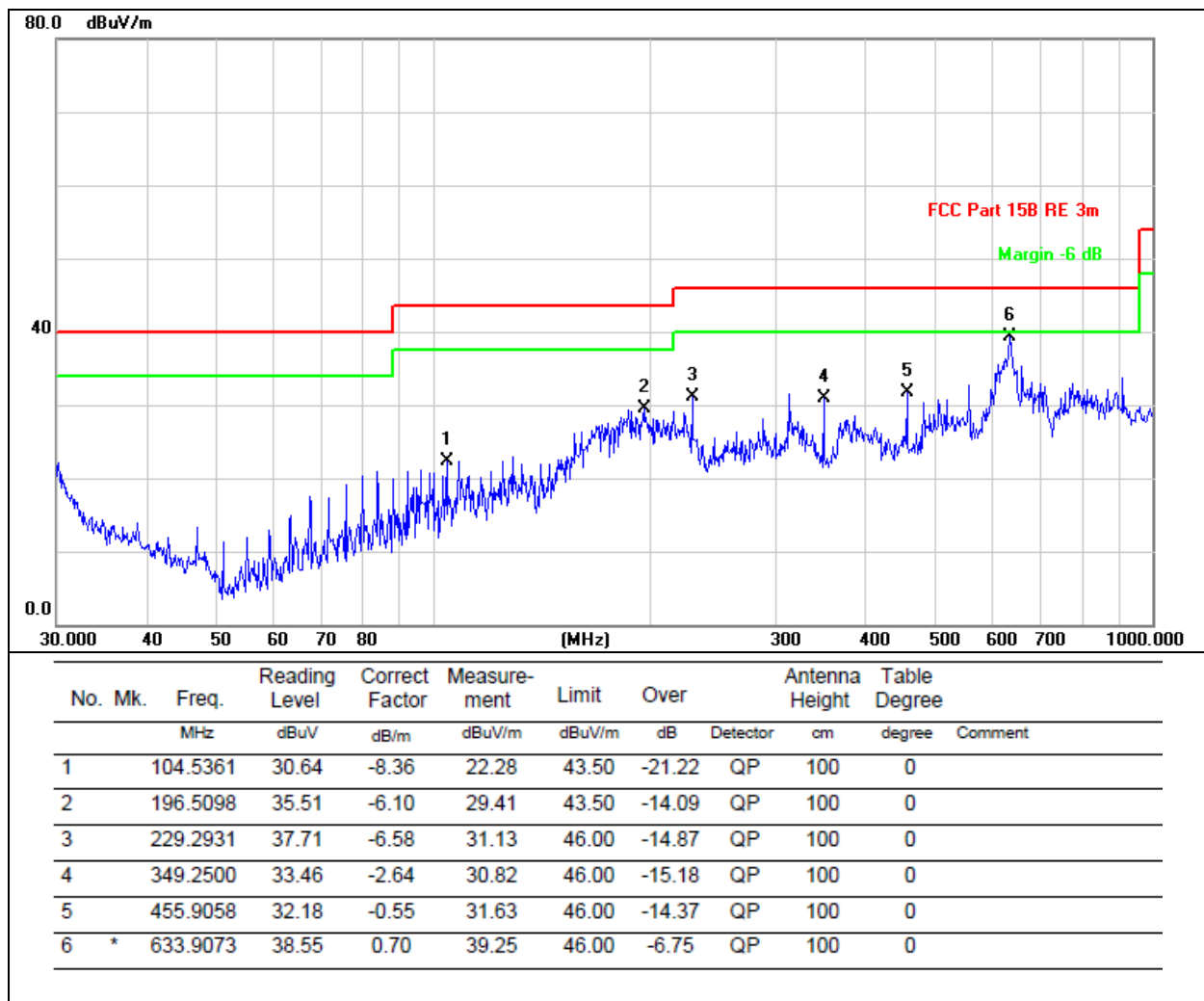

Remarks:

1. Final Level = Receiver Read level + Antenna Factor + Cable Loss – Pre-amplifier Factor
2. The emission levels of other frequencies are very lower than the limit and not show in test report.
3. The test data shows only the worst case GFSK mode

1GHz~25GHz

GFSK

| Polar (H/V) | Frequency | Meter Reading | Pre-amplifier | Cable Loss | Antenna Factor | Emission Level | Limits | Margin | Detector Type |
|---------------------|-----------|---------------|---------------|------------|----------------|----------------|----------|--------|---------------|
| | (MHz) | (dBuV) | (dB) | (dB) | (dB) | (dBuV/m) | (dBuV/m) | (dB) | |
| Low Channel:2402MHz | | | | | | | | | |
| V | 4804 | 53.79 | 30.55 | 5.77 | 24.66 | 53.67 | 74.00 | -20.33 | Pk |
| V | 4804 | 39.93 | 30.55 | 5.77 | 24.66 | 39.81 | 54.00 | -14.19 | AV |
| V | 7206 | 53.45 | 30.33 | 6.32 | 24.55 | 53.99 | 74.00 | -20.01 | Pk |
| V | 7206 | 39.40 | 30.33 | 6.32 | 24.55 | 39.94 | 54.00 | -14.06 | AV |
| V | 9608 | 52.57 | 30.85 | 7.45 | 24.69 | 53.86 | 74.00 | -20.14 | Pk |
| V | 9608 | 38.29 | 30.85 | 7.45 | 24.69 | 39.58 | 54.00 | -14.42 | AV |
| H | 4804 | 55.47 | 31.02 | 5.77 | 25.57 | 55.79 | 74.00 | -18.21 | Pk |
| H | 4804 | 39.83 | 31.02 | 5.77 | 25.57 | 40.15 | 54.00 | -13.85 | AV |
| H | 7206 | 54.70 | 30.55 | 6.32 | 24.66 | 55.13 | 74.00 | -18.87 | Pk |
| H | 7206 | 39.77 | 30.55 | 6.32 | 24.66 | 40.20 | 54.00 | -13.80 | AV |
| H | 9608 | 50.68 | 30.33 | 7.45 | 24.55 | 52.35 | 74.00 | -21.65 | Pk |
| H | 9608 | 36.60 | 30.33 | 7.45 | 24.55 | 38.27 | 54.00 | -15.73 | AV |

| Polar (H/V) | Frequency | Meter Reading | Pre-amplifier | Cable Loss | Antenna Factor | Emission Level | Limits | Margin | Detector Type |
|------------------------|-----------|---------------|---------------|------------|----------------|----------------|----------|--------|---------------|
| | (MHz) | (dBuV) | (dB) | (dB) | (dB) | (dBuV/m) | (dBuV/m) | (dB) | |
| Middle Channel:2441MHz | | | | | | | | | |
| V | 4882 | 55.13 | 30.55 | 5.77 | 24.66 | 55.01 | 74.00 | -18.99 | Pk |
| V | 4882 | 41.41 | 30.55 | 5.77 | 24.66 | 41.29 | 54.00 | -12.71 | AV |
| V | 7323 | 53.47 | 30.33 | 6.32 | 24.55 | 54.01 | 74.00 | -19.99 | Pk |
| V | 7323 | 39.17 | 30.33 | 6.32 | 24.55 | 39.71 | 54.00 | -14.29 | AV |
| V | 9764 | 52.32 | 30.85 | 7.45 | 24.69 | 53.61 | 74.00 | -20.39 | Pk |
| V | 9764 | 39.23 | 30.85 | 7.45 | 24.69 | 40.52 | 54.00 | -13.48 | AV |
| H | 4882 | 56.18 | 31.02 | 5.77 | 25.57 | 56.50 | 74.00 | -17.50 | Pk |
| H | 4882 | 40.59 | 31.02 | 5.77 | 25.57 | 40.91 | 54.00 | -13.09 | AV |
| H | 7323 | 54.34 | 30.55 | 6.32 | 24.66 | 54.77 | 74.00 | -19.23 | Pk |
| H | 7323 | 39.26 | 30.55 | 6.32 | 24.66 | 39.69 | 54.00 | -14.31 | AV |
| H | 9764 | 50.45 | 30.33 | 7.45 | 24.55 | 52.12 | 74.00 | -21.88 | Pk |
| H | 9764 | 38.24 | 30.33 | 7.45 | 24.55 | 39.91 | 54.00 | -14.09 | AV |

| Polar (H/V) | Frequency | Meter Reading | Pre-ampli fier | Cable Loss | Antenna Factor | Emission Level | Limits | Margin | Detector Type |
|----------------------|-----------|------------------|-------------------|---------------|-------------------|-------------------|----------|--------|------------------|
| | (MHz) | (dBuV) | (dB) | (dB) | (dB) | (dBuV/m) | (dBuV/m) | (dB) | |
| High Channel:2480MHz | | | | | | | | | |
| V | 4960 | 56.75 | 30.55 | 5.77 | 24.66 | 56.63 | 74.00 | -17.37 | Pk |
| V | 4960 | 39.79 | 30.55 | 5.77 | 24.66 | 39.67 | 54.00 | -14.33 | AV |
| V | 7440 | 53.67 | 30.33 | 6.32 | 24.55 | 54.21 | 74.00 | -19.79 | Pk |
| V | 7440 | 41.59 | 30.33 | 6.32 | 24.55 | 42.13 | 54.00 | -11.87 | AV |
| V | 9920 | 51.71 | 30.85 | 7.45 | 24.69 | 53.00 | 74.00 | -21.00 | Pk |
| V | 9920 | 38.39 | 30.85 | 7.45 | 24.69 | 39.68 | 54.00 | -14.32 | AV |
| H | 4960 | 56.71 | 31.02 | 5.77 | 25.57 | 57.03 | 74.00 | -16.97 | Pk |
| H | 4960 | 39.88 | 31.02 | 5.77 | 25.57 | 40.20 | 54.00 | -13.80 | AV |
| H | 7440 | 53.38 | 30.55 | 6.32 | 24.66 | 53.81 | 74.00 | -20.19 | Pk |
| H | 7440 | 39.22 | 30.55 | 6.32 | 24.66 | 39.65 | 54.00 | -14.35 | AV |
| H | 9920 | 49.92 | 30.33 | 7.45 | 24.55 | 51.59 | 74.00 | -22.41 | Pk |
| H | 9920 | 36.90 | 30.33 | 7.45 | 24.55 | 38.57 | 54.00 | -15.43 | AV |

Remark:

1. Emission Level = Meter Reading + Antenna Factor + Cable Loss – Pre-amplifier,
Margin= Emission Level - Limit
2. If peak below the average limit, the average emission was no test.
3. The amplitude of spurious emissions which are attenuated by more than 20dB below the permissible value has no need to be reported.

$\pi/4$ -DQPSK

| Polar (H/V) | Frequency | Meter Reading | Pre-amplifier | Cable Loss | Antenna Factor | Emission Level | Limits | Margin | Detector Type |
|---------------------|-----------|---------------|---------------|------------|----------------|----------------|----------|--------|---------------|
| | (MHz) | (dBuV) | (dB) | (dB) | (dB) | (dBuV/m) | (dBuV/m) | (dB) | |
| Low Channel:2402MHz | | | | | | | | | |
| V | 4804 | 55.02 | 30.55 | 5.77 | 24.66 | 54.90 | 74.00 | -19.10 | Pk |
| V | 4804 | 41.71 | 30.55 | 5.77 | 24.66 | 41.59 | 54.00 | -12.41 | AV |
| V | 7206 | 53.40 | 30.33 | 6.32 | 24.55 | 53.94 | 74.00 | -20.06 | Pk |
| V | 7206 | 40.52 | 30.33 | 6.32 | 24.55 | 41.06 | 54.00 | -12.94 | AV |
| V | 9608 | 50.45 | 30.85 | 7.45 | 24.69 | 51.74 | 74.00 | -22.26 | Pk |
| V | 9608 | 39.05 | 30.85 | 7.45 | 24.69 | 40.34 | 54.00 | -13.66 | AV |
| H | 4804 | 54.83 | 31.02 | 5.77 | 25.57 | 55.15 | 74.00 | -18.85 | Pk |
| H | 4804 | 40.16 | 31.02 | 5.77 | 25.57 | 40.48 | 54.00 | -13.52 | AV |
| H | 7206 | 54.26 | 30.55 | 6.32 | 24.66 | 54.69 | 74.00 | -19.31 | Pk |
| H | 7206 | 39.75 | 30.55 | 6.32 | 24.66 | 40.18 | 54.00 | -13.82 | AV |
| H | 9608 | 52.51 | 30.33 | 7.45 | 24.55 | 54.18 | 74.00 | -19.82 | Pk |
| H | 9608 | 38.89 | 30.33 | 7.45 | 24.55 | 40.56 | 54.00 | -13.44 | AV |

| Polar (H/V) | Frequency | Meter Reading | Pre-amplifier | Cable Loss | Antenna Factor | Emission Level | Limits | Margin | Detector Type |
|------------------------|-----------|---------------|---------------|------------|----------------|----------------|----------|--------|---------------|
| | (MHz) | (dBuV) | (dB) | (dB) | (dB) | (dBuV/m) | (dBuV/m) | (dB) | |
| Middle Channel:2441MHz | | | | | | | | | |
| V | 4882 | 56.33 | 30.55 | 5.77 | 24.66 | 56.21 | 74.00 | -17.79 | Pk |
| V | 4882 | 40.81 | 30.55 | 5.77 | 24.66 | 40.69 | 54.00 | -13.31 | AV |
| V | 7323 | 54.18 | 30.33 | 6.32 | 24.55 | 54.72 | 74.00 | -19.28 | Pk |
| V | 7323 | 39.42 | 30.33 | 6.32 | 24.55 | 39.96 | 54.00 | -14.04 | AV |
| V | 9764 | 52.33 | 30.85 | 7.45 | 24.69 | 53.62 | 74.00 | -20.38 | Pk |
| V | 9764 | 36.97 | 30.85 | 7.45 | 24.69 | 38.26 | 54.00 | -15.74 | AV |
| H | 4882 | 54.10 | 31.02 | 5.77 | 25.57 | 54.42 | 74.00 | -19.58 | Pk |
| H | 4882 | 40.01 | 31.02 | 5.77 | 25.57 | 40.33 | 54.00 | -13.67 | AV |
| H | 7323 | 54.13 | 30.55 | 6.32 | 24.66 | 54.56 | 74.00 | -19.44 | Pk |
| H | 7323 | 41.35 | 30.55 | 6.32 | 24.66 | 41.78 | 54.00 | -12.22 | AV |
| H | 9764 | 52.50 | 30.33 | 7.45 | 24.55 | 54.17 | 74.00 | -19.83 | Pk |
| H | 9764 | 36.75 | 30.33 | 7.45 | 24.55 | 38.42 | 54.00 | -15.58 | AV |

| Polar (H/V) | Frequency | Meter Reading | Pre-ampli fier | Cable Loss | Antenna Factor | Emission Level | Limits | Margin | Detector Type |
|----------------------|-----------|------------------|-------------------|---------------|-------------------|-------------------|----------|--------|------------------|
| | (MHz) | (dBuV) | (dB) | (dB) | (dB) | (dBuV/m) | (dBuV/m) | (dB) | |
| High Channel:2480MHz | | | | | | | | | |
| V | 4960 | 54.66 | 30.55 | 5.77 | 24.66 | 54.54 | 74.00 | -19.46 | Pk |
| V | 4960 | 42.16 | 30.55 | 5.77 | 24.66 | 42.04 | 54.00 | -11.96 | AV |
| V | 7440 | 52.88 | 30.33 | 6.32 | 24.55 | 53.42 | 74.00 | -20.58 | Pk |
| V | 7440 | 40.43 | 30.33 | 6.32 | 24.55 | 40.97 | 54.00 | -13.03 | AV |
| V | 9920 | 51.47 | 30.85 | 7.45 | 24.69 | 52.76 | 74.00 | -21.24 | Pk |
| V | 9920 | 39.08 | 30.85 | 7.45 | 24.69 | 40.37 | 54.00 | -13.63 | AV |
| H | 4960 | 56.15 | 31.02 | 5.77 | 25.57 | 56.47 | 74.00 | -17.53 | Pk |
| H | 4960 | 40.04 | 31.02 | 5.77 | 25.57 | 40.36 | 54.00 | -13.64 | AV |
| H | 7440 | 52.84 | 30.55 | 6.32 | 24.66 | 53.27 | 74.00 | -20.73 | Pk |
| H | 7440 | 40.33 | 30.55 | 6.32 | 24.66 | 40.76 | 54.00 | -13.24 | AV |
| H | 9920 | 51.63 | 30.33 | 7.45 | 24.55 | 53.30 | 74.00 | -20.70 | Pk |
| H | 9920 | 38.48 | 30.33 | 7.45 | 24.55 | 40.15 | 54.00 | -13.85 | AV |

Remark:

1. Emission Level = Meter Reading + Antenna Factor + Cable Loss – Pre-amplifier,
Margin= Emission Level - Limit
2. If peak below the average limit, the average emission was no test.
3. The amplitude of spurious emissions which are attenuated by more than 20dB below the permissible value has no need to be reported.

8-DPSK

| Polar (H/V) | Frequency | Meter Reading | Pre-ampli fier | Cable Loss | Antenna Factor | Emission Level | Limits | Margin | Detector Type |
|---------------------|-----------|------------------|-------------------|---------------|-------------------|-------------------|----------|--------|------------------|
| | (MHz) | (dBuV) | (dB) | (dB) | (dB) | (dBuV/m) | (dBuV/m) | (dB) | |
| Low Channel:2402MHz | | | | | | | | | |
| V | 4804 | 55.45 | 30.55 | 5.77 | 24.66 | 55.33 | 74.00 | -18.67 | Pk |
| V | 4804 | 41.99 | 30.55 | 5.77 | 24.66 | 41.87 | 54.00 | -12.13 | AV |
| V | 7206 | 53.64 | 30.33 | 6.32 | 24.55 | 54.18 | 74.00 | -19.82 | Pk |
| V | 7206 | 38.87 | 30.33 | 6.32 | 24.55 | 39.41 | 54.00 | -14.59 | AV |
| V | 9608 | 49.87 | 30.85 | 7.45 | 24.69 | 51.16 | 74.00 | -22.84 | Pk |
| V | 9608 | 38.94 | 30.85 | 7.45 | 24.69 | 40.23 | 54.00 | -13.77 | AV |
| H | 4804 | 54.06 | 31.02 | 5.77 | 25.57 | 54.38 | 74.00 | -19.62 | Pk |
| H | 4804 | 41.42 | 31.02 | 5.77 | 25.57 | 41.74 | 54.00 | -12.26 | AV |
| H | 7206 | 53.70 | 30.55 | 6.32 | 24.66 | 54.13 | 74.00 | -19.87 | Pk |
| H | 7206 | 39.39 | 30.55 | 6.32 | 24.66 | 39.82 | 54.00 | -14.18 | AV |
| H | 9608 | 51.32 | 30.33 | 7.45 | 24.55 | 52.99 | 74.00 | -21.01 | Pk |
| H | 9608 | 39.08 | 30.33 | 7.45 | 24.55 | 40.75 | 54.00 | -13.25 | AV |

| Polar (H/V) | Frequency | Meter Reading | Pre-ampli fier | Cable Loss | Antenna Factor | Emission Level | Limits | Margin | Detector Type |
|------------------------|-----------|------------------|-------------------|---------------|-------------------|-------------------|----------|--------|------------------|
| | (MHz) | (dBuV) | (dB) | (dB) | (dB) | (dBuV/m) | (dBuV/m) | (dB) | |
| Middle Channel:2441MHz | | | | | | | | | |
| V | 4882 | 55.16 | 30.55 | 5.77 | 24.66 | 55.04 | 74.00 | -18.96 | Pk |
| V | 4882 | 40.88 | 30.55 | 5.77 | 24.66 | 40.76 | 54.00 | -13.24 | AV |
| V | 7323 | 54.12 | 30.33 | 6.32 | 24.55 | 54.66 | 74.00 | -19.34 | Pk |
| V | 7323 | 39.29 | 30.33 | 6.32 | 24.55 | 39.83 | 54.00 | -14.17 | AV |
| V | 9764 | 52.73 | 30.85 | 7.45 | 24.69 | 54.02 | 74.00 | -19.98 | Pk |
| V | 9764 | 37.83 | 30.85 | 7.45 | 24.69 | 39.12 | 54.00 | -14.88 | AV |
| H | 4882 | 54.04 | 31.02 | 5.77 | 25.57 | 54.36 | 74.00 | -19.64 | Pk |
| H | 4882 | 40.52 | 31.02 | 5.77 | 25.57 | 40.84 | 54.00 | -13.16 | AV |
| H | 7323 | 53.66 | 30.55 | 6.32 | 24.66 | 54.09 | 74.00 | -19.91 | Pk |
| H | 7323 | 39.22 | 30.55 | 6.32 | 24.66 | 39.65 | 54.00 | -14.35 | AV |
| H | 9764 | 50.49 | 30.33 | 7.45 | 24.55 | 52.16 | 74.00 | -21.84 | Pk |
| H | 9764 | 36.81 | 30.33 | 7.45 | 24.55 | 38.48 | 54.00 | -15.52 | AV |

| Polar (H/V) | Frequency | Meter Reading | Pre-ampli fier | Cable Loss | Antenna Factor | Emission Level | Limits | Margin | Detector Type |
|----------------------|-----------|------------------|-------------------|---------------|-------------------|-------------------|----------|--------|------------------|
| | (MHz) | (dBuV) | (dB) | (dB) | (dB) | (dBuV/m) | (dBuV/m) | (dB) | |
| High Channel:2480MHz | | | | | | | | | |
| V | 4960 | 54.66 | 30.55 | 5.77 | 24.66 | 54.54 | 74.00 | -19.46 | Pk |
| V | 4960 | 41.79 | 30.55 | 5.77 | 24.66 | 41.67 | 54.00 | -12.33 | AV |
| V | 7440 | 52.88 | 30.33 | 6.32 | 24.55 | 53.42 | 74.00 | -20.58 | Pk |
| V | 7440 | 41.41 | 30.33 | 6.32 | 24.55 | 41.95 | 54.00 | -12.05 | AV |
| V | 9920 | 50.05 | 30.85 | 7.45 | 24.69 | 51.34 | 74.00 | -22.66 | Pk |
| V | 9920 | 37.46 | 30.85 | 7.45 | 24.69 | 38.75 | 54.00 | -15.25 | AV |
| H | 4960 | 54.15 | 31.02 | 5.77 | 25.57 | 54.47 | 74.00 | -19.53 | Pk |
| H | 4960 | 39.60 | 31.02 | 5.77 | 25.57 | 39.92 | 54.00 | -14.08 | AV |
| H | 7440 | 53.43 | 30.55 | 6.32 | 24.66 | 53.86 | 74.00 | -20.14 | Pk |
| H | 7440 | 38.88 | 30.55 | 6.32 | 24.66 | 39.31 | 54.00 | -14.69 | AV |
| H | 9920 | 51.46 | 30.33 | 7.45 | 24.55 | 53.13 | 74.00 | -20.87 | Pk |
| H | 9920 | 36.43 | 30.33 | 7.45 | 24.55 | 38.10 | 54.00 | -15.90 | AV |

Remark:

1. Emission Level = Meter Reading + Antenna Factor + Cable Loss – Pre-amplifier,
Margin= Emission Level - Limit
2. If peak below the average limit, the average emission was no test.
3. The amplitude of spurious emissions which are attenuated by more than 20dB below the permissible value has no need to be reported.

5. RADIATED BAND EMISSION MEASUREMENT

5.1 Test Requirement:

| | | | | | |
|-----------------------|--|----------|------|------|---------|
| Test Requirement: | FCC Part15 C Section 15.209 and 15.205 | | | | |
| Test Method: | ANSI C63.10: 2013 | | | | |
| Test Frequency Range: | All of the restrict bands were tested, only the worst band's (2310MHz to 2500MHz) data was showed. | | | | |
| Test site: | Measurement Distance: 3m | | | | |
| Receiver setup: | Frequency | Detector | RBW | VBW | Value |
| | Above 1GHz | Peak | 1MHz | 3MHz | Peak |
| | | Average | 1MHz | 3MHz | Average |

LIMITS OF RADIATED EMISSION MEASUREMENT (Above 1000MHz)

| FREQUENCY (MHz) | Limit (dBuV/m) (at 3M) | |
|-----------------|------------------------|---------|
| | PEAK | AVERAGE |
| Above 1000 | 74 | 54 |

Notes:

- (1) The limit for radiated test was performed according to FCC PART 15C.
- (2) The tighter limit applies at the band edges.
- (3) Emission level (dBuV/m)=20log Emission level (uV/m).

| Spectrum Parameter | Setting |
|---------------------------------------|--|
| Attenuation | Auto |
| Start Frequency | 2300MHz |
| Stop Frequency | 2520 |
| RB / VB (emission in restricted band) | 1 MHz / 1 MHz for Peak, 1 MHz / 10Hz for Average |

5.2 TEST PROCEDURE

Above 1GHz test procedure as below:

- a. 1. The EUT was placed on the top of a rotating table 1.5 meters above the ground at a 3 meter camber. The table was rotated 360 degrees to determine the position of the highest radiation.
- b. The EUT was set 3 meters away from the interference-receiving antenna, which was mounted on the top of a variable-height antenna tower.
- c. The antenna height is varied from one meter to four meters above the ground to determine the maximum value of the field strength. Both horizontal and vertical polarizations of the antenna are set to make the measurement.
- d. For each suspected emission, the EUT was arranged to its worst case and then the antenna was tuned to heights from 1 meter to 4 meters and the rota table was turned from 0 degrees to 360 degrees to find the maximum reading.
- e. The test-receiver system was set to Peak Detect Function and Specified Bandwidth with Maximum Hold Mode.
- f. If the emission level of the EUT in peak mode was 10dB lower than the limit specified, then testing could be stopped and the peak values of the EUT would be reported. Otherwise the emissions that did not have 10dB margin would be re-tested one by one using peak, quasi-peak or average method as specified and then reported in a data sheet.
- g. Test the EUT in the lowest channel,the Highest channel

Note:

Both horizontal and vertical antenna polarities were tested and performed pretest to three orthogonal axis. The worst case emissions were reported

5.3 DEVIATION FROM TEST STANDARD

No deviation

5.4 TEST SETUP

Radiated Emission Test-Up Frequency Above 1GHz

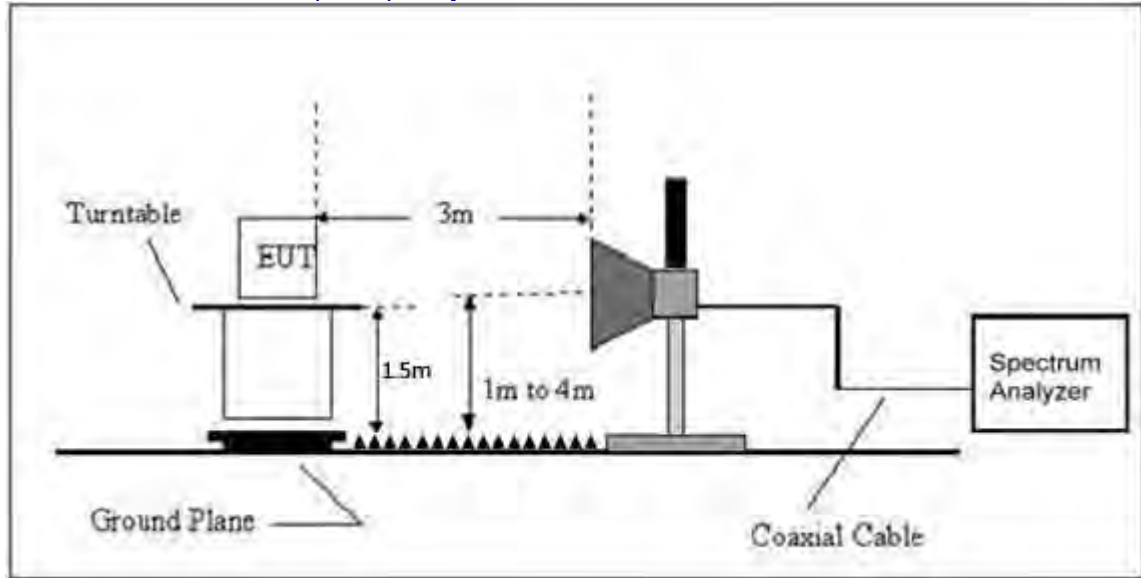

5.5 EUT OPERATING CONDITIONS

The EUT tested system was configured as the statements of 2.3 Unless otherwise a special operating condition is specified in the follows during the testing.

5.6 TEST RESULT

| | Polar (H/V) | Frequency (MHz) | Meter Reading (dBuV) | Pre-amplifier (dB) | Cable Loss (dB) | Antenna Factor (dB/m) | Emission level (dBuV/m) | Limit (dBuV/m) | Detector Type | Result |
|----------------|-----------------------|-----------------|----------------------|--------------------|-----------------|-----------------------|-------------------------|----------------|---------------|--------|
| GFSK | Low Channel: 2402MHz | | | | | | | | | |
| | H | 2390.00 | 53.08 | 30.22 | 4.85 | 23.98 | 51.69 | 74.00 | PK | PASS |
| | H | 2390.00 | 37.89 | 30.22 | 4.85 | 23.98 | 36.50 | 54.00 | AV | PASS |
| | H | 2400.00 | 52.43 | 30.22 | 4.85 | 23.98 | 51.04 | 74.00 | PK | PASS |
| | H | 2400.00 | 40.12 | 30.22 | 4.85 | 23.98 | 38.73 | 54.00 | AV | PASS |
| | V | 2390.00 | 50.27 | 30.22 | 4.85 | 23.98 | 48.88 | 74.00 | PK | PASS |
| | V | 2390.00 | 40.31 | 30.22 | 4.85 | 23.98 | 38.92 | 54.00 | AV | PASS |
| | V | 2400.00 | 51.36 | 30.22 | 4.85 | 23.98 | 49.97 | 74.00 | PK | PASS |
| | V | 2400.00 | 37.19 | 30.22 | 4.85 | 23.98 | 35.80 | 54.00 | AV | PASS |
| | High Channel: 2480MHz | | | | | | | | | |
| | H | 2483.50 | 47.28 | 30.22 | 4.85 | 23.98 | 45.89 | 74.00 | PK | PASS |
| | H | 2485.50 | 39.94 | 30.22 | 4.85 | 23.98 | 38.55 | 54.00 | AV | PASS |
| | H | 2483.50 | 47.81 | 30.22 | 4.85 | 23.98 | 46.42 | 74.00 | PK | PASS |
| | H | 2485.50 | 36.96 | 30.22 | 4.85 | 23.98 | 35.57 | 54.00 | AV | PASS |
| | V | 2483.50 | 59.21 | 30.22 | 4.85 | 23.98 | 57.82 | 74.00 | PK | PASS |
| | V | 2485.50 | 39.76 | 30.22 | 4.85 | 23.98 | 38.37 | 54.00 | AV | PASS |
| V | 2483.50 | 56.92 | 30.22 | 4.85 | 23.98 | 55.53 | 74.00 | PK | PASS | |
| V | 2485.50 | 43.21 | 30.22 | 4.85 | 23.98 | 41.82 | 54.00 | AV | PASS | |
| $\pi/4$ -DQPSK | Low Channel: 2402MHz | | | | | | | | | |
| | H | 2390.00 | 56.13 | 30.22 | 4.85 | 23.98 | 54.74 | 74.00 | PK | PASS |
| | H | 2390.00 | 36.18 | 30.22 | 4.85 | 23.98 | 34.79 | 54.00 | AV | PASS |
| | H | 2400.00 | 54.55 | 30.22 | 4.85 | 23.98 | 53.16 | 74.00 | PK | PASS |
| | H | 2400.00 | 40.53 | 30.22 | 4.85 | 23.98 | 39.14 | 54.00 | AV | PASS |
| | V | 2390.00 | 53.04 | 30.22 | 4.85 | 23.98 | 51.65 | 74.00 | PK | PASS |
| | V | 2390.00 | 42.50 | 30.22 | 4.85 | 23.98 | 41.11 | 54.00 | AV | PASS |
| | V | 2400.00 | 51.65 | 30.22 | 4.85 | 23.98 | 50.26 | 74.00 | PK | PASS |
| | V | 2400.00 | 39.42 | 30.22 | 4.85 | 23.98 | 38.03 | 54.00 | AV | PASS |
| | High Channel: 2480MHz | | | | | | | | | |
| | H | 2483.50 | 48.69 | 30.22 | 4.85 | 23.98 | 47.30 | 74.00 | PK | PASS |
| | H | 2485.50 | 37.64 | 30.22 | 4.85 | 23.98 | 36.25 | 54.00 | AV | PASS |
| | H | 2483.50 | 54.43 | 30.22 | 4.85 | 23.98 | 53.04 | 74.00 | PK | PASS |
| | H | 2485.50 | 34.34 | 30.22 | 4.85 | 23.98 | 32.95 | 54.00 | AV | PASS |
| | V | 2483.50 | 57.63 | 30.22 | 4.85 | 23.98 | 56.24 | 74.00 | PK | PASS |
| | V | 2485.50 | 39.15 | 30.22 | 4.85 | 23.98 | 37.76 | 54.00 | AV | PASS |
| V | 2483.50 | 57.32 | 30.22 | 4.85 | 23.98 | 55.93 | 74.00 | PK | PASS | |
| V | 2485.50 | 40.60 | 30.22 | 4.85 | 23.98 | 39.21 | 54.00 | AV | PASS | |

| Low Channel: 2402MHz | | | | | | | | | | | |
|---|-----------------------|---------|-------|-------|-------|-------|-------|-------|------|------|--|
| 8-DPSK | H | 2390.00 | 55.82 | 30.22 | 4.85 | 23.98 | 54.43 | 74.00 | PK | PASS | |
| | H | 2390.00 | 37.95 | 30.22 | 4.85 | 23.98 | 36.56 | 54.00 | AV | PASS | |
| | H | 2400.00 | 54.28 | 30.22 | 4.85 | 23.98 | 52.89 | 74.00 | PK | PASS | |
| | H | 2400.00 | 38.01 | 30.22 | 4.85 | 23.98 | 36.62 | 54.00 | AV | PASS | |
| | V | 2390.00 | 52.45 | 30.22 | 4.85 | 23.98 | 51.06 | 74.00 | PK | PASS | |
| | V | 2390.00 | 41.19 | 30.22 | 4.85 | 23.98 | 39.80 | 54.00 | AV | PASS | |
| | V | 2400.00 | 53.67 | 30.22 | 4.85 | 23.98 | 52.28 | 74.00 | PK | PASS | |
| | V | 2400.00 | 39.64 | 30.22 | 4.85 | 23.98 | 38.25 | 54.00 | AV | PASS | |
| | High Channel: 2480MHz | | | | | | | | | | |
| | H | 2483.50 | 47.26 | 30.22 | 4.85 | 23.98 | 45.87 | 74.00 | PK | PASS | |
| | H | 2485.50 | 40.49 | 30.22 | 4.85 | 23.98 | 39.10 | 54.00 | AV | PASS | |
| | H | 2483.50 | 49.27 | 30.22 | 4.85 | 23.98 | 47.88 | 74.00 | PK | PASS | |
| | H | 2485.50 | 38.19 | 30.22 | 4.85 | 23.98 | 36.80 | 54.00 | AV | PASS | |
| | V | 2483.50 | 55.31 | 30.22 | 4.85 | 23.98 | 53.92 | 74.00 | PK | PASS | |
| | V | 2485.50 | 44.31 | 30.22 | 4.85 | 23.98 | 42.92 | 54.00 | AV | PASS | |
| | V | 2483.50 | 60.11 | 30.22 | 4.85 | 23.98 | 58.72 | 74.00 | PK | PASS | |
| V | 2485.50 | 39.59 | 30.22 | 4.85 | 23.98 | 38.20 | 54.00 | AV | PASS | | |
| Remark: | | | | | | | | | | | |
| 1. Emission Level = Meter Reading + Antenna Factor + Cable Loss – Pre-amplifier, Margin= Emission Level - Limit | | | | | | | | | | | |

6. CONDUCTED BAND EDGE AND SPURIOUS EMISSION

| | |
|-------------------|---|
| Test Requirement: | FCC Part15 C Section 15.247 (d) |
| Test Method: | KDB558074 D0115.247 Meas Guidancev05r02 |

6.1 Limit

Regulation 15.247 (d), In any 100 kHz bandwidth outside the frequency band in which the spread spectrum or digitally modulated intentional radiator is operating, the radio frequency power that is produced by the intentional radiator shall be at least 20 dB below that in the 100 kHz bandwidth within the band that contains the highest level of the desired power, based on either an RF conducted or a radiated measurement, provided the transmitter demonstrates compliance with the peak conducted power limits. If the transmitter complies with the conducted power limits based on the use of RMS averaging over a time interval, as permitted under paragraph (b)(3) of this section, the attenuation required under this paragraph shall be 30 dB instead of 20 dB. Attenuation below the general limits specified in §15.209(a) is not required. In addition, radiated emissions which fall in the restricted bands, as defined in §15.205(a), must also comply with the radiated emission limits specified in §15.209(a) (see §15.205(c)).

6.2 Test Setup

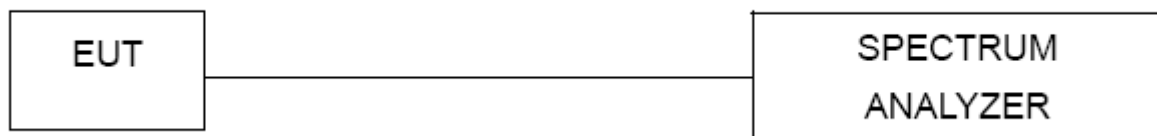

6.3 Test procedure

Using the following spectrum analyzer setting:

- A) Set the RBW = 100KHz.
- B) Set the VBW = 300KHz.
- C) Sweep time = auto couple.
- D) Detector function = peak.
- E) Trace mode = max hold.
- F) Allow trace to fully stabilize.

6.4 DEVIATION FROM STANDARD

No deviation.

6.5 Test Result

GFSK mode:

| | |
|---------------|----------------|
| Test channel: | Lowest channel |
|---------------|----------------|

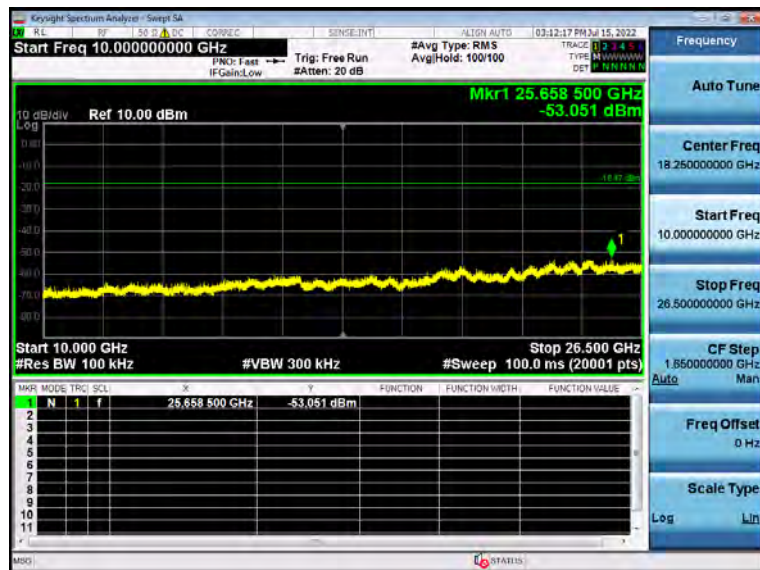
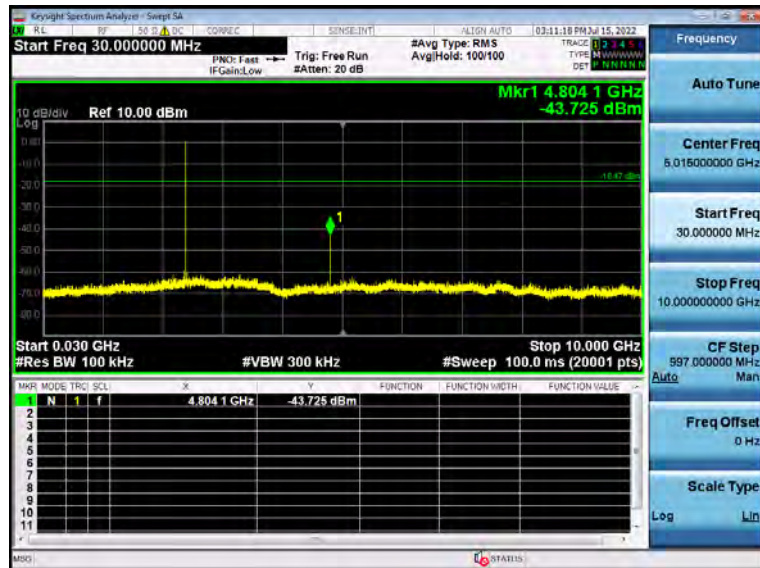

| | |
|---------------|----------------|
| Test channel: | Middle channel |
|---------------|----------------|

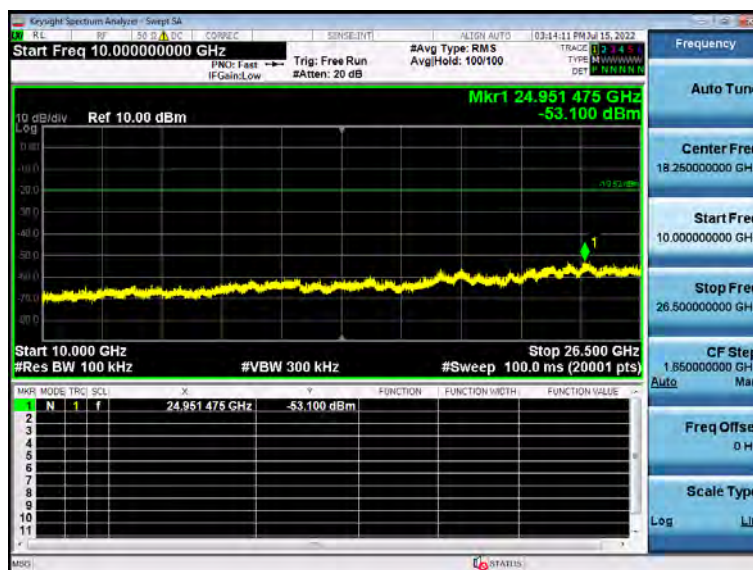
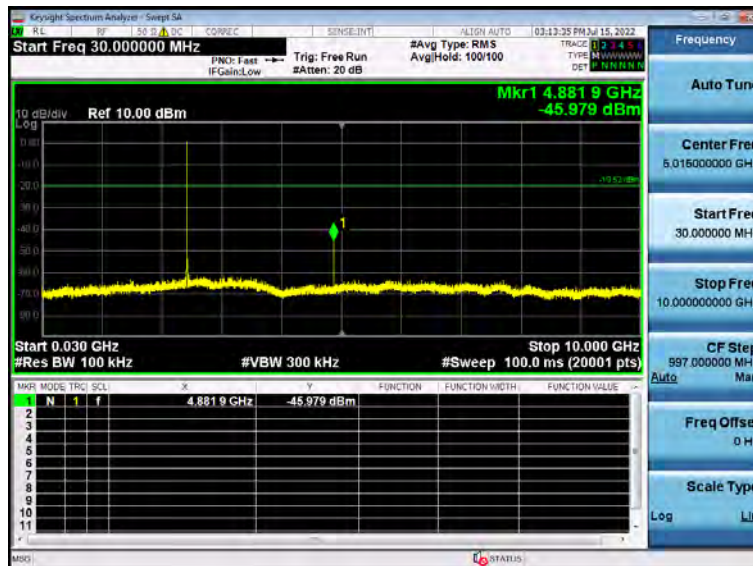

| | |
|---------------|-----------------|
| Test channel: | Highest channel |
|---------------|-----------------|

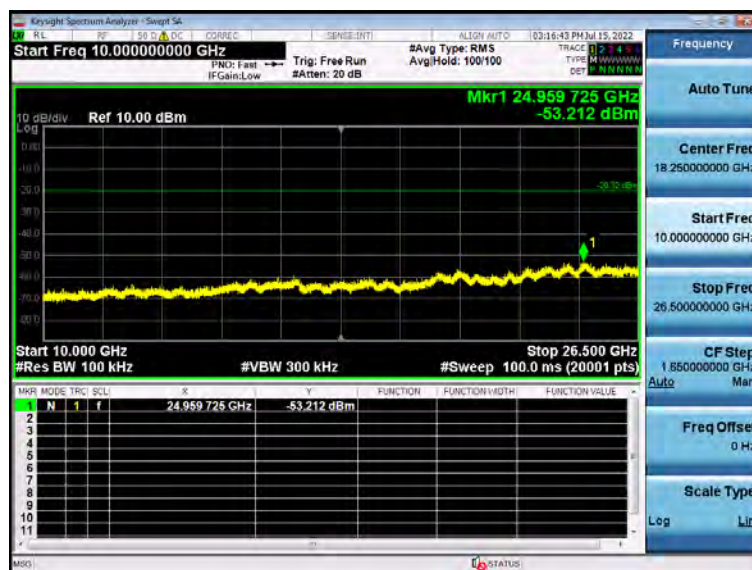
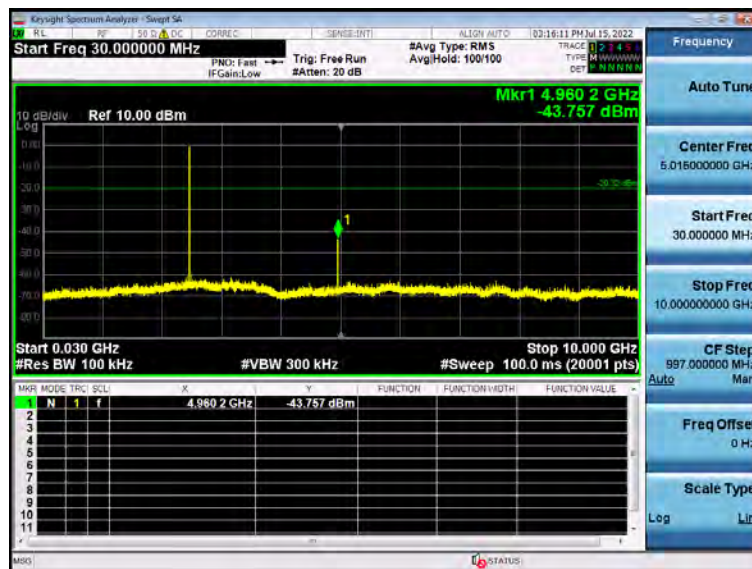

$\pi/4$ -DQPSK mode:

| | |
|---------------|----------------|
| Test channel: | Lowest channel |
|---------------|----------------|

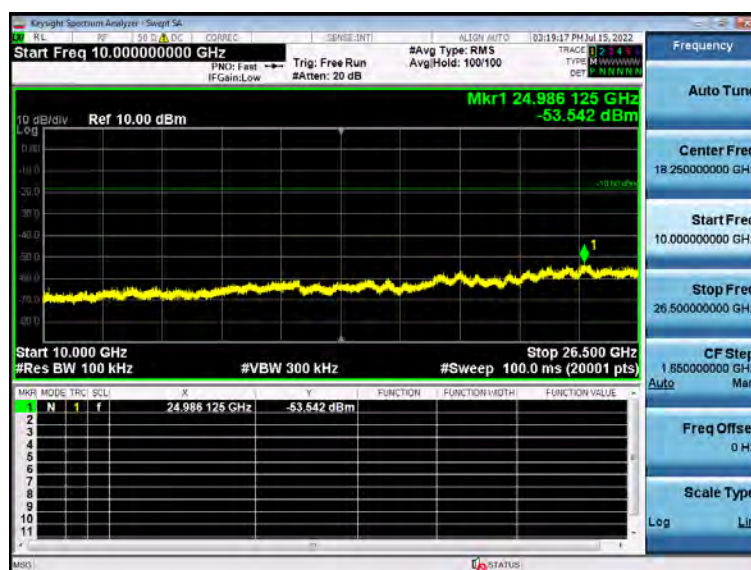
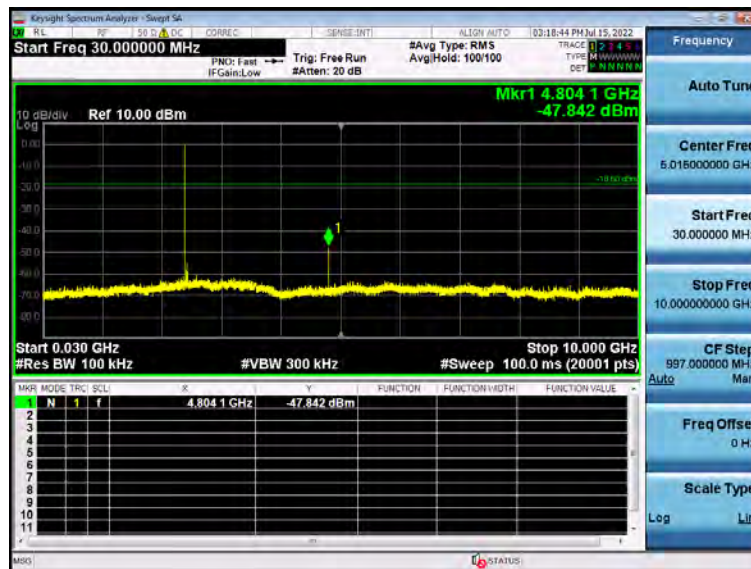

| | |
|---------------|----------------|
| Test channel: | Middle channel |
|---------------|----------------|

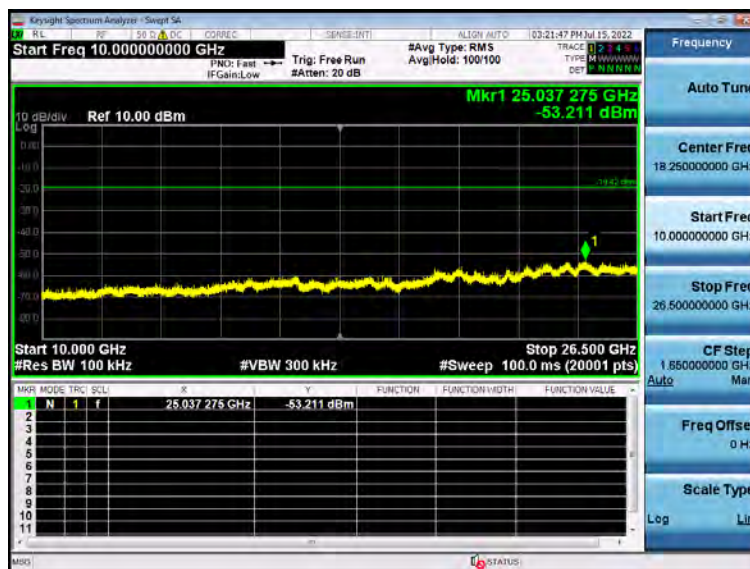
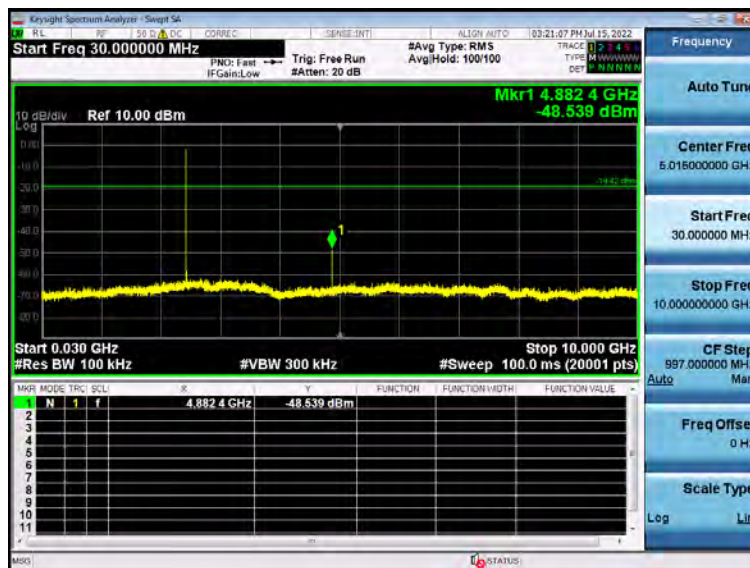

Test channel: Highest channel

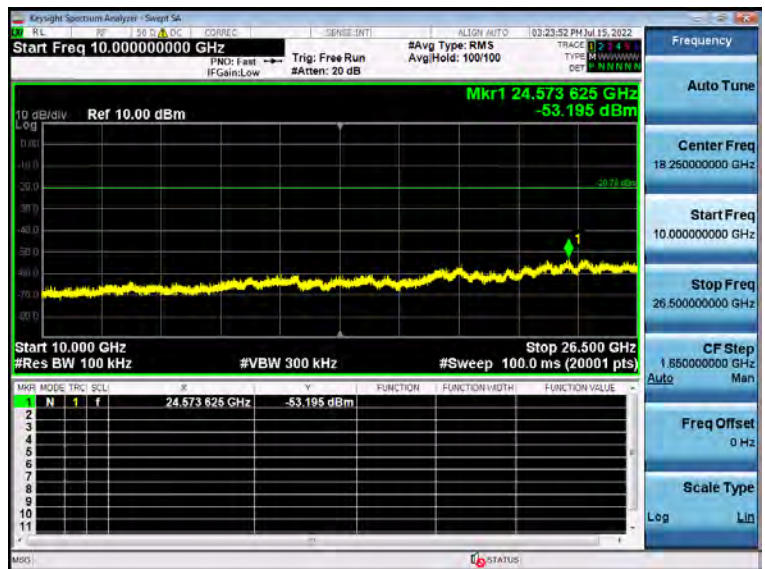
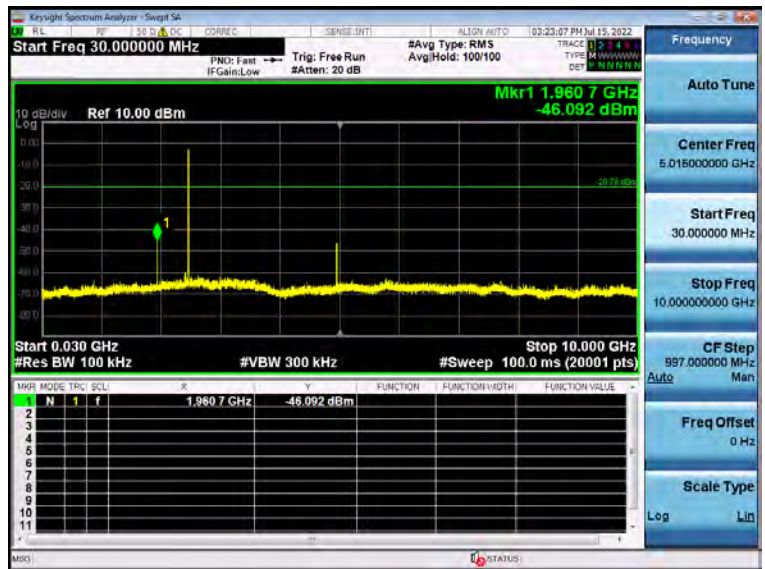

8-DPSK mode:

| | |
|---------------|----------------|
| Test channel: | Lowest channel |
|---------------|----------------|

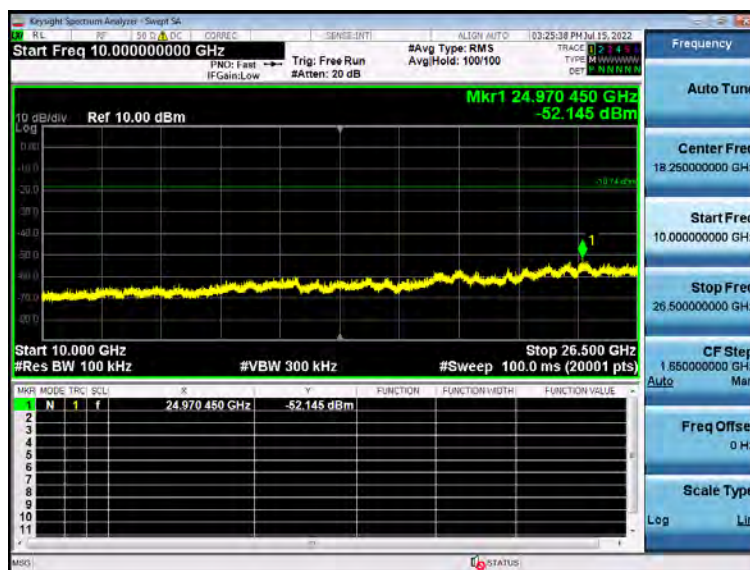
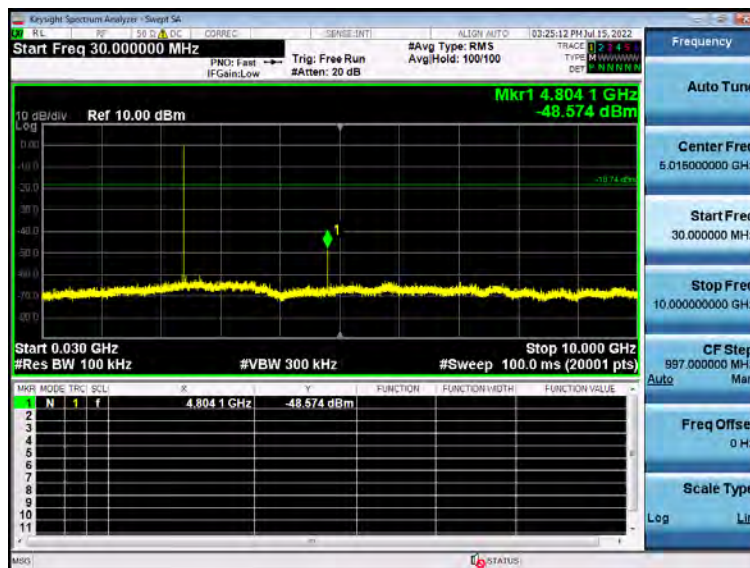

| | |
|---------------|----------------|
| Test channel: | Middle channel |
|---------------|----------------|

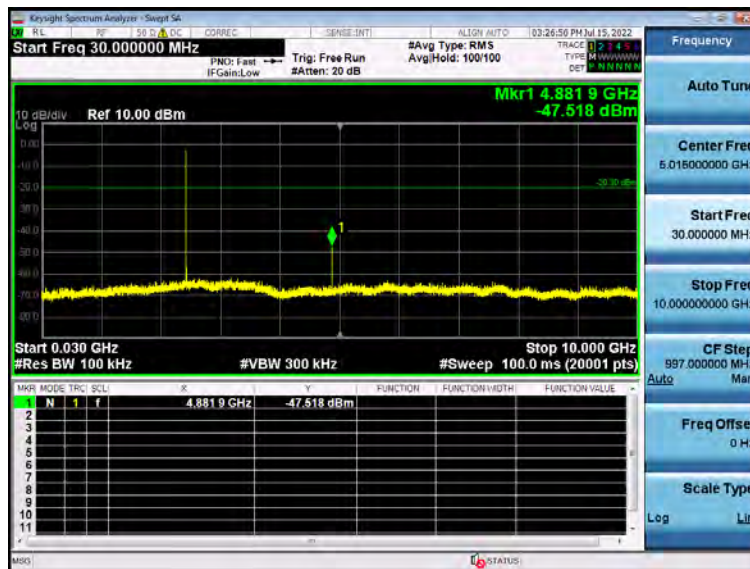

| | |
|---------------|-----------------|
| Test channel: | Highest channel |
|---------------|-----------------|

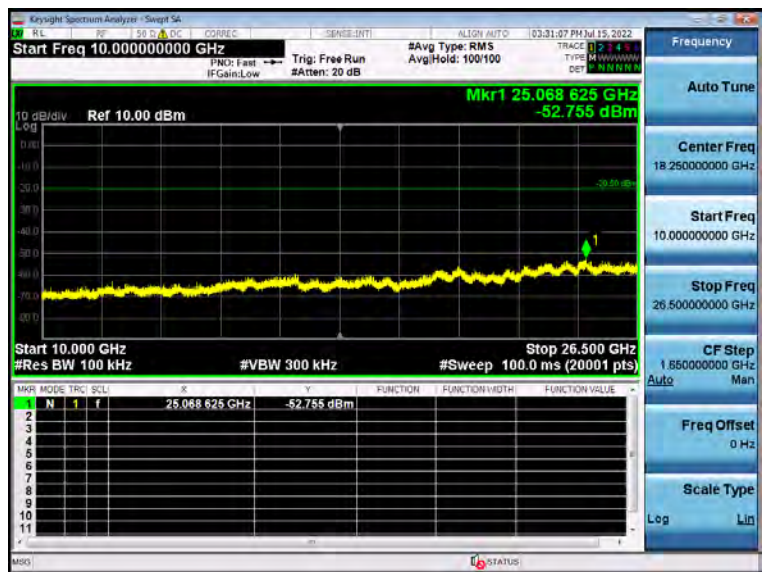
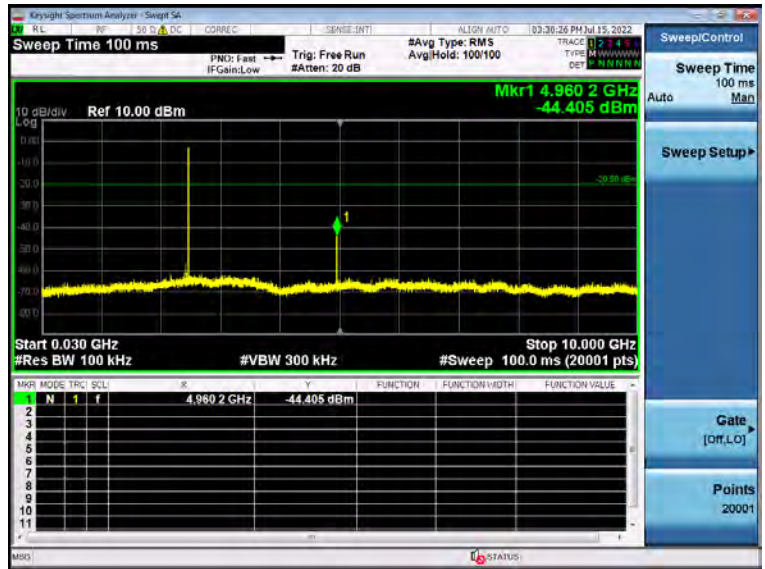

7. 20DB BANDWIDTH

| | |
|-------------------|------------------------------------|
| Test Requirement: | FCC Part15 C Section 15.247 (a)(1) |
| Test Method: | ANSI C63.10:2013 |

7.1 Test Setup



7.2 Limit

N/A

7.3 Test procedure

1. Set RBW = 20 kHz.
2. Set the video bandwidth (VBW) $\geq 3 \times$ RBW.
3. Detector = Peak.
4. Trace mode = max hold.
5. Sweep = auto couple.
6. Allow the trace to stabilize.
7. Measure the maximum width of the emission that is constrained by the frequencies associated with the two outermost amplitude points (upper and lower frequencies) that are attenuated by 6 dB relative to the maximum level measured in the fundamental emission.

7.4 DEVIATION FROM STANDARD

No deviation.

7.5 Test Result

| Mode | Test channel | 20dB Emission Bandwidth (MHz) | Result |
|----------------|--------------|-------------------------------|--------|
| GFSK | Lowest | 0.8593 | Pass |
| | Middle | 0.8840 | |
| | Highest | 0.8931 | |
| $\pi/4$ -DQPSK | Lowest | 1.215 | Pass |
| | Middle | 1.26 | |
| | Highest | 1.258 | |
| 8-DPSK | Lowest | 1.265 | Pass |
| | Middle | 1.257 | |
| | Highest | 1.267 | |

Test plots

GFSK Low Channel



GFSK Middle Channel



GFSK High Channel



$\pi/4$ -DQPSK Low Channel

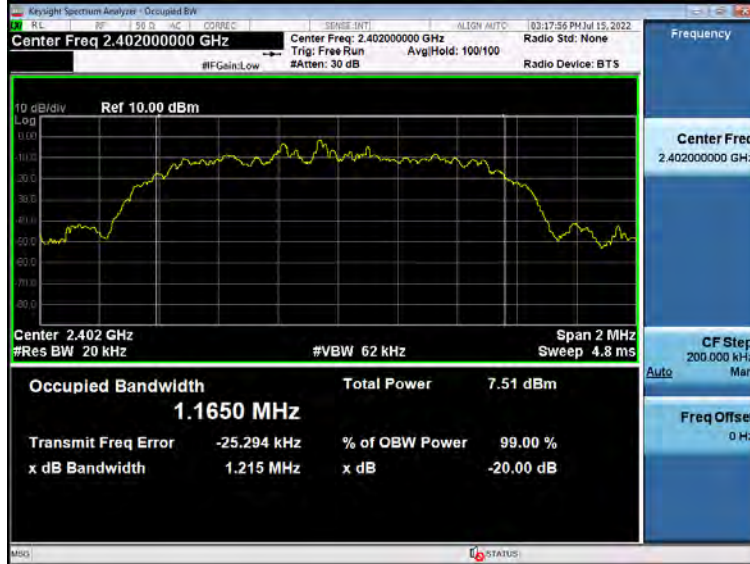

$\pi/4$ -DQPSK Middle Channel

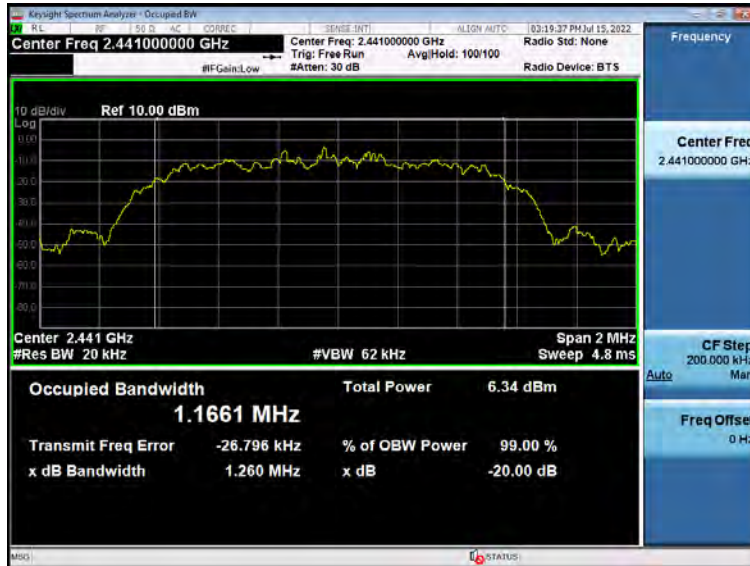

$\pi/4$ -DQPSK High Channel



8-DPSK Low Channel

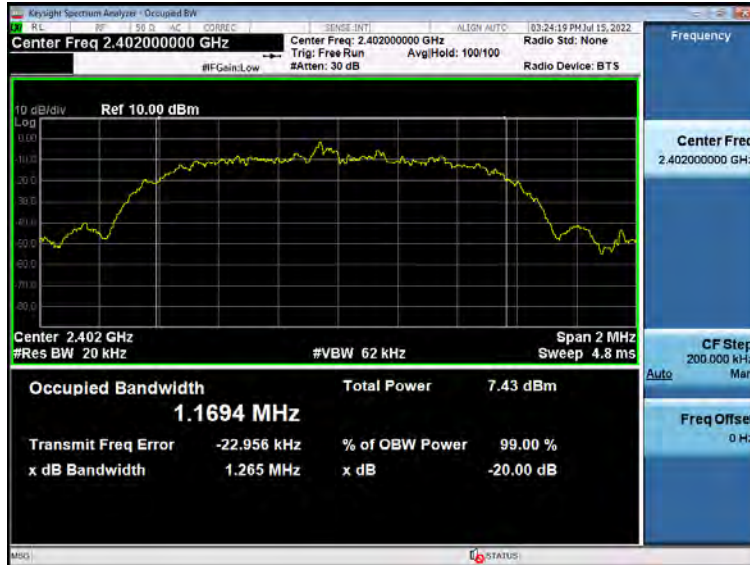

8-DPSK Middle Channel



8-DPSK High Channel



8. Maximum Peak Output Power

| | |
|-------------------|------------------------------------|
| Test Requirement: | FCC Part15 C Section 15.247 (b)(1) |
| Test Method: | ANSI C63.10:2013 |
| Limit: | 21 |

8.1 Block Diagram Of Test Setup



8.2 Limit

For frequency hopping systems operating in the 2400-2483.5 MHz band employing at least 75 non-overlapping hopping channels, and all frequency hopping systems in the 5725-5850 MHz band: 1 watt.
For all other frequency hopping systems in the 2400-2483.5 MHz band: 0.125 watts.

8.3 Test procedure

1. Remove the antenna from the EUT and then connect a low RF cable from the antenna port to the spectrum.
2. Set the spectrum analyzer: RBW = 3MHz. VBW = 3MHz. Sweep = auto; Detector Function = Peak.
3. Keep the EUT in transmitting at lowest, medium and highest channel individually. Record the max value.

8.4 DEVIATION FROM STANDARD

No deviation.

8.5 Test Result

| Mode | Test channel | Peak Output Power (dBm) | Limit (dBm) | Result |
|----------------|--------------|-------------------------|-------------|--------|
| GFSK | Lowest | 1.948 | 21 | Pass |
| | Middle | 0.891 | | |
| | Highest | 0.298 | | |
| $\pi/4$ -DQPSK | Lowest | 2.534 | 21 | Pass |
| | Middle | 1.583 | | |
| | Highest | 0.828 | | |
| 8-DPSK | Lowest | 2.956 | 21 | Pass |
| | Middle | 2.104 | | |
| | Highest | 1.537 | | |

9. Hopping Channel Separation

| | |
|-------------------|--|
| Test Requirement: | FCC Part15 C Section 15.247 (a)(1) |
| Test Method: | ANSI C63.10:2013 |
| Receiver setup: | RBW=100KHz, VBW=300KHz, detector=Peak |
| Limit: | 0.025MHz or 2/3 of the 20dB bandwidth (whichever is greater) |

9.1 Test Setup

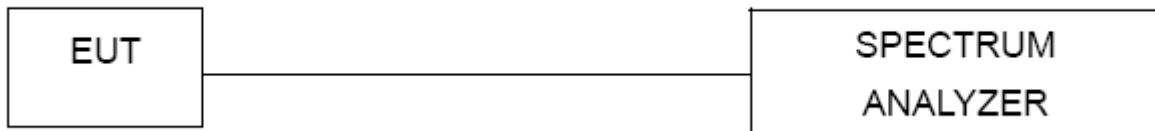

9.2 Test procedure

1. Remove the antenna from the EUT and then connect a low RF cable from the antenna port to the spectrum.
2. Set the spectrum analyzer: RBW = 100kHz. VBW = 300kHz , Span = 3.0MHz. Sweep = auto; Detector Function = Peak. Trace = Max hold.
3. Allow the trace to stabilize. Use the marker-delta function to determine the separation between the peaks of the adjacent channels. The limit is specified in one of the subparagraphs of this Section Submit this plot.

9.3 DEVIATION FROM STANDARD

No deviation.

9.4 Test Result

| Modulation | Test Channel | Separation (MHz) | Limit(MHz) | Result |
|----------------|--------------|------------------|------------|--------|
| GFSK | Low | 1.003 | 0.8593 | PASS |
| GFSK | Middle | 0.994 | 0.884 | PASS |
| GFSK | High | 1.000 | 0.8931 | PASS |
| $\pi/4$ -DQPSK | Low | 0.999 | 0.810 | PASS |
| $\pi/4$ -DQPSK | Middle | 0.996 | 0.840 | PASS |
| $\pi/4$ -DQPSK | High | 0.994 | 0.839 | PASS |
| 8-DPSK | Low | 0.997 | 0.843 | PASS |
| 8-DPSK | Middle | 0.997 | 0.838 | PASS |
| 8-DPSK | High | 0.631 | 0.845 | PASS |

Test plots GFSK Low Channel

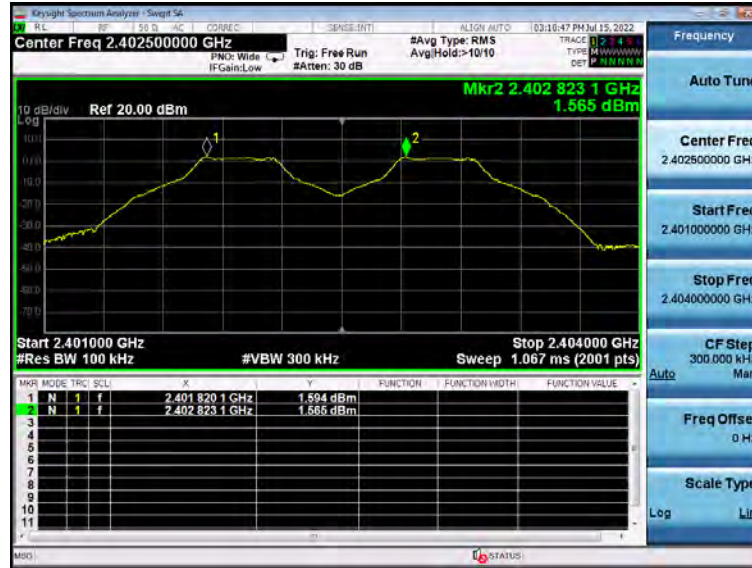

GFSK Middle Channel

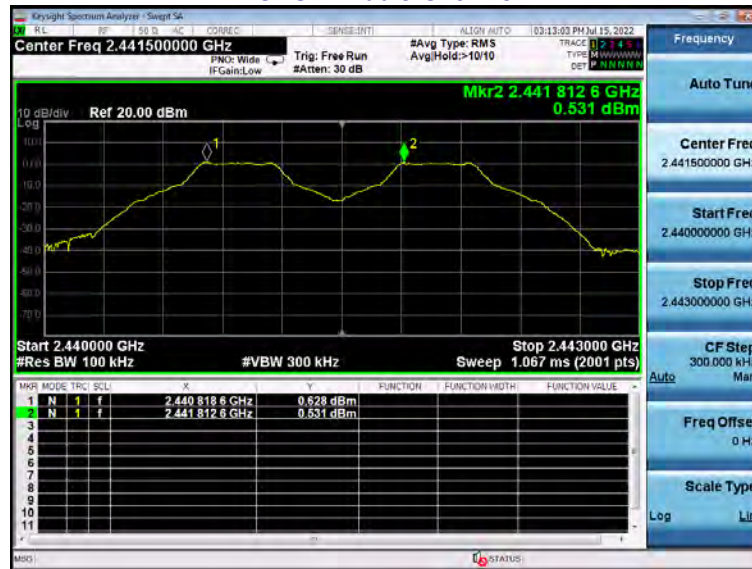

GFSK High Channel



$\pi/4$ -DQPSK Low Channel

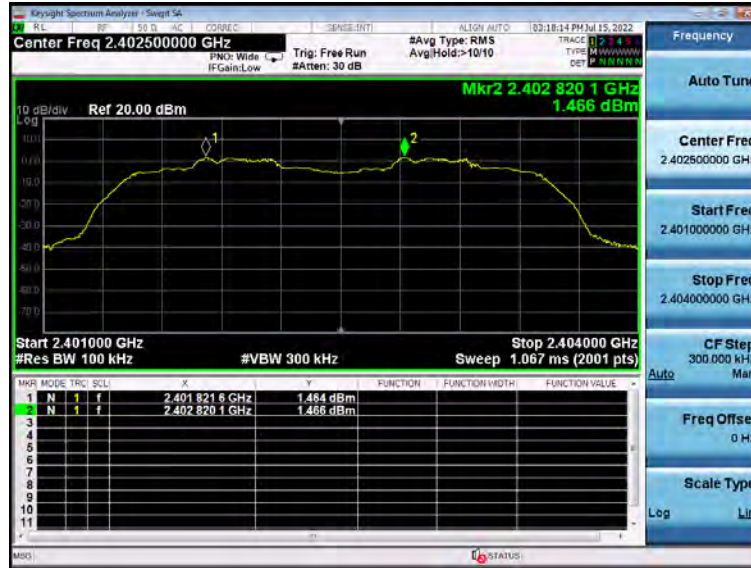

$\pi/4$ -DQPSK Middle Channel



$\pi/4$ -DQPSK High Channel



8-DPSK Low Channel



8-DPSK Middle Channel



8-DPSK High Channel



10.NUMBER OF HOPPING FREQUENCY

| | |
|-------------------|--|
| Test Requirement: | FCC Part15 C Section 15.247 (a)(1)(iii) |
| Test Method: | ANSI C63.10:2013 |
| Receiver setup: | RBW=100kHz, VBW=300kHz, Frequency range=2400MHz-2483.5MHz, Detector=Peak |
| Limit: | 15 channels |

10.1 Test Setup



10.2 Test procedure

1. Remove the antenna from the EUT and then connect a low RF cable from the antenna port to the spectrum.
2. Set the spectrum analyzer: RBW = 100kHz. VBW = 300kHz. Sweep = auto; Detector Function = Peak. Trace = Max hold.
3. Allow the trace to stabilize. It may prove necessary to break the span up to sections. in order to clearly show all of the hopping frequencies. The limit is specified in one of the subparagraphs of this Section.
4. Set the spectrum analyzer: Start Frequency = 2.4GHz, Stop Frequency = 2.4835GHz. Sweep=auto;

10.3 DEVIATION FROM STANDARD

No deviation.

10.4 Test Result

Test Plots: 79 Channels in total GFSK



$\pi/4$ -DQPSK



8-DPSK



11. DWELL TIME

| | |
|-------------------|---|
| Test Requirement: | FCC Part15 C Section 15.247 (a)(1)(iii) |
| Test Method: | ANSI C63.10:2013 |
| Receiver setup: | RBW=1MHz, VBW=3MHz, Span=0Hz, Detector=Peak |
| Limit: | 0.4 Second |

11.1 Test Setup



11.2 Test procedure

1. Remove the antenna from the EUT and then connect a low RF cable from the antenna port to the spectrum.
2. Set spectrum analyzer span = 0Hz;
3. Set RBW = 1MHz and VBW = 3MHz. Sweep = as necessary to capture the entire dwell time per hopping channel. Set the EUT for DH5, DH3 and DH1 packet transmitting.
4. Use the marker-delta function to determine the dwell time. If this value varies with different modes of operation (e.g.. data rate. modulation format. etc.). repeat this test for each variation. The limit is specified in one of the subparagraphs of this Section. Submit this plot(s).

11.3 DEVIATION FROM STANDARD

No deviation.

11.4 Test Result

| Frequency | Packet | Burst Width [ms/hop/ch] | Dwell time(ms) | Limit(ms) | Result |
|-----------|--------|----------------------------|----------------|-----------|--------|
| 2441MHz | DH1 | 0.400 | 128.000 | 400 | Pass |
| 2441MHz | DH3 | 1.656 | 264.960 | 400 | Pass |
| 2441MHz | DH5 | 2.902 | 309.547 | 400 | Pass |
| 2441MHz | 2-DH1 | 0.408 | 130.560 | 400 | Pass |
| 2441MHz | 2-DH3 | 1.661 | 265.760 | 400 | Pass |
| 2441MHz | 2-DH5 | 2.909 | 310.293 | 400 | Pass |
| 2441MHz | 3-DH1 | 0.411 | 131.520 | 400 | Pass |
| 2441MHz | 3-DH3 | 1.662 | 265.920 | 400 | Pass |
| 2441MHz | 3-DH5 | 2.91 | 310.400 | 400 | Pass |

Remarks:

The test period: $T = 0.4 \text{ Second/Channel} \times 79 \text{ Channel} = 31.6 \text{ s}$

Test channel: 2402MHz as blow

DH1 2DH1 3DH1 time slot= $\text{Burst Width(ms)} \times (1600 / (2 \times 79)) \times 31.6$

DH3 2DH3 3DH3 time slot= $\text{Burst Width(ms)} \times (1600 / (4 \times 79)) \times 31.6$

DH5 2DH5 3DH5 time slot= $\text{Burst Width(ms)} \times (1600 / (6 \times 79)) \times 31.6$

Test Plots

GFSK DH1 2441MHZ

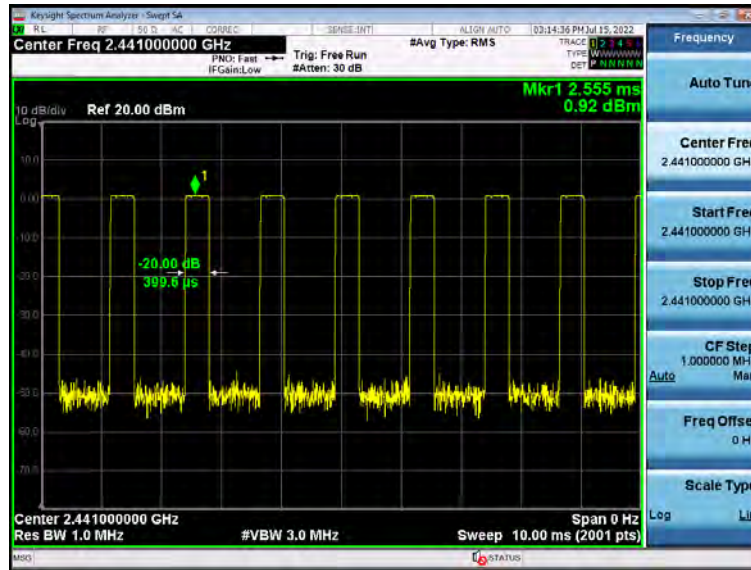

GFSK DH3 2441MHZ



GFSK DH5 2441MHZ



$\pi/4$ -DQPSK 2DH1 2441MHZ

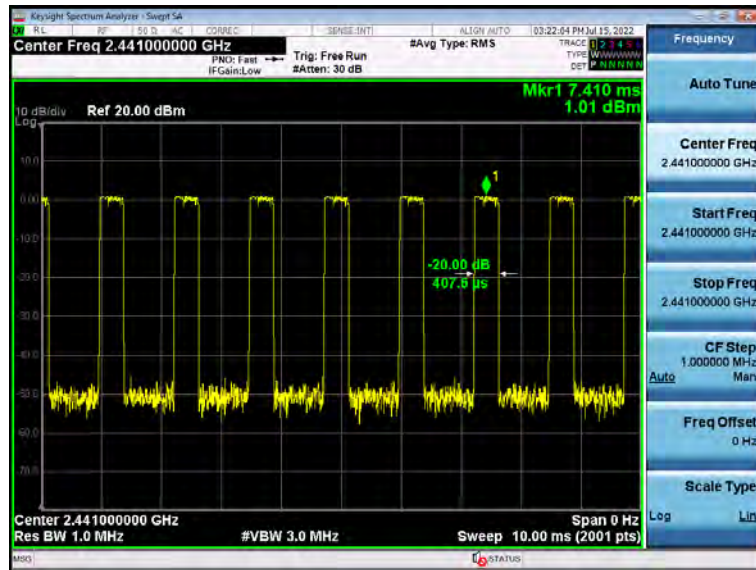

$\pi/4$ -DQPSK 2DH3 2441MHZ

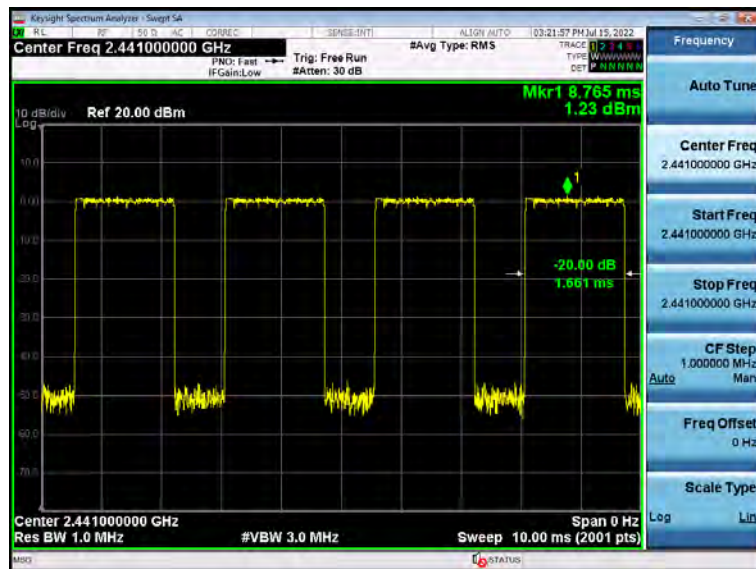

$\pi/4$ -DQPSK 2DH5 2441MHZ

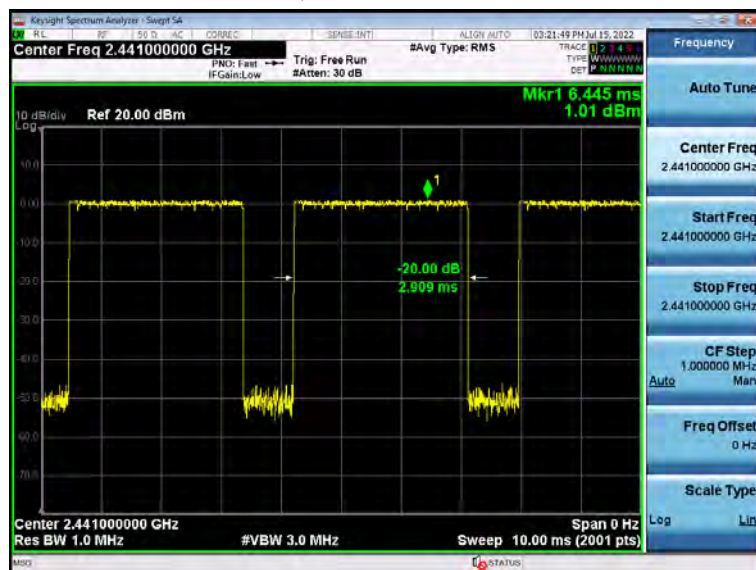

8-DPSK 3DH1 2441MHZ

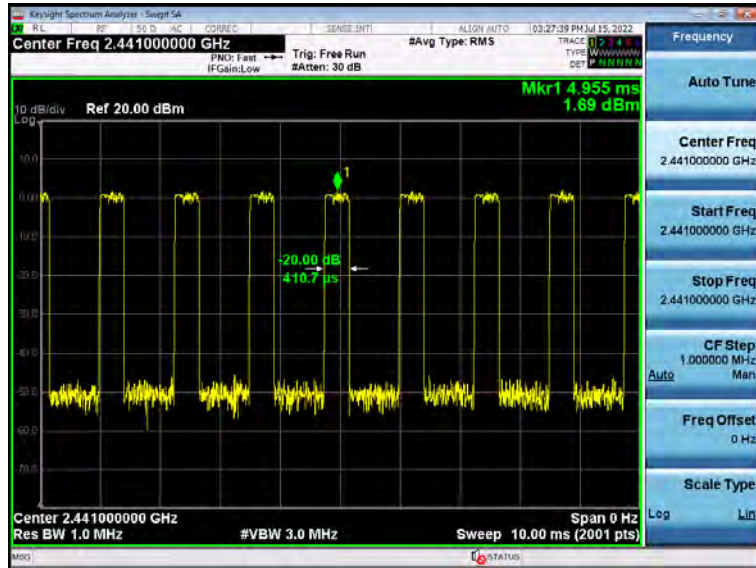

8-DPSK 3DH3 2441MHZ

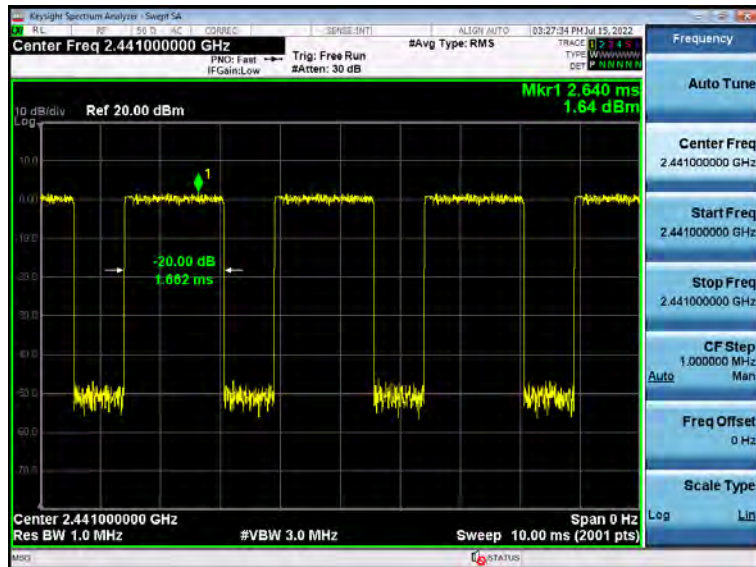

8-DPSK 3DH5 2441MHZ

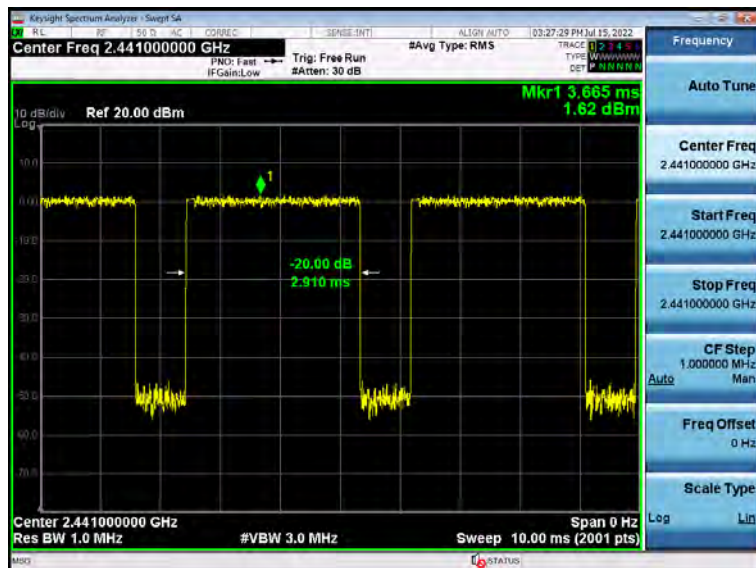

12. Antenna Requirement

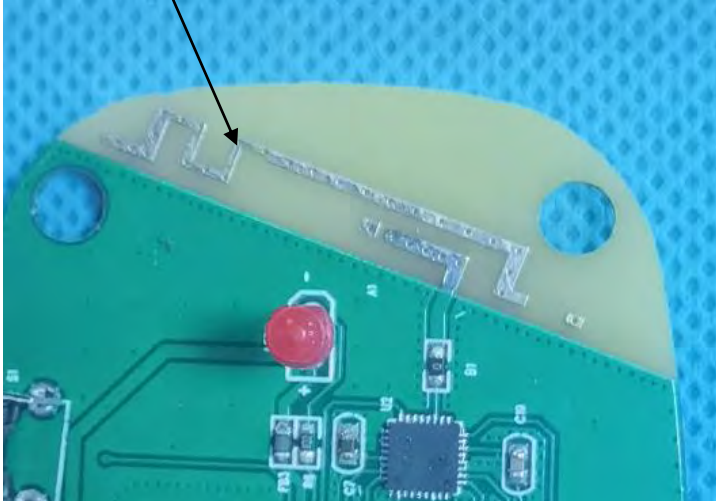
| | |
|--|-------------------------------------|
| Standard requirement: | FCC Part15 C Section 15.203 /247(c) |
| <p>15.203 requirement: An intentional radiator shall be designed to ensure that no antenna other than that furnished by the responsible party shall be used with the device. The use of a permanently attached antenna or of an antenna that uses a unique coupling to the intentional radiator, the manufacturer may design the unit so that a broken antenna can be replaced by the user, but the use of a standard antenna jack or electrical connector is prohibited.</p> <p>15.247(c) (1)(i) requirement: (i) Systems operating in the 2400-2483.5 MHz band that is used exclusively for fixed. Point-to-point operations may employ transmitting antennas with directional gain greater than 6dBi provided the maximum conducted output power of the intentional radiator is reduced by 1 dB for every 3 dB that the directional gain of the antenna exceeds 6dBi.</p> | |
| EUT Antenna: | |
| <p>The antenna is PCB antenna, the best case gain of the antennas are 0dBi, reference to the below photo for details</p> <p style="text-align: center;">ANT for BT</p>  | |

13. Test Setup Photo



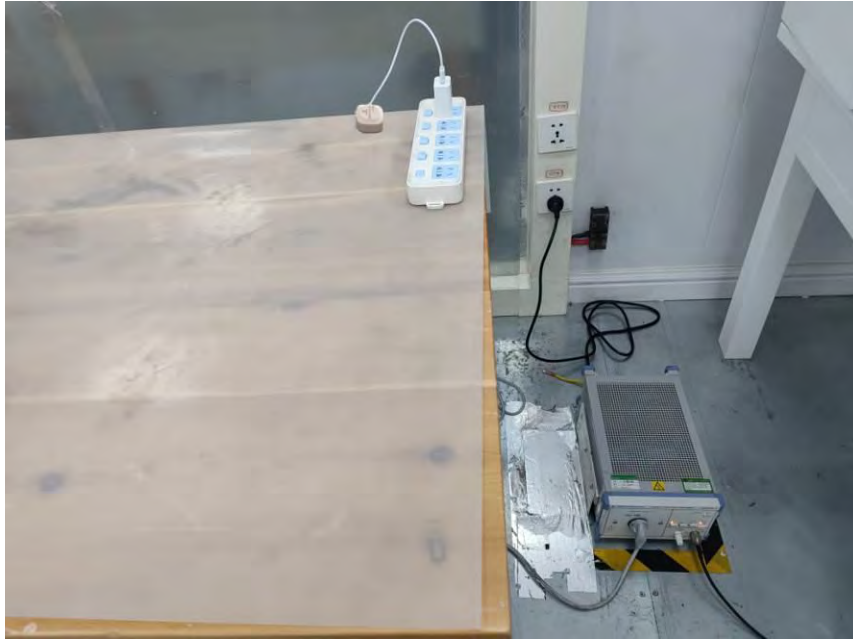

14. EUT Constructional Details

External photos file





internal photos

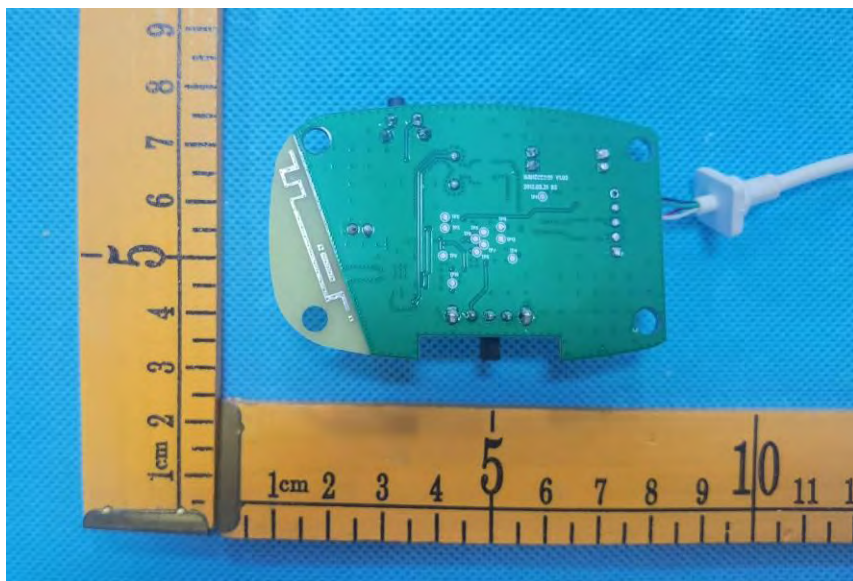
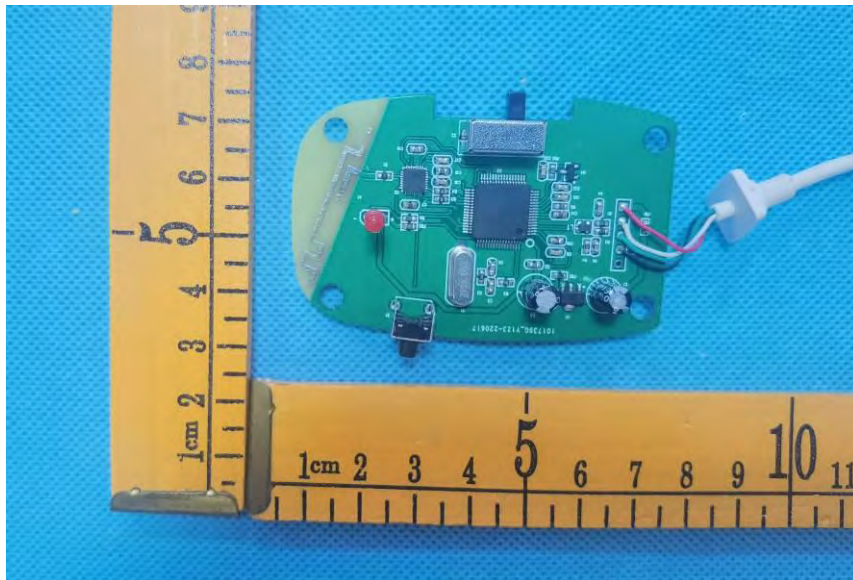
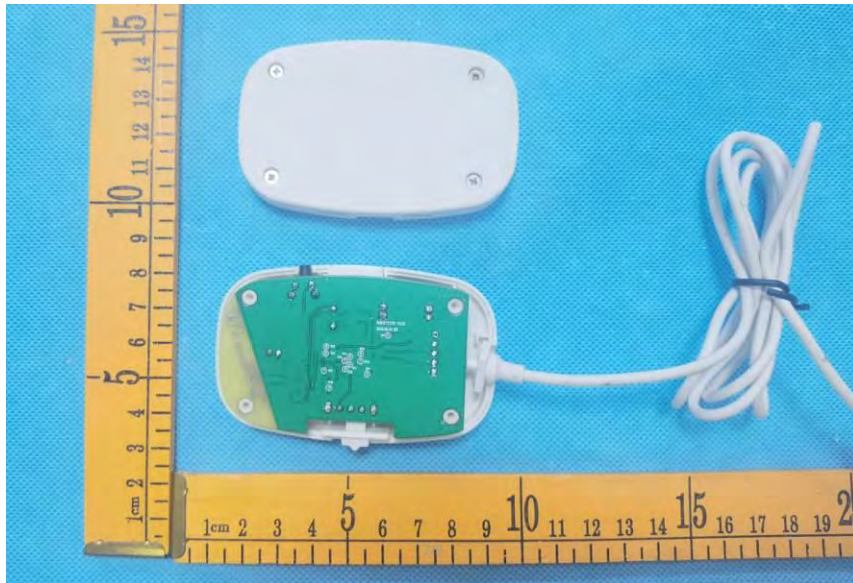

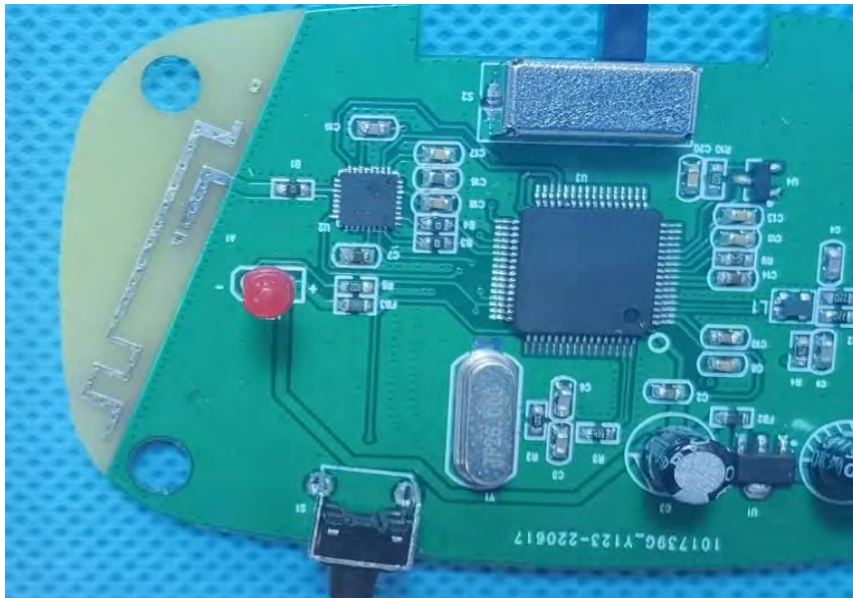

***** END OF REPORT *****