



# FCC Part 15C Test Report

## FCC ID:2ASVO05B7CT200

Product Name:	FM transmitter
Trademark:	N/A
Model Name :	CZE-7C CZE-05B, CZE-T200, ST-05B, ST-7C, ST-T200
Prepared For :	Guangzhou Chuangzhou Electronic Technology co., Ltd
Address :	2/F, No.3 ChuangYe Second Road, GuanDaovillage, ShaPu, XinTang Town, ZengCheng District, GuangZhou, China
Prepared By :	Shenzhen BCTC Testing Co., Ltd.
Address :	BCTC Building & 1-2F, East of B Building, Pengzhou Industrial, Fuyuan 1st Road, Qiaotou Community, Fuyong Street, Bao'an District, Shenzhen, China
Test Date:	Mar. 19, 2019 to Apr. 19, 2019
Date of Report :	Apr. 19, 2019
Report No.:	BCTC-FY190301270E

## VERIFICATION OF COMPLIANCE

**Applicant's name** ..... Guangzhou Chuangzhou Electronic Technology co., Ltd  
**Address** ..... 2/F, No.3 ChuangYe Second Road, GuanDaovillage, ShaPu, XinTang  
Town, ZengCheng District, GuangZhou, China

**Manufacture's Name**... Guangzhou Chuangzhou Electronic Technology co., Ltd  
**Address** ..... 2/F, No.3 ChuangYe Second Road, GuanDaovillage, ShaPu, XinTang  
Town, ZengCheng District, GuangZhou, China

### Product description

**Product name** ..... FM transmitter  
**Trademark:** N/A  
**Model Name:** CZE-7C  
CZE-05B, CZE-T200, ST-05B, ST-7C, ST-T200  
FCC Part15.239  
**Test Standards:** ANSI C63.10:2013

This device described above has been tested by BCTC, and the test results show that the equipment under test (EUT) is in compliance with the FCC requirements. And it is applicable only to the tested sample identified in the report.

This report shall not be reproduced except in full, without the written approval of BCTC, this document may be altered or revised by BCTC, personal only, and shall be noted in the revision of the document.

Test Result..... **Pass**

Prepared by(Engineer): Leke Xie



Reviewer(Supervisor): Eric Yang



Approved(Manager): Zero Zhou



<b>Table of Contents</b>	<b>Page</b>
<b>1 . SUMMARY OF TEST RESULTS</b>	<b>5</b>
1.1 TEST FACILITY	6
1.2 MEASUREMENT UNCERTAINTY	6
<b>2 . GENERAL INFORMATION</b>	<b>7</b>
2.1 GENERAL DESCRIPTION OF EUT	7
2.2 DESCRIPTION OF TEST MODES	8
2.3 BLOCK DIGRAM SHOWING THE CONFIGURATION OF SYSTEM TESTED	8
2.4 DESCRIPTION OF SUPPORT UNITS(CONDUCTED MODE)	8
2.5 EQUIPMENTS LIST FOR ALL TEST ITEMS	10
<b>3 . EMC EMISSION TEST</b>	<b>12</b>
3.1 CONDUCTED EMISSION MEASUREMENT	12
3.1.1 POWER LINE CONDUCTED EMISSION LIMITS	12
3.1.2 TEST PROCEDURE	13
3.1.3 DEVIATION FROM TEST STANDARD	13
3.1.4 TEST SETUP	13
3.1.5 EUT OPERATING CONDITIONS	13
3.1.6 TEST RESULTS	14
3.2 RADIATED EMISSION MEASUREMENT	16
3.2.1 RADIATED EMISSION LIMITS	16
3.2.2 TEST PROCEDURE	17
3.2.3 TEST SETUP	18
3.2.4 EUT OPERATING CONDITIONS	19
3.2.5 TEST RESULTS	20
<b>4 . BANDWIDTH TEST</b>	<b>31</b>
4.1 APPLIED PROCEDURES / LIMIT	31
4.1.1 TEST PROCEDURE	31
4.1.2 DEVIATION FROM STANDARD	31
4.1.3 TEST SETUP	31
4.1.4 EUT OPERATION CONDITIONS	31
4.1.5 TEST RESULTS	32
<b>5 . BAND EDGE MEASUREMENT</b>	<b>34</b>
6.1 APPLICABLE STANDARD	34
6.2 TEST PROCEDURE	34
6.3 DEVIATION FROM STANDARD	34
6.4 TEST SETUP	34
6.5 EUT OPERATION CONDITIONS	34



<b>Table of Contents</b>	<b>Page</b>
<b>6 . ANTENNA REQUIREMENT</b>	<b>37</b>
6.1 STANDARD REQUIREMENT	37
6.2 EUT ANTENNA	37
<b>7 . EUT TEST PHOTO</b>	<b>38</b>
<b>8 . EUT PHOTO</b>	<b>40</b>
<b>APPENDIX-PHOTOGRAPHS OF EUT CONSTRUCTIONAL DETAILS</b>	

## 1. SUMMARY OF TEST RESULTS

Test procedures according to the technical standards:

FCC Part15 (15.239) , Subpart C			
Standard Section	Test Item	Judgment	Remark
15.207	Conducted Emission	PASS	
15.209&15.239	Fundamental &Radiated Spurious Emission Measurement	PASS	
15.239a	Occupy Bandwidth	PASS	
15.203	Antenna Requirement	PASS	
15.239a	Band Edge Measurement	PASS	

NOTE:

(1) "N/A" denotes test is not applicable in this Test Report



## 1.1 TEST FACILITY

Shenzhen BCTC Testing Co., Ltd.

Add.: BCTC Building & 1-2F, East of B Building, Pengzhou Industrial, Fuyuan 1st Road, Qiaotou Community, Fuyong Street, Bao'an District, Shenzhen, China

FCC Test Firm Registration Number: 712850

IC Registered No.: 23583

## 1.2 MEASUREMENT UNCERTAINTY

The reported uncertainty of measurement  $y \pm U$ , where expanded uncertainty  $U$  is based on a standard uncertainty multiplied by a coverage factor of  $k=2$ , providing a level of confidence of approximately **95 %**.

No.	Item	Uncertainty
1	3m chamber Radiated spurious emission(30MHz-1GHz)	U=4.3dB
2	3m chamber Radiated spurious emission(1GHz-18GHz)	U=4.5dB
3	3m chamber Radiated spurious emission(18GHz-40GHz)	U=3.34dB
4	Conducted Adjacent channel power	U=1.38dB
5	Conducted output power uncertainty Above 1G	U=1.576dB
6	Conducted output power uncertainty below 1G	U=1.28dB
7	humidity uncertainty	U=5.3%
8	Temperature uncertainty	U=0.59°C



## 2. GENERAL INFORMATION

### 2.1 GENERAL DESCRIPTION OF EUT

Equipment	FM transmitter								
Trade Name	N/A								
Model Name	CZE-7C								
Serial Model	CZE-05B, CZE-T200, ST-05B, ST-7C, ST-T200								
Model Difference	All the model are the same circuit and RF module, except model names .								
Product Description	<table border="1"> <tr> <td>Operation Frequency:</td> <td>88.1 MHz ~107.9MHz</td> </tr> <tr> <td>Modulation Type:</td> <td>FM</td> </tr> <tr> <td>Antenna Type:</td> <td>External antenna with RP-SMA connector</td> </tr> <tr> <td>Antenna Gain:</td> <td>1dBi</td> </tr> </table>	Operation Frequency:	88.1 MHz ~107.9MHz	Modulation Type:	FM	Antenna Type:	External antenna with RP-SMA connector	Antenna Gain:	1dBi
	Operation Frequency:	88.1 MHz ~107.9MHz							
	Modulation Type:	FM							
	Antenna Type:	External antenna with RP-SMA connector							
	Antenna Gain:	1dBi							
Based on the application, features, or specification exhibited in User's Manual, the EUT is considered as an ITE/Computing Device. More details of EUT technical specification, please refer to the User's Manual.									
Adapter Ratings	INPUT: 100-240V~, 50-60Hz 0.6A OUTPUT: 12V 1.67A								
Connecting I/O Port(s)	Please refer to the User's Manual								
hardware version	H1.0								
Software version	V1.0								
Serial number	N/A								

Note:

1. For a more detailed features description, please refer to the manufacturer's specifications or the User's Manual.



## 2.2 DESCRIPTION OF TEST MODES

For All Emission	
Final Test Mode	Description
Mode 1	CH01
Mode 2	CH100
Mode 3	CH199
Mode 4	Link mode(conducted emission and Radiated emission)

Channel	Frequency (MHz)
01	88.1
02	88.2
03	88.3
~	~
198	107.8
199	107.9

Note:

(1) The measurements are performed at the highest, middle, lowest available channels.

## 2.3 BLOCK DIGRAM SHOWING THE CONFIGURATION OF SYSTEM TESTED

Conducted Emission Test

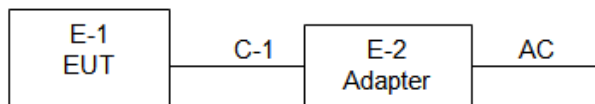

Spurious emissions

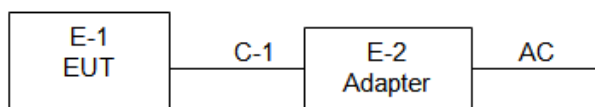

## 2.4 DESCRIPTION OF SUPPORT UNITS(CONDUCTED MODE)

The EUT has been tested as an independent unit together with other necessary accessories or support units. The following support units or accessories were used to form a representative test configuration during the tests.





Item	Equipment	Mfr/Brand	Model/Type No.	Series No.	Note
E-1	FM transmitter	N/A	CZE-7C	N/A	EUT
E-2	Adapter	N/A	ADS0202-U120167	N/A	EUT

Item	Shielded Type	Ferrite Core	Length	Note
C-1	NO	NO	1.0M	DC cable unshielded

Note:

- (1) The support equipment was authorized by Declaration of Confirmation.
- (2) For detachable type I/O cable should be specified the length in cm in 『Length』 column.
- (3) “YES” is means “shielded” “with core”; “NO” is means “unshielded” “without core”.



## 2.5 EQUIPMENTS LIST FOR ALL TEST ITEMS

### Radiation Test equipment

Item	Equipment	Manufacturer	Type No.	Serial No.	Last calibration	Calibrated until
1	Spectrum Analyzer (9kHz-26.5GHz)	Agilent	E4407B	MY45109572	2018.06.20	2019.06.20
2	Test Receiver (9kHz-7GHz)	R&S	ESR7	101154	2018.06.20	2019.06.20
3	Bilog Antenna (30MHz-3GHz)	SCHWARZBECK	VULB9163	VULB9163-942	2018.06.23	2019.06.23
4	Horn Antenna (1GHz-18GHz)	SCHWARZBECK	BBHA9120D	1541	2018.06.23	2021.06.22
5	Horn Antenna (18GHz-40GHz)	SCHWARZBECK	BBHA9170	822	2018.08.06	2019.08.06
6	Amplifier (9kHz-6GHz)	SCHWARZBECK	BBV9744	9744-0037	2018.06.20	2019.06.20
7	Amplifier (0.5GHz-18GHz)	SCHWARZBECK	BBV9718	9718-309	2018.06.20	2019.06.20
8	Amplifier (18GHz-40GHz)	MITEQ	TTA1840-35-HG	2034381	2018.08.06	2019.08.06
9	Loop Antenna (9kHz-30MHz)	SCHWARZBECK	FMZB1519B	014	2018.06.23	2019.06.23
10	RF cables1 (9kHz-30MHz)	Huber+Suhnar	9kHz-30MHz	B1702988-0008	2019.02.12	2020.02.12
11	RF cables2 (30MHz-1GHz)	Huber+Suhnar	30MHz-1GHz	1486150	2019.03.27	2020.03.27
12	RF cables3 (1GHz-40GHz)	Huber+Suhnar	1GHz-40GHz	1607106	2018.06.19	2019.06.19
13	Power Metter	Keysight	E4419	\	2018.06.15	2019.04.15
14	Power Sensor (AV)	Keysight	E9 300A	\	2018.06.15	2019.04.15
15	Signal Analyzer 20kHz-26.5GHz	KEYSIGHT	N9020A	MY49100060	2018.08.14	2019.08.13
16	Test Receiver 9kHz-40GHz	R&S	FSP40	100550	2018.06.13	2019.06.12
17	D.C. Power Supply	LongWei	TPR-6405D	\	\	\
18	Software	Frad	EZ-EMC	FA-03A2 RE	\	\



Conduction Test equipment

Item	Equipment	Manufacturer	Type No.	Serial No.	Last calibration	Calibrated until
1	Test Receiver	R&S	ESR3	102075	2018.06.20	2019.06.20
2	LISN	SCHWARZBEC K	NSLK8127	8127739	2018.06.19	2019.06.19
3	LISN	R&S	ENV216	101375	2018.06.20	2019.06.20
4	RF cables	Huber+Suhnar	9kHz-30MHz	B1702988-00 08	2019.02.12	2020.02.12
5	Software	Frad	EZ-EMC	EMC-CON 3A1	\	\



### 3. EMC EMISSION TEST

#### 3.1 CONDUCTED EMISSION MEASUREMENT

##### 3.1.1 POWER LINE CONDUCTED EMISSION Limits (Frequency Range 150KHz-30MHz)

FREQUENCY (MHz)	Limit (dBuV)		Standard
	Quasi-peak	Average	
0.15 -0.5	66 - 56 *	56 - 46 *	FCC
0.50 -5.0	56.00	46.00	FCC
5.0 -30.0	60.00	50.00	FCC

Note:

- (1) The tighter limit applies at the band edges.
- (2) The limit of " \* " marked band means the limitation decreases linearly with the logarithm of the frequency in the range.

The following table is the setting of the receiver

Receiver Parameters	Setting
Attenuation	10 dB
Start Frequency	0.15 MHz
Stop Frequency	30 MHz
IF Bandwidth	9 kHz



### 3.1.2 TEST PROCEDURE

- a. The EUT was placed 0.8 meters from the horizontal ground plane with EUT being connected to the power mains through a line impedance stabilization network (LISN). All other support equipments powered from additional LISN(s). The LISN provide 50 Ohm/ 50uH of coupling impedance for the measuring instrument.
- b. Interconnecting cables that hang closer than 40 cm to the ground plane shall be folded back and forth in the center forming a bundle 30 to 40 cm long.
- c. I/O cables that are not connected to a peripheral shall be bundled in the center. The end of the cable may be terminated, if required, using the correct terminating impedance. The overall length shall not exceed 1 m.
- d. LISN at least 80 cm from nearest part of EUT chassis.
- e. For the actual test configuration, please refer to the related Item –EUT Test Photos.

### 3.1.3 DEVIATION FROM TEST STANDARD

No deviation

### 3.1.4 TEST SETUP

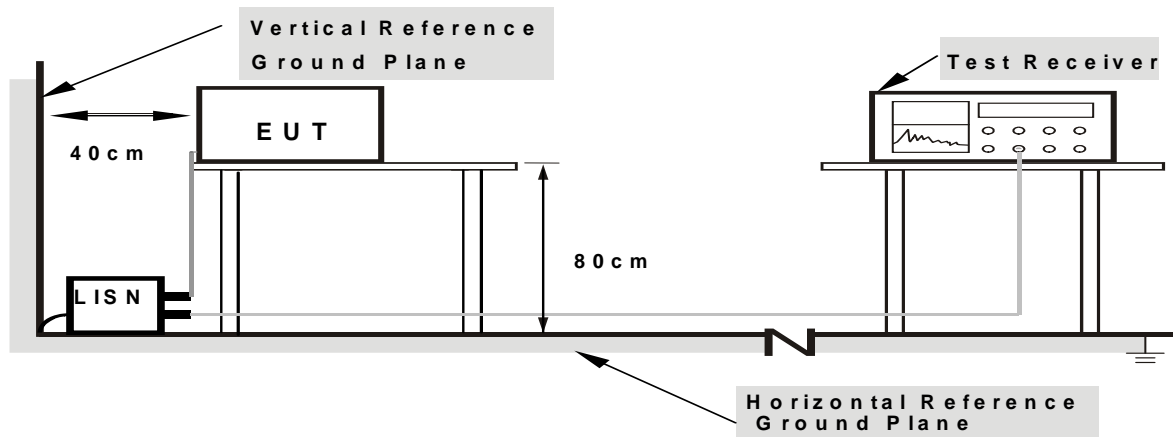

- Note: 1. Support units were connected to second LISN.  
2. Both of LISNs (AMN) are 80 cm from EUT and at least 80 cm from other units and other metal planes

### 3.1.5 EUT OPERATING CONDITIONS

The EUT was configured for testing in a typical fashion (as a customer would normally use it). The EUT has been programmed to continuously transmit during test. This operating condition was tested and used to collect the included data.

We pretest AC 120V and AC 240V, the worst voltage was AC 120V and the data recording in the report.



3.1.6 TEST RESULTS

Temperature :	26 °C	Relative Humidity :	54%
Pressure :	101kPa	Phase :	L
Test Voltage :	AC 120V/60Hz	Test Mode :	Mode 1

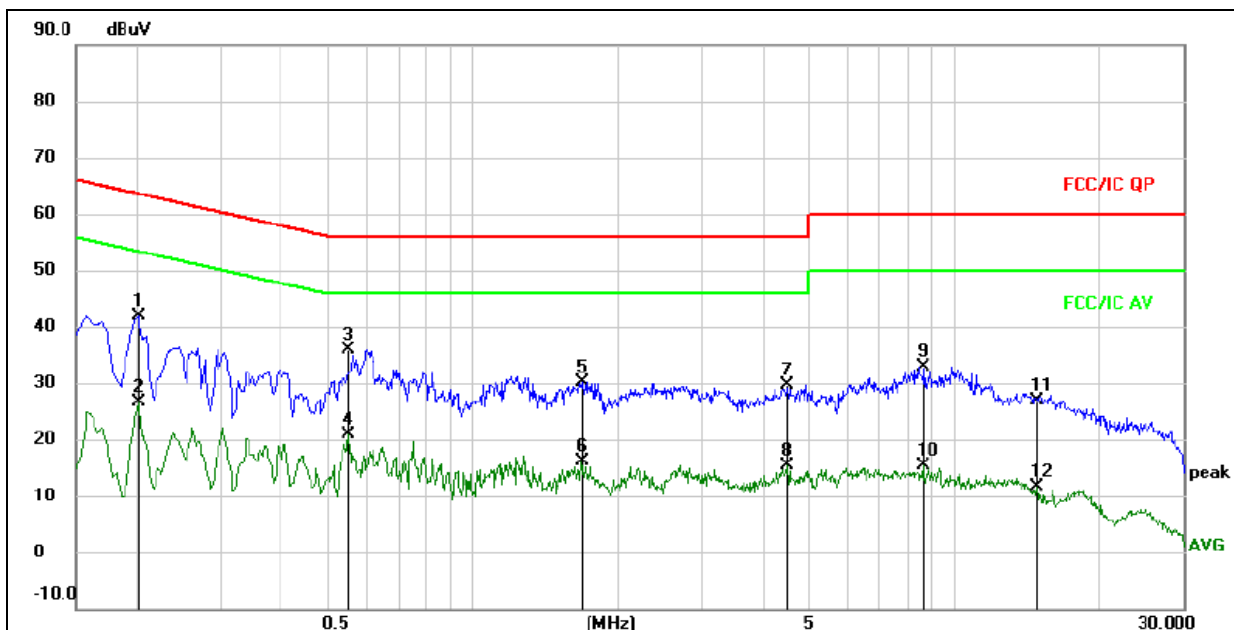

Remark:

1. All readings are Quasi-Peak and Average values.
2. Factor = Insertion Loss + Cable Loss.

No.	Mk.	Freq. MHz	Reading Level dBuV	Correct Factor	Measure- ment dBuV	Limit dBuV	Over dB	Detector	Comment
1		0.2020	32.40	9.46	41.86	63.53	-21.67	QP	
2		0.2020	17.10	9.46	26.56	53.53	-26.97	AVG	
3	*	0.5540	26.13	9.81	35.94	56.00	-20.06	QP	
4		0.5540	11.01	9.81	20.82	46.00	-25.18	AVG	
5		1.6740	20.58	9.58	30.16	56.00	-25.84	QP	
6		1.6740	6.47	9.58	16.05	46.00	-29.95	AVG	
7		4.5220	19.91	9.77	29.68	56.00	-26.32	QP	
8		4.5220	5.49	9.77	15.26	46.00	-30.74	AVG	
9		8.6140	23.06	9.70	32.76	60.00	-27.24	QP	
10		8.6140	5.73	9.70	15.43	50.00	-34.57	AVG	
11		14.8460	17.26	9.70	26.96	60.00	-33.04	QP	
12		14.8460	1.85	9.70	11.55	50.00	-38.45	AVG	



Temperature :	26 °C	Relative Humidity :	54%
Pressure :	101kPa	Phase :	N
Test Voltage :	AC 120V/60Hz	Test Mode :	Mode 1

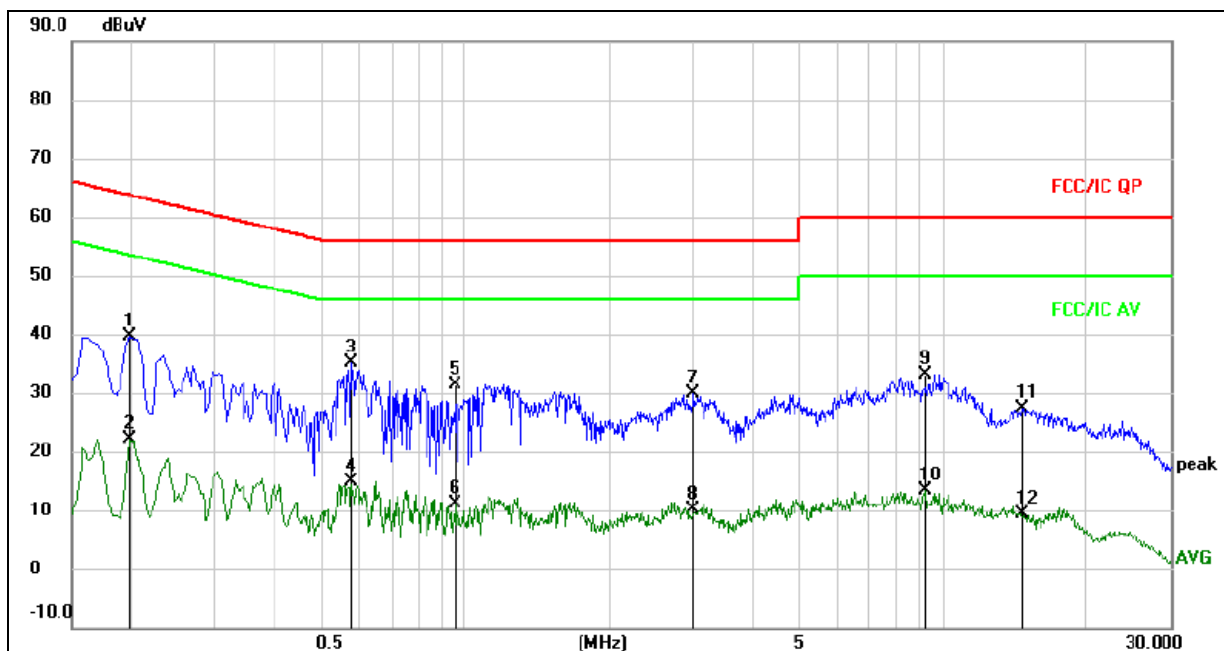

Remark:

1. All readings are Quasi-Peak and Average values.
2. Factor = Insertion Loss + Cable Loss.

No.	Mk.	Freq. MHz	Reading Level dBuV	Correct Factor	Measurement dBuV	Limit dBuV	Over dB	Detector	Comment
1		0.1980	30.12	9.46	39.58	63.69	-24.11	QP	
2		0.1980	12.68	9.46	22.14	53.69	-31.55	AVG	
3	*	0.5780	25.12	9.91	35.03	56.00	-20.97	QP	
4		0.5780	5.06	9.91	14.97	46.00	-31.03	AVG	
5		0.9580	21.74	9.58	31.32	56.00	-24.68	QP	
6		0.9580	1.48	9.58	11.06	46.00	-34.94	AVG	
7		2.9940	20.34	9.66	30.00	56.00	-26.00	QP	
8		2.9940	0.37	9.66	10.03	46.00	-35.97	AVG	
9		9.2500	23.54	9.70	33.24	60.00	-26.76	QP	
10		9.2500	3.61	9.70	13.31	50.00	-36.69	AVG	
11		14.5420	17.73	9.70	27.43	60.00	-32.57	QP	
12		14.5420	-0.31	9.70	9.39	50.00	-40.61	AVG	



### 3.2 RADIATED EMISSION MEASUREMENT

#### 3.2.1 RADIATED EMISSION LIMITS (Frequency Range 9kHz-1000MHz)

20dBc in any 100 kHz bandwidth outside the operating frequency band. In case the emission fall within the restricted band specified on 15.209&15.239 limit in the table below has to be followed.

Frequencies(MHz)	Field Strength(micorvolts/meter)	Measurement Distance(meters)
0.009~0.490	2400/F(KHz)	300
0.490~1.705	24000/F(KHz)	30
1.705~30.0	30	30
30~88	100	3
88~216	150	3
216~960	200	3
Above 960	500	3

#### LIMITS OF RADIATED EMISSION MEASUREMENT (Above 1000MHz)

FREQUENCY (MHz)	Limit (dBuV/m) (at 3M)	
	PEAK	AVERAGE
Above 1000	74	54

Notes:

- (1) The limit for radiated test was performed according to FCC PART 15C.
- (2) The tighter limit applies at the band edges.
- (3) Emission level (dBuV/m)=20log Emission level (uV/m).

#### FUNDAMENTAL AND HARMONICS EMISSION LIMITS

Fundamental Frequency (MHz)	Field Strength of Fundamental (microvolts/meter)	Field Strength of Spurious Emissions (microvolts/meter)
40.66 - 40.70	2,250	225
70 - 130	1,250	125
130 - 174	1,250 to 3,750 **	125 to 375 **
174 - 260	3,750	375
260 - 470	3,750 to 12,500 **	375 to 1,250 **
Above 470	12,500	1,250

\*\* linear interpolations

[Where F is the frequency in MHz, the formulas for calculating the maximum permitted fundamental field strengths are as follows: for the band 130-174 MHz,  $\mu\text{V}/\text{m}$  at 3 meters =  $56.81818(F) - 6136.3636$ ; for the band 260-470 MHz,  $\mu\text{V}/\text{m}$  at 3 meters =  $41.6667(F) - 7083.3333$ . The maximum permitted unwanted emission level is 20 dB below the maximum permitted fundamental level.]





FREQUENCY RANGE OF RADIATED MEASUREMENT (For unintentional radiators)

Highest frequency generated or Upper frequency of measurement used in the device or on which the device operates or tunes (MHz)	Range (MHz)
Below 1.705	30
1.705 – 108	1000
108 – 500	2000
500 – 1000	5000
Above 1000	5 <sup>th</sup> harmonic of the highest frequency or 40 GHz, whichever is lower

Spectrum Parameter	Setting
Attenuation	Auto
Start Frequency	1000 MHz
Stop Frequency	10th carrier harmonic
RBW / VBW setting	1 MHz / 1 MHz for Peak, 1 MHz / 10Hz for Average

Receiver Parameter	Setting
Attenuation	Auto
Start ~ Stop Frequency	9kHz~150kHz / RB 200Hz for QP
Start ~ Stop Frequency	150kHz~30MHz / RB 9kHz for QP
Start ~ Stop Frequency	30MHz~1000MHz / RB 120kHz for QP

**3.2.2 TEST PROCEDURE**

- a. The measuring distance of at 3 m shall be used for measurements at frequency up to 1GHz. For frequencies above 1GHz, any suitable measuring distance may be used.
- b. The EUT was placed on the top of a rotating table 0.8 meters above the ground at a 3 meter open area test site. The table was rotated 360 degrees to determine the position of the highest radiation.
- c. The height of the equipment or of the substitution antenna shall be 0.8 m; above 1GHz, the height was 1.5m, the height of the test antenna shall vary between 1 m to 4 m. Both horizontal and vertical polarizations of the antenna are set to make the measurement.
- d. The initial step in collecting conducted emission data is a spectrum analyzer peak detector mode pre-scanning the measurement frequency range. Significant peaks are then marked and then Quasi Peak detector mode re-measured.
- e. If the Peak Mode measured value compliance with and lower than Quasi Peak Mode Limit, the EUT shall be deemed to meet QP Limits and then no additional QP Mode measurement performed.
- f. For the actual test configuration, please refer to the related Item –EUT Test Photos.

Note:

Both horizontal and vertical antenna polarities were tested and performed pretest to three orthogonal axis. The worst case was X axis and the emissions were reported

### 3.2.3 TEST SETUP

(A) Radiated Emission Test-Up Frequency Below 30MHz

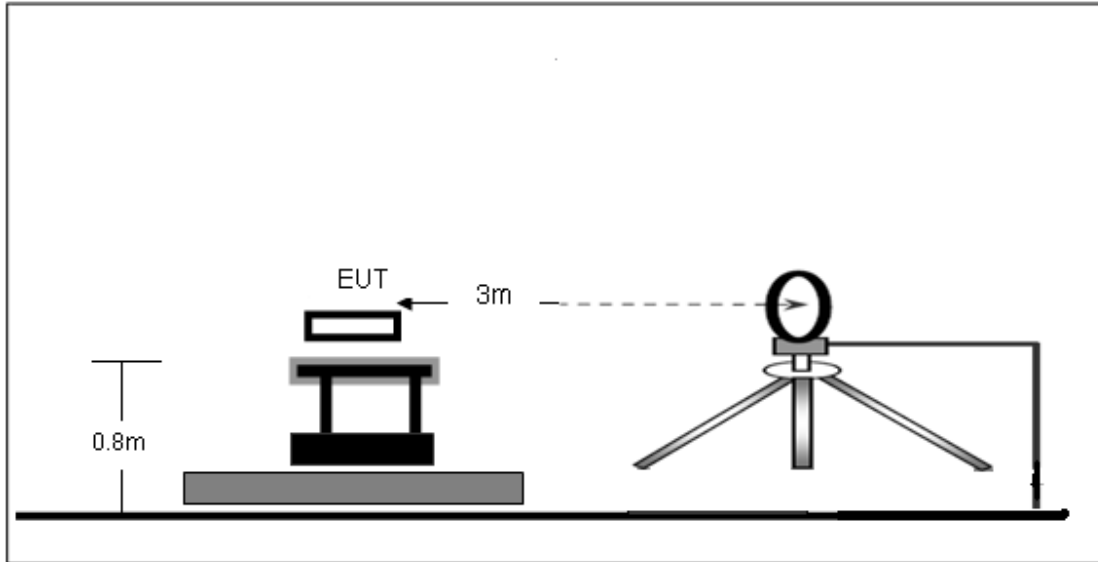

(B) Radiated Emission Test-Up Frequency 30MHz~1GHz

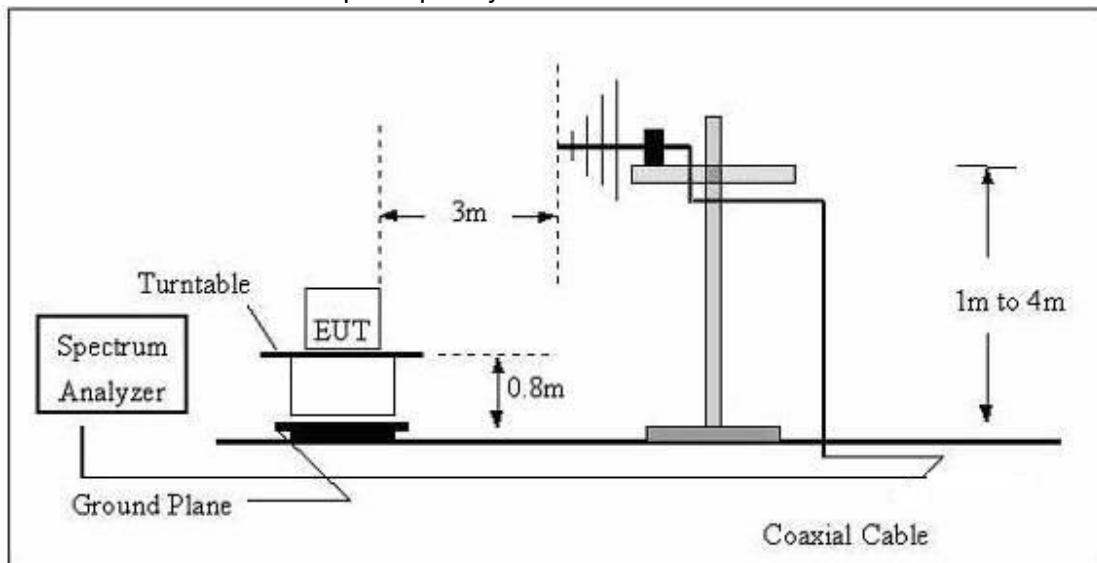

(C) Radiated Emission Test-Up Frequency Above 1GHz

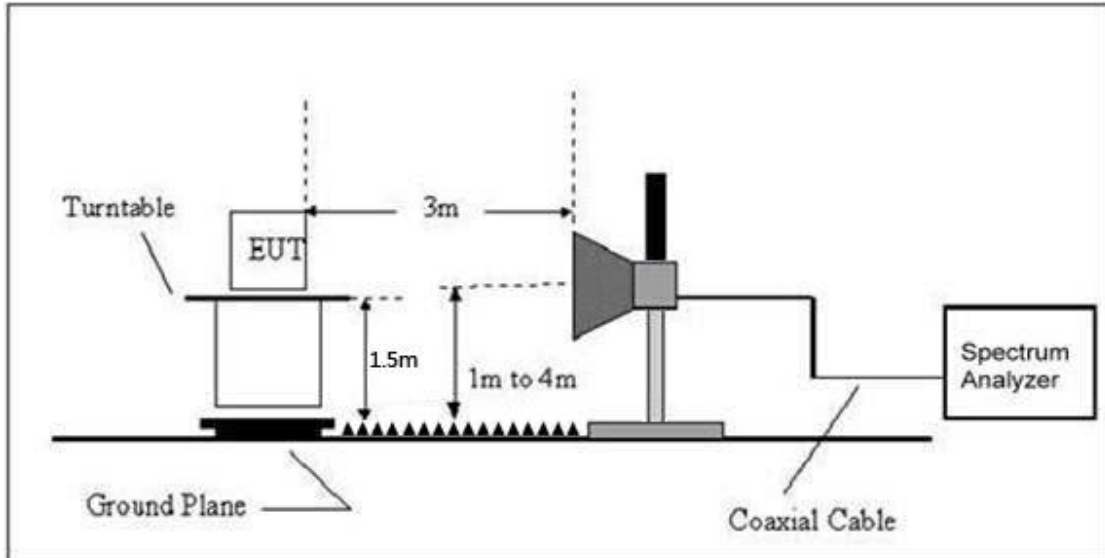

**3.2.4 EUT OPERATING CONDITIONS**

The EUT tested system was configured as the statements of 2.4 Unless otherwise a special operating condition is specified in the follows during the testing.



### 3.2.5 TEST RESULTS

Radiated Spurious Emission (Below 9KHz – 30MHz )

Temperature :	26 °C	Relative Humidity :	54%
Pressure :	101 kPa	Polarization :	---
Test Voltage :	AC 120V/60Hz		
Test Mode :	TX Mode		

Freq.	Reading	Limit	Margin	State
(MHz)	(dBuV/m)	(dBuV/m)	(dB)	P/F
--	--	--	--	PASS
--	--	--	--	PASS

**NOTE:**

The amplitude of spurious emissions which are attenuated by more than 20dB below the permissible value has no need to be reported.

Distance extrapolation factor =  $40 \log(\text{specific distance}/\text{test distance})$ (dB);

Limit line = specific limits(dBuv) + distance extrapolation factor.



Radiated Spurious Emission (Between 30MHz – 1GHz)

Temperature :	26 °C	Relative Humidity :	54%
Pressure :	101kPa	Phase :	H
Test Voltage :	AC 120V/60Hz	Test Mode :	Mode 1(88.1MHz)

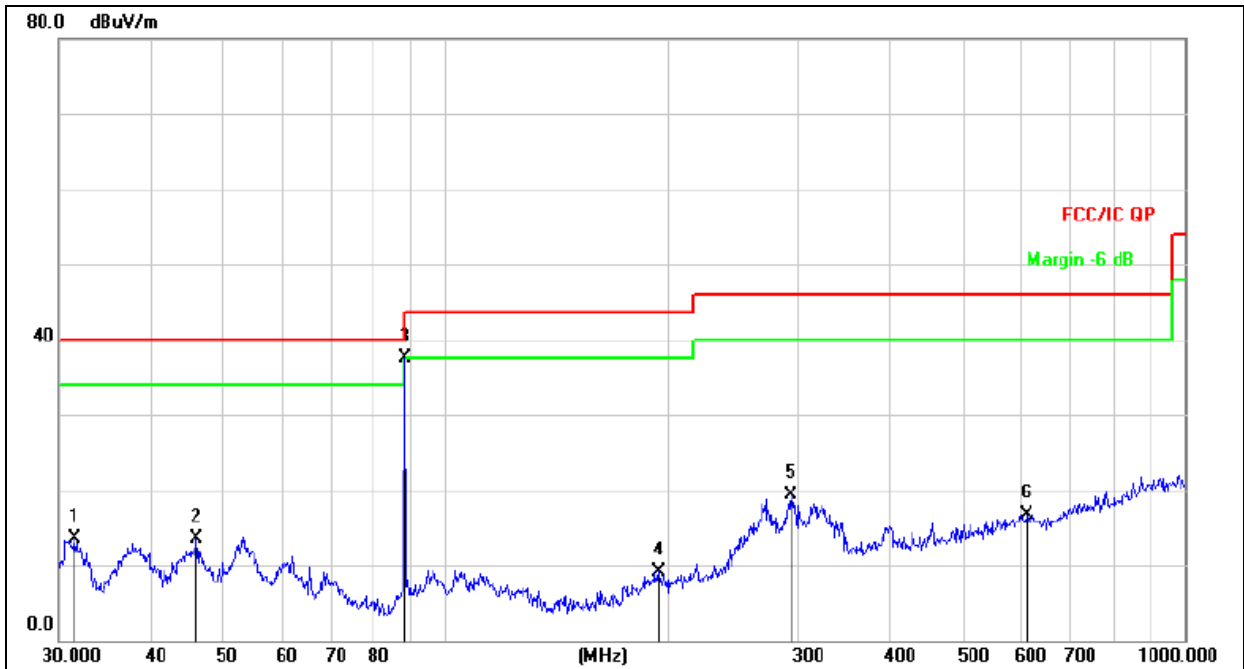

Remark:

1. All readings are Quasi-Peak and Average values.
2. Factor = Insertion Loss + Cable Loss.

No.	Mk.	Freq. MHz	Reading Level dBuV	Correct Factor dB	Measure- ment dBuV/m	Limit dB/m	Over dB	Detector
1		31.5095	30.46	-17.00	13.46	40.00	-26.54	QP
2		46.0164	28.65	-15.07	13.58	40.00	-26.42	QP
3	*	88.0329	56.13	-18.55	37.58	48.00	-10.42	peak
4		193.7728	25.90	-16.70	9.20	43.50	-34.30	QP
5		293.0842	33.04	-13.81	19.23	46.00	-26.77	QP
6		609.9217	23.34	-6.58	16.76	46.00	-29.24	QP



Temperature :	26 °C	Relative Humidity :	54%
Pressure :	101kPa	Phase :	V
Test Voltage :	AC 120V/60Hz	Test Mode :	Mode 1(88.1MHz)

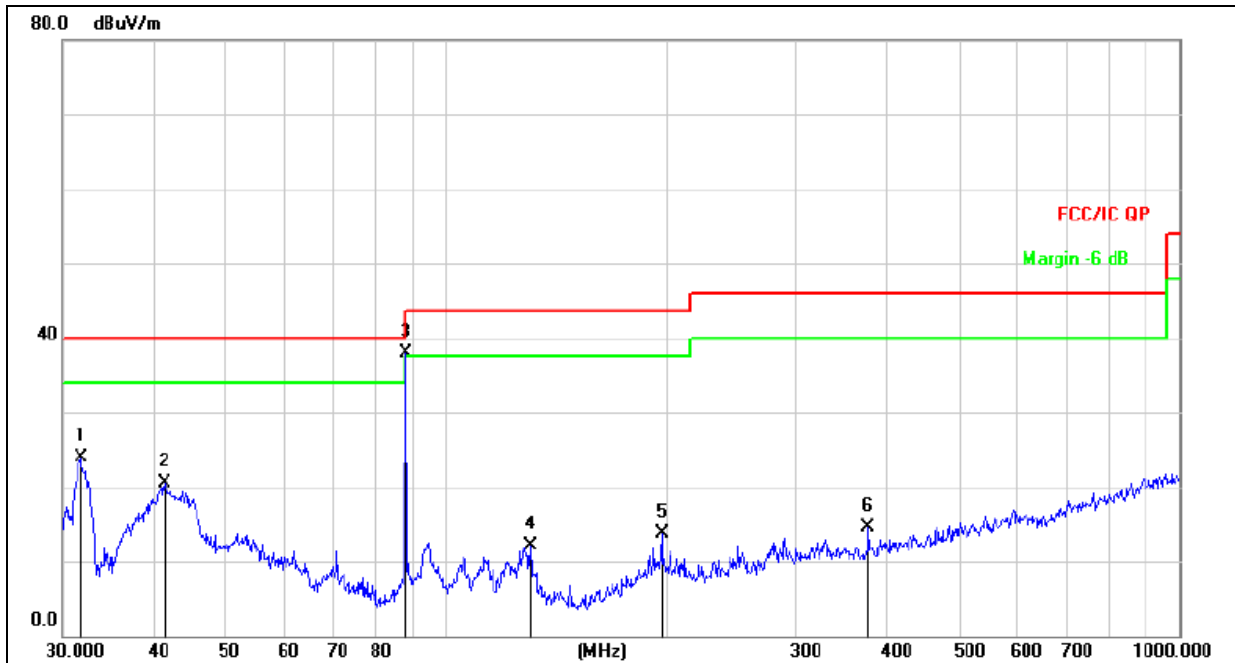

Remark:

- All readings are Quasi-Peak and Average values.
- Factor = Insertion Loss + Cable Loss.

No.	Mk.	Freq. MHz	Reading Level dBuV	Correct Factor dB	Measure- ment dBuV/m	Limit dB/m	Over dB	Detector
1		31.7313	40.96	-16.96	24.00	40.00	-16.00	QP
2		41.2765	35.82	-15.34	20.48	40.00	-19.52	QP
3	*	88.0329	56.42	-18.55	37.87	48.00	-10.13	peak
4		130.3789	30.30	-18.24	12.06	43.50	-31.44	QP
5		196.5098	30.30	-16.52	13.78	43.50	-29.72	QP
6		375.9385	26.14	-11.64	14.50	46.00	-31.50	QP



Temperature :	26 °C	Relative Humidity :	54%
Pressure :	101kPa	Phase :	H
Test Voltage :	AC 120V/60Hz	Test Mode :	Mode 1(98MHz)

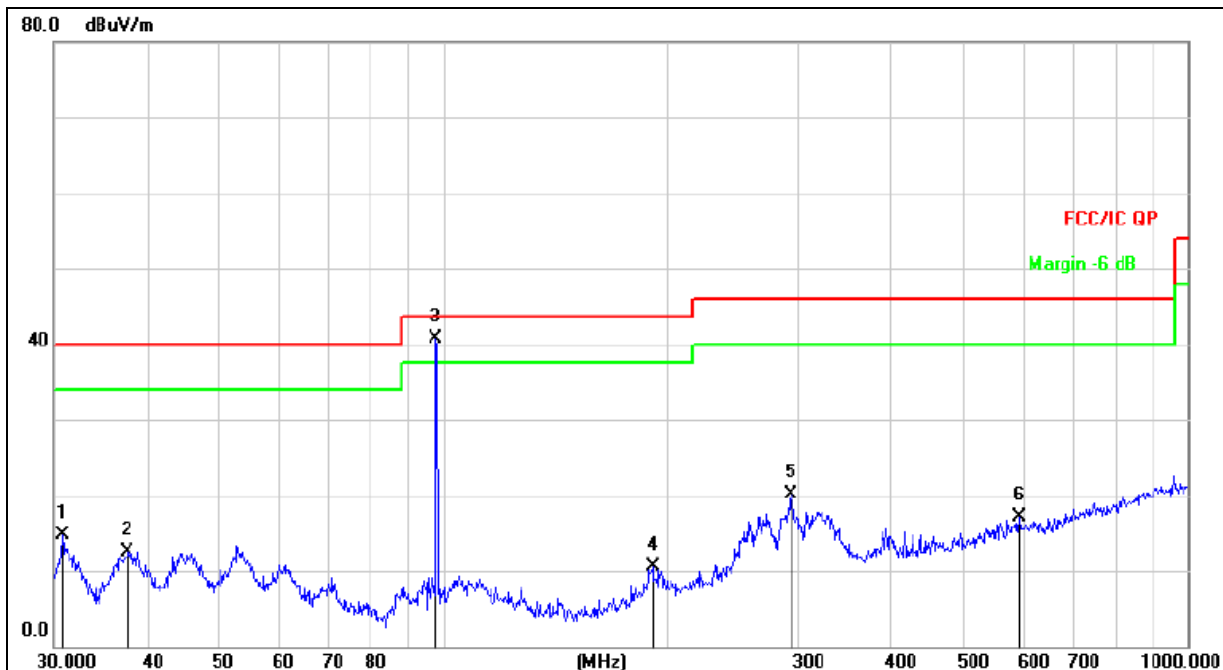

Remark:

1. All readings are Quasi-Peak and Average values.
2. Factor = Insertion Loss + Cable Loss.

No.	Mk.	Freq. MHz	Reading Level dBuV	Correct Factor dB	Measure- ment dBuV/m	Limit dB/m	Over dB	Detector
1		30.7455	31.81	-17.14	14.67	40.00	-25.33	QP
2		37.6798	28.32	-15.84	12.48	40.00	-27.52	QP
3	*	97.7983	57.40	-16.68	40.72	48.00	-7.28	peak
4		191.0738	27.45	-16.87	10.58	43.50	-32.92	QP
5		293.0842	33.88	-13.81	20.07	46.00	-25.93	QP
6		593.0497	23.70	-6.68	17.02	46.00	-28.98	QP



Temperature :	26 °C	Relative Humidity :	54%
Pressure :	101kPa	Phase :	V
Test Voltage :	AC 120V/60Hz	Test Mode :	Mode 1(98MHz)

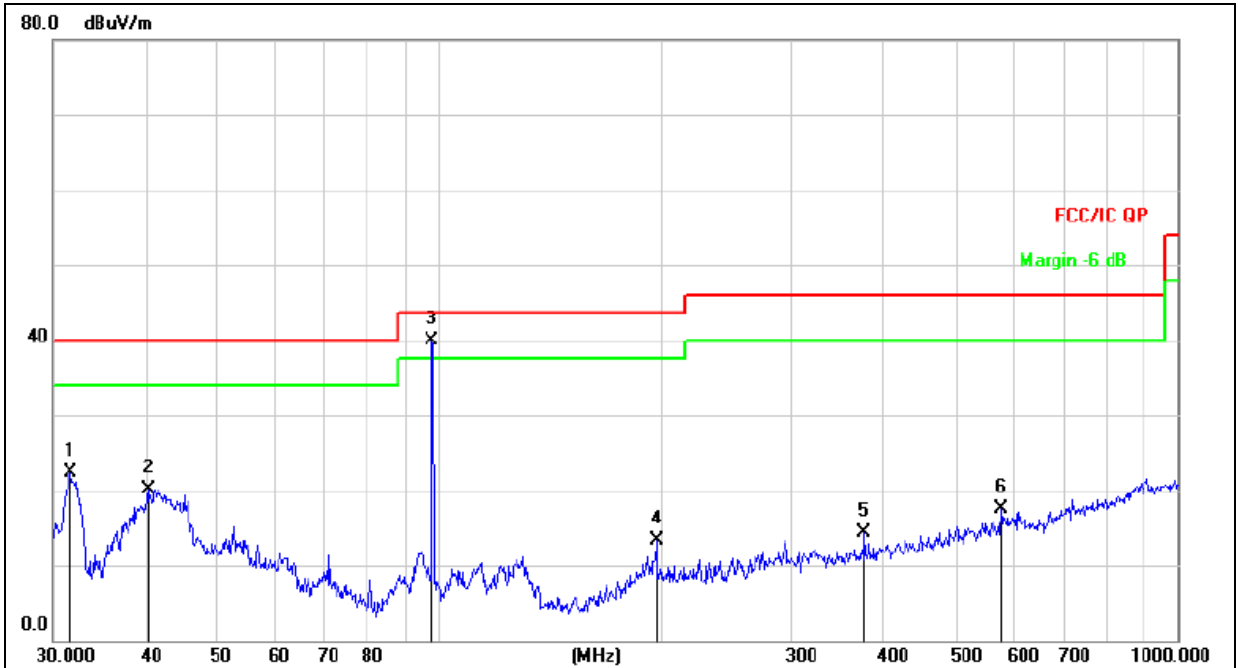

Remark:

1. All readings are Quasi-Peak and Average values.
2. Factor = Insertion Loss + Cable Loss.

No.	Mk.	Freq. MHz	Reading Level dBuV	Correct Factor dB	Measure- ment dBuV/m	Limit dB/m	Over dB	Detector
1		31.6202	39.35	-16.98	22.37	40.00	-17.63	QP
2		40.2757	35.47	-15.39	20.08	40.00	-19.92	QP
3	*	97.7983	56.50	-16.68	39.82	48.00	-8.18	peak
4		196.5098	29.79	-16.52	13.27	43.50	-30.23	QP
5		375.9385	26.03	-11.64	14.39	46.00	-31.61	QP
6		576.6443	24.63	-7.06	17.57	46.00	-28.43	QP





Temperature :	26 °C	Relative Humidity :	54%
Pressure :	101kPa	Phase :	H
Test Voltage :	AC 120V/60Hz	Test Mode :	Mode 1(107.9MHz)

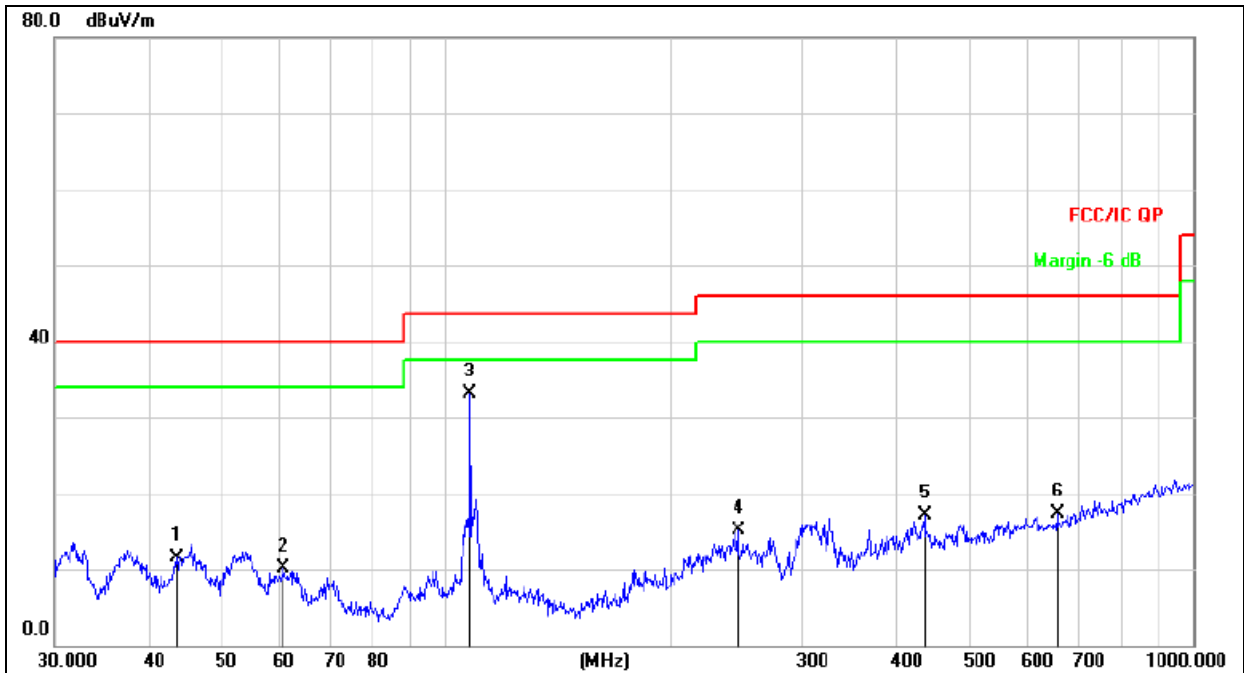

Remark:

1. All readings are Quasi-Peak and Average values.
2. Factor = Insertion Loss + Cable Loss.

No.	Mk.	Freq. MHz	Reading Level dBuV	Correct Factor dB	Measure- ment dBuV/m	Limit dB/m	Over dB	Detector
1		43.6584	26.80	-15.21	11.59	40.00	-28.41	QP
2		60.7043	26.22	-16.07	10.15	40.00	-29.85	QP
3	*	107.8876	49.95	-16.79	33.16	48.00	-14.84	peak
4		245.9508	30.26	-15.24	15.02	46.00	-30.98	QP
5		437.1198	27.30	-10.26	17.04	46.00	-28.96	QP
6		656.5299	23.99	-6.59	17.40	46.00	-28.60	QP



Temperature :	26 °C	Relative Humidity :	54%
Pressure :	101kPa	Phase :	V
Test Voltage :	AC 120V/60Hz	Test Mode :	Mode 1(107.9MHz)

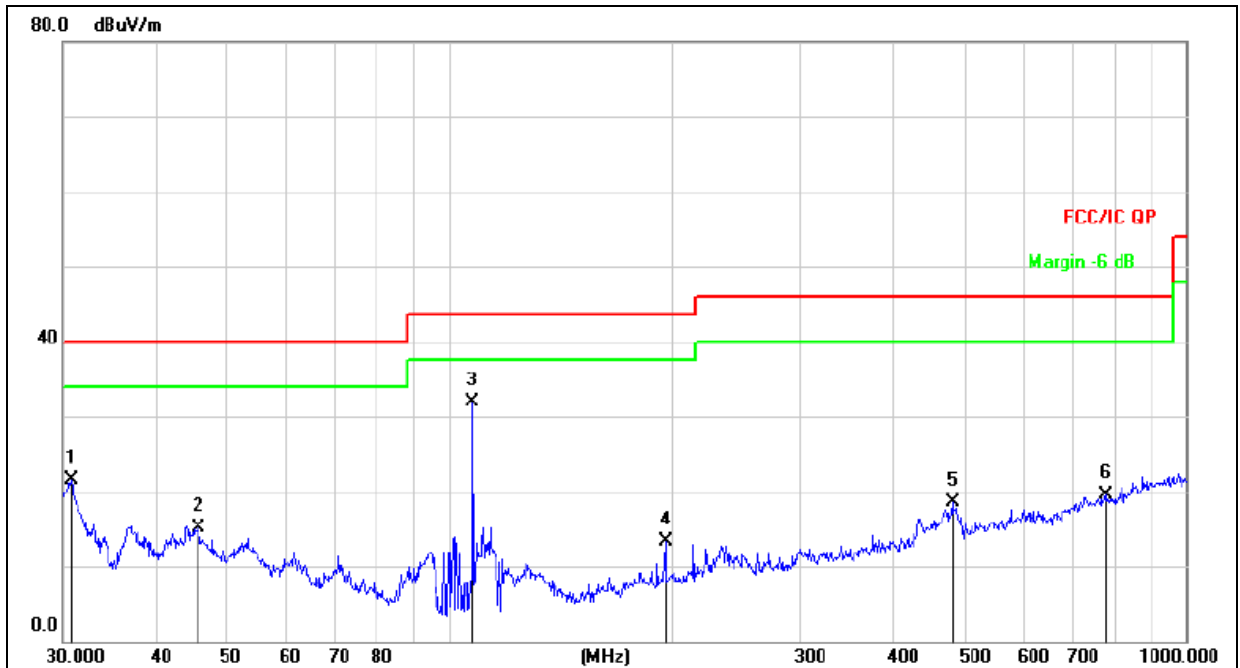

Remark:

1. All readings are Quasi-Peak and Average values.
2. Factor = Insertion Loss + Cable Loss.

No.	Mk.	Freq. MHz	Reading Level dBuV	Correct Factor dB	Measure- ment dBuV/m	Limit dB/m	Over dB	Detector
1		30.7454	38.64	-17.14	21.50	40.00	-18.50	QP
2		45.8551	30.16	-15.08	15.08	40.00	-24.92	QP
3	*	107.8876	48.61	-16.79	31.82	48.00	-16.18	peak
4		196.5098	29.88	-16.52	13.36	43.50	-30.14	QP
5		482.2155	27.86	-9.31	18.55	46.00	-27.45	QP
6		776.8777	23.53	-3.96	19.57	46.00	-26.43	QP



### 3.2.6 TEST RESULTS (1GHZ~6GHZ)

Polar (H/V)	Frequency	Meter Reading	Pre-amplifier	Cable Loss	Antenna Factor	Emission Level	Limits	Margin	Detector Type
	(MHz)	(dBuV)	(dB)	(dB)	(dB)	(dBuV/m)	(dBuV/m)	(dB)	
V	1057.20	50.10	39.55	7.77	25.66	43.98	74	-30.02	PK
V	1057.20	43.45	39.55	7.77	25.66	37.33	54	-16.67	AV
V	1176.00	53.97	38.33	7.3	24.55	47.49	74	-26.51	PK
V	1176.00	43.53	38.33	7.3	24.55	37.05	54	-16.95	AV
V	1294.80	43.95	38.33	7.6	24.55	37.77	74	-36.23	PK
V	1294.80	42.15	35.23	7.6	26.59	52.11	54	-10.89	AV
H	1145.30	54.29	39.55	7.77	25.66	48.17	74	-25.83	PK
H	1145.30	43.47	39.55	7.77	25.66	37.35	54	-16.65	AV
H	1274.00	53.80	38.33	7.3	23.55	46.32	74	-27.68	PK
H	1274.00	43.55	38.33	7.3	23.22	35.74	54	-18.26	AV
H	1402.70	43.57	38.33	7.6	24.55	37.39	74	-36.61	PK
H	1402.70	42.74	35.45	7.6	27.88	52.77	54	-11.23	AV

Remark:

1. Emission Level = Meter Reading + Antenna Factor + Cable Loss – Pre-amplifier,

Margin= Emission Level - Limit

2. If peak below the average limit, the average emission was no test.

3. The amplitude of spurious emissions which are attenuated by more than 20dB below the permissible value has no need to be reported.



CONDUCTED EMISSION MEASUREMENT

88.1MHz

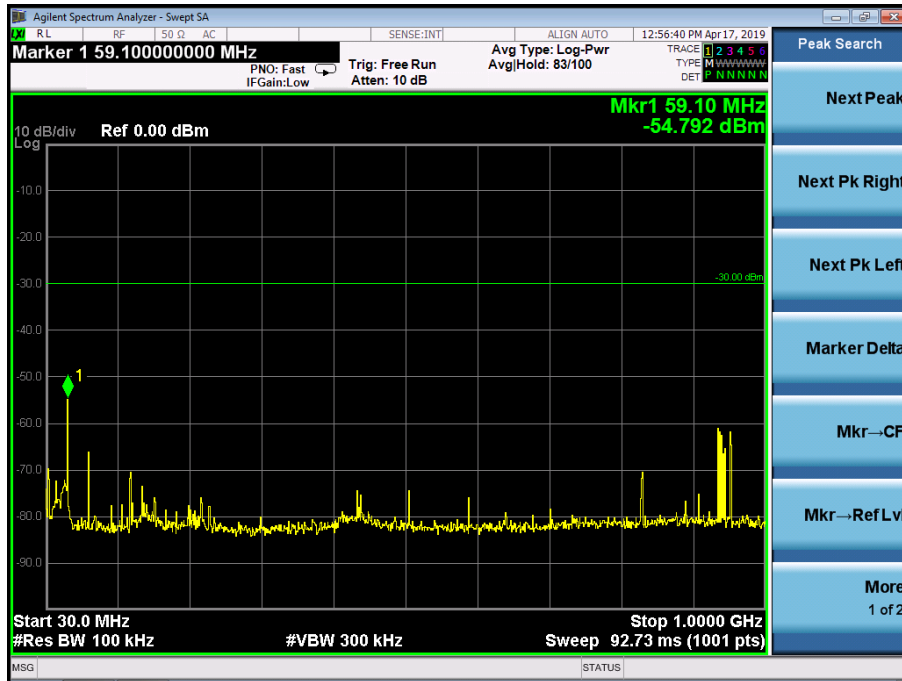

88.1MHz

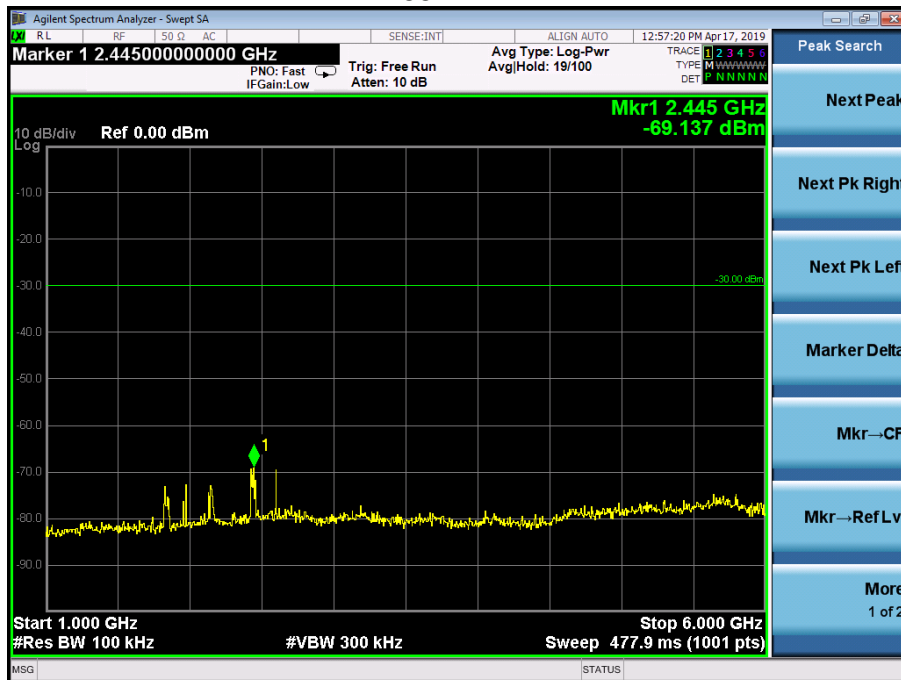



98MHz

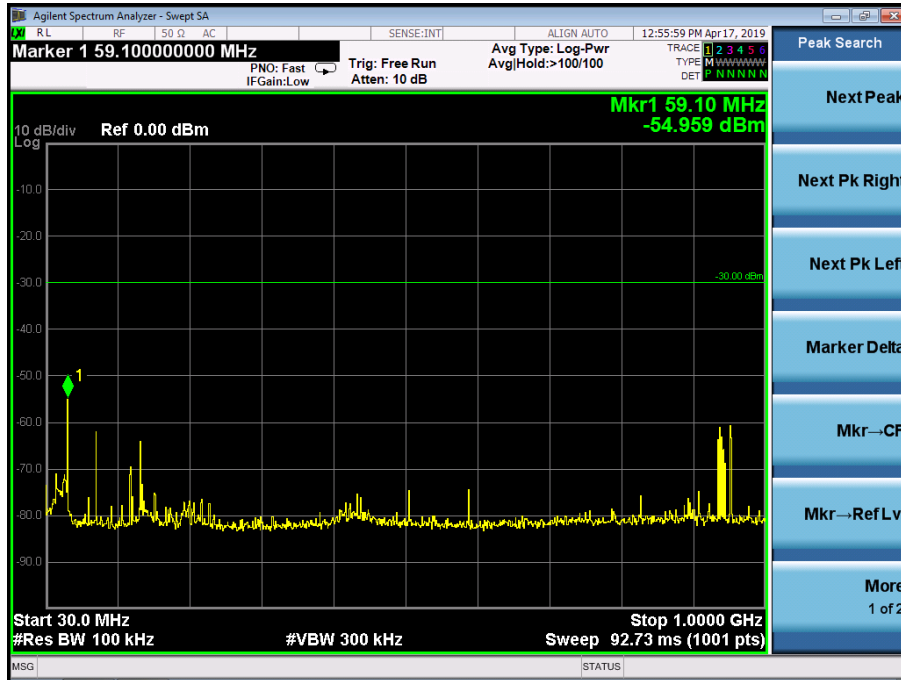

98MHz

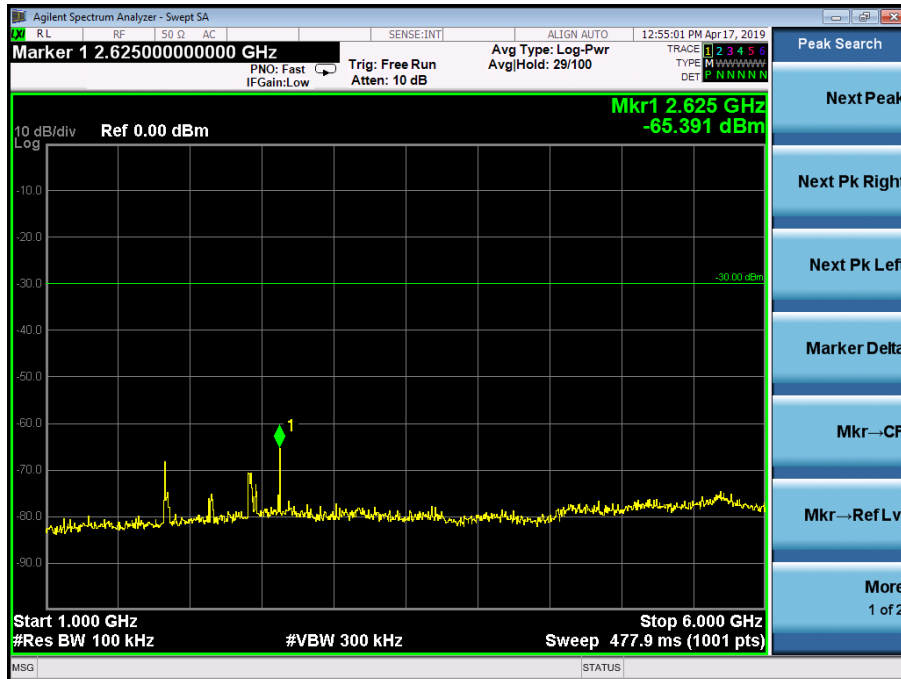



107.9MHz

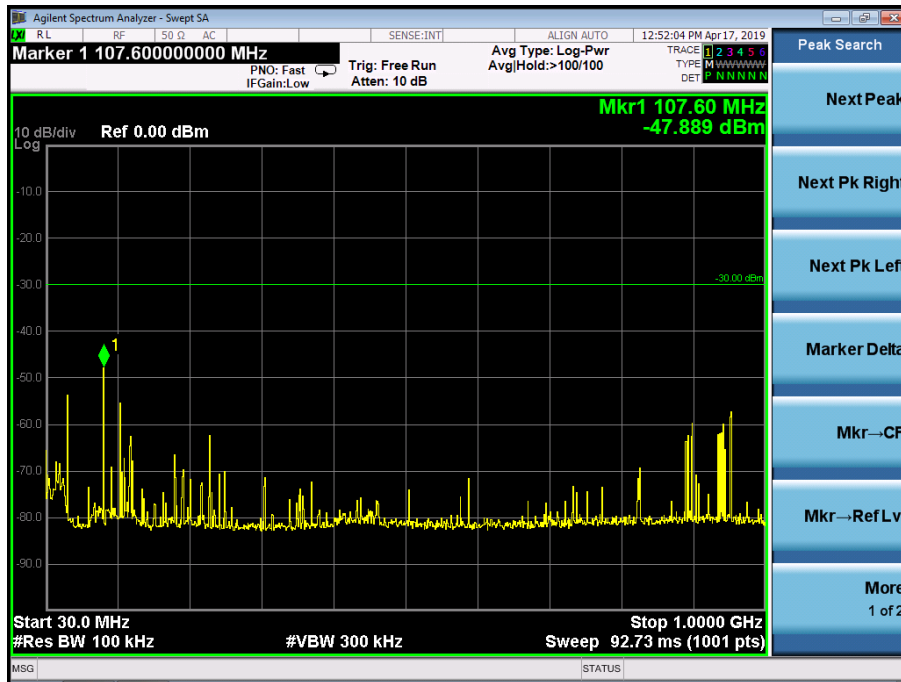

107.9MHz

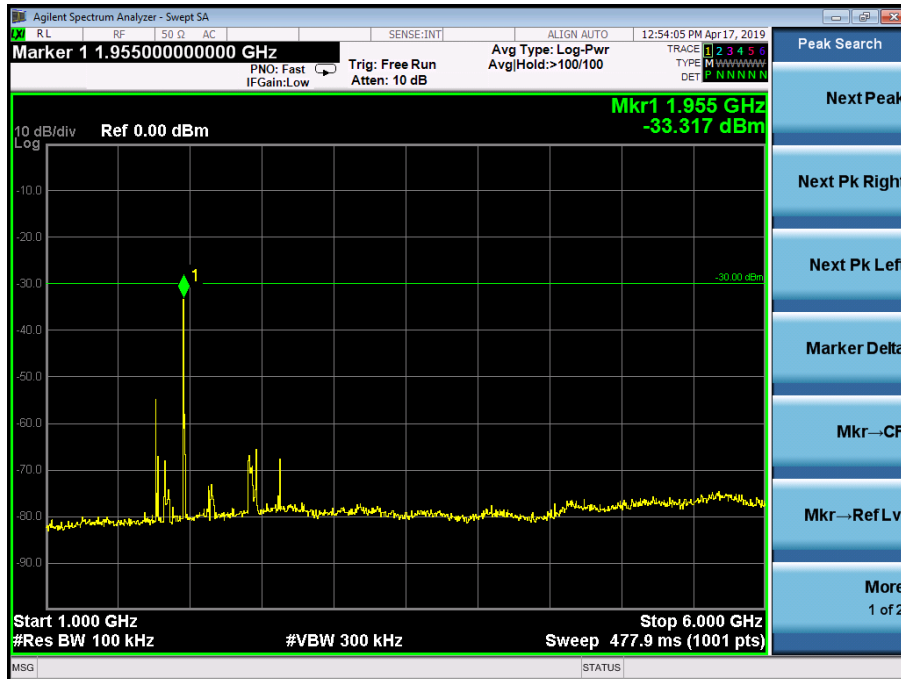

## 4. BANDWIDTH TEST

### 4.1 APPLIED PROCEDURES / LIMIT

According to 15.209&15.239 requirement:  
 The bandwidth of the emission shall not exceed 200 kHz.

Spectrum Parameter	Setting
Attenuation	Auto
Span Frequency	> Measurement Bandwidth or Channel Separation
RB	30kHz
VB	$\geq$ RBW
Detector	Peak
Trace	Max Hold
Sweep Time	Auto

#### 4.1.1 TEST PROCEDURE

- a. The EUT was directly connected to the spectrum analyzer and antenna output port as show in the block diagram below,
- b. Spectrum Setting : RBW= 30kHz, VBW $\geq$  RBW, Sweep time = Auto.

#### 4.1.2 DEVIATION FROM STANDARD

No deviation.

#### 4.1.3 TEST SETUP



#### 4.1.4 EUT OPERATION CONDITIONS

The EUT tested system was configured as the statements of 2.4 Unless otherwise a special operating condition is specified in the follows during the testing.

#### 4.1.5 TEST RESULTS

Temperature :	26 °C	Relative Humidity :	54%
Pressure :	101kPa	Test Voltage :	AC 120V/60Hz
Test Mode :	TX Mode		

Frequency	Occupied Bandwidth (kHz)	Limit (MHz)	Result
88.1MHz	89.415	200	PASS
98 MHz	95.008	200	PASS
107.9 MHz	88.819	200	PASS

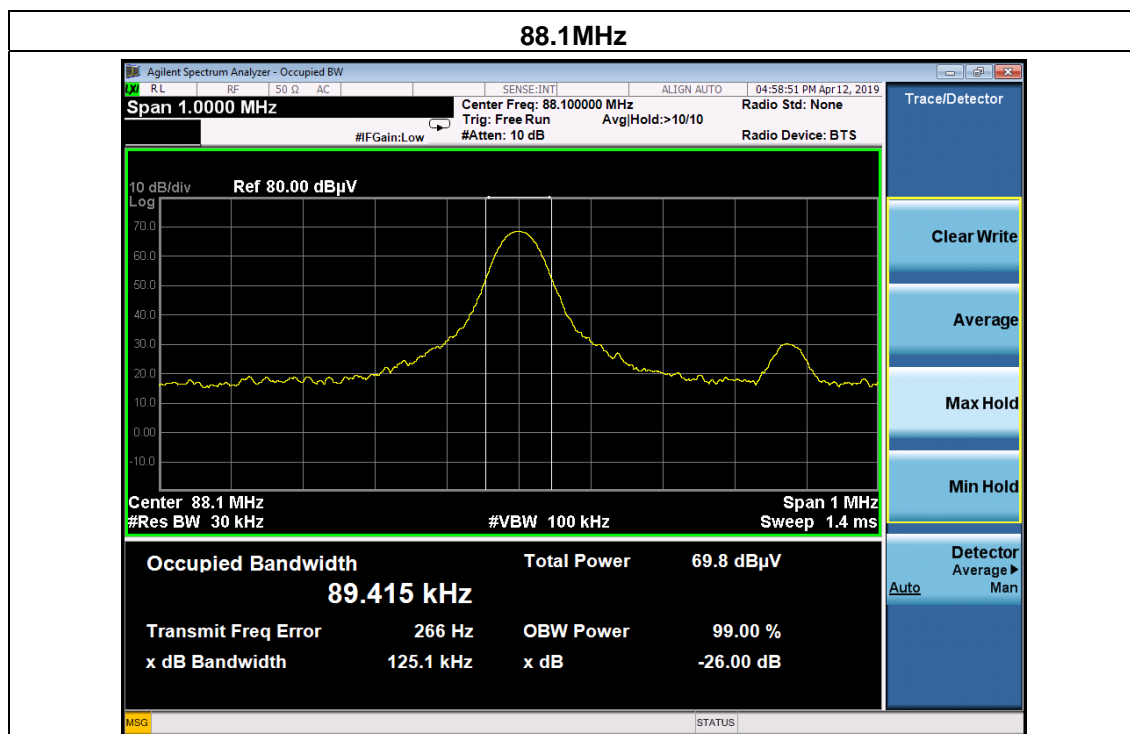



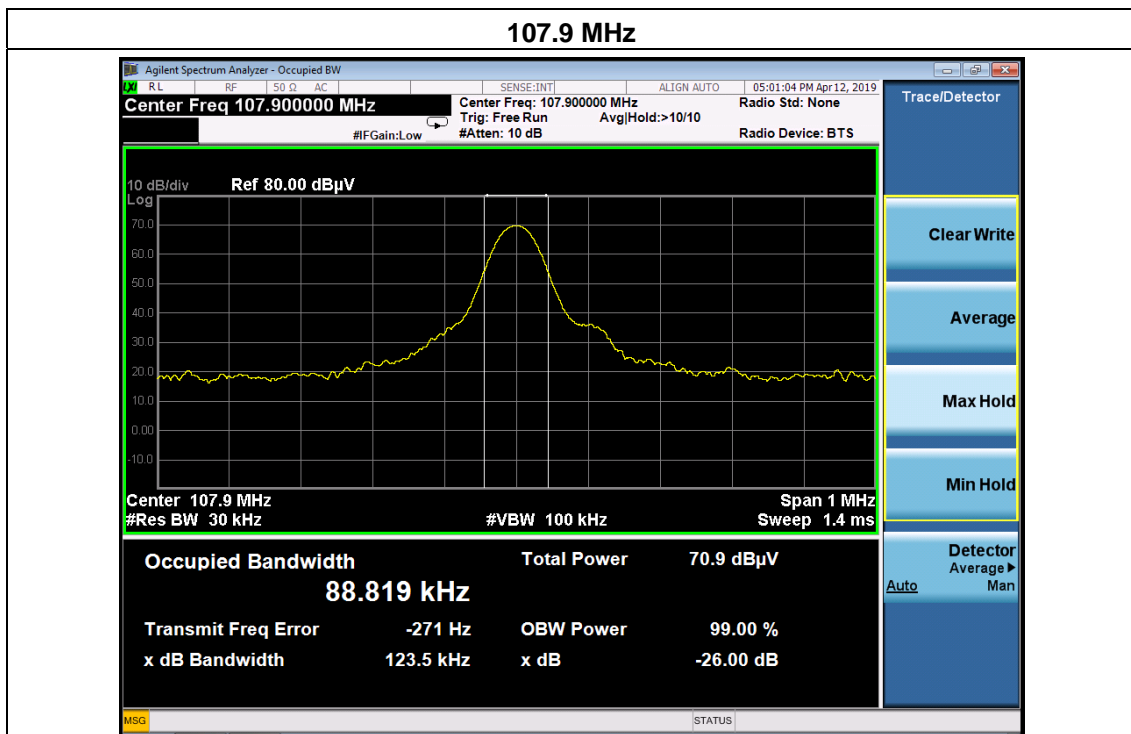
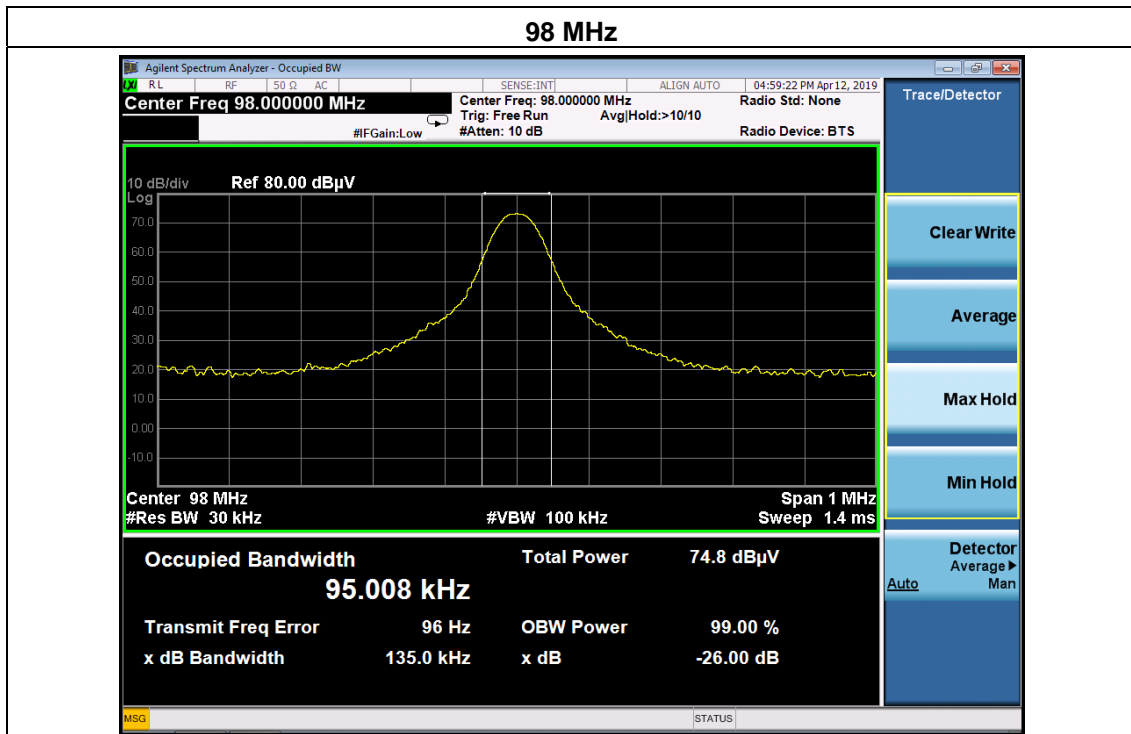

## 5. BAND EDGE MEASUREMENT

### 6.1 APPLICABLE STANDARD

FCC Part15 Paragraph 15.209&15.239

Outside the 200kHz band(as well as outside the 88-108MHz band), the general field strength limits listed in RSS-Gen apply.

### 6.2 TEST PROCEDURE

Using the following spectrum analyzer setting:

- a) Set the RBW = 3KHz.
- b) Set the VBW = 10KHz.
- c) Sweep time = auto couple.
- d) Detector function = peak.
- e) Trace mode = max hold.
- f) Allow trace to fully stabilize.

### 6.3 DEVIATION FROM STANDARD

No deviation.

### 6.4 TEST SETUP



### 6.5 EUT OPERATION CONDITIONS

The EUT tested system was configured as the statements of 2.4 Unless otherwise a special operating condition is specified in the follows during the testing.

### 6.6 TEST RESULTS



88.1MHz

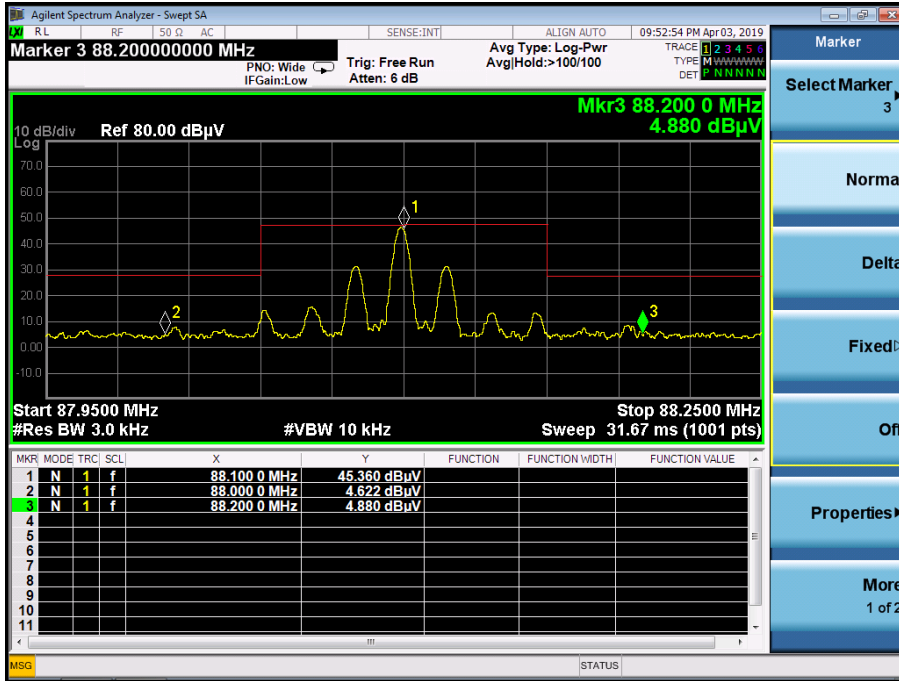

98MHz

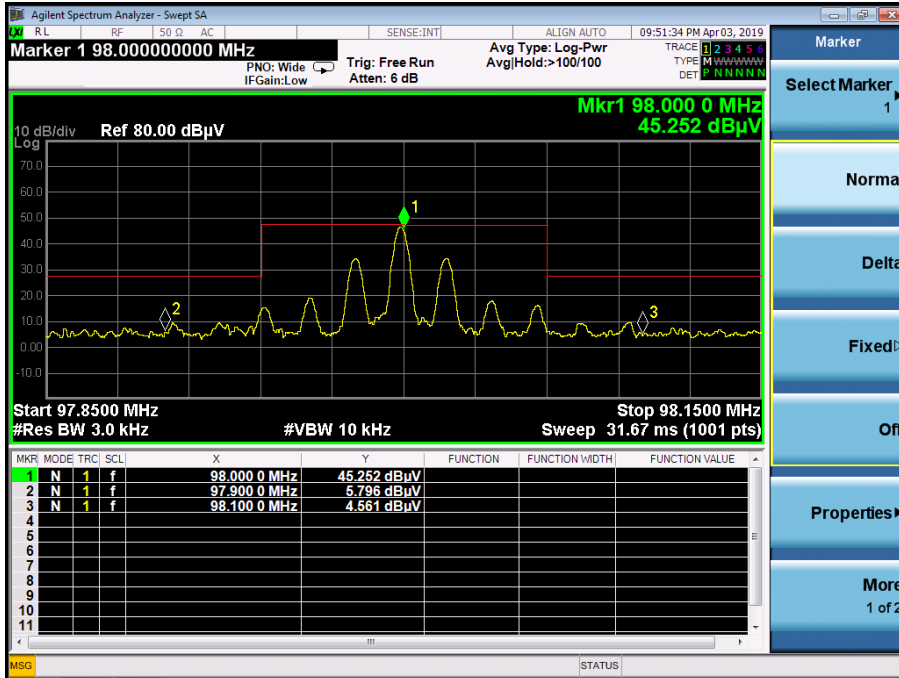



107.9MHz

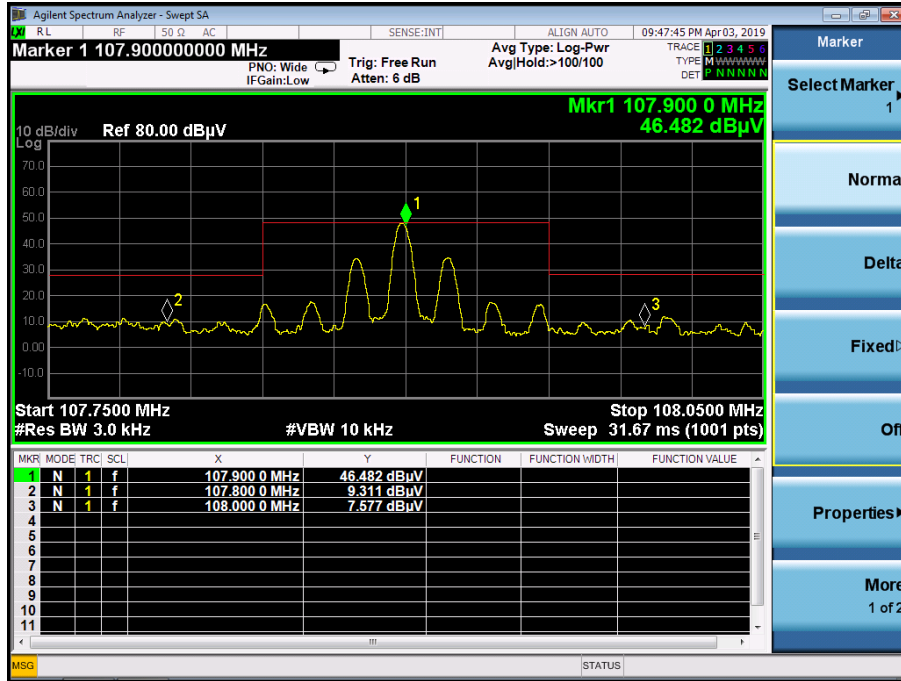



## 6. ANTENNA REQUIREMENT

### 6.1 STANDARD REQUIREMENT

15.203 requirement: For intentional device, according to 15.203: an intentional radiator shall be designed to ensure that no antenna other than that furnished by the responsible party shall be used with the device.

### 6.2 EUT ANTENNA

The EUT antenna is the External antenna with RP-SMA connector. It comply with the standard requirement.

## 7. EUT TEST PHOTO

### Radiated Measurement Photos

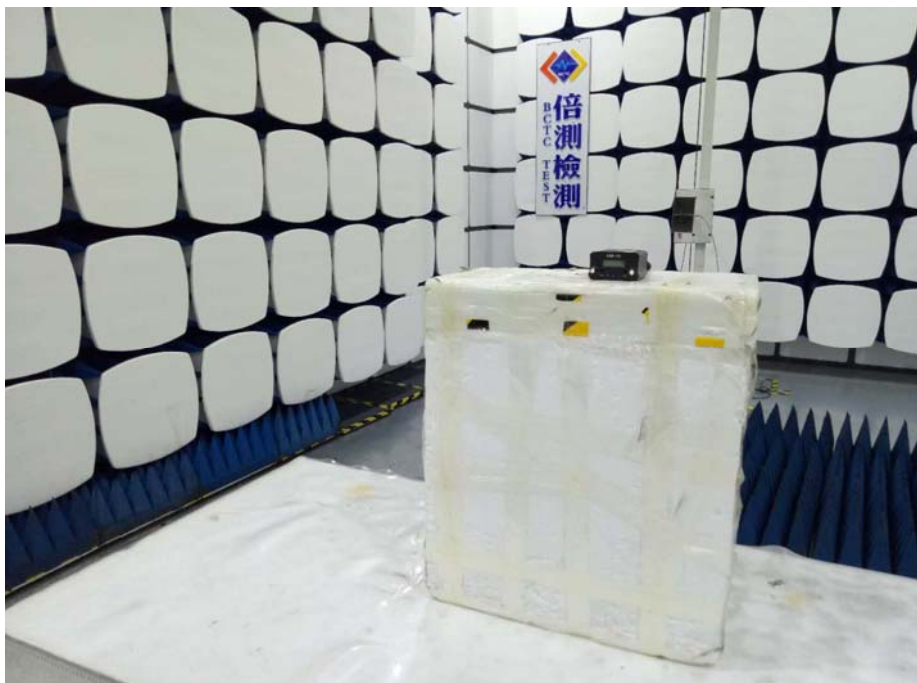
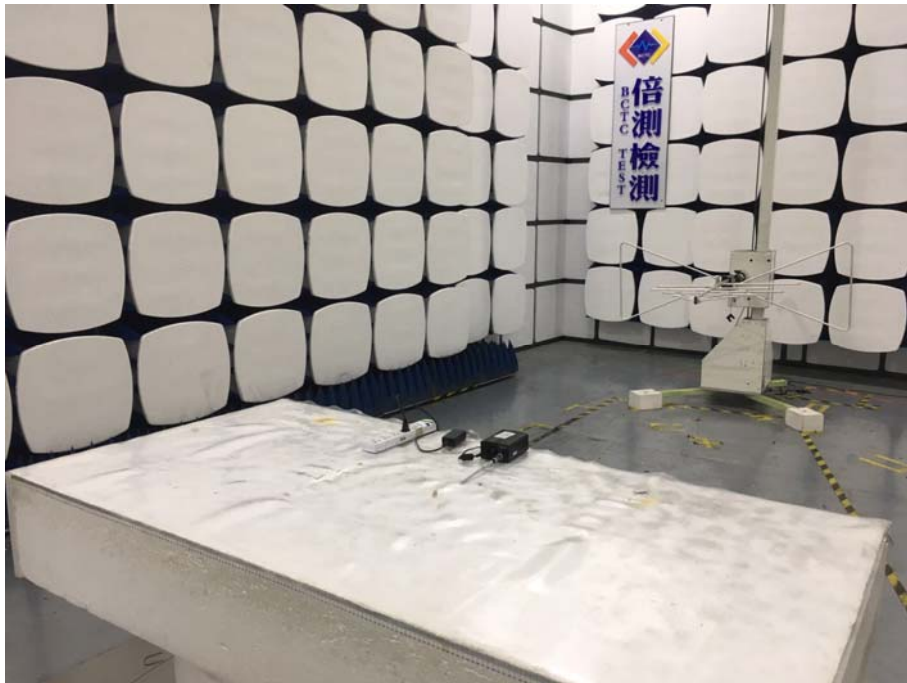



### Conducted Measurement Photos





## 8. EUT PHOTO







\*\*\*\*\* END OF REPORT \*\*\*\*\*