



Shenzhen CTL Testing Technology Co., Ltd.
Tel: +86-755-89486194 E-mail: ctl@ctl-lab.com

TEST REPORT

FCC Part 95

Report Reference No.: CTL1901161021-WF

Compiled by:
(position+printed name+signature)

Happy Guo
(File administrators)

Tested by:
(position+printed name+signature)

Nice Nong
(Test Engineer)

Approved by:
(position+printed name+signature)

Ivan Xie
(Manager)



Product Name: Walkie talkie

Model/Type reference: T5

List Model(s): N/A

FCC ID: 2ASV6-T5

Trade Mark: N/A

Applicant's name: **Shenzhen Beijia Electronic Technology Co., Ltd.**

Address of applicant: 2/F, No. 20 Xinkang 2nd Road, Shatian Community, Kengzi Street, Pingshan District, Shenzhen, China

Test Firm: **Shenzhen CTL Testing Technology Co., Ltd.**

Address of Test Firm: Floor 1-A, Baisha Technology Park, No.3011, Shahexi Road, Nanshan District, Shenzhen, China 518055

Test specification

Standard.....: **FCC Part 95**

TRF Originator: Shenzhen CTL Testing Technology Co., Ltd.

Master TRF: Dated 2011-01

Date of receipt of test item: Jan. 20, 2019

Date of sampling: Jan. 20, 2019

Date of Test Date: Jan. 20, 2019–Mar. 19, 2019

Data of Issue.....: Mar. 20, 2019

Result.....: **Pass**

Shenzhen CTL Testing Technology Co., Ltd. All rights reserved.

This publication may be reproduced in whole or in part for non-commercial purposes as long as the Shenzhen CTL Testing Technology Co., Ltd. is acknowledged as copyright owner and source of the material. Shenzhen CTL Testing Technology Co., Ltd. takes no responsibility for and will not assume liability for damages resulting from the reader's interpretation of the reproduced material due to its placement and context.

TEST REPORT

Test Report No. :	CTL1901161021-WF	Mar. 20, 2019 Date of issue
--------------------------	-------------------------	--------------------------------

Equipment under Test : Walkie talkie

Model /Type : T5

Listed Models : N/A

Applicant : **Shenzhen Beijia Electronic Technology Co., Ltd.**

Address : 2/F, No. 20 Xinkang 2nd Road, Shatian Community, Kengzi Street, Pingshan District, Shenzhen, China

Manufacturer : **Shenzhen Beijia Electronic Technology Co., Ltd.**

Address : 2/F, No. 20 Xinkang 2nd Road, Shatian Community, Kengzi Street, Pingshan District, Shenzhen, China

Test result	Pass *
--------------------	---------------

* In the configuration tested, the EUT complied with the standards specified page 5.

The test results presented in this report relate only to the object tested.

This report shall not be reproduced, except in full, without the written approval of the issuing testing laboratory.

Table of Contents

Page

- 1. SUMMARY5**
 - 1.1. TEST STANDARDS 5
 - 1.2. TEST DESCRIPTION 5
 - 1.3. TEST FACILITY 6
 - 1.4. STATEMENT OF THE MEASUREMENT UNCERTAINTY 6
- 2. GENERAL INFORMATION8**
 - 2.1. ENVIRONMENTAL CONDITIONS 8
 - 2.2. GENERAL DESCRIPTION OF EUT 8
 - 2.3. DESCRIPTION OF TEST MODES AND TEST FREQUENCY 8
 - 2.4. MEASUREMENT INSTRUMENTS LIST 9
 - 2.5. RELATED SUBMITTAL(S) / GRANT(S) 9
 - 2.6. MODIFICATIONS 9
- 3. TEST CONDITIONS AND RESULTS10**
 - 3.1. MAXIMUM TRANSMITTER POWER 10
 - 3.2. OCCUPIED BANDWIDTH AND EMISSION MASK 13
 - 3.3. MODULATION LIMIT 17
 - 3.4. AUDIO FREQUENCY RESPONSE 19
 - 3.5. FREQUENCY STABILITY 21
 - 3.6. TRANSMITTER RADIATED SPURIOUS EMISSION 23
- 4. TEST SETUP PHOTOS OF THE EUT26**
- 5. EXTERNAL AND INTERNAL PHOTOS OF THE EUT27**

1. SUMMARY

1.1. TEST STANDARDS

The tests were performed according to following standards:

[FCC Rules Part 95](#) : PERSONAL RADIO SERVICES

[ANSI/TIA-603-E-2016](#): Land Mobile FM or PM Communications Equipment Measurement and Performance Standards.

[FCC Part 2](#): FREQUENCY ALLOCATIONS AND RADIO TREATY MATTERS; GENERAL RULES AND REGULATIONS

[ANSI C63.26-2015](#): IEEE/ANSI Standard for Compliance Testing of Transmitters Used in Licensed Radio Services

1.2. Test Description

Description of Test Item	Standard clause	Verdict
Maximum Transmitter Power	FCC Part 95.567	PASS
Modulation Characteristic	FCC Part 2.1047 FCC Part 95.575	PASS
Occupied Bandwidth and Emission Mask	FCC Part 2.1049 FCC Part 95.573 FCC Part 95.579	PASS
Radiated Spurious Emission	FCC Part 95.579	PASS
Frequency Stability	FCC Part 2.1055 FCC Part 95.565	PASS

1.3. Test Facility

1.3.1 Address of the test laboratory

Shenzhen CTL Testing Technology Co., Ltd.
Floor 1-A, Baisha Technology Park, No. 3011, Shahexi Road, Nanshan, Shenzhen 518055 China

The 3m-Semi anechoic test site fulfils CISPR 16-1-4 according to ANSI C63.4:2014 and CISPR 16-1-4:2010 SVSWR requirement for radiated emission above 1GHz.

1.3.2 Laboratory accreditation

The test facility is recognized, certified, or accredited by the following organizations:

CNAS-Lab Code: L7497

Shenzhen CTL Testing Technology Co., Ltd. has been assessed and proved to be in compliance with CNAS-CL01 Accreditation Criteria for Testing and Calibration Laboratories (identical to ISO/IEC 17025: 2005 General Requirements) for the Competence of Testing and Calibration Laboratories.

A2LA-Lab Cert. No. 4343.01

Shenzhen CTL Testing Technology Co., Ltd. EMC Laboratory has been accredited by A2LA for technical competence in the field of electrical testing, and proved to be in compliance with ISO/IEC 17025: 2005 General Requirements for the Competence of Testing and Calibration Laboratories and any additional program requirements in the identified field of testing.

IC Registration No.: 9518B(CAB identifier: CN0041)

The 3m test site of Shenzhen CTL Testing Technology Co., Ltd. EMC Laboratory has been registered by Innovation, Science and Economic Development Canada to test to Canadian radio equipment requirements with Registration No.: 9518B on Jan. 22, 2019.

FCC-Registration No.: 399832(Designation No.: CN1216)

Shenzhen CTL Testing Technology Co., Ltd. EMC Laboratory has been registered and fully described in a report filed with the (FCC) Federal Communications Commission. The acceptance letter from the FCC is maintained in our files. Registration 399832, December 08, 2017.

1.4. Statement of the measurement uncertainty

The data and results referenced in this document are true and accurate. The reader is cautioned that there may be errors within the calibration limits of the equipment and facilities. The measurement uncertainty was calculated for all measurements listed in this test report acc. to CISPR 16 - 4 „Specification for radio disturbance and immunity measuring apparatus and methods – Part 4: Uncertainty in EMC Measurements“ and is documented in the Shenzhen CTL Testing Technology Co., Ltd. quality system acc. to DIN EN ISO/IEC 17025. Furthermore, component and process variability of devices similar to that tested may result in additional deviation. The manufacturer has the sole responsibility of continued compliance of the device.

Hereafter the best measurement capability for Shenzhen CTL Testing Technology Co., Ltd. is reported

Test Items	Measurement Uncertainty	Notes
Frequency error	25 Hz	(1)
Transmitter power conducted	0.57 dB	(1)
Transmitter power Radiated	2.20 dB	(1)
Adjacent and alternate channel power Conducted	1.20 dB	(1)
Conducted spurious emission 9KHz-12.75 GHz	1.60 dB	(1)
Radiated spurious emission 9KHz-12.75 GHz	2.20 dB	(1)
Intermodulation attenuation	1.00 dB	(1)
Maximum useable receiver sensitivity	2.80 dB	(1)
Co-channel rejection	2.80 dB	(1)
Adjacent channel selectivity	2.80 dB	(1)

Spurious response rejection	2.80 dB	(1)
Intermodulation response rejection	2.80 dB	(1)
Blocking or desensitization	2.80 dB	(1)

- (1) This uncertainty represents an expanded uncertainty expressed at approximately the 95% confidence level using a coverage factor of $k=2$.

2. GENERAL INFORMATION

2.1. Environmental conditions

During the measurement the environmental conditions were within the listed ranges:

Normal Temperature:	25°C
Relative Humidity:	55 %
Air Pressure:	101 kPa

2.2. General Description of EUT

Name of EUT	Walkie talkie
Model Number	T5
Power Supply	DC 6V from battery
Frequency Range	FRS: 462.5500MHz~462.7250MHz FRS: 462.5625MHz~462.7125MHz FRS: 467.5625MHz~467.7125MHz
Rate Power	0.5W
Modulation Type	FM
Channel Separation	12.5KHz
Antenna Type	Integral antenna
Antennal Gain	-9.7dBi

Note 1: For more details, please refer to the user's manual of the EUT.

2.3. Description of Test Modes and Test Frequency

The EUT has been tested under typical operating condition. As, test modes selected as below by the technical parameters of the EUT:

Operation Mode No.	Modulation	Channel Separation	Condition	
	FM	12.5KHz	TX	RX
1	<input checked="" type="checkbox"/>	<input checked="" type="checkbox"/>	<input checked="" type="checkbox"/>	
2	<input checked="" type="checkbox"/>	<input checked="" type="checkbox"/>		<input checked="" type="checkbox"/>

Frequency list

Channel	Frequency(MHz)	Type	Channel	Frequency(MHz)	Type
1	462.5625	FRS	12	467.6625	FRS
2	462.5875	FRS	13	467.6875	FRS
3	462.6125	FRS	14	467.7125	FRS
4	462.6375	FRS	15	462.5500	FRS
5	462.6625	FRS	16	462.5750	FRS
6	462.6875	FRS	17	462.6000	FRS
7	462.7125	FRS	18	462.6250	FRS
8	467.5625	FRS	19	462.6500	FRS
9	467.5875	FRS	20	462.6750	FRS
10	467.6125	FRS	21	462.7000	FRS
11	467.6375	FRS	22	462.7250	FRS

Note1: In section 15.31(m), regards to the operating frequency range less than 1MHz, only one point centered in the frequency range of operation selected to measure.

Note2: The line display in grey was the channel selected for test.

2.4. Measurement Instruments List

Test Equipment	Manufacturer	Model No.	Serial No.	Calibration Date	Calibration Due Date
LISN	R&S	ENV216	3560.6550.12	2018/05/25	2019/05/24
LISN	R&S	ESH2-Z5	860014/010	2018/05/25	2019/05/24
Power Meter	Agilent	U2531A	TW53323507	2018/06/01	2019/05/31
Power Sensor	Agilent	U2021XA	MY5365004	2018/05/20	2019/05/19
EMI Test Receiver	R&S	ESCI	1166.5950.03	2018/05/25	2019/05/24
Spectrum Analyzer	Agilent	E4407B	MY41440676	2019/01/19	2020/01/18
Spectrum Analyzer	Agilent	N9020	US46220290	2019/01/14	2020/01/13
Controller	EM Electronics	EM 1000	060859	2018/05/21	2019/05/20
Bilog Antenna	Schwarzbeck	VULB 9168	00824	2018/10/25	2019/10/24
Horn Antenna	Sunol Sciences Corp.	DRH-118	A062013	2018/05/25	2019/05/24
Horn Antenna	SCHWARZBACK	BBHA 9170	BBHA9170184	2018/05/18	2019/05/17
Active Loop Antenna	Da Ze	ZN30900A	/	2018/05/25	2019/05/24
Amplifier	Agilent	8449B	3008A02306	2018/05/25	2019/05/24
Amplifier	Agilent	8447D	2944A10176	2018/05/25	2019/05/24
Temperature/Humidity Meter	Gangxing	CTH-608	02	2018/05/17	2019/05/16
High-Pass Filter	micro-tranics	HPM50108	G174	2018/05/17	2019/05/16
High-Pass Filter	micro-tranics	HPM50111	G142	2018/05/17	2019/05/16
Radio Communication Tester	HP	8920A	116250	2019/01/19	2020/01/18
Storage Oscilloscope	Tektronix	TDS3054B	B033027	2018/10/11	2019/10/10
Coaxial Cables	HUBER+SUHNER	SUCOFLEX 104PEA-10M	10m	2018/05/17	2019/05/16
Coaxial Cables	HUBER+SUHNER	SUCOFLEX 104PEA-3M	3m	2018/05/17	2019/05/16
Coaxial Cables	HUBER+SUHNER	SUCOFLEX 104PEA-3M	3m	2018/05/17	2019/05/16
RF Cable	Megalon	RF-A303	N/A	2018/05/17	2019/05/16
EMI Test Software	R&S	ES-K1	V1.7.1	2018/06/01	2019/05/31
EMI Test Software	AUDIX	E3	V6.0	2018/06/01	2019/05/31

The calibration interval was one year

2.5. Related Submittal(s) / Grant(s)

This submittal(s) (test report) is intended to comply with FCC Part 95 Rules.

2.6. Modifications

No modifications were implemented to meet testing criteria.

3. TEST CONDITIONS AND RESULTS

3.1. Maximum Transmitter Power

LIMITS

According to FCC Part 95.567:

Each FRS transmitter type must be designed such that the effective radiated power (ERP) on channels 8 through 14 does not exceed 0.5 Watts and the ERP on channels 1 through 7 and 15 through 22 does not exceed 2.0 Watts.

TEST CONFIGURATION

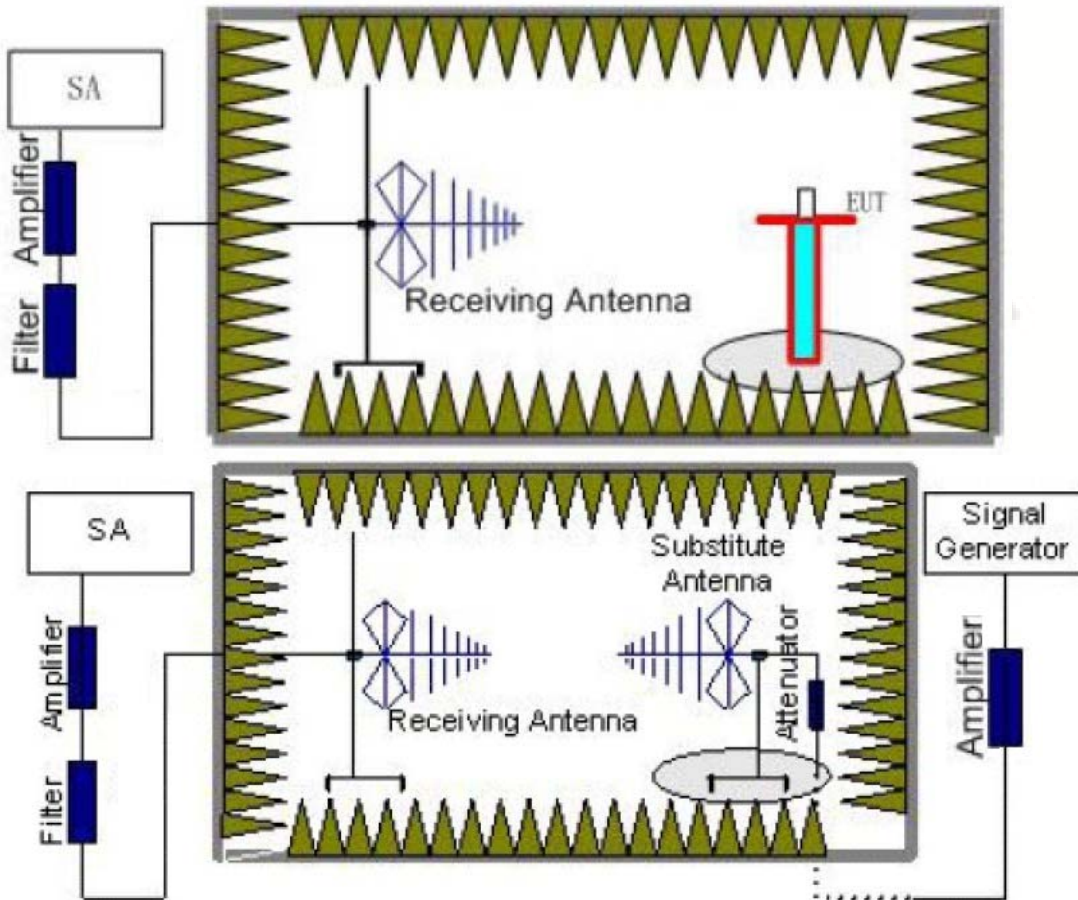

Measurement Procedure

1. EUT was placed on a 0.8 meter high non-conductive stand at a 3 meter test distance from the receive antenna. A receiving antenna was placed on the antenna mast 3 meters from the EUT for emission measurements. The height of receiving antenna is 1.0m. Detected emissions were maximized at each frequency by rotating the EUT through 360° and adjusting the receiving antenna polarization. The radiated emission measurements of all test transmit frequencies were measured with peak detector.
2. A log-periodic antenna or double-ridged waveguide horn antenna shall be substituted in place of the EUT. The log-periodic antenna will be driven by a signal generator and the level will be adjusted till the same power value on the spectrum analyzer or receiver. The level of the spurious emissions can be

calculated through the level of the signal generator, cable loss, the gain of the substitution antenna and the reading of the spectrum analyzer or receiver.

3. The EUT is then put into continuously transmitting mode at its maximum power level during the test. Set Test Receiver or Spectrum RBW=1MHz, VBW=3MHz, And the maximum value of the receiver should be recorded as (P_r).
4. The EUT shall be replaced by a substitution antenna. In the chamber, a substitution antenna for the frequency band of interest is placed at the reference point of the chamber. An RF Signal source for the frequency band of interest is connected to the substitution antenna with a cable that has been constructed to not interfere with the radiation pattern of the antenna. A power (P_{Mea}) is applied to the input of the substitution antenna, and adjust the level of the signal generator output until the value of the receiver reach the previously recorded (P_r). The power of signal source (P_{Mea}) is recorded. The test should be performed by rotating the test item and adjusting the receiving antenna polarization.
5. An amplifier may be connected to the Signal Source output port. And the cable should be connect between the Amplifier and the Substitution Antenna. The cable loss (P_{cl}), the Substitution Antenna Gain (G_a) and the Amplifier Gain (P_{Ag}) should be recorded after test.
The measurement results are obtained as described below:
$$\text{Power(EIRP)} = P_{Mea} + P_{Ag} - P_{cl} + G_a$$
6. This value is EIRP since the measurement is calibrated using an antenna of known gain (2.15 dBi) and known input power.
7. ERP can be calculated from EIRP by subtracting the gain of the dipole, $ERP = EIRP - 2.15\text{dBi}$.

TEST RESULTS

Remark;

The field strength of radiation emission was measured in the following position: EUT stand-up position (Z axis), lie-down position (X, Y axis). The data show in this report only with the worst case setup. After exploratory measurement the worst case of Z axis and receiver antenna at vertical polarization was reported.

Test Frequency (MHz)	P _{Mea} (dBm)	P _{cl} (dB)	G _a Antenna Gain(dBi)	Correction (dB)	P _{Ag} (dB)	ERP (dBm)	ERP (W)	Limit (W)	Polarization
462.6375	-11.51	2.08	7.69	2.15	34.59	26.54	0.4508	2.0	V
467.6375	-11.36	2.13	7.75	2.15	34.62	26.73	0.4710	0.5	V
462.6500	-11.57	2.08	7.69	2.15	34.59	26.48	0.4446	2.0	V

Remark:

- $EIRP = P_{Mea}(dBm) + P_{Ag}(dB) - P_{cl}(dB) + G_a(dBi)$
- $ERP = EIRP - 2.15dBi$ as ERP by subtracting the gain of the dipole.

3.2. Occupied Bandwidth and Emission Mask

LIMITS

According to FCC 95.573:

Each FRS transmitter type must be designed such that the occupied bandwidth does not exceed 12.5 kHz.

According to FCC 95.579:

At least 25dB (decibels) on any frequency removed from the center of the authorized bandwidth by more than 50 % up to and including 100 % of the authorized bandwidth.

At least 35 dB on any frequency removed from the center of the authorized bandwidth by more than 100 % up to and including 250 % of the authorized bandwidth.

At least $43 + 10 \log_{10}(T)$ dB on any frequency removed from the center of the authorized bandwidth by more than 250 %.

TEST CONFIGURATION

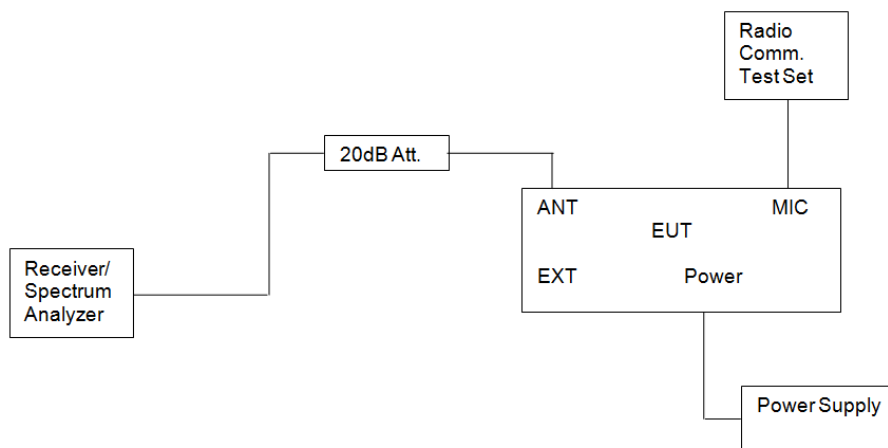

TEST PROCEDURE

- 1 The EUT was modulated by 2.5 KHz Sine wave audio signal; the level of the audio signal employed is 16 dB greater than that necessary to produce 50% of rated system deviation. Rated system deviation is 2.5 kHz (12.5 kHz channel spacing) and 5 kHz (25 kHz channel spacing).
- 2 Set SPA Center Frequency = fundamental frequency, RBW=300Hz, VBW= 3 KHz, span =50 KHz.
- 3 Set SPA Max hold. Mark peak, Set 99% Occupied Bandwidth and 26dB Occupied Bandwidth.

TEST RESULTS

Occupied Bandwidth:

Modulation	Channel	99% OBW (kHz)	26dB bandwidth (kHz)	Limit (KHz)	Result
FM	CH4	9.212	10.54	12.5	Pass
	CH11	9.167	10.46	12.5	Pass
	CH16	9.514	10.56	12.5	Pass

CH4

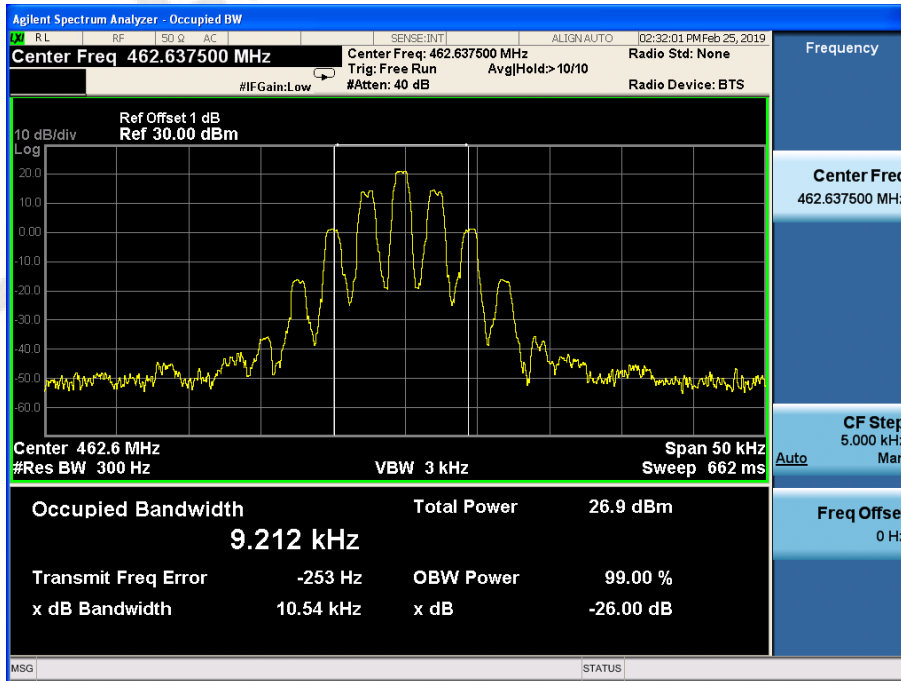

CH11

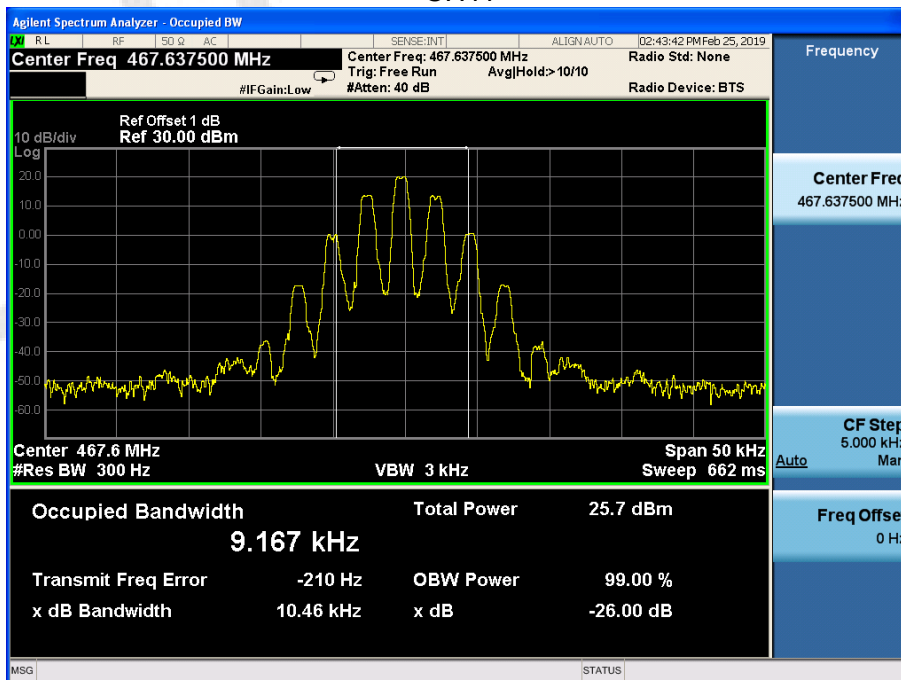

CH16

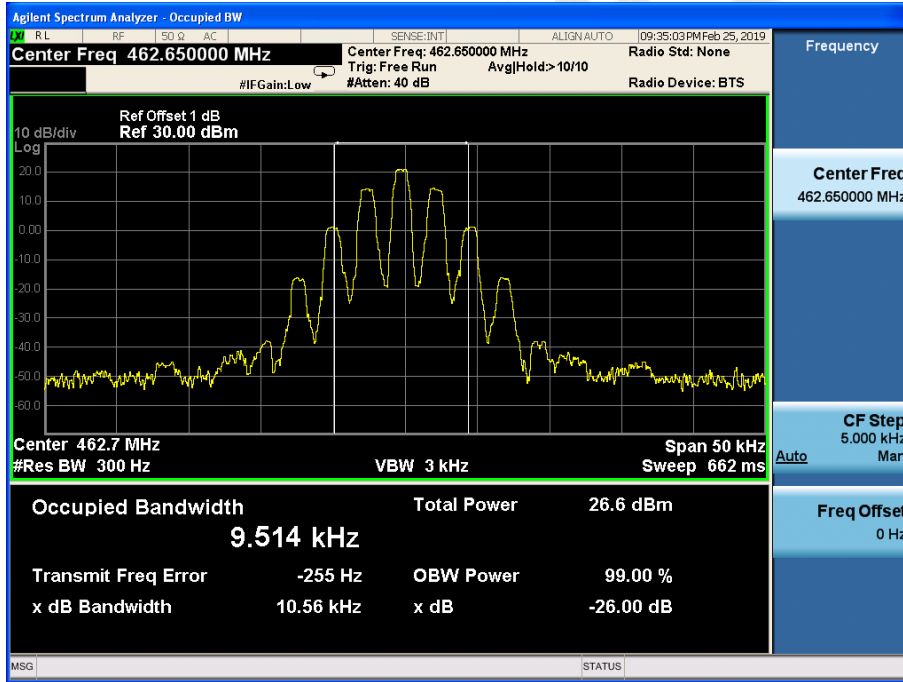

Emission Mask:

CH4

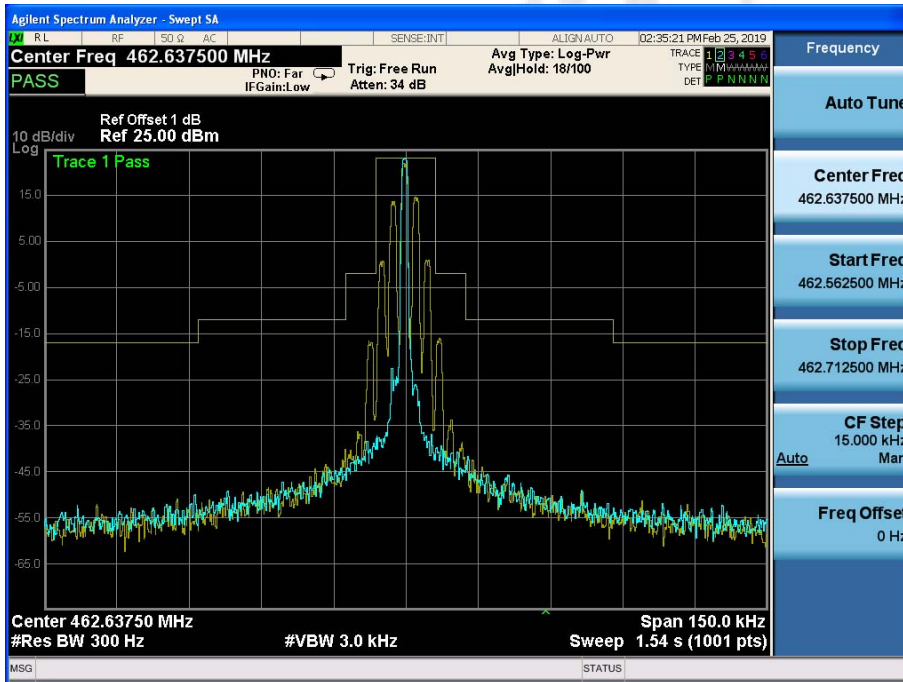

CH11

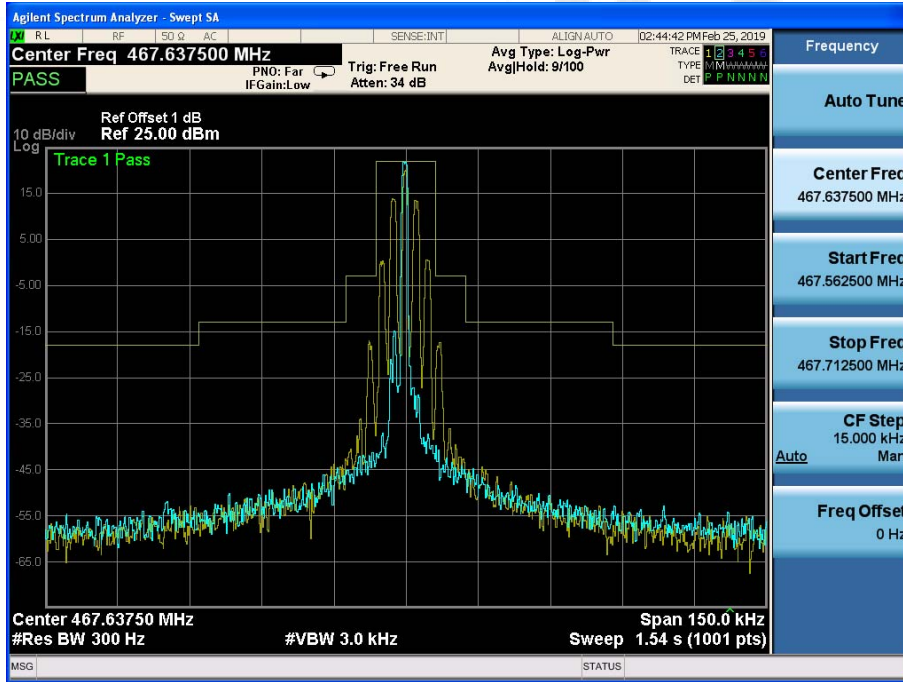

CH16

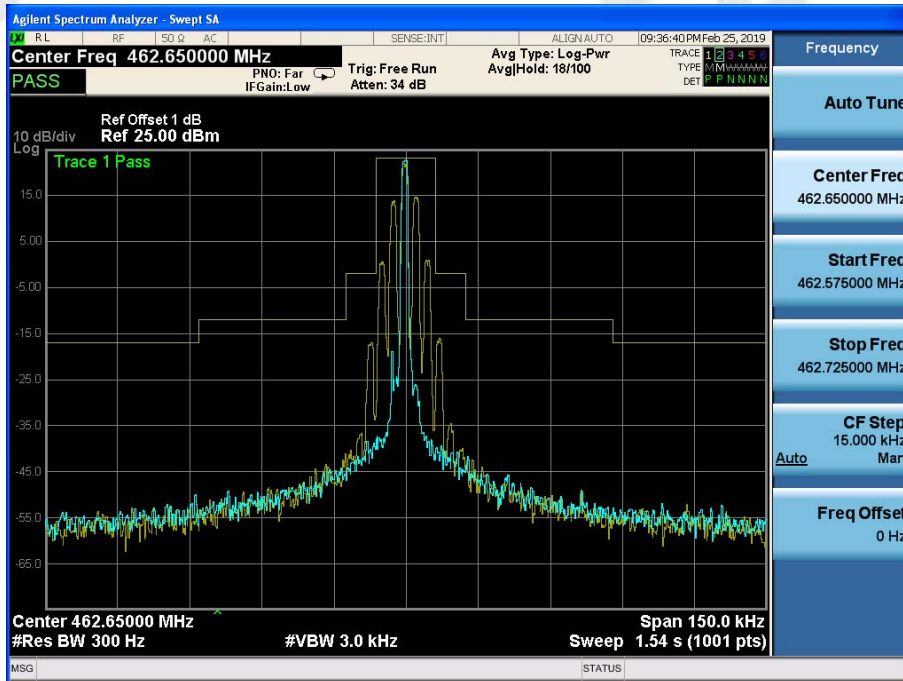

3.3. Modulation Limit

LIMITS

FCC Part 95.575, FCC Part 2.1047(b) Each FRS transmitter type must be designed such that the peak frequency deviation does not exceed 2.5 kHz, and the highest audio frequency contributing substantially to modulation must not exceed 3.125 kHz.

TEST PROCEDURE

Modulation Limit

- 1) Connect the equipment as illustrated.
- 2) Adjust the transmitter per the manufacturer's procedure for full rated system deviation.
- 3) Set the test receiver to measure peak positive deviation. Set the audio bandwidth for ≤ 0.25 Hz to $\geq 15,000$ Hz. Turn the de-emphasis function off.
- 4) Apply Input Modulation Signal to EUT according to Section 3.4 and vary the input level from -20 to $+20$ dB.
- 5) Measure both the instantaneous and steady-state deviation at and after the time of increasing the audio input level
- 6) Repeat step 4-5 with input frequency changing to 300Hz, 1004Hz, 1500Hz and 2500Hz in sequence

TEST CONFIGURATION

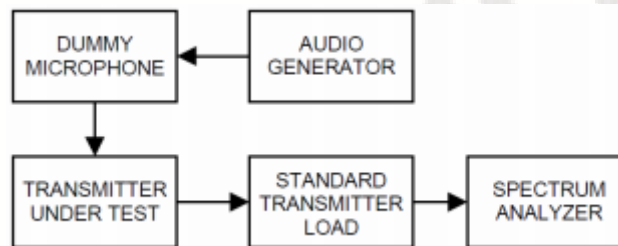

TEST RESULTS

Modulation Level(dB)	Peak Freq. Deviation At 300 Hz(KHz)	Peak Freq. Deviation At 1004 Hz(KHz)	Peak Freq. Deviation At 1500 Hz(KHz)	Peak Freq. Deviation At 2500 Hz(KHz)
-20	0.08	0.19	0.26	0.4
-15	0.11	0.3	0.44	0.68
-10	0.18	0.51	0.76	1.19
-5	0.29	0.88	1.33	1.77
0	0.48	1.52	1.87	1.9
+5	0.74	1.83	1.95	1.92
+10	0.79	1.85	1.96	1.94
+15	0.8	1.85	1.97	1.94
+20	0.87	1.86	1.98	1.94

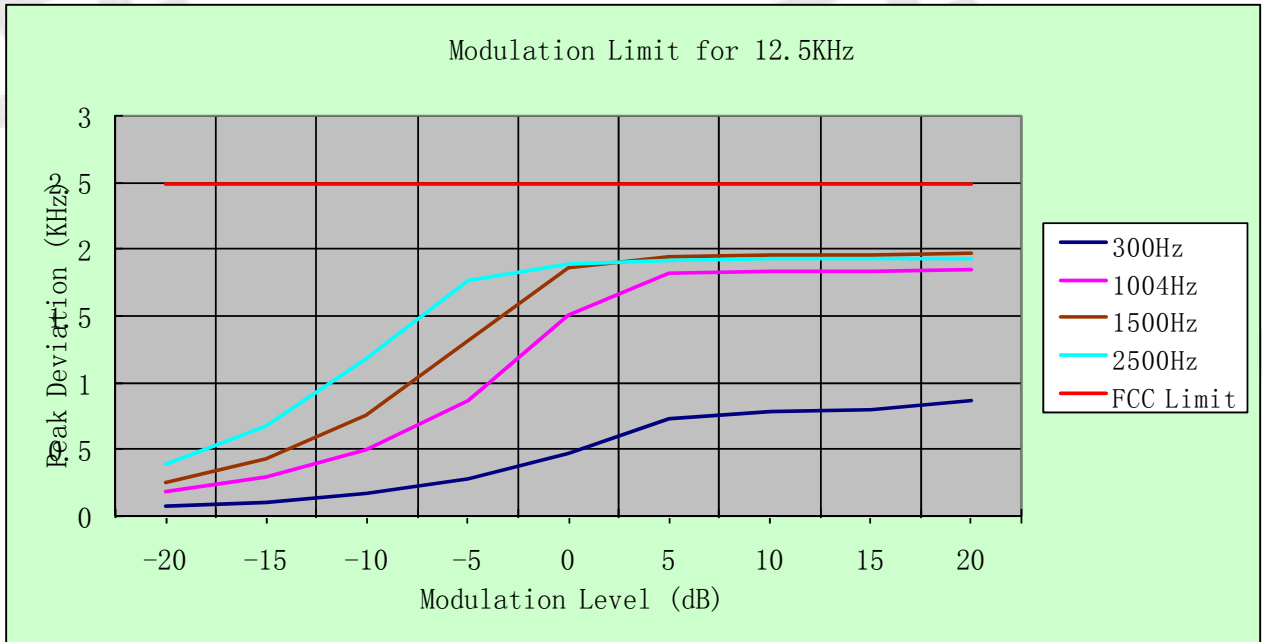

3.4. Audio Frequency Response

LIMIT

FCC Part 95.575), FCC Part 2.1047(a): Each FRS transmitter type must be designed such that the peak frequency deviation does not exceed 2.5 kHz, and the highest audio frequency contributing substantially to modulation must not exceed 3.125 kHz. Voice modulated communication equipment. A curve or equivalent data showing the frequency response of the audio modulating circuit over a range of 100 to 5000 Hz shall be submitted.

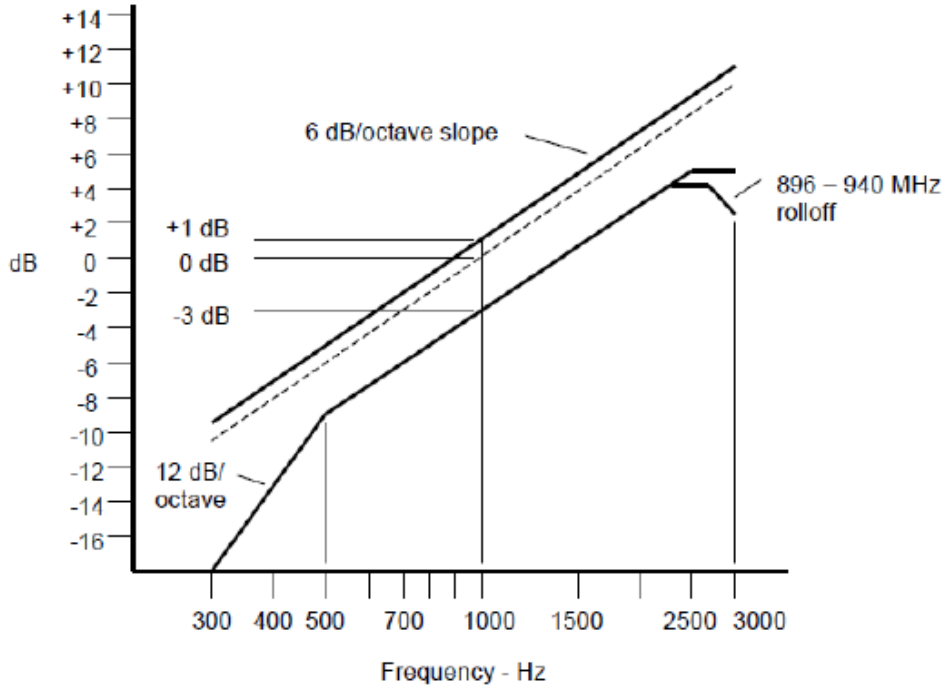

An additional 6 dB per octave attenuation is allowed from 2500 Hz to 3000 Hz in equipment operating in the 25 MHz to 869 MHz range.

TEST CONFIGURATION

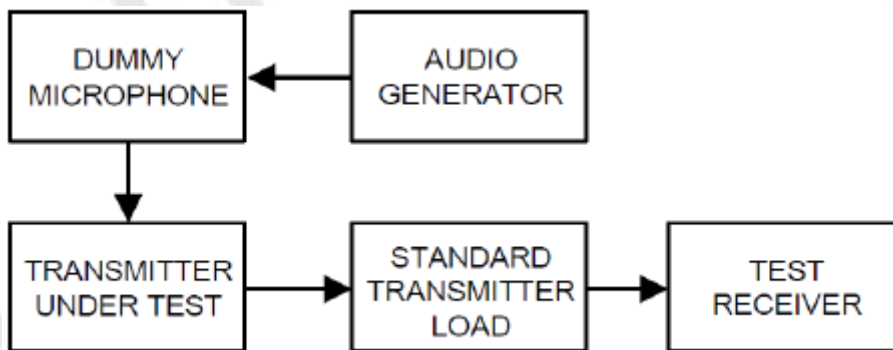

TEST PROCEDURE

- 1) Connect the equipment as illustrated.
- 2) Set the test receiver to measure peak positive deviation. Set the audio bandwidth for 50 Hz to 15,000 Hz. Turn the de-emphasis function off.
- 3) Set the DMM to measure rms voltage.
- 4) Adjust the transmitter per the manufacturer's procedure for full rated system deviation.
- 5) Apply Input Modulation Signal to EUT.
- 6) Set the test receiver to measure rms deviation and record the deviation reading.
- 7) Record the DMM reading as V_{REF} .
- 8) Set the audio frequency generator to the desired test frequency between 300 Hz and 3000 Hz.

- 9) Vary the audio frequency generator output level until the deviation reading that was recorded in step 6) is obtained.
- 10) Record the DMM reading as V_{FREQ}
- 11) Calculate the audio frequency response at the present frequency as: audio frequency response = $20\log_{10}(V_{FREQ}/V_{REF})$.
- 12) Repeat steps 8) through 11) for all the desired test frequencies

TEST RESULTS

Frequency (KHz)	Frequency Deviation (KHz)	1KHz Reference Deviation (KHz)	Audio Frequency Response (dB)
0.1	0.06	0.51	-18.59
0.2	0.05	0.51	-20.17
0.3	0.09	0.51	-15.07
0.4	0.14	0.51	-11.23
0.5	0.18	0.51	-9.05
0.6	0.27	0.51	-5.52
0.7	0.34	0.51	-3.52
0.8	0.38	0.51	-2.56
0.9	0.40	0.51	-2.11
1.0	0.51	0.51	0.00
1.2	0.59	0.51	1.27
1.4	0.69	0.51	2.63
1.6	0.76	0.51	3.46
1.8	0.91	0.51	5.03
2.0	0.95	0.51	5.40
2.2	1.03	0.51	6.11
2.4	1.16	0.51	7.14
2.6	1.21	0.51	7.50
2.7	1.23	0.51	7.65
2.8	1.36	0.51	8.52
3.0	1.29	0.51	8.06
3.5	0.05	0.51	-20.17
4.0	0.05	0.51	-20.17
4.5	0.05	0.51	-20.17
5.0	0.05	0.51	-20.17

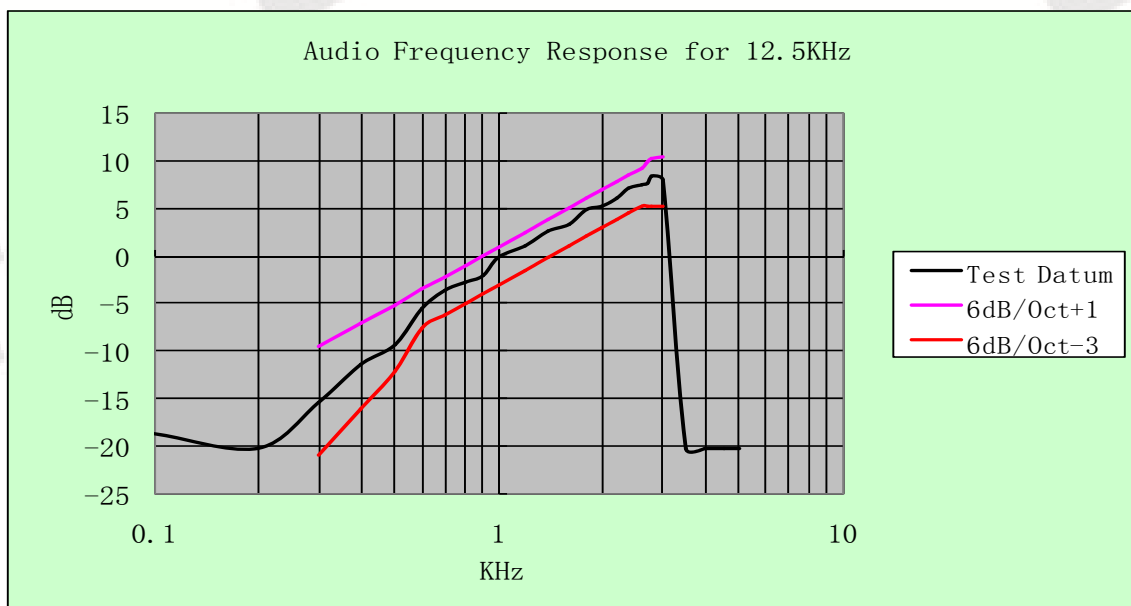

3.5. Frequency Stability

LIMITS

According to FCC 95.565

Each FRS transmitter type must be designed such that the carrier frequencies remain within ± 2.5 parts-per-million of the channel center frequencies specified in §95.563 during normal operating conditions.

TEST CONFIGURATION

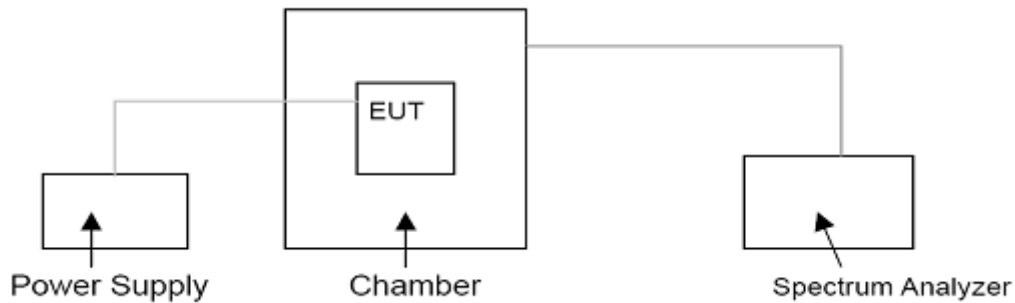

TEST PROCEDURE

The EUT was set in the climate chamber and connected to an external DC power supply. The RF output was directly connected to Spectrum Analyzer. The coupling loss of the additional cables was recorded and taken in account for all the measurements. After temperature stabilization (approx. 20 min for each stage), the frequency for the lower, the middle and the highest frequency range was recorded. For Frequency stability Vs. Voltage the EUT was connected to a DC power supply and the voltage was adjusted in the required ranges. The result was recorded.

TEST RESULTS

Reference Frequency: 462.6375MHz					
Voltage (V)	Temperature (°C)	Frequency error (Hz)	Frequency Tolerance (ppm)	Limit (ppm)	Result
6.0	-30	34.19	0.0739	±2.5	Pass
	-20	85.52	0.1849		
	-10	30.20	0.0653		
	0	50.65	0.1095		
	10	46.46	0.1004		
	20	72.62	0.1570		
	30	59.73	0.1291		
	40	82.86	0.1791		
	50	91.91	0.1987		
6.9	25	77.86	0.1683		
5.1	25	78.20	0.1690		

Reference Frequency: 467.6375MHz					
Voltage (V)	Temperature (°C)	Frequency error (Hz)	Frequency Tolerance (ppm)	Limit (ppm)	Result
6.0	-30	70.32	0.1504	±2.5	Pass
	-20	66.28	0.1417		
	-10	94.45	0.2020		
	0	34.09	0.0729		
	10	44.91	0.0960		
	20	57.19	0.1223		
	30	39.80	0.0851		
	40	58.47	0.1250		
	50	50.91	0.1089		
6.9	25	40.67	0.0870		
5.1	25	38.25	0.0818		

Reference Frequency: 462.6500MHz					
Voltage (V)	Temperature (°C)	Frequency error (Hz)	Frequency Tolerance (ppm)	Limit (ppm)	Result
6.0	-30	94.71	0.2034	±2.5	Pass
	-20	34.64	0.0744		
	-10	48.89	0.1050		
	0	50.94	0.1094		
	10	86.65	0.1861		
	20	66.81	0.1435		
	30	51.39	0.1104		
	40	87.34	0.1876		
	50	64.19	0.1379		
6.9	25	72.26	0.1552		
5.1	25	84.70	0.1819		

3.6. Transmitter Radiated Spurious Emission

Limit

The unwanted emission should be attenuated below TP by at least $43+10\log(\text{Transmit Power})$ dB and unwanted emissions falling within the restricted bands of RSS-Gen shall be attenuated to the limits provided in this section or to the general field strength limits shown in RSS-Gen, whichever are less stringent.

TEST CONFIGURATION

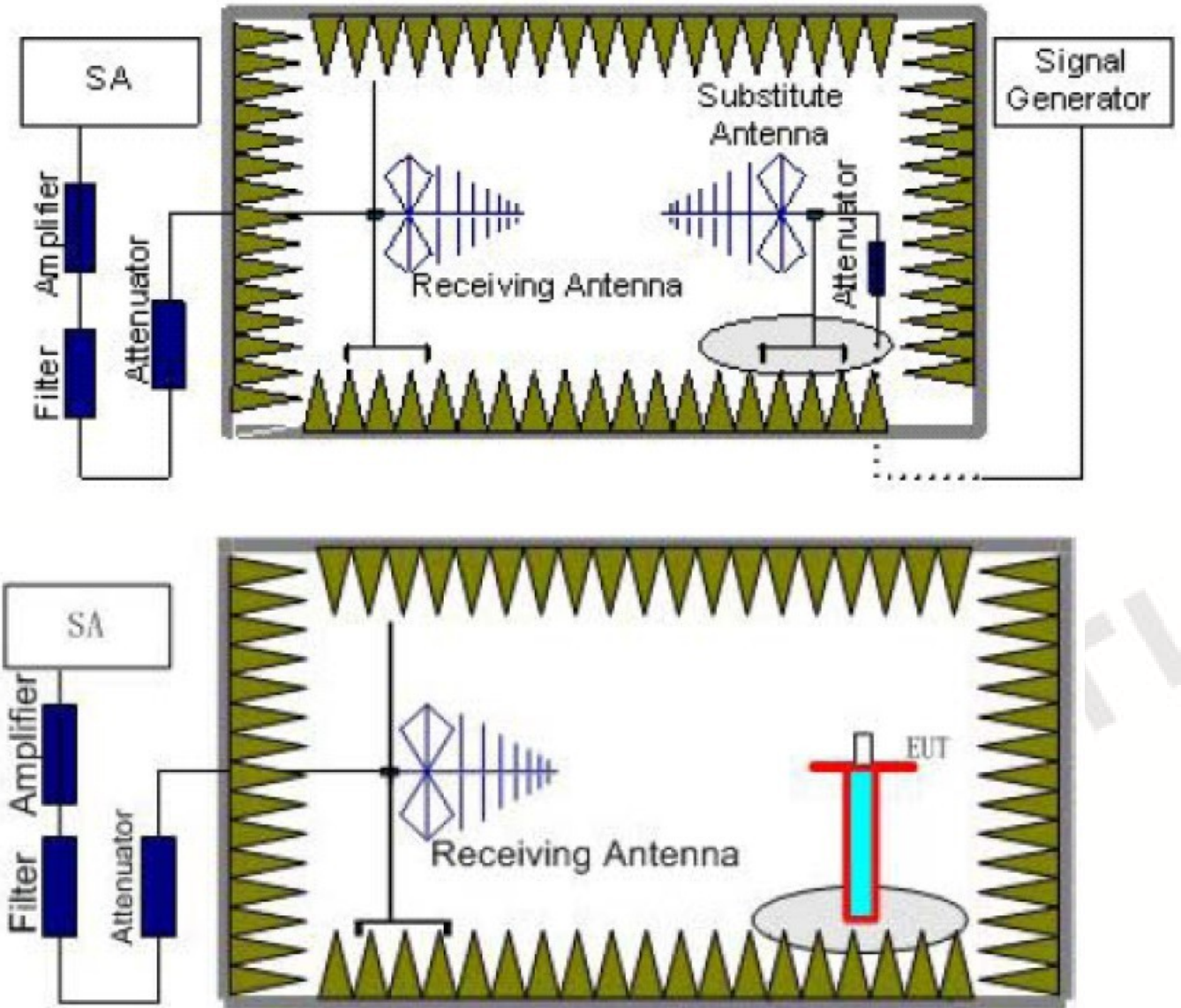

TEST PROCEDURE

- a. EUT was placed on a 0.8 meter high non-conductive stand at a 3 meter test distance from the receive antenna. A receiving antenna was placed on the antenna mast 3 meters from the EUT for emission measurements. The height of receiving antenna is 1.0m. Detected emissions were maximized at each frequency by rotating the EUT through 360° and adjusting the receiving antenna polarization. The radiated emission measurements of all test transmit frequencies were measured with peak detector.
- b. A log-periodic antenna or double-ridged waveguide horn antenna shall be substituted in place of the EUT. The log-periodic antenna will be driven by a signal generator and the level will be adjusted till the same power value on the spectrum analyzer or receiver. The level of the spurious emissions can be calculated through the level of the signal generator, cable loss, the gain of the substitution antenna and the reading of the spectrum analyzer or receiver.
- c. The EUT is then put into continuously transmitting mode at its maximum power level during the test. Set Test Receiver or Spectrum 100 kHz below 1GHz and 1MHz above 1GHz, Sweep from 30MHz to the 10th harmonic of the fundamental frequency; and recorded the level of the concerned spurious emission point as (P_r).
- d. The EUT then replaced by a substitution antenna. In the chamber, an substitution antenna for the frequency band of interest is placed at the reference point of the chamber. An RF Signal source for the frequency band of interest is connected to the substitution antenna with a cable that has been constructed to not interfere with the radiation pattern of the antenna. A power (P_{Mea}) is applied to the input of the substitution antenna, and adjust the level of the signal generator output until the value of the receiver reach the previously recorded (P_r). The power of signal source (P_{Mea}) is recorded. The test should be performed by rotating the test item and adjusting the receiving antenna polarization. The measurement results are obtained as described below:

$$\text{Power}_{(EIRP)} = P_{Mea} - P_{cl} + G_a$$

Where;

- P_{Mea} is the recorded signal generator level
- P_{cl} is the cable loss connect between instruments
- G_a Substitution Antenna Gain

- e. This value is EIRP since the measurement is calibrated using an antenna of known gain (2.15 dBi) and known input power.
- f. ERP can be calculated from EIRP by subtracting the gain of the dipole, $ERP = EIRP - 2.15\text{dBi}$.
- g. Test site anechoic chamber refer to ANSI C63.

TEST RESULTS

Remark: The measurement frequency range is from 30MHz to the 10th harmonic of the fundamental frequency; and worst spurious emissions recorded as below:

Test Frequency (MHz)	Frequency (MHz)	P _{Mea} (dBm)	P _{cl} (dB)	Distance (m)	G _a Antenna Gain(dBi)	Peak EIRP (dBm)	Limit (dBm)	Margin (dB)	Pol.
462.6375	925.25	-28.69	3.54	3.00	12.87	-19.36	-13.00	6.36	V
	1387.75	-33.50	4.21	3.00	15.48	-22.23	-13.00	9.23	V
	1850.50	-37.32	4.52	3.00	17.32	-24.52	-13.00	11.52	V
	2313.25	-41.07	5.24	3.00	18.76	-28.99	-13.00	15.99	V
	--	--	--	--	--	--	--	--	--
467.6375	935.28	-27.46	3.57	3.00	12.90	-18.13	-13.00	5.13	V
	1042.91	-33.14	4.25	3.00	15.53	-21.86	-13.00	8.86	V
	1870.55	-38.81	4.60	3.00	17.46	-25.95	-13.00	12.95	V
	2338.20	-40.95	5.37	3.00	18.92	-27.40	-13.00	14.40	V
	--	--	--	--	--	--	--	--	--
462.5600	925.10	-29.43	3.54	3.00	12.87	-20.10	-13.00	7.10	V
	1387.70	-34.52	4.21	3.00	15.48	-23.25	-13.00	10.25	V
	1850.25	-39.34	4.52	3.00	17.32	-26.54	-13.00	13.54	V
	2313.50	-42.80	5.24	3.00	18.76	-29.28	-13.00	16.28	V
	--	--	--	--	--	--	--	--	--

Remark:

1. $EIRP = P_{Mea}(dBm) - P_{cl}(dB) + G_a(dBi)$
2. -- Means other points for values lower than limits and not recorded.
3. $Margin = Limit - EIRP$

4. Test Setup Photos of the EUT

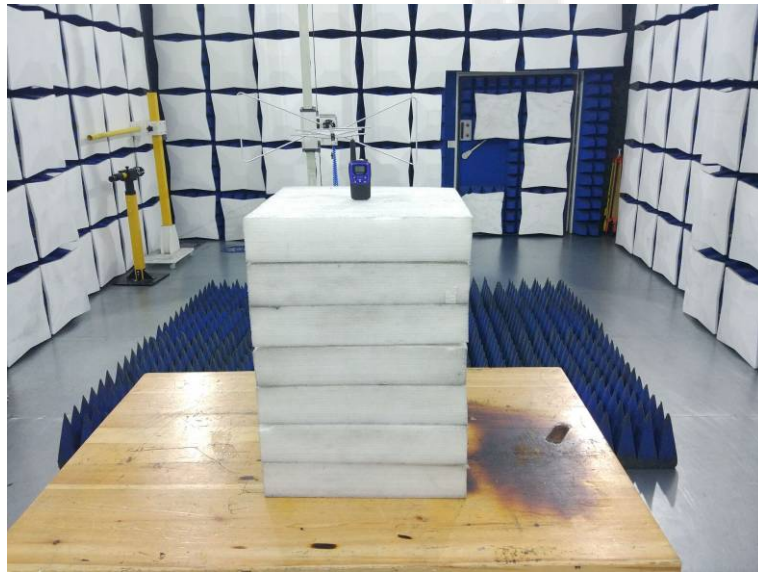

5. External and Internal Photos of the EUT

External Photos of EUT







Internal Photos of EUT

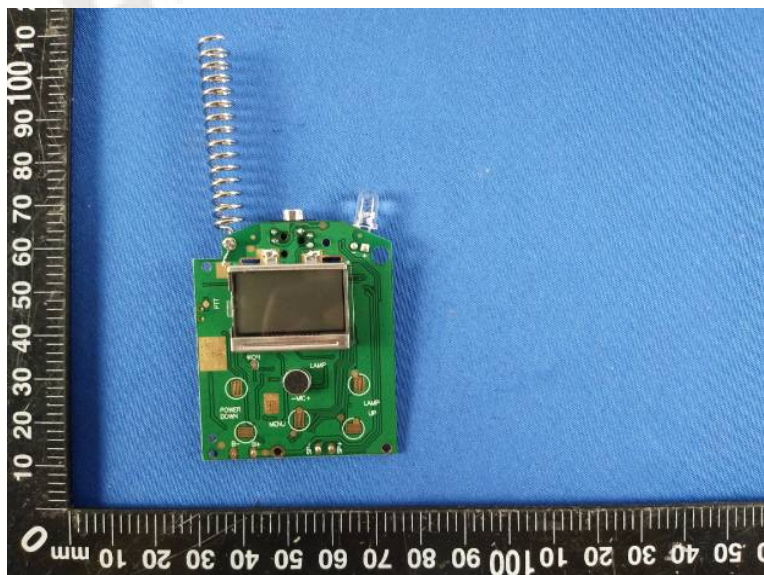
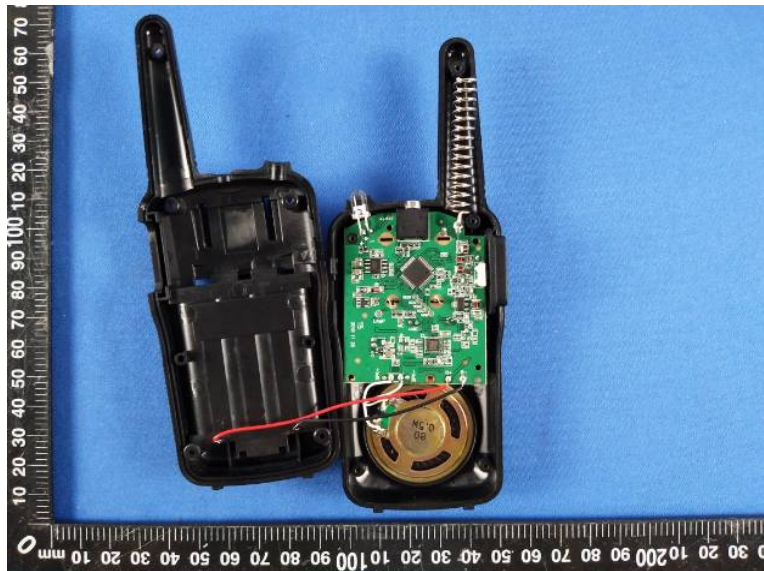

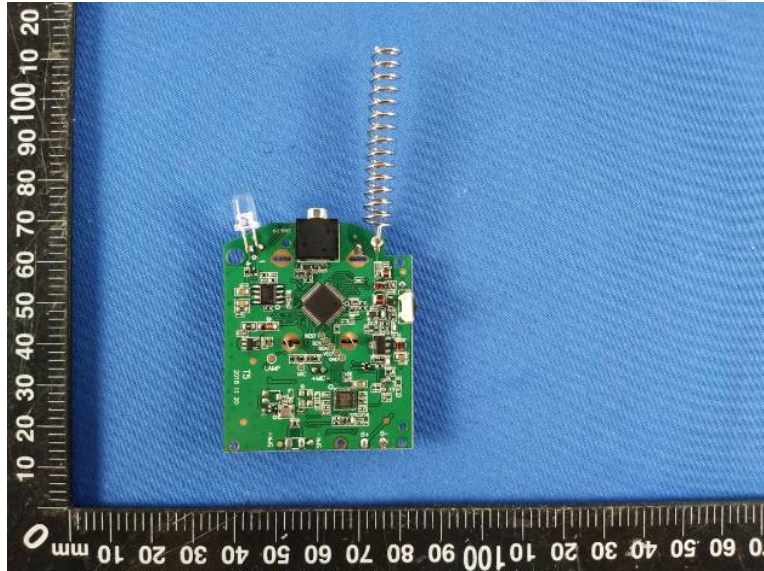

***** End of Report *****