

Report on the Radio Testing
For
Raspberry Pi (Trading) Ltd
on
Raspberry Pi 3
Report no. TRA-029073-45-02B
18th February 2016

RF916 2.0

Report Number: TRA-029073-45-02B
Issue: B

REPORT ON THE RADIO TESTING OF A
Raspberry Pi (Trading) Ltd
Raspberry Pi 3
WITH RESPECT TO SPECIFICATION
FCC 47CFR 15.247 & IC RSS-247

TEST DATE: 29/01/2016

Written by: A Longley

A Longley
Radio Test Engineer

Approved by:

J Charters
Department Manager - Radio

Date: 18th February 2016

Disclaimers:

- [1] THIS DOCUMENT MAY BE REPRODUCED ONLY IN ITS ENTIRETY AND WITHOUT CHANGE
- [2] THE RESULTS CONTAINED IN THIS DOCUMENT RELATE ONLY TO THE ITEM(S) TESTED

RF916 2.0

1 Revision Record

<i>Issue Number</i>	<i>Issue Date</i>	<i>Revision History</i>
A	18th February 2016	Original

2 Summary

TEST REPORT NUMBER: TRA-029073-45-02B

WORKS ORDER NUMBER: TRA-029073-01

PURPOSE OF TEST: USA: Testing of radio frequency equipment per the relevant authorization procedure of chapter 47 of CFR (code of federal regulations) Part 2, subpart J.

Canada: Testing of radio apparatus for TAC (technical acceptance certificate) per subsections 4(2) of the Radio communication Act and 21(1) of the Radio communication Regulations.

TEST SPECIFICATION(S): 47CFR15.247 & RSS-247

EQUIPMENT UNDER TEST (EUT): Raspberry Pi 3

FCC IDENTIFIER: 2ABCB-RPI32

IC IDENTIFIER: 20953-RPI32

EUT SERIAL NUMBER: Prototype

MANUFACTURER/AGENT: Raspberry Pi (Trading) Ltd

ADDRESS: 30 Station Road
Cambridge
Cambridgeshire
CB1 2JH
United Kingdom

CLIENT CONTACT: Gordon Hollingworth
☎ 01223 322633
✉ gordon@raspberrypi.org

ORDER NUMBER: PO-0175

TEST DATE: 29/01/2016

TESTED BY: A Longley
Element

2.1 Test Summary

Test Method and Description	Requirement Clause		Applicable to this equipment	Result / Note
	RSS	47CFR15		
Radiated spurious emissions (restricted bands of operation and cabinet radiation)	Gen, 8.10	15.205	☒	Pass
AC power line conducted emissions	Gen, 8.8	15.207	☒	Pass
Carrier frequency separation	247, 5.1 (2)	15.247(a)(1)	☒	Pass
Number of hopping channels	247, 5.1 (3), (4) and (5)	15.247(a)(1) (i), (ii) and (iii)	☒	Pass
Average time of occupancy	247, 5.1 (3), (4) and (5)	15.247(a)(1) (i), (ii) and (iii)	☒	Pass
Maximum peak conducted output power	247, 5.4 (1), (2) and (3)	15.247 (a)(1), (b)(1) and (b)(2)	☒	Pass
20dB emission bandwidth	247, 5.1 (3) and (4)	15.247(a)(1) (i) and (ii)	☒	Pass
Out-of-band emissions	247, 5.5	15.247(d)	☒	Pass
Radiated spurious emissions (receive mode)	-	15.109	☒	Pass

Note s:

The results contained in this report relate only to the items tested, in the condition at time of test, and were obtained in the period between the date of initial receipt of samples and the date of issue of the report.

The apparatus was set up and exercised using the configurations, modes of operation and arrangements defined in this report only. Any modifications made are identified in Section 8 of this report.

Particular operating modes, apparatus monitoring methods and performance criteria required by the standards tested to have been performed except where identified in Section 5.2 of this test report (Deviations from Test Standards).

3 Contents

1	Revision Record.....	3
2	Summary.....	4
2.1	Test Summary.....	5
3	Contents.....	6
4	Introduction.....	8
5	Test Specifications.....	9
5.1	Normative References.....	9
5.2	Deviations from Test Standards.....	9
6	Glossary of Terms.....	10
7	Equipment Under Test.....	11
7.1	EUT Identification.....	11
7.2	System Equipment.....	11
7.3	EUT Mode of Operation.....	11
7.3.1	Transmission.....	11
7.3.2	Reception.....	11
7.4	EUT Radio Parameters.....	12
7.4.1	General.....	12
7.4.2	Antennas.....	12
7.4.3	Product specific declarations.....	13
7.5	EUT Description.....	13
8	Modifications.....	14
9	EUT Test Setup.....	15
9.1	Block Diagram.....	15
9.2	General Set-up Photograph.....	16
10	General Technical Parameters.....	17
10.1	Normal Conditions.....	17
10.2	Varying Test Conditions.....	17
11	Radiated emissions.....	18
11.1	Definitions.....	18
11.2	Test Parameters.....	18
11.3	Test Limit.....	18
11.4	Test Method.....	19
11.5	Test Set-up Photograph.....	20
11.6	Test Equipment.....	21
11.7	Test Results.....	22
12	AC power-line conducted emissions.....	46
12.1	Definition.....	46
12.2	Test Parameters.....	46
12.3	Test Method.....	47
12.4	Test Set-up Photograph.....	48
12.5	Test Equipment.....	48
12.6	Test Results.....	49
13	Carrier frequency separation.....	50
13.1	Definition.....	50
13.2	Test Parameters.....	50
13.3	Test Limit.....	50
13.4	Test Method.....	51
13.5	Test Equipment.....	51
13.6	Test Results.....	51
14	Number of hopping frequencies.....	53
14.1	Definition.....	53
14.2	Test Parameters.....	53
14.3	Test Limit.....	53
14.4	Test Method.....	54
14.5	Test Equipment.....	54
14.6	Test Results.....	54
15	Average channel occupancy.....	56
15.1	Definition.....	56
15.2	Test Parameters.....	56
15.3	Test Limit.....	56
15.4	Test Method.....	57
15.5	Test Equipment.....	57
15.6	Test Results.....	57

16	Maximum peak conducted output power	59
16.1	Definition	59
16.2	Test Parameters	59
16.3	Test Limit.....	59
16.4	Test Method.....	60
16.5	Test Equipment.....	60
16.6	Test Results.....	60
17	Occupied Bandwidth.....	61
17.1	Definition	61
17.2	Test Parameters	61
17.3	Test Limit.....	61
17.4	Test Method.....	62
17.5	Test Equipment.....	62
17.6	Test Results.....	63
18	Out-of-band and conducted spurious emissions	67
18.1	Definition	67
18.2	Test Parameters	67
18.3	Test Limits.....	67
18.4	Test Method.....	68
18.5	Test Equipment.....	68
18.6	Test Results.....	68
19	Radiated emissions – unintentional radiation / receiver emissions	99
19.1	Definitions	99
19.2	Test Parameters	99
19.3	Test Limit.....	99
19.4	Test Method.....	100
19.5	Test Set-up Photograph.....	100
19.6	Test Equipment.....	101
19.7	Test Results.....	102
20	Measurement Uncertainty.....	112
21	RF Exposure.....	113

4 Introduction

This report TRA-029073-45-02B presents the results of the Radio testing on a Raspberry Pi (Trading) Ltd, Raspberry Pi 3 to specification 47CFR15 Radio Frequency Devices and RSS-247 Digital Transmission Systems (DTSs), Frequency Hopping Systems (FHSs) and Licence-Exempt Local Area Network (LE-LAN) Devices.

The testing was carried out for Raspberry Pi (Trading) Ltd by Element, at the address(es) detailed below.

<input checked="" type="checkbox"/>	Element Hull Unit E South Orbital Trading Park Hedon Road Hull HU9 1NJ UK	<input type="checkbox"/>	Element North West Unit 1 Pendle Place Skemersdale West Lancashire WN8 9PN UK
-------------------------------------	---	--------------------------	---

This report details the configuration of the equipment, the test methods used and any relevant modifications where appropriate.

All test and measurement equipment under the control of the laboratory and requiring calibration is subject to an established programme and procedures to control and maintain measurement standards. The quality management system meets the principles of ISO 9001, and has quality control procedures for monitoring the validity of tests undertaken. Records and sufficient detail are retained to establish an audit trail of calibration records relating to its test results for a defined period. Under control of the established calibration programme, key quantities or values of the test & measurement instrumentation are within specification and comply with the relevant traceable internationally recognised and appropriate standard specifications, which are UKAS calibrated as such where these properties have a significant effect on results. Participation in inter-laboratory comparisons and proficiency testing ensures satisfactory correlation of results conform to Elements own procedures, as well as statistical techniques for analysis of test data providing the appropriate confidence in measurements.

Throughout this report EUT denotes equipment under test.

FCC Site Listing:

Element is accredited for the above sites under the US-EU MRA, Designation number UK0009.

IC Registration Number(s):

Element North West	3930B
Element Hull	3483A-1

The test site requirements of ANSI C63.4-2014 are met up to 1GHz.

The test site SVSWR requirements of CISPR 16-1-4:2010 are met over the frequency range 1 GHz to 18 GHz.

5 Test Specifications

5.1 Normative References

- FCC 47 CFR Ch. I – Part 15 – Radio Frequency Devices.
- ANSI C63.10-2013 – American National Standard of Procedures for Compliance Testing of Unlicensed Wireless Devices.
- ANSI C63.4-2014 – American National Standard for Methods of Measurement of Radio-Noise Emissions from Low-Voltage Electrical and Electronic Equipment in the Range of 9 kHz to 40 GHz.
- Industry Canada RSS-210, Issue 8, December 2010 – Licence-exempt Radio Apparatus (All Frequency Bands): Category I Equipment.
- Industry Canada RSS-247, Issue 1, May 2015 – Digital Transmission Systems (DTSs), Frequency Hopping Systems (FHSs) and Licence-Exempt Local Area Network (LE-LAN) Devices
- Industry Canada RSS-Gen, Issue 4, November 2014 – General Requirements for Compliance of Radio Apparatus.

5.2 Deviations from Test Standards

There were no deviations from the test standard.

6 Glossary of Terms

§	denotes a section reference from the standard, not this document
AC	Alternating Current
ANSI	American National Standards Institute
BW	bandwidth
C	Celsius
CFR	Code of Federal Regulations
CW	Continuous Wave
dB	decibel
dBm	dB relative to 1 milliwatt
DC	Direct Current
DSSS	Direct Sequence Spread Spectrum
EIRP	Equivalent Isotropically Radiated Power
ERP	Effective Radiated Power
EUT	Equipment Under Test
FCC	Federal Communications Commission
FHSS	Frequency Hopping Spread Spectrum
Hz	hertz
IC	Industry Canada
ITU	International Telecommunication Union
LBT	Listen Before Talk
m	metre
max	maximum
MIMO	Multiple Input and Multiple Output
min	minimum
MRA	Mutual Recognition Agreement
N/A	Not Applicable
PCB	Printed Circuit Board
PDF	Portable Document Format
Pt-mpt	Point-to-multipoint
Pt-pt	Point-to-point
RF	Radio Frequency
RH	Relative Humidity
RMS	Root Mean Square
Rx	receiver
s	second
SVSWR	Site Voltage Standing Wave Ratio
Tx	transmitter
UKAS	United Kingdom Accreditation Service
V	volt
W	watt
Ω	ohm

7 Equipment Under Test

7.1 EUT Identification

- Name: Raspberry Pi 3
- Serial Number: Prototype
- Model Number: Model B
- Software Revision: V4.1
- Build Level / Revision Number: V1.2

7.2 System Equipment

Equipment listed below forms part of the overall test setup and is required for equipment functionality and/or monitoring during testing. The compliance levels achieved in this report relate only to the EUT and not items given in the following list.

Not Applicable – No support/monitoring equipment required.

7.3 EUT Mode of Operation

7.3.1 Transmission

The mode of operation for Tx tests was as follows:

Testing was performed with the EUT continuously transmitting in GFSK and 8PSK modes, at the “DH5” data rate. Test levels were set using the “compliance_app.sh” script, the test scripts used during the assessment are on file at Element.

7.3.2 Reception

The mode of operation for Rx tests was as follows:

Testing was performed with the EUT in receive mode according to the “compliance_app.sh” script.

7.4 EUT Radio Parameters

7.4.1 General

Frequency of operation:	2400 to 2483.5 MHz (channelized)
Modulation type(s):	GFSK / 8PSK
Occupied channel bandwidth(s):	1 MHz
Channel spacing:	1 MHz
ITU emission designator(s):	1MF1D / 1MG1D
Declared output power(s):	8 dBm
Warning against use of alternative antennas in user manual (yes/no):	N/A (PCB mounted chip antenna)
Nominal Supply Voltage:	5Vdc (via USB power supply)
Location of notice for license exempt use:	Label / user manual / both.
Method of prevention of use on non-US / non-Canadian frequencies:	N/A (2.4 GHz operation only)

7.4.2 Antennas

Type:	AEL - A2450M000000S007
Frequency range:	2400 to 2500 MHz
Impedance:	50 Ω
SWR:	2.0 max.
Gain:	1.5 dBi max.
Polarisation:	Linear
Beam width:	Omni-directional
Connector type:	None
Length:	5.2 \pm 0.2 mm
Weight:	N/A
Environmental limits:	-40 to +85 °C / 55-75% RH
Mounting:	PCB mounted chip ceramic

7.4.3 Product specific declarations

Multiple antenna configuration(s), e.g. MIMO:	Single Antenna
Fixed pt-pt operations (yes/no):	No
Installation manual advice on pt-pt operational restrictions (yes/no):	N/A
Fixed pt-mpt operations (yes/no):	No
Simultaneous tx (yes/no):	

7.5 EUT Description

The EUT is a small, single board, computer with WiFi, Bluetooth and Bluetooth LE connectivity.

8 Modifications

No modifications were performed during this assessment.

9 EUT Test Setup

9.1 Block Diagram

The following diagram shows basic EUT interconnections with cable type and cable lengths identified:

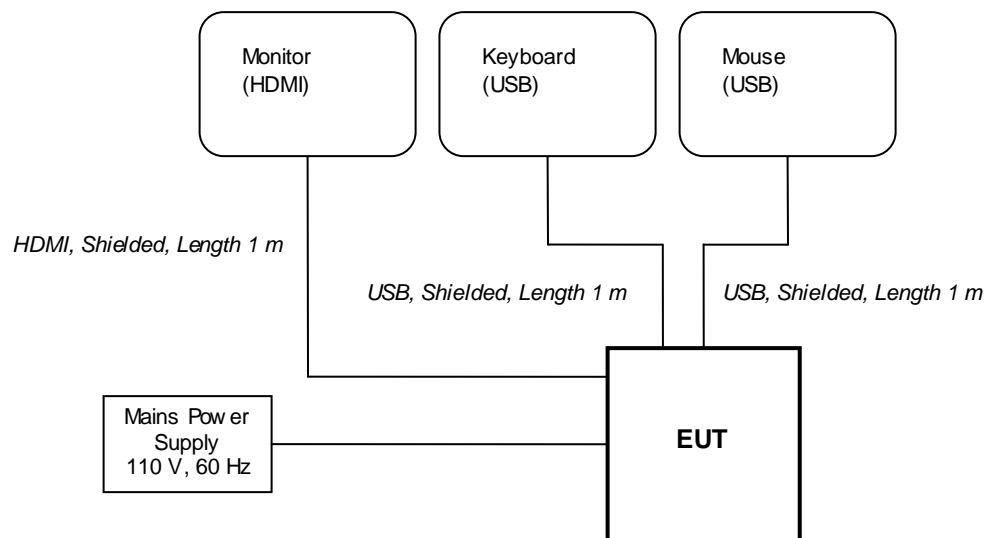

9.2 General Set-up Photograph

The following photograph shows basic EUT set-up:



10 General Technical Parameters

10.1 Normal Conditions

The E U T was tested under the normal environmental conditions of the test laboratory, except where otherwise stated. The normal power source applied was approx. 5 V dc from the adaptor / 110 V ac, 60 Hz, from the mains.

10.2 Varying Test Conditions

There are no specific frequency stability requirements for the type of device. The results contained in this report demonstrate that the occupied bandwidth is contained within the authorised band and the manufacturer has declared sufficient frequency stability (refer to section 7.4).

Variation of supply voltage is required to ensure stability of the declared output power. During carrier power testing the following variations were made:

	Category	Nominal	Variation
<input type="checkbox"/>	Mains	110 V ac +/-2 %	85 % and 115 %
<input type="checkbox"/>	Battery	New battery	N/A

11 Radiated emissions

11.1 Definitions

Spurious emissions

Emissions on a frequency or frequencies, which are outside the necessary bandwidth and the level of which may be reduced without affecting the corresponding transmission of information. Spurious emissions include harmonic emissions, parasitic emissions, intermodulation products and frequency conversion products, but exclude out-of-band emissions.

Restricted bands

A frequency band in which intentional radiators are permitted to radiate only spurious emissions but not fundamental signals.

11.2 Test Parameters

Test Location:	Element Hull
Test Chamber:	Lab 16 / Lab 10
Test Standard and Clause:	ANSI C63.10-2013, Clause 6.5 and 6.6
EUT Channels / Frequencies Measured:	Low / Mid / High
EUT Channel Bandwidths:	1 MHz
Deviations From Standard:	None
Measurement BW:	30 MHz to 1 GHz: 120 kHz Above 1 GHz: 1 MHz
Measurement Detector:	Up to 1 GHz: quasi-peak Above 1 GHz: RMS average and Peak

Environmental Conditions (Normal Environment)

Temperature: 19 °C	+15 °C to +35 °C (as declared)
Humidity: 55 % RH	20 % RH to 75 % RH (as declared)
Supply: 110 V ac	110 V ac \pm 10 % (as declared)

11.3 Test Limit

Unwanted emissions that fall within the restricted frequency bands shall comply with the limits specified:

General Field Strength Limits for License-Exempt Transmitters at Frequencies above 30 MHz

<i>Frequency (MHz)</i>	<i>Field Strength (μV/m at 3 m)</i>
30 to 88	100
88 to 216	150
216 to 960	200
Above 960	500

11.4 Test Method

With the EUT setup as per section 9 of this report and connected as per Figure i, the emissions from the EUT were measured on a spectrum analyzer / EMI receiver.

Radiated electromagnetic emissions from the EUT are checked first by preview scans. Preview scans for all spectrum and modulation characteristics are checked, using a peak detector and where applicable worst-case determined for function, operation, orientation, etc. for both vertical and horizontal polarisations. Pre-scan plots are shown with a peak detector and 100 kHz RBW.

If the EUT connects to auxiliary equipment and is table or floor standing, the configurations prescribed in ANSI C63.10 are followed. Alternatively, a layout closest to normal use (as declared by the provider) is employed, (see EUT setup photographs for more detail).

Emissions between 30 MHz and 1 GHz are measured using calibrated broadband antennas. Emissions above 1 GHz are characterized using standard gain horn antennas. Pre-amplifiers and filters are used where required. Care is taken to ensure that test receiver resolution bandwidth, video bandwidth and detector type(s) meet the regulatory requirements.

For both horizontal and vertical polarizations, the EUT is then rotated through 360 degrees in azimuth until the highest emission is detected. At the previously determined azimuth the test antenna is raised and lowered from 1 to 4 m in height until a maximum emission level is detected, this maximum value is recorded.

Power values measured on the test receiver / analyzer are converted to field strength, FS, in dB μ V/m at the regulatory distance, using:

$$FS = PR + CL + AF - PA + DC - CF$$

Where,

PR is the power recorded on the receiver / spectrum analyzer in dB μ V;
 CL is the cable loss in dB;
 AF is the test antenna factor in dB/m;
 PA is the pre-amplifier gain in dB (where used);
 DC is the duty correction factor in dB (where used, e.g. harmonics of pulsed fundamental);
 CF is the distance factor in dB (where measurement distance different to limit distance);

This field strength value is then compared with the regulatory limit.

Figure i Test Setup

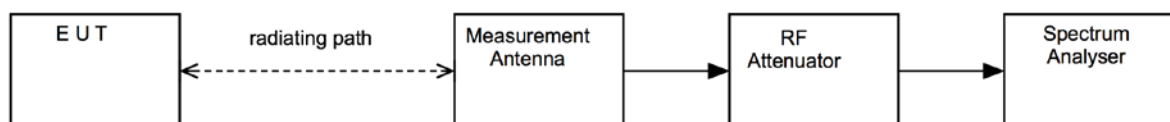

11.5 Test Set-up Photograph

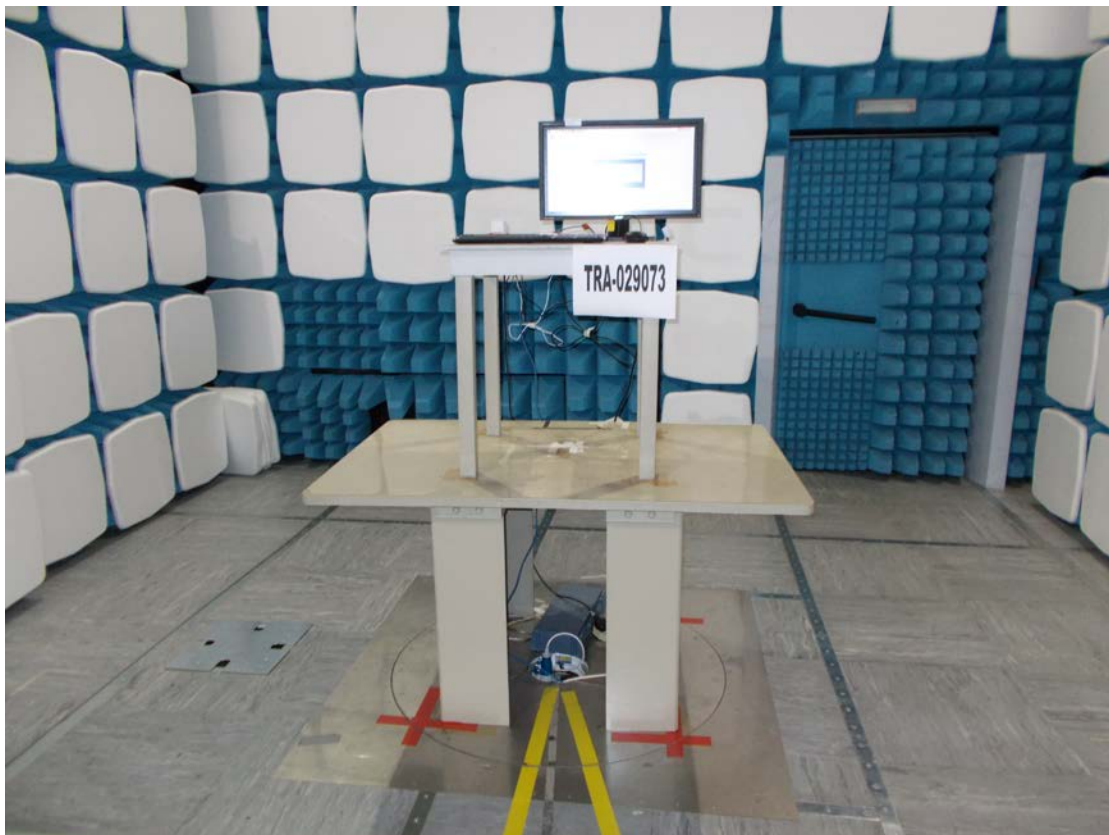



11.6 Test Equipment

Equipment Type	Manufacturer	Equipment Description	Element No	Due For Calibration	Calibration Interval (m)
ATS	Rainford	Ferrite Lined Chamber	REF886	21/07/2016	12
FSU46	R&S	Spectrum Analyser	REF910	28/05/2016	12
310	Sonoma	Pre-Amp (9kHz – 1GHz)	REF927	01/07/2016	12
8449B	Agilent	Pre-Amp (1 – 26.5GHz)	REF913	05/02/2016	12
3109	EMCO	Biconical Antenna	RFG095	09/05/2016	24
3146	EMCO	Log Periodic Antenna	RFG191	09/05/2016	24
3115	EMCO	Horn Antenna	RFG129	05/02/2016	24
	Q-Par	Horn Antenna	RFG629	30/09/2017	24
SN 4478	BSC	2.4 GHz Bandstop Filter	REF2158	Cal before use	N/A

11.7 Test Results

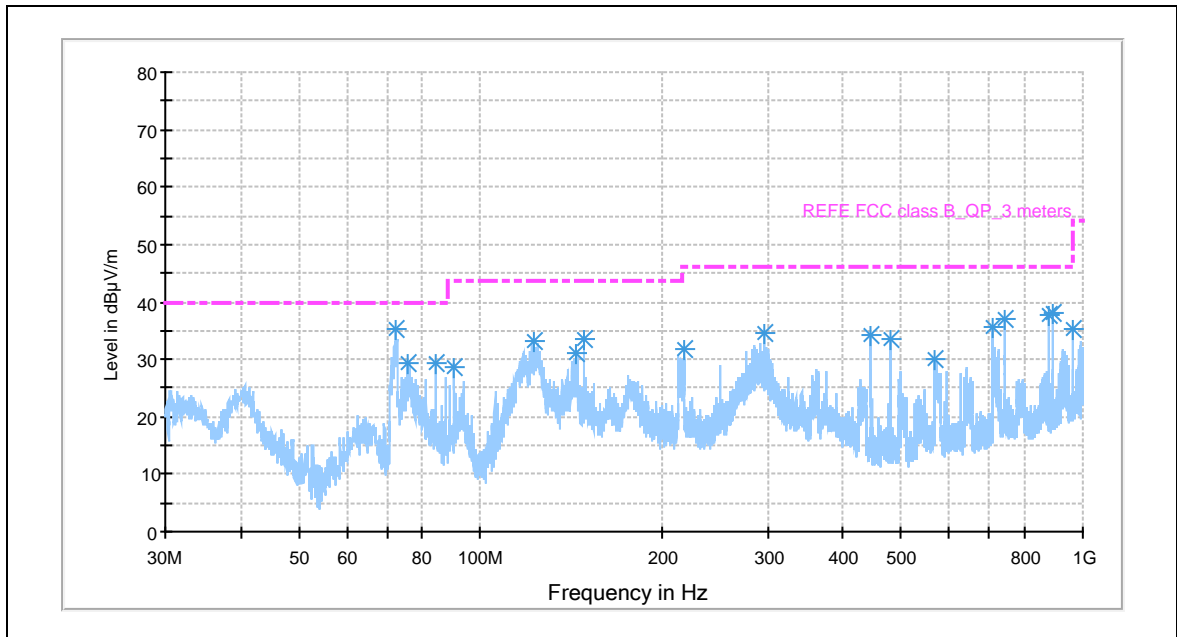

Bluetooth DH5 GFSK Channel 0 : 30 MHz to 1 GHz

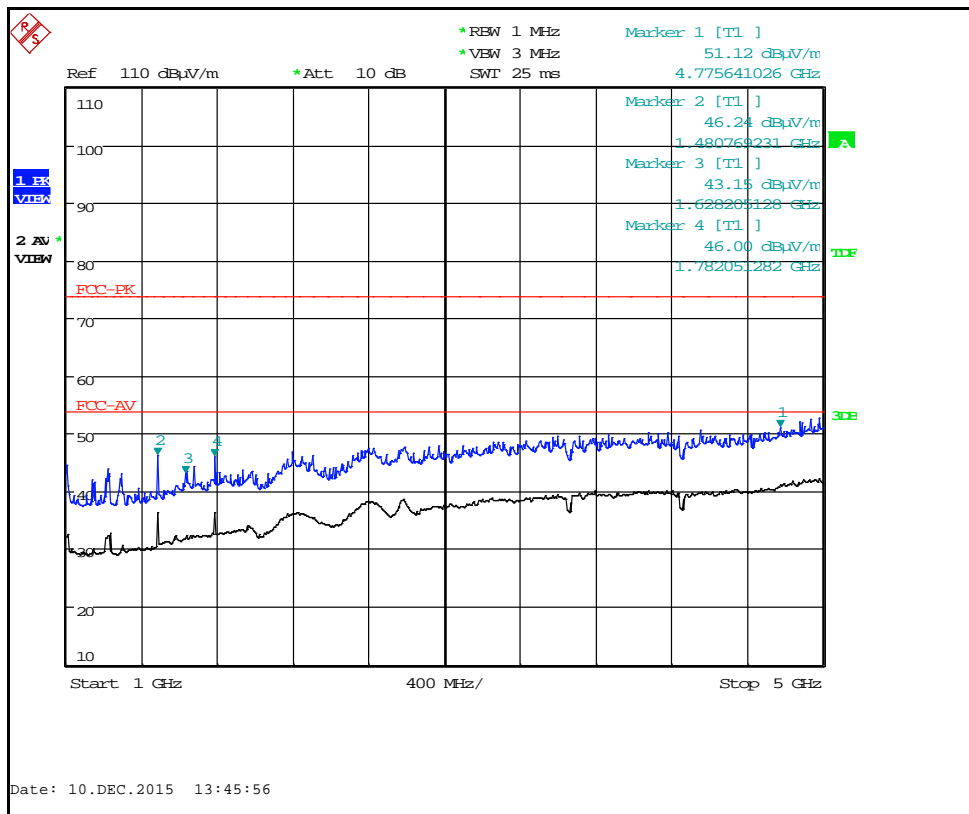

Bluetooth DH5 GFSK Channel 0 : 1 GHz to 5 GHz

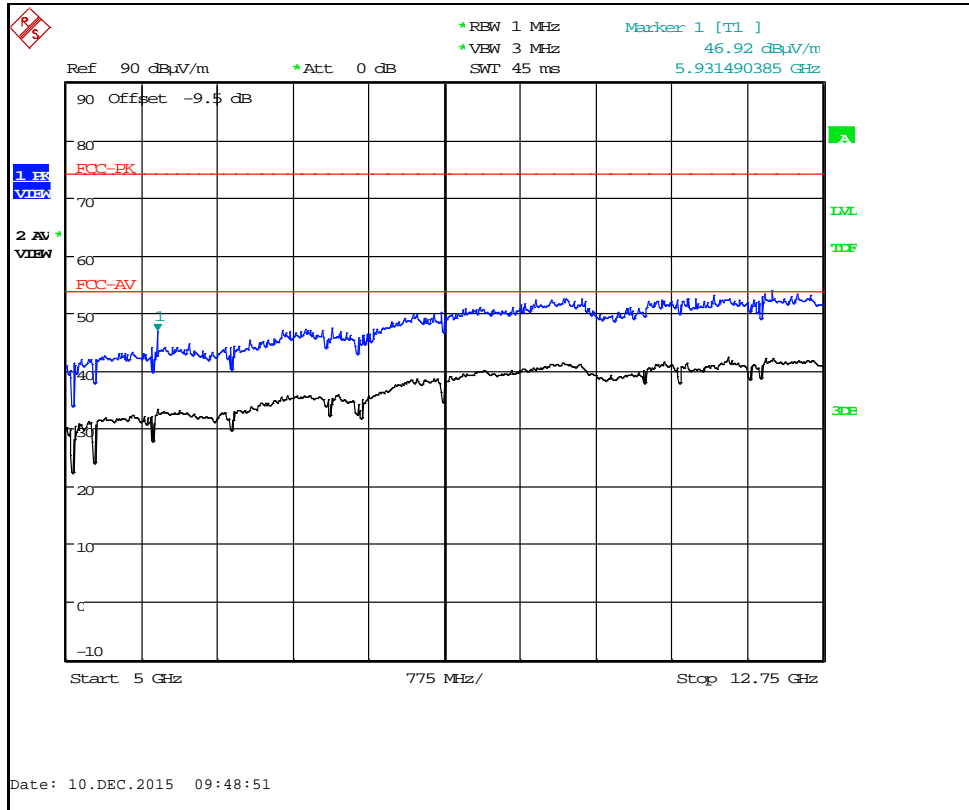

Bluetooth DH5 GFSK Channel 0 : 5 GHz to 12.75 GHz

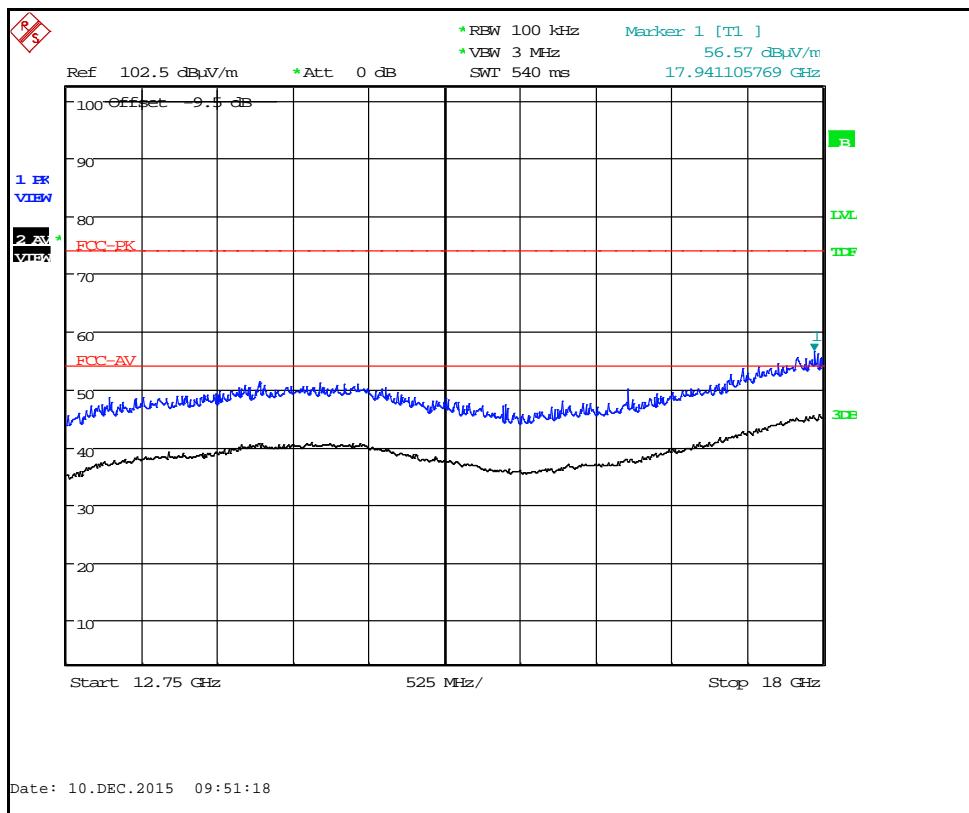

Bluetooth DH5 GFSK Channel 0 : 12.75 GHz to 18 GHz

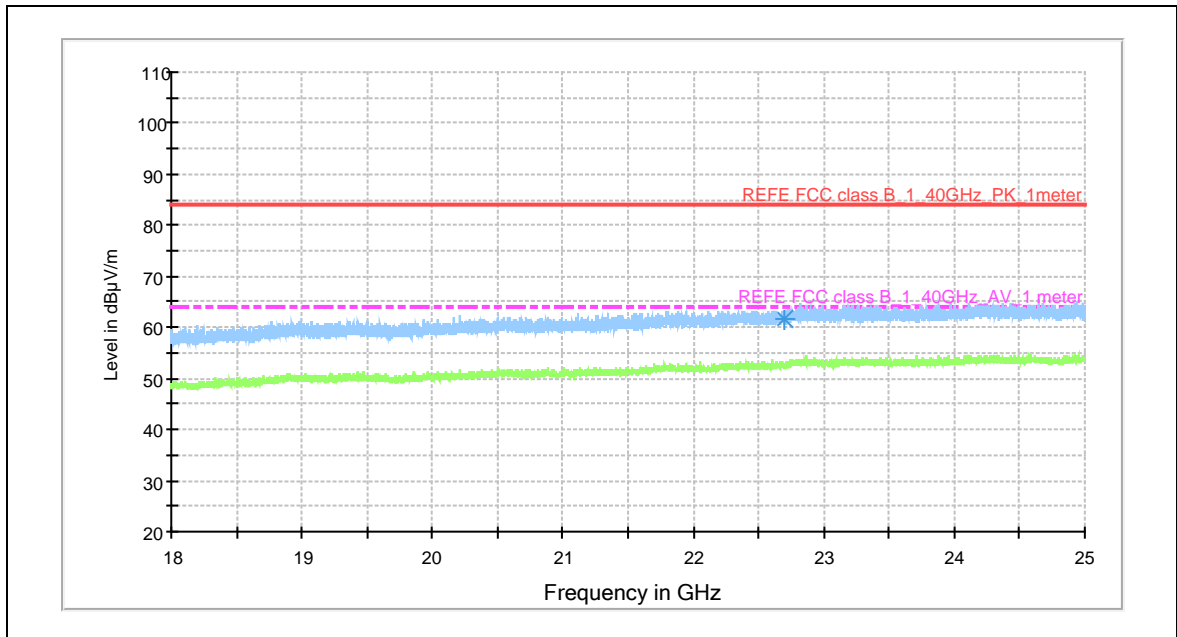

Bluetooth DH5 GFSK Channel 0 : 18 GHz to 25 GHz

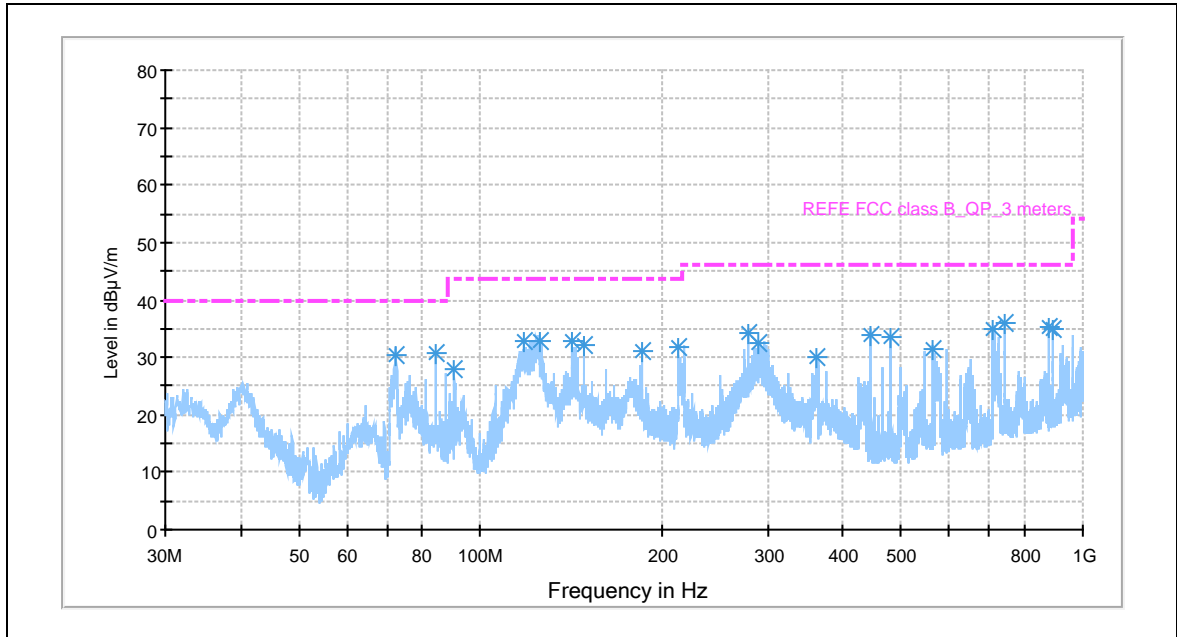

Bluetooth DH5 GFSK Channel 38 : 30 MHz to 1 GHz

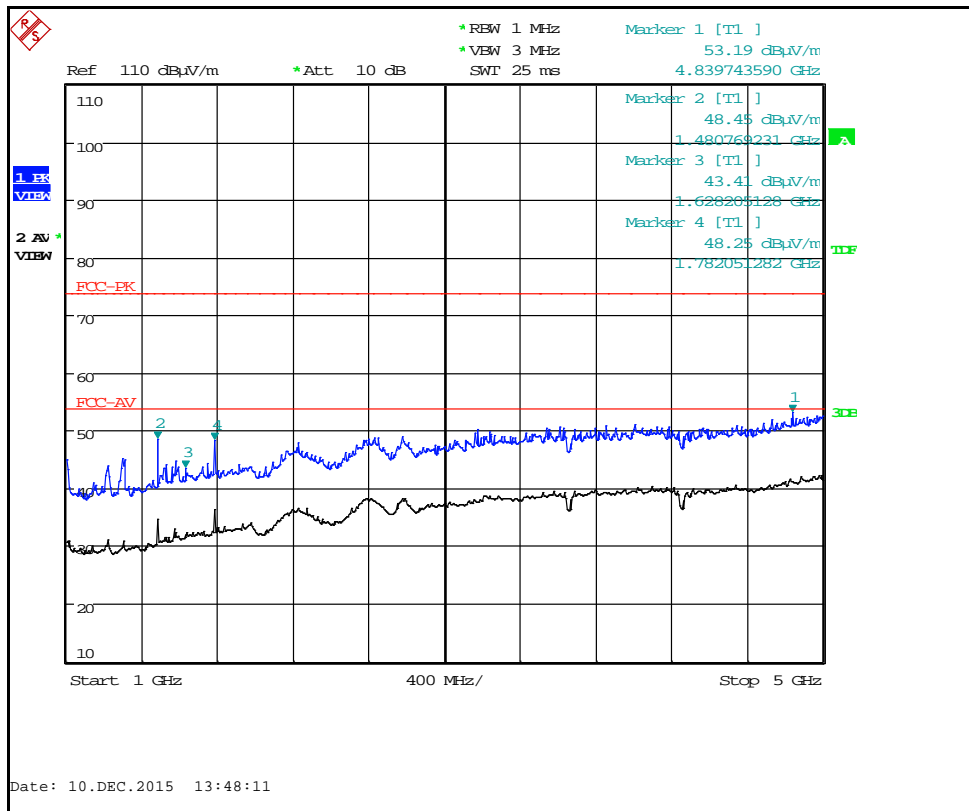

Bluetooth DH5 GFSK Channel 38 : 1 GHz to 5 GHz

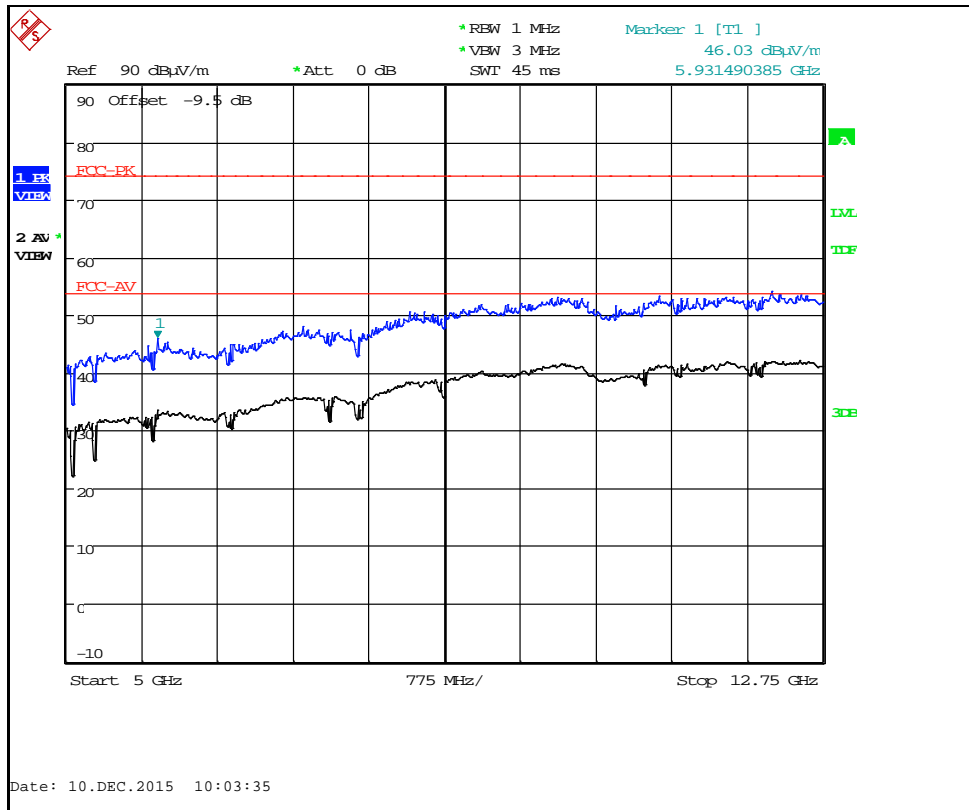

Bluetooth DH5 GFSK Channel 38 : 5 GHz to 12.75 GHz

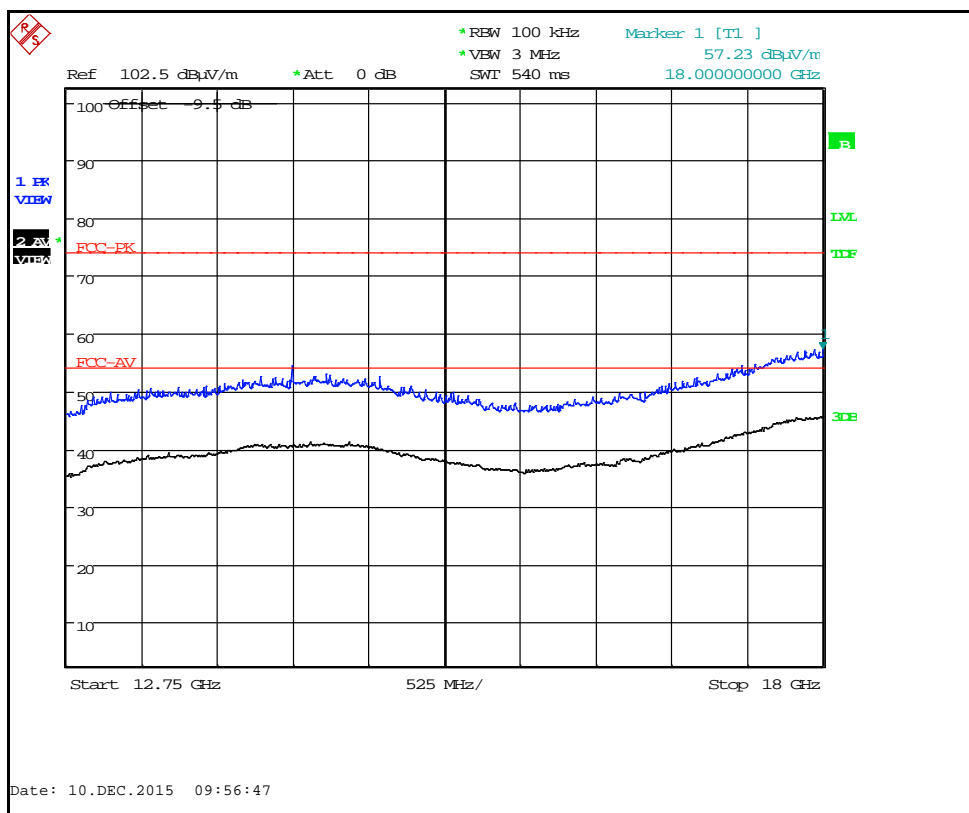

Bluetooth DH5 GFSK Channel 38 : 12.75 GHz to 18 GHz

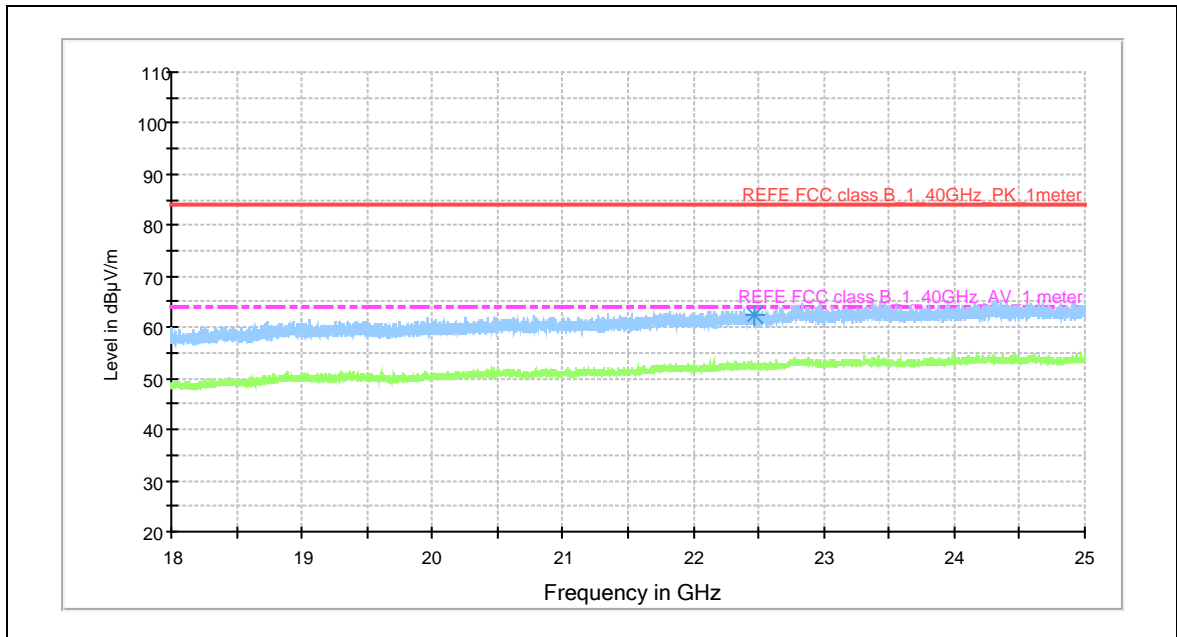

Bluetooth DH5 GFSK Channel 38 : 18 GHz to 25 GHz

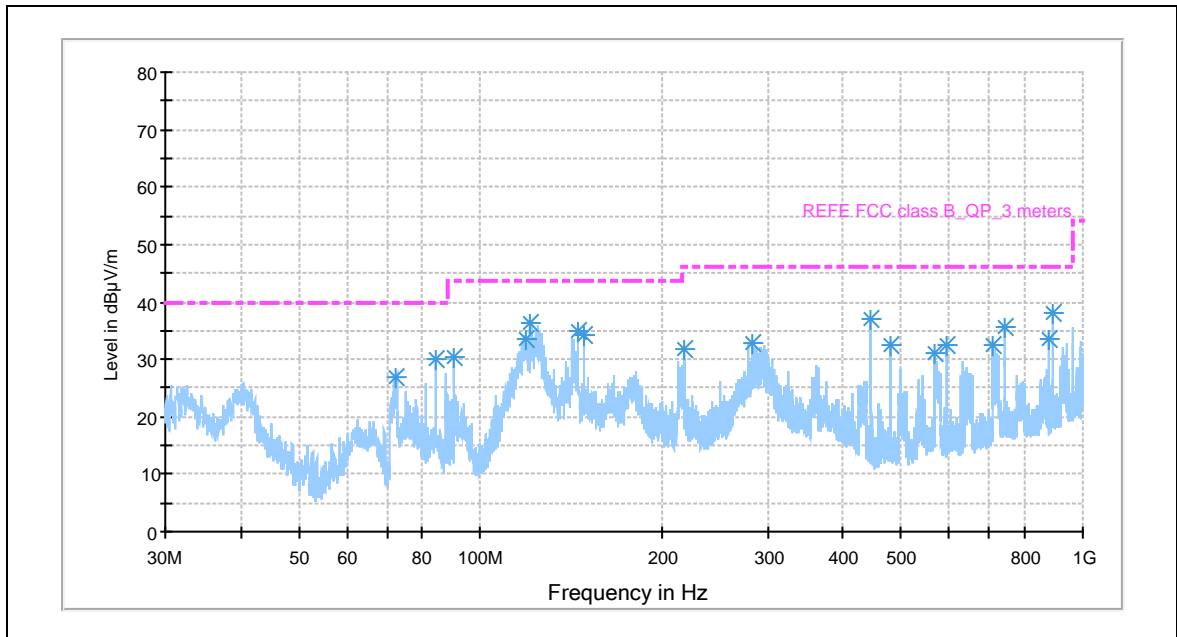

Bluetooth DH5 GFSK Channel 78 : 30 MHz to 1 GHz

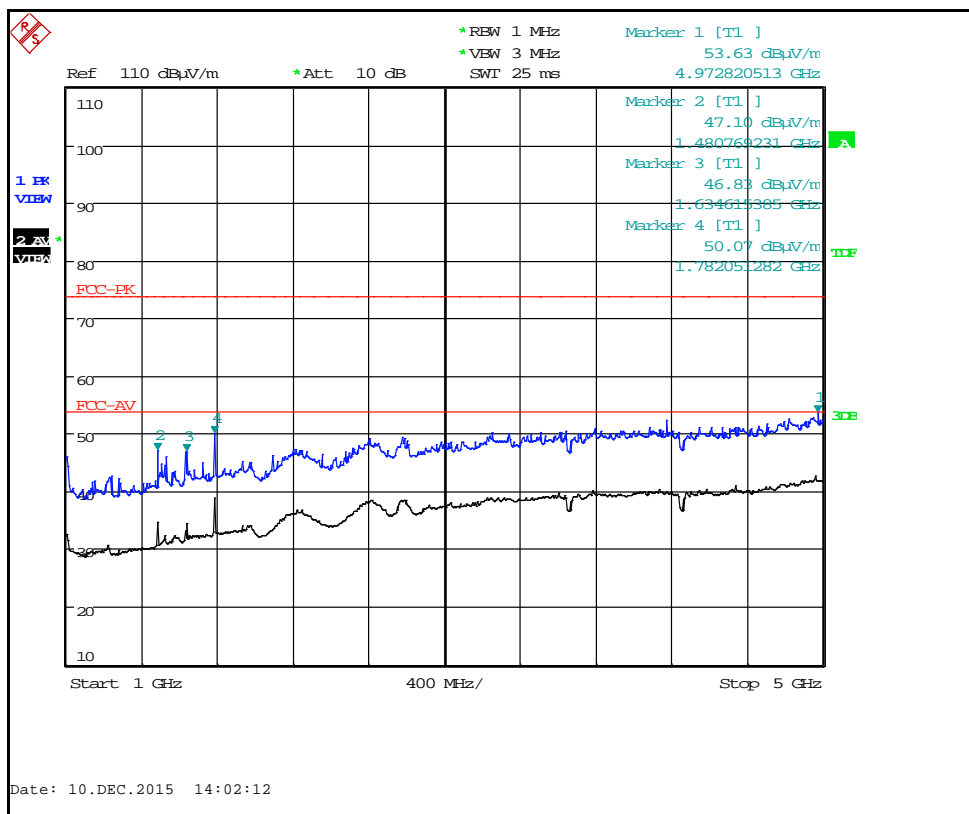

Bluetooth DH5 GFSK Channel 78 : 1 GHz to 5 GHz

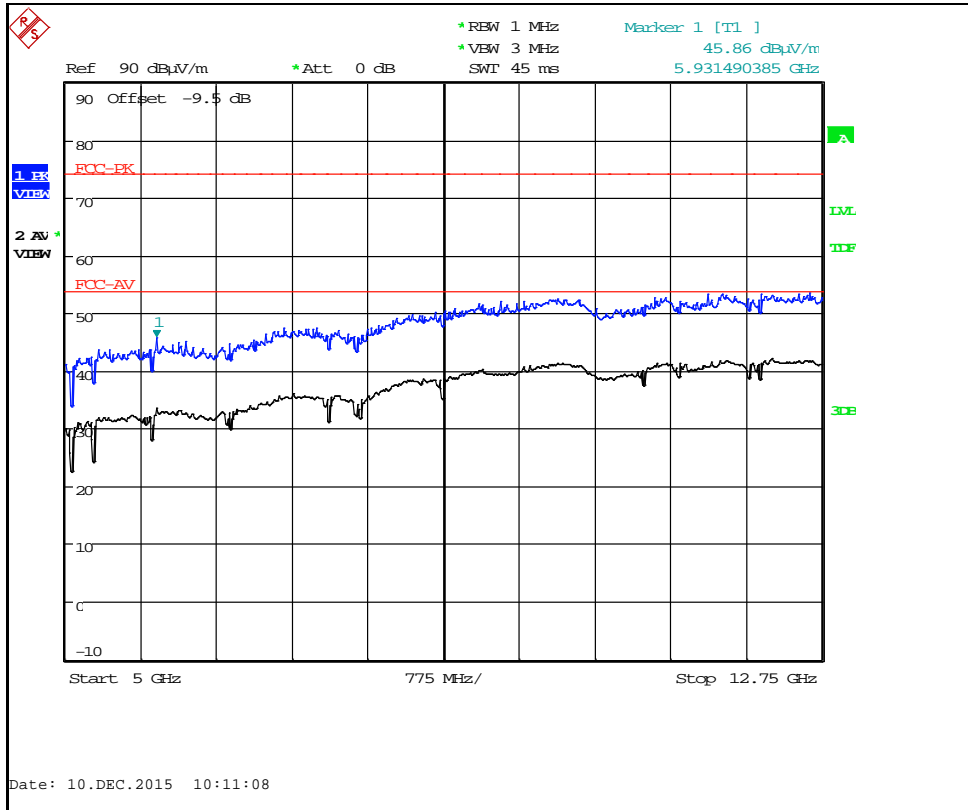

Bluetooth DH5 GFSK Channel 78 : 5 GHz to 12.75 GHz

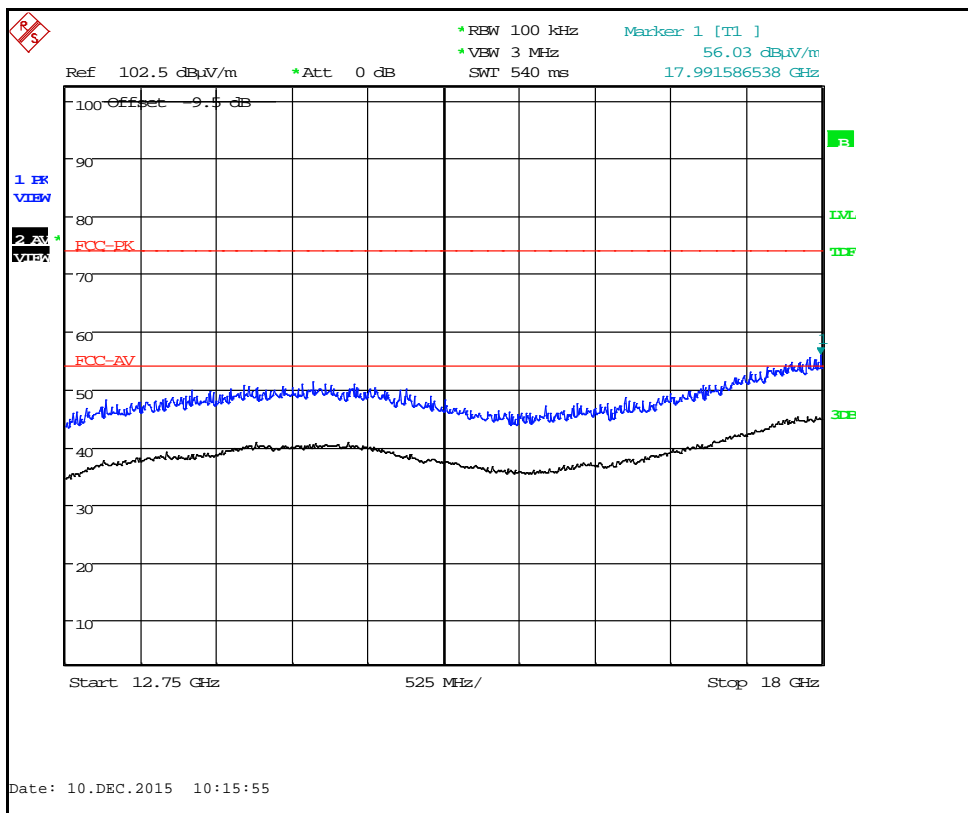

Bluetooth DH5 GFSK Channel 78 : 12.75 GHz to 18 GHz

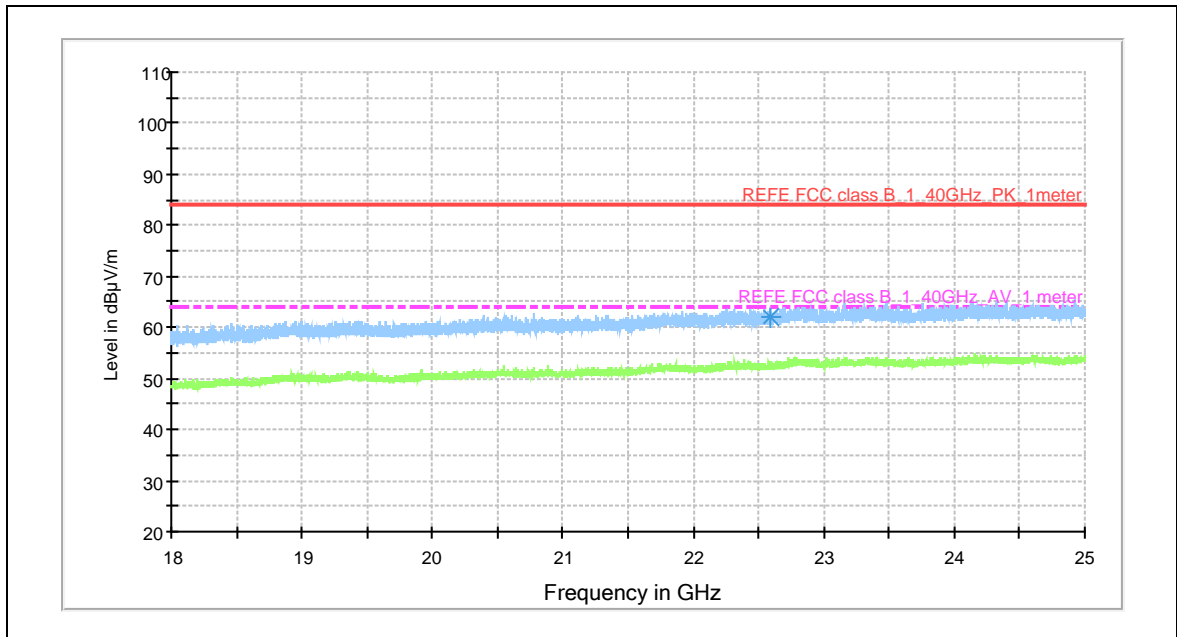

Bluetooth DH5 GFSK Channel 78 : 18 GHz to 25 GHz

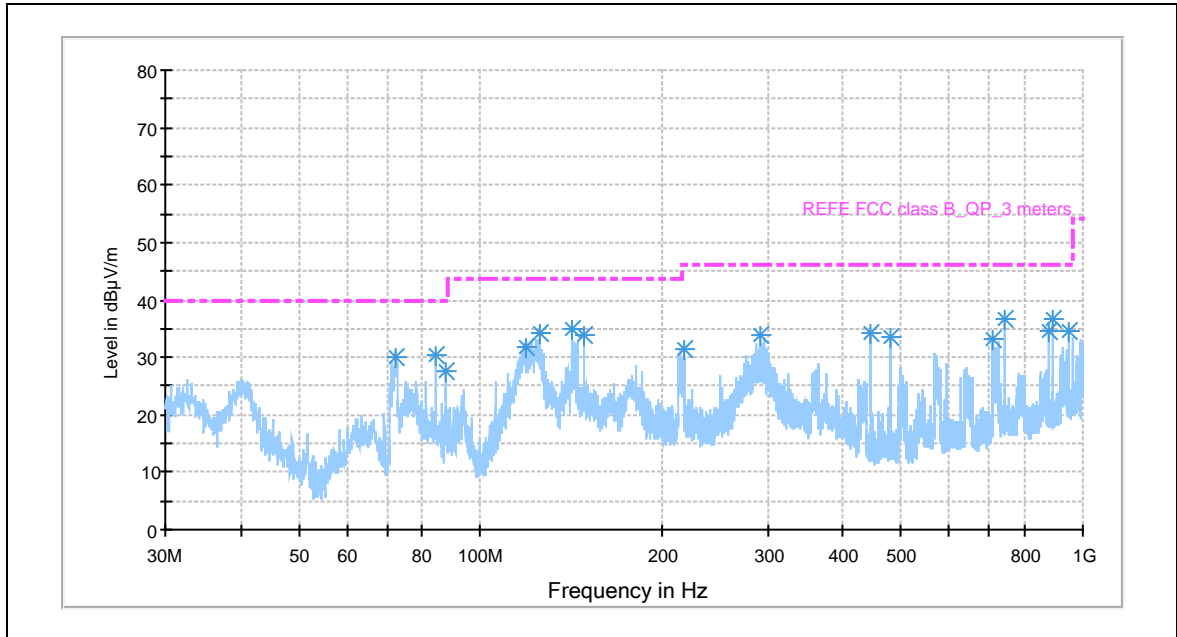

Bluetooth DH5 8PSK Channel 0 : 30 MHz to 1 GHz

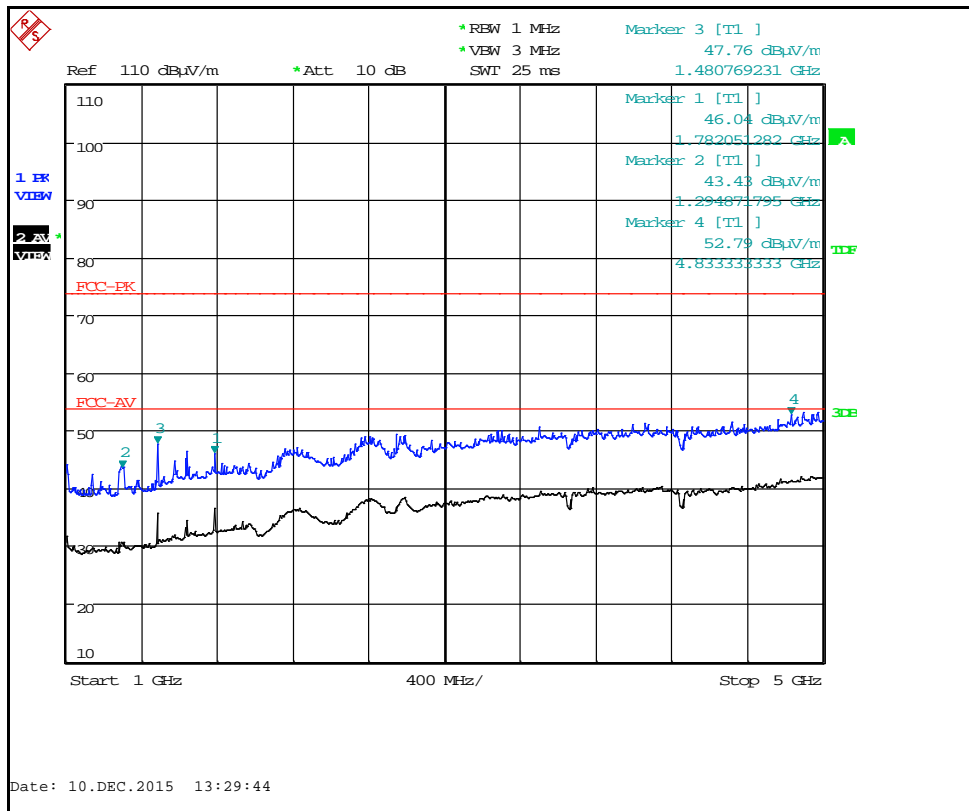

Bluetooth DH5 8PSK Channel 0 : 1 GHz to 5 GHz

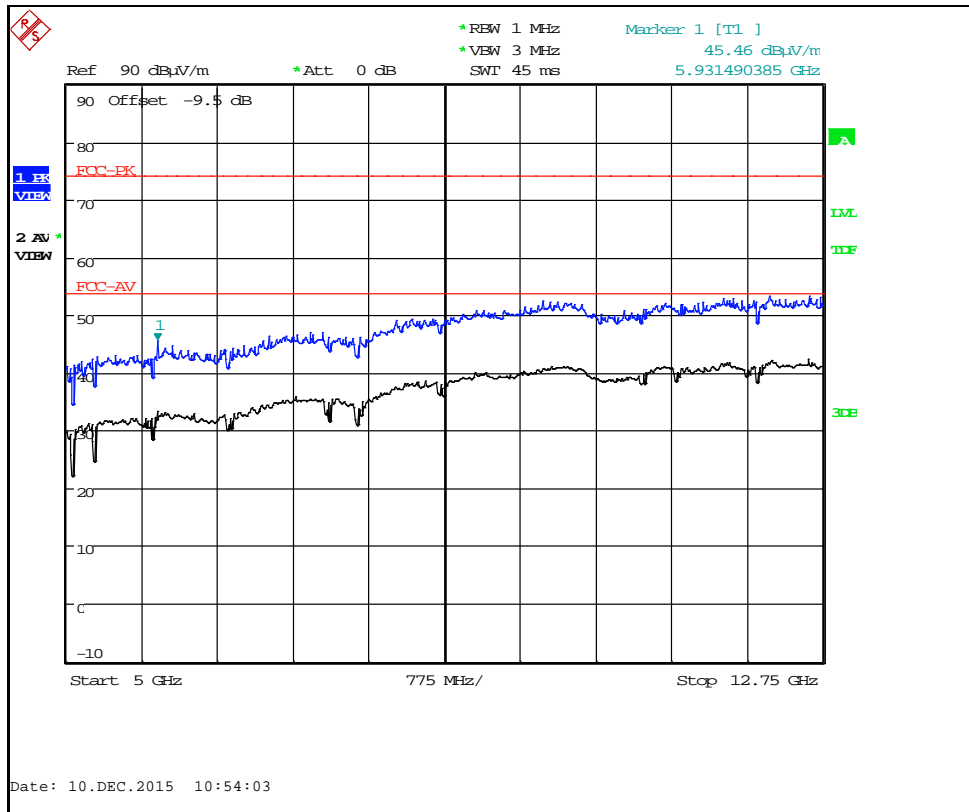

Bluetooth DH5 8PSK Channel 0 : 5 GHz to 12.75 GHz

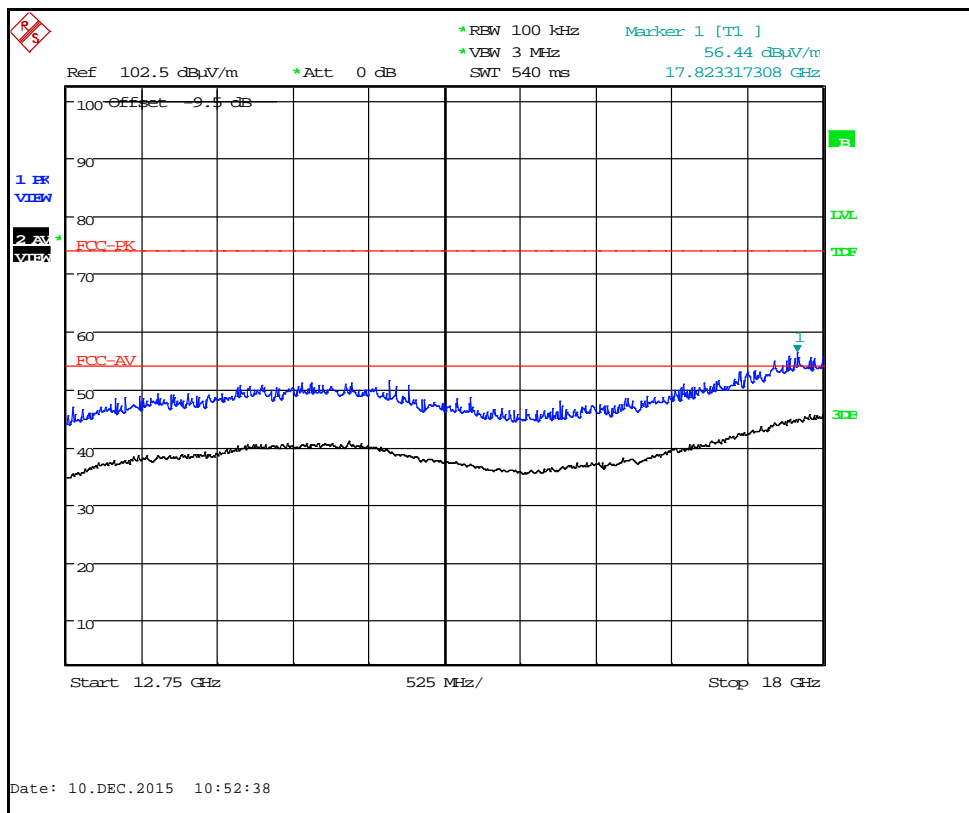

Bluetooth DH5 8PSK Channel 0 : 12.75 GHz to 18 GHz

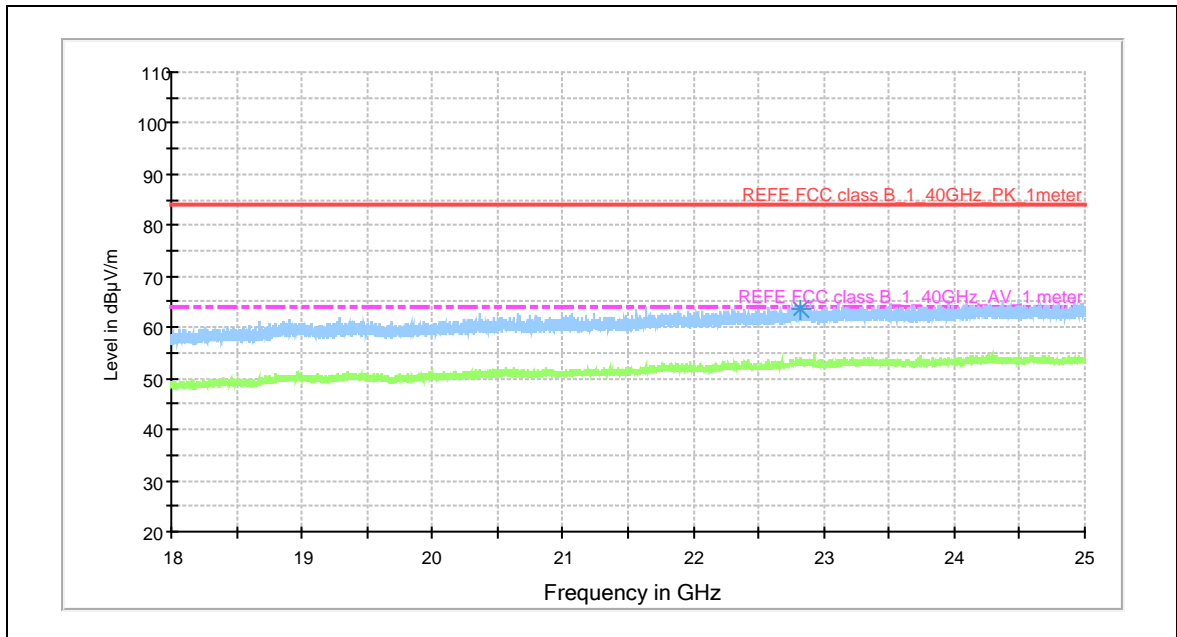

Bluetooth DH5 8PSK Channel 0 : 18 GHz to 25 GHz

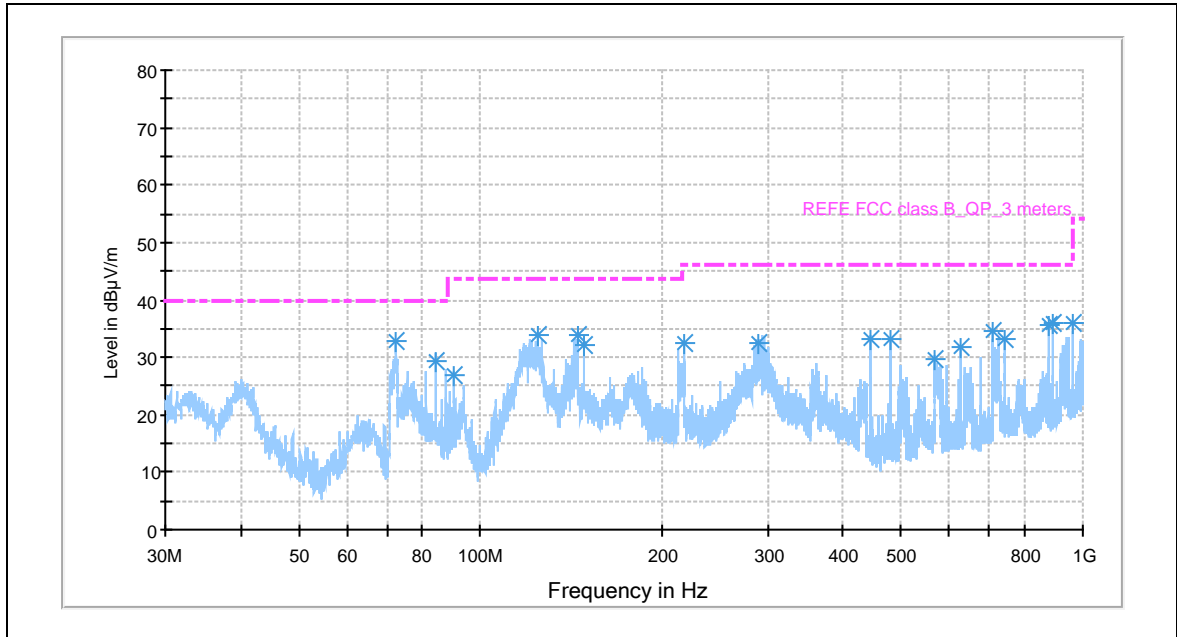

Bluetooth DH5 8PSK Channel 38 : 30 MHz to 1 GHz

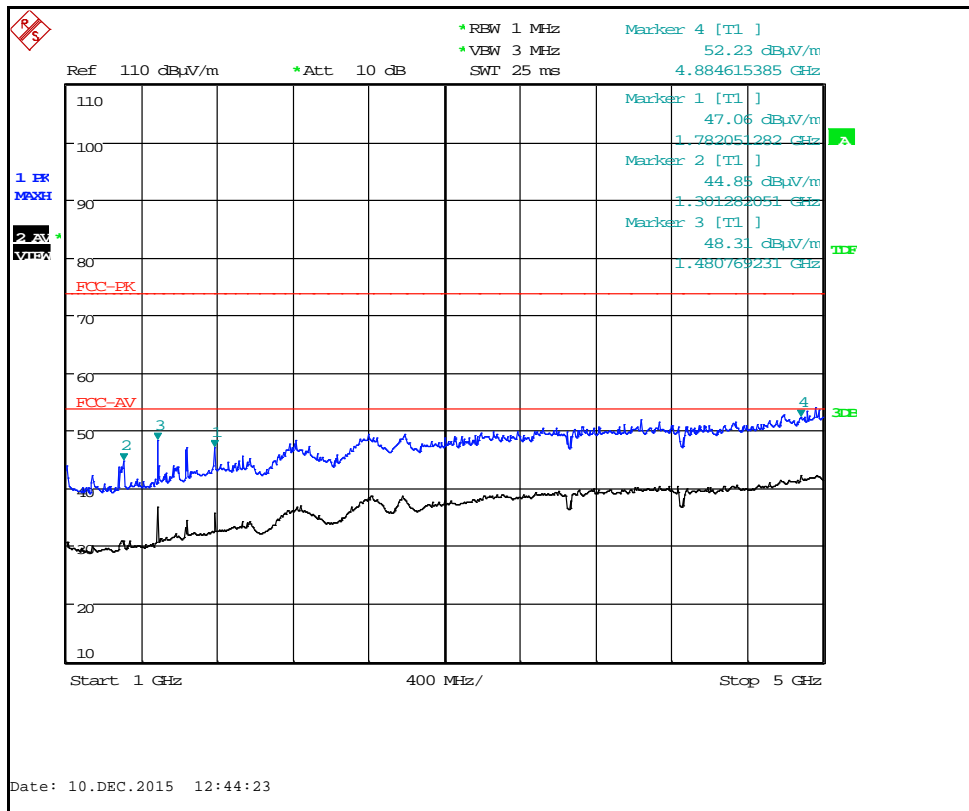

Bluetooth DH5 8PSK Channel 38 : 1 GHz to 5 GHz

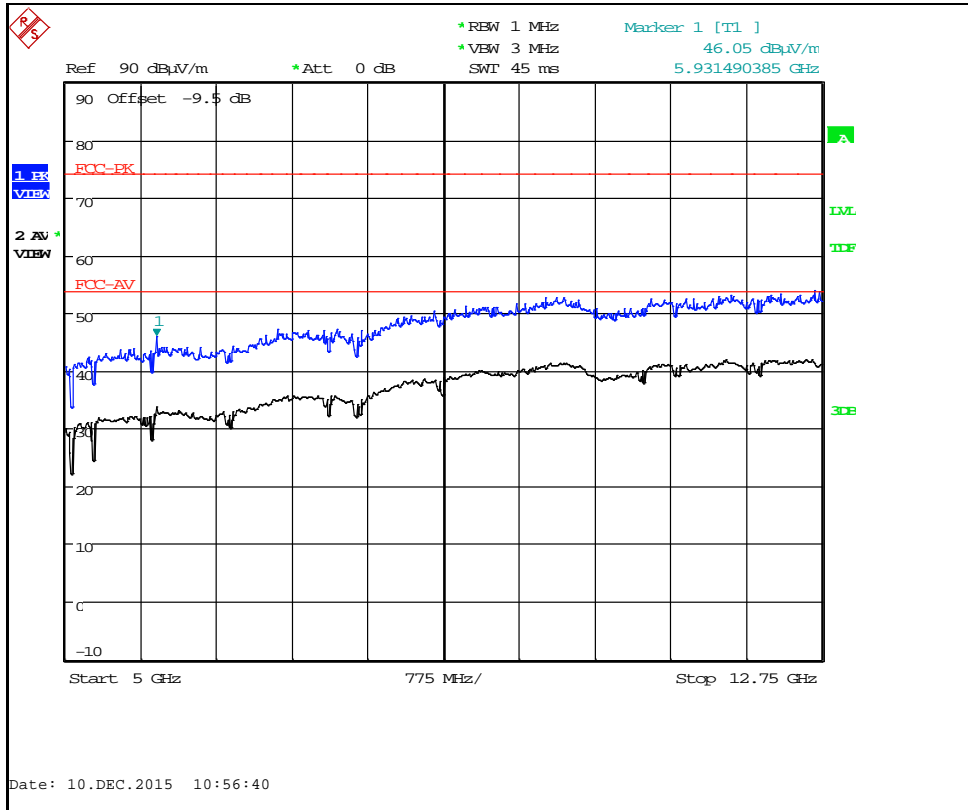

Bluetooth DH5 8PSK Channel 38 : 5 GHz to 12.75 GHz

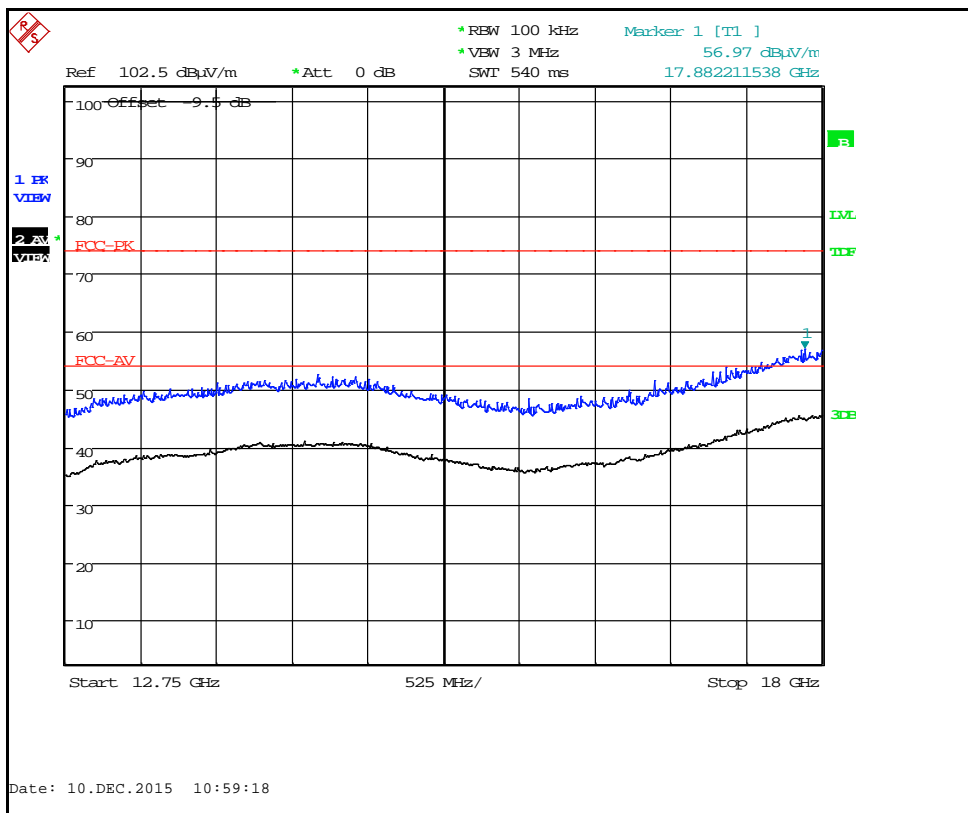

Bluetooth DH5 8PSK Channel 38 : 12.75 GHz to 18 GHz

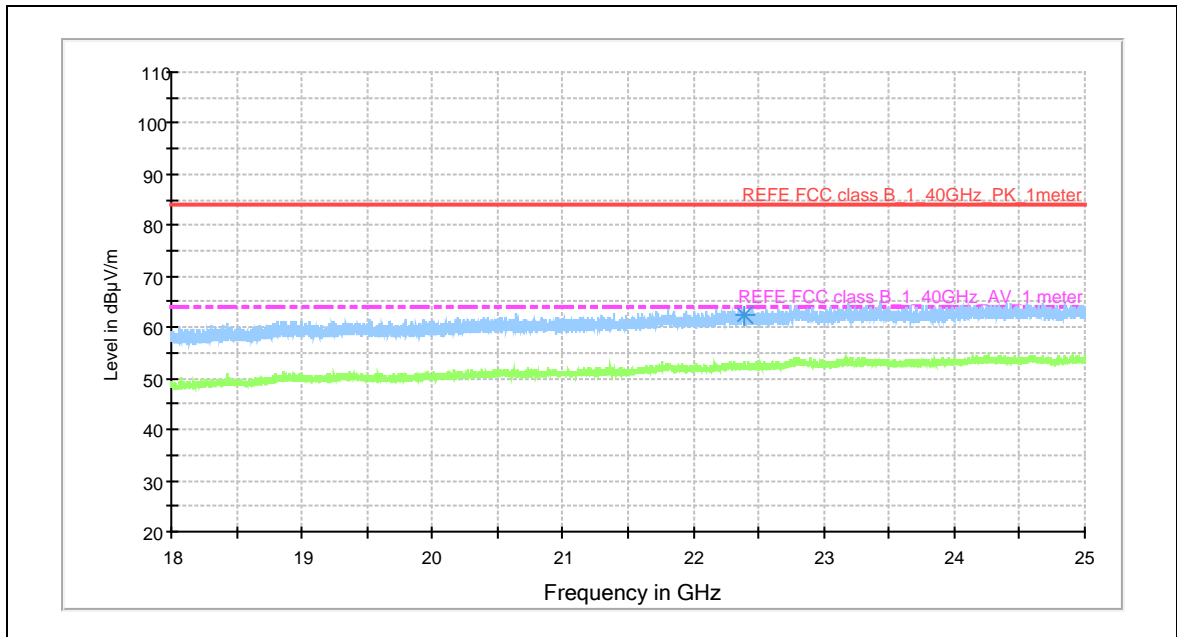

Bluetooth DH5 8PSK Channel 38 : 18 GHz to 25 GHz

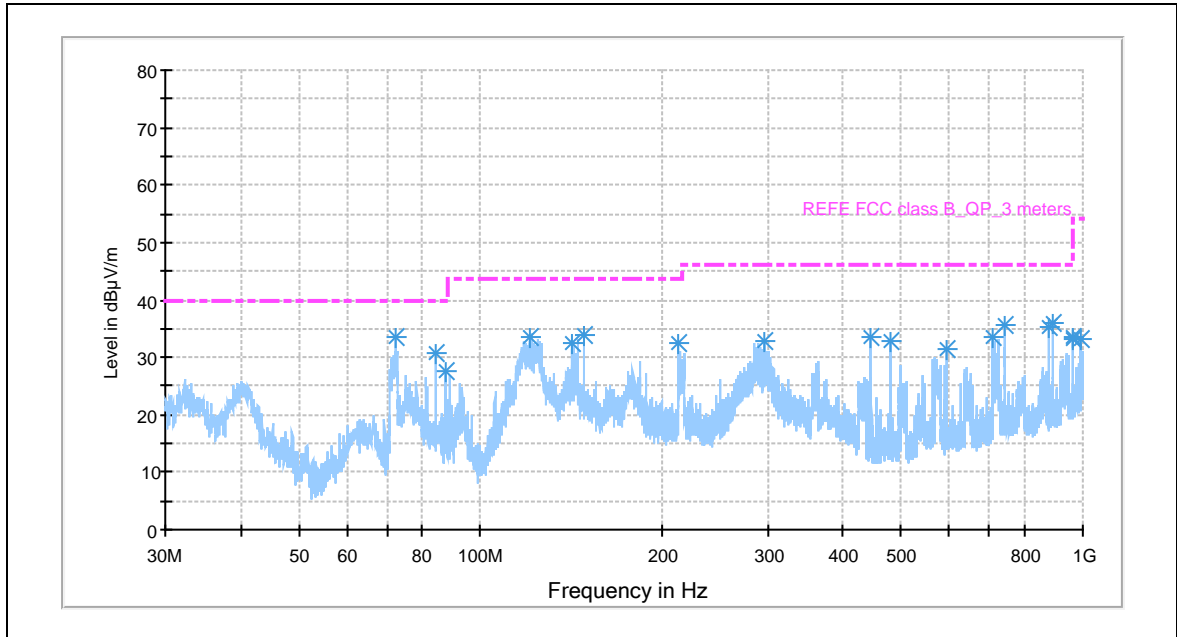

Bluetooth DH5 8PSK Channel 78 : 30 MHz to 1 GHz

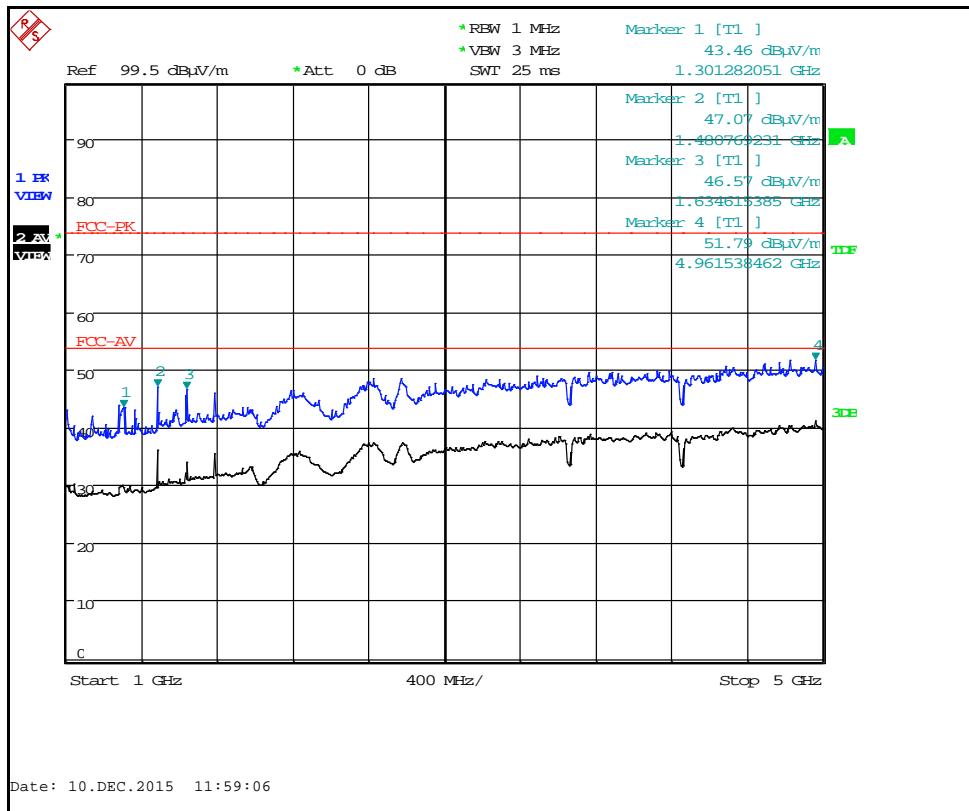

Bluetooth DH5 8PSK Channel 78 : 1 GHz to 5 GHz

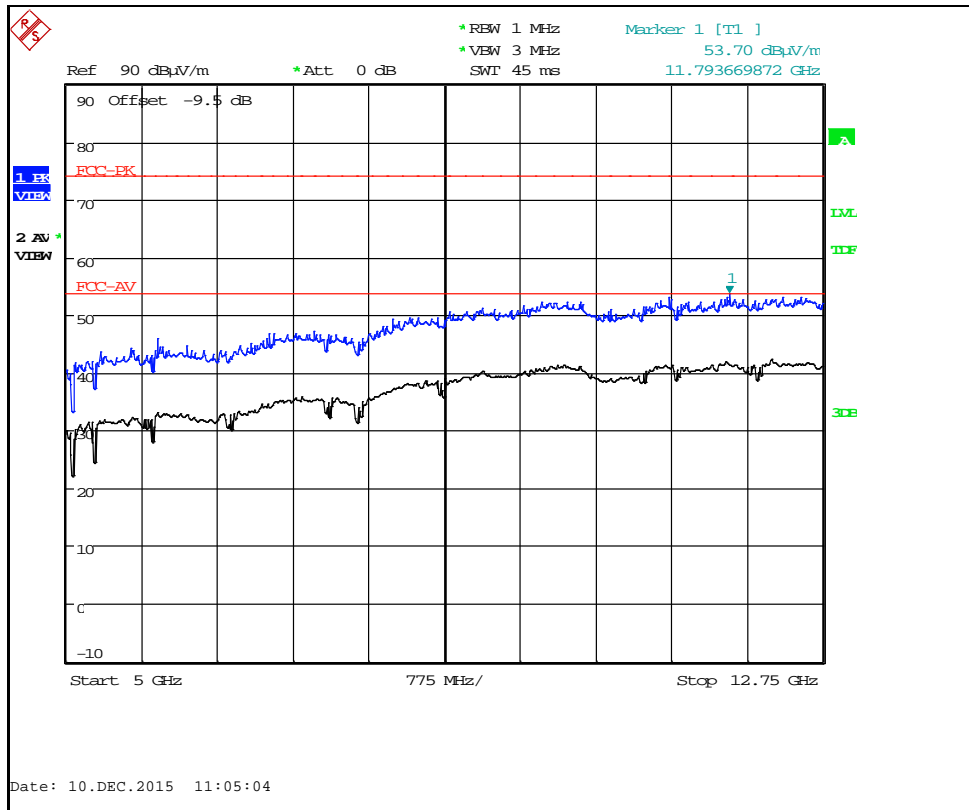

Bluetooth DH5 8PSK Channel 78 : 5 GHz to 12.75 GHz

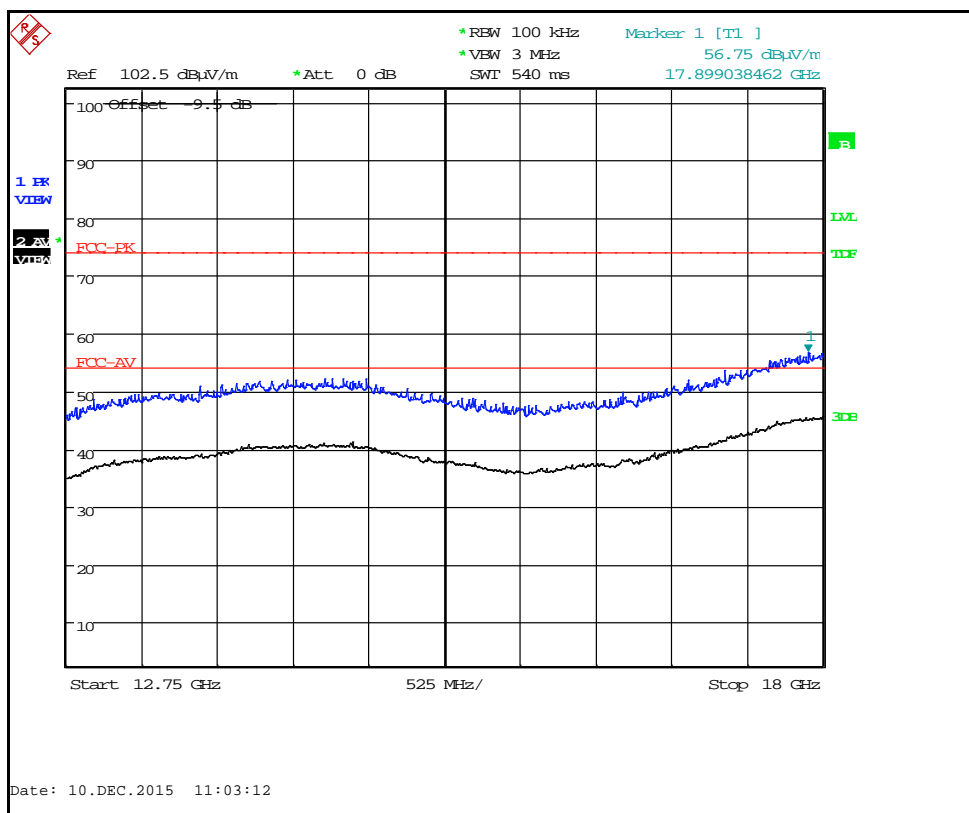

Bluetooth DH5 8PSK Channel 78 : 12.75 GHz to 18 GHz

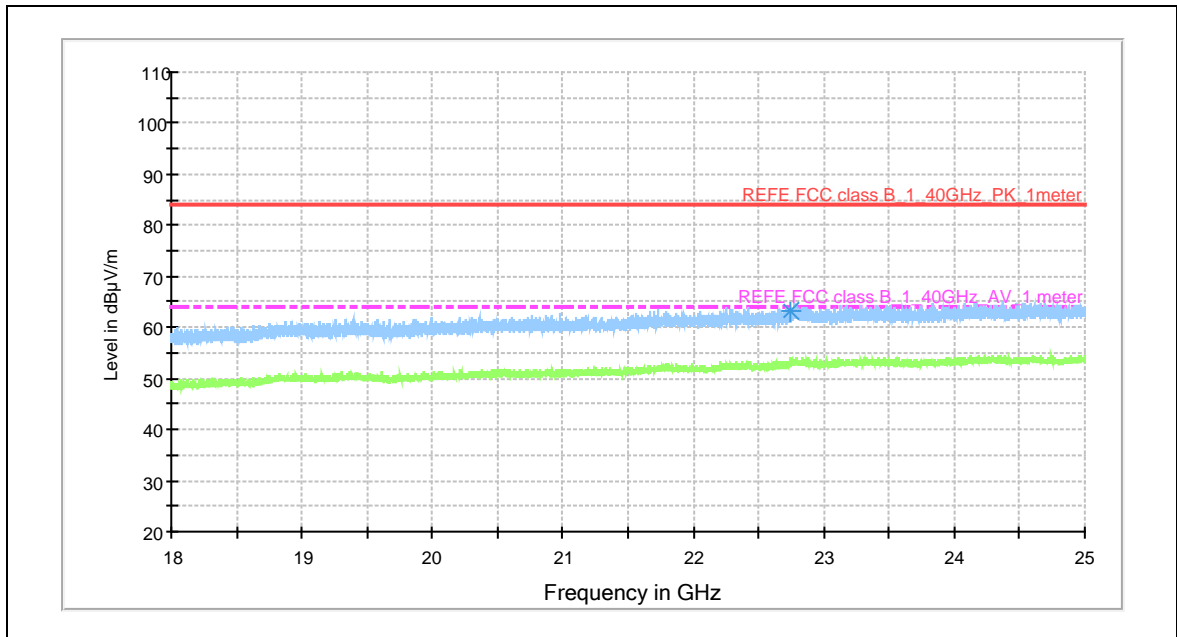

Bluetooth DH5 8PSK Channel 78 : 18 GHz to 25 GHz

Frequency (MHz)	QuasiPeak (dB μ V/m)	Meas. Time (ms)	Bandwidth (kHz)	Height (cm)	Polarization	Azimuth (deg)	Corr. (dB)	Margin (dB)	Limit (dB μ V/m)
40.561093	22.8	15000.0	120.000	101.0	V	266.0	-17.5	17.2	40.0
71.442560	32.5	15000.0	120.000	398.0	H	343.0	-24.0	7.5	40.0
72.379200	33.2	15000.0	120.000	410.0	H	146.0	-23.8	6.8	40.0
84.426120	29.8	15000.0	120.000	101.0	V	253.0	-22.0	10.2	40.0
87.749973	22.5	15000.0	120.000	214.0	V	280.0	-21.6	17.5	40.0
92.270187	26.0	15000.0	120.000	245.0	H	319.0	-21.1	17.6	43.5
93.741133	23.8	15000.0	120.000	235.0	H	-1.0	-20.8	19.7	43.5
118.952560	32.4	15000.0	120.000	103.0	V	104.0	-18.5	11.1	43.5
124.698080	36.3	15000.0	120.000	103.0	V	102.0	-18.3	7.2	43.5
144.685000	28.1	15000.0	120.000	103.0	V	49.0	-18.6	15.4	43.5
148.513493	33.6	15000.0	120.000	100.0	V	18.0	-18.8	9.9	43.5
213.509947	17.5	15000.0	120.000	103.0	V	114.0	-21.1	26.0	43.5
217.890613	18.9	15000.0	120.000	100.0	H	150.0	-20.7	27.1	46.0
276.748933	29.0	15000.0	120.000	144.0	H	132.0	-17.1	17.0	46.0
289.216933	27.3	15000.0	120.000	207.0	V	17.0	-16.9	18.7	46.0
445.490707	35.2	15000.0	120.000	100.0	H	341.0	-13.0	10.8	46.0
479.998293	33.4	15000.0	120.000	100.0	H	238.0	-12.1	12.6	46.0
567.570173	21.2	15000.0	120.000	189.0	H	97.0	-9.6	24.8	46.0
593.995853	32.0	15000.0	120.000	100.0	H	177.0	-10.0	14.0	46.0
713.304347	18.5	15000.0	120.000	100.0	H	174.0	-8.2	27.5	46.0
742.503987	37.4	15000.0	120.000	184.0	V	171.0	-6.9	8.6	46.0
781.738347	20.1	15000.0	120.000	140.0	H	107.0	-7.0	25.9	46.0
875.012227	38.1	15000.0	120.000	101.0	V	205.0	-5.8	7.9	46.0
891.004267	35.6	15000.0	120.000	296.0	H	217.0	-5.7	10.4	46.0
925.311067	23.2	15000.0	120.000	103.0	V	136.0	-4.1	22.8	46.0
944.987507	27.3	15000.0	120.000	140.0	V	146.0	-3.3	18.7	46.0
960.008640	32.7	15000.0	120.000	193.0	H	151.0	-3.3	21.3	54.0
992.528747	27.2	15000.0	120.000	101.0	V	143.0	-3.1	26.8	54.0

High Power; Channel: 2402 MHz										
Detector	Freq. (MHz)	Meas'd Emission (dB μ V)	Cable Loss (dB)	Antenna Factor (dB/m)	Pre-amp Gain (dB)	Duty Cycle Corr'n (dB)	Distance Extrap'n Factor (dB)	Field Strength (dB μ V/m)	Field Strength (μ V/m)	Limit (μ V/m)
Pk	1309.214	50.1	4	25.6	34.07	0	0	44.7	171.79	5000
Av	1309.214	34.832	4	25.6	34.07	0	0	29.4	29.51	500
Pk	1484.935	53.4	4.3	25.9	33.78	0	0	48.9	278.61	5000
Av	1484.935	45.032	4.3	25.9	33.78	0	0	40.5	105.93	500
Pk	2400.000	45.8	7.3	28.4	33.75	0	0	46.9	221.31	14289
Av	2400.000	32.3	7.3	28.4	33.75	0	0	33.4	46.77	14289
Pk	2358.429	45.7	7.1	28.3	33.74	0	0	46.5	211.35	5000
Av	2358.429	34.8	7.1	28.3	33.74	0	0	35.6	60.26	500
Pk	2327.628	52.4	6.9	28.2	33.74	0	0	52.9	441.57	5000
Av	2327.628	36.4	6.9	28.2	33.74	0	0	36.9	69.98	500
Pk	4804.302	45.8	8.7	32.9	34.04	0	0	52.7	431.52	5000
Av	4804.302	36.132	8.7	32.9	34.04	0	0	43.0	141.25	500

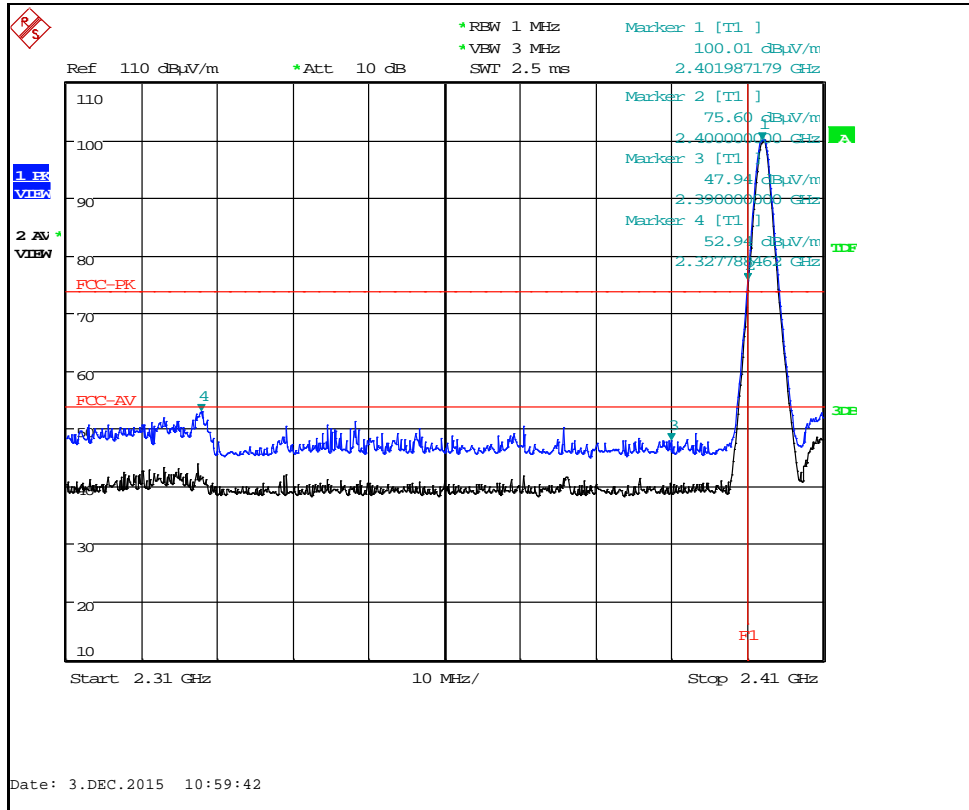

Bluetooth DH5 GFSK Channel 0 : Lower Band Edge

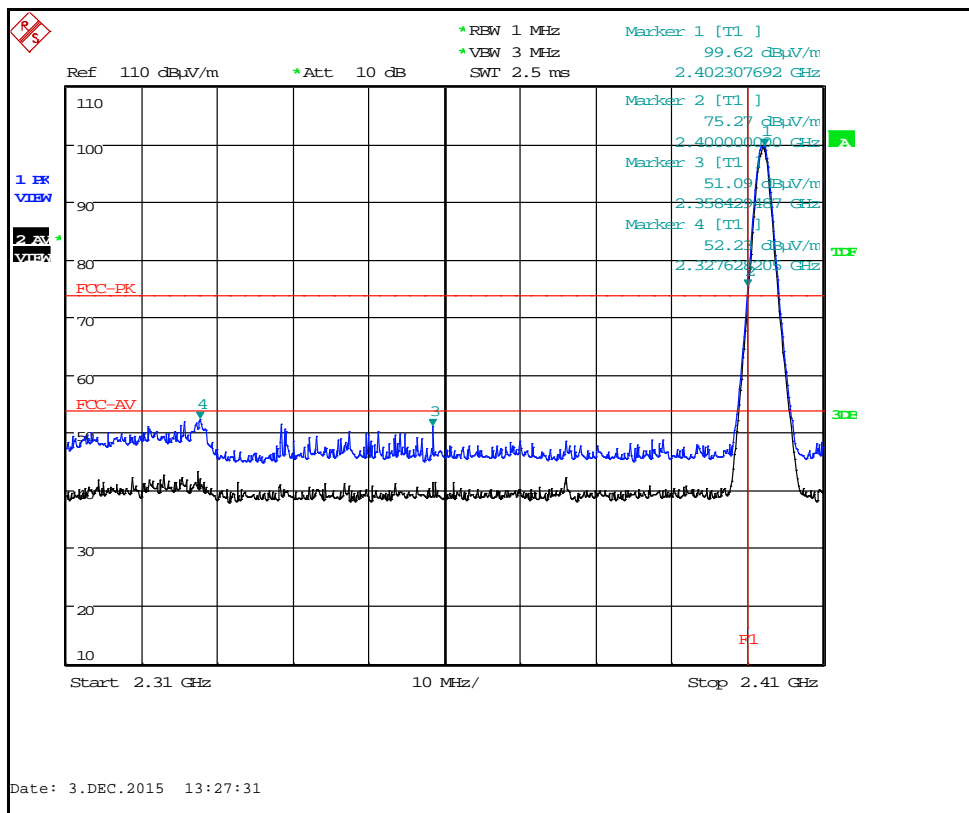

Bluetooth DH5 8PSK Channel 0 : Lower Band Edge

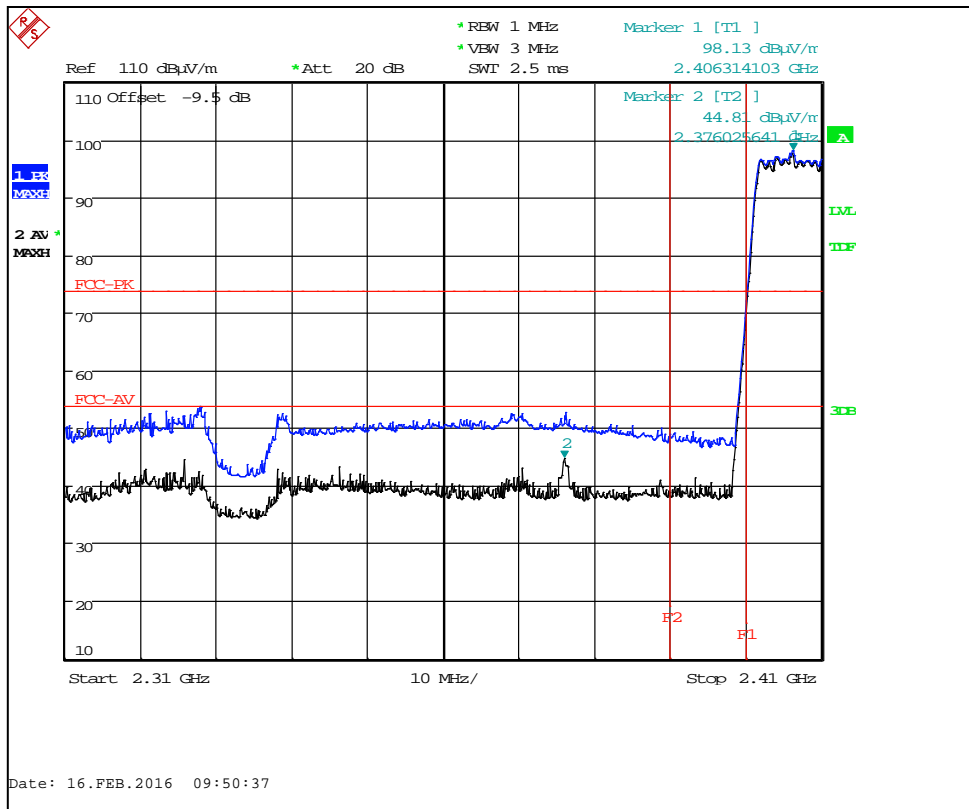

Bluetooth Hopping mode : Lower Band Edge

<i>High Power; Channel : 2440MHz</i>										
<i>Detector</i>	<i>Freq. (MHz)</i>	<i>Meas'd Emission (dBμV)</i>	<i>Cable Loss (dB)</i>	<i>Antenna Factor (dB/m)</i>	<i>Pre-amp Gain (dB)</i>	<i>Duty Cycle Corr'n (dB)</i>	<i>Distance Extrap'n Factor (dB)</i>	<i>Field Strength (dBμV/m)</i>	<i>Field Strength (μV/m)</i>	<i>Limit (μV/m)</i>
Pk	1309.214	49.69	4	25.6	34.07	0	0	44.3	164.06	74.0
Av	1309.214	35.332	4	25.6	34.07	0	0	29.9	31.26	54.0
Pk	1484.935	54.65	4.3	25.9	33.78	0	0	50.1	319.89	74.0
Av	1484.935	46.732	4.3	25.9	33.78	0	0	42.2	128.82	54.0
Pk	4879.583	45.88	8.6	33.2	34.06	0	0	53	446.68	74.0
Av	4879.583	37.732	8.6	33.2	34.06	0	0	44.8	173.78	54.0

<i>High Power; Channel : 2480MHz</i>										
<i>Detector</i>	<i>Freq. (MHz)</i>	<i>Meas'd Emission (dBμV)</i>	<i>Cable Loss (dB)</i>	<i>Antenna Factor (dB/m)</i>	<i>Pre-amp Gain (dB)</i>	<i>Duty Cycle Corr'n (dB)</i>	<i>Distance Extrap'n Factor (dB)</i>	<i>Field Strength (dBμV/m)</i>	<i>Field Strength (μV/m)</i>	<i>Limit (μV/m)</i>
Pk	1309.214	50.51	4	25.6	34.07	0	0	45.1	179.89	5000
Av	1309.214	35.012	4	25.6	34.07	0	0	29.6	30.20	500
Pk	1485.015	54.7	4.3	25.9	33.77	0	0	50.2	323.59	5000
Av	1485.015	46.472	4.3	25.9	33.77	0	0	41.9	124.45	500
Pk	1633.461	52	5	26.2	33.72	0	0	48.5	266.07	5000
Av	1633.461	48.832	5	26.2	33.72	0	0	45.4	186.21	500
Pk	2483.500	56.3	7.5	28.5	33.78	0	0	57.7	767.36	5000
Av	2483.500	50.7	7.5	28.5	33.78	0	0	52.1	402.72	500
Pk	2487.059	47.7	7.6	28.5	33.78	0	0	49.2	288.40	5000
Av	2487.059	35.5	7.6	28.5	33.78	0	0	37	70.79	500
Pk	4959.615	46.6	8.9	33.5	34.09	0	0	54.3	518.80	5000
Av	4959.615	37.632	8.9	33.5	34.09	0	0	45.4	186.21	500

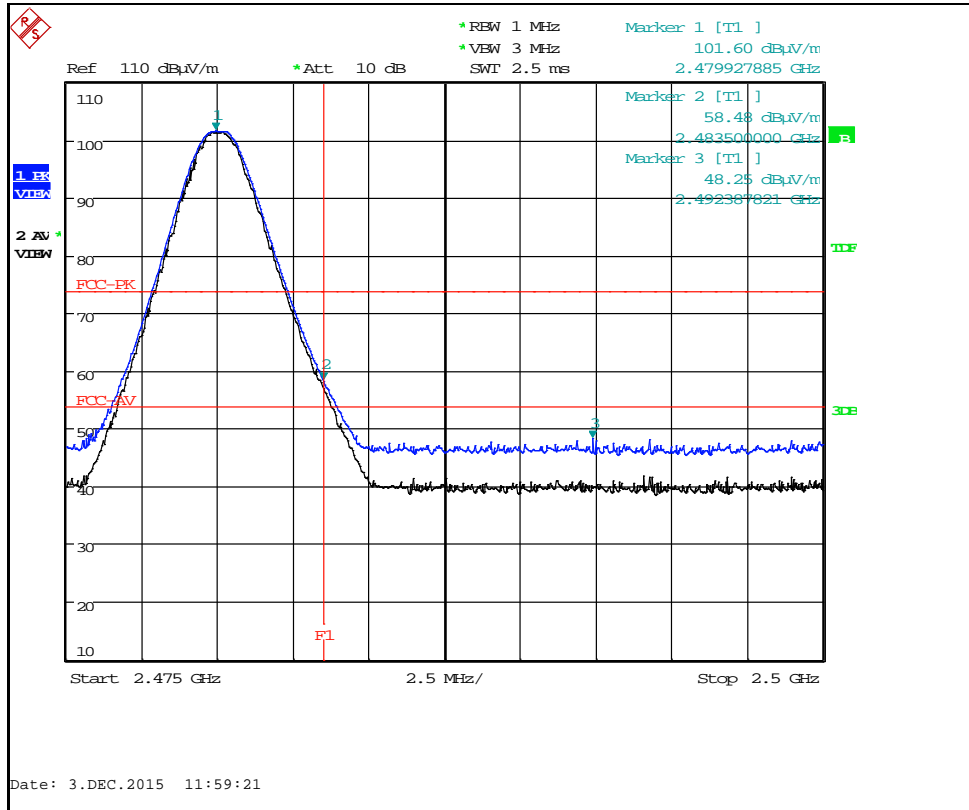

Bluetooth DH5 GFSK Channel 78 : Upper Band Edge

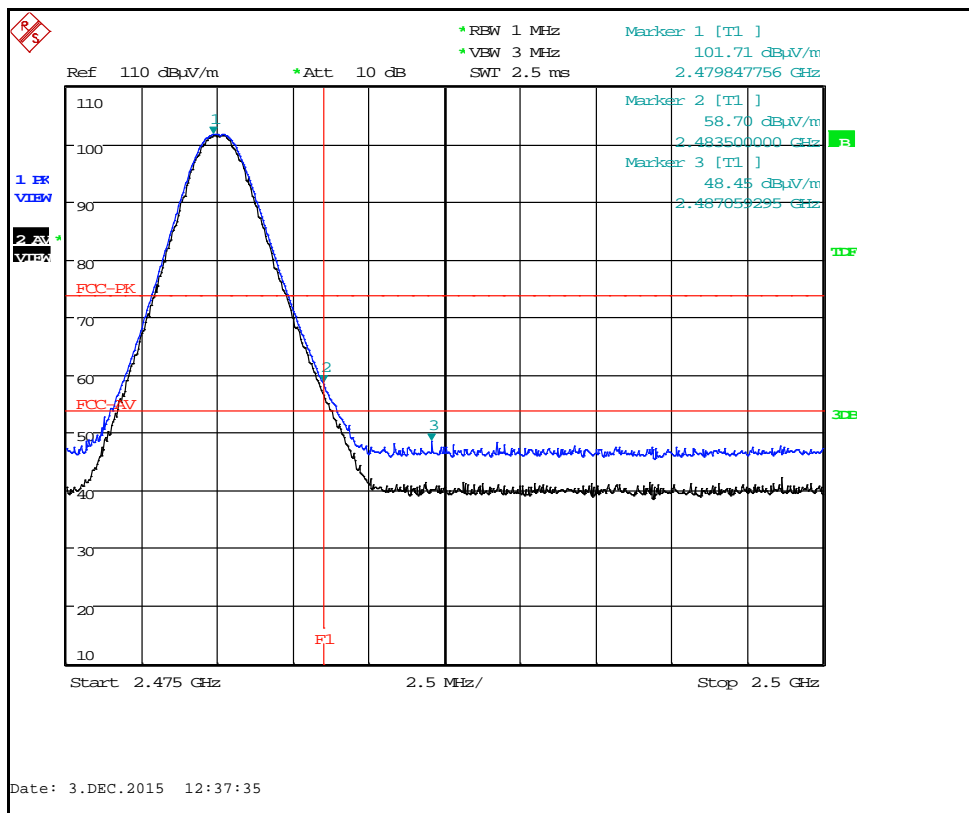

Bluetooth DH5 8PSK Channel 78 : Upper Band Edge

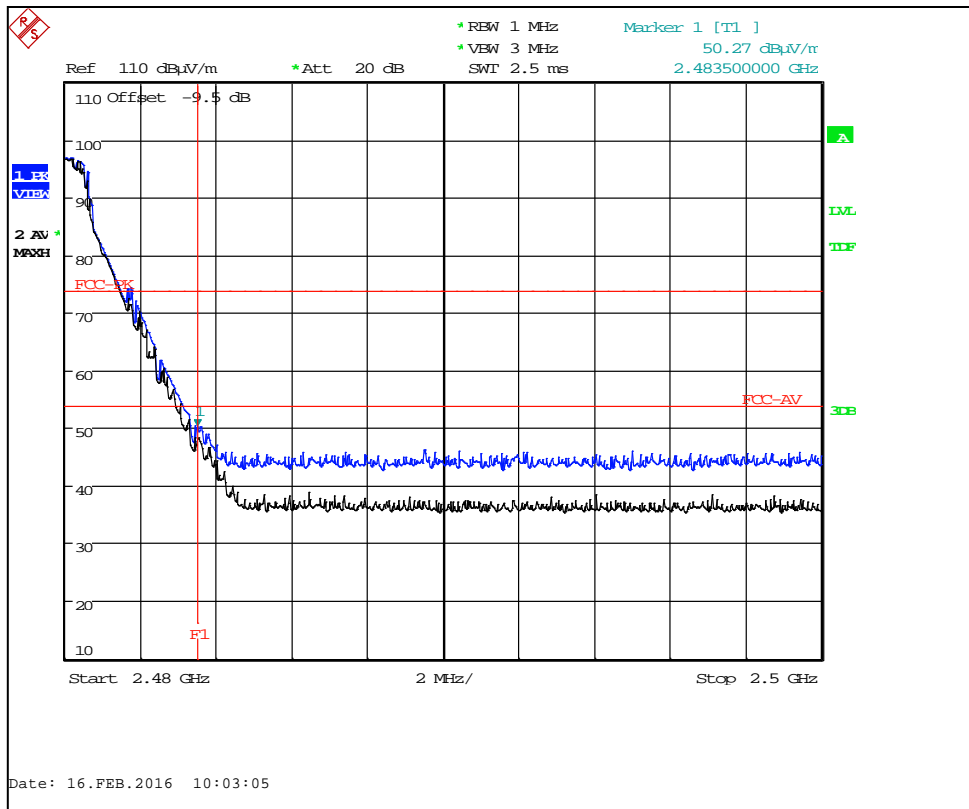

Bluetooth Hopping mode : Upper Band Edge

12 AC power-line conducted emissions

12.1 Definition

Line-to-ground radio-noise voltage that is conducted from all of the EUT current-carrying power input terminals that are directly (or indirectly via separate transformers or power supplies) connected to a public power network.

12.2 Test Parameters

Test Location:	Element Hull
Test Chamber:	Lab 7
Test Standard and Clause:	ANSI C63.10-2013, Clause 6.2
EUT Channels / Frequencies Measured:	Mid
EUT Channel Bandwidths:	1 MHz
EUT Modulation:	GFSK
Deviations From Standard:	None
Measurement BW:	9 kHz
Measurement Detectors:	Quasi-Peak and Average, RMS

Environmental Conditions (Normal Environment)

Temperature: 22 °C	+15 °C to +35 °C (as declared)
Humidity: 32 % RH	20 % RH to 75 % RH (as declared)
Supply: 110 V ac	110 V ac ±10 % (as declared)

Test Limit

A radio apparatus that is designed to be connected to the public utility (AC) power line shall ensure that the radio frequency voltage, which is conducted back onto the AC power line on any frequency or frequencies within the band 150 kHz to 30 MHz, shall not exceed the limits in Table 3.

Table 3 – AC Power Line Conducted Emission Limits

<i>Frequency (MHz)</i>	<i>Conducted limit (dBμV)</i>	
	<i>Quasi-Peak</i>	<i>Average</i>
0.15 to 0.5	66 to 56	56 to 46
0.5 to 5	56	46
5 to 30	60	50

*The level decreases linearly with the logarithm of the frequency.

**A linear average detector is required.

12.3 Test Method

With the EUT setup in a screened room, as per section 9 of this report and connected as per Figure ii, the power line emissions were measured on a spectrum analyzer / EMI receiver.

AC power line conducted emissions from the EUT are checked first by preview scans with peak and average detectors covering both live and neutral lines. A spectrum analyzer is used to determine if any periodic emissions are present.

Formal measurements using the correct detector(s) and bandwidth are made on frequencies identified from the preview scans. Final measurements were performed with EUT set at its maximum duty in transmit and receive modes.

Figure ii Test Setup

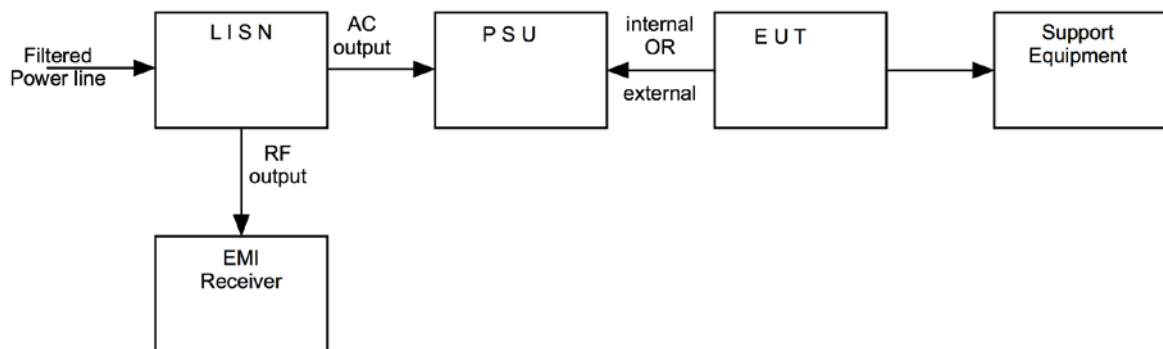

12.4 Test Set-up Photograph

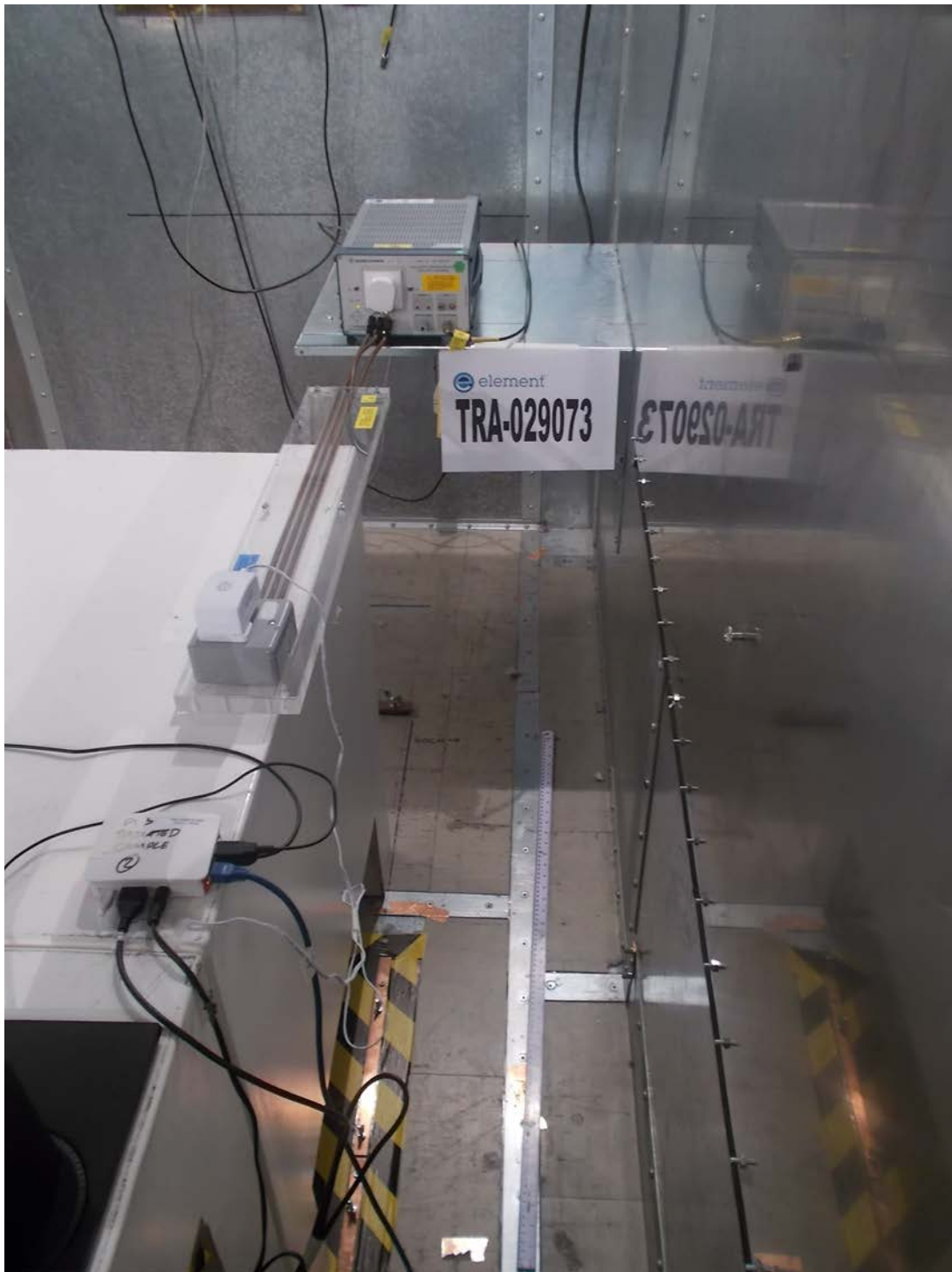

12.5 Test Equipment

Equipment Type	Manufacturer	Equipment Description	Element No	Due For Calibration	Calibration Interval (m)
ESH3-Z5	R & S	LISN	RFG189	08/09/2016	12
ESH3-Z2	R & S	Pulse Limiter	RFG674	02/04/2016	12
ESC17	R & S	Test Receiver	RFG715	06/10/2016	12

12.6 Test Results

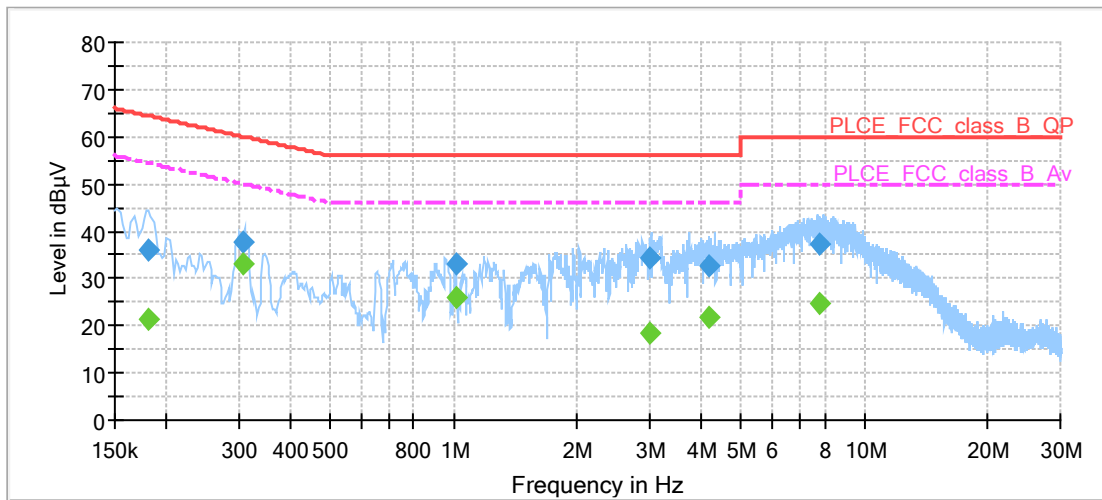

Frequency (MHz)	QuasiPeak (dBµV)	Meas. Time (ms)	Bandwidth (kHz)	PE	Line	Corr. (dB)	Margin (dB)	Limit (dBµV)
0.180600	36.1	15000.0	9.000	GND	L1	10.2	28.3	64.5
0.307550	37.7	15000.0	9.000	GND	L1	10.2	22.4	60.0
1.014800	33.2	15000.0	9.000	GND	N	10.1	22.8	56.0
3.021125	34.5	15000.0	9.000	GND	L1	10.1	21.5	56.0
4.194825	32.7	15000.0	9.000	GND	L1	10.2	23.3	56.0
7.788000	37.4	15000.0	9.000	GND	L1	10.5	22.6	60.0

Frequency (MHz)	Average (dBµV)	Meas. Time (ms)	Bandwidth (kHz)	PE	Line	Corr. (dB)	Margin (dB)	Limit (dBµV)
0.180600	21.4	15000.0	9.000	GND	L1	10.2	33.0	54.5
0.307550	33.1	15000.0	9.000	GND	L1	10.2	16.9	50.0
1.014800	25.9	15000.0	9.000	GND	N	10.1	20.1	46.0
3.021125	18.5	15000.0	9.000	GND	L1	10.1	27.5	46.0
4.194825	21.9	15000.0	9.000	GND	L1	10.2	24.1	46.0
7.788000	24.9	15000.0	9.000	GND	L1	10.5	25.1	50.0

13 Carrier frequency separation

13.1 Definition

The carrier frequency separation is the frequency separation between two adjacent hopping frequencies.

13.2 Test Parameters

Test Location:	Element Hull
Test Chamber:	Lab 4
Test Standard and Clause:	ANSI C63.10-2013, Clause 7.8.2
EUT Channels / Frequencies Measured:	All; 2402 to 2480 MHz
EUT 20dB Bandwidth:	950 kHz
EUT Test Modulations:	Internal pattern generation – hopping enabled
Deviations From Standard:	None
Measurement BW:	30kHz
Measurement Detector:	Peak

Environmental Conditions (Normal Environment)

Temperature: 22 °C	+15 °C to +35 °C (as declared)
Humidity: 32 % RH	20 % RH to 75 % RH (as declared)
Supply: 110 V ac	110V ac ±10 % (as declared)

13.3 Test Limit

Frequency hopping systems shall have hopping channel carrier frequencies separated by a minimum of 25 kHz or the -20 dB bandwidth of the hopping channel, whichever is greater. Alternatively, frequency hopping systems operating in the band 2400 to 2483.5 MHz may have hopping channel carrier frequencies that are separated by 25 kHz or two-thirds of the -20 dB bandwidth of the hopping channel, whichever is greater, provided that the systems operate with an output power no greater than 0.125 W.

13.4 Test Method

With the EUT setup as per section 9 of this report and connected as per Figure iii, the emissions of the EUT were measured on a spectrum analyser.

The measurements were performed with EUT set at its maximum duty. All modulation schemes, data rates and power settings were used to observe the worst-case configuration in each nominal bandwidth.

Figure iii Test Setup

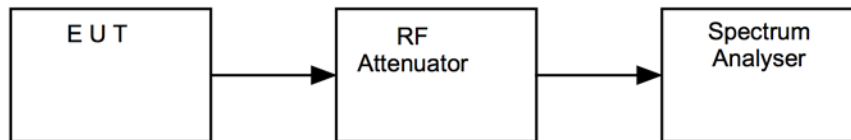

13.5 Test Equipment

Type of Equipment	Maker/Supplier	Model Number	Element Number	Calibration Due Date	Calibration Interval (m)
Spectrum Analyser	Agilent	N9030A	REF2167	13/10/2016	12

13.6 Test Results

<i>Channel #: 38 & 39; Modulation: GFSK; Power setting: Full</i>				
<i>Data Rate</i>	<i>F_{1c} (MHz)</i>	<i>F_{2c} (MHz)</i>	<i>Channel Separation, F_{2c} - F_{1c} (kHz)</i>	<i>Result</i>
DH5	Not recorded	Not recorded	1000.10	PASS



14 Number of hopping frequencies

14.1 Definition

The total number of hopping frequencies (the centre frequencies defined within the hopping sequence of a FHSS equipment) which are randomly sequenced in order to spread the transmission.

14.2 Test Parameters

Test Location:	Element Hull
Test Chamber:	Lab 4
Test Standard and Clause:	ANSI C63.10-2013, Clause 7.8.3
EUT Channels / Frequencies Measured:	All; 2402 – 2480 MHz
EUT 20dB Bandwidth:	950 kHz
EUT Test Modulations:	Internal pattern generation – hopping enabled
Deviations From Standard:	None
Measurement BW:	1 MHz
Measurement Detector:	Peak

Environmental Conditions (Normal Environment)

Temperature: 22 °C	+15 °C to +35 °C (as declared)
Humidity: 32 % RH	20 % RH to 75 % RH (as declared)
Supply: 110 V ac	110 V ac ±10 % (as declared)

14.3 Test Limit

- For frequency hopping systems in the band 902 to 928 MHz: if the -20 dB bandwidth of the hopping channel is less than 250 kHz, the system shall use at least 50 hopping channels;
If the -20 dB bandwidth of the hopping channel is 250 kHz or greater, the system shall use at least 25 hopping channels;
- Frequency hopping systems operating in the band 2400 to 2483.5 MHz shall use at least 15 hopping channels;
- Frequency hopping systems operating in the band 5725 to 5850 MHz shall use at least 75 hopping channels.

14.4 Test Method

With the EUT setup as per section 9 of this report and connected as per Figure iv, the emissions of the EUT were measured on a spectrum analyser.

The measurements were performed with EUT set at its maximum duty. All modulation schemes, data rates and power settings were used to observe the worst-case configuration in each nominal bandwidth.

Figure iv Test Setup

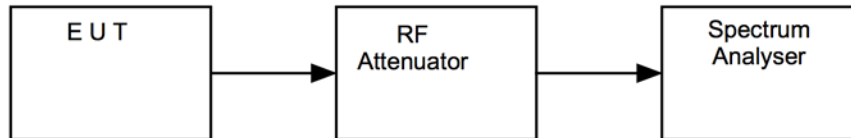

14.5 Test Equipment

Type of Equipment	Maker/Supplier	Model Number	Element Number	Calibration Due Date	Calibration Interval (m)
Spectrum Analyser	Agilent	N9030A	REF2167	13/10/2016	12

14.6 Test Results

<i>Modulation: GFSK; Power setting: Full.</i>				
<i>Data Rate</i>	<i>Lowest channel, F_{CL} (MHz)</i>	<i>Highest channel, F_{CH} (MHz)</i>	<i>Number of channels observed</i>	<i>Result</i>
DH5	2402	2480	79	PASS

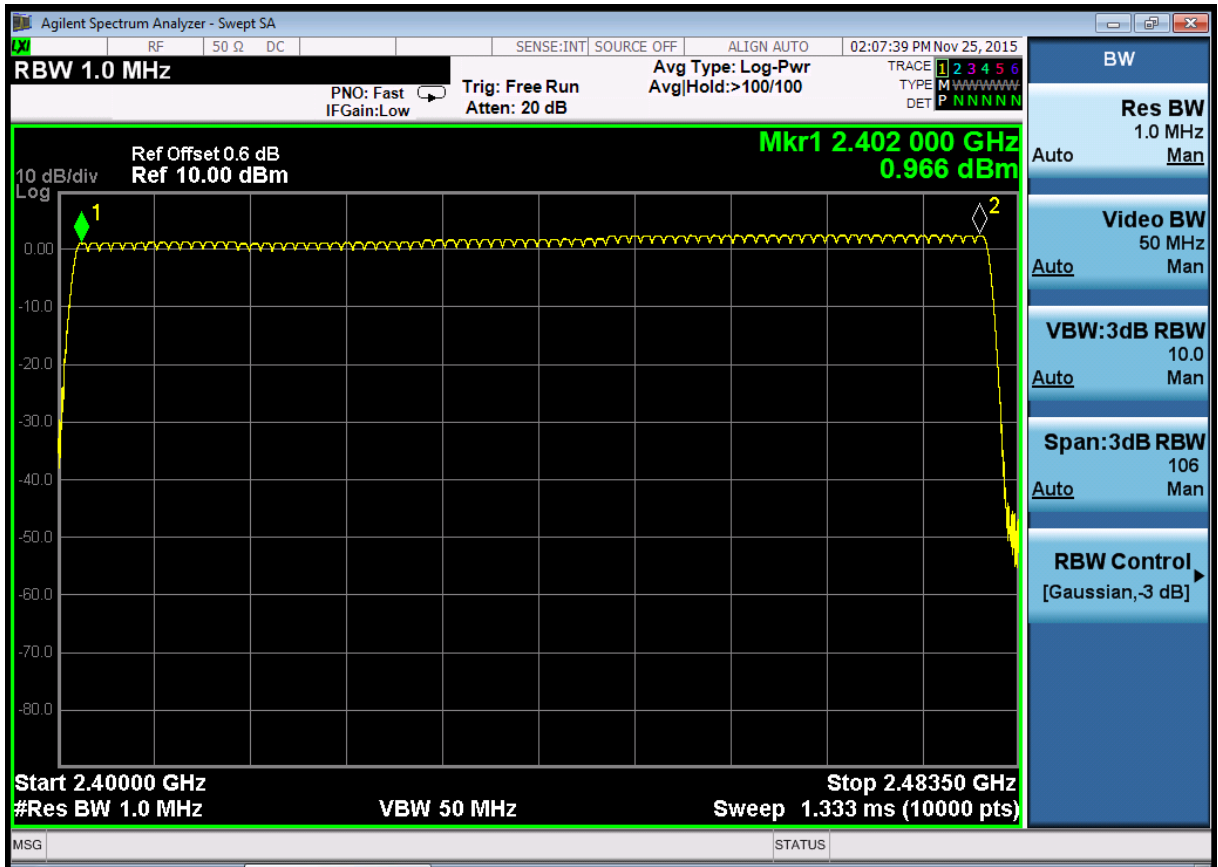

15 Average channel occupancy

15.1 Definition

The channel occupancy is the total of the transmitter 'on' times, during an observation period, on a particular hopping frequency.

15.2 Test Parameters

Test Location:	Element Hull
Test Chamber:	Lab 4
Test Standard and Clause:	ANSI C63.10-2013, Clause 7.8.4
EUT Channels / Frequencies Measured:	Mid
EUT 20dB bandwidth:	950 kHz
EUT Number of hopping channels:	79
EUT Test Modulations:	Internal pattern generation – hopping enabled
Deviations From Standard:	None
Measurement BW:	100kHz
Measurement Detector:	Peak

Environmental Conditions (Normal Environment)

Temperature: 22 °C	+15 °C to +35 °C (as declared)
Humidity: 32 % RH	20 % RH to 75 % RH (as declared)
Supply: 110 V ac	110 V ac ±10 % (as declared)

15.3 Test Limit

- For frequency hopping systems in the band 902 to 928 MHz: if the -20 dB bandwidth of the hopping channel is less than 250 kHz, the average time of occupancy on any channel shall not be greater than 0.4 seconds within a 20 second period; If the -20 dB bandwidth of the hopping channel is 250 kHz or greater, the average time of occupancy on any channel shall not be greater than 0.4 seconds within a 10 second period;
- Frequency hopping systems operating in the band 2400 to 2483.5 MHz: The average time of occupancy on any channel shall not be greater than 0.4 seconds within a period of 0.4 seconds, multiplied by the number of hopping channels employed;
- Frequency hopping systems operating in the band 5725 to 5850 MHz: The average time of occupancy on any frequency shall not be greater than 0.4 seconds within a 30 second period.

15.4 Test Method

With the EUT setup as per section 9 of this report and connected as per Figure v, the emissions of the EUT were measured on a spectrum analyser.

The measurements were performed with EUT set at its maximum duty. A number of hops were observed to confirm consistency of the dwell time / observe the worst case. All modulation schemes, data rates and power settings were used to observe the worst-case configuration.

Figure v Test Setup

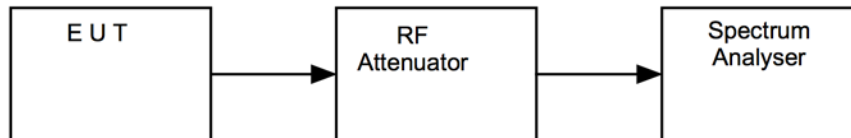

15.5 Test Equipment

Type of Equipment	Maker/Supplier	Model Number	Element Number	Calibration Due Date	Calibration Interval (m)
Spectrum Analyser	Agilent	N9030A	REF2167	13/10/2016	12

15.6 Test Results

<i>Modulation: GFSK ; Power setting: Full.</i>					
<i>Data Rate</i>	<i>Individual occupancy time (ms)</i>	<i>Observation period (s)</i>	<i>Number of hops observed</i>	<i>Average time of occupancy (s)</i>	<i>Result</i>
DH5	0.1443	31.6	1620	0.233766	PASS

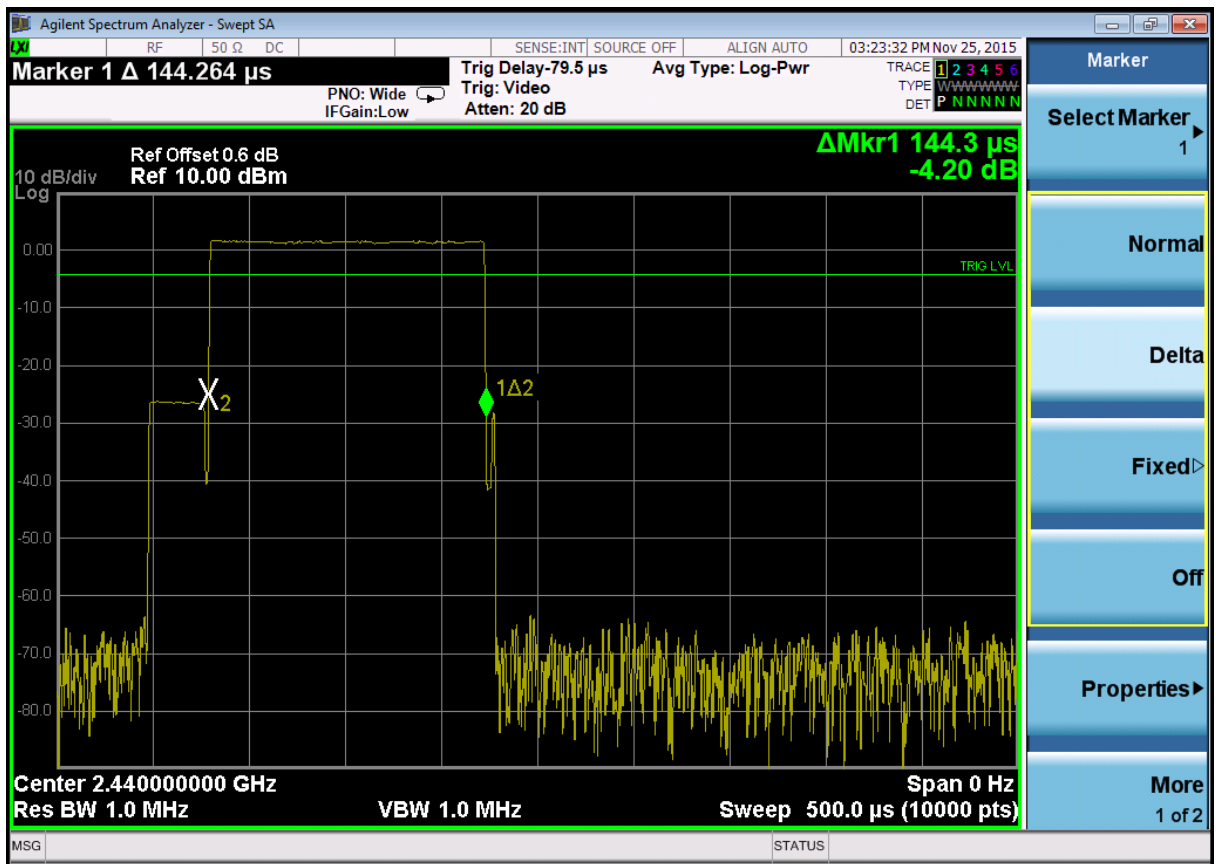

16 Maximum peak conducted output power

16.1 Definition

The maximum peak conducted output power is defined as the maximum power level measured with a peak detector using a filter with width and shape of which is sufficient to accept the signal bandwidth.

16.2 Test Parameters

Test Location:	Element Hull
Test Chamber:	Lab 4
Test Standard and Clause:	ANSI C63.10-2013, Clause 7.8.5
EUT Channels / Frequencies Measured:	Low / Mid / High – hopping disabled.
EUT Channel Bandwidths:	1 MHz
Deviations From Standard:	None
Measurement BW:	Wideband
Spectrum Analyzer Video BW:	N/A
Measurement Detector:	Peak
Voltage Extreme Environment Test Range:	Mains Power = 85 % and 115 % of Nominal (FCC only requirement); Battery Power = new battery.

Environmental Conditions (Normal Environment)

Temperature: 19 °C	+15 °C to +35 °C (as declared)
Humidity: 55 % RH	20 % RH to 75 % RH (as declared)

16.3 Test Limit

- For frequency hopping systems operating in the band 902 to 928 MHz, the maximum peak conducted output power shall not exceed 1 W, and the e.i.r.p. shall not exceed 4 W, if the hopset uses 50 or more hopping channels; the maximum peak conducted output power shall not exceed 0.25 W, and the e.i.r.p. shall not exceed 1 W, if the hopset uses less than 50 hopping channels.
- For frequency hopping systems operating in the band 2400 to 2483.5 MHz and employing at least 75 hopping channels, the power shall not exceed 1 W; for all other frequency hopping systems in the band, the maximum peak conducted output power shall not exceed 0.125 W. The e.i.r.p. shall not exceed 4 W.
- For frequency hopping systems operating in the band 5725 to 5850 MHz, the maximum peak conducted output power shall not exceed 1 W. The e.i.r.p. shall not exceed 4 W.
- Point-to-point systems in the bands 2400-2483.5 MHz and 5725 to 5850 MHz are permitted to have an e.i.r.p. higher than 4 W provided that the higher e.i.r.p. is achieved by employing higher gain directional antennas and not higher transmitter output powers.

16.4 Test Method

With the EUT setup as per section 9 of this report and connected as per Figure vi, the resolution bandwidth of the spectrum analyser was increased above the EUT occupied bandwidth and the peak emission data noted.

The measurements were performed with EUT set at its maximum duty. All modulation schemes, data rates and power settings were used to observe the worst-case configuration in each bandwidth.

Figure vi Test Setup

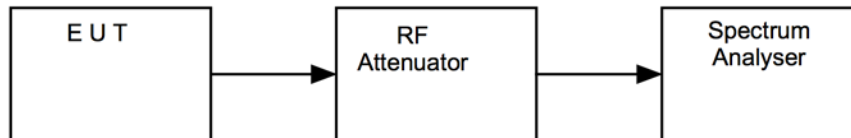

16.5 Test Equipment

Equipment Type	Manufacturer	Equipment Description	Element No	Due For Calibration	Calibration Interval (m)
RPR3006W	DARE	Power Meter	REF2083	17/11/2016	12

16.6 Test Results

Modulation: GFSK; Data rate: DH5; Power setting: Full						
Channel Frequency (MHz)	Analyzer Level (dBm)	Cable loss (dB)	Maximum peak conducted output power (W)	Antenna gain (dBi)	E.I.R.P. (W)	Result
2402	3.5	0	0.0022	1.5	0.0032	PASS
2440	3.8	0	0.0024	1.5	0.0034	PASS
2480	4.2	0	0.0026	1.5	0.0037	PASS

Modulation: 8PSK; Data rate: DH5; Power setting: Full						
Channel Frequency (MHz)	Analyzer Level (dBm)	Cable loss (dB)	Maximum peak conducted output power (W)	Antenna gain (dBi)	E.I.R.P. (W)	Result
2402	3.5	0	0.0022	1.5	0.0032	PASS
2440	3.7	0	0.0023	1.5	0.0033	PASS
2480	4.0	0	0.0025	1.5	0.0035	PASS

17 Occupied Bandwidth

17.1 Definition

The emission bandwidth (-20 dB) is defined as the frequency range between two points, one above and one below the carrier frequency, at which the spectral density of the emission is attenuated 20 dB below the maximum in-band spectral density of the modulated signal.

17.2 Test Parameters

Test Location:	Element Hull
Test Chamber:	Lab 4
Test Standard and Clause:	ANSI C63.10-2013, Clause 6.9
EUT Channels / Frequencies Measured:	Low / Mid / High – hopping stopped.
EUT Channel Bandwidths:	1 MHz
EUT Test Modulations:	DH5 (GFSK and 8PSK)
Deviations From Standard:	None
Measurement BW: (requirement: 1 % to 5 % OBW)	30 kHz
Spectrum Analyzer Video BW: (requirement at least 3x RBW)	300 kHz
Measurement Span: (requirement 2 to 5 times OBW)	2 MHz
Measurement Detector:	Peak

Environmental Conditions (Normal Environment)

Temperature: 22 °C	+15 °C to +35 °C (as declared)
Humidity: 32 % RH	20 % RH to 75 % RH (as declared)
Supply: 110 V ac	110 V ac ±10 % (as declared)

17.3 Test Limit

- For frequency hopping systems in the band 902 to 928 MHz: The maximum allowed -20 dB bandwidth of the hopping channel is 500 kHz.
- Frequency hopping systems operating in the band 5725 to 5850 MHz: The maximum -20 dB bandwidth of the hopping channel shall be 1 MHz

17.4 Test Method

With the EUT setup as per section 9 of this report and connected as per Figure vii, the bandwidth of the EUT was measured on a spectrum analyser.

The measurements were performed with EUT set at its maximum duty. All modulation schemes, data rates and power settings were used to observe the worst-case configuration in each bandwidth.

Figure vii Test Setup

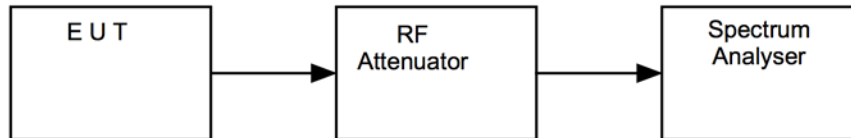

17.5 Test Equipment

<i>Type of Equipment</i>	<i>Maker/Supplier</i>	<i>Model Number</i>	<i>Element Number</i>	<i>Calibration Due Date</i>	<i>Calibration Interval (m)</i>
Spectrum Analyser	Agilent	N9030A	REF2167	13/10/2015	12

17.6 Test Results

Modulation: GFSK; Data rate: DH5; Power setting: Full			
Channel Frequency (MHz)	99% Bandwidth (kHz)	20dB Bandwidth (kHz)	Result
2402	909.78	949.4	PASS
2440	910.36	949.3	PASS
2480	911.83	950.0	PASS

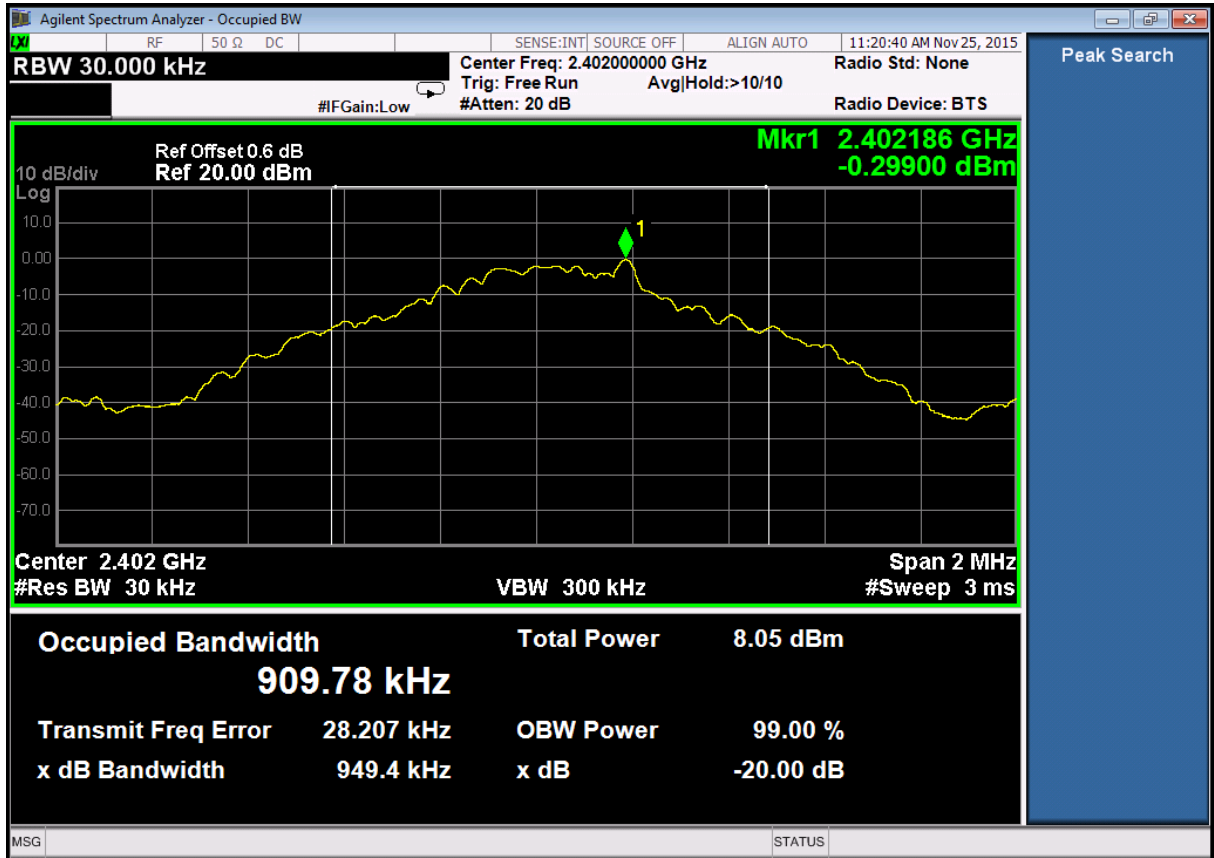

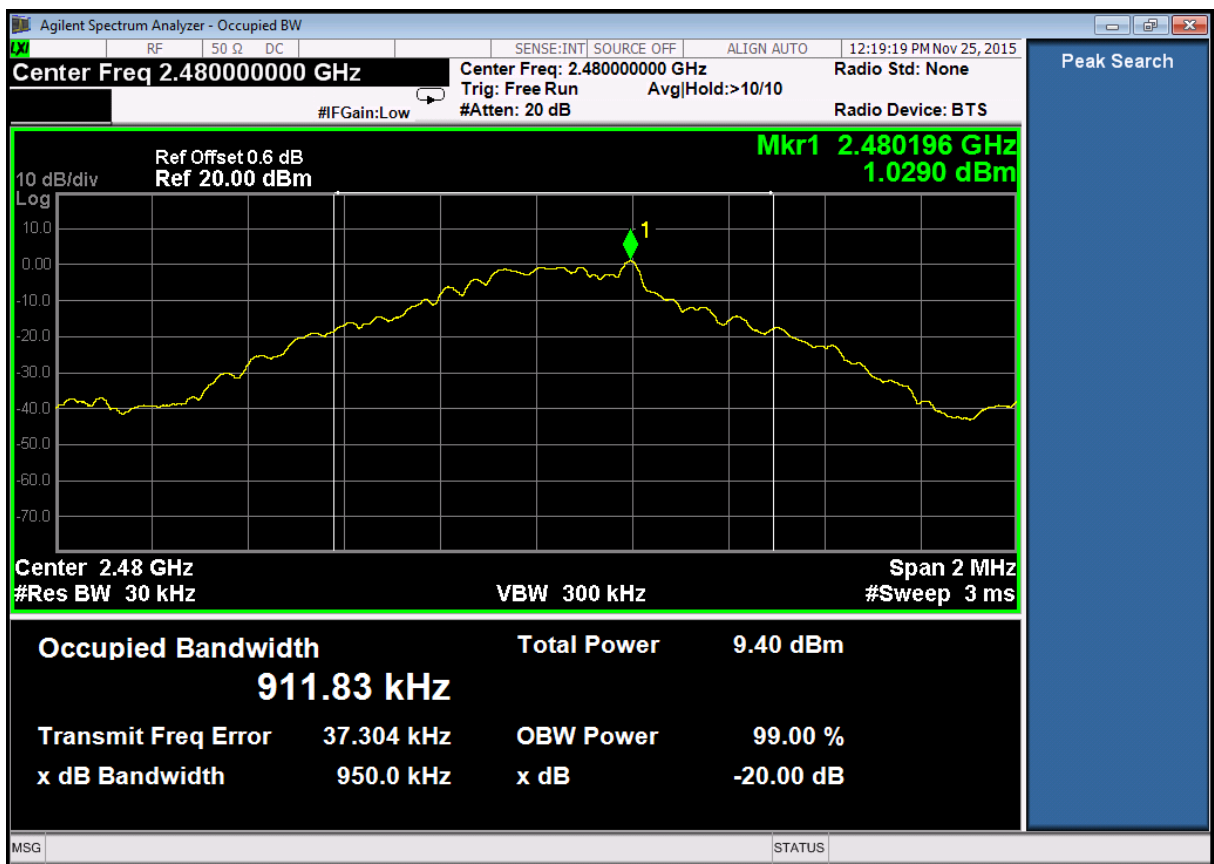

Modulation: 8PSK; Data rate: DH5; Power setting: Full			
Channel Frequency (MHz)	99% Bandwidth (kHz)	20dB Bandwidth (kHz)	Result
2402	910.99	950.3	PASS
2440	909.93	948.3	PASS
2480	911.02	949.0	PASS

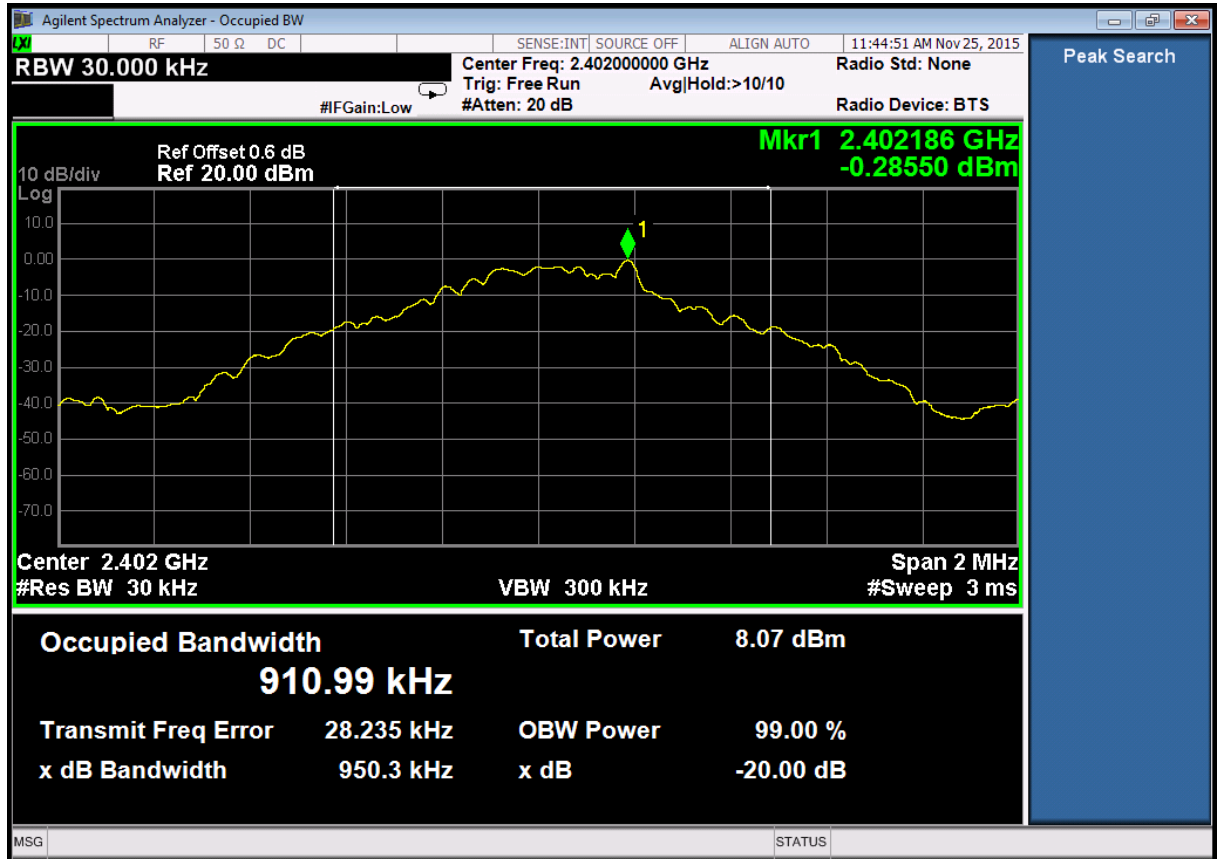

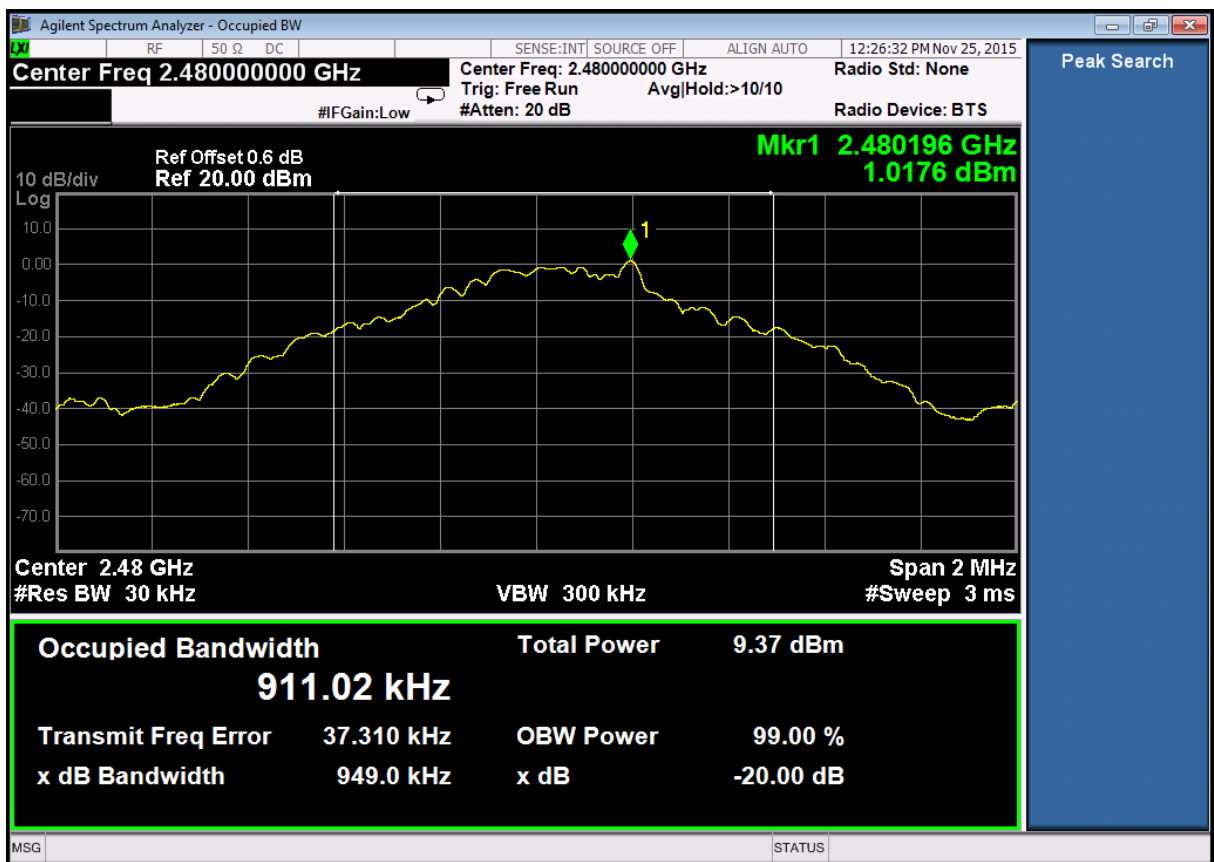
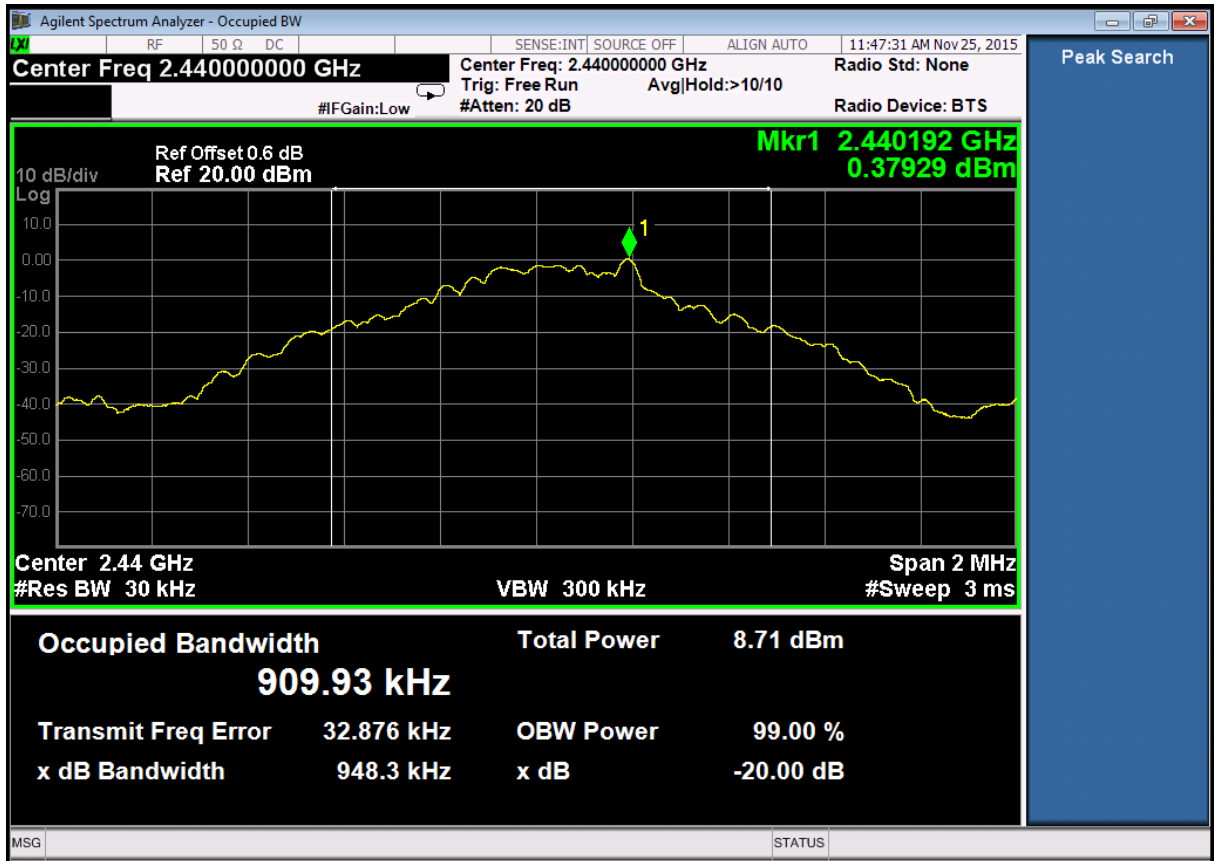

18 Out-of-band and conducted spurious emissions

18.1 Definition

Out-of-band emission.

Emission on a frequency or frequencies immediately outside the necessary bandwidth that results from the modulation process but excluding spurious emissions.

Spurious emission.

Emission on a frequency or frequencies that are outside the necessary bandwidth and the level of which may be reduced without affecting the corresponding transmission of information. Spurious emissions include harmonic emissions, parasitic emissions, intermodulation products, and frequency conversion products, but exclude out-of-band emissions.

18.2 Test Parameters

Test Location:	Element Hull
Test Chamber:	Lab 4
Test Standard and Clause:	ANSI C63.10-2013, Clause 7.8.8
EUT Channels / Frequencies Measured:	2402/2440/2480 MHz
EUT Channel Bandwidths:	1 MHz
Deviations From Standard:	None
Measurement BW:	100 kHz
Spectrum Analyzer Video BW: (requirement at least 3x RBW)	300 kHz
Measurement Detector:	Peak
Measurement Range:	9 kHz to 25 GHz

Environmental Conditions (Normal Environment)

Temperature: 25 °C	+15 °C to +35 °C (as declared)
Humidity: 30 % RH	20 % RH to 75 % RH (as declared)
Supply: 110 V ac	110 V ac ±10 % (as declared)

18.3 Test Limits

In any 100 kHz bandwidth outside the frequency band in which the spread spectrum or digitally modulated device is operating, the RF power that is produced shall be at least 20 dB below that in the 100 kHz bandwidth within the band that contains the highest level of the desired power, based on either an RF conducted or a radiated measurement, provided that the transmitter demonstrates compliance with the peak conducted power limits. If the transmitter complies with the conducted power limits based on the use of root-mean-square averaging over a time interval, the attenuation required shall be 30 dB instead of 20 dB. Attenuation below the general field strength limits specified in FCC 47CFR15.209(a) / RSS-Gen is not required.

18.4 Test Method

With the EUT setup as per section 9 of this report and connected as per Figure viii, the emissions from the EUT were measured on a spectrum analyser.

The measurements were performed with EUT set at its maximum duty. All modulation schemes, data rates and power settings were used to observe the worst case configuration in each bandwidth.

Figure viii Test Setup

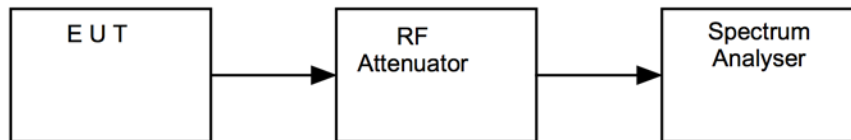

18.5 Test Equipment

Equipment Type	Manufacturer	Equipment Description	Element No	Due For Calibration	Calibration Interval (m)
FSU26	R&S	Spectrum Analyser	U405	11/05/2016	12

18.6 Test Results

<i>Modulation: GFSK; Data rate: 1Mbps; Power setting: -1</i>						
<i>Channel Frequency (MHz)</i>	<i>Emission Frequency (MHz)</i>	<i>Analyzer Level (dBm)</i>	<i>Emission Level (dBm)</i>	<i>Limit (dBm)</i>	<i>Margin (dB)</i>	<i>Result</i>
All emissions were a minimum of 20 dB below the test limit						

CH0

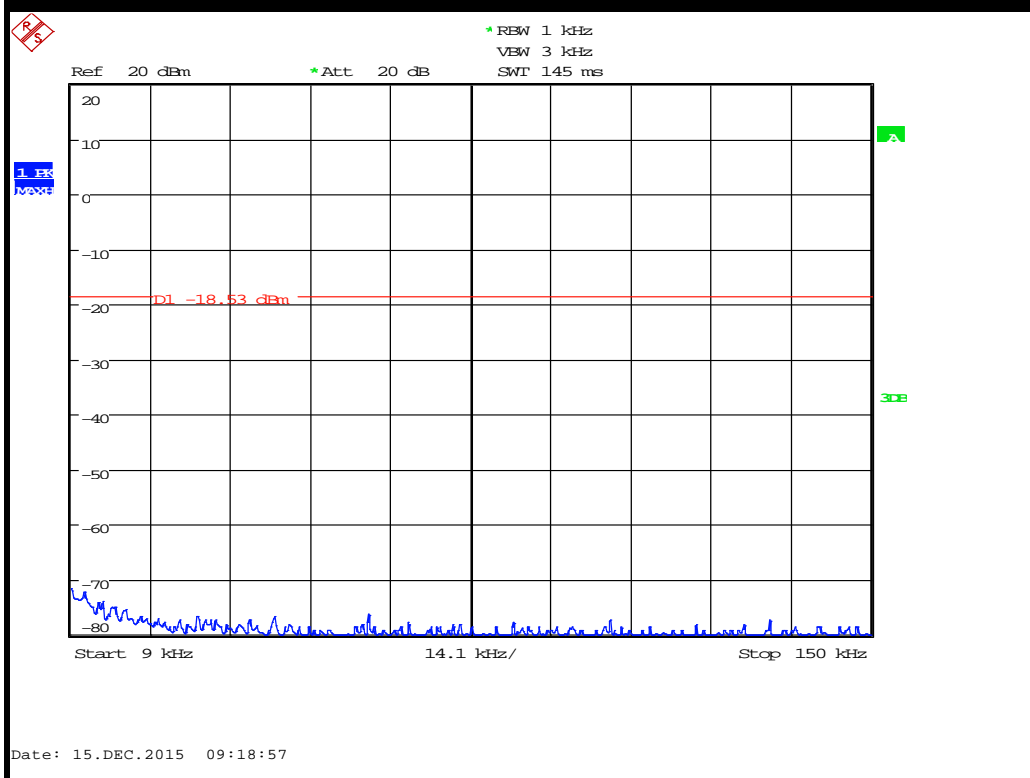
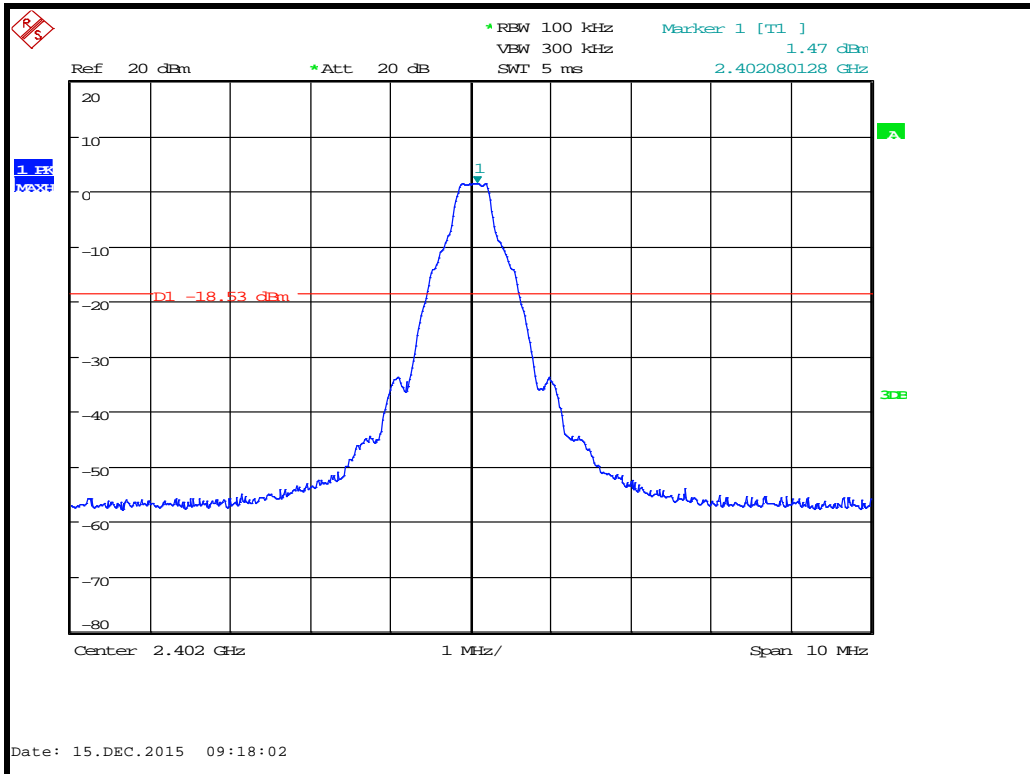

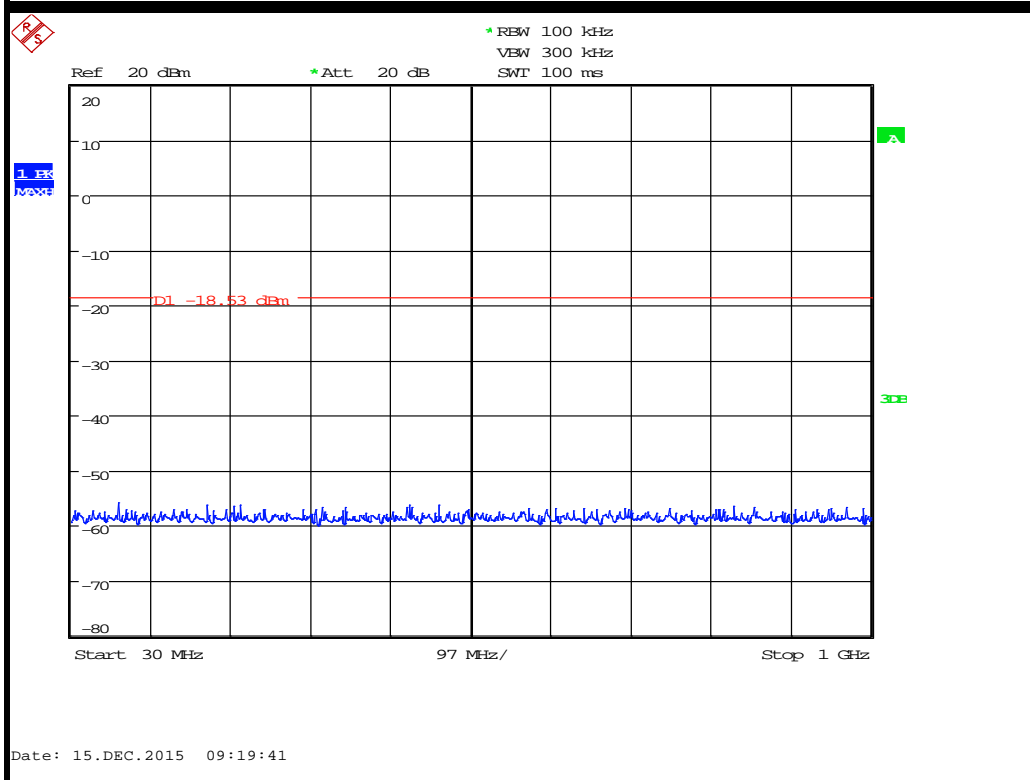
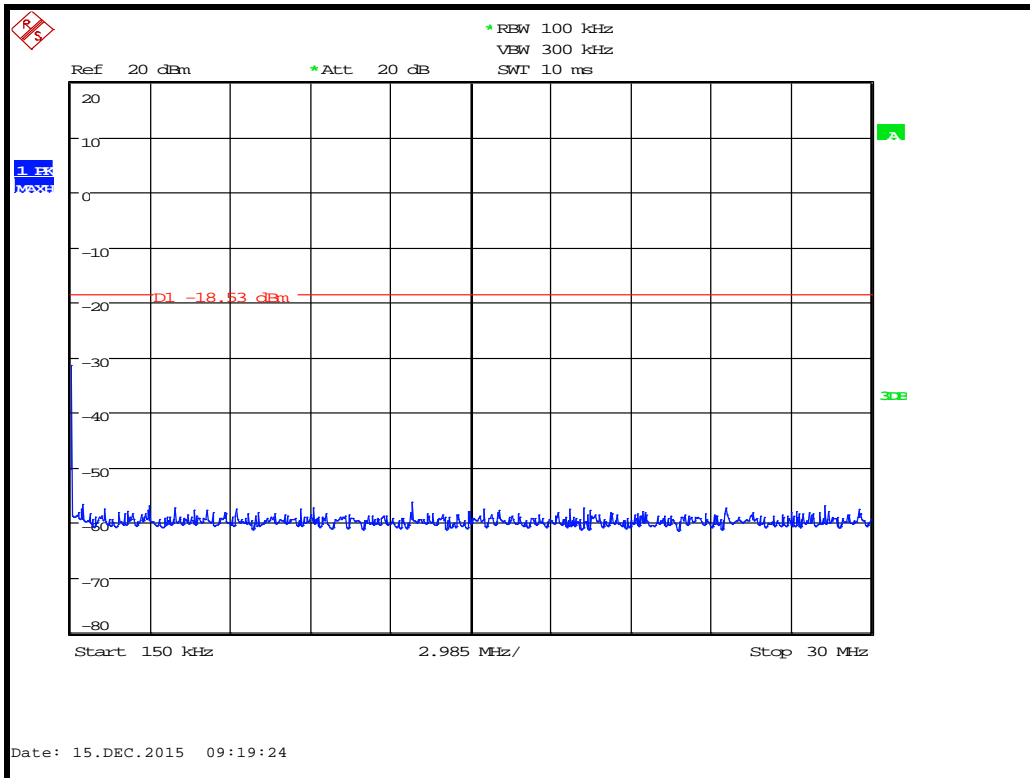

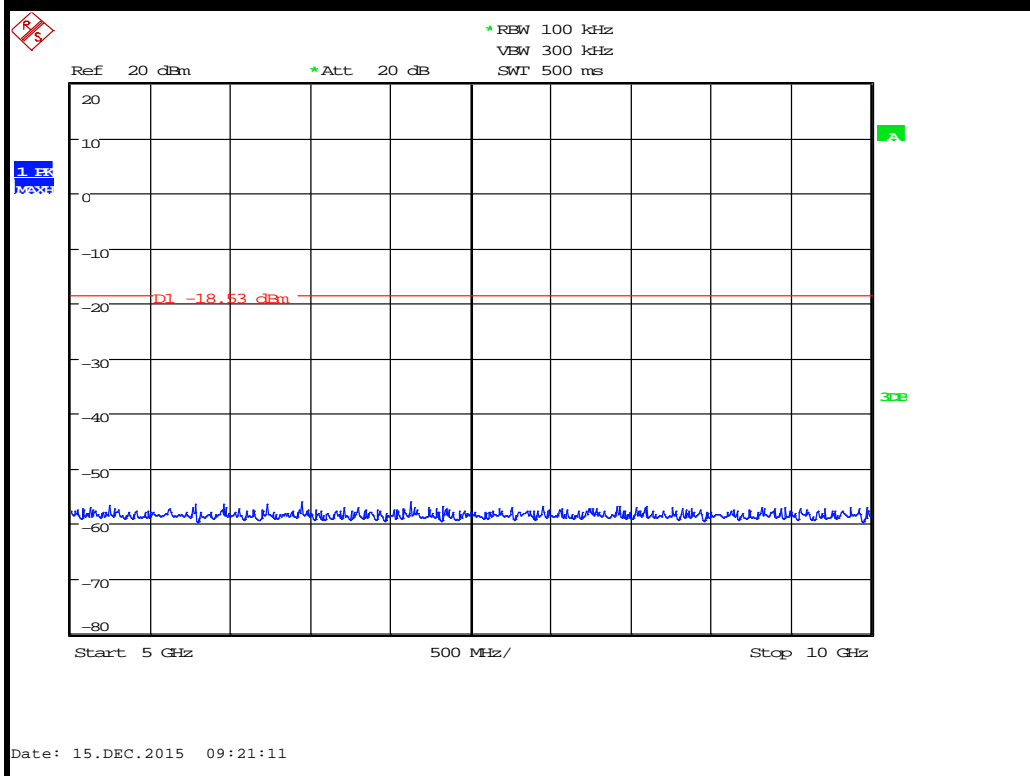
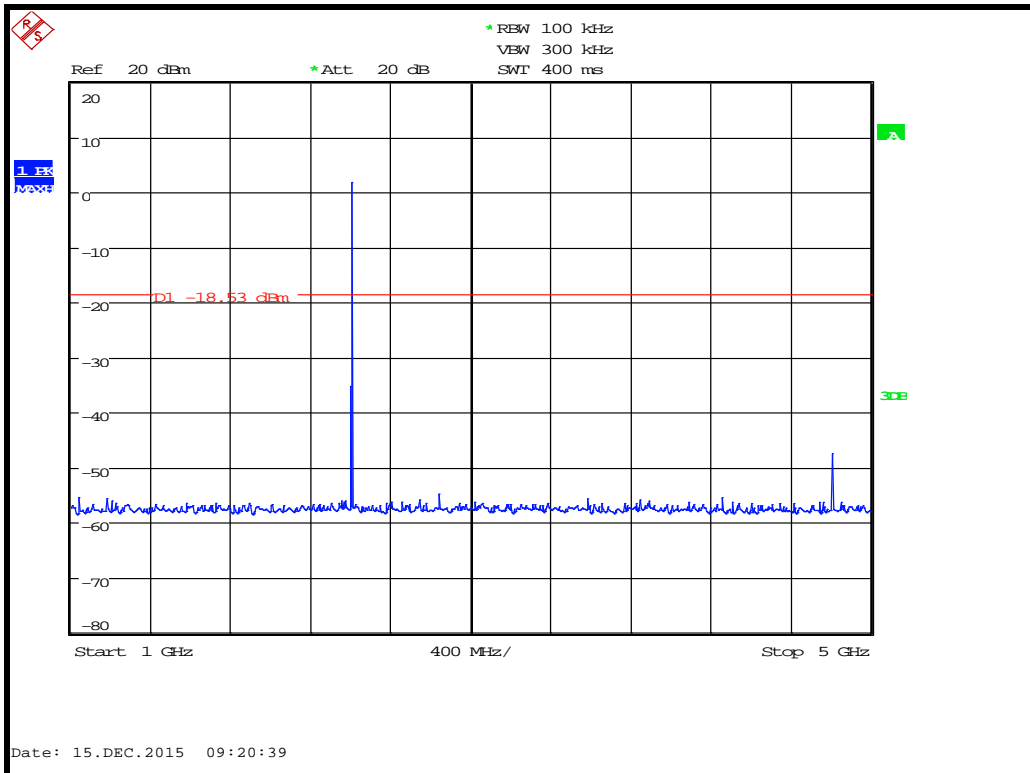

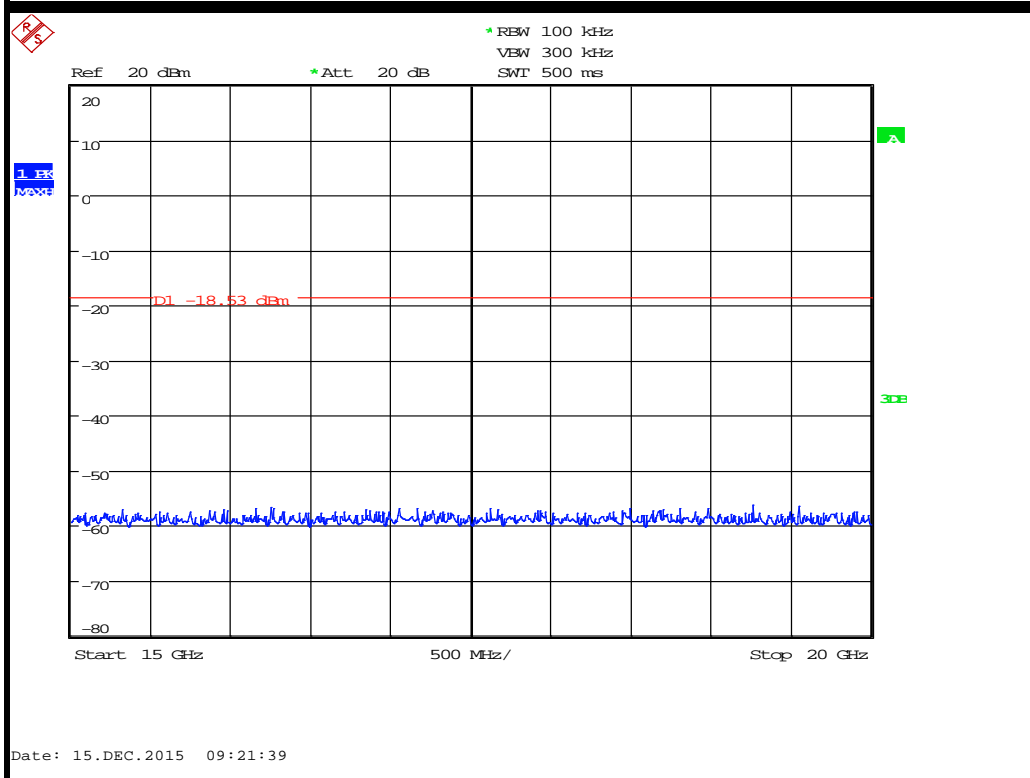
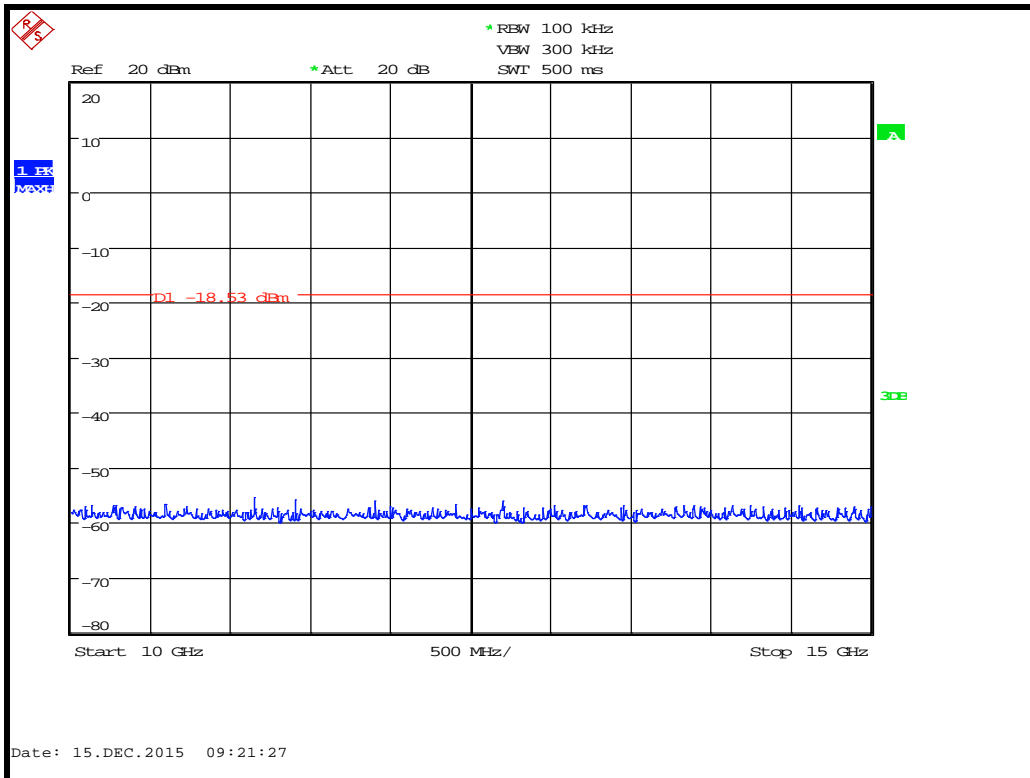

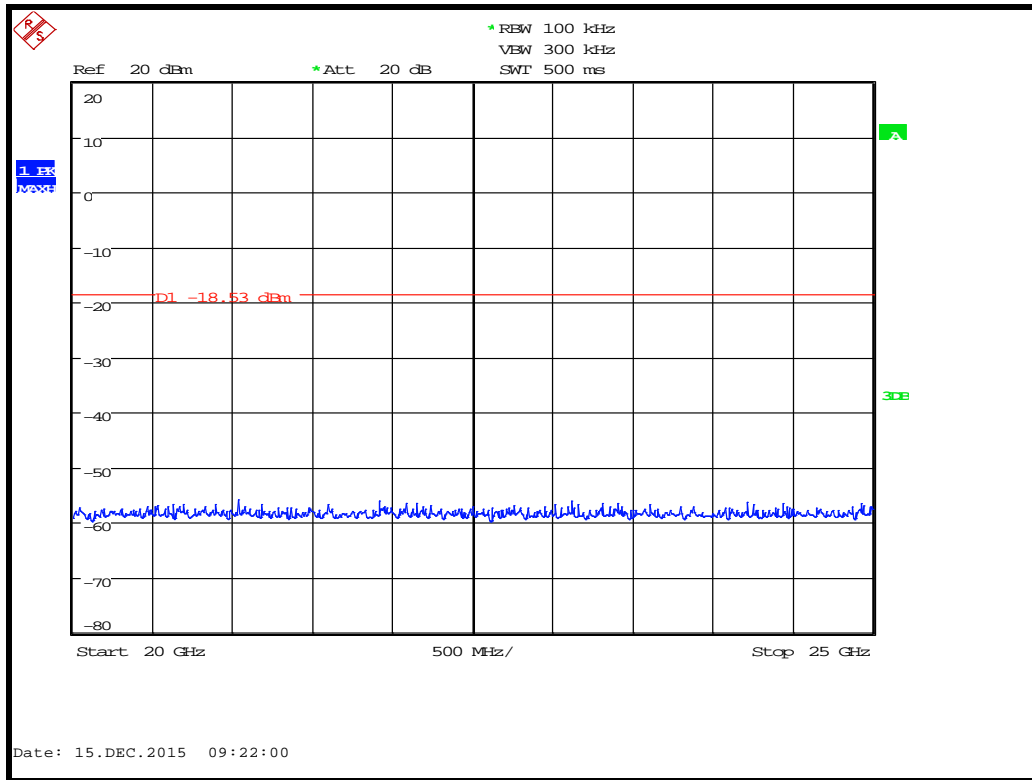

CH38

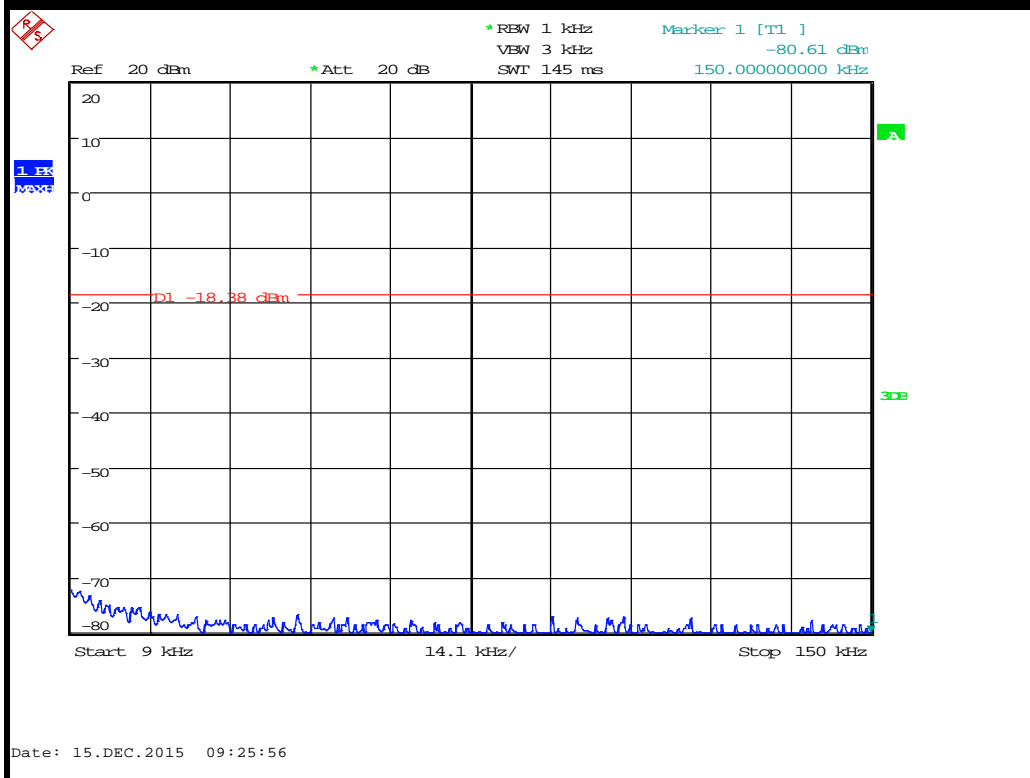
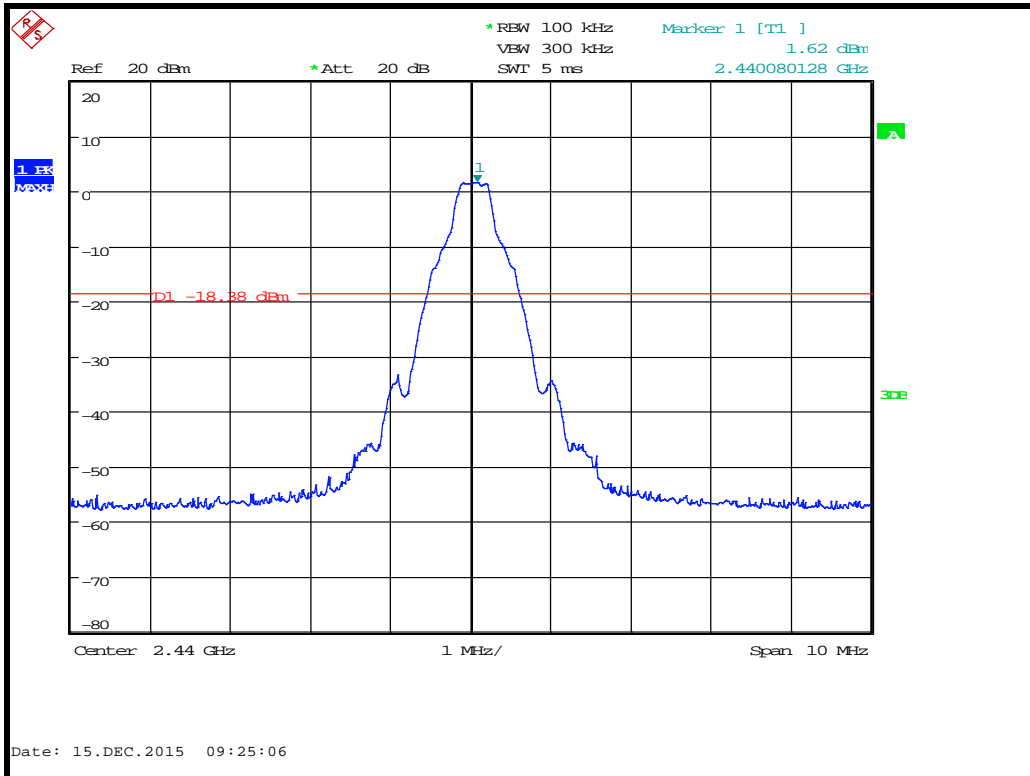

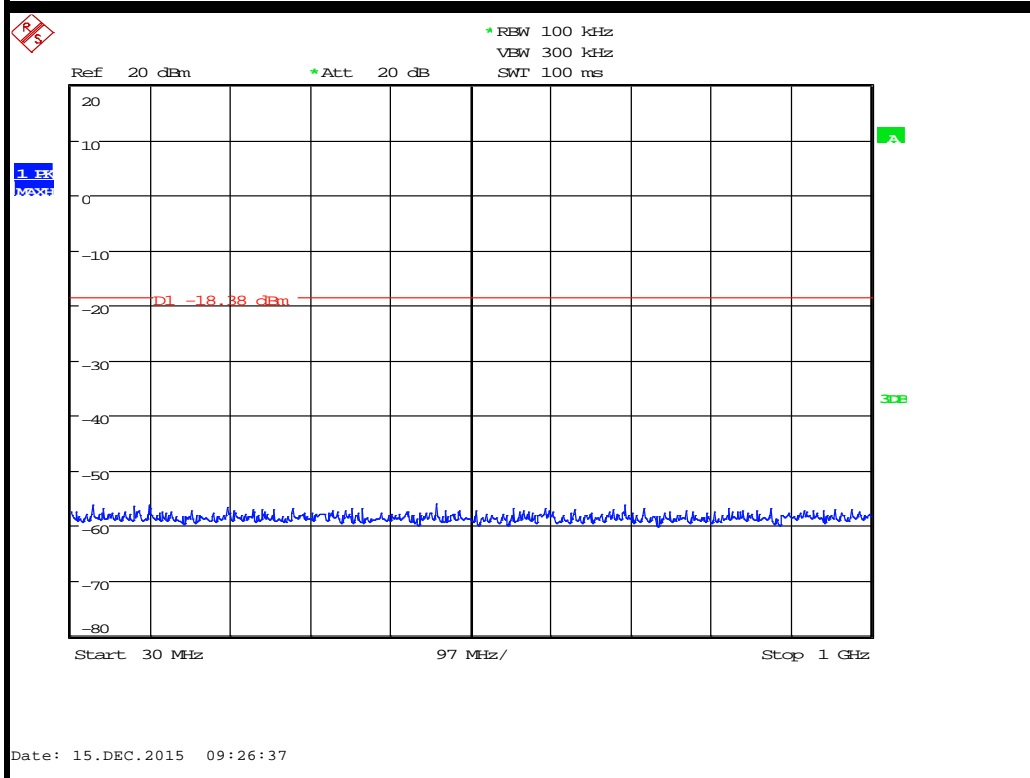
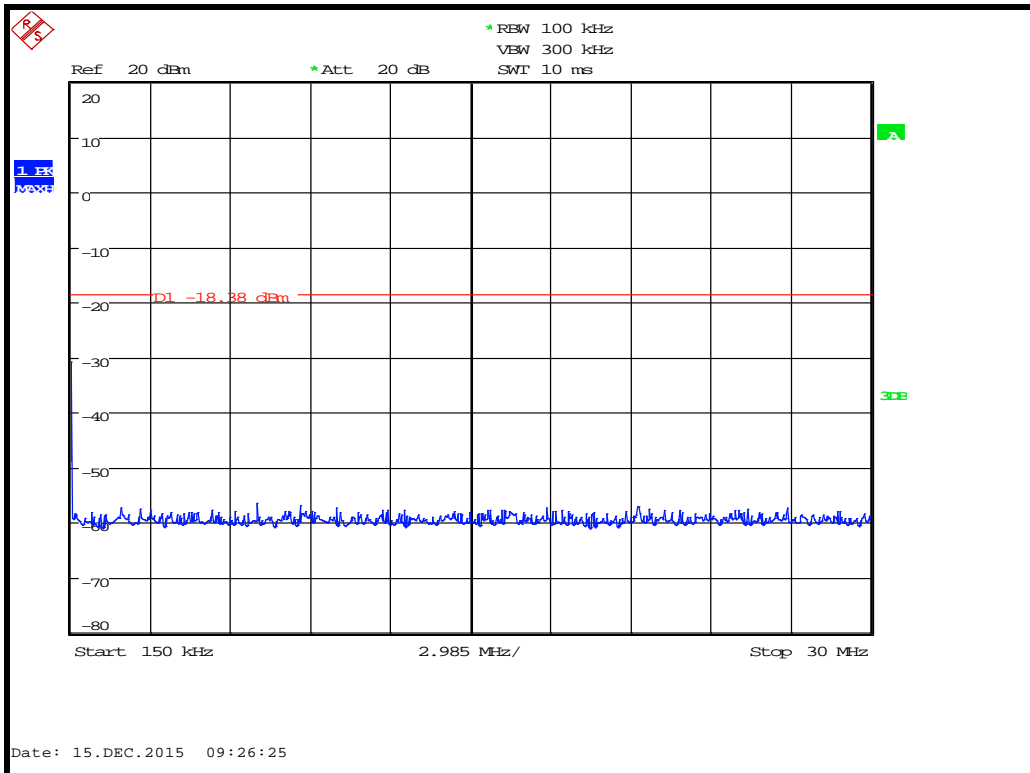

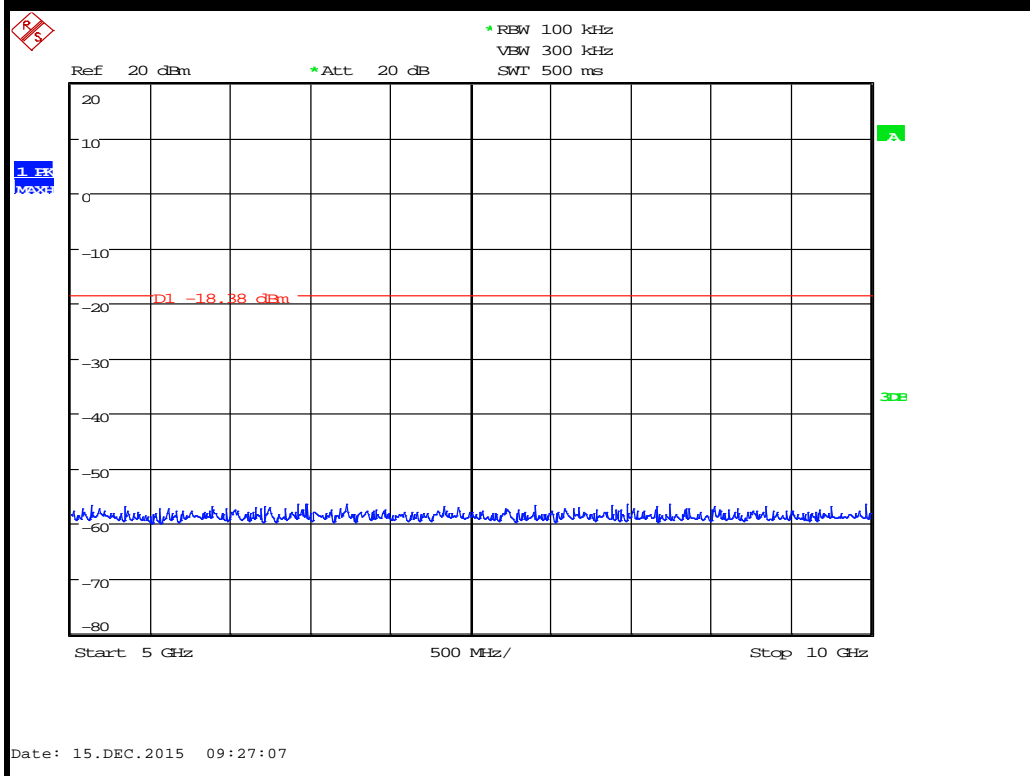
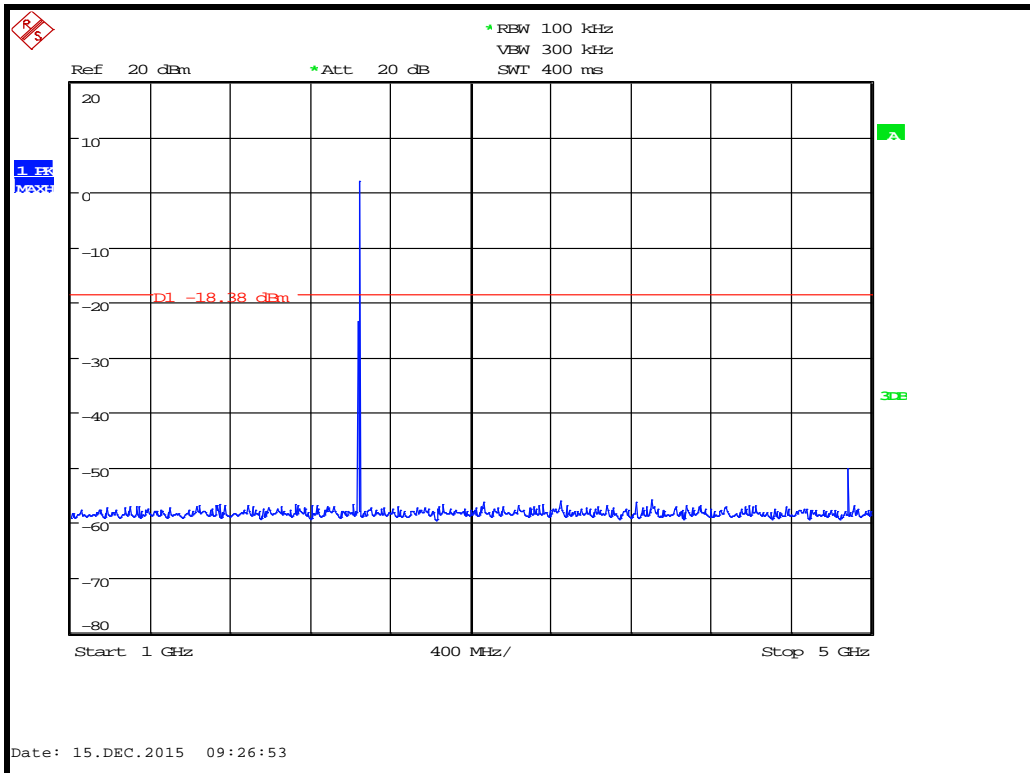

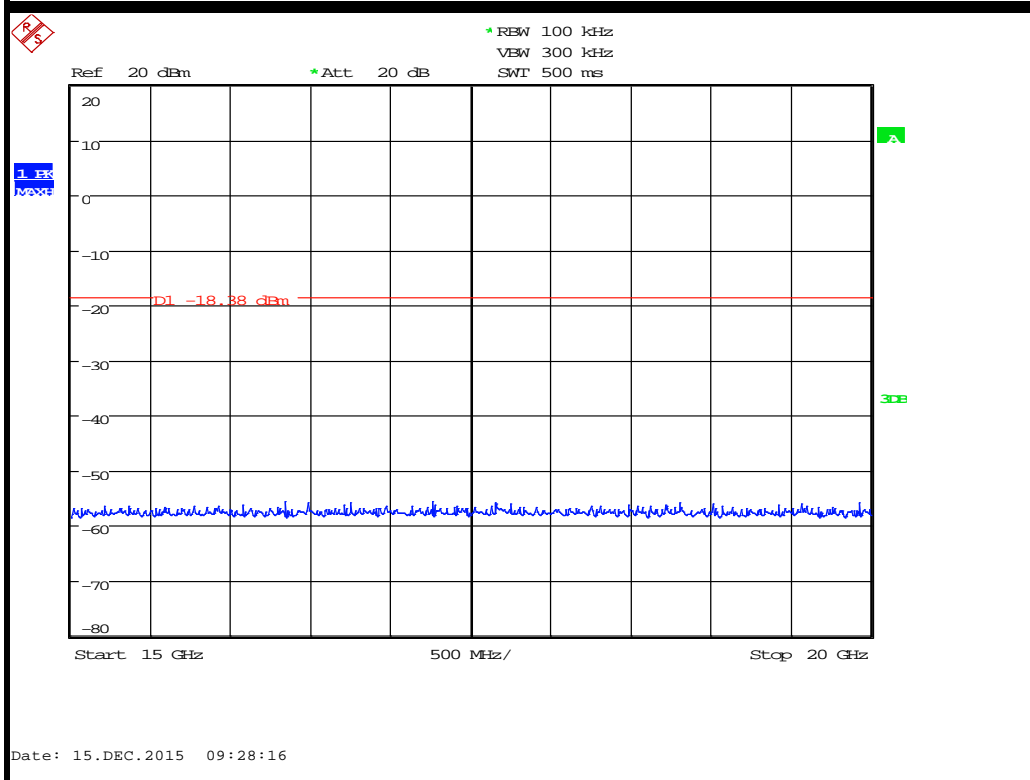
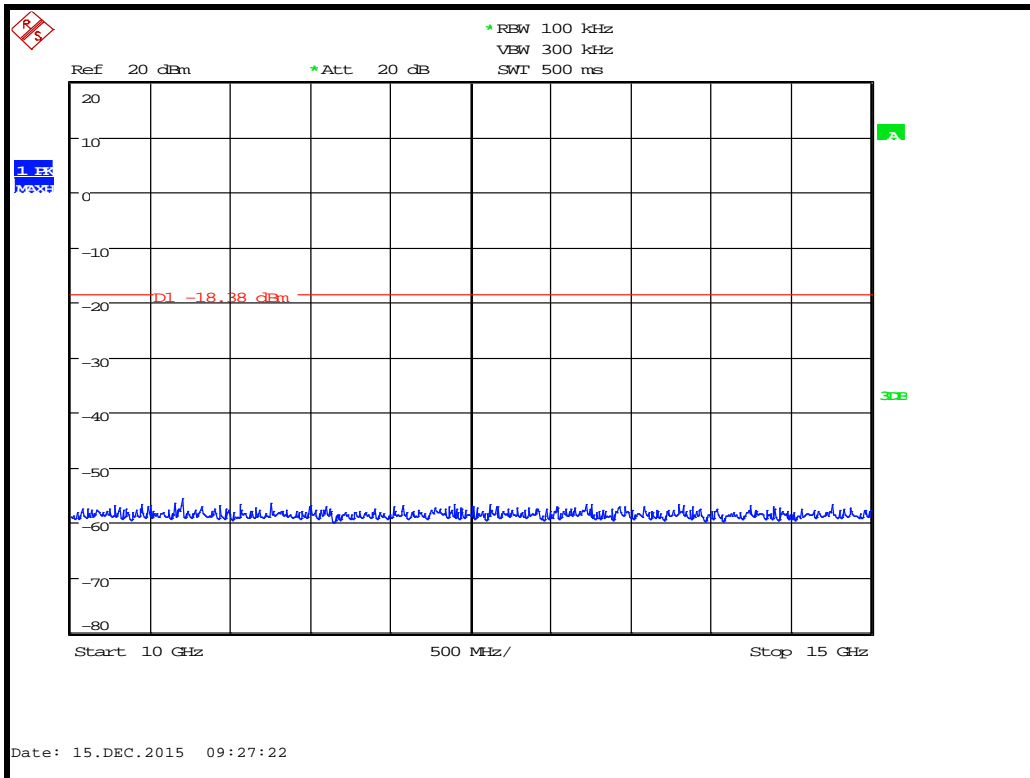

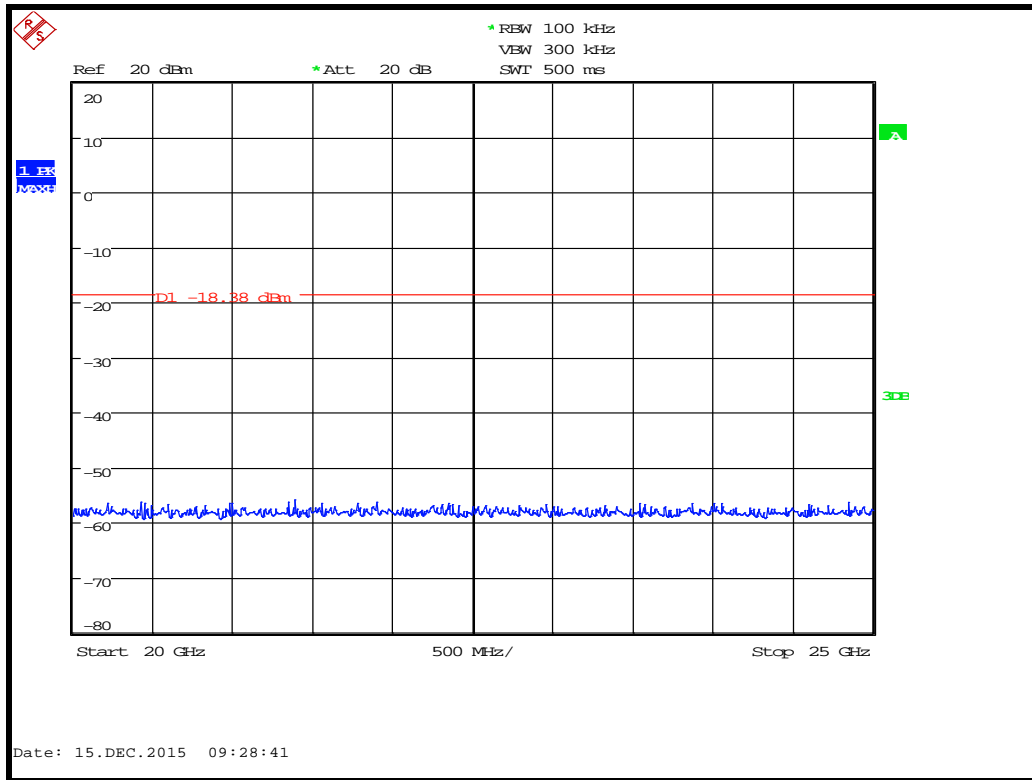

CH76

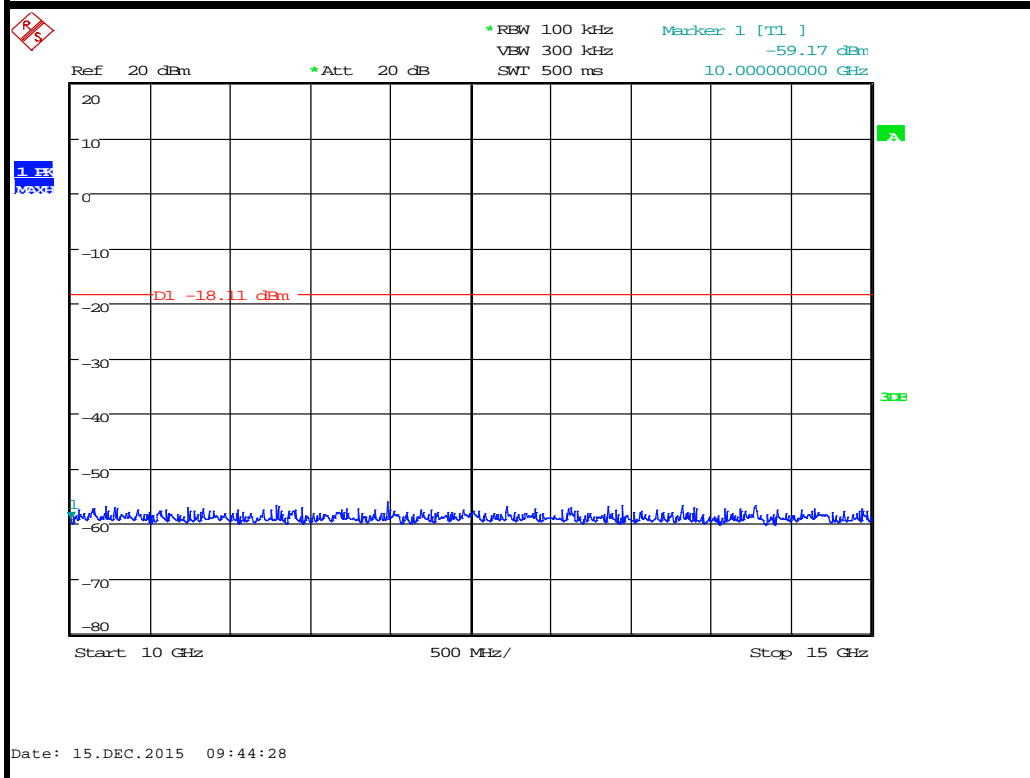
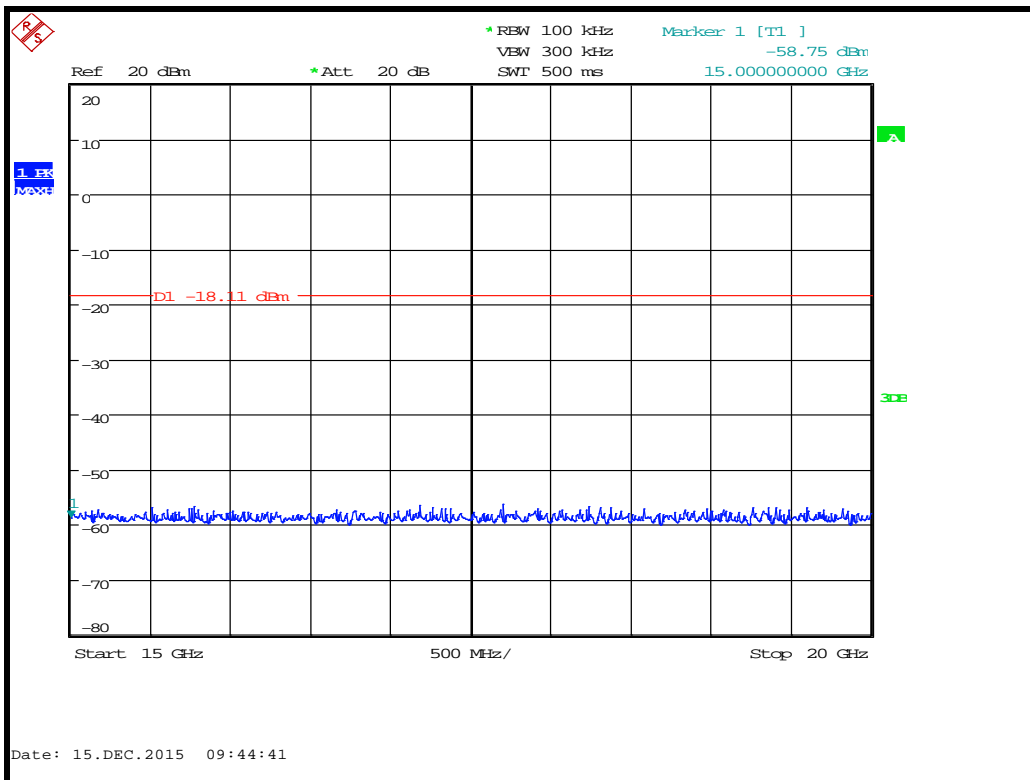

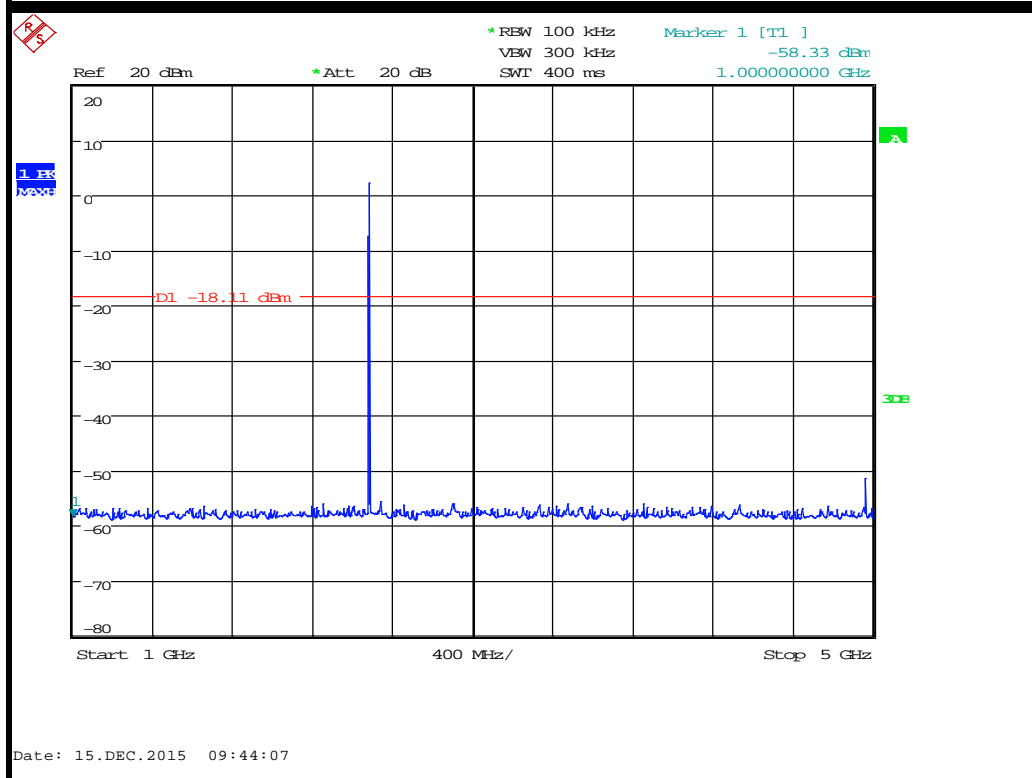
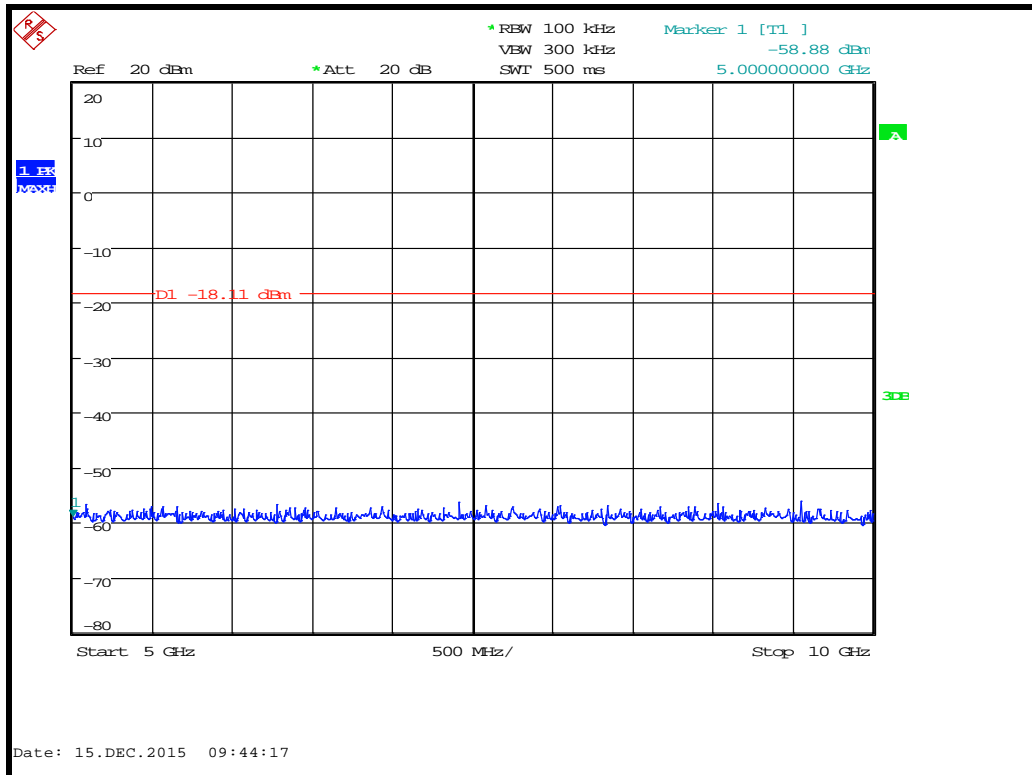

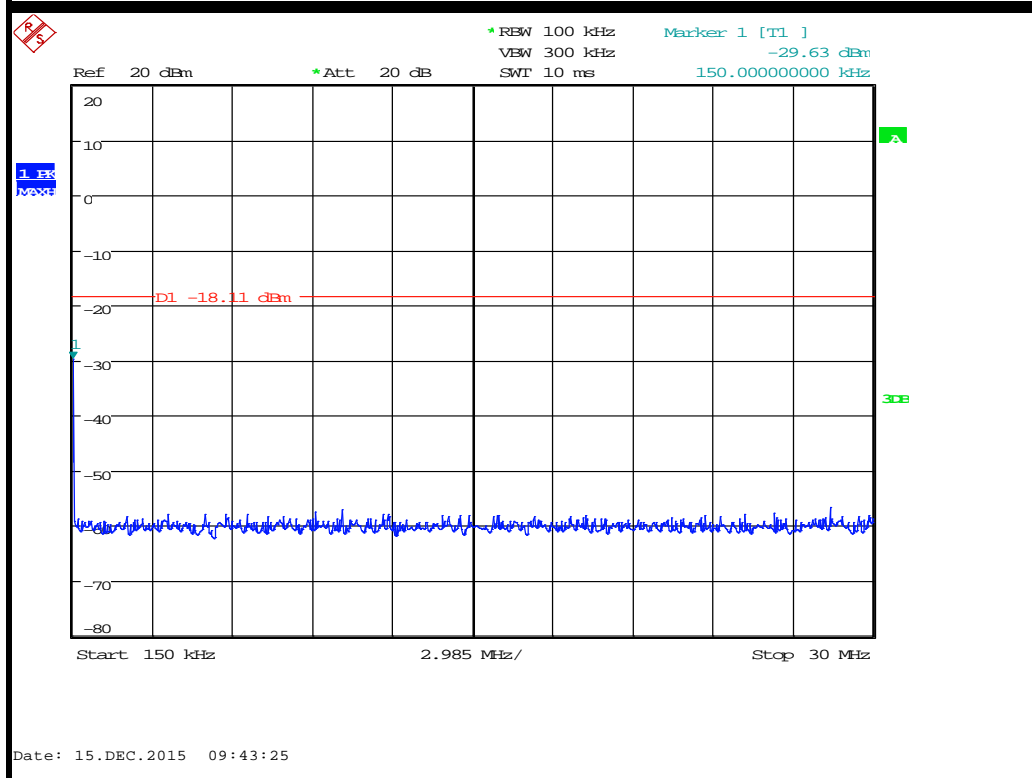
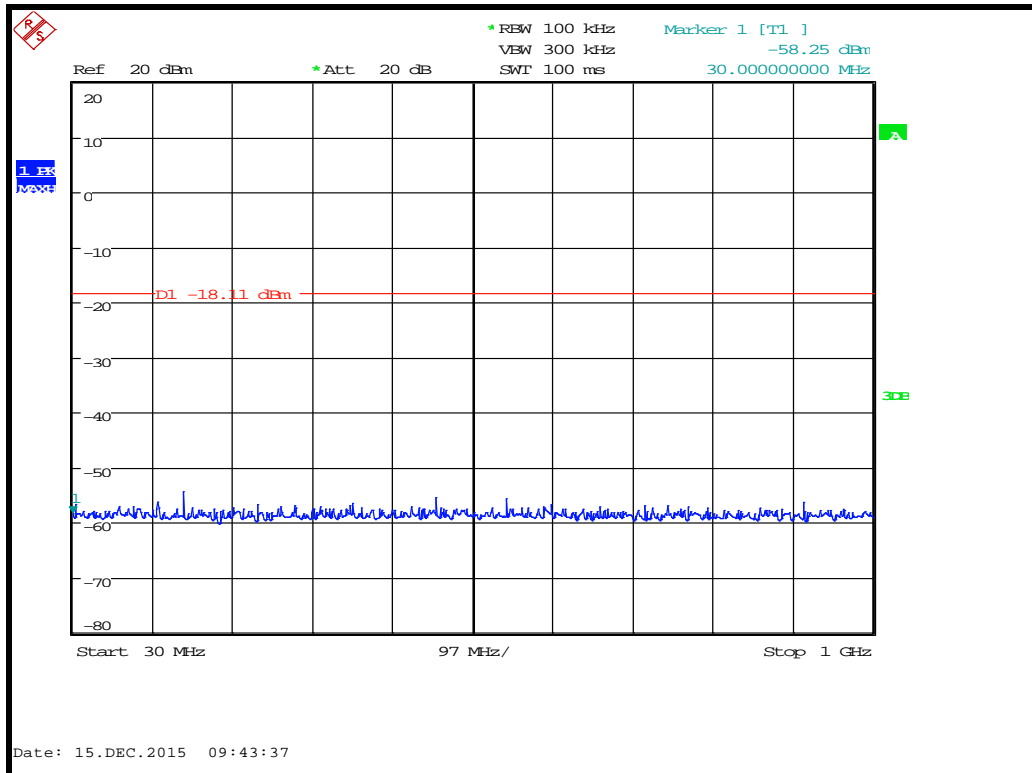

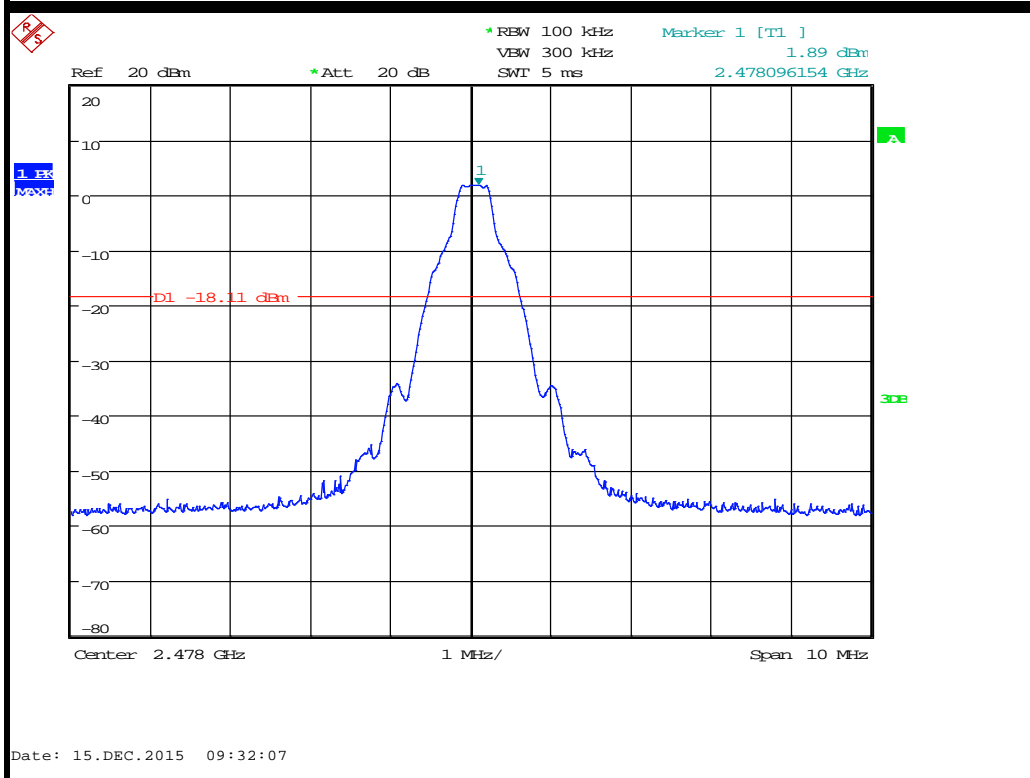
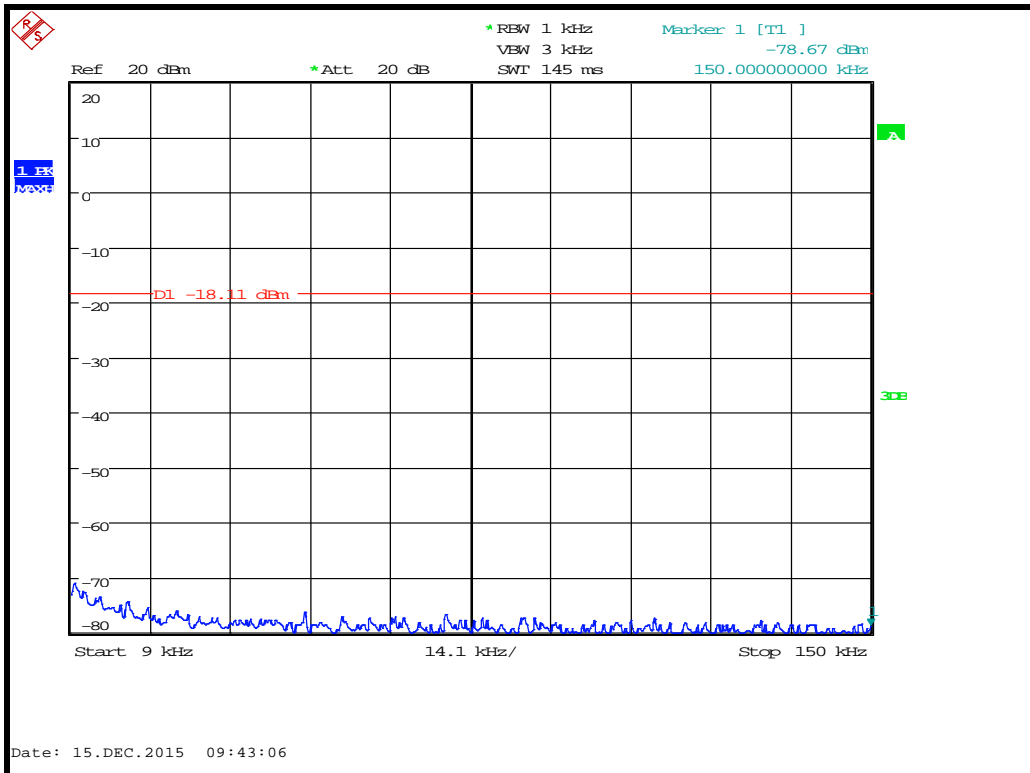

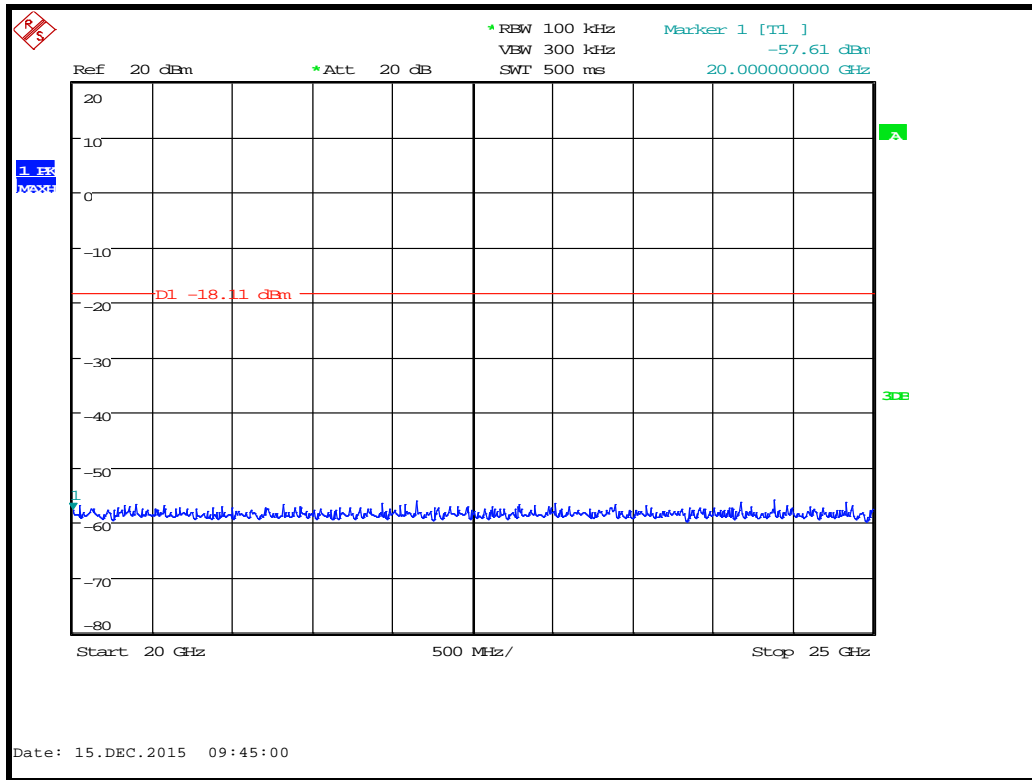

Modulation: 8DPSK; Data rate: 3Mbps; Power setting: -1						
Channel Frequency (MHz)	Emission Frequency (MHz)	Analyzer Level (dBm)	Emission Level (dBm)	Limit (dBm)	Margin (dB)	Result
All emissions were a minimum of 20 dB below the test limit						

CHO

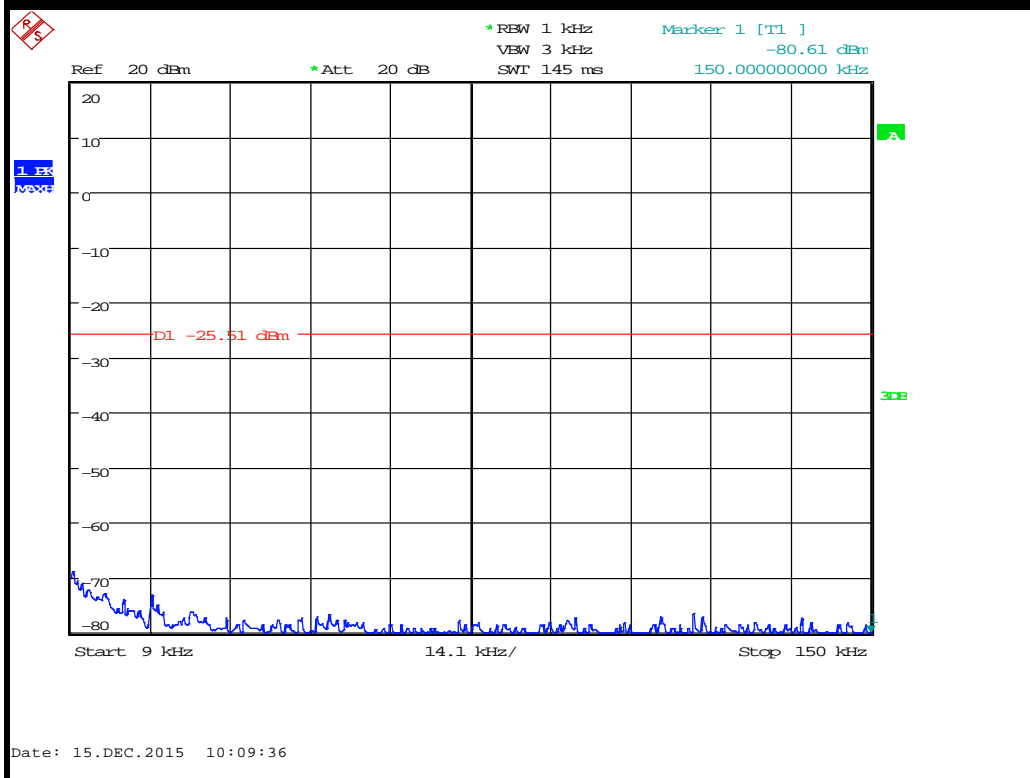
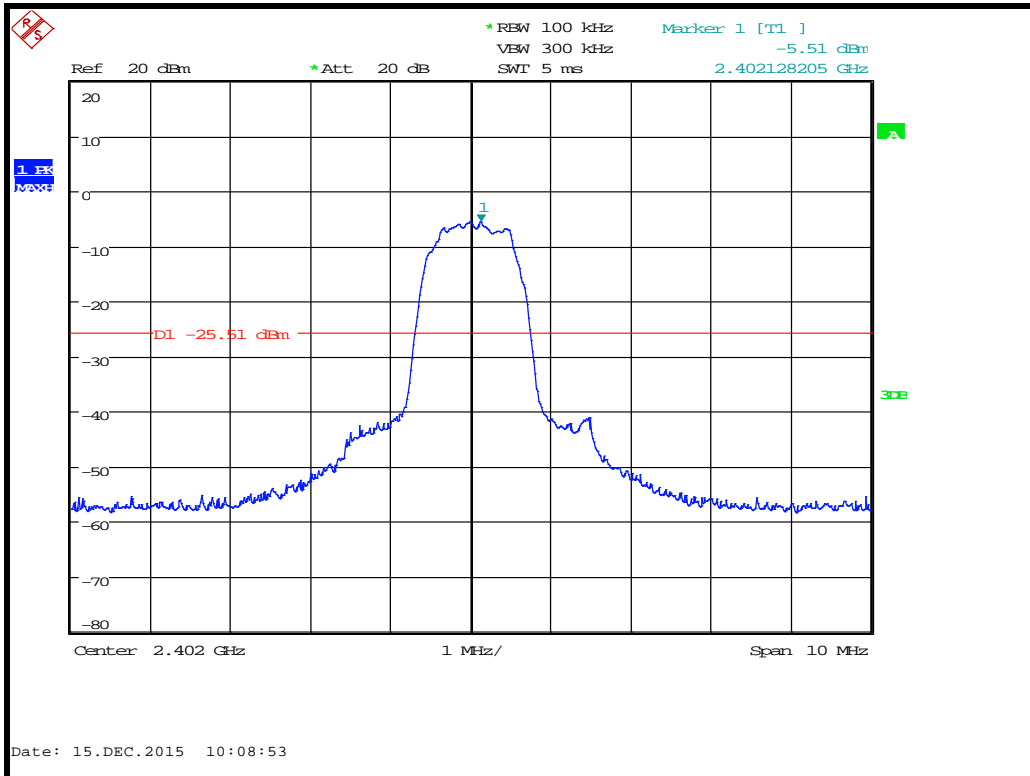

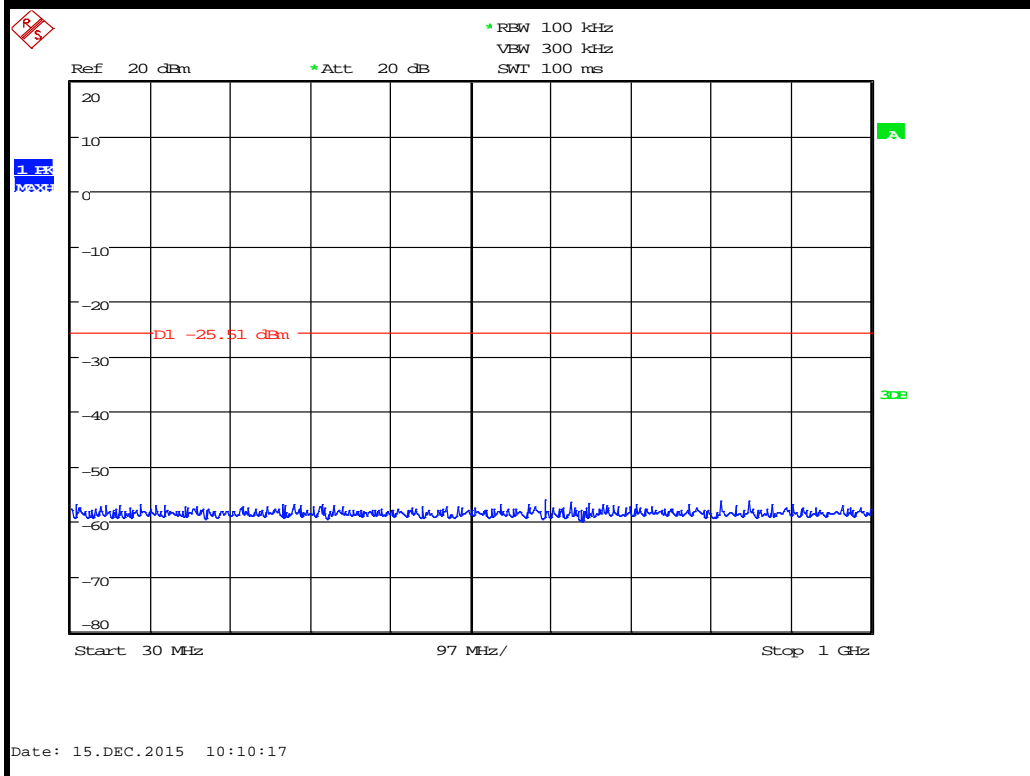
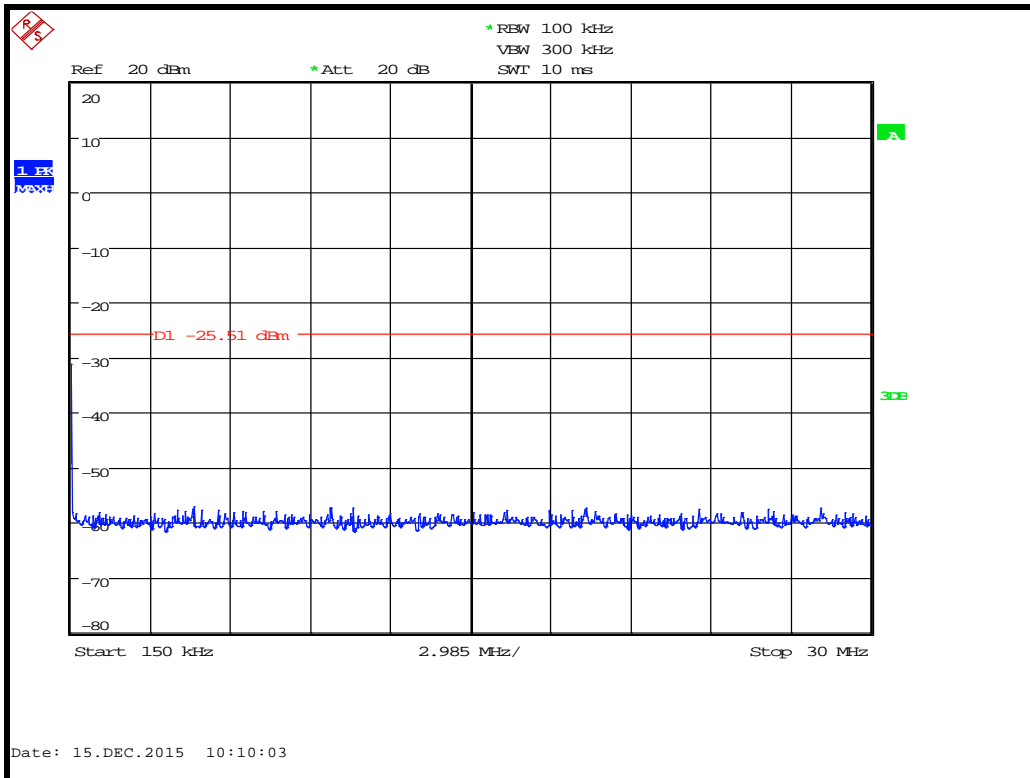

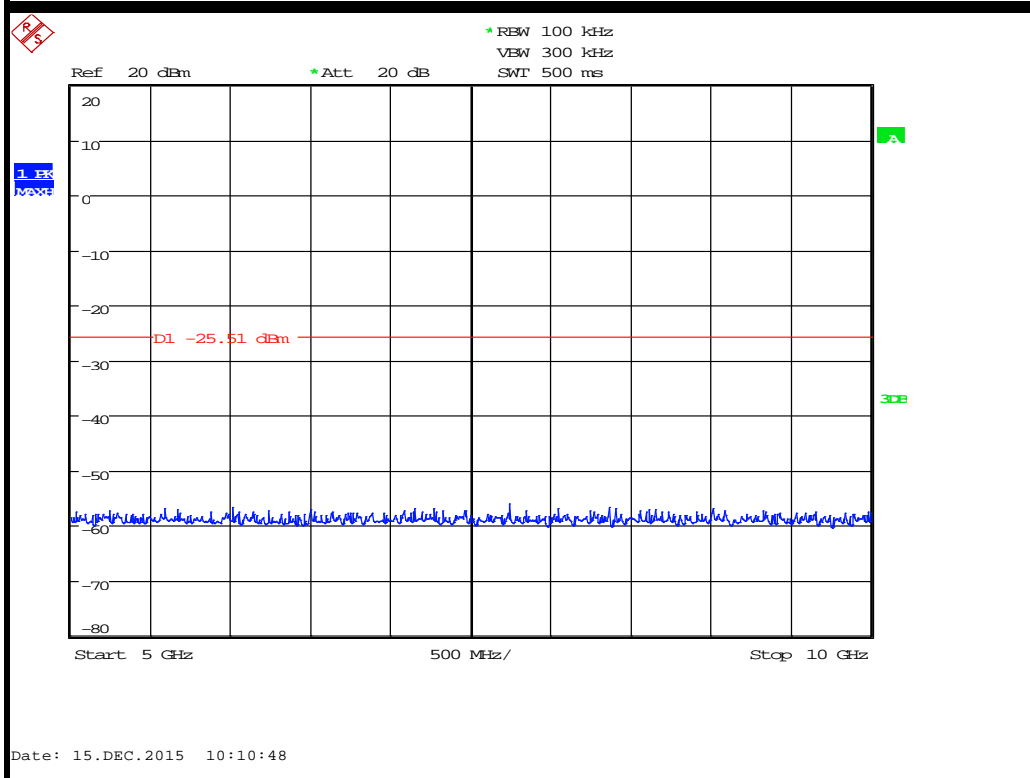
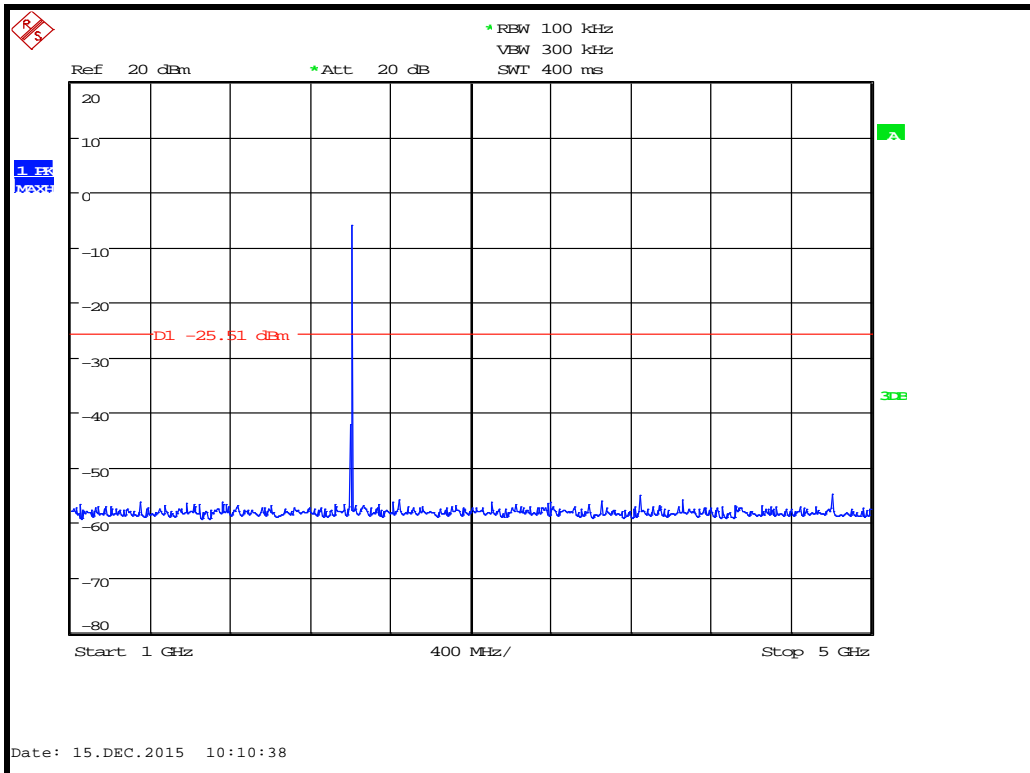

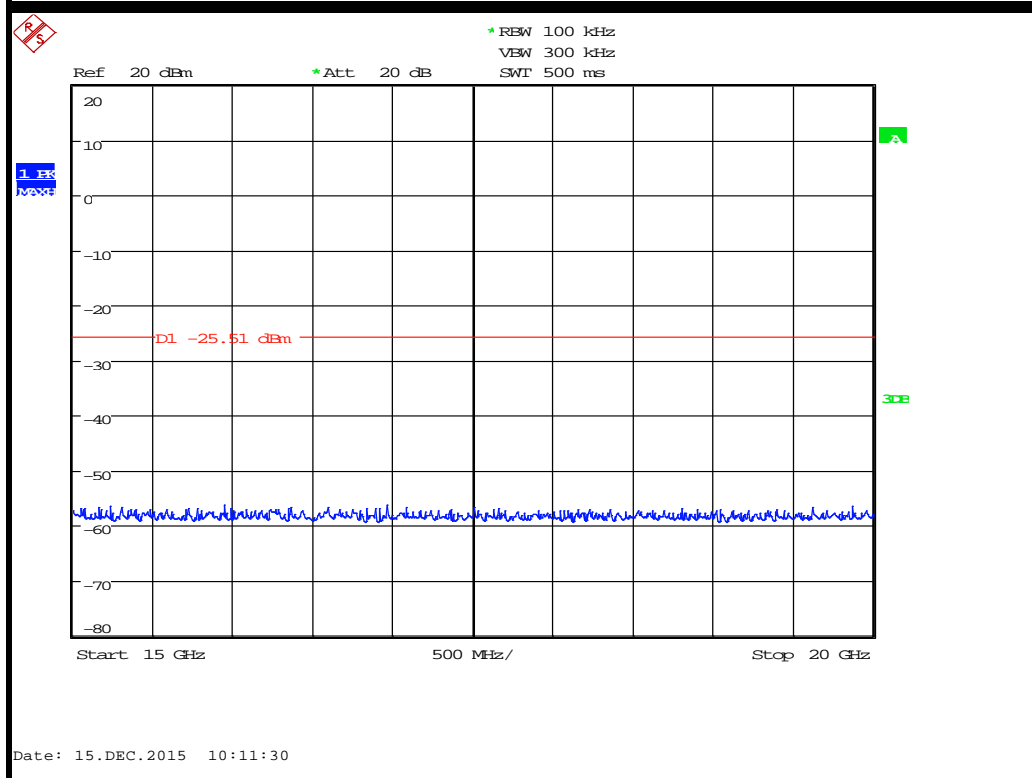
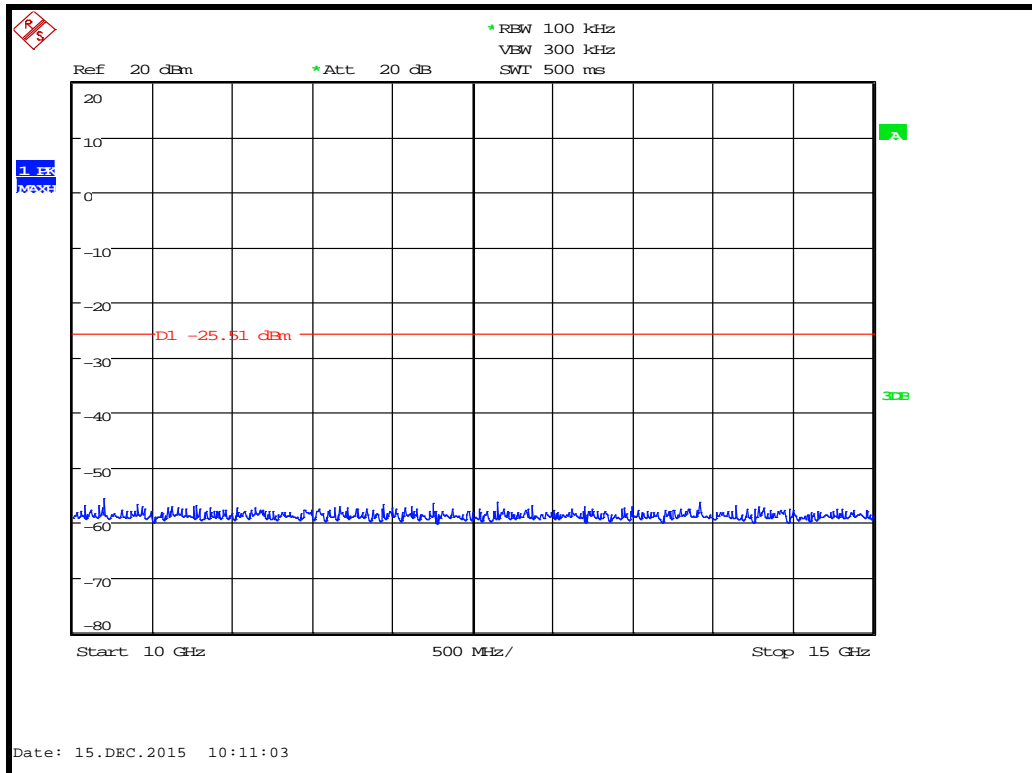

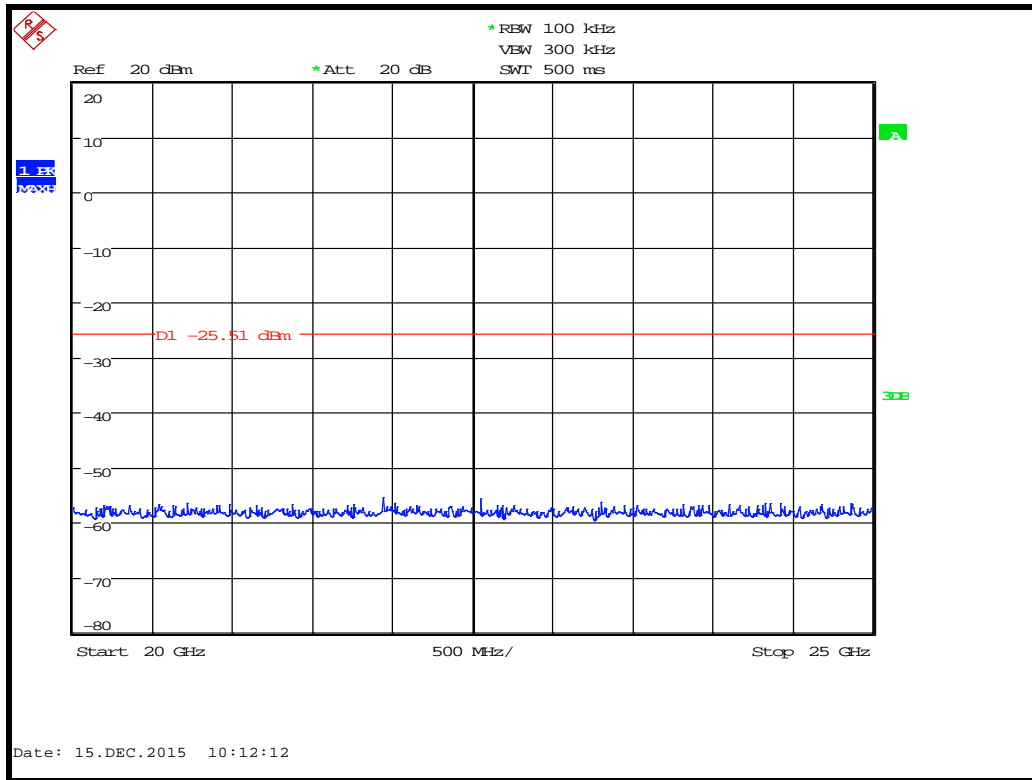

CH38

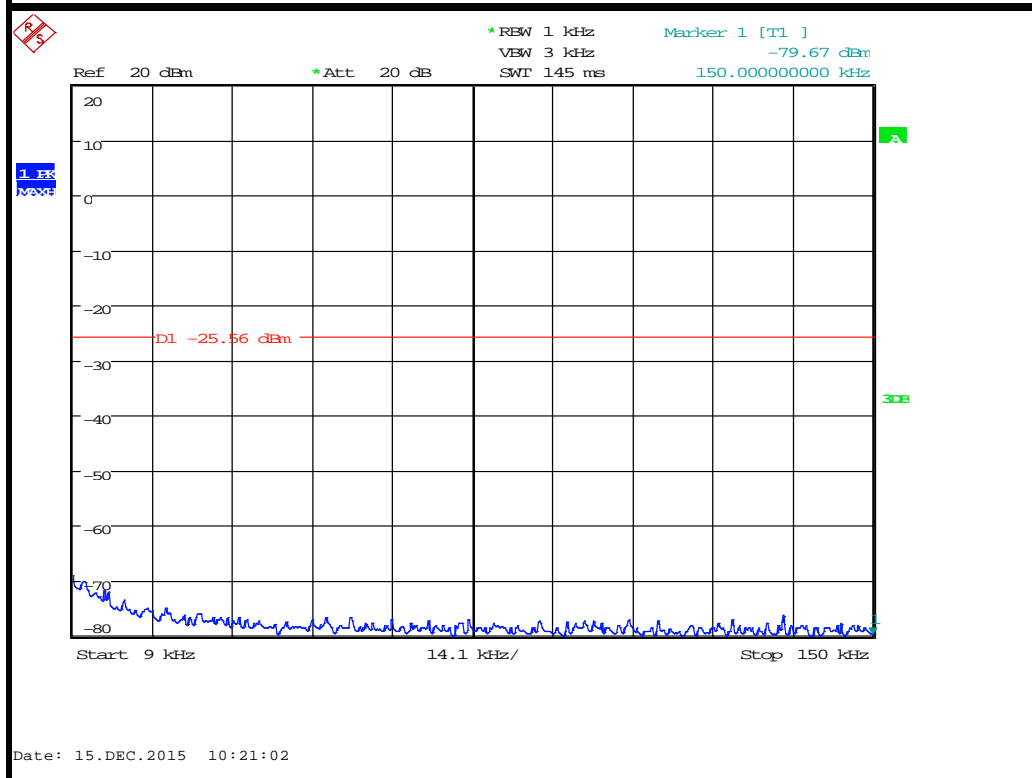
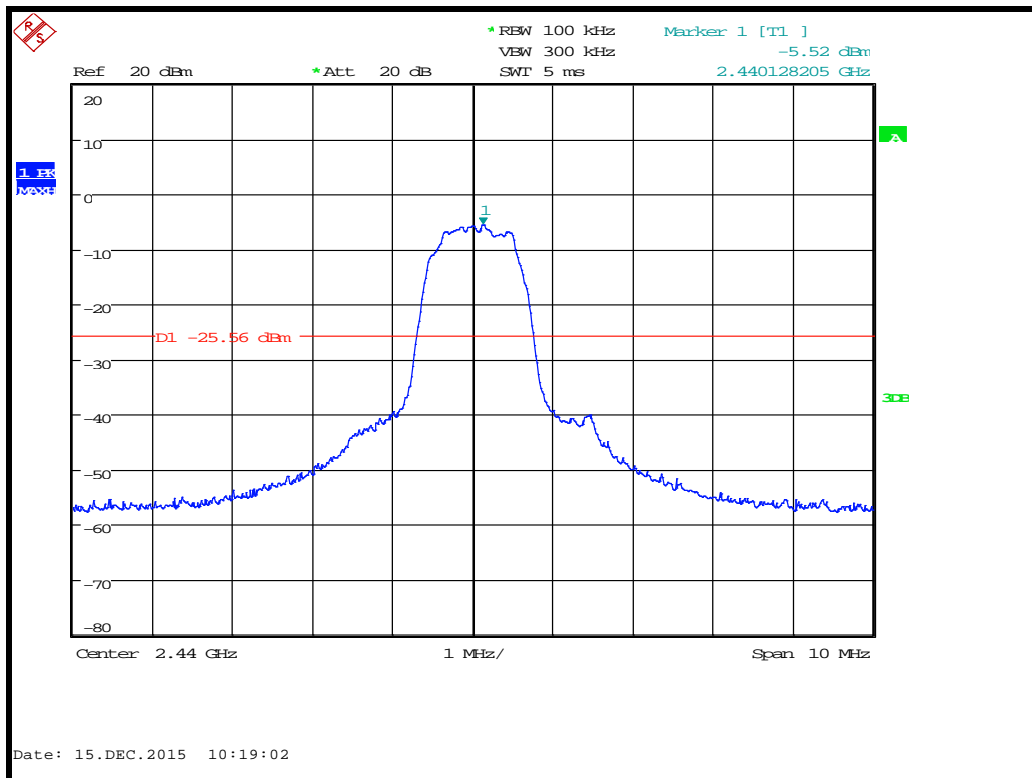

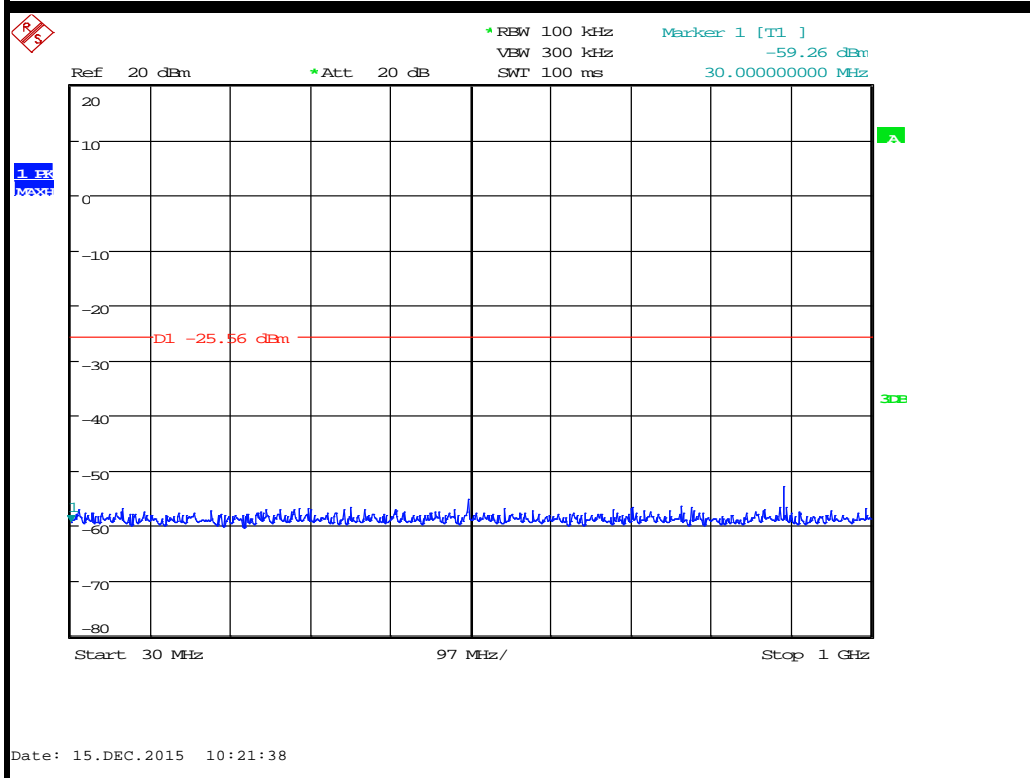
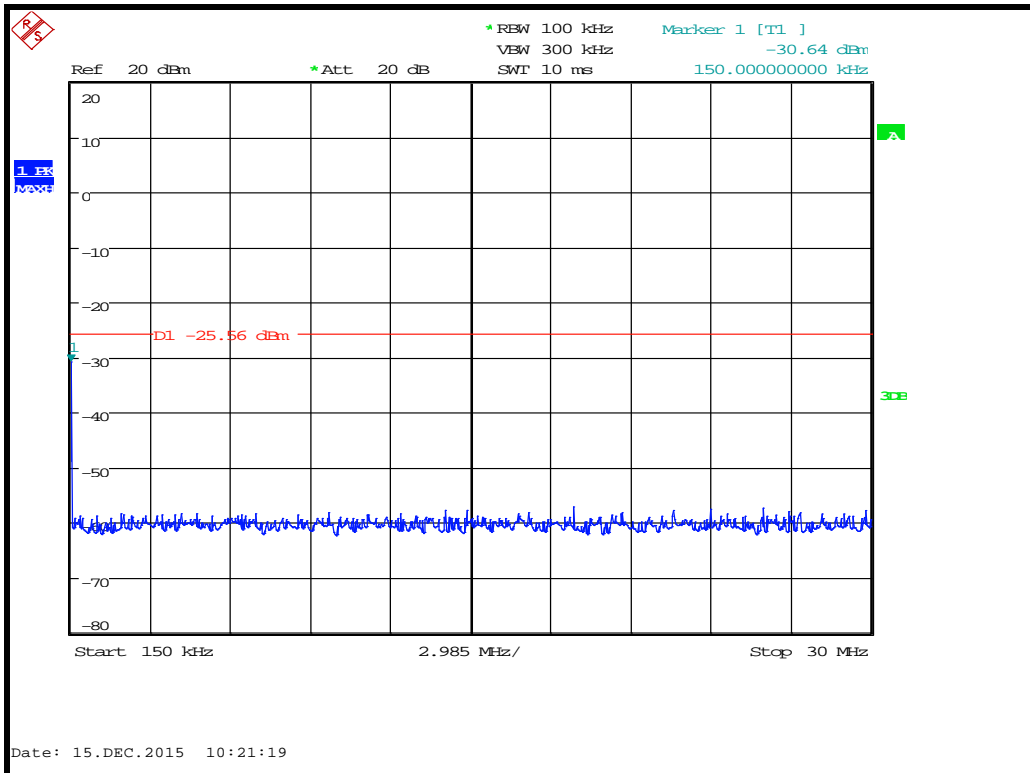

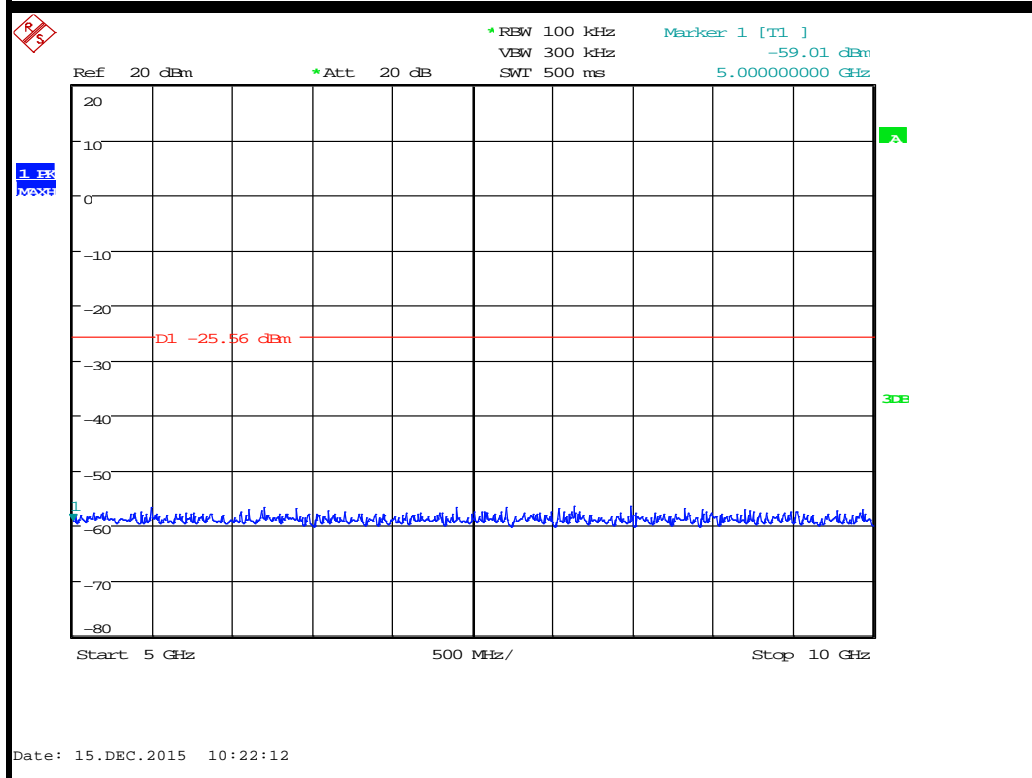
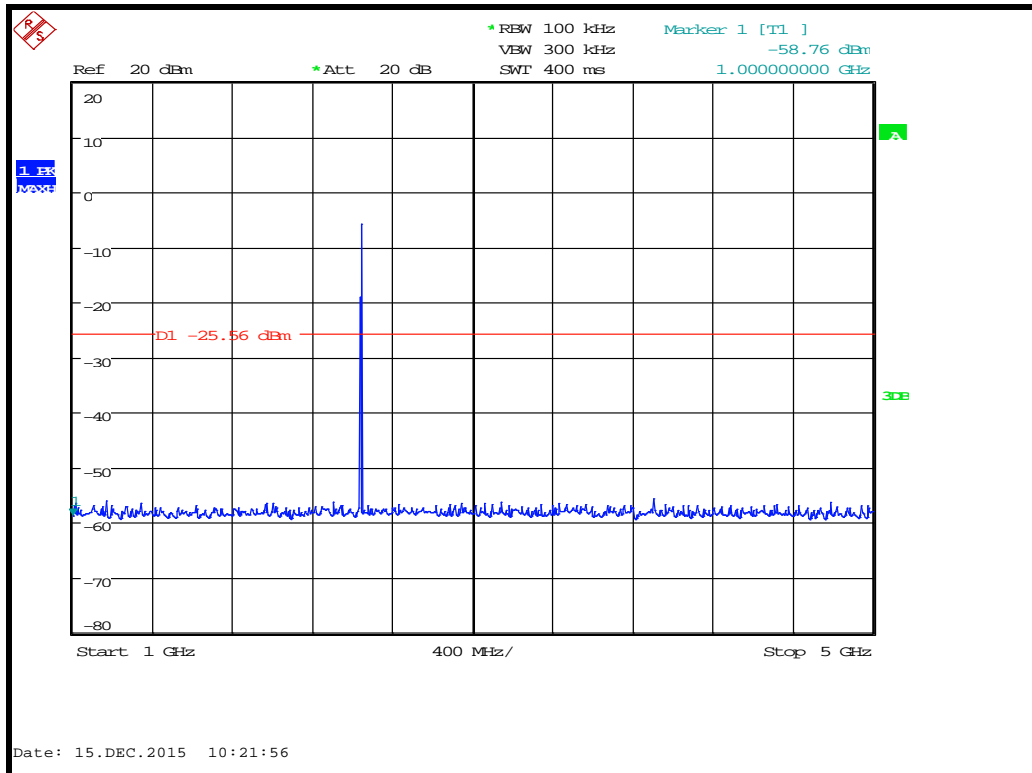

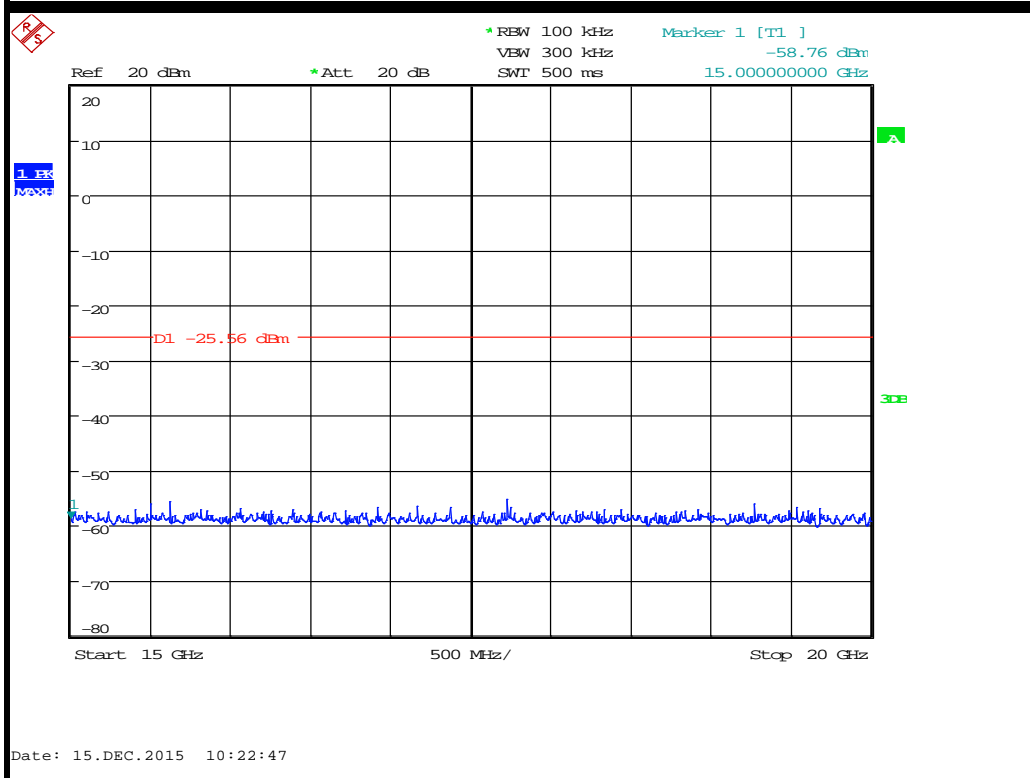
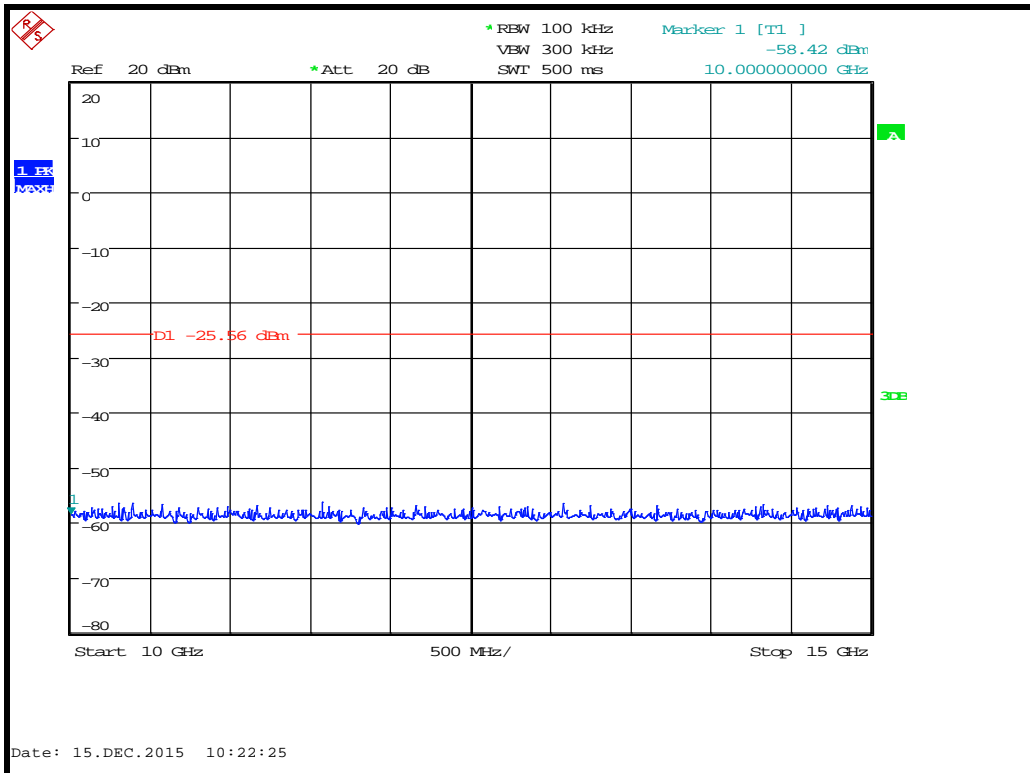

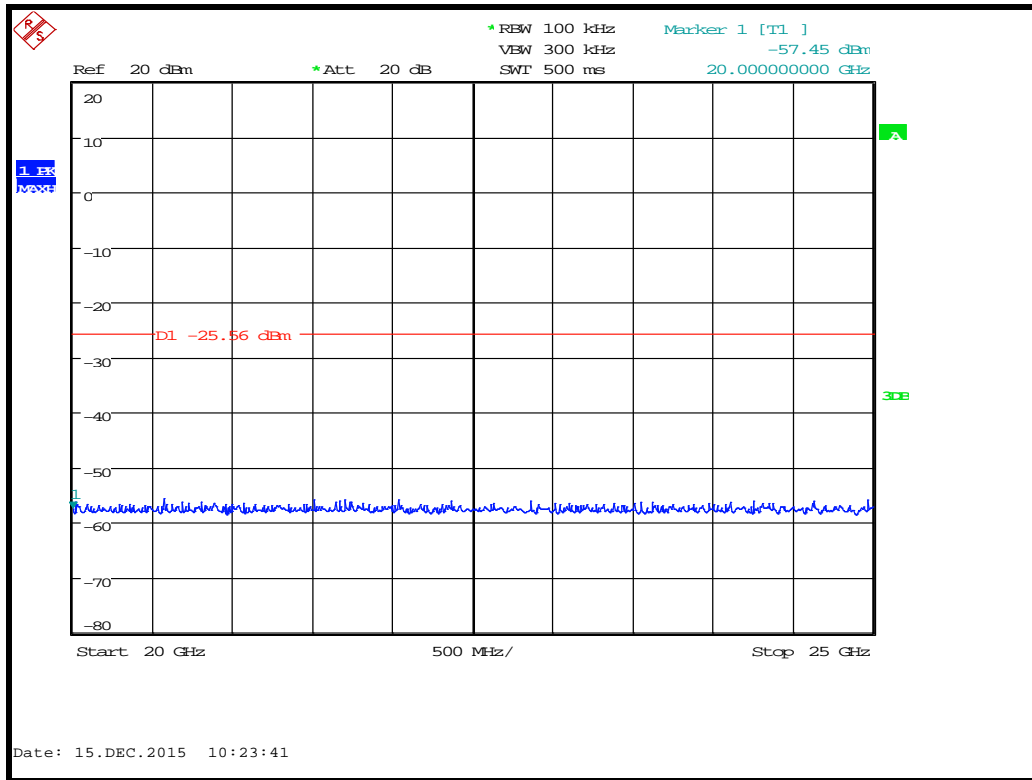

CH76

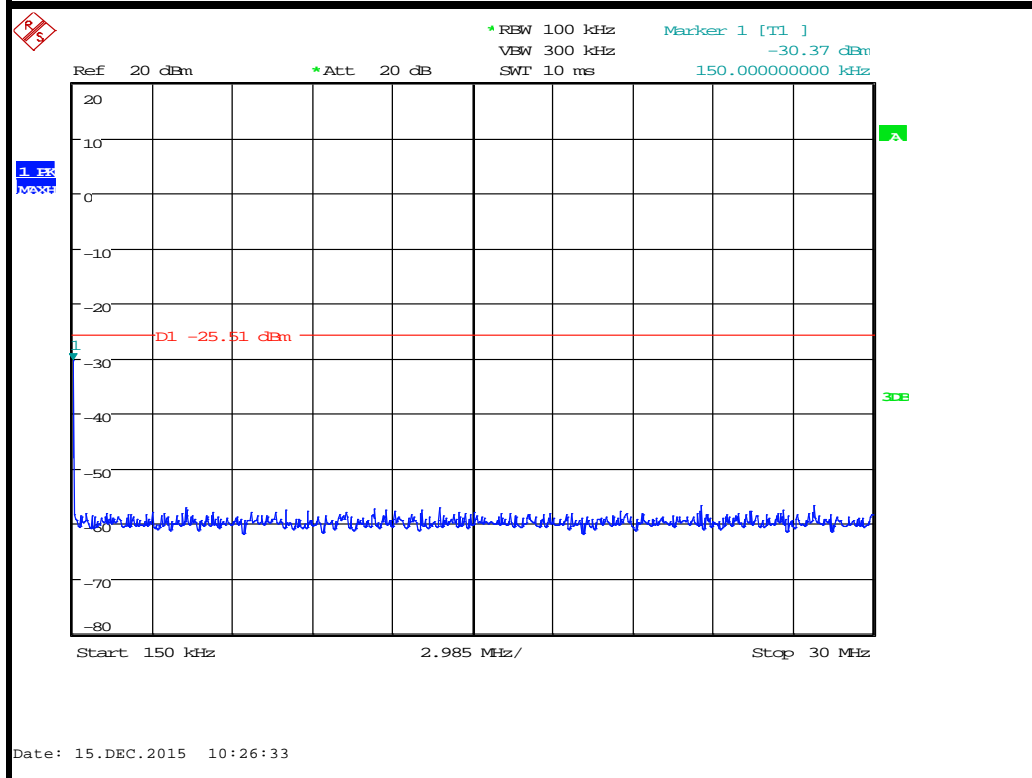
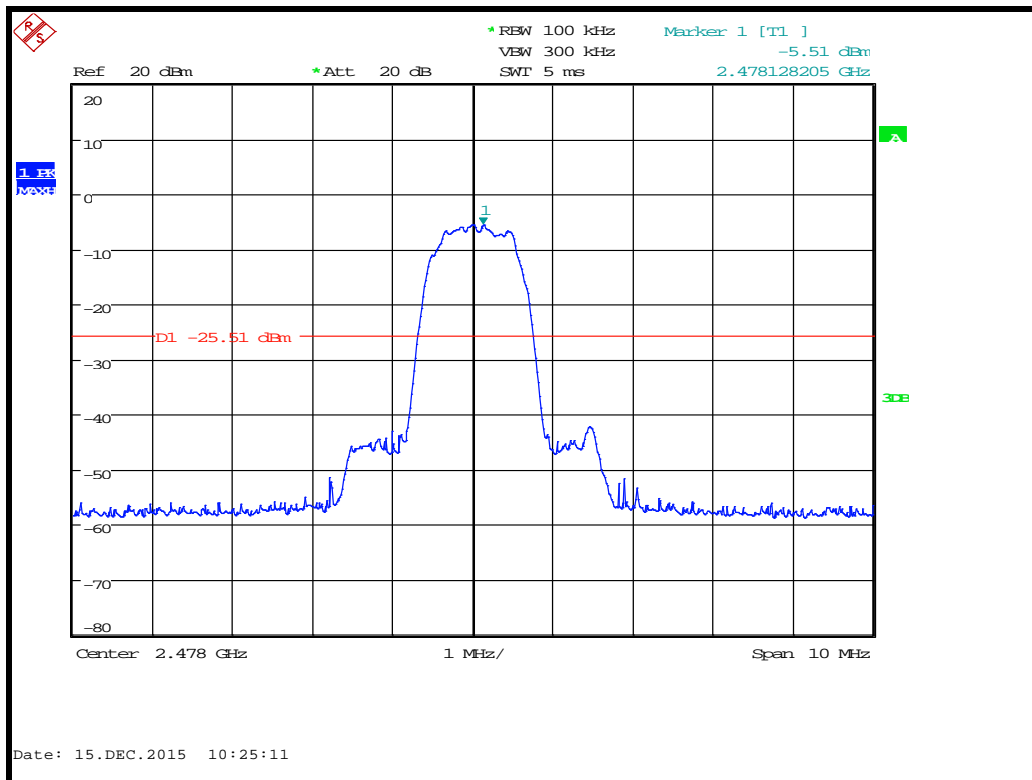

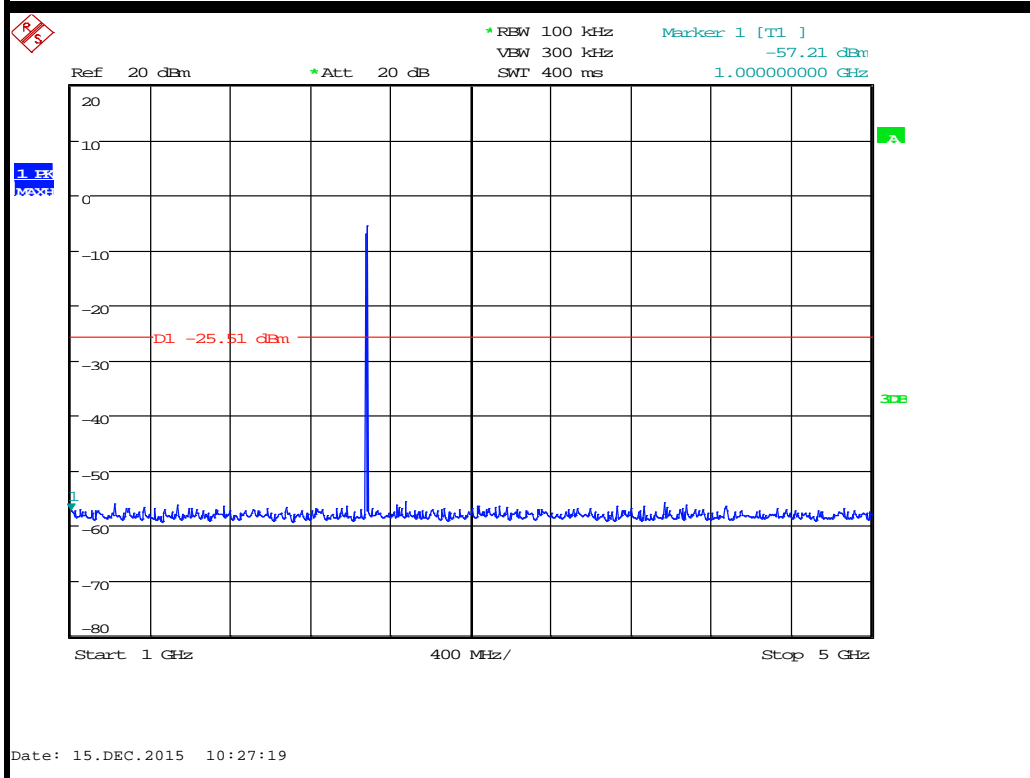
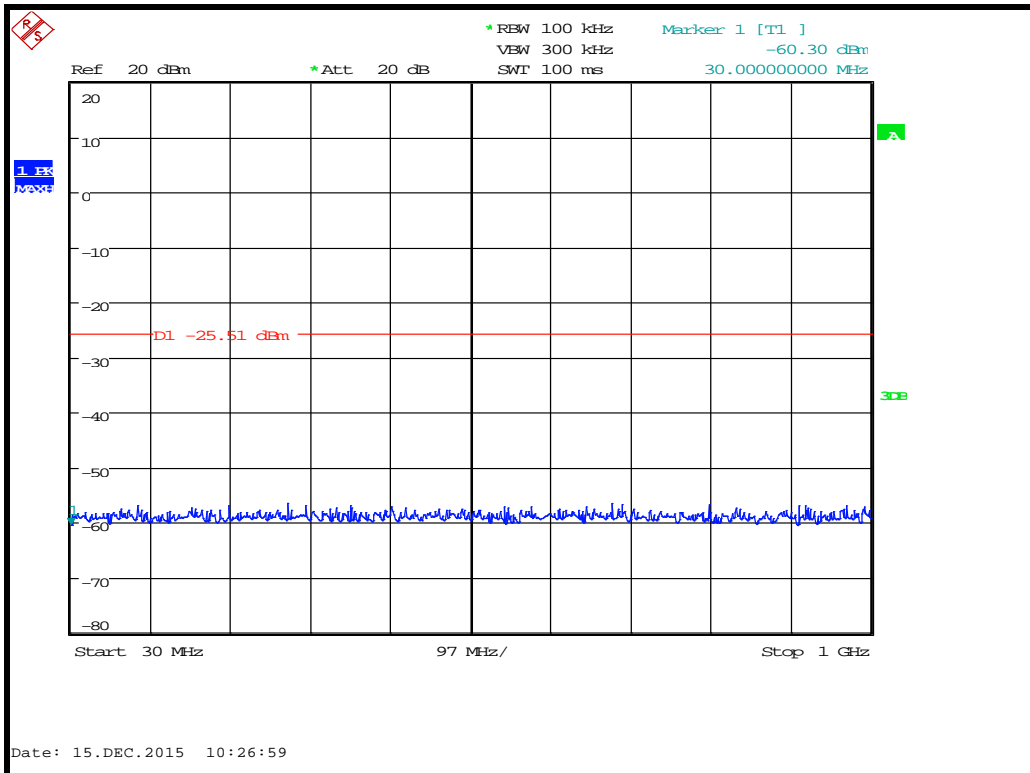

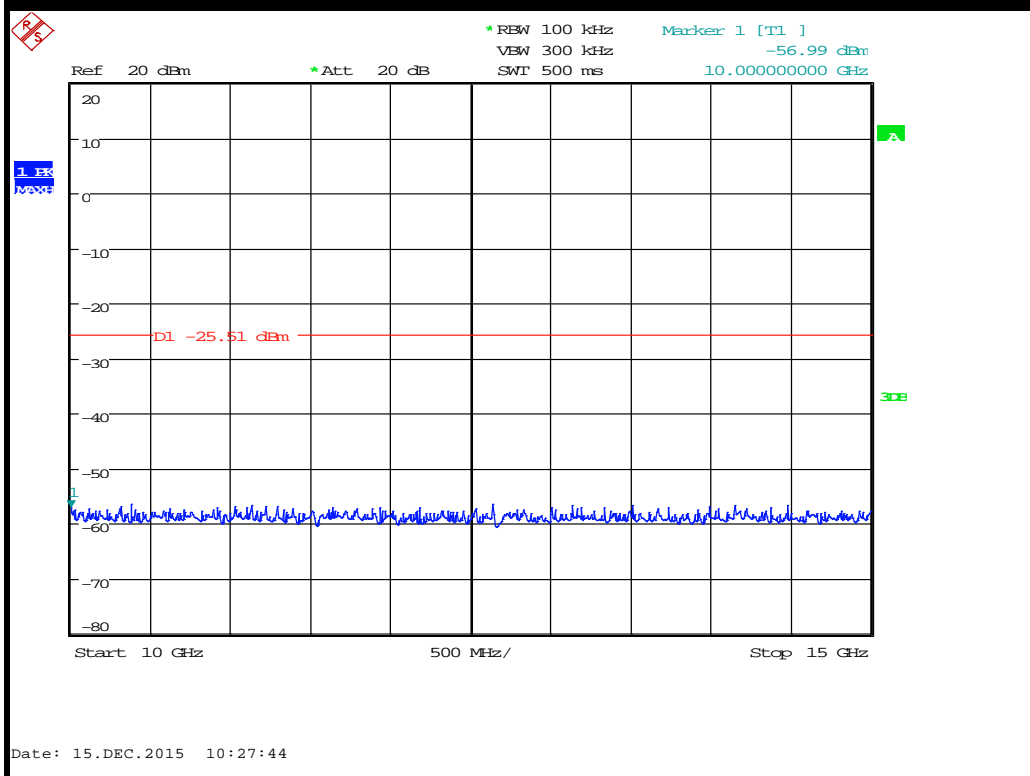
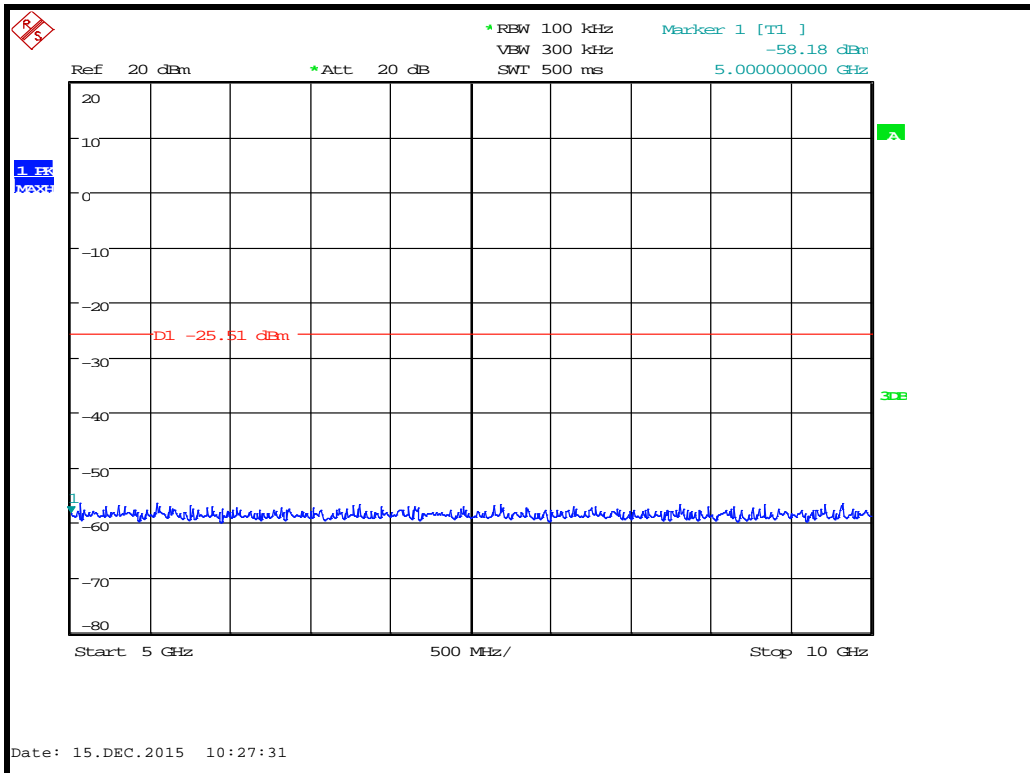

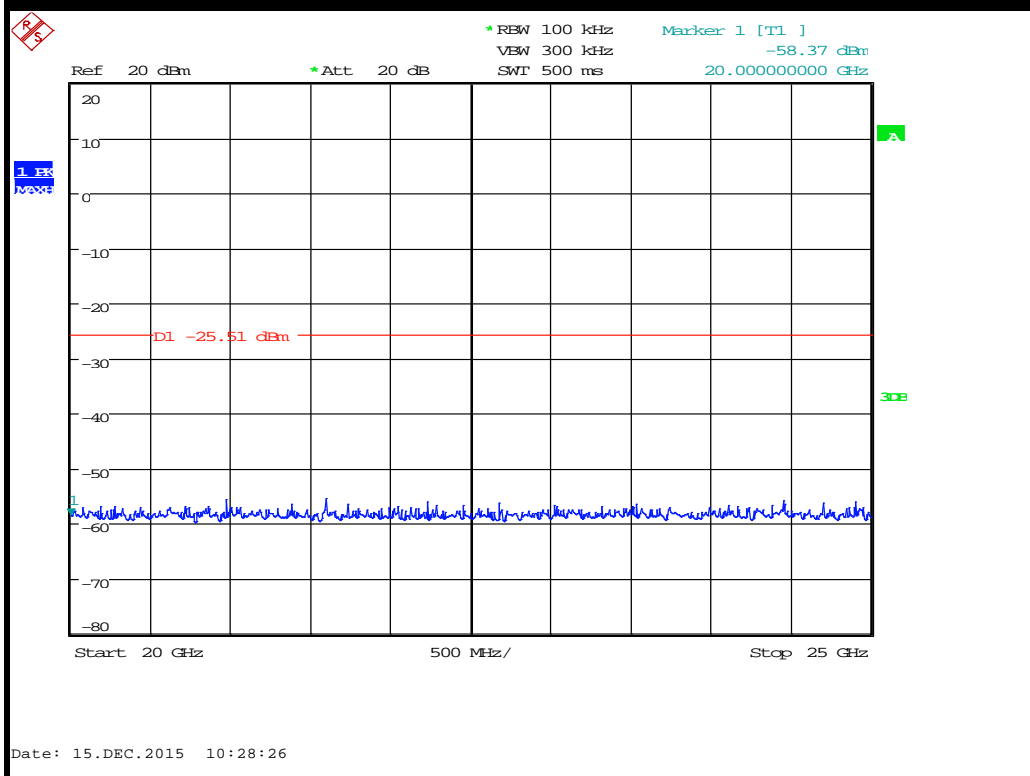
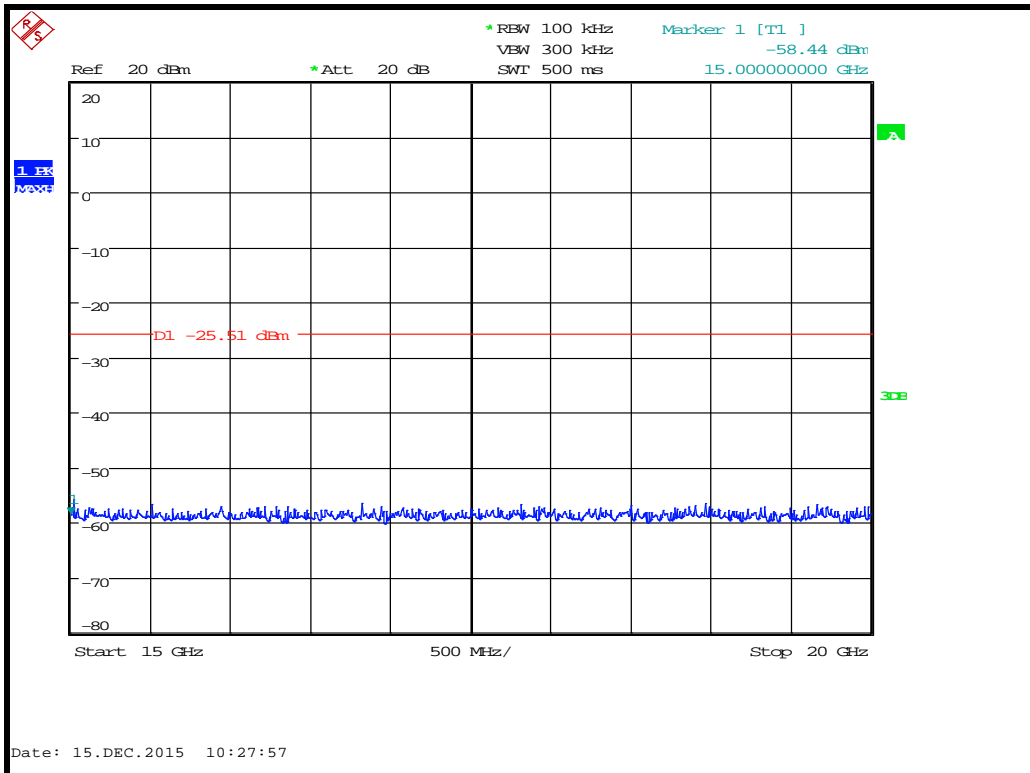

19 Radiated emissions – unintentional radiation / receiver emissions

19.1 Definitions

Receiver spurious emissions

The radio frequency signals generated within the receiver, which may cause interference to other equipment. This includes the period during which the equipment is scanning or switching channels.

Unintentional radiator

A device that generates RF energy which is not intended to be radiated for reception by a radio receiver.

19.2 Test Parameters

Test Location:	Element Hull
Test Chamber:	Lab 16 / Lab10
Test Standard and Clause:	ANSI C63.10-2013, Clause 6.5 and 6.6
EUT Channels / Frequencies Measured:	Low / Mid / High
EUT Channel Bandwidths:	1 MHz
Deviations From Standard:	None
Measurement BW:	30 MHz to 1 GHz: 120 kHz Above 1 GHz: 1 MHz
Measurement Detector:	Up to 1 GHz: quasi-peak Above 1 GHz: Peak

Environmental Conditions (Normal Environment)

Temperature: 19 °C	+15 °C to +35 °C (as declared)
Humidity: 55 % RH	20 % RH to 75 % RH (as declared)
Supply: 110 V ac	110 V ac ±10 % (as declared)

19.3 Test Limit

Note:

Only radio communication receivers operating in stand-alone mode within the band 30 to 960 MHz, as well as scanner receivers, are subject to requirements, as described above. All other receivers are exempted from any certification, testing, labelling and reporting requirements.

However, all receivers in all frequency bands shall comply with the limits set forth in FCC 47CFR15B / IC RSS-Gen even in cases where testing, reporting and/or certification are not required.

Receiver Radiated Limits

<i>Frequency (MHz)</i>	<i>Field Strength (μV/m at 3 m)</i>
30 to 88	100
88 to 216	150
216 to 960	200
Above 960	500

19.4 Test Method

With the EUT setup as per section 9 of this report and connected as per Figure viii, the emissions from the EUT were measured on a spectrum analyzer / EMI receiver. The EUT was rotated in three orthogonal planes and the measurement antenna height scanned (below 1 GHz, from 1 to 4 m; above 1 GHz as necessary) in order to maximise emissions.

The measurements were performed with EUT set at its maximum duty. All modulation schemes, data rates and power settings were used to observe the worst-case configuration at each frequency.

Pre-scan plots are shown with a peak detector and 100 kHz RBW.

Figure viii Test Setup

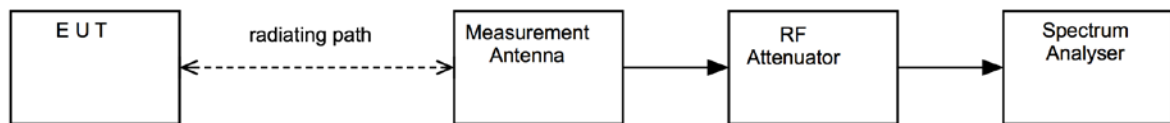

19.5 Test Set-up Photograph

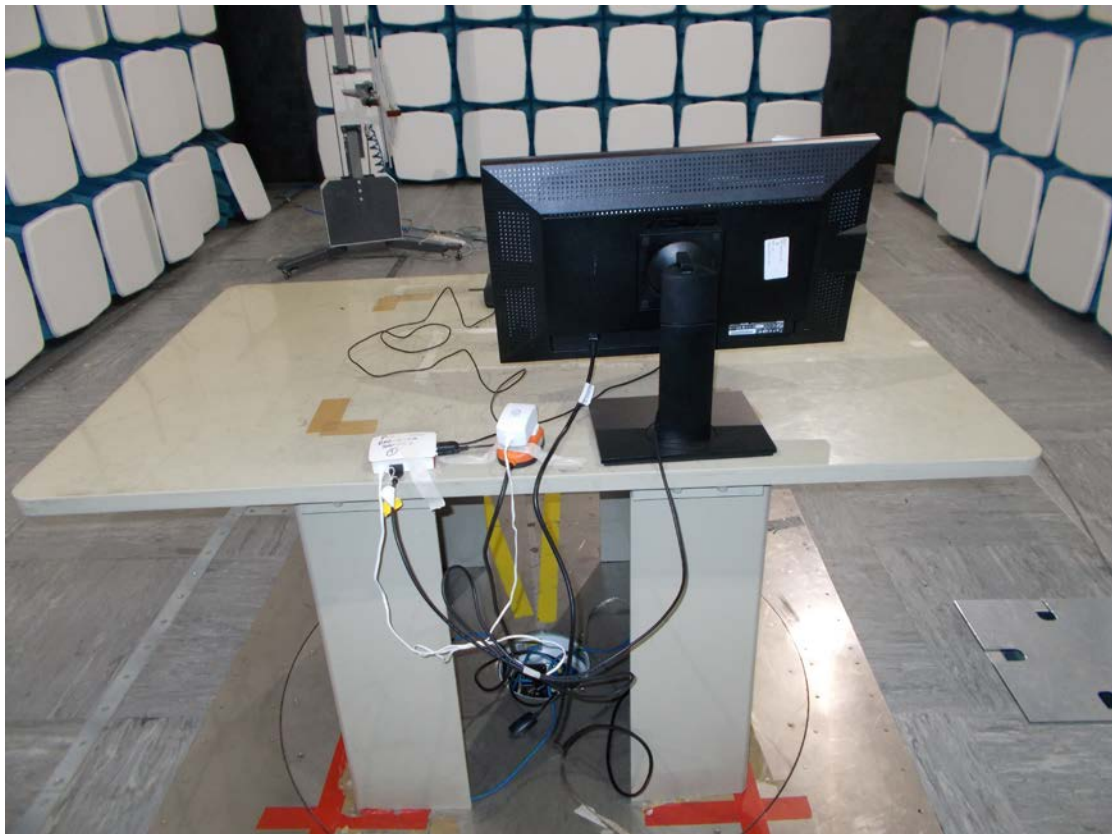

19.6 Test Equipment

Equipment Type	Manufacturer	Equipment Description	Element No	Due For Calibration	Calibration Interval (m)
ATS	Rainford	Ferrite Lined Chamber	REF886	21/07/2016	12
FSU46	R&S	Spectrum Analyser	REF910	28/05/2016	12
310	Sonoma	Pre-Amp (9kHz – 1GHz)	REF927	01/07/2016	12
8449B	Agilent	Pre-Amp (1 – 26.5GHz)	REF913	05/02/2016	12
3109	EMCO	Biconical Antenna	RFG095	09/05/2016	24
3146	EMCO	Log Periodic Antenna	RFG191	09/05/2016	24
3115	EMCO	Horn Antenna	RFG129	05/02/2016	24
	Q-Par	Horn Antenna	RFG629	30/09/2017	24

19.7 Test Results

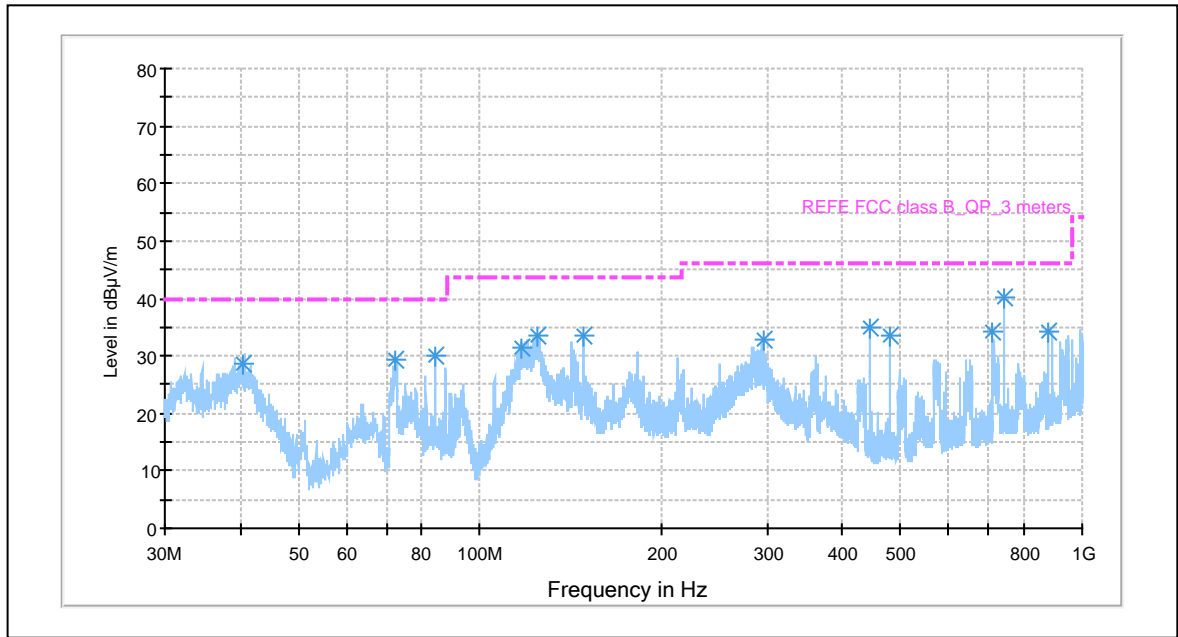

Bluetooth Channel 0 : 30 MHz to 1 GHz

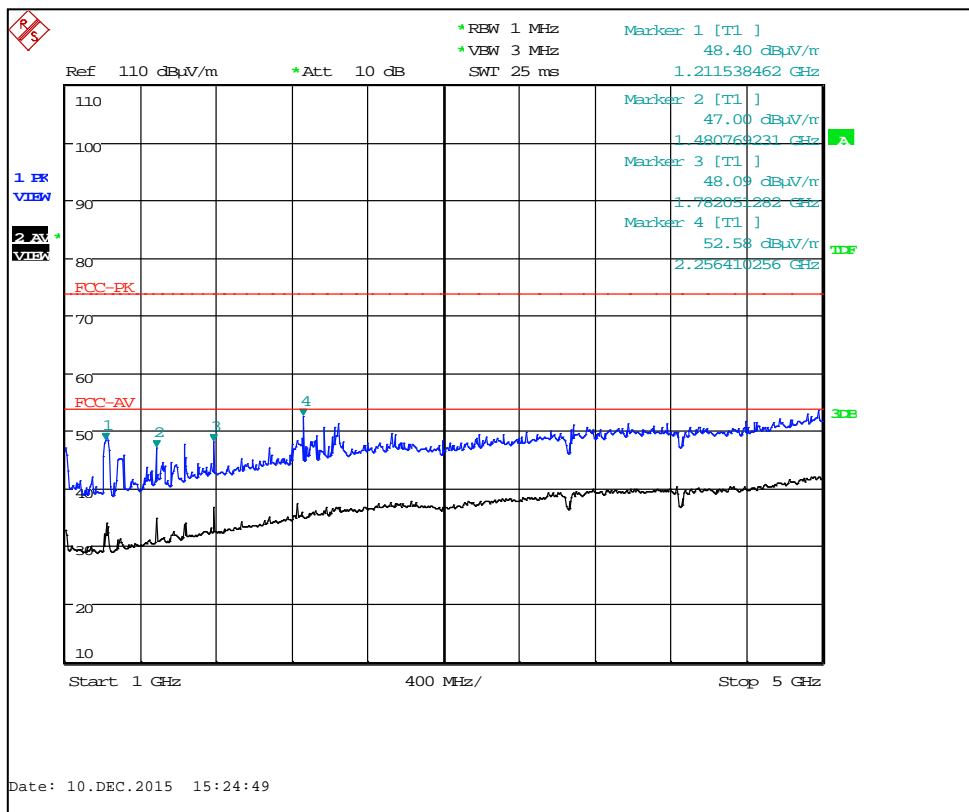

Bluetooth Channel 0 : 1 GHz to 5 GHz

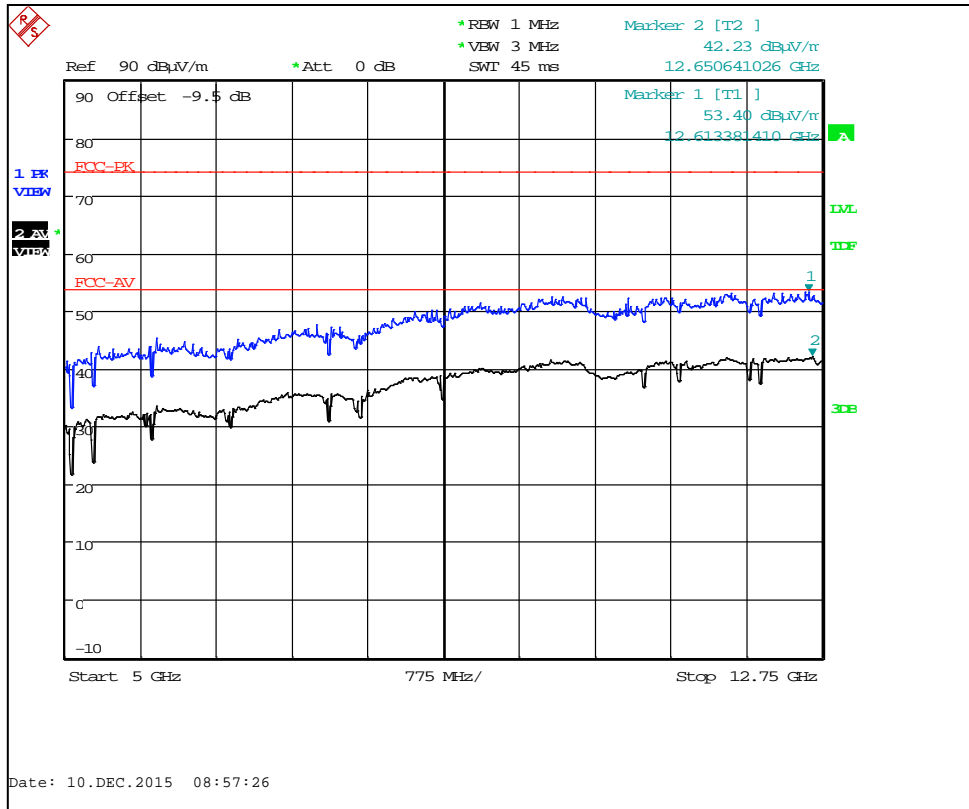

Bluetooth Channel 0 : 5 GHz to 12.75 GHz

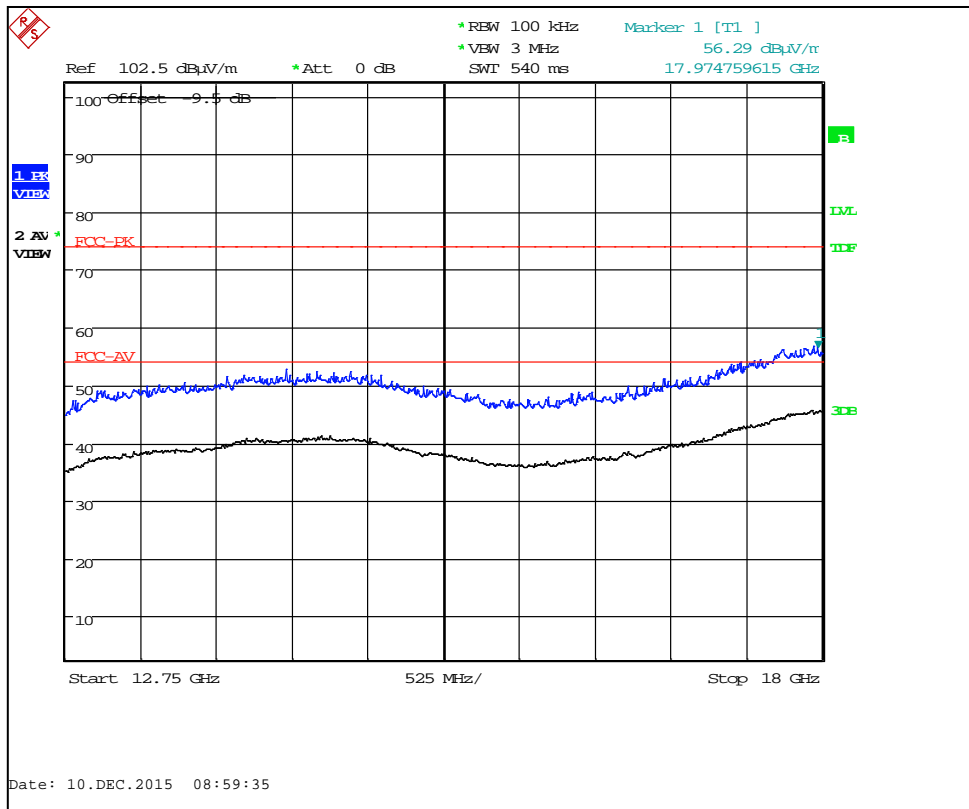

Bluetooth Channel 0 : 12.75 GHz to 18 GHz

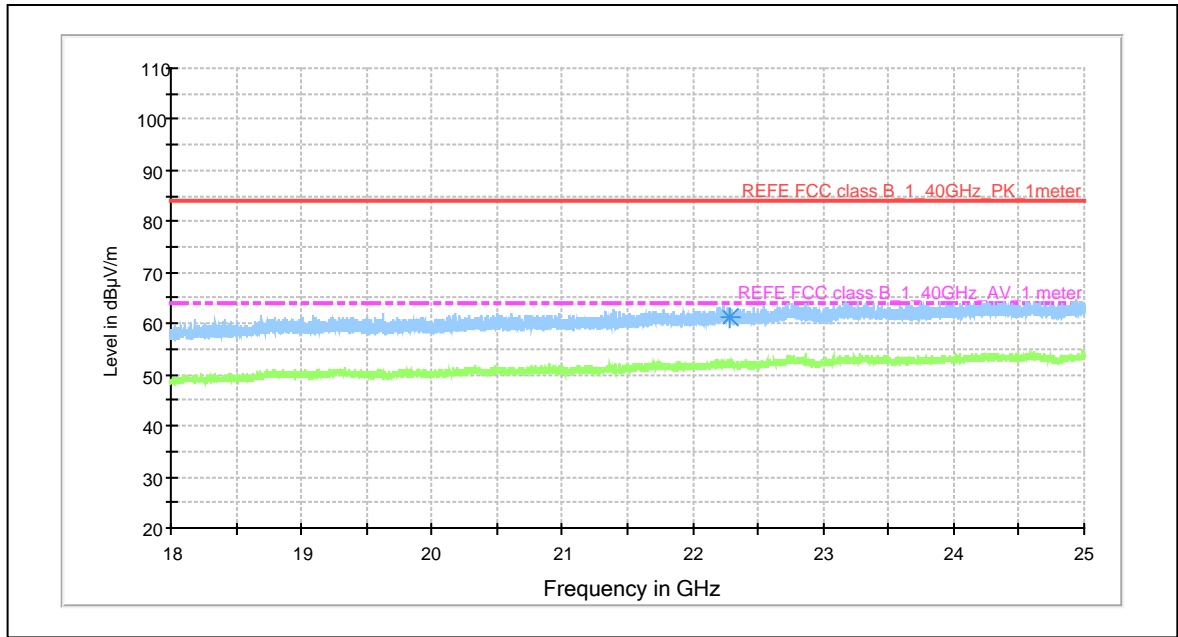

Bluetooth Channel 0 : 18 GHz to 25 GHz

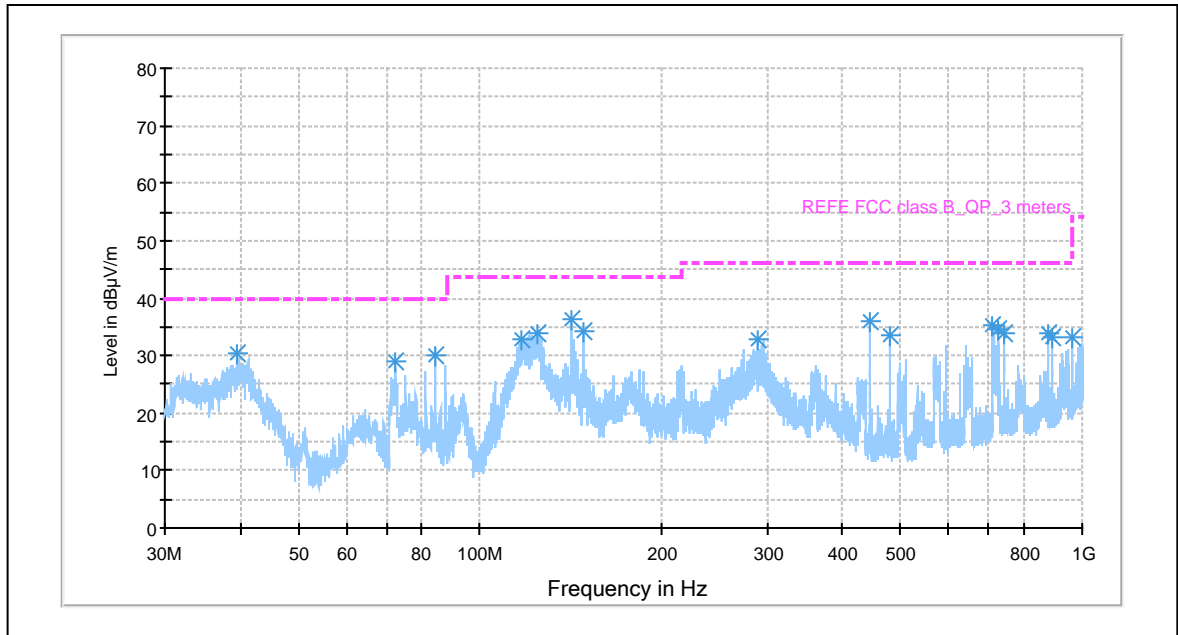

Bluetooth Channel 38 : 30 MHz to 1 GHz

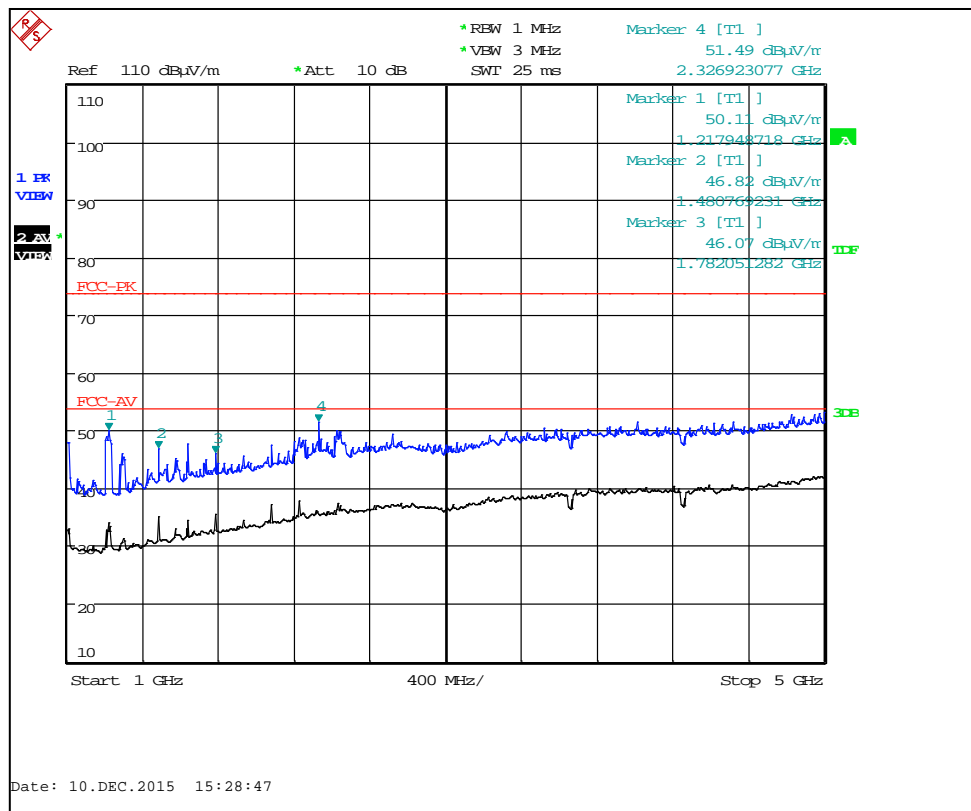

Bluetooth Channel 38 : 1 GHz to 5 GHz

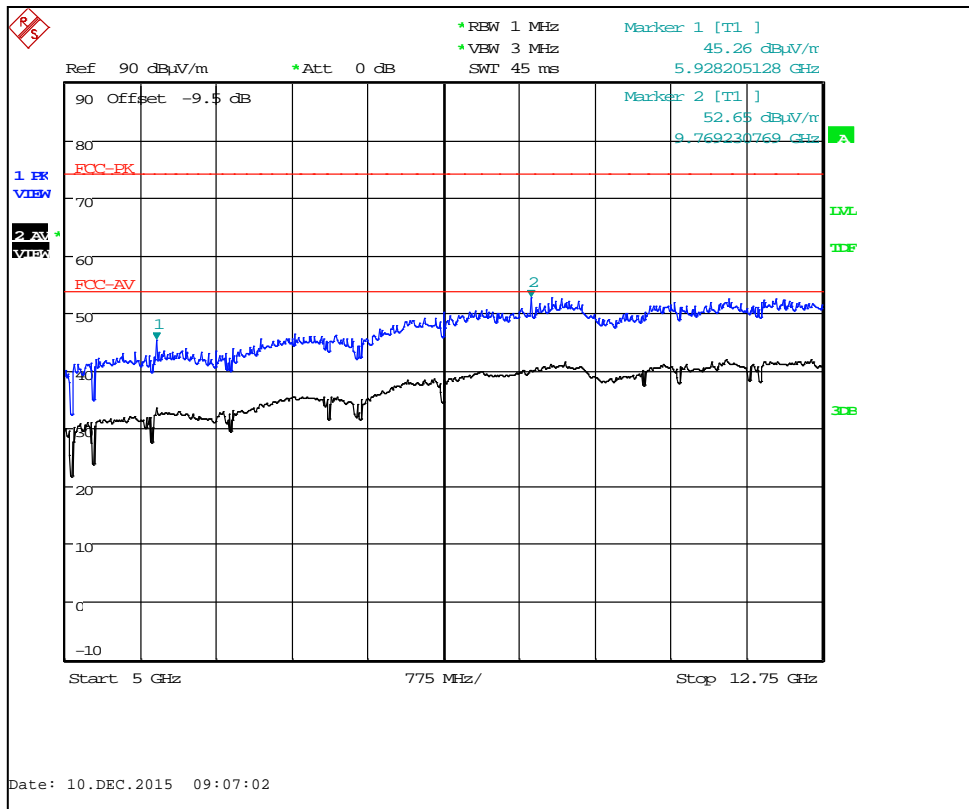

Bluetooth Channel 38 : 5 GHz to 12.75 GHz

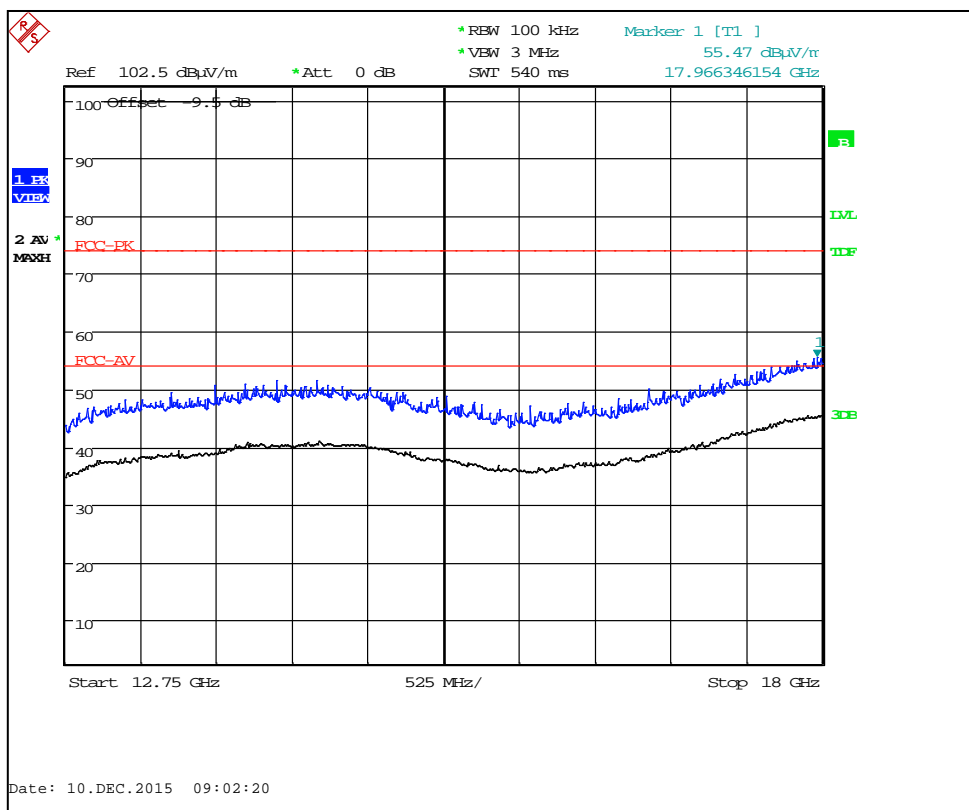

Bluetooth Channel 38 : 12.75 GHz to 18 GHz

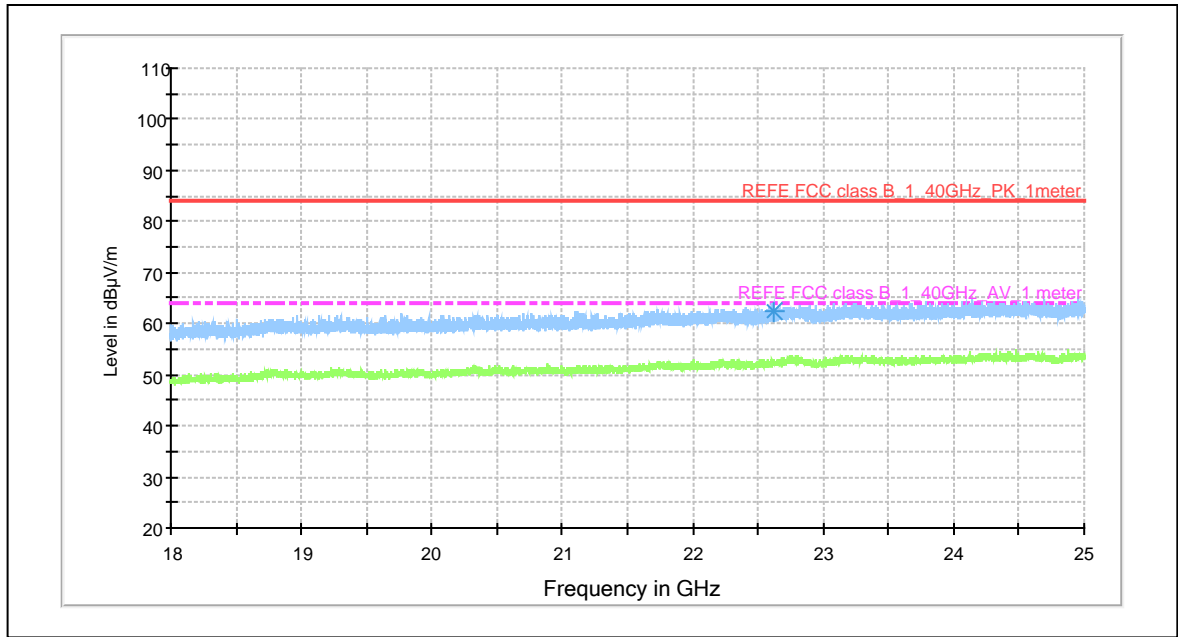

Bluetooth Channel 38 : 18 GHz to 25 GHz

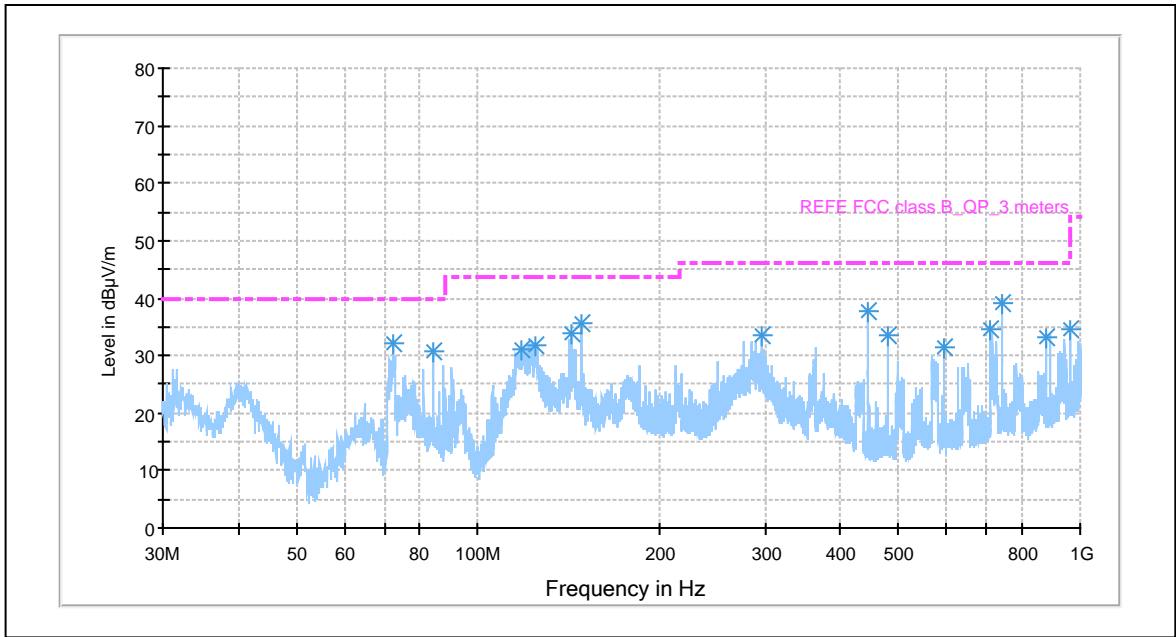

Bluetooth Channel 78 : 30 MHz to 1 GHz

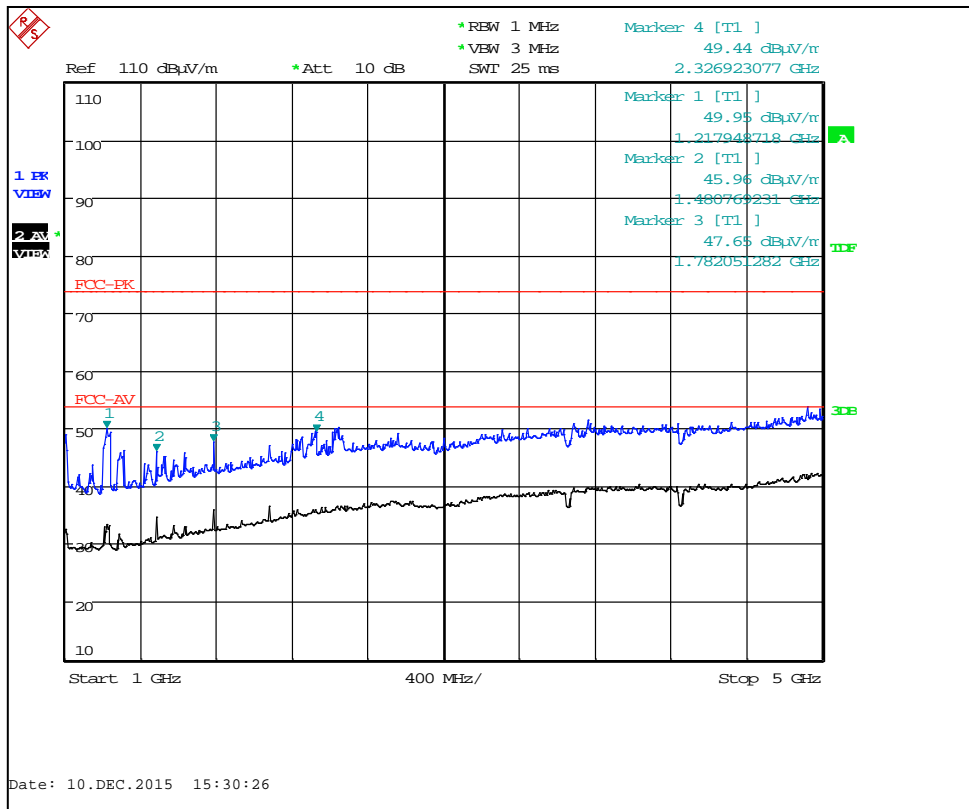

Bluetooth Channel 78 : 1 GHz to 5 GHz

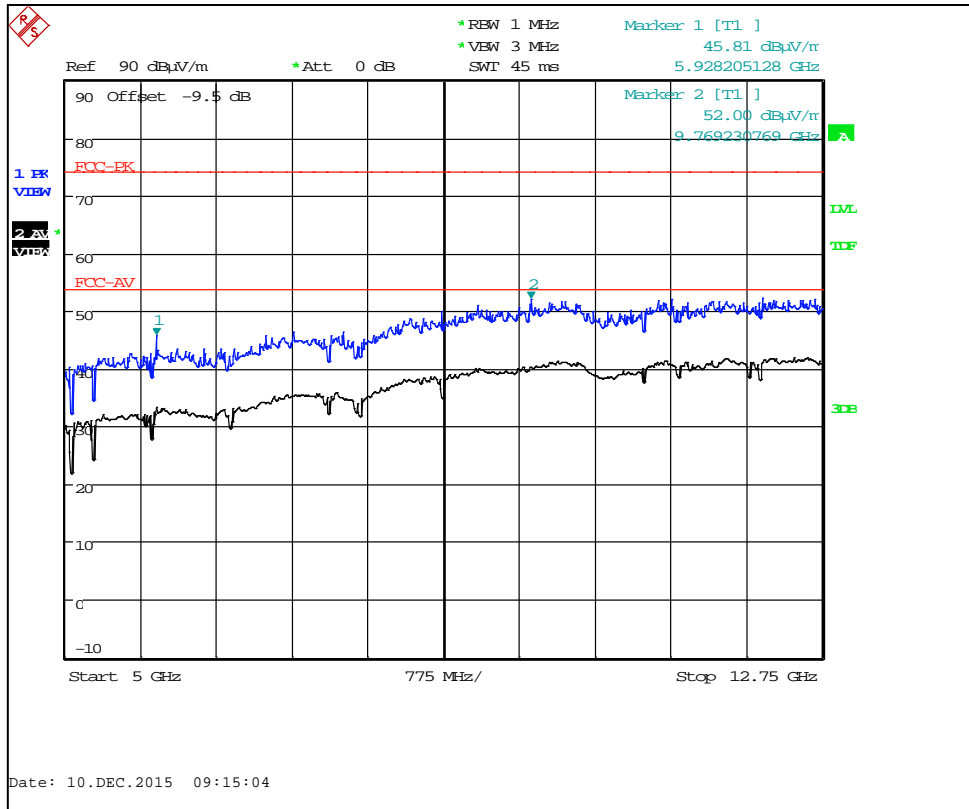

Bluetooth Channel 78 : 5 GHz to 12.75 GHz

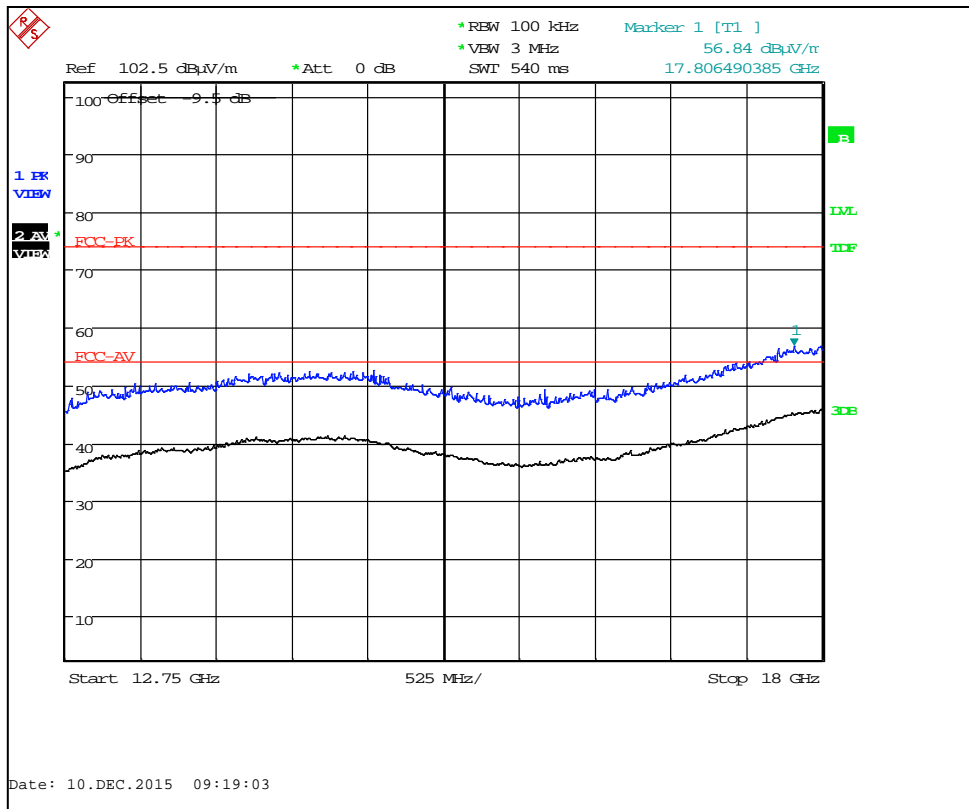

Bluetooth Channel 78 : 12.75 GHz to 18 GHz

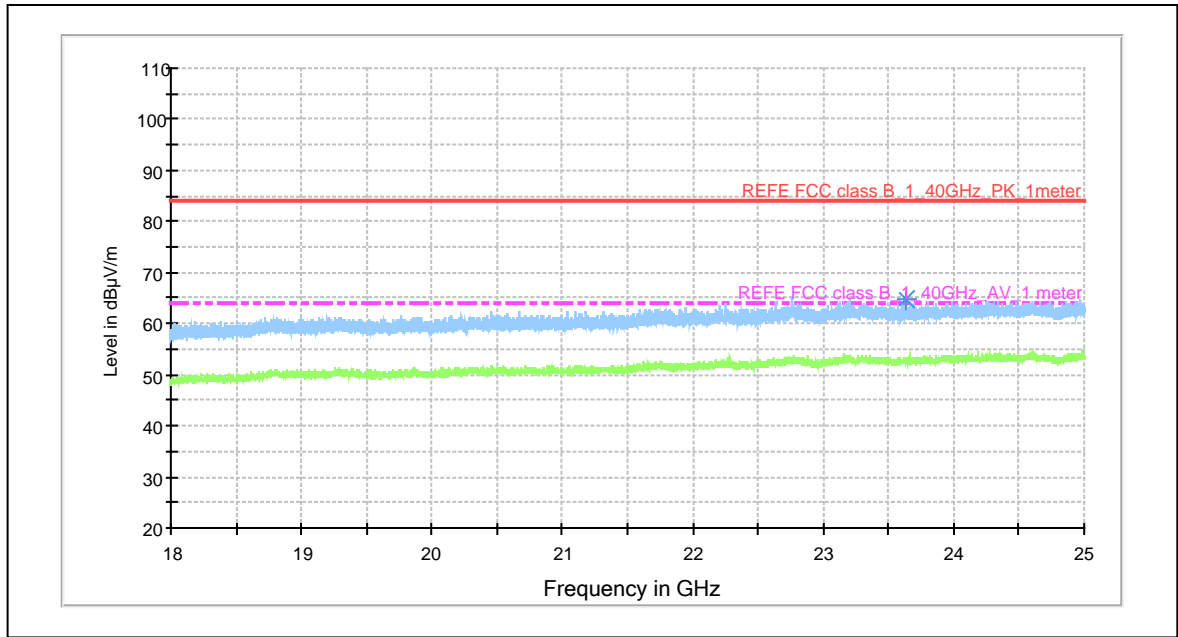

Bluetooth Channel 78 : 18 GHz to 25 GHz

Frequency (MHz)	QuasiPeak (dB μ V/m)	Meas. Time (ms)	Bandwidth (kHz)	Height (cm)	Polarization	Azimuth (deg)	Corr. (dB)	Margin (dB)	Limit (dB μ V/m)
40.575707	21.3	15000.0	120.000	109.0	V	208.0	-17.5	18.7	40.0
71.760480	18.8	15000.0	120.000	389.0	H	346.0	-23.9	21.2	40.0
72.366827	28.1	15000.0	120.000	404.0	H	348.0	-23.8	11.9	40.0
76.900573	17.5	15000.0	120.000	152.0	V	283.0	-23.3	22.5	40.0
84.421147	30.3	15000.0	120.000	129.0	V	271.0	-22.0	9.7	40.0
87.459933	26.0	15000.0	120.000	147.0	V	238.0	-21.6	14.0	40.0
90.756907	27.0	15000.0	120.000	397.0	H	159.0	-21.2	16.5	43.5
117.138453	25.4	15000.0	120.000	107.0	V	135.0	-18.5	18.1	43.5
124.961733	34.8	15000.0	120.000	100.0	V	254.0	-18.3	8.7	43.5
142.563667	25.6	15000.0	120.000	100.0	V	44.0	-18.4	17.9	43.5
148.506707	34.9	15000.0	120.000	100.0	V	21.0	-18.8	8.6	43.5
212.861973	16.1	15000.0	120.000	100.0	V	141.0	-21.1	27.4	43.5
284.367920	26.4	15000.0	120.000	197.0	V	9.0	-17.2	19.6	46.0
290.570093	28.1	15000.0	120.000	183.0	V	27.0	-16.9	17.9	46.0
362.527560	25.7	15000.0	120.000	100.0	H	81.0	-15.3	20.3	46.0
445.490533	35.5	15000.0	120.000	100.0	H	124.0	-13.0	10.5	46.0
480.001893	33.3	15000.0	120.000	100.0	H	239.0	-12.1	12.7	46.0
568.987480	25.2	15000.0	120.000	210.0	H	68.0	-9.7	20.8	46.0
593.993693	31.8	15000.0	120.000	190.0	H	176.0	-10.0	14.2	46.0
625.003280	28.5	15000.0	120.000	109.0	V	177.0	-9.4	17.5	46.0
639.263213	24.7	15000.0	120.000	201.0	H	69.0	-9.3	21.3	46.0
709.076120	19.3	15000.0	120.000	109.0	H	185.0	-8.4	26.7	46.0
742.516227	40.3	15000.0	120.000	108.0	H	101.0	-6.9	5.7	46.0
875.000707	37.9	15000.0	120.000	100.0	V	206.0	-5.8	8.1	46.0
890.999293	36.6	15000.0	120.000	100.0	H	224.0	-5.7	9.4	46.0
960.018000	34.8	15000.0	120.000	109.0	H	151.0	-3.3	19.2	54.0

<i>High Power; Channel: 2042 MHz</i>									
Detector	Freq. (MHz)	Measured Emission (dB μ V/m)	Cable Loss (dB)	Antenna Factor (dB/m)	Pre-amp Gain (dB)	Field Strength (dB μ V/m)	Extrap'n Factor (dB)	Field Strength (μ V/m)	Limit (μ V/m)
Pk	1276.327	48.67	4.1	25.6	34.12	43.3	0	146.22	5000
Av	1276.327	32.2	4.1	25.6	34.12	26.8	0	21.88	500
Pk	1485.063	53.9	4.3	25.9	33.77	49.4	0	295.12	5000
Av	1485.063	43.55	4.3	25.9	33.77	39.0	0	89.13	500
Pk	1782.051	49.72	5.1	27.2	33.69	47.4	0	234.42	5000
Av	1782.051	45.12	5.1	27.2	33.69	42.8	0	138.04	500
Pk	2256.410	49.8	6.6	28.0	33.72	49.8	0	309.03	5000
Av	2256.410	44	6.6	28.0	33.72	44.0	0	158.49	500

20 Measurement Uncertainty

Calculated Measurement Uncertainties

All statements of uncertainty are expanded standard uncertainty using a coverage factor of 1.96 to give a 95 % confidence:

[1] Radiated spurious emissions

Uncertainty in test result (30 MHz to 1 GHz) = **4.6 dB**

Uncertainty in test result (1 GHz to 18 GHz) = **4.7 dB**

[2] AC power line conducted emissions

Uncertainty in test result = **3.4 dB**

[3] Occupied bandwidth

Uncertainty in test result = **15.5 %**

[4] Conducted carrier power

Uncertainty in test result (Power Meter) = **1.08 dB**

[5] Conducted / radiated RF power out-of-band

Uncertainty in test result – up to 8.1 GHz = **3.31 dB**

Uncertainty in test result – 8.1 GHz to 15.3 GHz = **4.43 dB**

Uncertainty in test result (30 MHz to 1 GHz) = **4.6 dB**

Uncertainty in test result (1 GHz to 18 GHz) = **4.7 dB**

[6] Frequency separation

Uncertainty in test result (Spectrum Analyser) = **3.6 kHz**

[7] Accumulated channel occupancy time

Uncertainty in test result = **7.98 %**

21 RF Exposure

As per KDB 447498

47 CFR §§1.1307 and 2.1091

2.1091 Radio frequency radiation exposure evaluation: Portable devices.

For purposes of these requirements mobile devices are defined by the FCC as transmitters designed to be used in other than fixed locations and to generally be used in such a way that a separation distance of at least 20 centimetres is normally maintained between radiating structures and the body of the user or nearby persons. These devices are normally evaluated for exposure potential with relation to the MPE limits. As the 20cm separation specified under FCC rules may not be achievable under normal operation of the EUT, an RF exposure calculation is needed to show the minimum distance required to be less than $0.6\text{mW}/\text{cm}^2$ power density limit, as required under FCC rules

Prediction of MPE limit at a given distance

Equation from KDB 447498 D01

$$S = \frac{1.64ERP}{4\pi R^2} \text{ re - arranged } R = \sqrt{\frac{1.64ERP}{S4\pi}}$$

where:

S = power density

R = distance to the centre of radiation of the antenna

ERP = EUT Maximum power

Result:

Prediction Frequency (MHz)	Maximum ERP (mW)	Power density limit (S) (mW/cm^2)	Distance (R) cm required to be less than $0.6\text{mW}/\text{cm}^2$ (cm)
2480	3.72	0.6	0.9