

SAR TEST REPORT

Report No.: BCTC2204915425-3E

Applicant: Ningbo Pelican Smart Fishing Tackle Co., Ltd

Product Name: Remote Control

Model/Type Ref.: SU-0000G1AP01

Tested Date: 2022-06-14 to 2022-06-14

Issued Date: 2022-07-25



Shenzhen **BCTC** Testing Co., Ltd.



FCC ID: 2ASTRSU-0000G1AP01

Product Name: Remote Control

Trademark: 

Model/Type Ref.: SU-0000G1AP01

Applicant: Ningbo Pelican Smart Fishing Tackle Co., Ltd

Address: No.16, Yongchang Road, Chengdong Industrial Park, Xiangshan County, Ningbo City, Zhejiang Province, China

Manufacturer: Ningbo Pelican Smart Fishing Tackle Co., Ltd

Address: No.16, Yongchang Road, Chengdong Industrial Park, Xiangshan County, Ningbo City, Zhejiang Province, China

Factory: N/A

Address: N/A

Prepared By: Shenzhen BCTC Testing Co., Ltd.

Address: 1-2/F., Building B, Pengzhou Industrial Park, No.158, Fuyuan 1st Road, Tangwei, Fuhai Subdistrict, Bao'an District, Shenzhen, Guangdong, China

Sample Received Date: 2022-05-26

Sample tested Date: 2022-06-14 to 2022-06-14

Issue Date: 2022-07-25

Test Standards: IEEE Std C95.1, 2019/ IEEE Std 1528™-2013/FCC Part 2.1093

Test Results: PASS

Remark: This is SAR test report

Tested by:

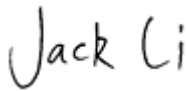

Jack Li/Project Handler

Approved by:



Zero Zhou/Reviewer

The test report is effective only with both signature and specialized stamp. This result(s) shown in this report refer only to the sample(s) tested. Without written approval of Shenzhen BCTC Testing Co., Ltd, this report can't be reproduced except in full. The tested sample(s) and the sample information are provided by the client.

Table Of Content

Test Report Declaration	Page
1. Version	5
2. Test Standards	6
3. Test Summary	7
4. SAR Limits.....	8
5. Measurement Uncertainty	9
6. Product Information And Test Setup	11
6.1 Product Information.....	11
6.2 Test Setup Configuration	12
6.3 Support Equipment	12
6.4 Test Environment.....	12
7. Test Facility And Test Instrument Used.....	13
7.1 Test Facility.....	13
7.2 Test Instrument Used.....	13
8. Specific Absorption Rate (SAR)	15
8.1 Introduction	15
8.2 SAR Definition.....	15
9. SAR Measurement System	16
9.1 The Measurement System	16
9.2 Probe	16
9.3 Test Procedure	18
9.4 Phantom.....	19
9.5 Phantom.....	19
10. Tissue Simulating Liquids.....	20
10.1 Composition of Tissue Simulating Liquid	20
10.2 Limit	21
10.3 Tissue Calibration Result	22
11. SAR Measurement Evaluation	23
11.1 Purpose of System Performance Check	23
11.2 System Setup.....	23
11.3 Validation Results	23
12. EUT Testing Position.....	24
12.1 Define Two Imaginary Lines on The Handset	24
12.2 Cheek Position	25
12.3 Tilted Position	25
12.4 Body Position	26
13. SAR Measurement Procedures.....	27
13.1 Measurement Procedures.....	27
13.2 Spatial Peak SAR Evaluation.....	27
13.3 Area & Zoom Scan Procedures	28
13.4 Volume Scan Procedures	28
13.5 SAR Averaged Methods.....	28
13.6 Power Drift Monitoring.....	28
14. SAR Test Result.....	30

14.1	Conducted RF Output Power	30
14.2	Transmit Antennas and SAR Measurement Position	31
14.3	Test Results for Standalone SAR Test.....	32
14.4	Standalone SAR Test Exclusion Considerations and Estimated SAR	33
14.5	Simultaneous TX SAR Considerations.....	33
14.6	SAR Measurement Variability	33
14.7	General description of test procedures	34
15.	Test Plots	36
15.1	System Performance Check	36
15.2	SAR Test Graph Results.....	38
16.	CALIBRATION CERTIFICATES.....	42
17.	EUT Photographs.....	67
18.	EUT Test Setup Photographs.....	69

(Note: N/A Means Not Applicable)

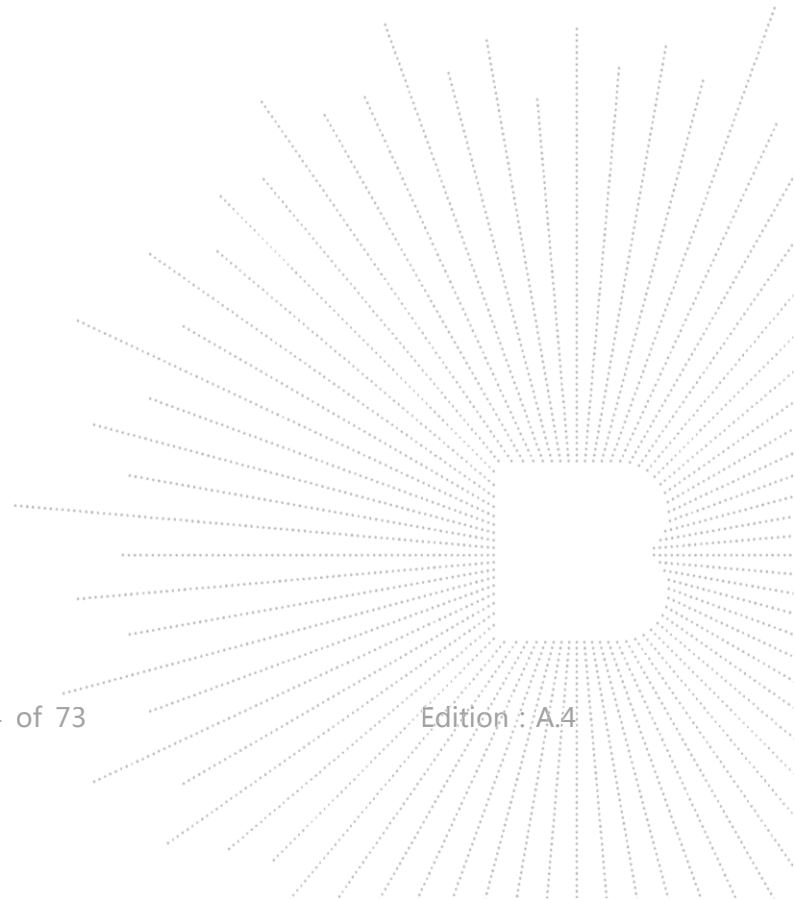

1. Version

Report No.	Issue Date	Description	Approved
BCTC2204915425-3E	2022-07-25	Original	Valid

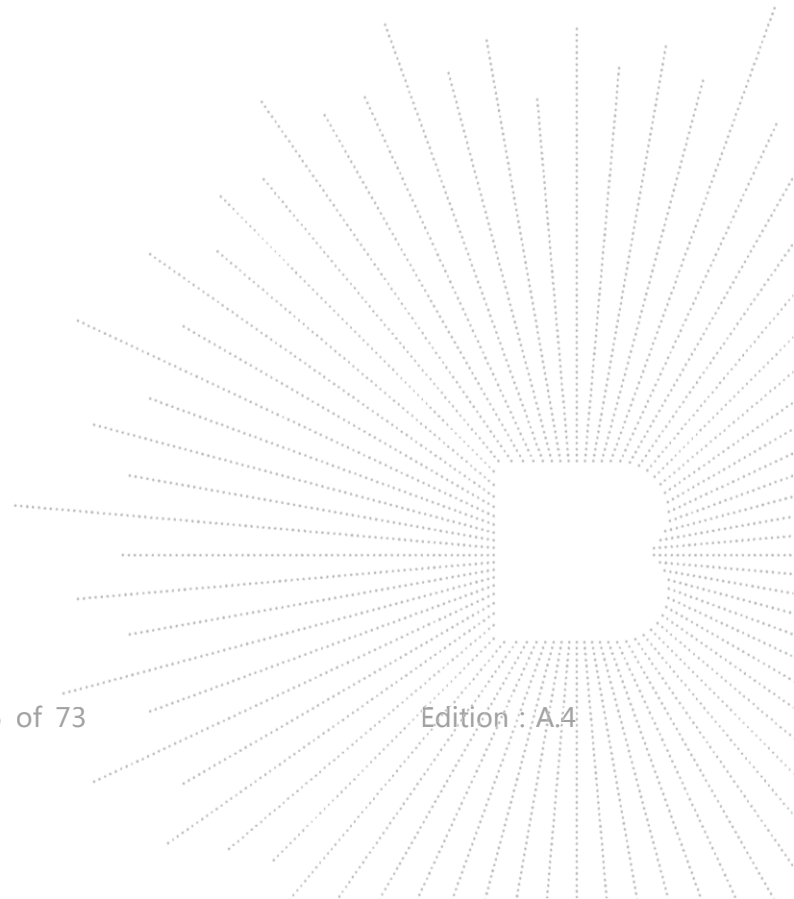

2. Test Standards

IEEE Std C95.1-2019: IEEE Standard for Safety Levels with Respect to Human Exposure to Electric, Magnetic, and Electromagnetic Fields, 0 Hz to 300 GHz. It specifies the maximum exposure limit of 1.6 W/kg as averaged over any 1 gram of tissue for portable devices being used within 20 cm of the user in the uncontrolled environment.

IEEE Std 1528™-2013: IEEE Recommended Practice for Determining the Peak Spatial-Average Specific Absorption Rate (SAR) in the Human Head from Wireless Communications Devices: Measurement Techniques.

FCC Part 2.1093 Radiofrequency Radiation Exposure Evaluation: Portable Devices

KDB447498 D01 General RF Exposure Guidance v06 : Mobile and Portable Device RF Exposure Procedures and Equipment Authorization Policies

KDB447498 D02 SAR Procedures for Dongle Xmtr v02r01: SAR Measurement Procedures For USB Dongle Transmitters.

KDB865664 D01 SAR Measurement 100 MHz to 6 GHz v01r04 : SAR Measurement Requirements for 100 MHz to 6 GHz

KDB865664 D02 RF Exposure Reporting v01r02: RF Exposure Compliance Reporting and Documentation Considerations

KDB 248227 D01 802.11 Wi-Fi SAR v02r02: SAR GUIDANCE FOR IEEE 802.11 (Wi-Fi) TRANSMITTERS

KDB 616217 D04 SAR for laptop and tablets v01r02: SAR Evaluation procedures for umpc mini-tablet devices

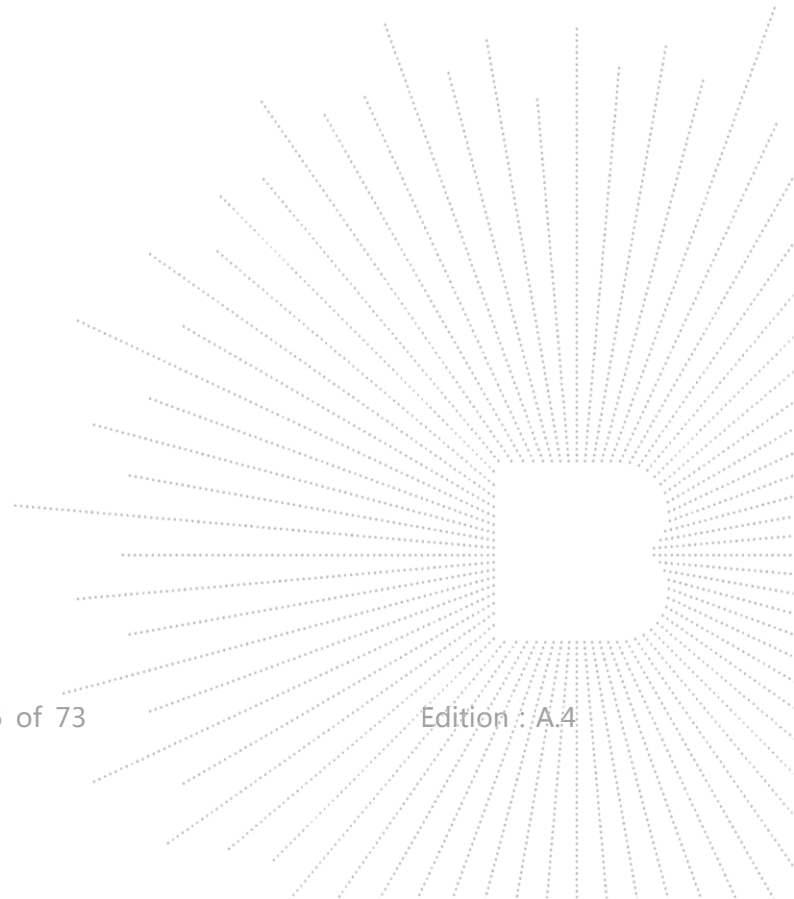

3. Test Summary

The maximum results of Specific Absorption Rate (SAR) have found during testing are as follows:

Frequency Band	Head SAR	Body (0mm Gap)	SAR _{1g} Limit (W/kg)
	Report SAR _{1g} (W/kg)	Report SAR _{1g} (W/kg)	
WIFI2.4G	NA	0.016	1.6
SRD2.4G	NA	0.326	1.6

The device is in compliance with Specific Absorption Rate (SAR) for general population/uncontrolled exposure limits (1.6 W/kg) specified in FCC 47 CFR part 2 (2.1093) and ANSI/IEEE C95.1-2019, and had been tested in accordance with the measurement methods and procedure specified in IEEE 1528-2013.

Highest Reported simultaneous SAR

Exposure Position	Classment Class	Highest Reported Simultaneous Transmission SAR1-g (W/kg)
Body	WIFI2.4G	0.342
	SRD2.4G	

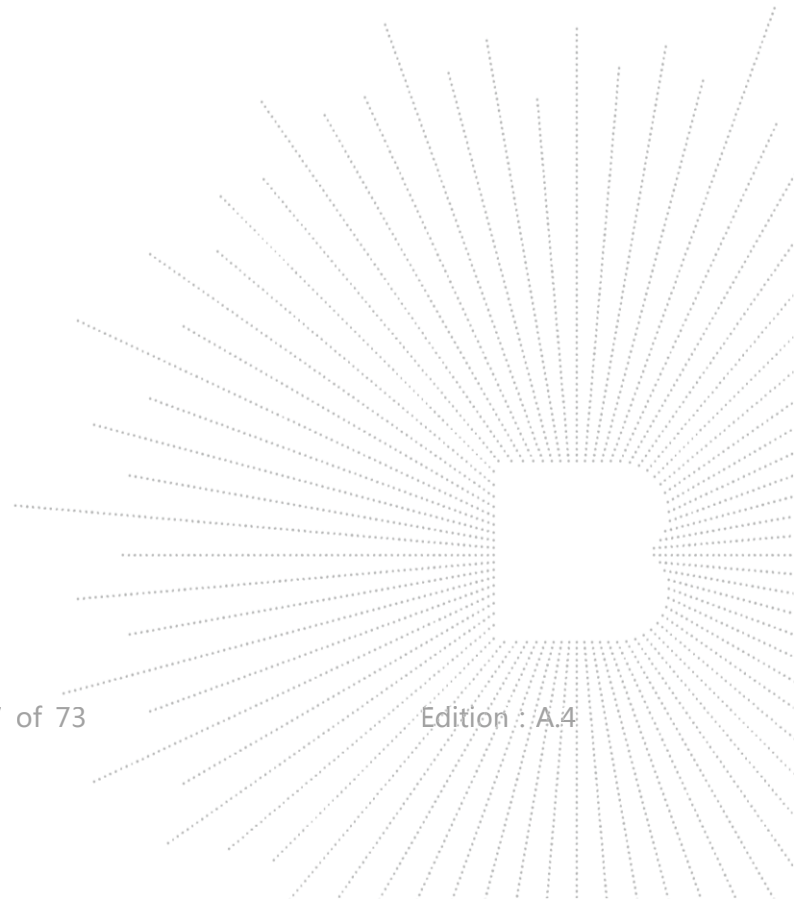

4. SAR Limits

EXPOSURE LIMITS	FCC Limit (1g Tissue)	
	SAR (W/kg)	
	(General Population / Uncontrolled Exposure Environment)	(Occupational / Controlled Exposure Environment)
Spatial Average(averaged over the whole body)	0.08	0.4
Spatial Peak(averaged over any 1 g of tissue)	1.6	8.0
Spatial Peak(hands/wrists/ feet/anklesaveraged over 10 g)	4.0	20.0

Population/Uncontrolled Environments are defined as locations where there is the exposure of individual who have no knowledge or control of their exposure.

Occupational/Controlled Environments are defined as locations where there is exposure that may be incurred by people who are aware of the potential for exposure (i.e. as a result of employment or occupation).

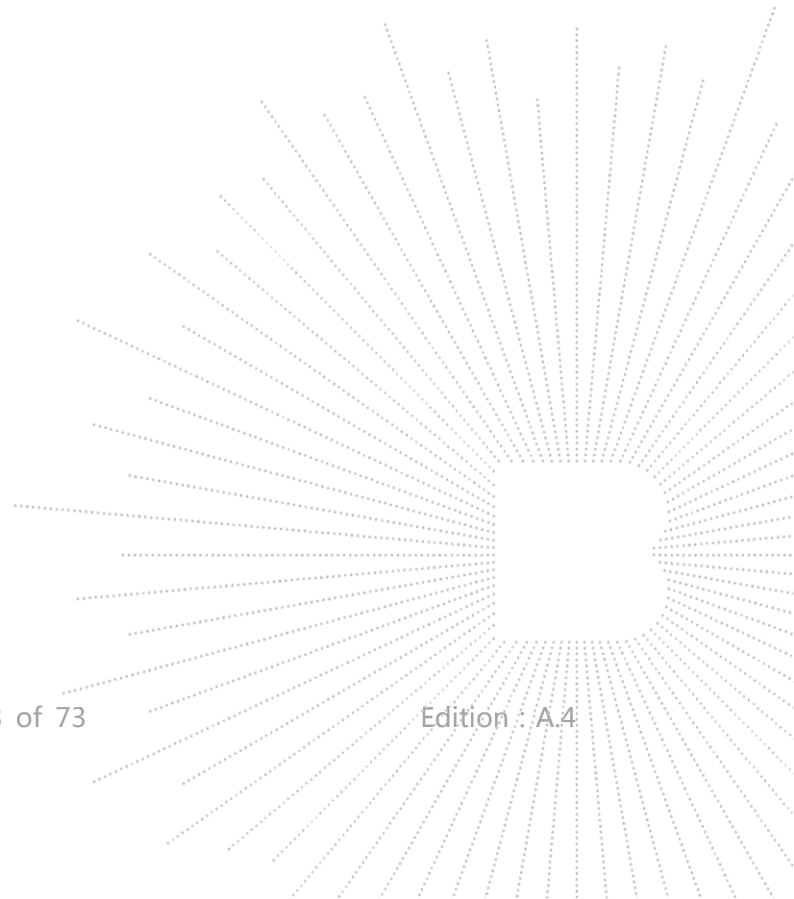

5. Measurement Uncertainty

Not required as SAR measurement uncertainty analysis is required in SAR reports only when the highest measured SAR in a frequency band is ≥ 1.5 W/kg for 1-g SAR according to KDB865664D01.

Uncertainty Component	Tol (+-%)	Prob. Dist.	Div.	Ci (1g)	Ci (10g)	1g Ui (+-%)	10g Ui (+-%)	Veff
Measurement System								
Probe calibration	5.8	N	1	1	1	5.80	5.80	∞
Axial Isotropy	3.5	R	$\sqrt{3}$	$\sqrt{1 - C_p}$	$\sqrt{1 - C_p}$	1.43	1.43	∞
Hemispherical Isotropy	5.9	R	$\sqrt{3}$	$\sqrt{C_p}$	$\sqrt{C_p}$	2.41	2.41	∞
Boundary effect	1.0	R	$\sqrt{3}$	1	1	0.58	0.58	∞
Linearity	4.7	R	$\sqrt{3}$	1	1	2.71	2.71	∞
System detection limits	1.0	R	$\sqrt{3}$	1	1	0.58	0.58	∞
Readout Electronics	0.5	N	1	1	1	0.50	0.50	∞
Response Time	0.0	R	$\sqrt{3}$	1	1	0.00	0.00	∞
Integration Time	1.4	R	$\sqrt{3}$	1	1	0.81	0.81	∞
RF ambient Conditions - Noise	3.0	R	$\sqrt{3}$	1	1	1.73	1.73	∞
RF ambient Conditions - Reflections	3.0	R	$\sqrt{3}$	1	1	1.73	1.73	∞
Probe positioner Mechanical Tolerance	1.4	R	$\sqrt{3}$	1	1	0.81	0.81	∞
Probe positioning with respect to Phantom Shell	1.4	R	$\sqrt{3}$	1	1	0.81	0.81	∞
Max. SAR Evaluation	1.0	R	$\sqrt{3}$	1	1	0.6	0.6	∞
Test sample Related								
Device positioning	2.6	N	1	1	1	2.6	2.6	11
Device holder	3.0	N	1	1	1	3.0	3.0	7
Drift of output power	5.0	N	$\sqrt{3}$	1	1	2.89	2.89	∞
Phantom and Tissue Parameters								
Phantom uncertainty	4.00	R	$\sqrt{3}$	1	1	2.31	2.31	∞
Liquid conductivity (target)	2.50	N	1	0.78	0.71	1.95	1.78	5
Liquid conductivity (meas)	4.00	N	1	0.23	0.26	0.92	1.04	5
Liquid Permittivity (target)	2.50	N	1	0.78	0.71	1.95	1.78	∞
Liquid Permittivity (meas)	5.00	N	1	0.23	0.26	1.15	1.30	∞
Combined Standard		RSS		$U_c = \sqrt{\sum_{i=1}^n C_i^2 U_i^2}$		10.63 %	10.54%	

Expanded Uncertainty (95% Confidence interval)	$U = k UC, k=2$	21.26 %	21.08%	
---	-----------------	------------	--------	--

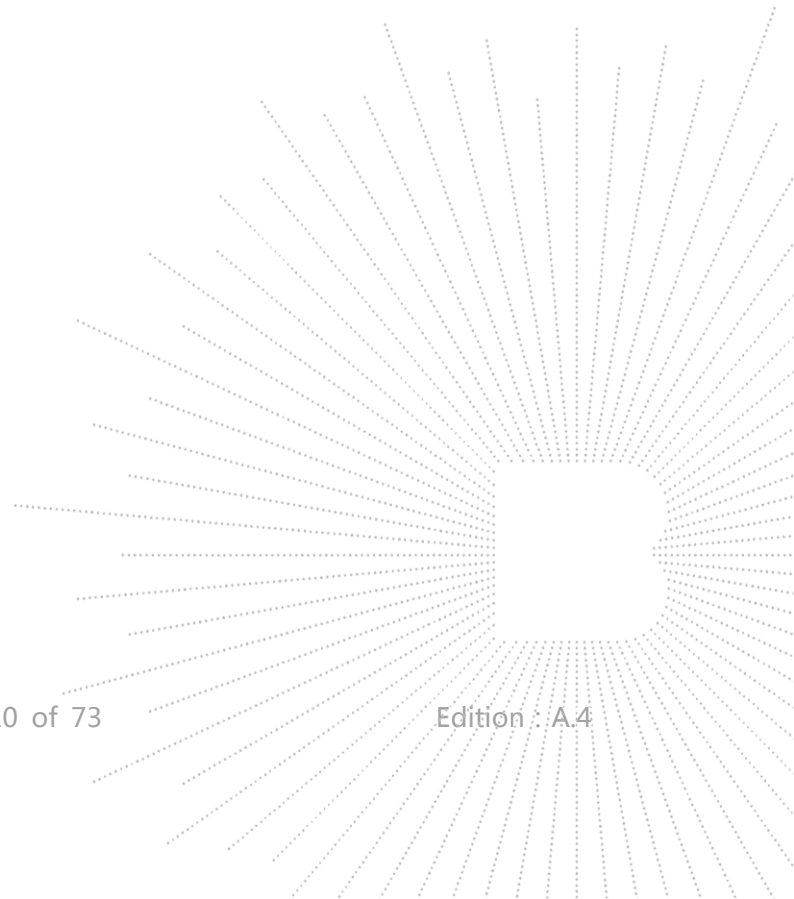

6. Product Information And Test Setup

6.1 Product Information

Model/Type Ref.:	SU-0000G1AP01
Model differences:	N/A
Hardware Version:	N/A
Software Version:	N/A
Ratings:	DC 3.7V From battery, USB DC 5V From adapter
Adapter:	Model:WTA24-0503000-U Input:100-240V~50/60Hz 1.0A Output:5.0V ---3.0A

WIFI2.4G

Operation Frequency:	802.11b/g/n20MHz:2412~2462 MHz
Bit Rate of Transmitter:	802.11b:11/5.5/2/1Mbps 802.11g:54/48/36/24/18/12/9/6Mbps 802.11n Up to 75Mbps
Type of Modulation:	WIFI: OFDM/DSSS
Number Of Channel:	802.11b/g/n20MHz:11 CH
Antenna installation:	PCB antenna
Antenna Gain:	1dBi

SRD2.4G

Operation Frequency:	2407MHz-2477MHz
Type of Modulation:	GFSK
Number Of Channel:	11CH
Antenna installation:	External antenna
Antenna Gain:	3.16 dBi

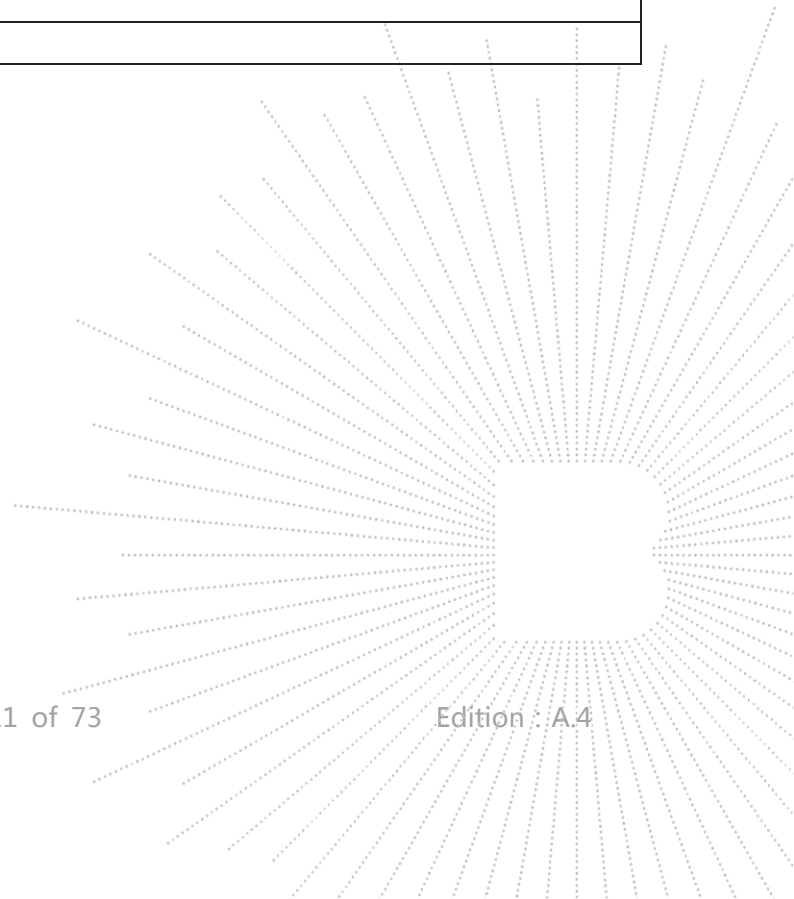

6.2 Test Setup Configuration

See test photographs attached in EUT TEST SETUP PHOTOGRAPHS for the actual connections between Product and support equipment.

6.3 Support Equipment

Cable of Product

No.	Cable Type	Quantity	Provider	Length (m)	Shielded	Note
1	--	--	Applicant	---	Yes/No	--
2	--	--	BCTC	--	Yes/No	--

No.	Device Type	Brand	Model	Series No.	Note
1.	---	---	---	---	---
2.	--	--	--	--	--

Notes:

1. All the equipment/cables were placed in the worst-case configuration to maximize the emission during the test.
2. Grounding was established in accordance with the manufacturer's requirements and conditions for the intended use.

6.4 Test Environment

1. Normal Test Conditions:

Humidity(%):	54
Atmospheric Pressure(kPa):	101
Temperature(°C):	22

2. Extreme Test Conditions:
N/A

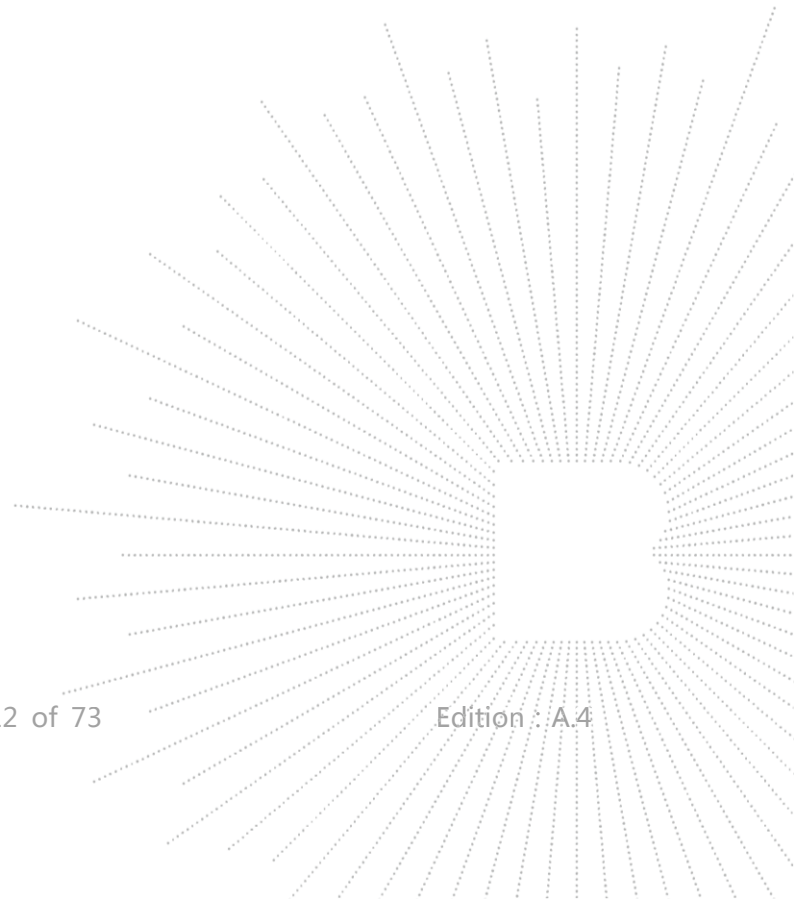

7. Test Facility And Test Instrument Used

7.1 Test Facility

All measurement facilities used to collect the measurement data are located at Shenzhen BCTC Testing Co., Ltd. Address: 1-2/F., Building B, Pengzhou Industrial Park, No.158, Fuyuan 1st Road, Tangwei, Fuhai Subdistrict, Bao'an District, Shenzhen, Guangdong, China. The site and apparatus are constructed in conformance with the requirements of ANSI C63.4 and CISPR 16-1-1 other equivalent standards.

7.2 Test Instrument Used

Equipment	Manufacturer	Model#	Serial#	Last Cal.	Next Cal.
PC	DELL	\	\	N/A	N/A
SAR Measurement system	SATIMO	\	\	N/A	N/A
Signal Generator	Agilent	83712A	\	May 24, 2022	May 23, 2023
Multimeter	Keithley	1160271	\	Nov. 12, 2021	Nov 11, 2022
S-parameter Network Analyzer	R&S	ZVB 8	101353	Dec. 09, 2021	Dec. 08, 2022
Wideband Radio Communication Tester	R&S	CMW500	\	Nov. 12, 2021	Nov 11, 2022
E SAR PROBE 6GHz	MVG	SSE2	SN EPGO362	Nov. 20, 2021	Nov. 19, 2022
DIPOLE 2450	SATIMO	SID 2450	SN 47/21 DIP 0G835-621	Nov. 20, 2021	Nov. 19, 2024
COMOSAR OPENCoaxial Probe	SATIMO	\	\	Nov. 20, 2021	Nov. 19, 2022
SAR Locator	SATIMO	\	\	Nov. 20, 2021	Nov. 19, 2022
Communication Antenna	SATIMO	\	\	Nov. 20, 2021	Nov. 19, 2022
FEATURE PHONEPOSITIONING DEVICE	SATIMO	\	\	N/A	N/A
DUMMY PROBE	SATIMO	\	\	N/A	N/A
SAM Phantom	MVG	\	SN 13/09 SAM68	N/A	N/A
Liquid measurement Kit	HP	85033D	3423A08186	Nov. 20, 2021	Nov. 19, 2022
Power meter	Agilent	E4419	\	May 24, 2022	May 23, 2023
Power meter	Agilent	E4419	\	May 24, 2022	May 23, 2023
Power sensor	Agilent	E9300A	\	May 24, 2022	May 23, 2023
Power sensor	Agilent	E9300A	\	May 24, 2022	May 23, 2023
Directional Coupler	Krytar 158020	131467	\	Nov. 12, 2021	Nov 11, 2022

Note:

Per KDB865664D01 requirements for dipole calibration, the test laboratory has adopted three year extended calibration interval. Each measured dipole is expected to evaluate with following criteria at least on annual interval.

- P. There is no physical damage on the dipole;
- Q. System check with specific dipole is within 10% of calibrated values;
- R. The most recent return-loss results, measured at least annually, deviates by no more than 20% from the previous measurement;

- S. The most recent measurement of the real or imaginary parts of the impedance, measured at least annually is within 5Ω from the previous measurement.

Network analyzer probe calibration against air, distilled water and a shorting block performed before measuring liquid parameters.

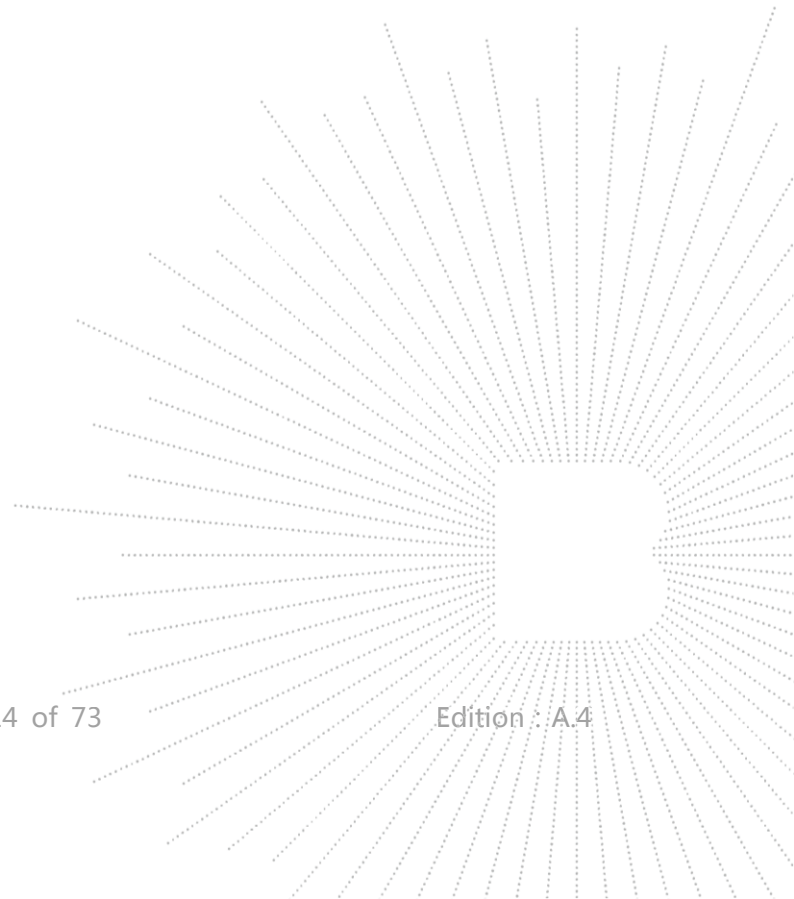

8. Specific Absorption Rate (SAR)

8.1 Introduction

SAR is related to the rate at which energy is absorbed per unit mass in an object exposed to a radio field. The SAR distribution in a biological body is complicated and is usually carried out by experimental techniques or numerical modeling. The standard recommends limits for two tiers of groups, occupational/controlled and general population/uncontrolled, based on a person's awareness and ability to exercise control over his or her exposure. In general, occupational/controlled exposure limits are higher than the limits for general population/uncontrolled.

8.2 SAR Definition

The SAR definition is the time derivative (rate) of the incremental energy (dW) absorbed by (dissipated in) an incremental mass (dm) contained in a volume element (dv) of a given density (ρ). The equation description is as below:

$$\mathbf{SAR} = \frac{d}{dt} \left(\frac{dW}{dm} \right) = \frac{d}{dt} \left(\frac{dW}{\rho dv} \right)$$

SAR is expressed in units of Watts per kilogram (W/kg)

SAR measurement can be either related to the temperature elevation in tissue by

$$\mathbf{SAR} = C \left(\frac{\delta T}{\delta t} \right)$$

Where: C is the specific heat capacity, δT is the temperature rise and δt is the exposure duration, or related to the

electrical field in the tissue by

$$\mathbf{SAR} = \frac{\sigma |E|^2}{\rho}$$

Where: σ is the conductivity of the tissue, ρ is the mass density of the tissue and E is the RMS electrical field strength.

However for evaluating SAR of low power transmitter, electrical field measurement is typically applied.

9. SAR Measurement System

9.1 The Measurement System

Comosar is a system that is able to determine the SAR distribution inside a phantom of human being according to different standards. The Comosar system consists of the following items:

- Main computer to control all the system
- 6 axis robot
- Data acquisition system
- Miniature E-field probe
- Phone holder
- Head simulating tissue

The following figure shows the system.



The EUT under test operating at the maximum power level is placed in the phone holder, under the phantom, which is filled with head simulating liquid. The E-Field probe measures the electric field inside the phantom. The OpenSAR software computes the results to give a SAR value in a 1g or 10g mass.

9.2 Probe

For the measurements the Specific Dosimetric E-Field Probe SN 46/21 EPGO362 with following specifications is used

- Dynamic range: 0.01-100 W/kg
- Tip Diameter : 5 mm
- Distance between probe tip and sensor center: 2.10mm
- Distance between sensor center and the inner phantom surface: 4 mm (repeatability better than +/- 1mm)
- Probe linearity: <0.25 dB
- Axial Isotropy: <0.25 dB
- Spherical Isotropy: <0.50 dB
- Calibration range: 835 to 2500MHz for head & body simulating liquid.

Angle between probe axis (evaluation axis) and surface normal line: less than 30°

Probe calibration is realized, in compliance with EN 62209-1 and IEEE 1528 STD, with CALISAR, Antenna proprietary calibration system. The calibration is performed with the EN 62209-1 annex technique using reference guide at the five frequencies.

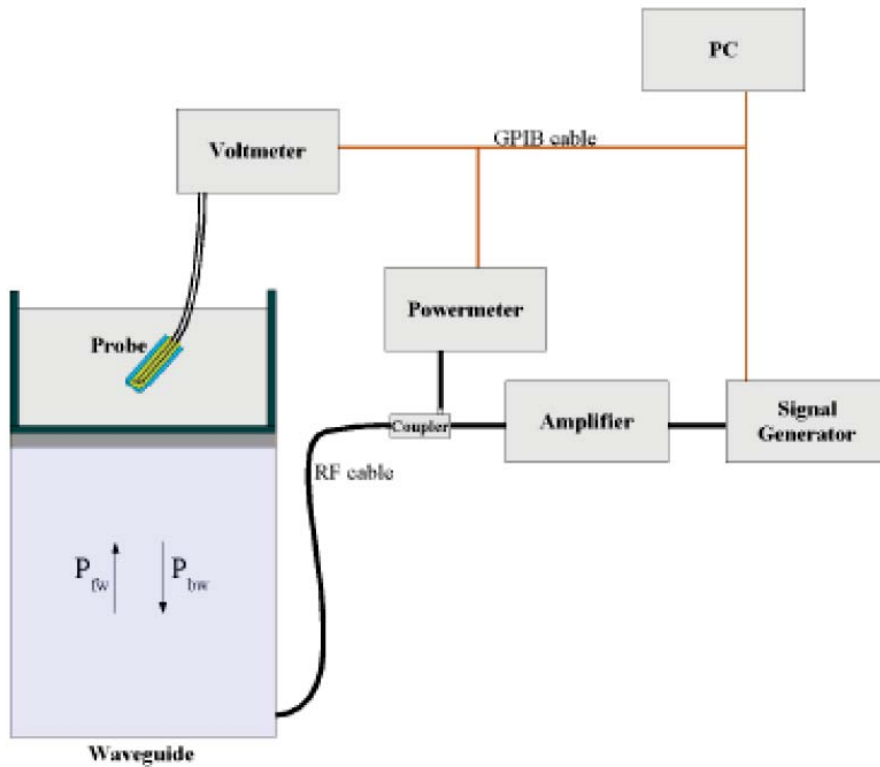

$$SAR = \frac{4(p_{fw} - p_{pbw})}{ab\delta} \cos^2 \left(\pi \frac{y}{a} \right) e^{(2\pi/\delta)}$$

Where :

P_{fw} = Forward Power

P_{bw} = Backward Power

a and b = Waveguide dimensions

δ = Skin depth

Keithley configuration:

Rate = Medium; Filter = ON; RDGS = 10; Filter type = Moving Average; Range auto after each calibration, a SAR measurement is performed on a validation dipole and compared with a NPL calibrated probe, to verify it.

The calibration factors, CF(N), for the 3 sensors corresponding to dipole 1, dipole 2 and dipole 3 are:

$$CF(N) = SAR(N)/V_{lin}(N) \quad (N=1,2,3)$$

The linearised output voltage $V_{lin}(N)$ is obtained from the displayed output voltage $V(N)$ using

$$V_{lin}(N) = V(N) * (1 + V(N)/DCP(N)) \quad (N=1,2,3)$$

where DCP is the diode compression point in mV.

9.3 Test Procedure

Dosimetric Assessment Procedure

Each E-Probe/Probe Amplifier combination has unique calibration parameters. SATIMO Probe calibration procedure is conducted to determine the proper amplifier settings to enter in the probe parameters. The amplifier settings are determined for a given frequency by subjecting the probe to a known E-field density (1 mW/cm²) using an with CALISAR, Antenna proprietary calibration system.

Free Space Assessment Procedure

The free space E-field from amplified probe outputs is determined in a test chamber. This calibration can be performed in a TEM cell if the frequency is below 1 GHz and in a waveguide or other methodologies above 1 GHz for free space. For the free space calibration, the probe is placed in the volumetric center of the cavity and at the proper orientation with the field. The probe is rotated 360 degrees until the three channels show the maximum reading. The power density readings equates to 1mW/cm².

Temperature Assessment Procedure

E-field temperature correlation calibration is performed in a flat phantom filled with the appropriate simulated head tissue. The E-field in the medium correlates with the temperature rise in the dielectric medium. For temperature correlation calibration a RF transparent thermistor-based temperature probe is used in conjunction with the E-field probe.

Where:

$$SAR = C \frac{\Delta T}{\Delta t}$$

Δt = exposure time (30 seconds),

C = heat capacity of tissue (brain or muscle),

ΔT = temperature increase due to RF exposure.

SAR is proportional to $\Delta T/\Delta t$, the initial rate of tissue heating, before thermal diffusion takes place. The electric field in the simulated tissue can be used to estimate SAR by equating the thermally derived SAR to that with the E- field component.

$$SAR = \frac{|E|^2 \cdot \sigma}{\rho}$$

Where:

σ = simulated tissue conductivity,

ρ = Tissue density (1.25 g/cm³ for brain tissue)

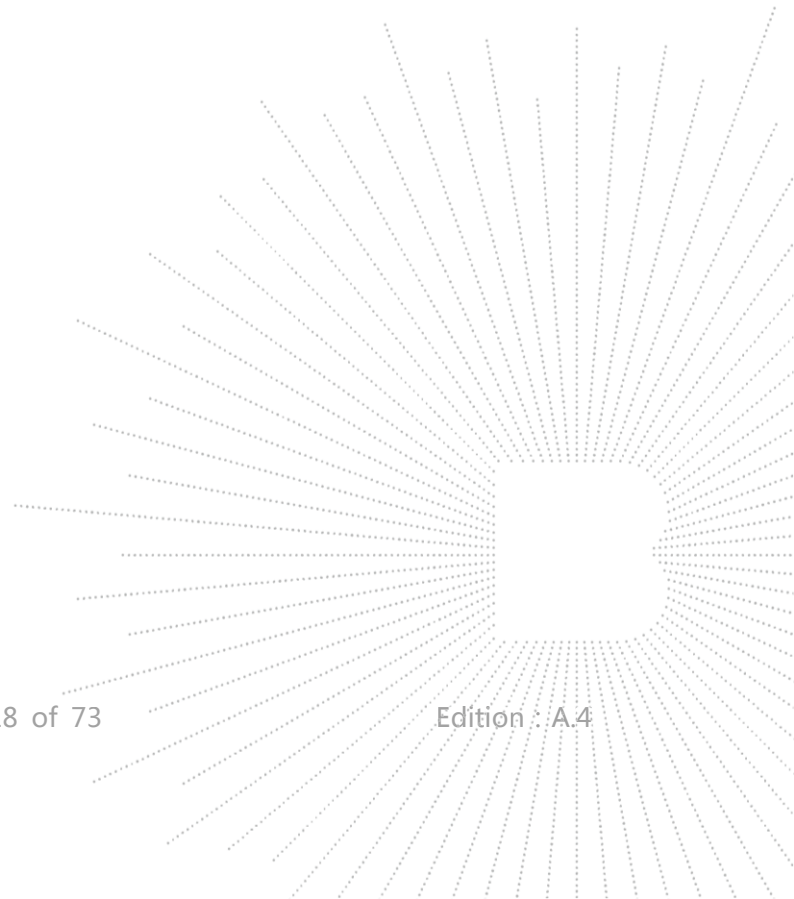

9.4 Phantom

For the measurements the Specific Anthropomorphic Mannequin (SAM) defined by the IEEE SCC-34/SC2 group is used. The phantom is a polyurethane shell integrated in a wooden table. The thickness of the phantom amounts to 2mm +/- 0.2mm. It enables the dosimetric evaluation of left and right phone usage and includes an additional flat phantom part for the simplified performance check. The phantom set-up includes a cover, which prevents the evaporation of the liquid.

9.5 Phantom

The positioning system allows obtaining cheek and tilting position with a very good accuracy. In compliance with CENELEC, the tilt angle uncertainty is lower than 1°.

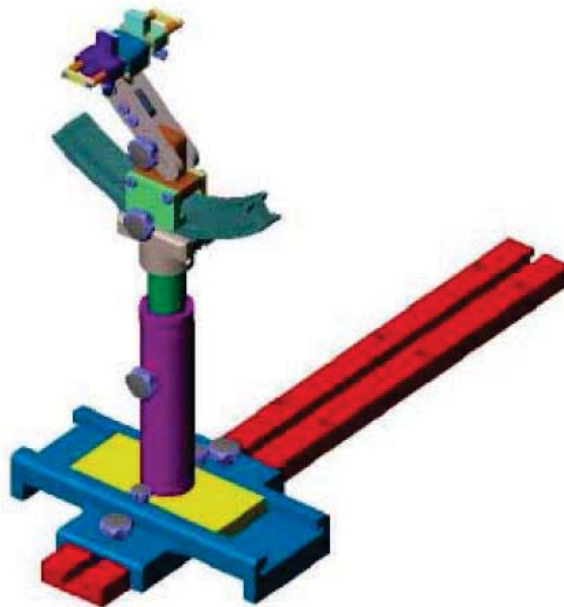

System Material	Permittivity	Loss Tangent
Delrin	3.7	0.005

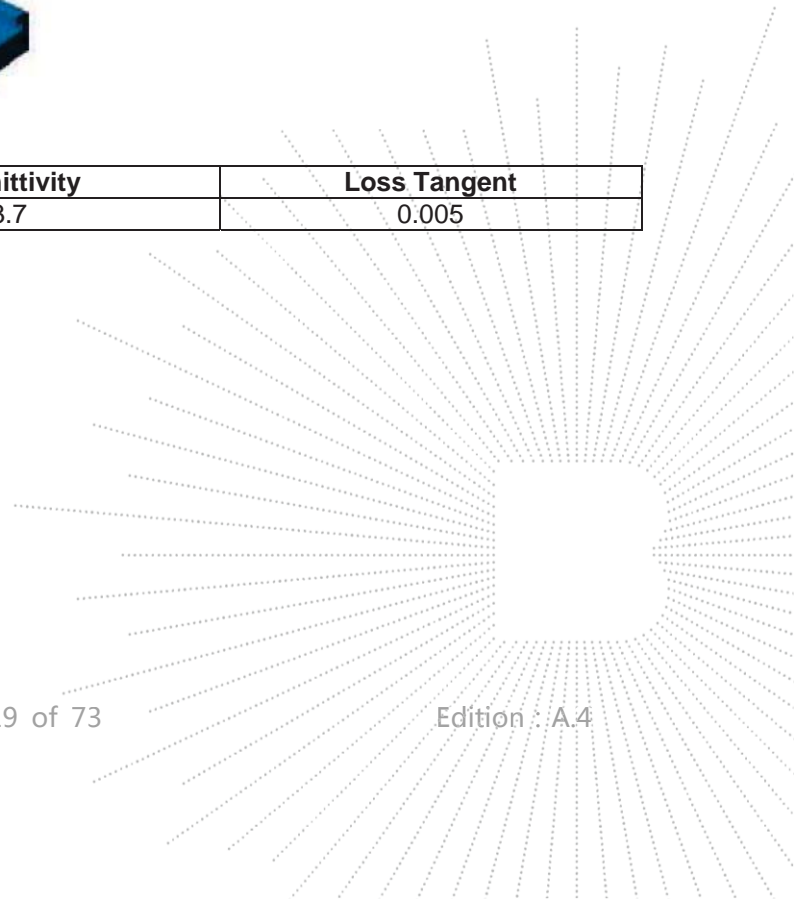

10. Tissue Simulating Liquids

10.1 Composition of Tissue Simulating Liquid

For the measurement of the field distribution inside the SAM phantom with SMTIMO, the phantom must be filled with around 25 liters of homogeneous body tissue simulating liquid. For head SAR testing, the liquid height from the ear reference point (ERP) of the phantom to the liquid top surface is larger than 15 cm. For body SAR testing, the liquid height from the center of the flat phantom to the liquid top surface is larger than 15 cm. Please see the following photos for the liquid height.



Liquid Height for Body SAR

The Composition of Tissue Simulating Liquid

Frequency (MHz)	Water (%)	Salt (%)	1,2-Propane diol (%)	HEC (%)	Preventol (%)	DGBE (%)
Head/Body						
835	40.3	1.4	57.9	0.2	0.2	0
900	40.3	1.4	57.9	0.2	0.2	0
1800-2000	55.2	0.3	0	0	0	44.5
2450	55.0	0.1	0	0	0	44.9
2600	54.9	0.1	0	0	0	45.0

Frequency (MHz)	Water (%)	Hexyl Carbitol (%)	Triton X-100 (%)
Head/Body			
5000-6000	65.52	17.24	17.24

10.2 Limit

The head tissue dielectric parameters recommended by the IEEE SCC-34/SC-2 in P1528 have been incorporated in the following table. These head parameters are derived from planar layer models simulating the highest expected SAR for the dielectric properties and tissue thickness variations in a human head. Other head and body tissue parameters that have not been specified in P1528 are derived from the tissue dielectric parameters

computed from the 4-Cole-Cole equations described in Reference [12] and extrapolated according to the head parameters specified in P1528.

Target Frequency (MHz)	Head/Body	
	Conductivity (σ)	Permittivity (ϵ_r)
150	0.76	52.3
300	0.87	45.3
450	0.87	43.5
750	0.89	41.9
835	0.90	41.5
900	0.97	41.5
915	0.98	41.5
1450	1.20	40.5
1610	1.29	40.3
1800-2000	1.40	40.0
2450	1.80	39.2
2600	1.96	39.0
3000	2.40	38.5
5200	4.66	36.0
5400	4.86	35.8
5600	5.07	35.5
5800	5.27	35.3

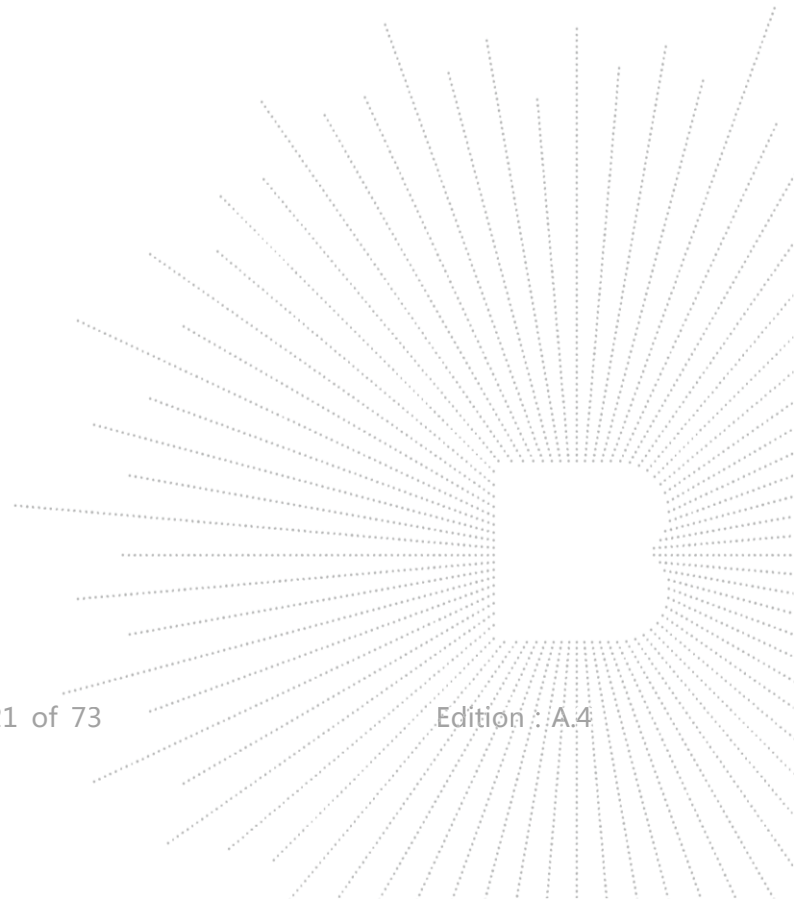

10.3 Tissue Calibration Result

The dielectric parameters of the liquids were verified prior to the SAR evaluation using an R&S ZVB 8. Dielectric Probe Kit and an Agilent Network Analyzer.

Calibration Result for Dielectric Parameters of Tissue Simulating Liquid

Frequency (MHz)	Liquid	Target Permittivity (F/m)	Target Conductivity (S/m)	Measured Permittivity (F/m)	Measured Conductivity (S/m)	Deviation Perm. Con d.(%)	Date	Temp. Ambient TSL (°C)
2450	Head	39.09	1.89	39.09	1.89	-0.01 -0.16	06/14/2022	20.0 20.0

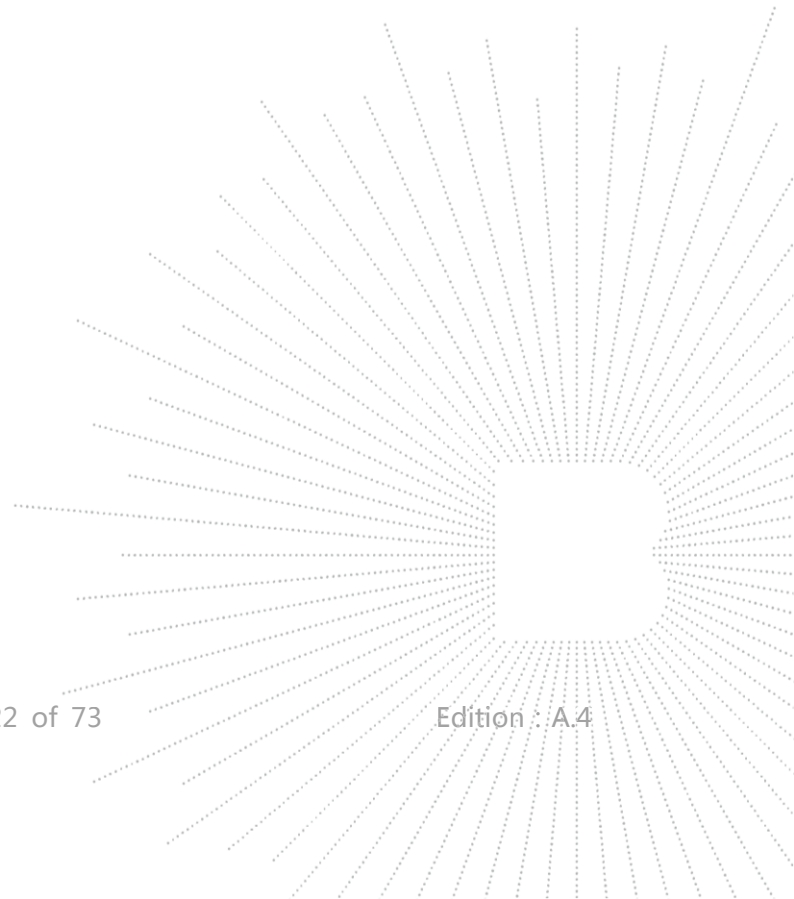

11. SAR Measurement Evaluation

11.1 Purpose of System Performance Check

At the device test frequencies. System check verifies the measurement repeatability of a SAR system before compliance testing and is not a validation of all system specifications. The latter is not required for testing a device but is mandatory before the system is deployed. The system check detects possible short-term drift and unacceptable measurement errors or uncertainties in the system.

11.2 System Setup

In the simplified setup for system evaluation, the EUT is replaced by a calibrated dipole and the power source is replaced by a continuous wave which comes from a signal generator at frequency 850MHz,900 MHz,1800MHz,2000MHz, 2450MHz,2600MHz. The calibrated dipole must be placed beneath the flat phantom section of the SAM twin phantom with the correct distance holder. The distance holder should touch the phantom surface with a light pressure at the reference marking and be oriented parallel to the long side of the phantom. The output power on dipole port must be calibrated to 24 dBm (250 mW) before dipole is connected.

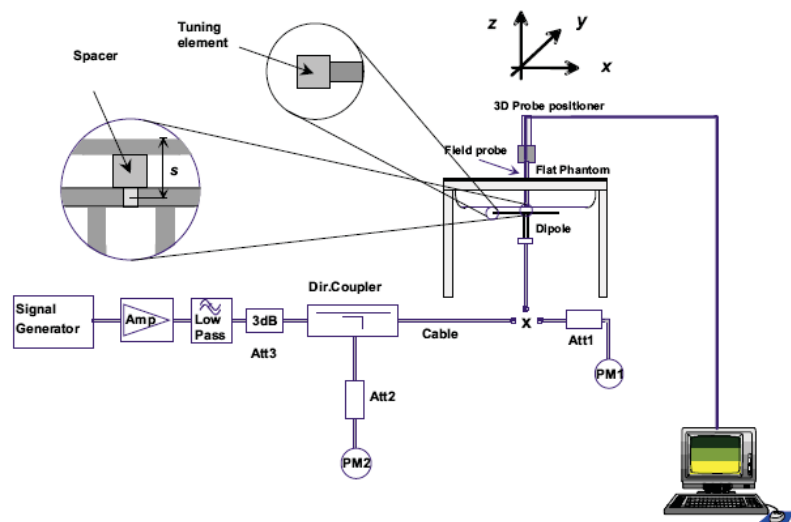

11.3 Validation Results

Comparing to the original SAR value provided by SATIMO, the validation data should be within its specification of 10 %. The following table shows the target SAR and measured SAR after normalized to 1W input power. The table below indicates the system performance check can meet the variation criterion.

Mixture Type	Frequency (MHz)	Power	SAR _{1g} (W/Kg)	SAR _{10g} (W/Kg)	Drift (%)	1W Target		Difference percentage		Liquid Temp	Date
						SAR _{1g} (W/Kg)	SAR _{10g} (W/Kg)	1g	10g		
Head	2450	100 mW	55.16	24.15	0.24	5.24	2.40	0.01%	0.01%	20.0	06/14/2022
		Normalize to 1 Watt	5.52	2.41							

12. EUT Testing Position

12.1 Define Two Imaginary Lines on The Handset

(a) The vertical centerline passes through two points on the front side of the handset - the midpoint of the width w_t of the handset at the level of the acoustic output, and the midpoint of the width w_b of the bottom of the handset.

(b) The horizontal line is perpendicular to the vertical centerline and passes through the center of the acoustic output. The horizontal line is also tangential to the face of the handset at point A.

(c) The two lines intersect at point A. Note that for many handsets, point A coincides with the center of the acoustic output; however, the acoustic output may be located elsewhere on the horizontal line. Also note that the vertical centerline is not necessarily parallel to the front face of the handset, especially for clamshell handsets, handsets with flip covers, and other irregularly shaped handsets.

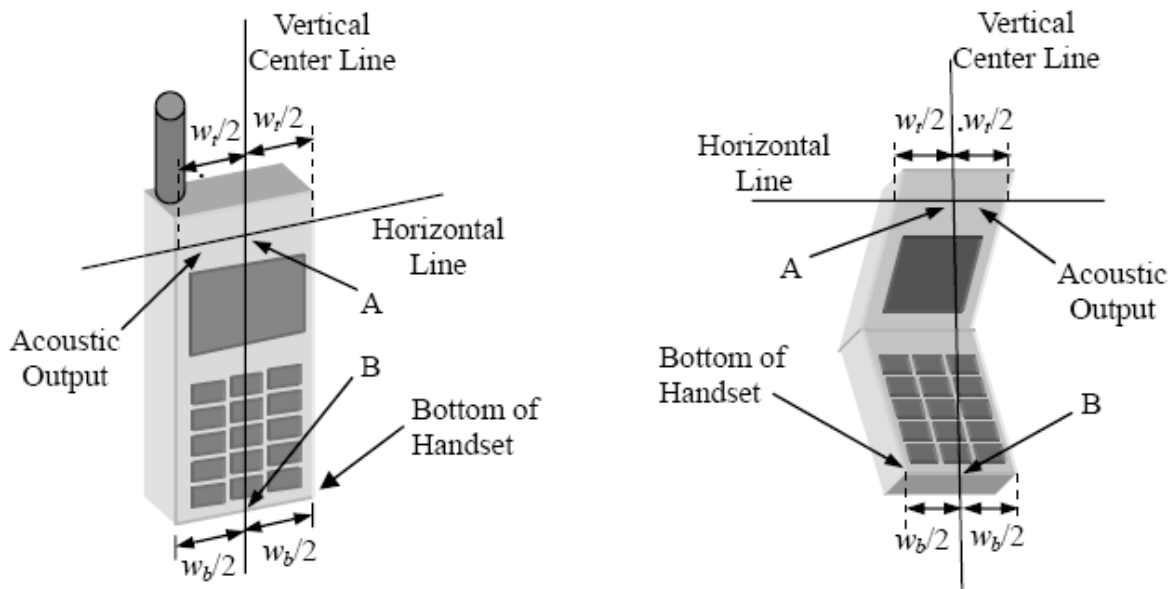

Illustration for Handset Vertical and Horizontal Reference Lines

12.2 Cheek Position

(a) To position the device with the vertical center line of the body of the device and the horizontal line crossing the center piece in a plane parallel to the sagittal plane of the phantom. While maintaining the device in this plane, align the vertical center line with the reference plane containing the three ear and mouth reference point (M: Mouth, RE: Right Ear, and LE: Left Ear) and align the center of the ear piece with the line RE-LE.

(b) To move the device towards the phantom with the ear piece aligned with the line LE-RE until the phone touched the ear. While maintaining the device in the reference plane and maintaining the phone contact with the ear, move the bottom of the phone until any point on the front side is in contact with the cheek of the phantom or until contact with the ear is lost (see below).

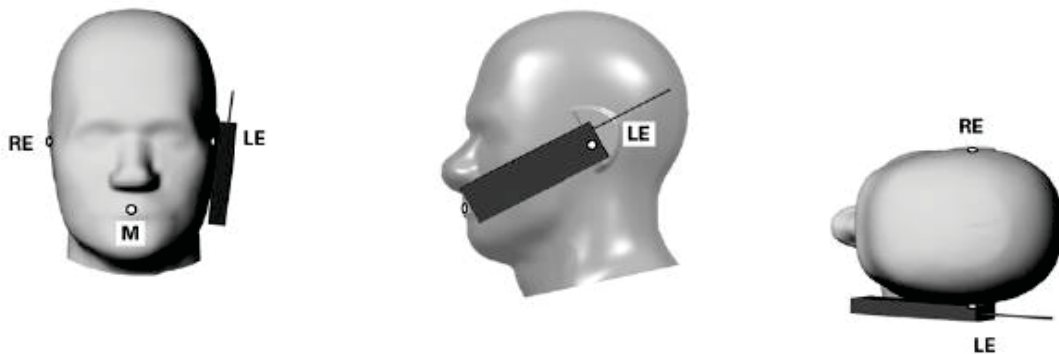

Illustration for Cheek Position

12.3 Tilted Position

(a) To position the device in the “cheek” position described above.

(b) While maintaining the device the reference plane described above and pivoting against the ear, moves it outward away from the mouth by an angle of 15 degrees or until contact with the ear is lost (see below).

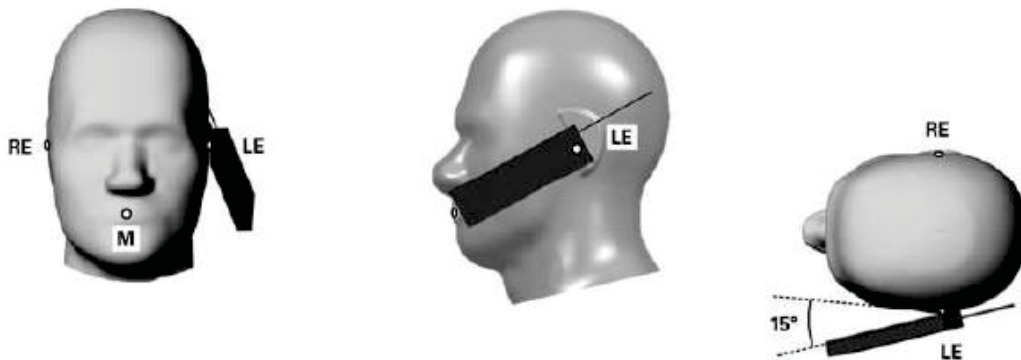

Illustration for Tilted Position

12.4 Body Position

- (a) To position the device parallel to the phantom surface with each side.
- (b) To adjust the device parallel to the flat phantom.
- (c) To adjust the distance between the device surface and the flat phantom to 5mm. a separation distance of 5mm between the phone and the body is used in the measurement conducted for body SAR. This distance represents a typical phone-skin distance when the phone is close to the body e.g. located in pants pocket taking into consideration typical average clothing fabric thickness.

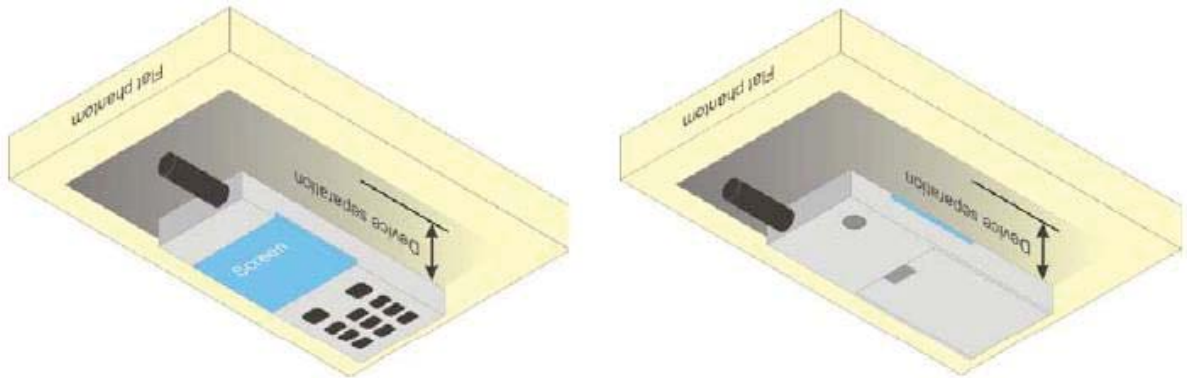
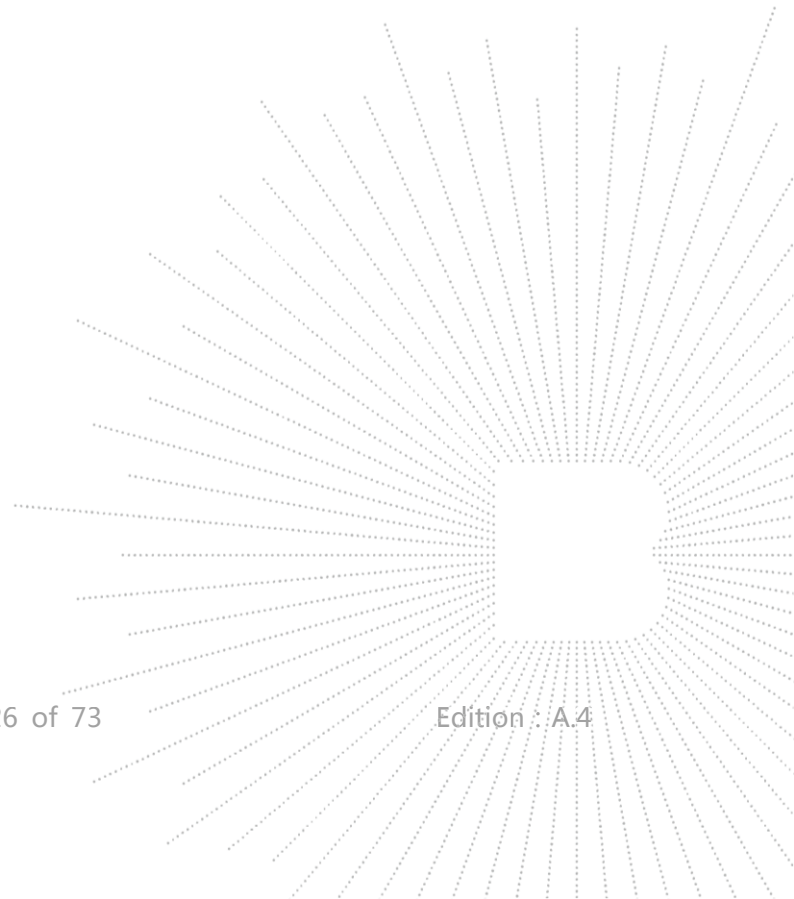

Illustration for Body Worn Position



13. SAR Measurement Procedures

13.1 Measurement Procedures

The measurement procedures are as follows:

- (a) Use base station simulator (if applicable) or engineering software to transmit RF power continuously (continuous Tx) in the highest power channel.
- (b) Keep EUT to radiate maximum output power or 100% factor (if applicable)
- (c) Measure output power through RF cable and power meter.
- (d) Place the EUT in the positions as Annex D demonstrates.
- (e) Set scan area, grid size and other setting on the SATIMO software.
- (f) Measure SAR results for the highest power channel on each testing position.
- (g) Find out the largest SAR result on these testing positions of each band
- (h) Measure SAR results for other channels in worst SAR testing position if the SAR of highest power channel is larger than 0.8 W/kg

According to the test standard, the recommended procedure for assessing the peak spatial-average SAR value consists of the following steps:

- (a) Power reference measurement
- (b) Area scan
- (c) Zoom scan
- (d) Power drift measurement

13.2 Spatial Peak SAR Evaluation

The procedure for spatial peak SAR evaluation has been implemented according to the test standard. It can be conducted for 1g and 10g, as well as for user-specific masses. The SATIMO software includes all numerical procedures necessary to evaluate the spatial peak SAR value.

The base for the evaluation is a "cube" measurement. The measured volume must include the 1g and 10g cubes with the highest averaged SAR values. For that purpose, the center of the measured volume is aligned to the interpolated peak SAR value of a previously performed area scan.

The entire evaluation of the spatial peak values is performed within the post-processing engine. The system always gives the maximum values for the 1g and 10g cubes. The algorithm to find the cube with highest averaged SAR is divided into the following stages:

- (a) Extraction of the measured data (grid and values) from the Zoom Scan
- (b) Calculation of the SAR value at every measurement point based on all stored data
- (c) Generation of a high-resolution mesh within the measured volume
- (d) Interpolation of all measured values from the measurement grid to the high-resolution grid
- (e) Extrapolation of the entire 3D field distribution to the phantom surface over the distance from sensor to surface
- (f) Calculation of the averaged SAR within masses of 1g and 10g

13.3 Area & Zoom Scan Procedures

First Area Scan is used to locate the approximate location(s) of the local peak SAR value(s). The measurement grid within an Area Scan is defined by the grid extent, grid step size and grid offset. Next, in order to determine the EM field distribution in a three-dimensional spatial extension, Zoom Scan is required. The Zoom Scan measures 5x5x7 points with step size 8, 8 and 5 mm for 300 MHz to 3 GHz, and 8x8x8 points with step size 4, 4 and 2.5 mm for 3 GHz to 6 GHz. The Zoom Scan is performed around the highest E-field value to determine the averaged SAR-distribution over 10 g.

13.4 Volume Scan Procedures

The volume scan is used for assess overlapping SAR distributions for antennas transmitting in different frequency bands. It is equivalent to an oversized zoom scan used in standalone measurements. The measurement volume will be used to enclose all the simultaneous transmitting antennas. For antennas transmitting simultaneously in different frequency bands, the volume scan is measured separately in each frequency band. In order to sum correctly to compute the 1g aggregate SAR, the EUT remain in the same test position for all measurements and all volume scan use the same spatial resolution and grid spacing (step-size is 4, 4 and 2.5 mm). When all volume scan were completed, the software can combine and subsequently superpose these measurement data to calculating the multiband SAR.

13.5 SAR Averaged Methods

The local SAR inside the phantom is measured using small dipole sensing elements inside a probe body. The probe tip must not be in contact with the phantom surface in order to minimize measurements errors, but the highest local SAR will occur at the surface of the phantom.

An extrapolation is using to determinate this highest local SAR values. The extrapolation is based on a fourth-order least-square polynomial fit of measured data. The local SAR value is then extrapolated from the liquid surface with a 1mm step.

The measurements have to be performed over a limited time (due to the duration of the battery) so the step of measurement is high. It could vary between 5 and 8 mm. To obtain an accurate assessment of the maximum SAR averaged over 10g and 1 g requires a very fine resolution in the three dimensional scanned data array.

13.6 Power Drift Monitoring

All SAR testing is under the EUT install full charged battery and transmit maximum output power. In SATIMO measurement software, the power reference measurement and power drift measurement procedures are used for monitoring the power drift of EUT during SAR test. Both these procedures

measure the field at a specified reference position before and after the SAR testing. The software will calculate the field difference in dB. If the power drift more than 5%, the SAR will be retested.

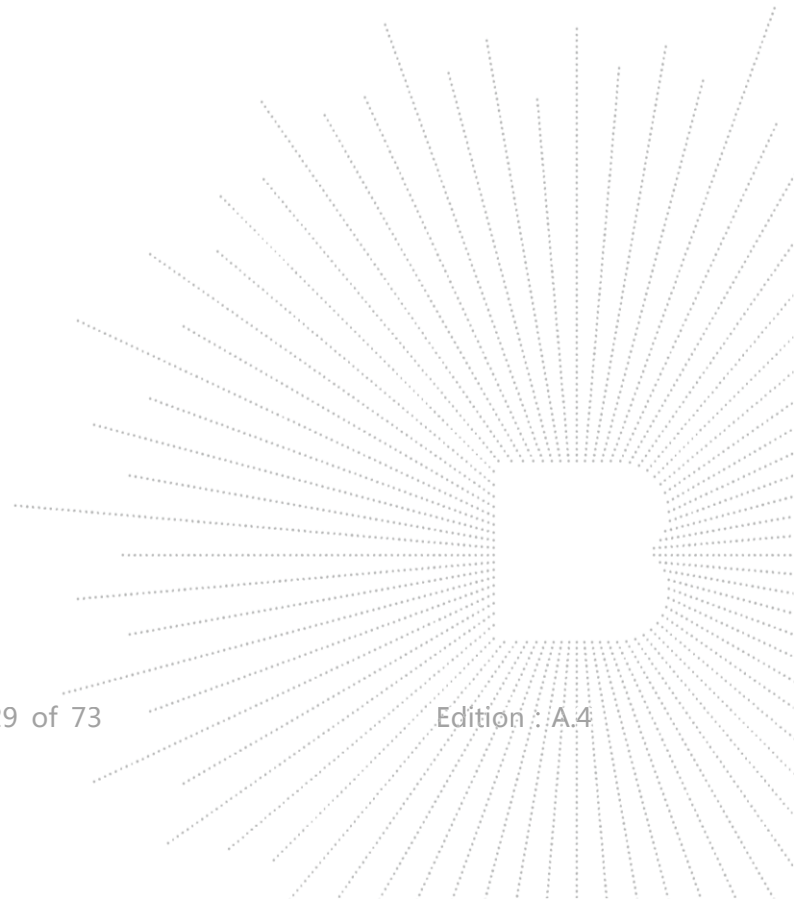

14. SAR Test Result

14.1 Conducted RF Output Power

According KDB 447498 D01 General RF Exposure Guidance v06 Section 4.1 2) states that “Unless it is specified differently in the published RF exposure KDB procedures, these requirements also apply to test reduction and test exclusion considerations. Time-averaged maximum conducted output power applies to SAR and, as required by § 2.1091(c), time-averaged ERP applies to MPE. When an antenna port is not available on the device to support conducted power measurement, such as FRS and certain Part 15 transmitters with built-in integral antennas, the maximum output power allowed for production units should be used to determine RF exposure test exclusion and compliance.”

WIFI2.4G

Test Mode	Frequency(MHz)	Maximum Conducted Output Power(PK) (dBm)
802.11b	2412	15.36
	2437	15.98
	2462	16.05
802.11g	2412	14.67
	2437	15.32
	2462	15.15
802.11n20	2412	14.13
	2437	13.53
	2462	14.06

Note: SAR is not required for the following 2.4 GHz OFDM conditions as the highest reported SAR for DSSS is adjusted by the ratio of OFDM to DSSS specified maximum output power and the adjusted SAR is ≤ 1.2 W/kg.

SRD2.4G

	Frequency	Maximum Conducted Output Power(PK) (dBm)
GFSK	2407 MHz	19.47
	2442 MHz	20.73
	2477 MHz	20.94

14.2 Transmit Antennas and SAR Measurement Position

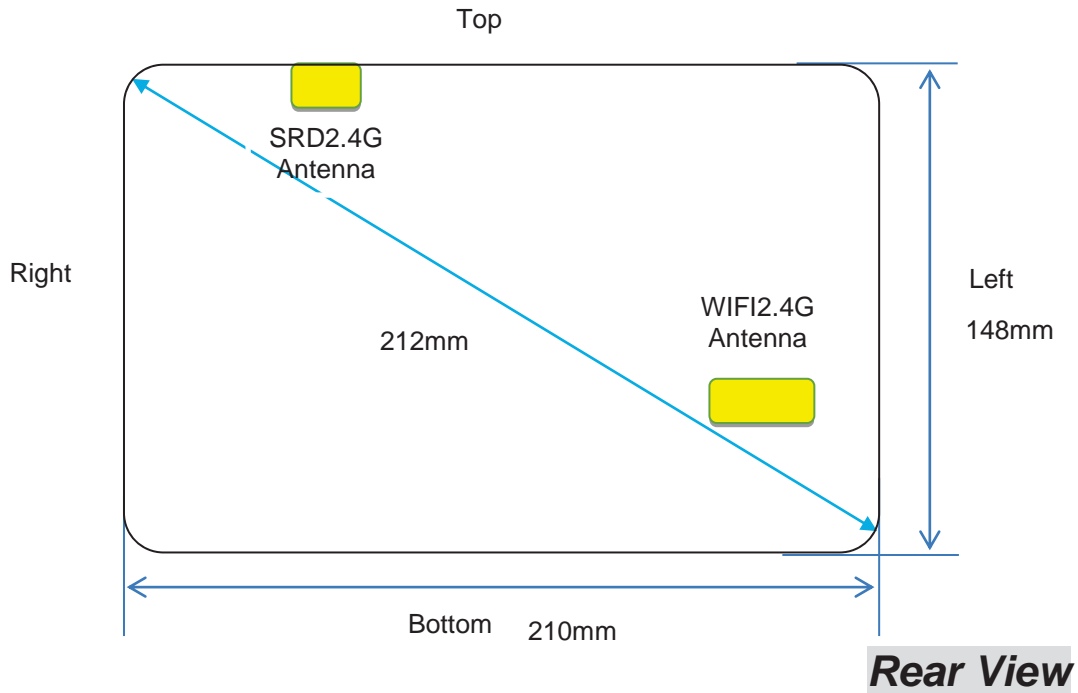

Antenna information:

WIFI2.4G Antenna	TX/RX
SRD2.4G Antenna	TX/RX

Note:

- 1). Per KDB648474 D04, 10-g extremity SAR is not required when Body-Worn mode 1-g reported SAR < 1.2 W/Kg.
- 2). According to the KDB941225 D06 Hot Spot SAR v02, the edges with less than 25 mm distance to the antennas need to be tested for SAR.

Distance of The Antenna to the EUT surface and edge (mm)

Antennas	Front	Back	Top Side	Bottom Side	Left Side	Right Side
WIFI2.4G	<5	<5	75	60	34	137
SRD2.4G	<5	<5	N/A	120	135	28

Positions for SAR tests; Hotspot mode

Antennas	Front	Back	Top Side	Bottom Side	Left Side	Right Side
WIFI2.4G	Yes	Yes	No	No	No	No
SRD2.4G	Yes	Yes	No	No	No	No

General Note: Referring to KDB 941225 D06 v02, When the overall device length and width are 9cm*5cm, the test distance is 0mm, SAR must be measured for all sides and surfaces with a transmitting antenna located with 25mm from that surface or edge.

14.3 Test Results for Standalone SAR Test

The calculated SAR is obtained by the following formula:

$$\text{Reported SAR} = \text{Measured SAR} * 10 \cdot (\text{P}_{\text{target}} - \text{P}_{\text{measured}}) / 10$$

$$\text{Scaling factor} = 10 \cdot (\text{P}_{\text{target}} - \text{P}_{\text{measured}}) / 10$$

$$\text{Reported SAR} = \text{Measured SAR} * \text{Scaling factor}$$

Where

P_{target} is the power of manufacturing upper limit;

P_{measured} is the measured power;

Measured SAR is measured SAR at measured power which including power drift)

Reported SAR which including Power Drift and Scaling factor

Duty Cycle

Test Mode	Duty Cycle
WIFI2.4G	1:1
SRD2.4G	1:1

SAR Values [WIFI2.4G]

Ch.	Freq. (MHz)	Service	Test Position	Conducted Power (dBm)	Maximum Allowed Power (dBm)	Power Drift (%)	Scaling Factor	SAR1-g results(W/kg)		Graph Results
								Measured	Reported	
measured / reported SAR numbers - Body (hotspot open, distance 0mm)										
11	2462	802.11b	Front	16.05	16.50	1.25	1.109	0.010	0.011	
11	2462	802.11b	Rear	16.05	16.50	-3.24	1.109	0.014	0.016	Plot 1

Remark:

1. The value with The bold is the maximum SAR Value of each test band.

2. Per FCC KDB Publication 447498 D01, if the reported (scaled) SAR measured at the middle channel or highest output power channel for each test configuration is ≤ 0.8 W/kg then testing at the other channels is optional for such test configuration(s).

SAR Values [SRD2.4G]

Ch.	Freq. (MHz)	Service	Test Position	Conducted Power (dBm)	Maximum Allowed Power (dBm)	Power Drift (%)	Scaling Factor	SAR1-g results(W/kg)		Graph Results
								Measured	Reported	
measured / reported SAR numbers - Body (hotspot open, distance 0mm)										
High	2477	GFSK	Front1	20.94	21.00	2.32	1.014	0.295	0.299	
High	2477	GFSK	Rear1	20.94	21.00	-0.14	1.014	0.322	0.326	Plot 2
High	2477	GFSK	Front2	20.94	21.00	0.21	1.014	0.250	0.254	
High	2477	GFSK	Rear2	20.94	21.00	1.45	1.014	0.300	0.304	
High	2477	GFSK	Top	20.94	21.00	0.58	1.014	0.210	0.213	

Remark:

1. The value with The bold is the maximum SAR Value of each test band.

2. Per FCC KDB Publication 447498 D01, if the reported (scaled) SAR measured at the middle channel or highest output power channel for each test configuration is ≤ 0.8 W/kg then testing at the other channels is optional for such test configuration(s).

14.4 Standalone SAR Test Exclusion Considerations and Estimated SAR

Per KDB447498 requires when the standalone SAR test exclusion of section 4.3.1 is applied to an antenna that transmits simultaneously with other antennas, the standalone SAR must be estimated according to the following to determine simultaneous transmission SAR test exclusion;

- (max. power of channel, including tune-up tolerance, mW)/(min. test separation distance, mm)] · [√ f(GHz)/x] W/kg for test separation distances ≤ 50 mm; where x = 7.5 for 1-g SAR, and x = 18.75 for 10-g SAR.

- 0.4 W/kg for 1-g SAR and 1.0 W/kg for 10-g SAR, when the test separation distances is > 50 mm

Per FCC KD B447498 D01, simultaneous transmission SAR test exclusion may be applied when the sum of the 1-g SAR for all the transmitting antenna in a specific a physical test configuration is ≤1.6 W/Kg. When the sum is greater than the SAR limit, SAR test exclusion is determined by the SAR to peak location separation ratio.

$$\text{Ratio} = \frac{(SAR_1 + SAR_2)^{1.5}}{(\text{peak location separation, mm})} < 0.04$$

Estimated stand alone SAR					
Communication system	Frequency (MHz)	Configuration	Maximum Power (dBm)	Separation Distance (mm)	Estimated SAR1-g (W/kg)
Bluetooth*	2450	Body-worn	N/A	5	N/A

Remark:

1. Bluetooth*- Including Lower power Bluetooth
2. Maximum average power including tune-up tolerance;
3. When the minimum test separation distance is < 5 mm, a distance of 5 mm is applied to determine SAR test exclusion
4. Body as body use distance is 5mm from manufacturer declaration of user manual

14.5 Simultaneous TX SAR Considerations

Simultaneous transmission SAR test exclusion is determined for each operating configuration and exposure condition according to the reported standalone SAR of each applicable simultaneous transmitting antenna. The device has 1 antenna, WWAN main antenna.;

Application Simultaneous Transmission information:

Combination No.	Mode
1	WIFI2.4G+SRD2.4G

The maximum superposition value is 0.342W/kg.

14.6 SAR Measurement Variability

According to KDB865664, Repeated measurements are required only when the measured SAR is ≥ 0.80 W/kg. If the measured SAR value of the initial repeated measurement is < 1.45 W/kg with ≤ 20% variation, only one repeated measurement is required to reaffirm that the results are not expected to have substantial variations, which may introduce significant compliance concerns. A second repeated measurement is required only if the measured result for the initial repeated measurement is within 10% of the SAR limit and vary by more than 20%, which are often related to device and measurement setup difficulties. The following procedures are applied to determine if repeated measurements are required. The same

procedures should be adapted for measurements according to extremity and occupational exposure limits by applying a factor of 2.5 for extremity exposure and a factor of 5 for occupational exposure to the corresponding SAR thresholds.19 The repeated measurement results must be clearly identified in the SAR report. All measured SAR, including the repeated results, must be considered to determine compliance and for reporting according to KDB 690783. Repeated measurement is not required when the original highest measured SAR is < 0.80 W/kg; steps 2) through 4) do not apply.

- 1) When the original highest measured SAR is ≥ 0.80 W/kg, repeat that measurement once.
- 2) Perform a second repeated measurement only if the ratio of largest to smallest SAR for the original and first repeated measurements is > 1.20 or when the original or repeated measurement is ≥ 1.45 W/kg (~ 10% from the 1-g SAR limit).
- 3) Perform a third repeated measurement only if the original, first or second repeated measurement is ≥ 1.5 W/kg and the ratio of largest to smallest SAR for the original, first and second repeated measurements is > 1.20 .
- 4) Perform a third repeated measurement only if the original, first or second repeated measurement is ≥ 1.5 W/kg and the ratio of largest to smallest SAR for the original, first and second repeated measurements is > 1.20 .

Frequency Band (MHz)	Air Interface	RF Exposure Configuration	Test Position	Repeated SAR (yes/no)	Highest Measured SAR1-g (W/kg)	First Repeated	
						Measured SAR1-g (W/kg)	Largest to Smallest SAR Ratio
2462	WiFi2.4G	Standalone	Body-Rear	no	0.014	n/a	n/a
2477	SRD2.4G	Standalone	Body-Rear	no	0.322	n/a	n/a

Remark:

1. Second Repeated Measurement is not required since the ratio of the largest to smallest SAR for the original and first repeated measurement is not > 1.20 or 3 (1-g or 10-g respectively)

14.7 General description of test procedures

1. The DUT is tested using CMU 200 communications testers as controller unit to set test channels and maximum output power to the DUT, as well as for measuring the conducted peak power.
2. Test positions as described in the tables above are in accordance with the specified test standard.
3. Tests in body position were performed in that configuration, which generates the highest time based averaged output power (see conducted power results).
4. Tests in head position with GSM were performed in voice mode with 1 timeslot unless GPRS/EGPRS/DTM function allows parallel voice and data traffic on 2 or more timeslots.
5. UMTS was tested in RMC mode with 12.2 kbit/s and TPC bits set to 'all 1'.
6. WiFi was tested in 802.11b/g/n mode with 1 Mbit/s and 6 Mbit/s. According to KDB 248227 the SAR testing for 802.11g/n is not required since When the highest reported SAR for DSSS is adjusted by the ratio of OFDM to DSSS specified maximum output power and the adjusted SAR is ≤ 1.2 W/kg.
7. Required WiFi test channels were selected according to KDB 248227
8. According to FCC KDB pub 248227 D01, When there are multiple test channels with the same measured maximum output power, the channel closest to mid-band frequency is selected for SAR measurement and when there are multiple test channels with the same measured maximum output power and equal separation from mid-band frequency; for example, high and low channels or two mid-band channels, the higher frequency (number) channel is selected for SAR measurement.
9. According to FCC KDB pub 941225 D06 this device has been tested with 10 mm distance to the phantom for operation in WiFi hot spot mode.



10. Per FCC KDB pub 941225 D06 the edges with antennas within 2.5 cm are required to be evaluated for SAR to cover WiFi hot spot function.
11. According to IEEE 1528 the SAR test shall be performed at middle channel. Testing of top and bottom channel is optional.
12. According to KDB 447498 D01 testing of other required channels within the operating mode of a frequency band is not required when the reported 1-g or 10-g SAR for the mid-band or highest output power channel is:
 - ≤ 0.8 W/kg or 2.0 W/kg, for 1-g or 10-g respectively, when the transmission band is ≤ 100 MHz
 - ≤ 0.6 W/kg or 1.5 W/kg, for 1-g or 10-g respectively, when the transmission band is between 100 MHz and 200 MHz
 - ≤ 0.4 W/kg or 1.0 W/kg, for 1-g or 10-g respectively, when the transmission band is ≥ 200 MHz
13. IEEE 1528 require the middle channel to be tested first. This generally applies to wireless devices that are designed to operate in technologies with tight tolerances for maximum output power variations across channels in the band.
14. Per KDB648474 D04 require when the reported SAR for a body-worn accessory, measured without a headset connected to the handset, is < 1.2 W/kg.
15. Per KDB648474 D04 require when the separation distance required for body-worn accessory testing is larger than or equal to that tested for hotspot mode, using the same wireless mode test configuration for voice and data, such as UMTS, LTE and Wi-Fi, and for the same surface of the phone, the hotspot mode SAR data may be used to support body-worn accessory SAR compliance for that particular configuration (surface)
16. 10-g extremity SAR is required only for the surfaces and edges with hotspot mode 1-g SAR > 1.2 W/kg.
17. Per KDB648474 D04 require for phablet SAR test considerations · For Smart phones with a display diagonal dimension > 15.0 cm or an overall diagonal dimension > 16.0 cm, When hotspot mode applies, 10-g extremity SAR is required only for the surfaces and edges with hotspot mode 1-g reported SAR > 1.2 W/kg.
18. 10-g extremity SAR is required only for the surfaces and edges with hotspot mode 1-g SAR > 1.2 W/kg.

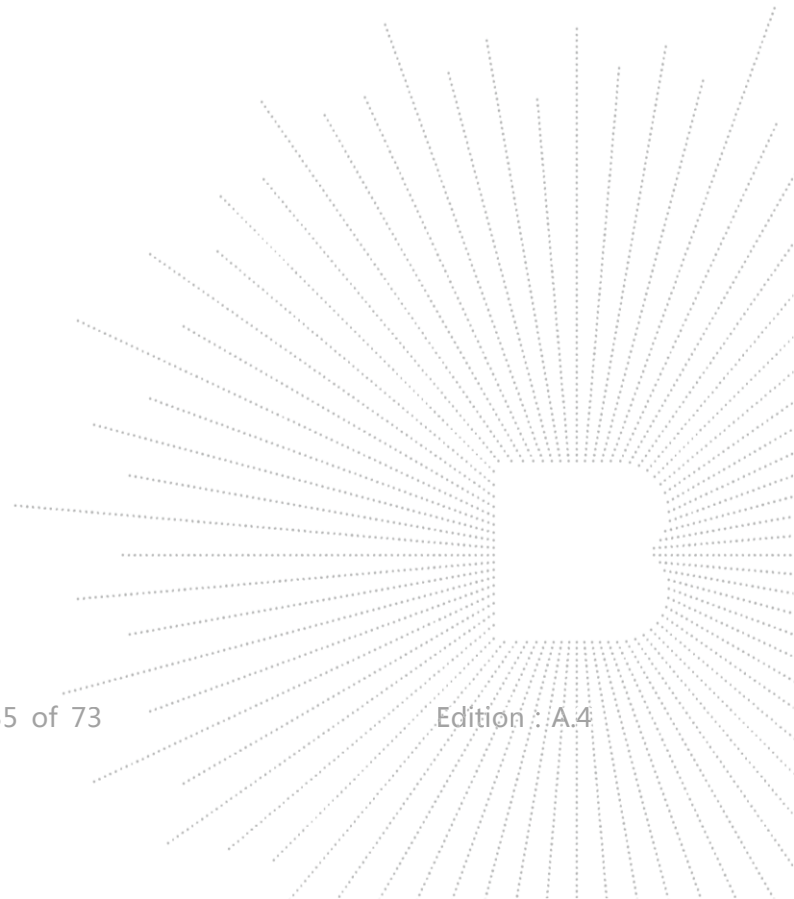

15. Test Plots

15.1 System Performance Check

System check at 2450 MHz

A. Experimental conditions.

Probe	SN EPGO362
ConvF	26.43
Area Scan	dx=10mm dy=10mm, Adaptive 2 max
Zoom Scan	5x5x7,dx=8mm dy=8mm dz=5mm,Very fast
Phantom	Validation plane
Device Position	Dipole
Band	CW2450
Channels	Middle
Signal	CW (Crest factor: 1.0)

B. Permittivity

Frequency (MHz)	2450.000
Relative permittivity (real part)	52.700
Relative permittivity (imaginary part)	14.330
Conductivity (S/m)	1.950

C. SAR Surface and Volume

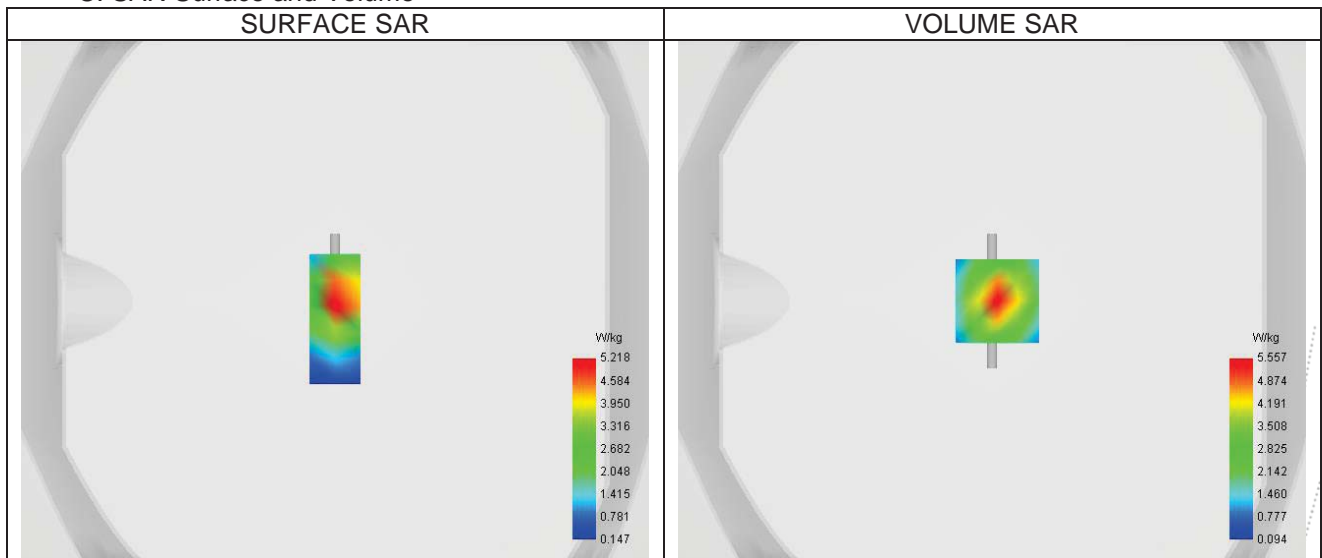

Maximum location: X=2.00, Y=0.00 ; SAR Peak: 9.11 W/kg

D. SAR 1g & 10g

SAR 10g (W/Kg)	2.457
SAR 1g (W/Kg)	5.085
Variation (%)	0.360
Horizontal validation criteria: minimum distance (mm)	0.000000
Vertical validation criteria: SAR ratio M2/M1 (%)	0.000000

E. Z Axis Scan

Z (mm)	0.00	4.00	9.00	14.00	19.00
SAR (W/Kg)	9.121	5.557	2.866	1.459	0.770

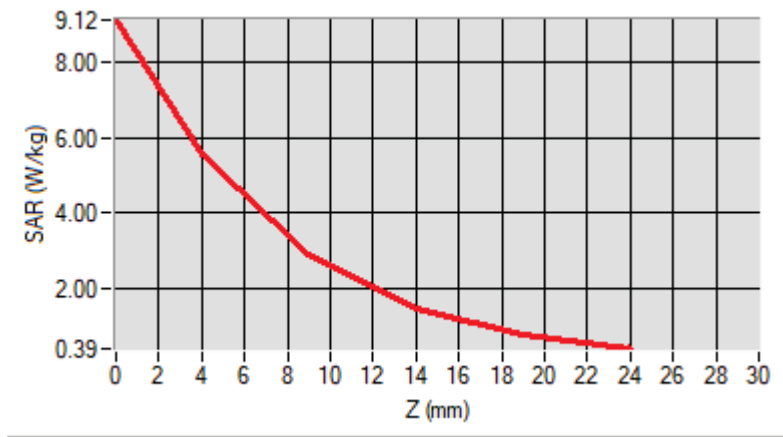

F. 3D Image

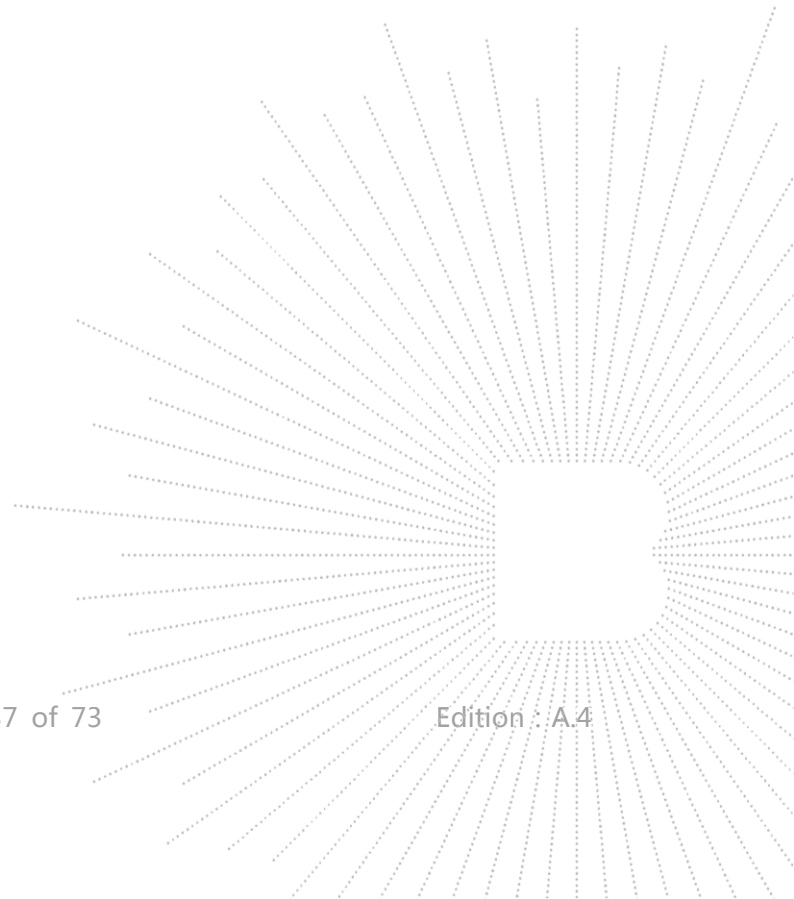
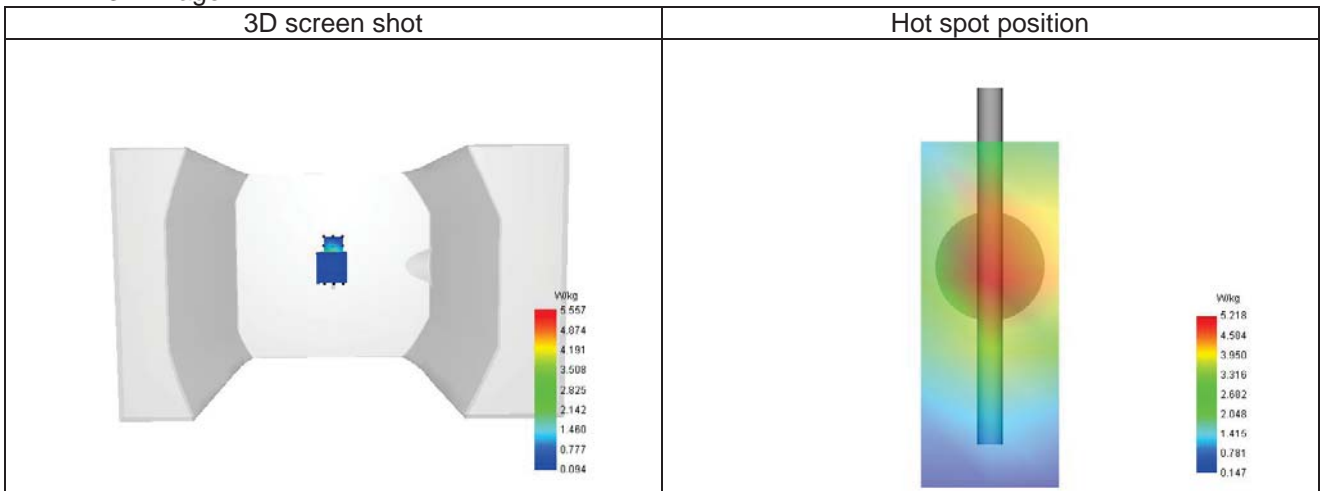

15.2 SAR Test Graph Results

SAR plots for the highest measured SAR in each exposure configuration, wireless mode and frequency band combination according to FCC KDB 865664 D02

Plot 1

A. Experimental conditions.

Probe	SN EPG0362
ConvF	25.73
Area Scan	surf_sam_plan.txt
Zoom Scan	5x5x7,dx=8mm dy=8mm dz=5mm,Very fast
Phantom	Validation plane
Device Position	Body
Band	IEEE 802.11b ISM
Channels	High (11)
Signal	IEEE802.b (Crest factor: 1.0)

B. Permittivity

Frequency (MHz)	2462.000
Relative permittivity (real part)	39.226
Relative permittivity (imaginary part)	13.207
Conductivity (S/m)	1.788

C. SAR Surface and Volume

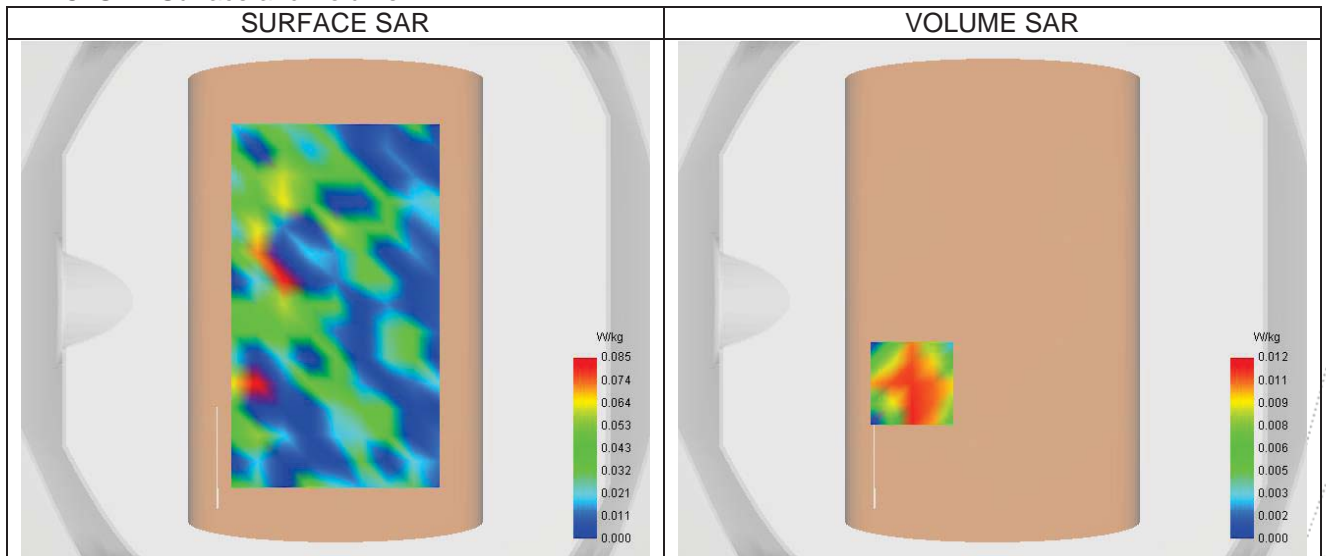

Maximum location: X=-31.00, Y=-32.00 ; SAR Peak: 0.04 W/kg

D. SAR 1g & 10g

SAR 10g (W/Kg)	0.009
SAR 1g (W/Kg)	0.014
Variation (%)	-3.240
Horizontal validation criteria: minimum distance (mm)	0.000000
Vertical validation criteria: SAR ratio M2/M1 (%)	0.000000

E. Z Axis Scan

Z (mm)	0.00	4.00	9.00	14.00	19.00
--------	------	------	------	-------	-------

SAR (W/Kg)	0.041	0.012	0.005	0.005	0.000
------------	-------	-------	-------	-------	-------

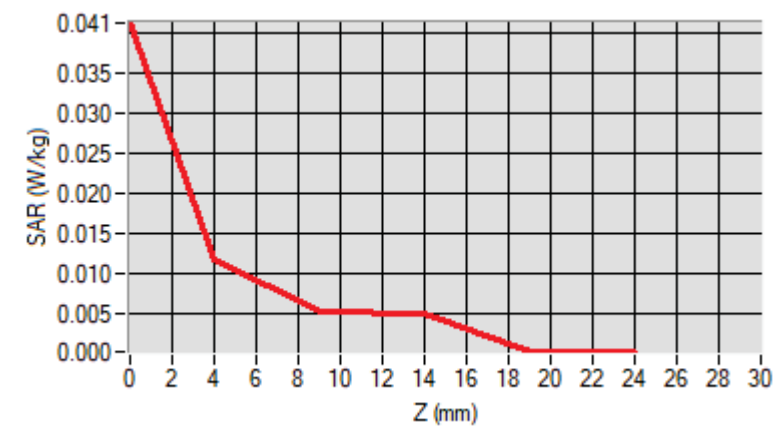

F. 3D Image

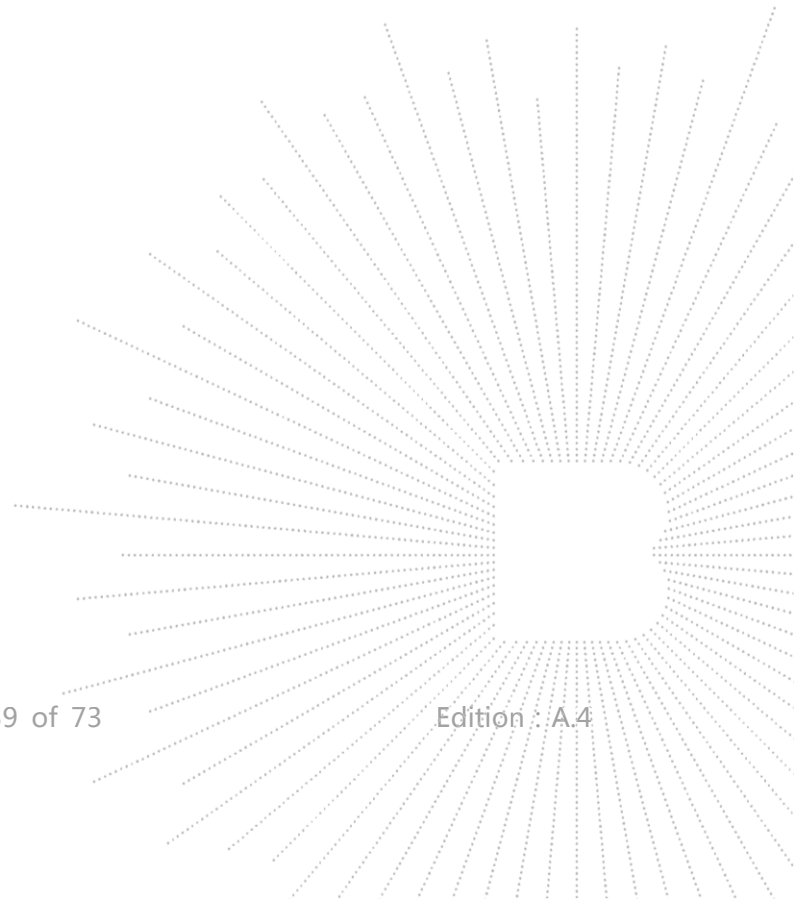
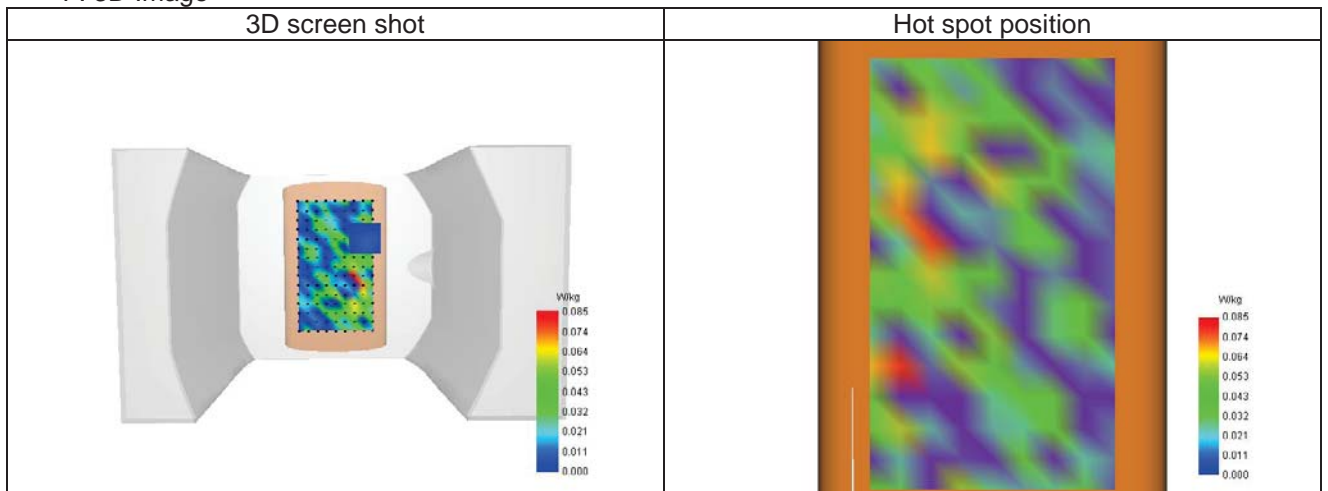

Plot 2

A. Experimental conditions.

Probe	SN EPG0362
ConvF	25.73
Area Scan	surf_sam_plan.txt
Zoom Scan	5x5x7,dx=8mm dy=8mm dz=5mm,Very fast
Phantom	Validation plane
Device Position	Body
Band	SRD2.4G
Channels	High
Signal	SRD2.4G (Crest factor: 1.0)

B. Permittivity

Frequency (MHz)	2477.000
Relative permittivity (real part)	39.226
Relative permittivity (imaginary part)	13.207
Conductivity (S/m)	1.788

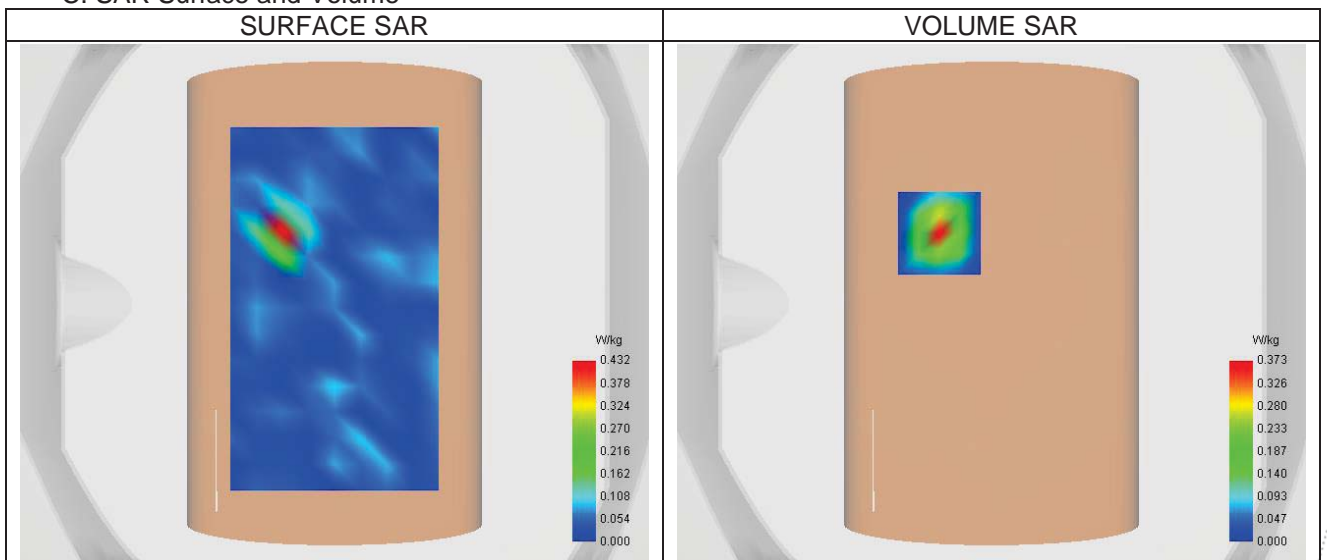
C. SAR Surface and Volume

Maximum location: X=-20.00, Y=27.00 ; SAR Peak: 0.67 W/kg

D. SAR 1g & 10g

SAR 10g (W/Kg)	0.133
SAR 1g (W/Kg)	0.322
Variation (%)	-0.140
Horizontal validation criteria: minimum distance (mm)	0.000000
Vertical validation criteria: SAR ratio M2/M1 (%)	0.000000

E. Z Axis Scan

Z (mm)	0.00	4.00	9.00	14.00	19.00
SAR (W/Kg)	0.661	0.373	0.169	0.073	0.032

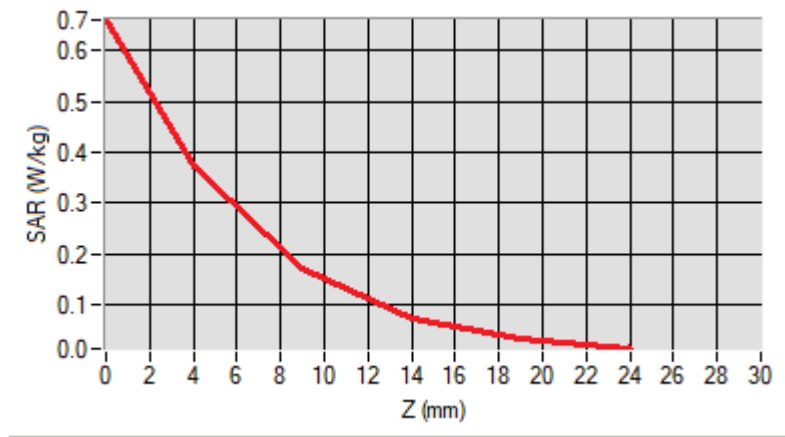

F. 3D Image

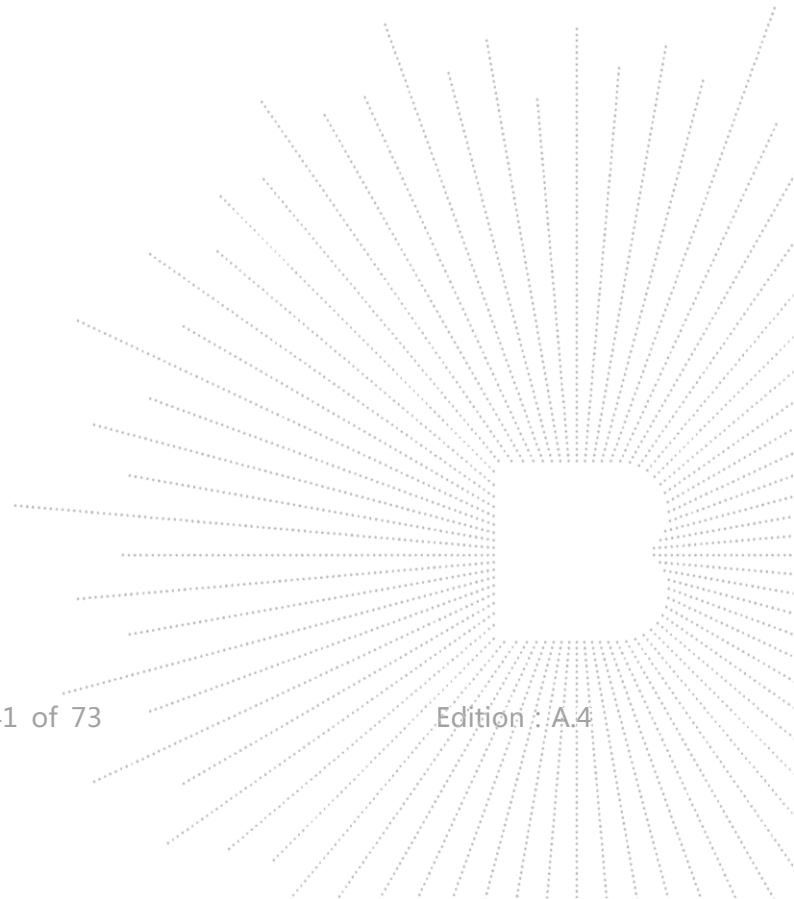
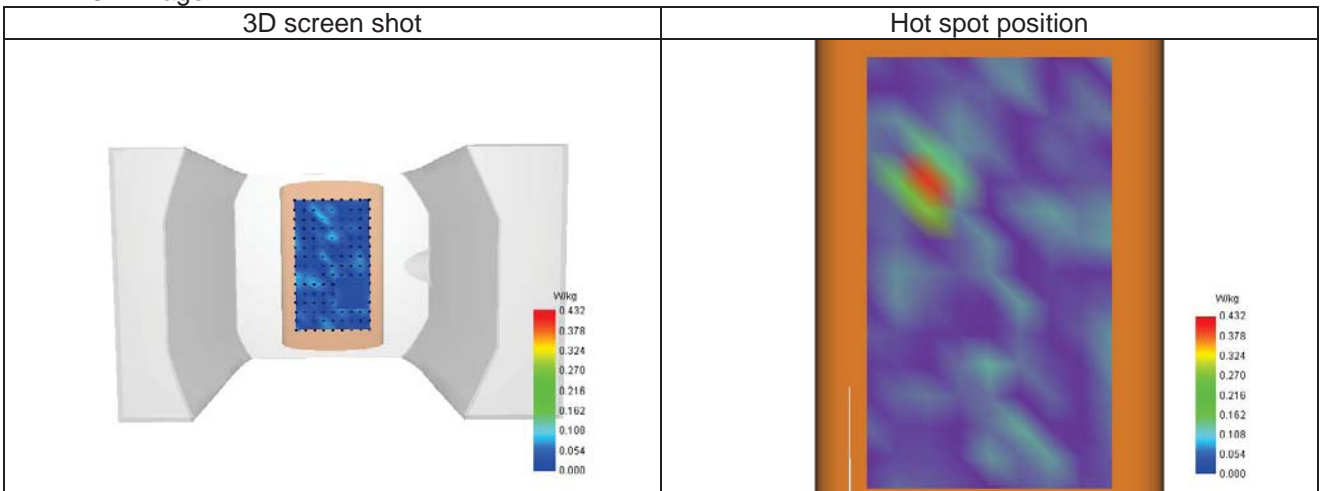

16. CALIBRATION CERTIFICATES

Probe-EPGO362 Calibration Certificate
SID2450Dipole Calibration Certificate

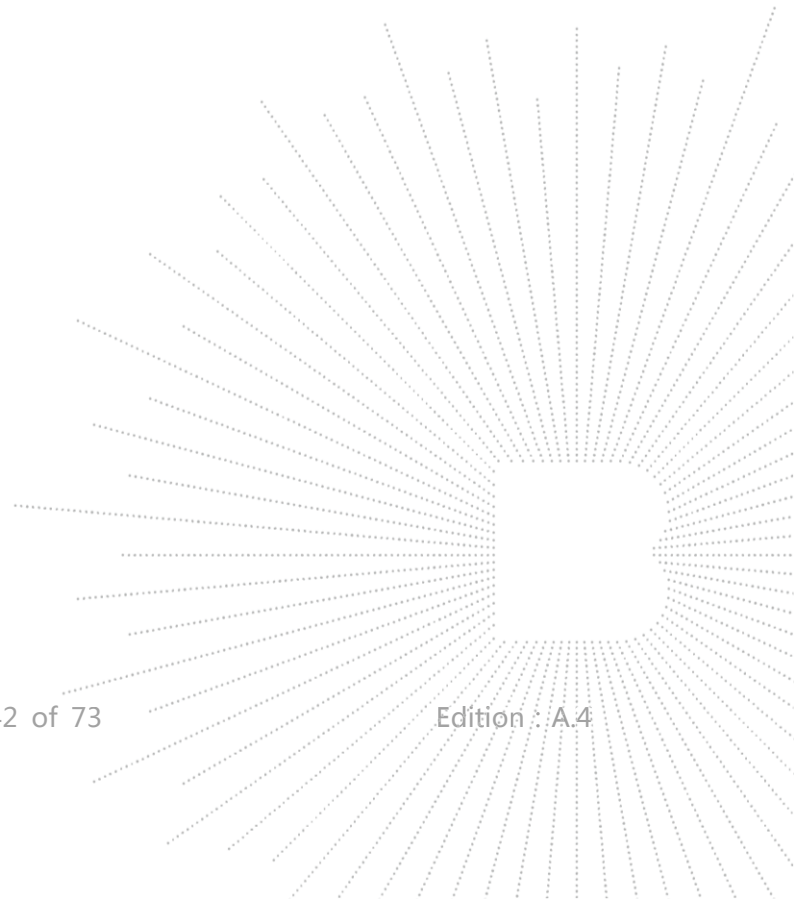

**COMOSAR E-Field Probe Calibration Report**

Ref : ACR.329.6.21.BES.A

SHENZHEN BCTC TECHNOLOGY CO., LTD.
1 ~2/ F, NO. B FACTORY BUILDING, PENGZHOU
INDUSTRIAL PARK, FUYUAN 1ST ROAD,
TANGWEI COMMUNITY, FUHAI STREET, BAO'AN
DISTRICT, SHENZHEN, GUANGDONG, CHINA
MVG COMOSAR DOSIMETRIC E-FIELD PROBE
SERIAL NO.: SN 46/21 EPGO362

Calibrated at MVG
Z.I. de la pointe du diable
Technopôle Brest Iroise – 295 avenue Alexis de Rochon
29280 PLOUZANE - FRANCE

Calibration date: 11/25/2021

Accreditations #2-6789
Scope available on www.cofrac.fr

The use of the Cofrac brand and the accreditation references is prohibited from any reproduction.

Summary:

This document presents the method and results from an accredited COMOSAR E-Field Probe calibration performed at MVG, using the CALIPROBE test bench, for use with a MVG COMOSAR system only. The test results covered by accreditation are traceable to the International System of Units (SI).

Page: 1/11



	<i>Name</i>	<i>Function</i>	<i>Date</i>	<i>Signature</i>
<i>Prepared by :</i>	Jérôme Luc	Technical Manager	11/25/2021	<i>JL</i>
<i>Checked by :</i>	Jérôme Luc	Technical Manager	11/25/2021	<i>JL</i>
<i>Approved by :</i>	Yann Toutain	Laboratory Director	11/25/2021	<i>Yann TOUTAIN</i>

2021.11.25
 11:50:23 +01'00'

	<i>Customer Name</i>
<i>Distribution :</i>	Shenzhen BCTC Technology Co., Ltd.

<i>Issue</i>	<i>Name</i>	<i>Date</i>	<i>Modifications</i>
A	Jérôme Luc	11/25/2021	Initial release

Page: 2/11

Template_ACR.DDD.N.YY.MVGB.ISSUE_COMOSAR Probe vE

This document shall not be reproduced, except in full or in part, without the written approval of MVG. The information contained herein is to be used only for the purpose for which it is submitted and is not to be released in whole or part without written approval of MVG.

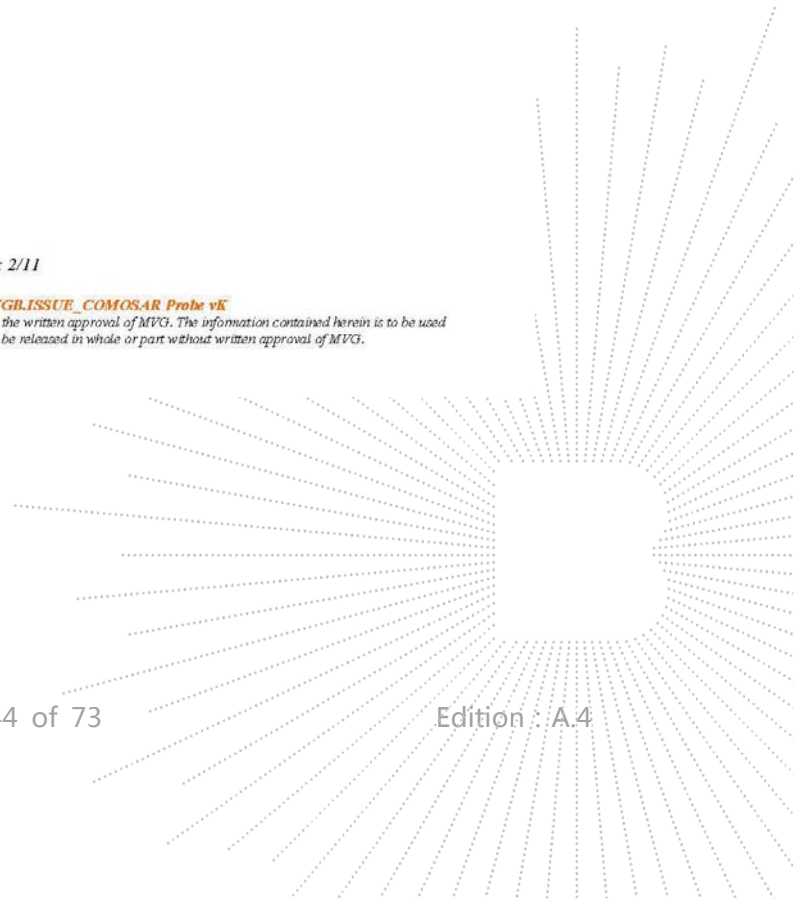

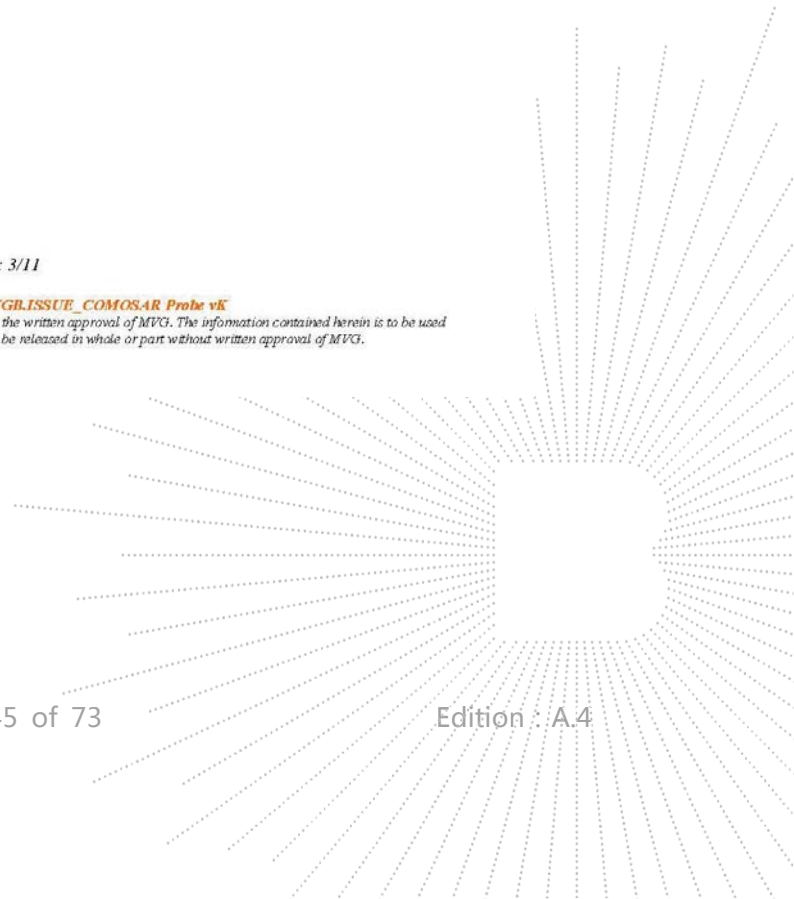

TABLE OF CONTENTS

1	Device Under Test	4
2	Product Description	4
2.1	General Information	4
3	Measurement Method	4
3.1	Linearity	4
3.2	Sensitivity	4
3.3	Lower Detection Limit	5
3.4	Isotropy	5
3.1	Boundary Effect	5
4	Measurement Uncertainty	6
5	Calibration Measurement Results	6
5.1	Sensitivity in air	6
5.2	Linearity	7
5.3	Sensitivity in liquid	8
5.4	Isotropy	9
6	List of Equipment	10

Page: 3/11

Template_ACR.DDD.N.YY.MVGB.ISSUE_COMOSAR Probe vE

This document shall not be reproduced, except in full or in part, without the written approval of MVG. The information contained herein is to be used only for the purpose for which it is submitted and is not to be released in whole or part without written approval of MVG.





1 DEVICE UNDER TEST

Device Under Test	
Device Type	COMOSAR DOSIMETRIC E FIELD PROBE
Manufacturer	MVG
Model	SSE2
Serial Number	SN 46/21 EPGO362
Product Condition (new / used)	New
Frequency Range of Probe	0.15 GHz-6GHz
Resistance of Three Dipoles at Connector	Dipole 1: R1=0.221 MΩ Dipole 2: R2=0.231 MΩ Dipole 3: R3=0.212 MΩ

2 PRODUCT DESCRIPTION

2.1 GENERAL INFORMATION

MVG's COMOSAR E field Probes are built in accordance to the IEC/IEEE 62209-1528 and FCC KDB865664 D01 standards.



Figure 1 – MVG COMOSAR Dosimetric E field Probe

Probe Length	330 mm
Length of Individual Dipoles	2 mm
Maximum external diameter	8 mm
Probe Tip External Diameter	2.5 mm
Distance between dipoles / probe extremity	1 mm

3 MEASUREMENT METHOD

The IEC/IEEE 62209-1528 and FCC KDB865664 D01 standards provide recommended practices for the probe calibrations, including the performance characteristics of interest and methods by which to assess their affect. All calibrations / measurements performed meet the fore mentioned standards.

3.1 LINEARITY

The evaluation of the linearity was done in free space using the waveguide, performing a power sweep to cover the SAR range 0.01W/kg to 100W/kg.

3.2 SENSITIVITY

The sensitivity factors of the three dipoles were determined using a two step calibration method (air and tissue simulating liquid) using waveguides as outlined in the standards.

Page: 4/11

Template_ACR.DDD.N.YY.MVGB.ISSUE_COMOSAR Probe vE

This document shall not be reproduced, except in full or in part, without the written approval of MVG. The information contained herein is to be used only for the purpose for which it is submitted and is not to be released in whole or part without written approval of MVG.



3.3 LOWER DETECTION LIMIT

The lower detection limit was assessed using the same measurement set up as used for the linearity measurement. The required lower detection limit is 10 mW/kg.

3.4 ISOTROPY

The axial isotropy was evaluated by exposing the probe to a reference wave from a standard dipole with the dipole mounted under the flat phantom in the test configuration suggested for system validations and checks. The probe was rotated along its main axis from 0 to 360 degrees in 15-degree steps. The hemispherical isotropy is determined by inserting the probe in a thin plastic box filled with tissue-equivalent liquid, with the plastic box illuminated with the fields from a half wave dipole. The dipole is rotated about its axis (0°–180°) in 15° increments. At each step the probe is rotated about its axis (0°–360°).

3.1 BOUNDARY EFFECT

The boundary effect is defined as the deviation between the SAR measured data and the expected exponential decay in the liquid when the probe is oriented normal to the interface. To evaluate this effect, the liquid filled flat phantom is exposed to fields from either a reference dipole or waveguide. With the probe normal to the phantom surface, the peak spatial average SAR is measured and compared to the analytical value at the surface.

The boundary effect uncertainty can be estimated according to the following uncertainty approximation formula based on linear and exponential extrapolations between the surface and $d_{be} + d_{step}$ along lines that are approximately normal to the surface:

$$SAR_{uncertainty} [\%] = \Delta SAR_{be} \frac{(d_{be} + d_{step})^2}{2d_{step}} \frac{(e^{-d_{be}/\delta})}{\delta/2} \quad \text{for } (d_{be} + d_{step}) < 10 \text{ mm}$$

where

$SAR_{uncertainty}$	is the uncertainty in percent of the probe boundary effect
d_{be}	is the distance between the surface and the closest <i>zoom-scan</i> measurement point, in millimetre
Δ_{step}	is the separation distance between the first and second measurement points that are closest to the phantom surface, in millimetre, assuming the boundary effect at the second location is negligible
δ	is the minimum penetration depth in millimetres of the head tissue-equivalent liquids defined in this standard, i.e., $\delta \approx 14$ mm at 3 GHz,
ΔSAR_{be}	in percent of SAR is the deviation between the measured SAR value, at the distance d_{be} from the boundary, and the analytical SAR value.

The measured worst case boundary effect $SAR_{uncertainty}[\%]$ for scanning distances larger than 4mm is 1.0% Limit ,2%).

Page: 5/11

Template_ACR.DDD.N.YY.MVGB.ISSUE_COMOSAR Probe vE

This document shall not be reproduced, except in full or in part, without the written approval of MVG. The information contained herein is to be used only for the purpose for which it is submitted and is not to be released in whole or part without written approval of MVG.

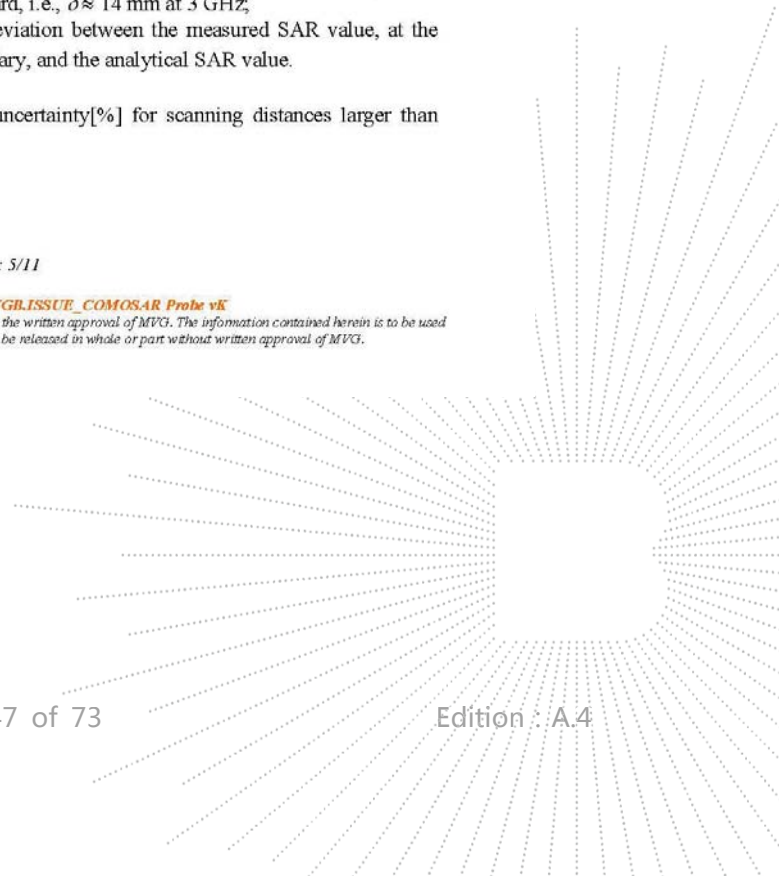



4 MEASUREMENT UNCERTAINTY

The guidelines outlined in the IEC/IEEE 62209-1528 and FCC KDB865664 D01 standards were followed to generate the measurement uncertainty associated with an E-field probe calibration using the waveguide technique. All uncertainties listed below represent an expanded uncertainty expressed at approximately the 95% confidence level using a coverage factor of $k=2$, traceable to the Internationally Accepted Guides to Measurement Uncertainty.

Uncertainty analysis of the probe calibration in waveguide					
ERROR SOURCES	Uncertainty value (%)	Probability Distribution	Divisor	ci	Standard Uncertainty (%)
Expanded uncertainty 95 % confidence level $k = 2$					14 %

5 CALIBRATION MEASUREMENT RESULTS

Calibration Parameters	
Liquid Temperature	20 +/- 1 °C
Lab Temperature	20 +/- 1 °C
Lab Humidity	30-70 %

5.1 SENSITIVITY IN AIR

Normx dipole 1 ($\mu\text{V}/(\text{V}/\text{m}^2)$)	Normy dipole 2 ($\mu\text{V}/(\text{V}/\text{m}^2)$)	Normz dipole 3 ($\mu\text{V}/(\text{V}/\text{m}^2)$)
1.25	0.74	1.41

DCP dipole 1 (mV)	DCP dipole 2 (mV)	DCP dipole 3 (mV)
110	107	107

Calibration curves $e_i=f(V)$ ($i=1,2,3$) allow to obtain E-field value using the formula:

$$E = \sqrt{E_1^2 + E_2^2 + E_3^2}$$

Page: 6/11

Template_ACR.DDD.N.YY.MVGB.ISSUE_COMOSAR_Probe vE

This document shall not be reproduced, except in full or in part, without the written approval of MVG. The information contained herein is to be used only for the purpose for which it is submitted and is not to be released in whole or part without written approval of MVG.

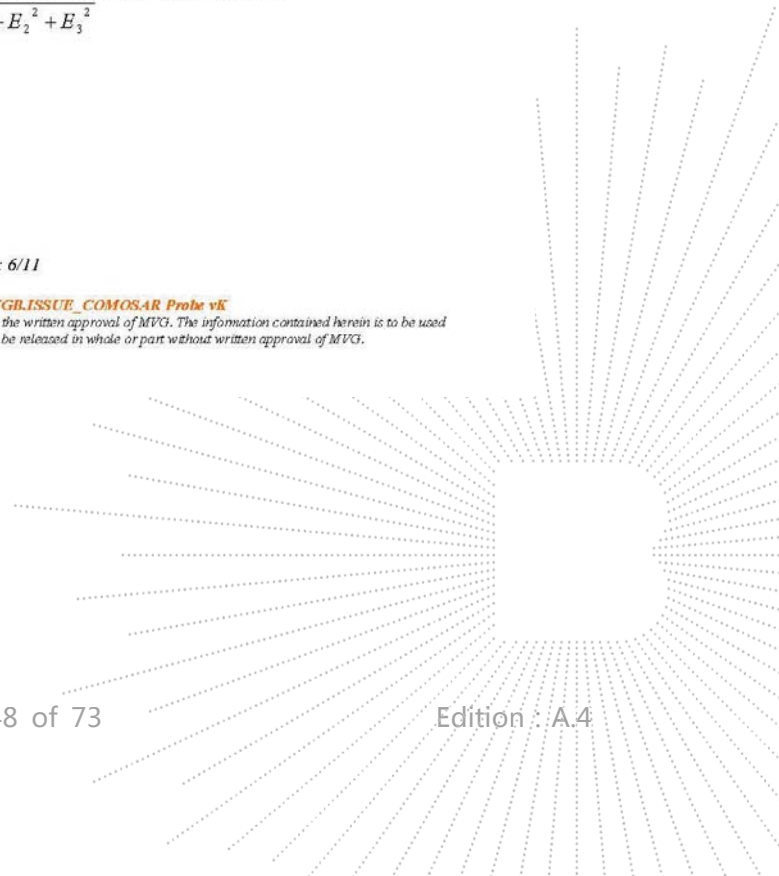

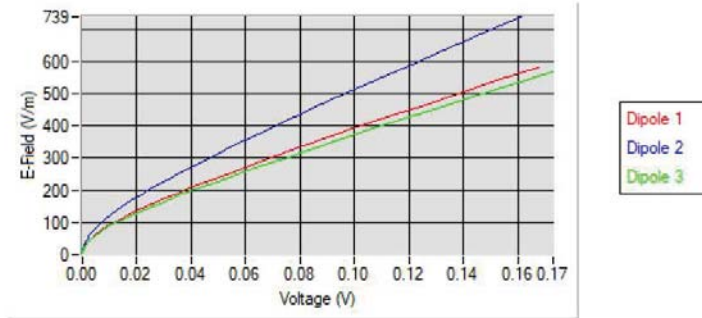
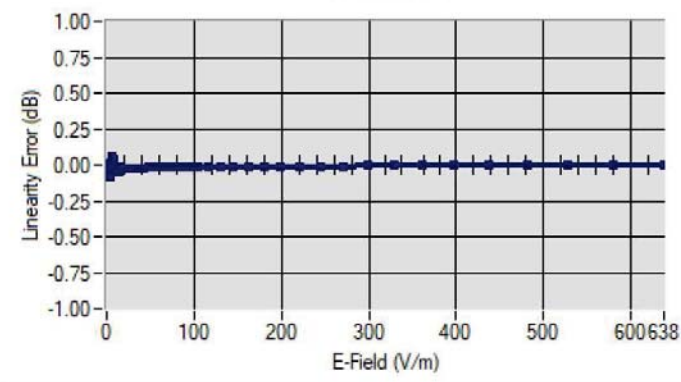

Calibration curves

 5.2 LINEARITY
Linearity

Linearity: +/-1.89% (+/-0.08dB)

Page: 7/11

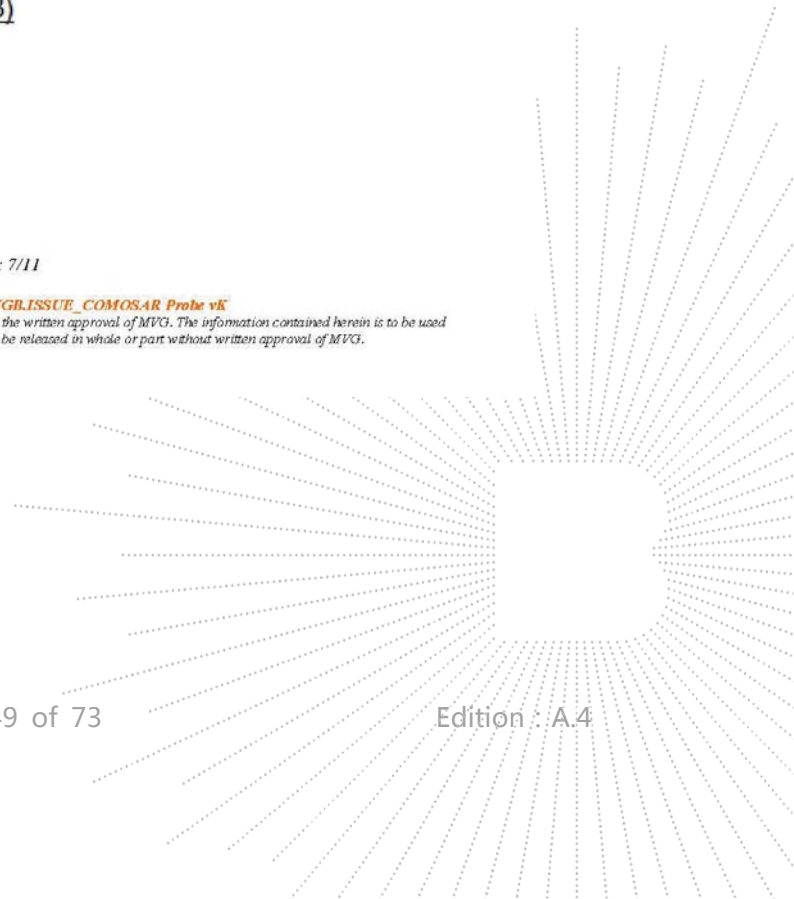
Template_ACR.DDD.N.YY.MVGB.ISSUE_COMOSAR_Probe vE

This document shall not be reproduced, except in full or in part, without the written approval of MVG. The information contained herein is to be used only for the purpose for which it is submitted and is not to be released in whole or part without written approval of MVG.



 5.3 SENSITIVITY IN LIQUID

Liquid	Frequency (MHz +/- 100MHz)	ConvF
HL450*	450	2.13
BL450*	450	2.08
HL750	750	2.04
BL750	750	2.12
HL850	835	2.08
BL850	835	2.17
HL900	900	2.13
BL900	900	2.22
HL1800	1800	2.35
BL1800	1800	2.72
HL1900	1900	2.50
BL1900	1900	2.96
HL2100	2100	2.63
BL2100	2100	3.12
HL2300	2300	2.95
BL2300	2300	3.41
HL2450	2450	2.99
BL2450	2450	3.38
HL2600	2600	2.87
BL2600	2600	2.98
HL5200	5200	2.78
BL5200	5200	2.90
HL5400	5400	2.63
BL5400	5400	2.75
HL5600	5600	2.59
BL5600	5600	2.55
HL5800	5800	2.59
BL5800	5800	2.70

* Frequency not covered by COFRAC scope, calibration not accredited

LOWER DETECTION LIMIT: 8mW/kg

Page: 8/11

Template_ACR.DDD.N.YY.MVGB.ISSUE_COMOSAR_Probe vE

This document shall not be reproduced, except in full or in part, without the written approval of MVG. The information contained herein is to be used only for the purpose for which it is submitted and is not to be released in whole or part without written approval of MVG.

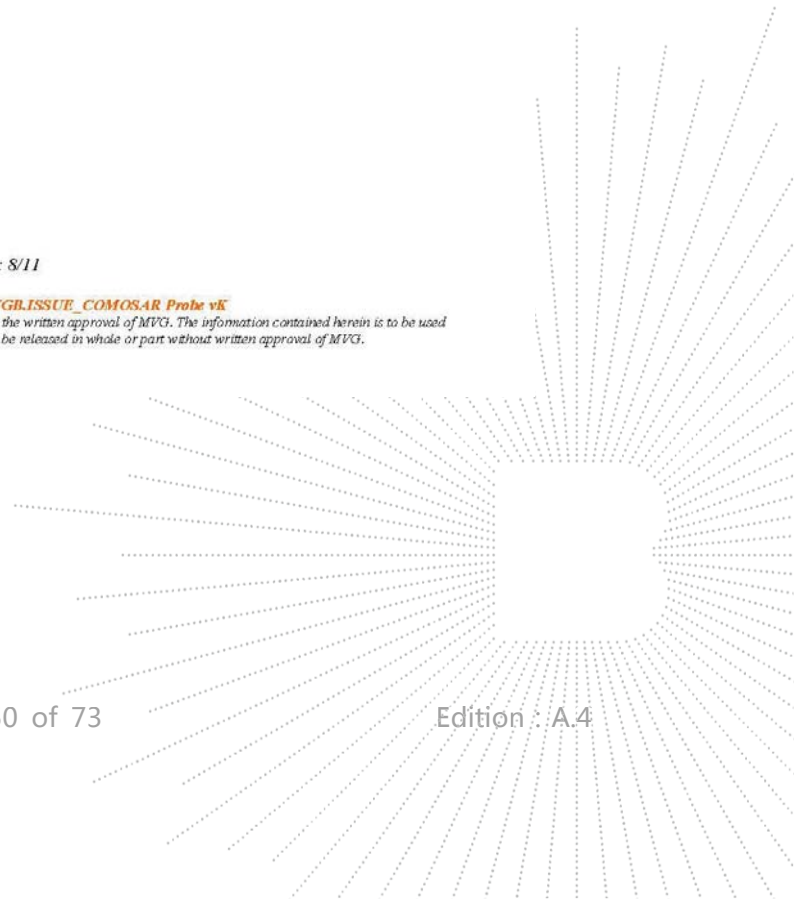

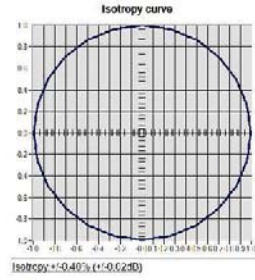

 5.4 ISOTROPY
HL1800 MHz

Page: 9/11

Template_ACR.DDD.N.YY.MVGB.ISSUE_COMOSAR Probe vE

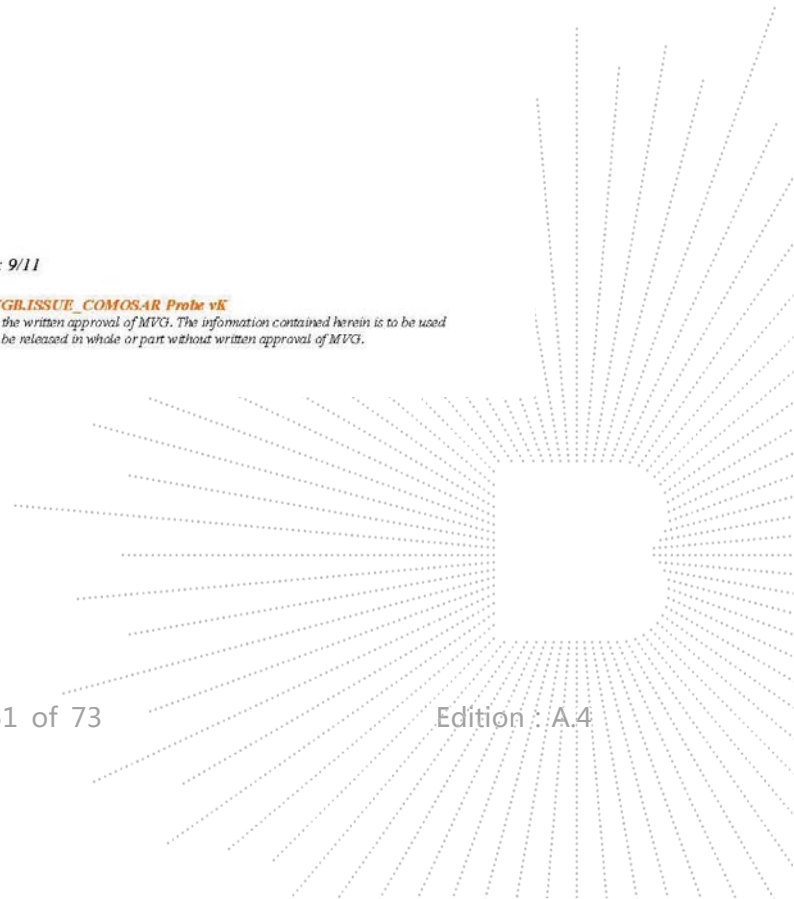
This document shall not be reproduced, except in full or in part, without the written approval of MVG. The information contained herein is to be used only for the purpose for which it is submitted and is not to be released in whole or part without written approval of MVG.



6 LIST OF EQUIPMENT

Equipment Summary Sheet				
Equipment Description	Manufacturer / Model	Identification No.	Current Calibration Date	Next Calibration Date
CALIPROBE Test Bench	Version 2	NA	Validated. No cal required.	Validated. No cal required.
Network Analyzer	Rohde & Schwarz ZVM	100203	08/2021	08/2024
Network Analyzer	Agilent 8753ES	MY40003210	10/2019	10/2022
Network Analyzer – Calibration kit	Rohde & Schwarz ZV-Z235	101223	05/2019	05/2022
Network Analyzer – Calibration kit	HP 85033D	3423A08186	06/2021	06/2027
Multimeter	Keithley 2000	1160271	02/2020	02/2023
Signal Generator	Rohde & Schwarz SMB	106589	04/2019	04/2022
Amplifier	MVG	MODU-023-C-0002	Characterized prior to test. No cal required.	Characterized prior to test. No cal required.
Power Meter	NI-USB 5680	170100013	06/2021	06/2024
Power Meter	Rohde & Schwarz NRVD	832839-056	11/2019	11/2022
Directional Coupler	Krytar 158020	131467	Characterized prior to test. No cal required.	Characterized prior to test. No cal required.
Waveguide	MVG	SN 32/16 WG4_1	Validated. No cal required.	Validated. No cal required.
Liquid transition	MVG	SN 32/16 WGLIQ_0G900_1	Validated. No cal required.	Validated. No cal required.
Waveguide	MVG	SN 32/16 WG6_1	Validated. No cal required.	Validated. No cal required.
Liquid transition	MVG	SN 32/16 WGLIQ_1G500_1	Validated. No cal required.	Validated. No cal required.
Waveguide	MVG	SN 32/16 WG8_1	Validated. No cal required.	Validated. No cal required.
Liquid transition	MVG	SN 32/16 WGLIQ_1G800B_1	Validated. No cal required.	Validated. No cal required.
Liquid transition	MVG	SN 32/16 WGLIQ_1G800H_1	Validated. No cal required.	Validated. No cal required.
Waveguide	MVG	SN 32/16 WG10_1	Validated. No cal required.	Validated. No cal required.
Liquid transition	MVG	SN 32/16 WGLIQ_3G500_1	Validated. No cal required.	Validated. No cal required.

Page: 10/11

Template_ACR.DDD.N.YY.MVGBISSUE_COMOSAR Probe vE

This document shall not be reproduced, except in full or in part, without the written approval of MVG. The information contained herein is to be used only for the purpose for which it is submitted and is not to be released in whole or part without written approval of MVG.

COMOSAR E-FIELD PROBE CALIBRATION REPORT

Ref: ACR.90.1.21.BES.A

Waveguide	MVG	SN 32/16 WG12_1	Validated. No cal required.	Validated. No cal required.
Liquid transition	MVG	SN 32/16 WGLIQ_5G000_1	Validated. No cal required.	Validated. No cal required.
Temperature / Humidity Sensor	Testo 184 H1	44225320	06/2021	06/2024

Page: 11/11

Template_ACR.DDD.N.YY.MVGR.ISSUE_COMOSAR Probe vK

This document shall not be reproduced, except in full or in part, without the written approval of MVG. The information contained herein is to be used only for the purpose for which it is submitted and is not to be released in whole or part without written approval of MVG.

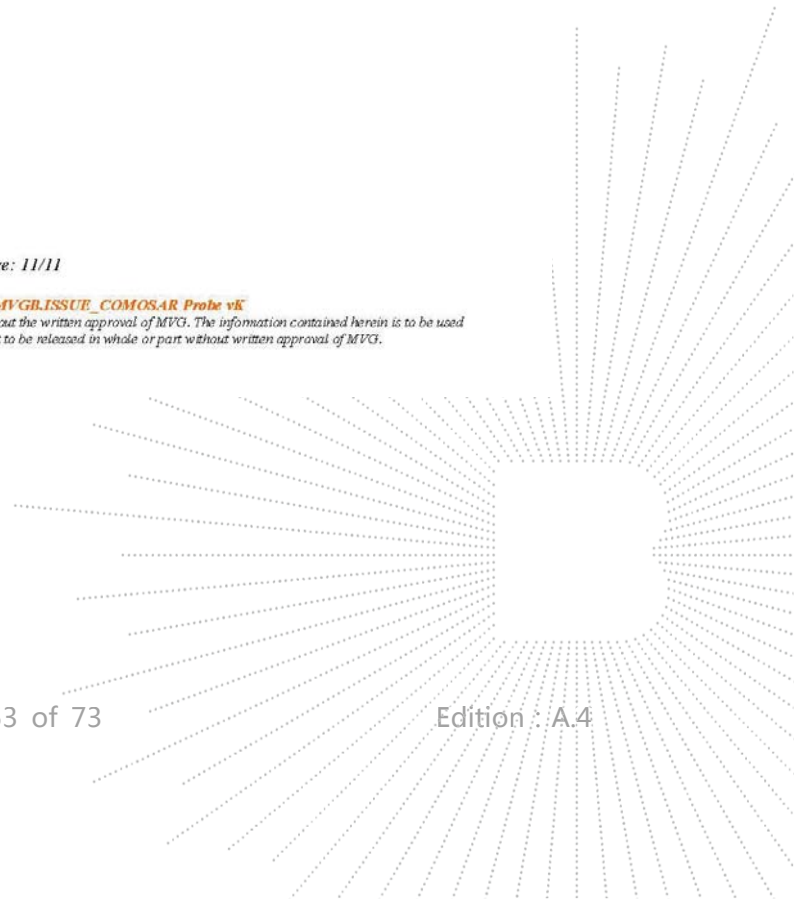

**SAR Reference Dipole Calibration Report**

Ref : ACR.329.15.21.BES.A

SHENZHEN BCTC TECHNOLOGY CO., LTD.
1 ~2/ F, NO. B FACTORY BUILDING, PENGZHOU
INDUSTRIAL PARK, FUYUAN 1ST ROAD,
TANGWEI COMMUNITY, FUHAI STREET, BAO'AN
DISTRICT, SHENZHEN, GUANGDONG, CHINA
MVG COMOSAR REFERENCE DIPOLE
FREQUENCY: 2450 MHZ
SERIAL NO.: SN 47/21 DIP 2G450-627

Calibrated at MVG
Z.I. de la pointe du diable
Technopôle Brest Iroise – 295 avenue Alexis de Rochon
29280 PLOUZANE - FRANCE

Calibration date: 11/25/2021



Accreditations #2-6789 and #2-6814
Scope available on www.cofrac.fr

The use of the Cofrac brand and the accreditation references is prohibited from any reproduction.

Summary:

This document presents the method and results from an accredited SAR reference dipole calibration performed in MVG using the COMOSAR test bench. All calibration results are traceable to national metrology institutions.

Page: 1/13



	<i>Name</i>	<i>Function</i>	<i>Date</i>	<i>Signature</i>
<i>Prepared by :</i>	Jérôme Luc	Technical Manager	11/25/2021	<i>JL</i>
<i>Checked by :</i>	Jérôme Luc	Technical Manager	11/25/2021	<i>JL</i>
<i>Approved by :</i>	Yann Toutain	Laboratory Director	11/25/2021	<i>Yann TOUTAIN</i>

2021.11.25
11:58:11 +01'00'

	<i>Customer Name</i>
<i>Distribution :</i>	Shenzhen BCTC Technology Co., Ltd.

<i>Issue</i>	<i>Name</i>	<i>Date</i>	<i>Modifications</i>
A	Jérôme Luc	11/25/2021	Initial release

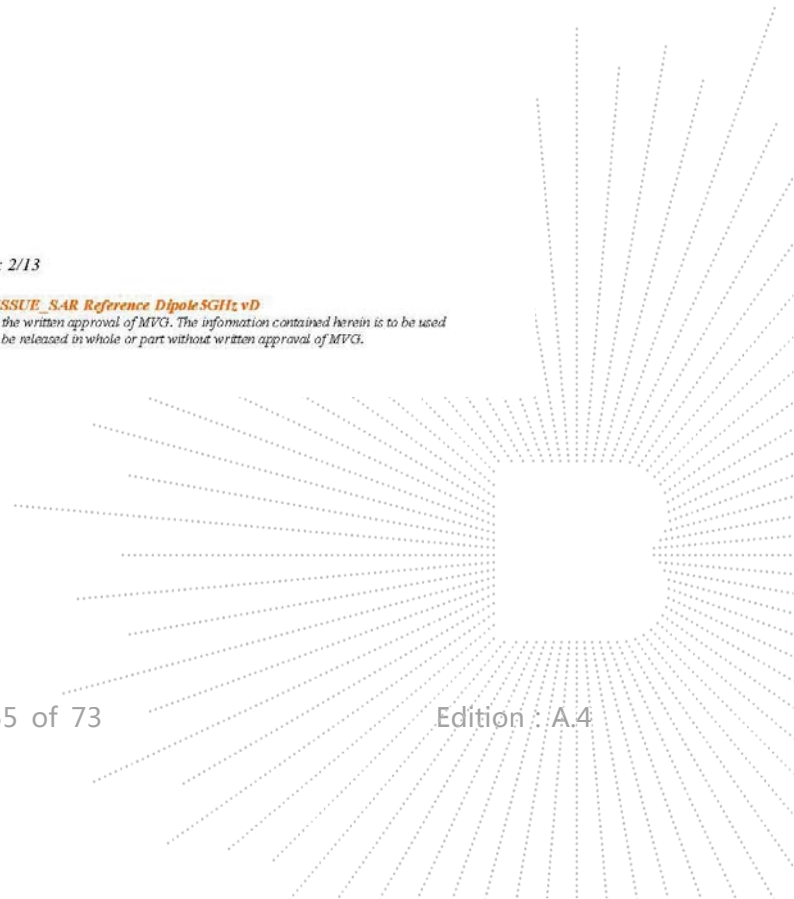

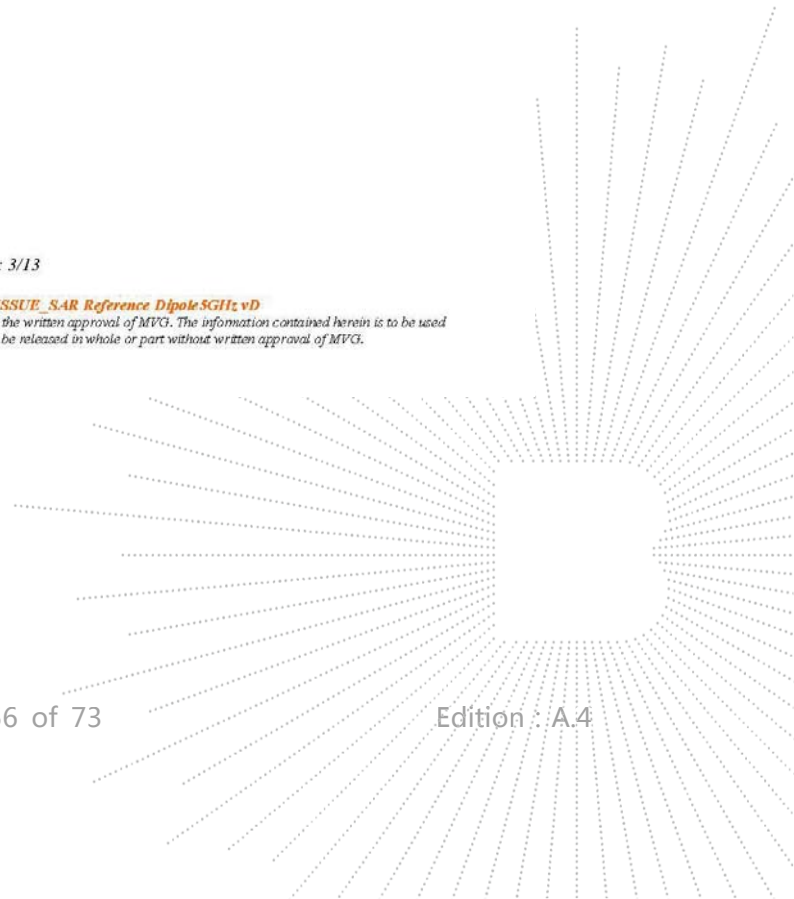

TABLE OF CONTENTS

1	Introduction.....	4
2	Device Under Test	4
3	Product Description	4
3.1	General Information	4
4	Measurement Method	4
4.1	Return Loss Requirements	5
4.2	Mechanical Requirements	5
5	Measurement Uncertainty	5
5.1	Return Loss	5
5.2	Dimension Measurement	5
5.3	Validation Measurement	5
6	Calibration Measurement Results	6
6.1	Return Loss	6
6.2	Mechanical Dimensions	7
7	Validation measurement	7
7.1	Head Liquid Measurement	7
7.2	Measurement Result	8
7.3	Body Measurement Result	10
8	List of Equipment	13

Page: 3/13

Template_ACR.DDD.N.YY.MVGB.ISSUE_SAR Reference DipoleSGHt.vD

This document shall not be reproduced, except in full or in part, without the written approval of MVG. The information contained herein is to be used only for the purpose for which it is submitted and is not to be released in whole or part without written approval of MVG.





1 INTRODUCTION

This document contains a summary of the requirements set forth by the IEC/IEEE 62209-1528 and FCC KDB865664 D01 standards for reference dipoles used for SAR measurement system validations and the measurements that were performed to verify that the product complies with the fore mentioned standards.

2 DEVICE UNDER TEST

Device Under Test	
Device Type	COMOSAR 5200-5800 MHz REFERENCE DIPOLE
Manufacturer	MVG
Model	SID5000
Serial Number	SN 47/21 DIP 5G000-629
Product Condition (new / used)	New

3 PRODUCT DESCRIPTION

3.1 GENERAL INFORMATION

MVG's COMOSAR Validation Dipoles are built in accordance to the IEC/IEEE 62209-1528 and FCC KDB865664 D01 standards. The product is designed for use with the COMOSAR test bench only.



Figure 1 – MVG COMOSAR Validation Dipole

Page: 4/13

Template_ACR.DDD.N.YY.MVGB.ISSUE_SAR Reference Dipole SGHt.vD

This document shall not be reproduced, except in full or in part, without the written approval of MVG. The information contained herein is to be used only for the purpose for which it is submitted and is not to be released in whole or part without written approval of MVG.



4 MEASUREMENT METHOD

The IEC/IEEE 62209-1528 and FCC KDB865664 D01 standards provide requirements for reference dipoles used for system validation measurements. The following measurements were performed to verify that the product complies with the fore mentioned standards.

4.1 RETURN LOSS REQUIREMENTS

The dipole used for SAR system validation measurements and checks must have a return loss of -20 dB or better. The return loss measurement shall be performed against a liquid filled flat phantom, with the phantom constructed as outlined in the fore mentioned standards. A direct method is used with a network analyser and its calibration kit, both with a valid ISO17025 calibration.

4.2 MECHANICAL REQUIREMENTS

The IEC/IEEE 62209-1528 and FCC KDB865664 D01 standards specify the mechanical components and dimensions of the validation dipoles, with the dimension's frequency and phantom shell thickness dependent. The COMOSAR test bench employs a 2 mm phantom shell thickness therefore the dipoles sold for use with the COMOSAR test bench comply with the requirements set forth for a 2 mm phantom shell thickness. A direct method is used with a ISO17025 calibrated caliper.

5 MEASUREMENT UNCERTAINTY

All uncertainties listed below represent an expanded uncertainty expressed at approximately the 95% confidence level using a coverage factor of k=2, traceable to the Internationally Accepted Guides to Measurement Uncertainty.

5.1 RETURN LOSS

The following uncertainties apply to the return loss measurement:

Frequency band	Expanded Uncertainty on Return Loss
400-6000MHz	0.08 LIN

5.2 DIMENSION MEASUREMENT

The following uncertainties apply to the dimension measurements:

Length (mm)	Expanded Uncertainty on Length
0 - 300	0.20 mm

5.3 VALIDATION MEASUREMENT

The guidelines outlined in the IEC/IEEE 62209-1528 and FCC KDB865664 D01 standards were followed to generate the measurement uncertainty for validation measurements.

Scan Volume	Expanded Uncertainty
1 g	19 % (SAR)
10 g	19 % (SAR)

Page: 5/13

Template_ACR.DDD.N.YY.MVGB.ISSUE_SAR Reference Dipole SGHz vD

This document shall not be reproduced, except in full or in part, without the written approval of MVG. The information contained herein is to be used only for the purpose for which it is submitted and is not to be released in whole or part without written approval of MVG.

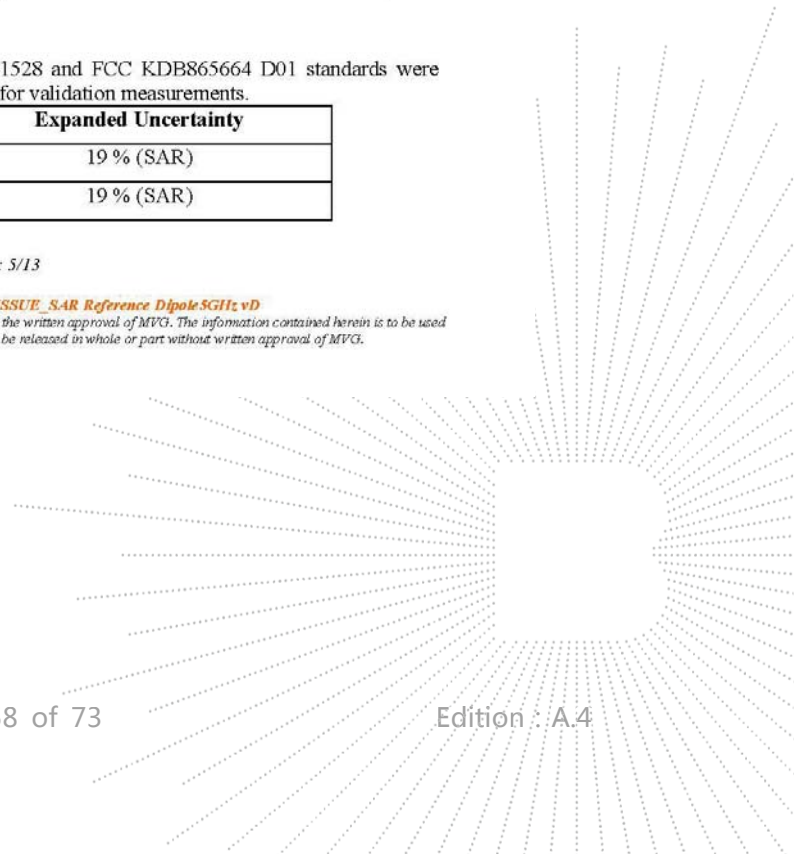



6 CALIBRATION MEASUREMENT RESULTS

6.1 RETURN LOSS IN HEAD LIQUID

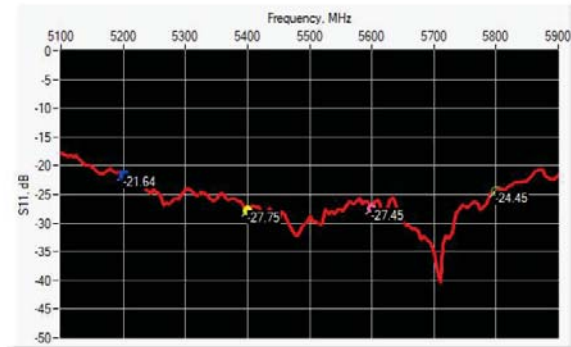

Frequency (MHz)	Return Loss (dB)	Requirement (dB)	Impedance
5200	-21.64	-20	54.48 Ω - 6.92 j Ω
5400	-27.75	-20	50.97 Ω + 3.98 j Ω
5600	-27.45	-20	54.05 Ω + 1.24 j Ω
5800	-24.45	-20	45.31 Ω + 3.71 j Ω

6.2 RETURN LOSS IN BODY LIQUID

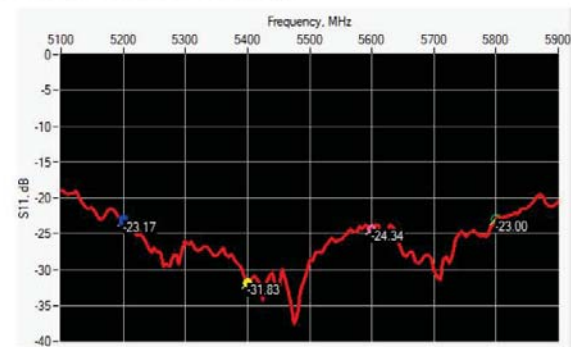

Page: 6/13

Template_ACR.DDD.N.YY.MVGB.ISSUE_SAR Reference Dipole SGHz vD

This document shall not be reproduced, except in full or in part, without the written approval of MVG. The information contained herein is to be used only for the purpose for which it is submitted and is not to be released in whole or part without written approval of MVG.

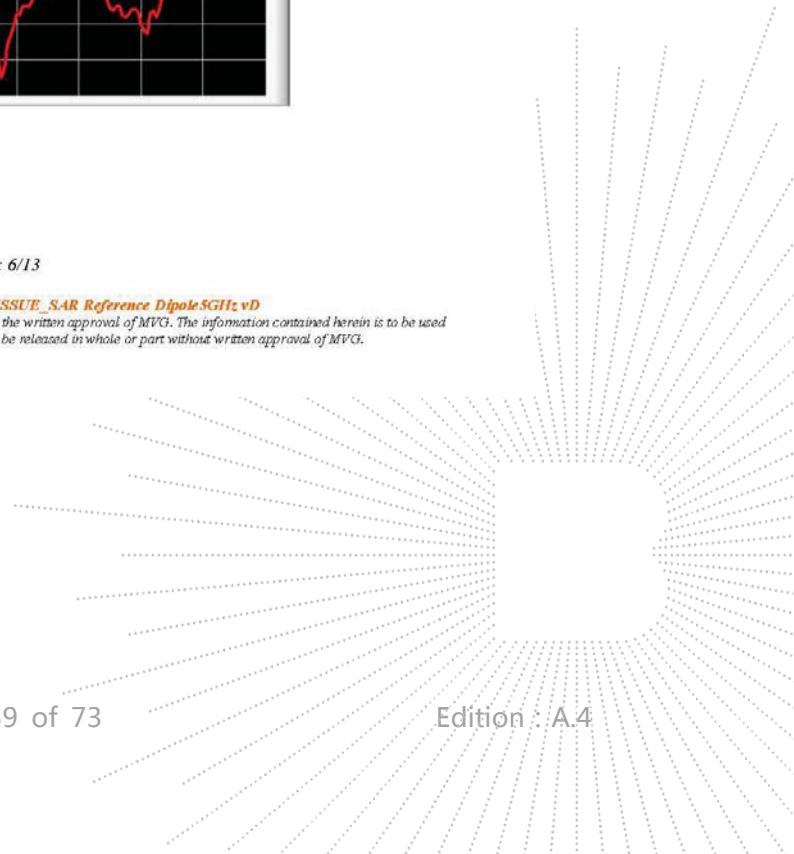



Frequency (MHz)	Return Loss (dB)	Requirement (dB)	Impedance
5200	-23.17	-20	54.03 Ω - 5.62 j Ω
5400	-31.83	-20	51.01 Ω + 2.35 j Ω
5600	-24.34	-20	55.50 Ω + 2.51 j Ω
5800	-23.00	-20	43.65 Ω + 3.06 j Ω

6.3 MECHANICAL DIMENSIONS

Frequency MHz	L mm		h mm		d mm	
	required	measured	required	measured	required	measured
5000 to 6000	20.6 \pm 1 %	20.62	40.3 \pm 1 %	40.45	3.6 \pm 1 %	3.61

7 VALIDATION MEASUREMENT

The IEC/IEEE 62209-1528 and FCC KDB865664 D01 standards state that the system validation measurements must be performed using a reference dipole meeting the fore mentioned return loss and mechanical dimension requirements. The validation measurement must be performed against a liquid filled flat phantom, with the phantom constructed as outlined in the fore mentioned standards. Per the standards, the dipole shall be positioned below the bottom of the phantom, with the dipole length centered and parallel to the longest dimension of the flat phantom, with the top surface of the dipole at the described distance from the bottom surface of the phantom.

7.1 HEAD LIQUID MEASUREMENT

Frequency MHz	Relative permittivity (ϵ_r)		Conductivity (σ) S/m	
	required	measured	required	measured
5000	36.2 \pm 10 %		4.45 \pm 10 %	
5100	36.1 \pm 10 %		4.56 \pm 10 %	
5200	36.0 \pm 10 %	34.44	4.66 \pm 10 %	4.64
5300	35.9 \pm 10 %		4.76 \pm 10 %	
5400	35.8 \pm 10 %	33.63	4.86 \pm 10 %	4.88
5500	35.6 \pm 10 %		4.97 \pm 10 %	
5600	35.5 \pm 10 %	32.80	5.07 \pm 10 %	5.12
5700	35.4 \pm 10 %		5.17 \pm 10 %	
5800	35.3 \pm 10 %	32.63	5.27 \pm 10 %	5.31
5900	35.2 \pm 10 %		5.38 \pm 10 %	
6000	35.1 \pm 10 %		5.48 \pm 10 %	

Page: 7/13

Template_ACR.DDD.N.YY.MVGB.ISSUE_SAR Reference Dipole SGHz vD

This document shall not be reproduced, except in full or in part, without the written approval of MVG. The information contained herein is to be used only for the purpose for which it is submitted and is not to be released in whole or part without written approval of MVG.



7.2 SAR MEASUREMENT RESULT WITH HEAD LIQUID

At those frequencies, the target SAR value can not be generic. Hereunder is the target SAR value defined by MVG, within the uncertainty for the system validation. All SAR values are normalized to 1 W net power. In bracket, the measured SAR is given with the used input power.

Software	OPENSAR V5
Phantom	SN 13/09 SAM68
Probe	SN 41/18 EPG0333
Liquid	Head Liquid Values 5200 MHz: eps' :34.44 sigma : 4.64 Head Liquid Values 5400 MHz: eps' :33.63 sigma : 4.88 Head Liquid Values 5600 MHz: eps' :32.80 sigma : 5.12 Head Liquid Values 5800 MHz: eps' :32.63 sigma : 5.31
Distance between dipole and liquid	10 mm
Area scan resolution	dx=8mm/dy=8mm
Zoon Scan Resolution	dx=4mm/dy=4m/dz=2mm
Frequency	5200 MHz 5400 MHz 5600 MHz 5800 MHz
Input power	20 dBm
Liquid Temperature	20 +/- 1 °C
Lab Temperature	20 +/- 1 °C
Lab Humidity	30-70 %

Frequency (MHz)	1 g SAR (W/kg)		10 g SAR (W/kg)	
	required	measured	required	measured
5200	76.50	76.41 (7.64)	21.60	21.86 (2.19)
5400	-	80.52 (8.05)	-	22.91 (2.29)
5600	-	79.08 (7.91)	-	22.73 (2.27)
5800	78.00	76.49 (7.65)	21.90	22.03 (2.20)

SAR MEASUREMENT PLOTS @ 5200 MHz

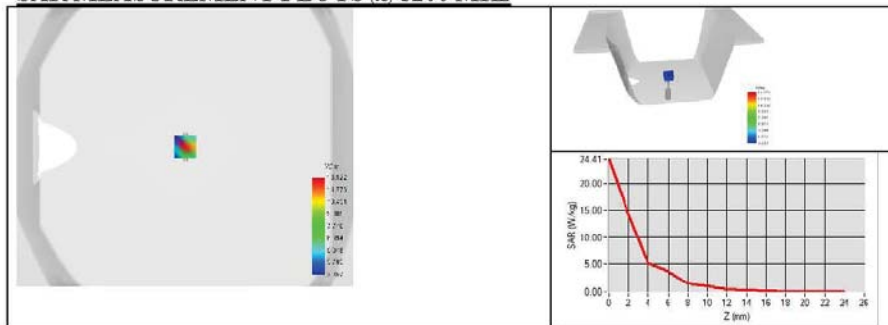

Page: 8/13

Template_ACR.DDD.N.YY.MVGB.ISSUE_SAR Reference DipoleSGHz.vD

This document shall not be reproduced, except in full or in part, without the written approval of MVG. The information contained herein is to be used only for the purpose for which it is submitted and is not to be released in whole or part without written approval of MVG.

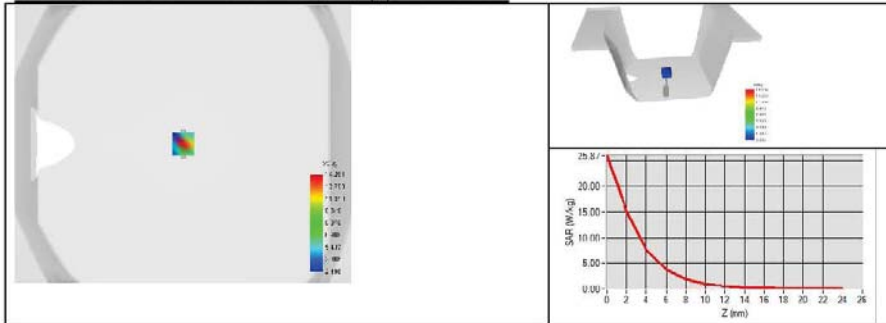
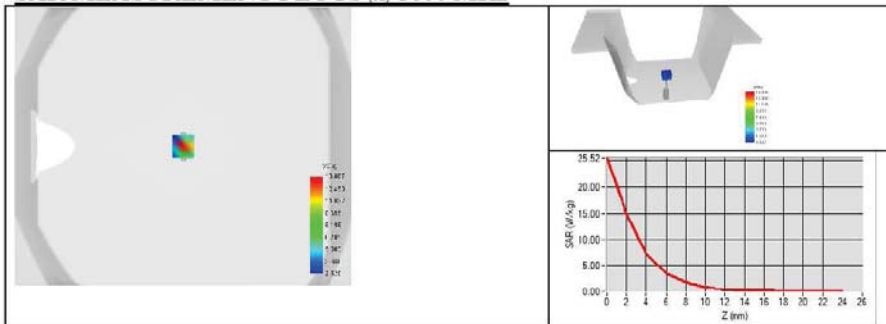
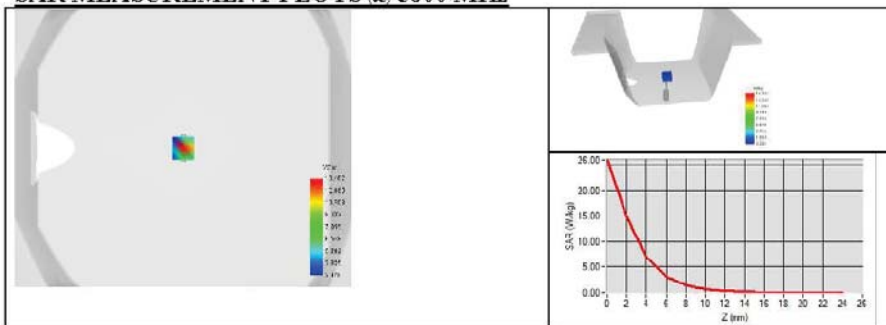
SAR MEASUREMENT PLOTS @ 5400 MHz

SAR MEASUREMENT PLOTS @ 5600 MHz

SAR MEASUREMENT PLOTS @ 5800 MHz

Page: 9/13

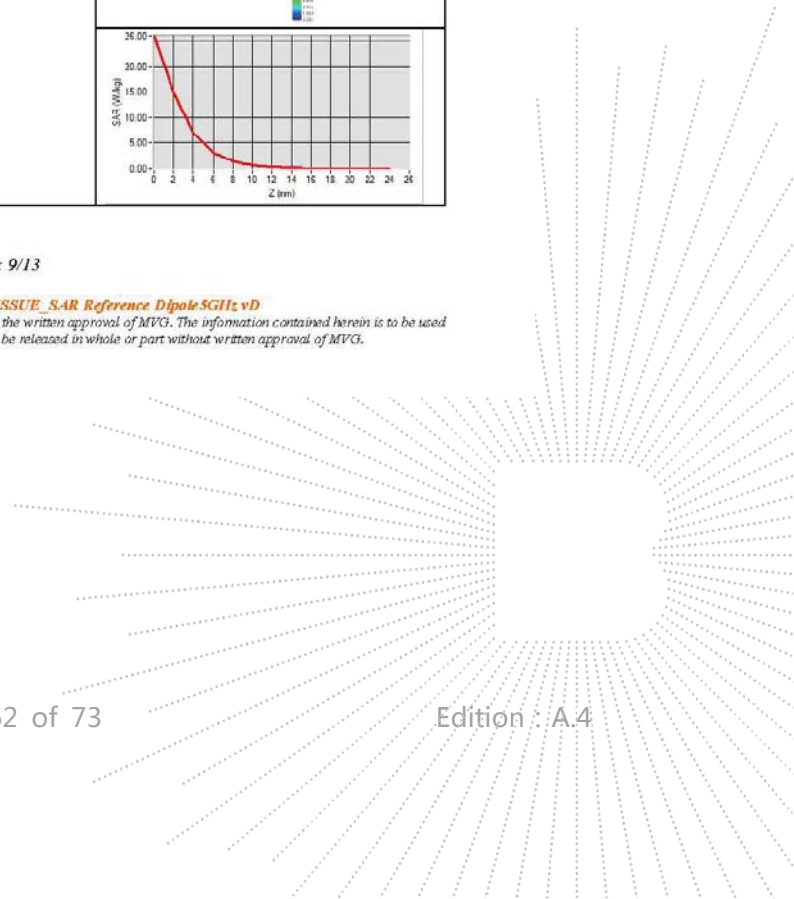
Template_ACR.DDD.N.YY.MVGB.ISSUE_SAR Reference Dipole SGHt vD

This document shall not be reproduced, except in full or in part, without the written approval of MVG. The information contained herein is to be used only for the purpose for which it is submitted and is not to be released in whole or part without written approval of MVG.



 7.3 BODY LIQUID MEASUREMENT

Frequency MHz	Relative permittivity (ϵ_r)		Conductivity (σ) S/m	
	required	measured	required	measured
5200	49.0 \pm 1.0 %	45.50	5.30 \pm 1.0 %	5.63
5300	48.9 \pm 1.0 %		5.42 \pm 1.0 %	
5400	48.7 \pm 1.0 %	44.78	5.53 \pm 1.0 %	5.95
5500	48.6 \pm 1.0 %		5.65 \pm 1.0 %	
5600	48.5 \pm 1.0 %	44.85	5.77 \pm 1.0 %	6.26
5800	48.2 \pm 1.0 %	44.45	6.00 \pm 1.0 %	6.58

 7.4 SAR MEASUREMENT RESULT WITH BODY LIQUID

Software	OPENSAR V5
Phantom	SN 13/09 SAM68
Probe	SN 41/18 EPG0333
Liquid	Body Liquid Values 5200 MHz: ϵ_r :45.50 σ : 5.63 Body Liquid Values 5400 MHz: ϵ_r :44.78 σ : 5.95 Body Liquid Values 5600 MHz: ϵ_r :44.85 σ : 6.26 Body Liquid Values 5800 MHz: ϵ_r :44.45 σ : 6.58
Distance between dipole and liquid	10 mm
Area scan resolution	dx=8mm/dy=8mm
Zoon Scan Resolution	dx=4mm/dy=4m/dz=2mm
Frequency	5200 MHz 5400 MHz 5600 MHz 5800 MHz
Input power	20 dBm
Liquid Temperature	20 +/- 1 °C
Lab Temperature	20 +/- 1 °C
Lab Humidity	30-70 %

Frequency (MHz)	1 g SAR (W/kg)	10 g SAR (W/kg)
	measured	measured
5200	73.02 (7.30)	20.58 (2.06)
5400	77.86 (7.79)	21.85 (2.19)
5600	79.90 (7.99)	22.73 (2.27)
5800	71.90 (7.19)	20.50 (2.05)

Page: 10/13

Template_ACR.DDD.N.YY.MVGB.ISSUE_SAR Reference Dipole 5GHz vD

This document shall not be reproduced, except in full or in part, without the written approval of MVG. The information contained herein is to be used only for the purpose for which it is submitted and is not to be released in whole or part without written approval of MVG.

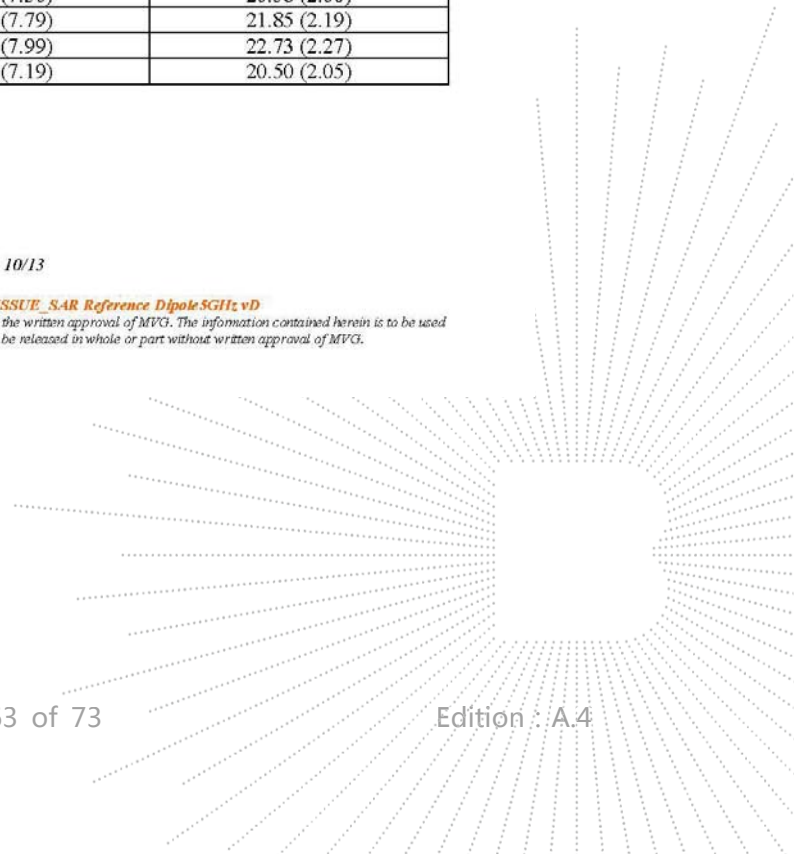

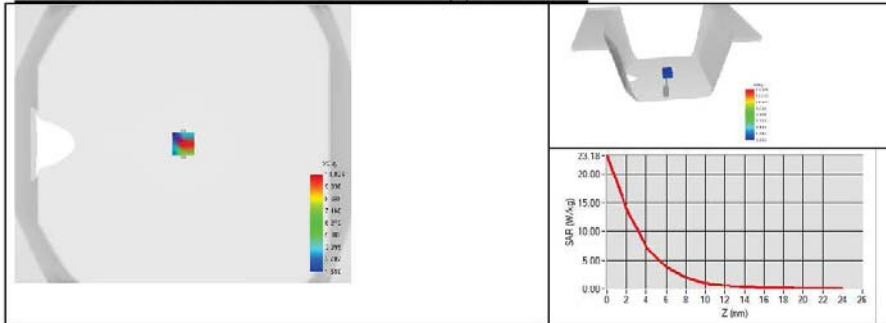
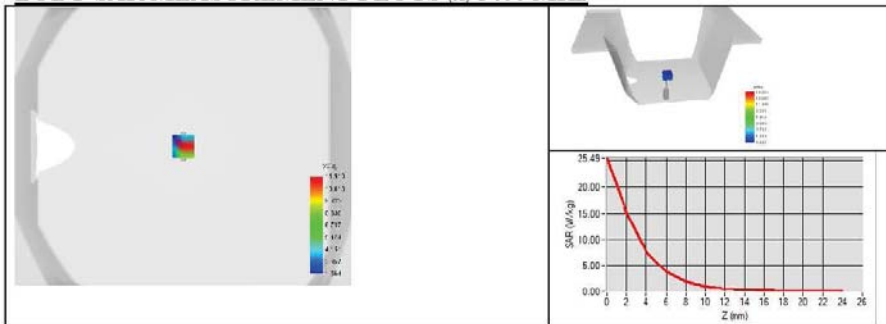
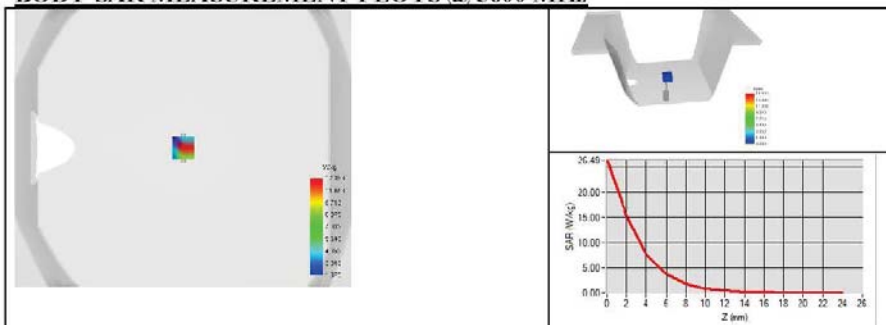

BODY SAR MEASUREMENT PLOTS @ 5200 MHz

BODY SAR MEASUREMENT PLOTS @ 5400 MHz

BODY SAR MEASUREMENT PLOTS @ 5600 MHz

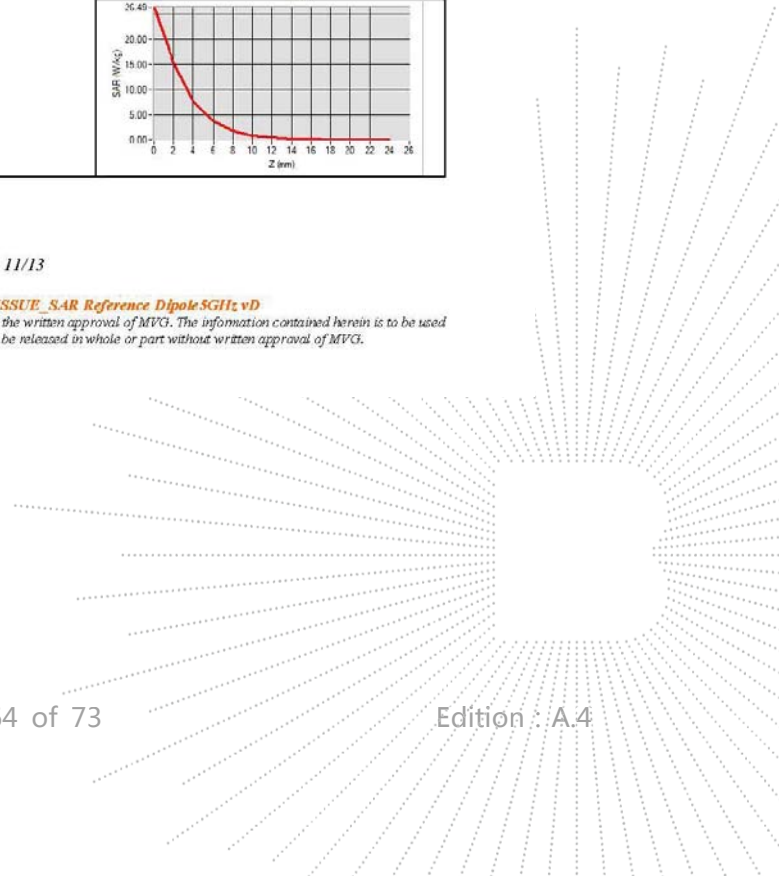
Page: 11/13

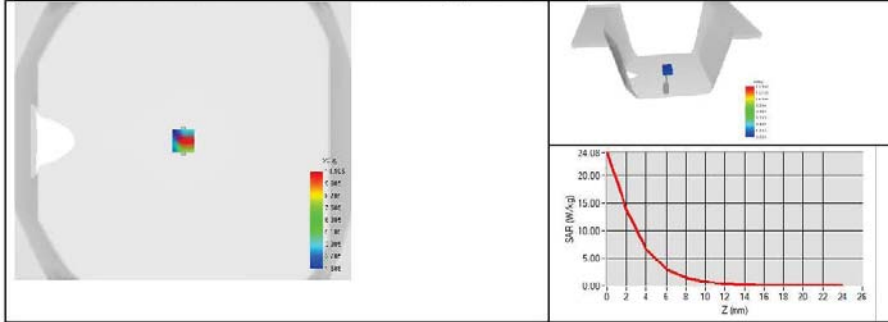
Template_ACR.DDD.N.YY.MVGB.ISSUE_SAR Reference Dipole SGHt vD

This document shall not be reproduced, except in full or in part, without the written approval of MVG. The information contained herein is to be used only for the purpose for which it is submitted and is not to be released in whole or part without written approval of MVG.





BODY SAR MEASUREMENT PLOTS @ 5800 MHz

Page: 12/13

Template_ACR.DDD.N.YY.MVGB.ISSUE_SAR Reference Dipole SGHt.vD

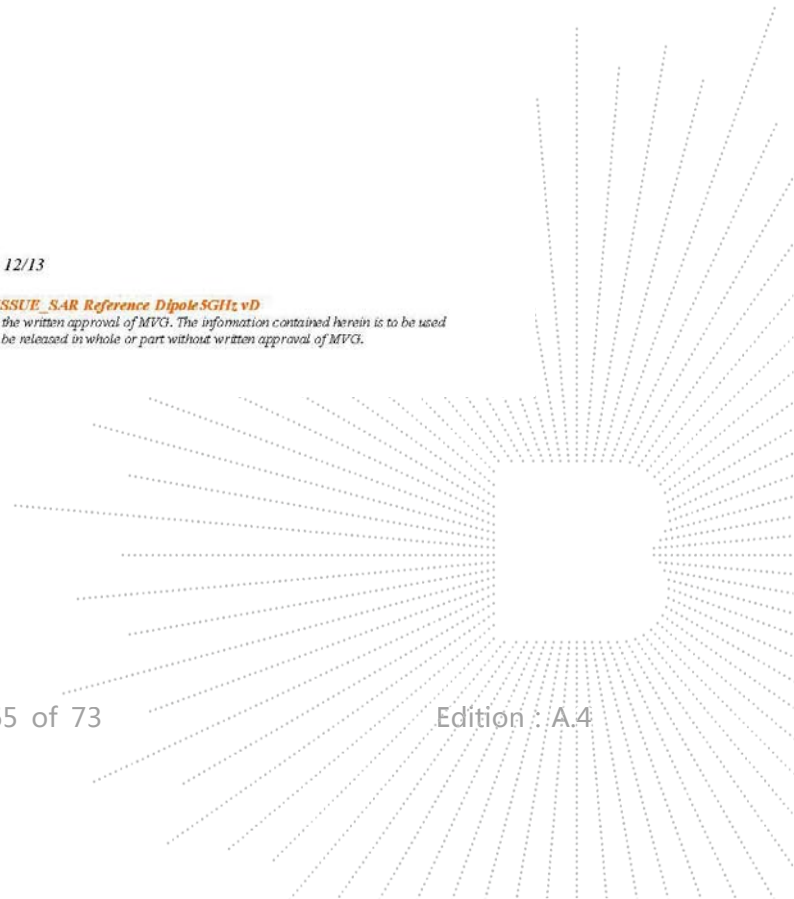
This document shall not be reproduced, except in full or in part, without the written approval of MVG. The information contained herein is to be used only for the purpose for which it is submitted and is not to be released in whole or part without written approval of MVG.





8 LIST OF EQUIPMENT

Equipment Summary Sheet				
Equipment Description	Manufacturer / Model	Identification No.	Current Calibration Date	Next Calibration Date
SAM Phantom	MVG	SN 13/09 SAM68	Validated. No cal required.	Validated. No cal required.
COMOSAR Test Bench	Version 3	NA	Validated. No cal required.	Validated. No cal required.
Network Analyzer	Rohde & Schwarz ZVM	100203	08/2021	08/2024
Network Analyzer	Agilent 8753ES	MY40003210	10/2019	10/2022
Network Analyzer – Calibration kit	Rohde & Schwarz ZV-Z235	101223	05/2019	05/2022
Network Analyzer – Calibration kit	HP 85033D	3423A08186	06/2021	06/2027
Calipers	Mitutoyo	SN 0009732	10/2019	10/2022
Reference Probe	MVG	SN 41/18 EPGO333	10/2021	10/2022
Multimeter	Keithley 2000	1160271	02/2020	02/2023
Signal Generator	Rohde & Schwarz SMB	106589	04/2019	04/2022
Amplifier	MVG	MODU-023-C-0002	Characterized prior to test. No cal required.	Characterized prior to test. No cal required.
Power Meter	NI-USB 5680	170100013	06/2021	06/2024
Power Meter	Rohde & Schwarz NRVD	832839-056	11/2019	11/2022
Directional Coupler	Krytar 158020	131467	Characterized prior to test. No cal required.	Characterized prior to test. No cal required.
Temperature / Humidity Sensor	Testo 184 H1	44225320	06/2021	06/2024

Page: 13/13

Template_ACR.DDD.N.YY.MVGB.ISSUE_SAR Reference DipoleSGHtc vD

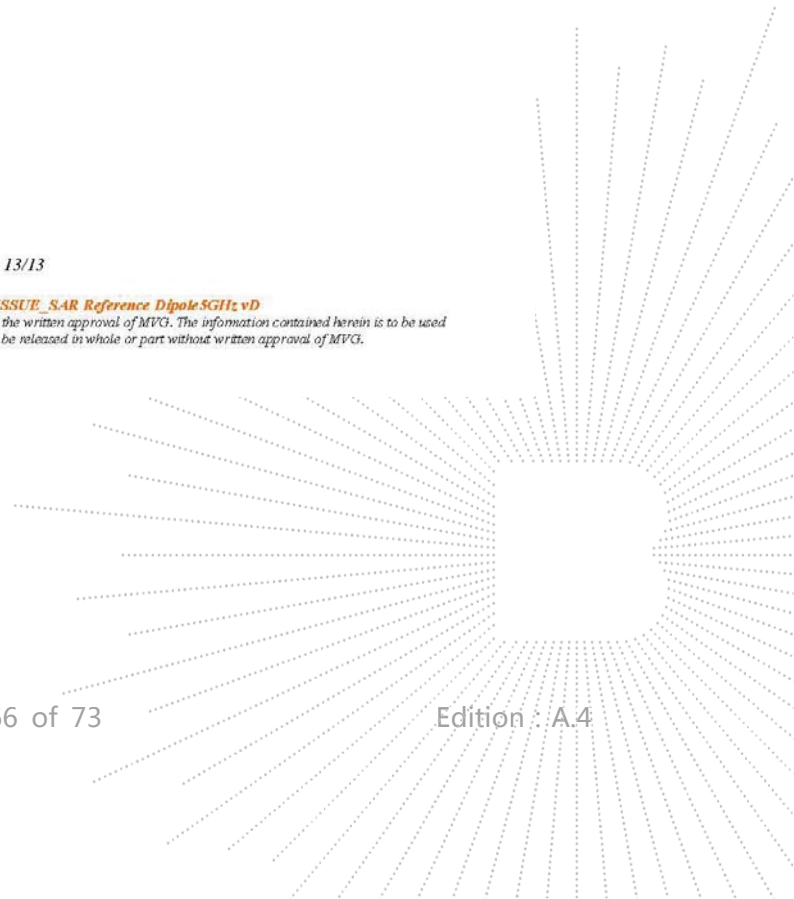
This document shall not be reproduced, except in full or in part, without the written approval of MVG. The information contained herein is to be used only for the purpose for which it is submitted and is not to be released in whole or part without written approval of MVG.



17. EUT Photographs

EUT Front View



EUT Back View

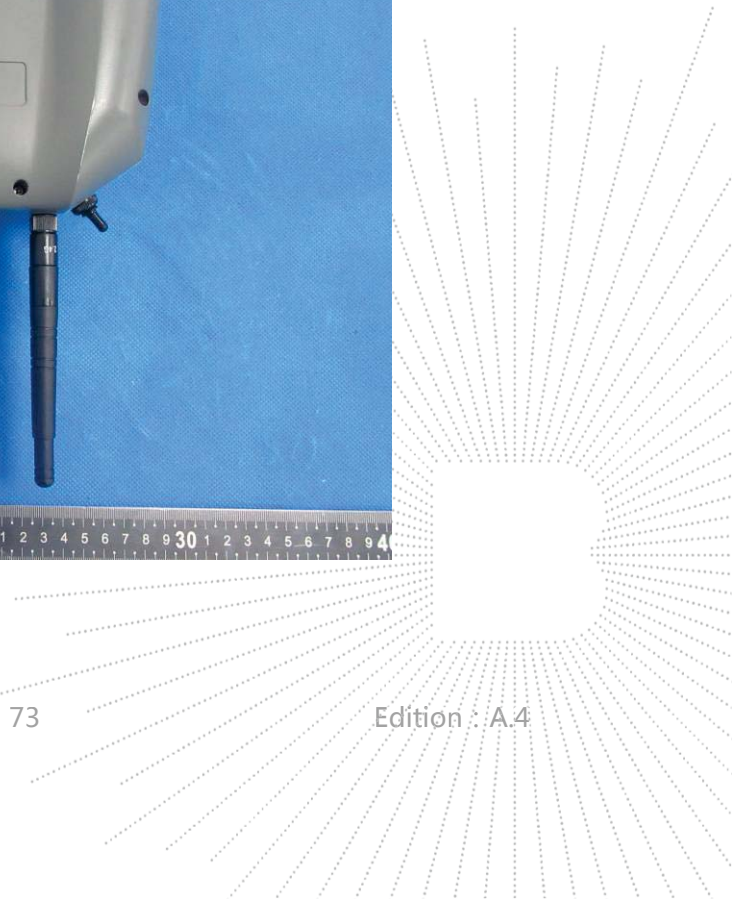

Antenna View

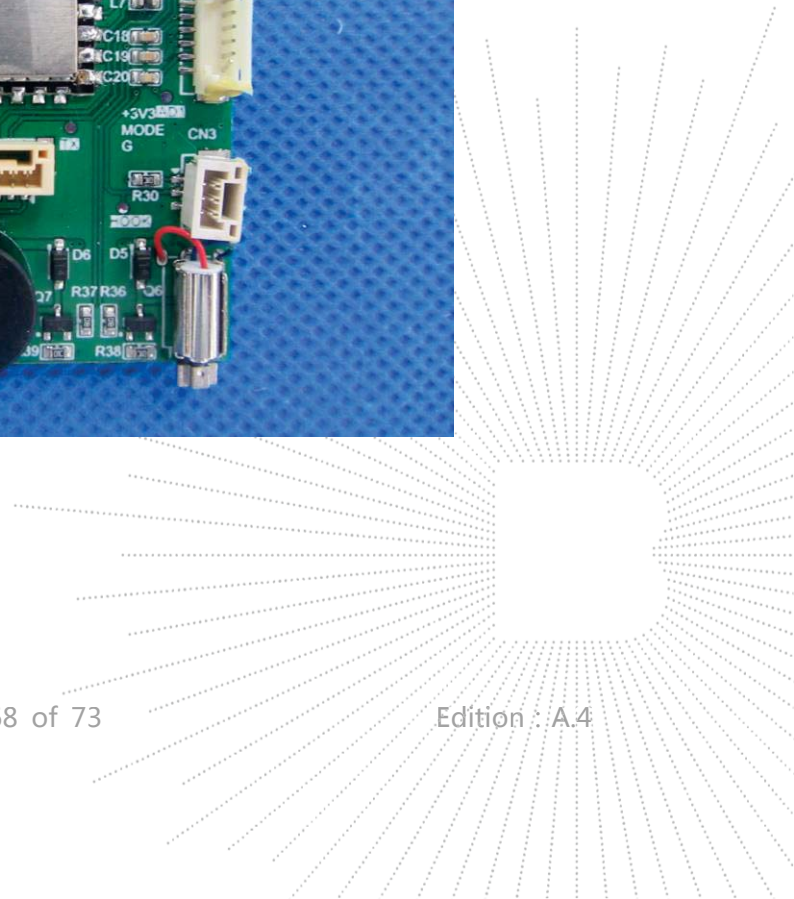
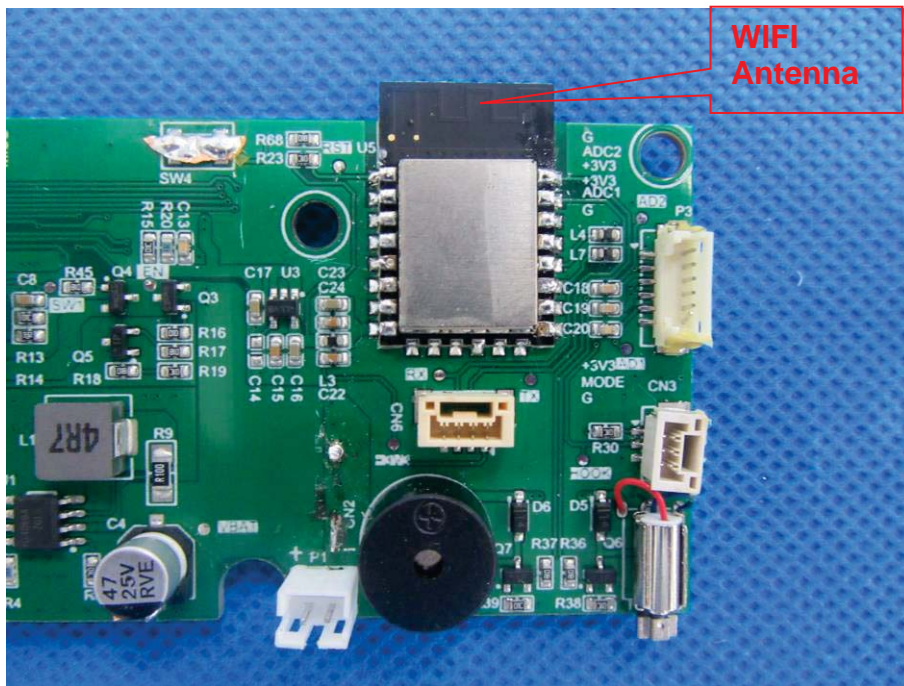
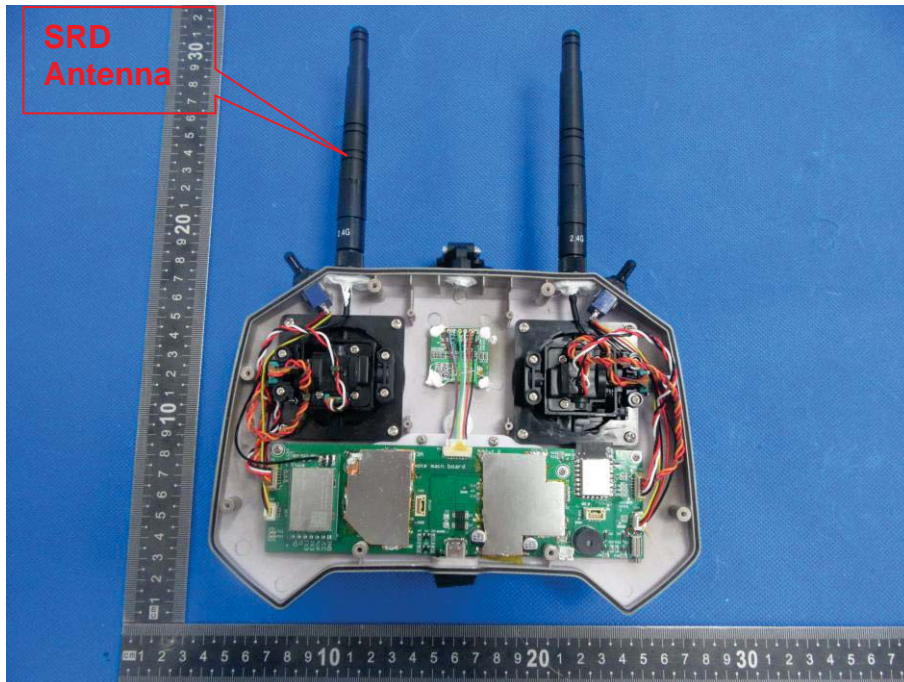

18. EUT Test Setup Photographs

Body mode Exposure Conditions
Test distance: 0mm

Front (WiFi)



Back (WiFi)



Front1 (SRD)

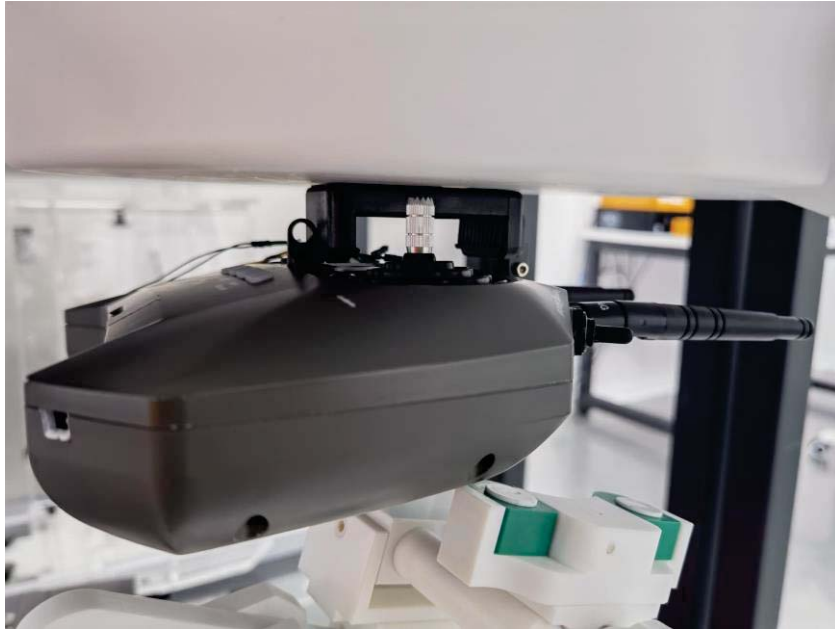

Front2 (SRD)

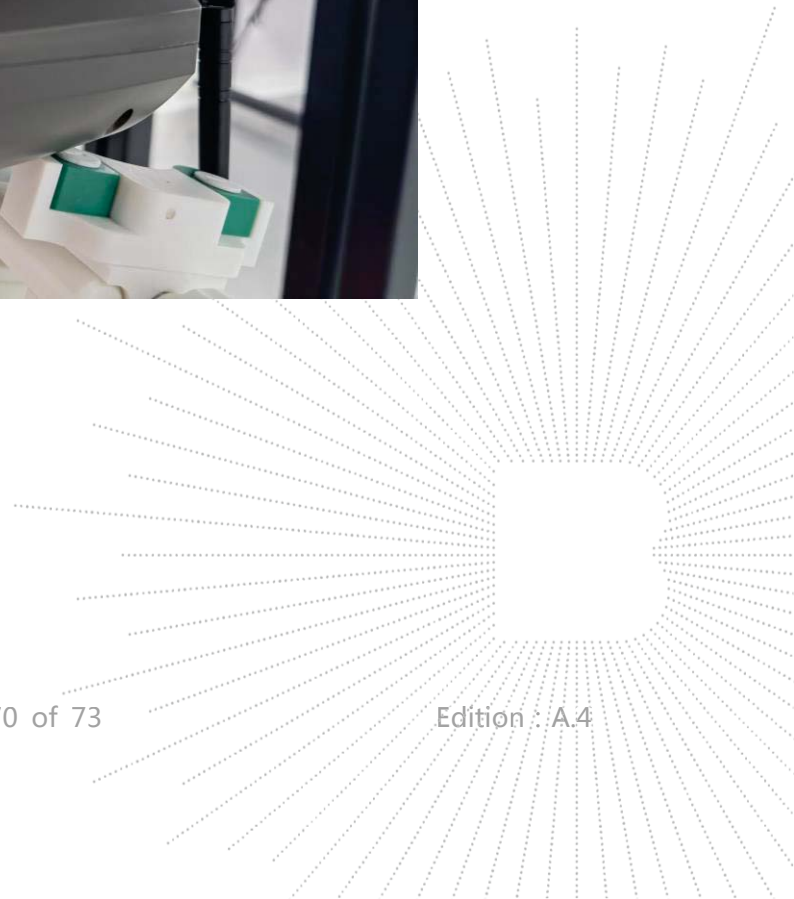

Back1 (SRD)



Back2 (SRD)

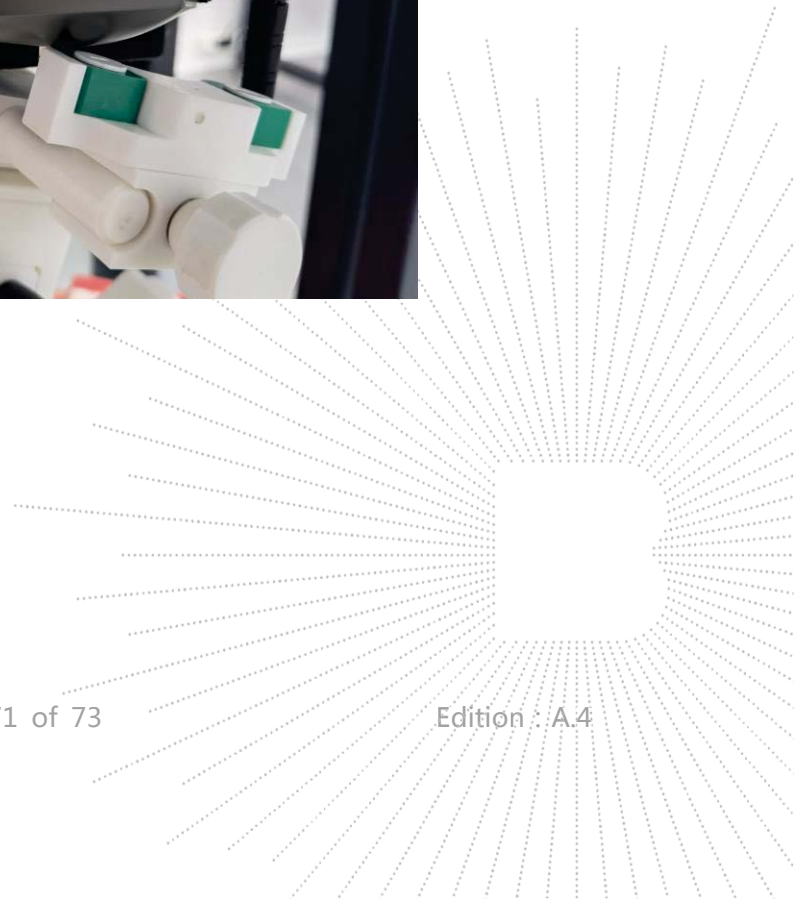

Top (SRD)

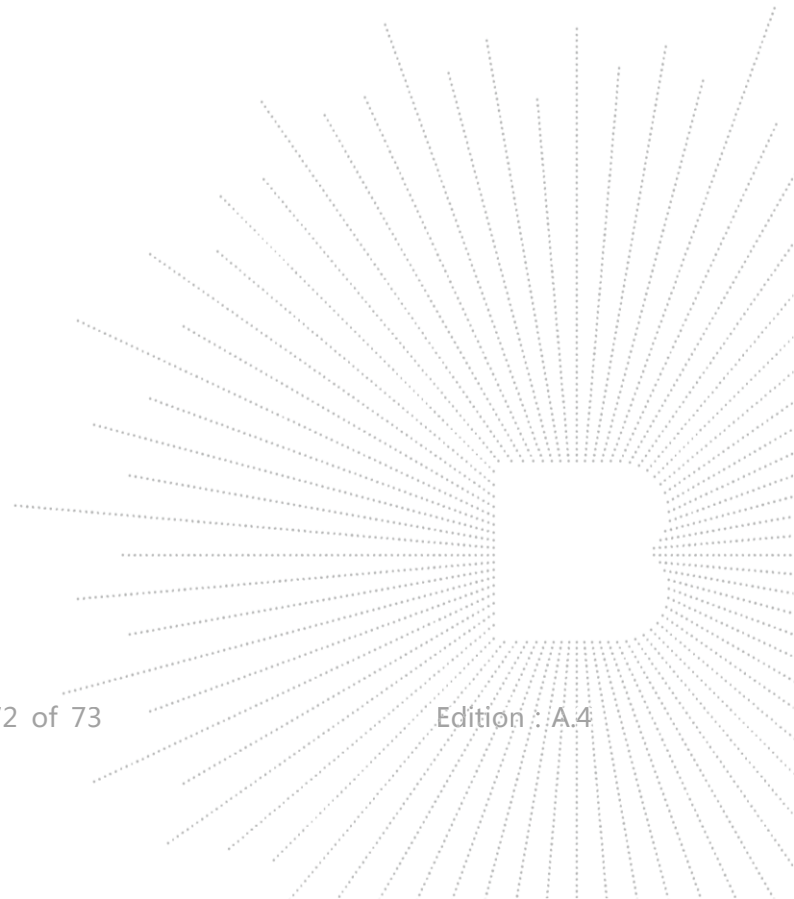

STATEMENT

- 1.The equipment lists are traceable to the national reference standards.
- 2.The test report can not be partially copied unless prior written approval is issued from our lab.
- 3.The test report is invalid without stamp of laboratory.
- 4.The test report is invalid without signature of person(s) testing and authorizing.
- 5.The test process and test result is only related to the Unit Under Test.
- 6.The quality system of our laboratory is in accordance with ISO/IEC17025.
- 7.If there is any objection to report, the client should inform issuing laboratory within 15 days from the date of receiving test report.

Address:

1-2/F., Building B, Pengzhou Industrial Park, No.158, Fuyuan 1st Road, Tangwei, Fuhai Subdistrict, Bao'an District, Shenzhen, Guangdong, China

TEL : 400-788-9558

T. C.: 518103

FAX : 0755-33229357

Website : <http://www.chnbctc.com>

E-Mail : bctc@bctc-lab.com.cn

***** END *****

