



<http://www.lab-t.net>

2182-42 Baegok-daero, Mohyeon-eup, Cheoin-gu
Yongin-si, Gyeonggi-do 17036, Korea (Republic of)
Main: +82-31-322-6767 / Fax: +82-31-322-6768

Test report No.:
TREFCC22-0066

FCC CERTIFICATION TEST REPORT

Test report No. : TREFCC22-0066
Applicant : KD Navien Co., Ltd.
Address : 95, Suworam-gil, Seotan-myeon, Pyeongtaek-si, Gyeonggi-do, 17704, Republic of Korea
Manufacturer : KD Navien Co., Ltd.
Address : 95, Suworam-gil, Seotan-myeon, Pyeongtaek-si, Gyeonggi-do, 17704, Republic of Korea
Type of equipment : DC Heated Mattress Pad
Model name : EME501-DP
Variant model name : EME501-SP
FCC ID : 2ASTC-EME501
Date of incoming : July 20, 2022
Date of test : July 20, 2022
Date of issue : July 27, 2022
Test standards : ANSI C 63.4-2014
47 CFR Part 15 Subpart B
Type of device : Class B All other devices
Test Result : Complied Not complied

Summary

The test results presented in this test report are limited only to the sample supplied by applicant and the use of this test report is inhibited other than its purpose. This test report shall not be reproduced except in full, without the written approval of Lab-T, Inc.

Prepared by

Gyu-Bong Nam / EMC Test Engineer

Approved by

Cheol-Ho, Lee / Technical manager

If this test report is required for confirmation of authenticity, please contact info@lab-t.net
This test report is not related to KOLAS.

	<p style="text-align: center;">http://www.lab-t.net</p> <p style="text-align: center;">2182-42 Baegok-daero, Mohyeon-eup, Cheoin-gu Yongin-si, Gyeonggi-do 17036, Korea (Republic of) Main: +82-31-322-6767 / Fax: +82-31-322-6768</p>	<p style="text-align: center;">Test report No.: TREFCC22-0066</p>
---	---	--

- CONTENTS -

1. REVISION HISTORY	3
2. INFORMATION OF TEST LABORATORY	4
3. APPLICANT INFORMATION	5
4. DESCRIPTION OF EUT (EQUIPMENT UNDER TEST)	6
4.1 Product description.....	6
4.2 Product specification	6
4.3 EUT internal operating frequency	7
4.4 Information of additional model	7
4.5 Peripheral equipment	8
4.6 Connection cable.....	8
4.7 Test setup and configuration.....	9
4.8 EUT operating test mode(s).....	9
4.9 EUT modification	9
5. TEST STANDARD	10
5.1 Standard	10
6. EMISSION TEST RESULT	11
6.1 Conducted emission.....	11
6.2 Radiated emission (30 MHz ~ 1 000 MHz).....	17
6.3 Radiated emission (Above 1 GHz).....	23

	<p style="text-align: center;">http://www.lab-t.net</p> <p>2182-42 Baegok-daero, Mohyeon-eup, Cheoin-gu Yongin-si, Gyeonggi-do 17036, Korea (Republic of) Main: +82-31-322-6767 / Fax: +82-31-322-6768</p>	<p style="text-align: center;">Test report No.: TREFCC22-0066</p>
---	---	--

1. Revision history

Test report No.	Version	Date of issue	Revision
TREFCC22-0066	Rev. 00	July 27, 2022	Original







	<p style="text-align: center;">http://www.lab-t.net</p> <p style="text-align: center;">2182-42 Baegok-daero, Mohyeon-eup, Cheoin-gu Yongin-si, Gyeonggi-do 17036, Korea (Republic of) Main: +82-31-322-6767 / Fax: +82-31-322-6768</p>	<p style="text-align: center;">Test report No.: TREFCC22-0066</p>
---	---	--

2. Information of test laboratory

Corporate name	Lab-T, Inc.
Representative	Duke (Jongyoung) Kim
Address	2182-42 Baegok-daero, Mohyeon-eup, Cheoin-gu, Yongin-si Gyeonggi-do 17036, Korea (Republic of)
Telephone	+82-31-322-6767
Fax	+82-31-322-6768
E-mail	info@lab-t.net

Test site	Building L, A, T
Address	2182-40, 2182-44, 2182-42 Baegok-daero, Mohyeon-eup, Cheoin-gu Yongin-si, Gyeonggi-do 17036, Korea (Republic of)

* Lab-T, Inc. has been accredited / filed / authorized by the agencies listed in the following table.

Certificate	Nation	Agency	Code	Mark
Accreditation	Korea	KOLAS	KT703	
Site filing	USA	FCC	KR0159	
	Japan	VCCI	R-14282, C-14764, T-12276, G-10886, G-10887	
	Canada	Industry Canada (IC)	22000-1	
Certification	Korea	KC	KR0159 (RRA) KC2019-1 (KATS)	
	EU	TUV SUD	CARAT 093449 0006	
	USA	UL	1706-E-197	

	<p style="text-align: center;">http://www.lab-t.net</p> <p style="text-align: center;">2182-42 Baegok-daero, Mohyeon-eup, Cheoin-gu Yongin-si, Gyeonggi-do 17036, Korea (Republic of) Main: +82-31-322-6767 / Fax: +82-31-322-6768</p>	<p style="text-align: center;">Test report No.: TREFCC22-0066</p>
---	---	--

3. Applicant information

Applicant	KD Navien Co., Ltd.
Address	95, Suworam-gil, Seotan-myeon, Pyeongtaek-si, Gyeonggi-do, 17704, Republic of Korea

Manufacturer	KD Navien Co., Ltd.
Address	95, Suworam-gil, Seotan-myeon, Pyeongtaek-si, Gyeonggi-do, 17704, Republic of Korea
Country of origin	Reublic of Korea

Factory	KYUNG DONG NAVIEN CO.,LTD
Address	104, Sabgyocheon-Ro, Seonjang-Myeon, Asan-Si, Chungcheongnam-Do, Republic of Korea
Factory (Country)	Reublic of Korea

	<p style="text-align: center;">http://www.lab-t.net</p> <p style="text-align: center;">2182-42 Baegok-daero, Mohyeon-eup, Cheoin-gu Yongin-si, Gyeonggi-do 17036, Korea (Republic of) Main: +82-31-322-6767 / Fax: +82-31-322-6768</p>	<p style="text-align: center;">Test report No.: TREFCC22-0066</p>
---	---	--

4. Description of EUT (Equipment under test)

4.1 Product description

Name of EUT	DC Heated Mattress Pad
Model name	EME501-DP

4.2 Product specification

Product Name		DC Heated Mattress Pad
Model Name	Single	EME501-SP
	Queen	EME501-DP
Rated Power Consumption		DC24V, 105W (Single), 150W (Queen)
Operating & Storage Conditions	Temperature	Operating : 32°F ~ 77°F (0°C ~ 25°C) Storage : -13°F ~ 158°F (-25°C ~ 70°C)
	Humidity	Operating : 10% ~ 90% RH, Non-condensing Storage : 5% ~ 90% RH, Non-condensing
Controller Size		D45 x W155 x H35 mm
Controller Weight		100g
Receptacle Size		D95 x W70 x H30 mm
Receptacle Weight		150g
Pad Size	Single	950 x 1,800 mm
	Queen	1,450 x 1,800 mm

	<p style="text-align: center;">http://www.lab-t.net</p> <p style="text-align: center;">2182-42 Baegok-daero, Mohyeon-eup, Cheoin-gu Yongin-si, Gyeonggi-do 17036, Korea (Republic of) Main: +82-31-322-6767 / Fax: +82-31-322-6768</p>	<p style="text-align: center;">Test report No.: TREFCC22-0066</p>
---	---	--

Bluetooth	Version		Bluetooth v4.2
	Frequency	Tx	2,402 MHz ~ 2,480 MHz
		Rx	2,402 MHz ~ 2,480 MHz
	Output		6 mW
Wi-Fi	Standard		IEEE 802.11 b/g/n
	Wireless channels		1 to 11 channels
	Authentication methods		OPEN, WEP, WPA-PSK, WPA2-PSK
	Frequency	Tx	2,412 MHz ~ 2,462 MHz
		Rx	2,412 MHz ~ 2,462 MHz
	Output		398 mW

4.3 EUT internal operating frequency

Frequency	Description	Frequency	Description
2.4 GHz	-	-	-
* Note: Upper frequency of measurement range is 13 GHz.			

4.4 Information of additional model

Division	Model name	Difference
1	EME501-SP	Power consumption and mat heat line length

	<p style="text-align: center;">http://www.lab-t.net</p> <p style="text-align: center;">2182-42 Baegok-daero, Mohyeon-eup, Cheoin-gu Yongin-si, Gyeonggi-do 17036, Korea (Republic of) Main: +82-31-322-6767 / Fax: +82-31-322-6768</p>	<p style="text-align: center;">Test report No.: TREFCC22-0066</p>
---	---	--

4.5 Peripheral equipment

Product	Model name	Serial No.	Manufacturer
DC Heated Mattress Pad (EUT)	EME501-DP	-	KD Navien Co., Ltd. / KOREA
Controller (EUT)	EME501-DP	-	KD Navien Co., Ltd. KOREA
DC Heated Mattress Pad (EUT)	EME501-SP	-	KD Navien Co., Ltd. / KOREA
Controller (EUT)	EME501-SP	-	KD Navien Co., Ltd. KOREA
AC/DC ADAPTER	KDA-150WKB	-	RFTech / KOREA

4.6 Connection cable

Start-up device		Connected end device		Cable specification	
Name	I/O port	Name	I/O port	Length (m)	Spec.
DC Heated Mattress Pad (EUT)	6 PIN CONNECTOR	Controller (EUT)	-	1.0	Unshield
Controller (EUT)	DC IN	AC/DC ADAPTER	DC OUT	1.5	Unshield
AC/DC ADAPTER	AC IN	AC Power Source	AC OUT	0.7	Unshield

	<p style="text-align: center;">http://www.lab-t.net</p> <p style="text-align: center;">2182-42 Baegok-daero, Mohyeon-eup, Cheoin-gu Yongin-si, Gyeonggi-do 17036, Korea (Republic of) Main: +82-31-322-6767 / Fax: +82-31-322-6768</p>	<p style="text-align: center;">Test report No.: TREFCC22-0066</p>
---	---	--

4.7 Test setup and configuration

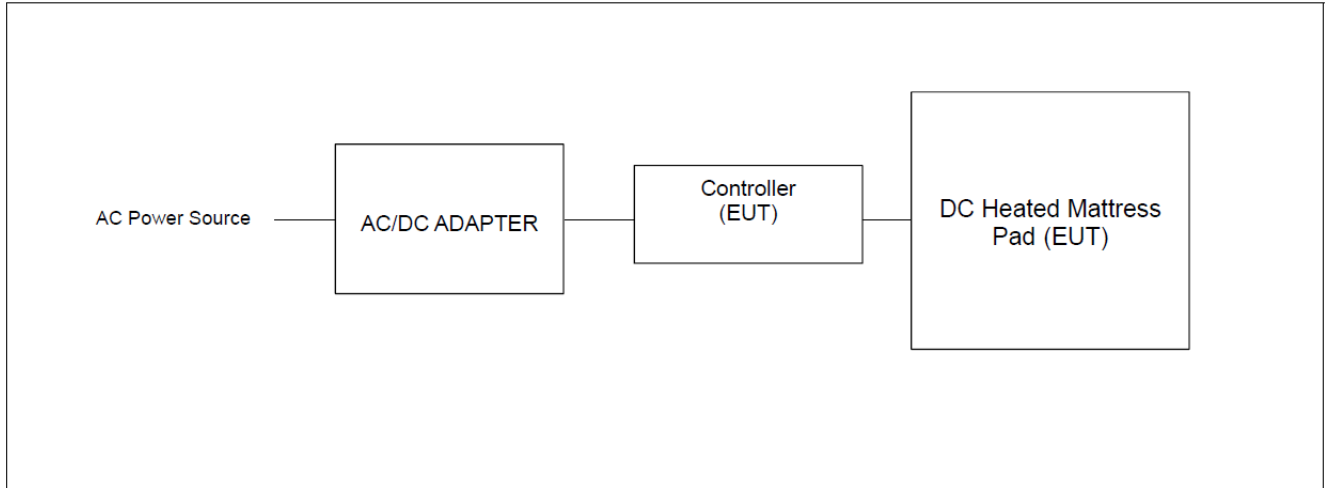

4.8 EUT operating test mode(s)

- Test the electric mat after setting it to its maximum temperature.
- The basic model (EME501-DP) and the derivative model (EME501-SP) are tested respectively during the test.
- The AC/DC ADAPTER used in the test was not provided and was used as a peripheral device during the test.
(AC/DC ADAPTER Specification)
 - Input : AC 100 V ~ 240 V, 50 / 60 Hz, 2.5 A
 - Output : DC 24 V, 6.25 A, 150 W)

4.9 EUT modification

- Not modification.

	<p style="text-align: center;">http://www.lab-t.net</p> <p style="text-align: center;">2182-42 Baegok-daero, Mohyeon-eup, Cheoin-gu Yongin-si, Gyeonggi-do 17036, Korea (Republic of) Main: +82-31-322-6767 / Fax: +82-31-322-6768</p>	<p style="text-align: center;">Test report No.: TREFCC22-0066</p>
---	---	--

5. Test standard

5.1 Standard

Test item	Applied standard	Result
Conducted emission	47 CFR FCC Part 15 Subpart B §15.107 (Class B)	C
Radiated emission (30 MHz ~ 1 000 MHz)	47 CFR FCC Part 15 Subpart B §15.109 (Class B)	C
Radiated emission (Above 1 GHz)	47 CFR FCC Part 15 Subpart B §15.109 (Class B)	C
* C=Comply, N/A=Not applicable		

[Measurement uncertainty]

All measurements involve certain levels of uncertainties, especially in field of EMC.

The factors contributing to uncertainties are test receiver, cable loss, antenna factor calibration, Antenna directivity, antenna factor variation with height, antenna phase center variation, antenna frequency interpolation, measurement distance variation, site imperfection, mismatch, and system repeatability. Based on CISPR 16-4-2, the measurement uncertainty level with a 95 % confidence level was applied.

Test item		Uncertainty	Confidence level of approximately
Conducted emission	0.15 kHz ~ 30 MHz	2.36 dB	Least about 95 %, k = 2
Radiated emission (30 MHz ~ 1 000 MHz)	30 MHz ~ 1 000 MHz	4.80 dB	Least about 95 %, k = 2
Radiated emission (Above 1 GHz)	1 000 MHz ~ 13 000 MHz	5.06 dB	Least about 95 %, k = 2

	<p style="text-align: center;">http://www.lab-t.net 2182-42 Baegok-daero, Mohyeon-eup, Cheoin-gu Yongin-si, Gyeonggi-do 17036, Korea (Republic of) Main: +82-31-322-6767 / Fax: +82-31-322-6768</p>	<p style="text-align: center;">Test report No.: TREFCC22-0066</p>
---	---	---

6. Emission test result

6.1 Conducted emission

Test standard	47 CFR FCC Part 15 Subpart B §15.107
Test date	2022.07.20
Test facility	Building A Shielded room (#1)
Test voltage	AC 120 V, 60 Hz
Temperature	(20.7 ~ 21.1) °C
Relative humidity	(50.3 ~ 50.7) % R.H.
Test result	Complied

6.1.1 Measurement procedure

If the EUT is table top equipment, it was placed on a wooden table with a height of 0.8 m above the reference ground plane and 0.4 m from the conducting wall of the shielded room.

Also if the EUT is floor-standing equipment, it was placed either directly on the reference ground plane or on insulating material as described in ANSI C 63.4 6.3.3.2. Connect the EUT's power source lines to the appropriate power mains / peripherals through the LISN. All the other peripherals are connected to the 2nd LISN & ISN, if any. Unused measuring port of the LISN & ISN was resistively terminated by 50 ohm terminator. The measuring port of the LISN for EUT was connected to spectrum analyzer. Using conducted emission test software, the emissions were scanned with peak detector mode. After scanning over the frequency range, suspected emissions were selected to perform final measurement. When performing final measurement, the receiver was used which has quasi-peak detector and CISPR average detector. By varying the configuration of the test sample and the cable routing it was attempted to maximize the emission.

	<p style="text-align: center;">http://www.lab-t.net</p> <p style="text-align: center;">2182-42 Baegok-daero, Mohyeon-eup, Cheoin-gu Yongin-si, Gyeonggi-do 17036, Korea (Republic of) Main: +82-31-322-6767 / Fax: +82-31-322-6768</p>	<p style="text-align: center;">Test report No.: TREFCC22-0066</p>
---	---	--

6.1.2 Test equipment used

Equipment	Model	Manufacturer	Serial number	Next cal. date
EMI Test Receiver	ESR7	R&S	102160	2023.06.14
PULSE LIMITER	TFL-007D	KYORITSU	12-19-121	2023.06.14
LISN	ENV216	R&S	101416	2023.06.14
LISN Control Unit	LISN Controller	TSJ	06660-1	-
LISN Control Unit	LISN Controller	TSJ	06660-2	-
EMI CE Software	EMI-C3	TSJ	-	-

* All test equipment used is calibrated on a regular basis.

6.1.3 Conducted emission limit

Frequency (MHz)	Class A (dB(μV))		Class B (dB(μV))	
	Quasi-peak	Average	Quasi-peak	Average
0.15 to 0.5	79	66	66 ~ 56*	56 ~ 46*
0.5 to 5	73	60	56	46
5 to 30			60	50

Remark 1: (*) The limit decreases linearly with the logarithm of frequency.



<http://www.lab-t.net>

2182-42 Baegok-daero, Mohyeon-eup, Cheoin-gu
Yongin-si, Gyeonggi-do 17036, Korea (Republic of)
Main: +82-31-322-6767 / Fax: +82-31-322-6768

Test report No.:
TREFCC22-0066

6.1.4 Conducted emission test data

* Basic model (EME501-DP) Minimum limit margin is 7.4 dB at 15.51933 MHz. (Quasi-peak / Neutral)

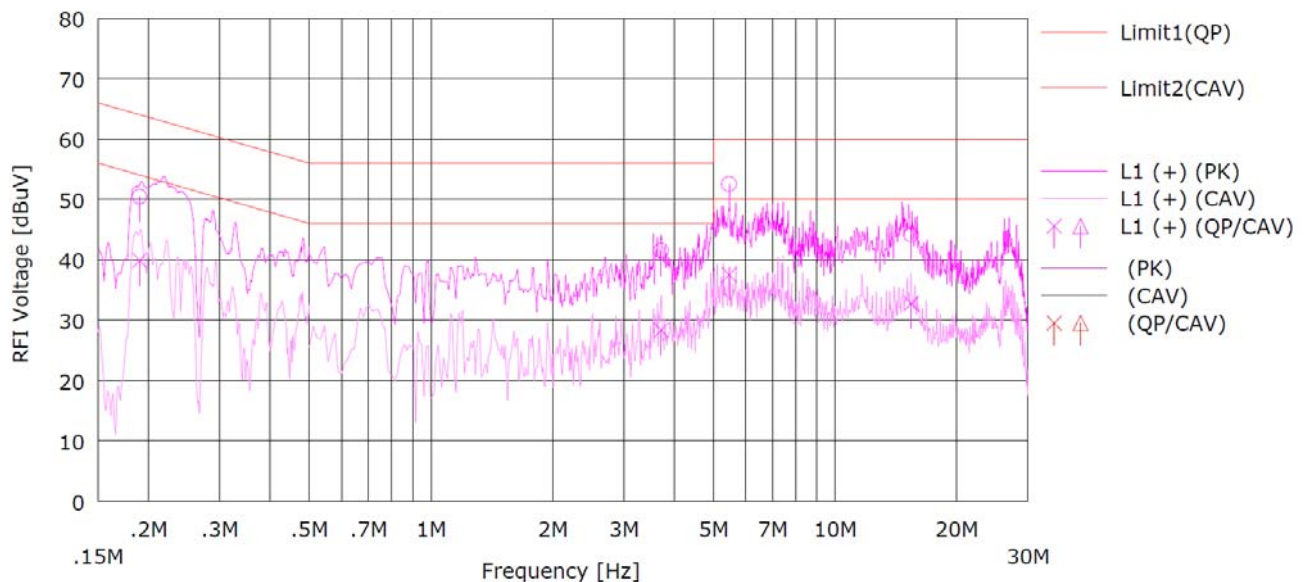
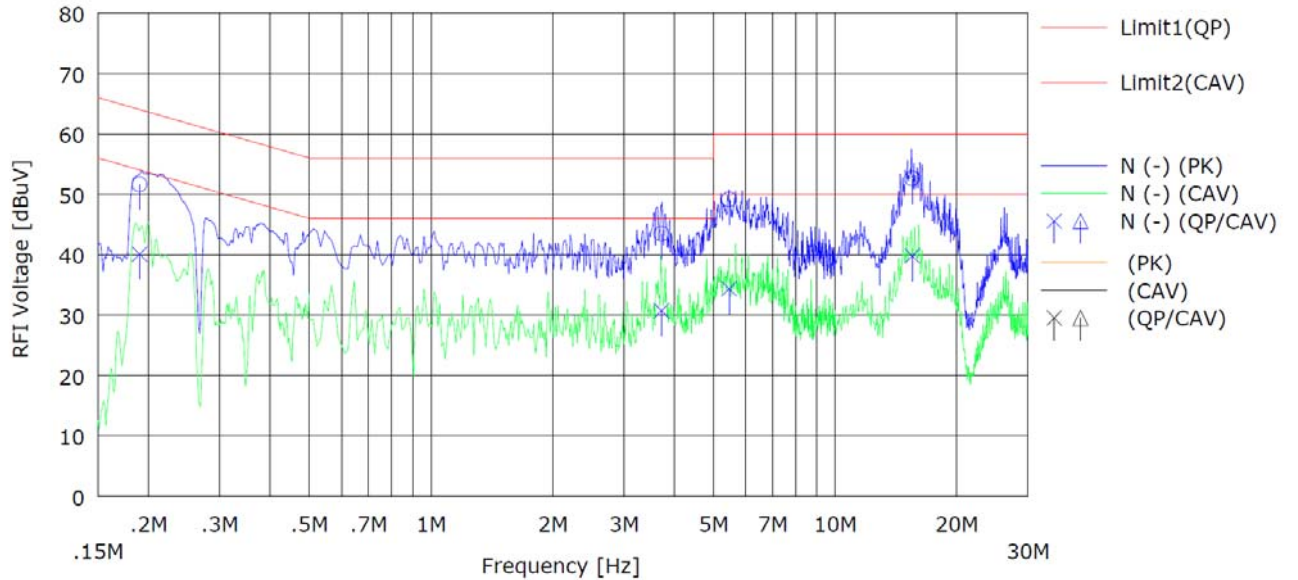



<http://www.lab-t.net>

2182-42 Baegok-daero, Mohyeon-eup, Cheoin-gu
Yongin-si, Gyeonggi-do 17036, Korea (Republic of)
Main: +82-31-322-6767 / Fax: +82-31-322-6768

Test report No.:
TREFCC22-0066

NO	FREQ [MHz]	READING		C.FACTOR [dB]	RESULT		LIMIT		MARGIN		PHASE
		QP [dBuV]	CAV [dBuV]		QP [dBuV]	CAV [dBuV]	QP [dBuV]	CAV [dBuV]	QP [dBuV]	CAV [dBuV]	
1	0.19001	41.5	30.0	10.1	51.6	40.1	64.0	54.0	12.4	13.9	N (-)
2	3.71952	33.5	20.7	10.0	43.5	30.7	56.0	46.0	12.5	15.3	N (-)
3	5.46799	39.1	24.3	10.1	49.1	34.3	60.0	50.0	10.9	15.7	N (-)
4	15.51933	42.1	29.2	10.6	52.6	39.8	60.0	50.0	7.4	10.2	N (-)
5	0.19001	40.4	29.8	10.1	50.5	39.9	64.0	54.0	13.5	14.1	L1 (+)
6	3.71204	31.5	18.4	10.0	41.5	28.3	56.0	46.0	14.5	17.7	L1 (+)
7	5.46749	42.5	27.5	10.1	52.5	37.5	60.0	50.0	7.5	12.5	L1 (+)
8	15.42406	33.6	22.2	10.5	44.2	32.8	60.0	50.0	15.8	17.2	L1 (+)

* Remark: "L1": (Line), "N": (Neutral)

* Result [dB(μ V)] = Reading [dB(μ V)] + C.FACTOR [dB]

* C.FACTOR [dB] = LISN insertion Loss [dB] + Cable loss [dB] + Pulse limiter factor [dB]

* Margin [dB] = Limit [dB(μ V)] - Result [dB(μ V)]

* QP: Quasi-peak, CAV: CISPR Average

* ex) Measure Value [QP]

Frequency: 0.19001 MHz

Result [dB μ V] = 51.6, Reading [dB μ V] = 41.5, C.FACTOR [dB] = 10.1

51.6 dB μ V = 41.5 dB μ V + 10.1 dB

Margin [dB μ V] = 12.4, Limit [dB μ V] = 64.0, Result [dB μ V] = 51.6

12.4 dB μ V = 64.0 dB μ V - 51.6 dB μ V



<http://www.lab-t.net>

2182-42 Baegok-daero, Mohyeon-eup, Cheoin-gu
Yongin-si, Gyeonggi-do 17036, Korea (Republic of)
Main: +82-31-322-6767 / Fax: +82-31-322-6768

Test report No.:
TREFCC22-0066

* Derivative model (EME501-SP) Minimum limit margin is 1.7 dB at 0.15252 MHz. (Quasi-peak / LINE)

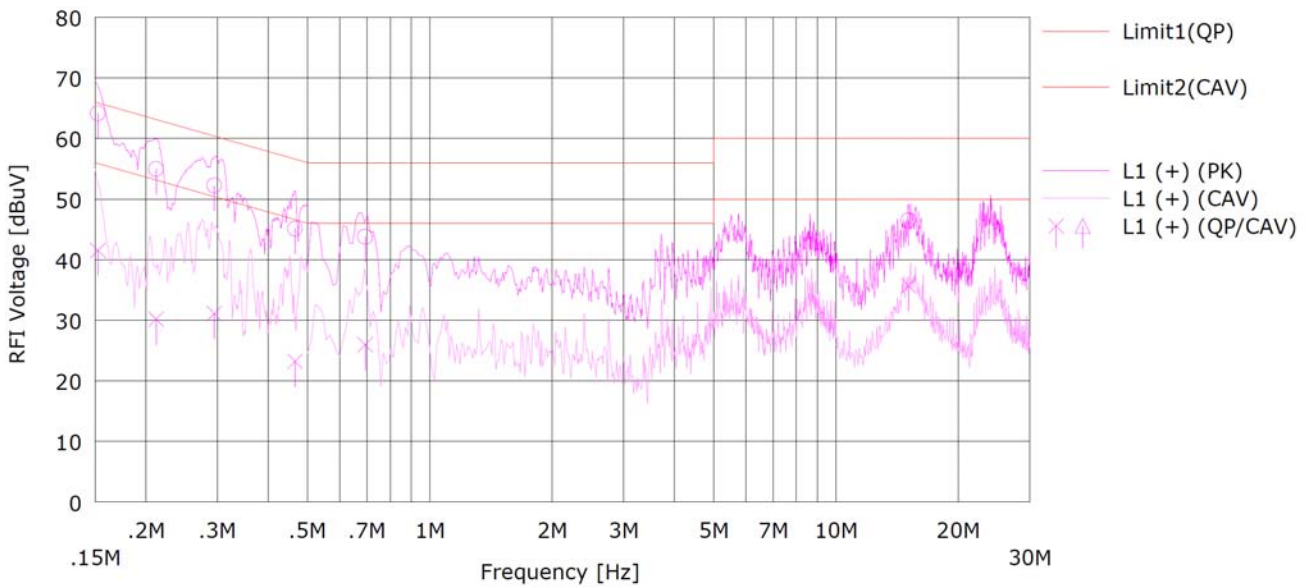
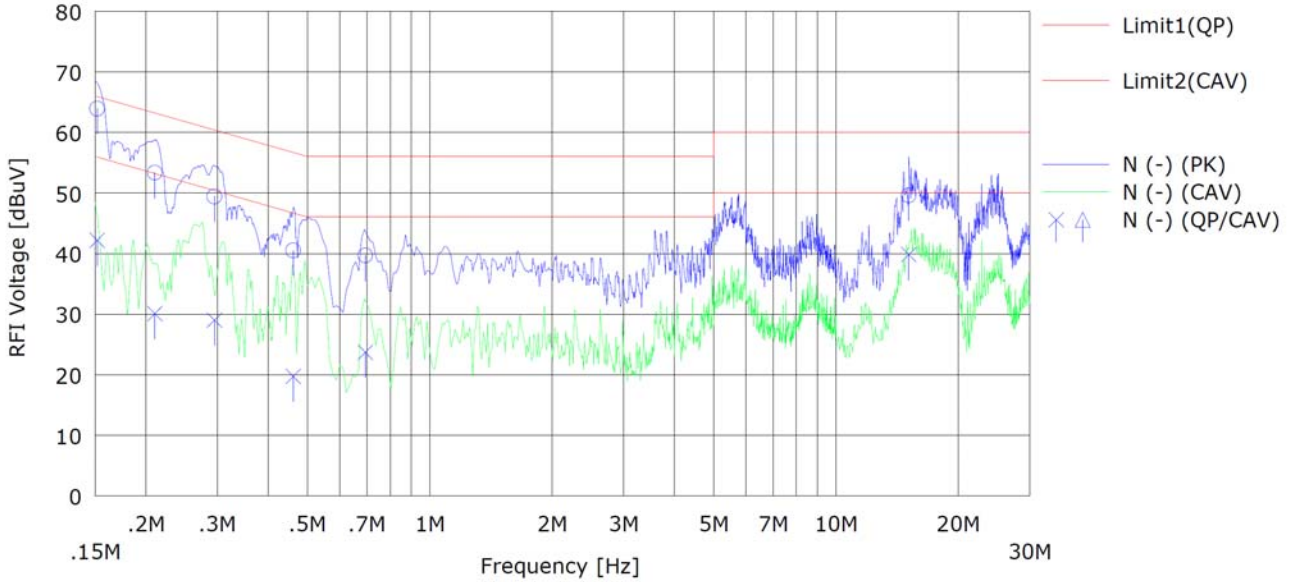



<http://www.lab-t.net>

2182-42 Baegok-daero, Mohyeon-eup, Cheoin-gu
Yongin-si, Gyeonggi-do 17036, Korea (Republic of)
Main: +82-31-322-6767 / Fax: +82-31-322-6768

Test report No.:
TREFCC22-0066

NO	FREQ [MHz]	READING		C.FACTOR [dB]	RESULT		LIMIT		MARGIN		PHASE
		QP [dBuV]	CAV [dBuV]		QP [dBuV]	CAV [dBuV]	QP [dBuV]	CAV [dBuV]	QP [dBuV]	CAV [dBuV]	
1	0.15177	54.1	32.3	9.8	63.9	42.2	65.9	55.9	2.0	13.7	N (-)
2	0.21051	43.4	20.1	10.0	53.3	30.1	63.2	53.2	9.9	23.1	N (-)
3	0.29527	39.6	19.2	9.8	49.4	29.0	60.4	50.4	11.0	21.4	N (-)
4	0.46121	30.5	9.7	10.0	40.5	19.7	56.7	46.7	16.2	27.0	N (-)
5	0.69396	29.7	13.7	9.9	39.7	23.7	56.0	46.0	16.3	22.3	N (-)
6	15.10860	39.0	29.3	10.5	49.6	39.8	60.0	50.0	10.4	10.2	N (-)
7	0.15252	54.3	31.7	9.9	64.2	41.5	65.9	55.9	1.7	14.4	L1 (+)
8	0.21193	45.0	20.2	10.0	55.0	30.2	63.1	53.1	8.1	22.9	L1 (+)
9	0.29511	42.4	21.3	9.9	52.2	31.1	60.4	50.4	8.2	19.3	L1 (+)
10	0.46592	35.1	13.2	10.0	45.1	23.2	56.6	46.6	11.5	23.4	L1 (+)
11	0.69391	33.8	16.0	9.9	43.8	25.9	56.0	46.0	12.2	20.1	L1 (+)
12	15.08566	36.0	25.2	10.5	46.5	35.7	60.0	50.0	13.5	14.3	L1 (+)

* Remark: "L1": (Line), "N": (Neutral)

* Result [dB(μV)] = Reading [dB(μV)] + C.FACTOR [dB]

* C.FACTOR [dB] = LISN insertion Loss [dB] + Cable loss [dB] + Pulse limiter factor [dB]

* Margin [dB] = Limit [dB(μV)] - Result [dB(μV)]

* QP: Quasi-peak , CAV: CISPR Average

* ex) Measure Value [QP]

Frequency: 0.15177 MHz

Result [dB μ V] = 63.9, Reading [dB μ V] = 54.1, C.FACTOR [dB]= 9.8

63.9 dB μ V = 54.1 dB μ V + 9.8 dB

Margin [dB μ V] = 2.0, Limit[dB μ V] = 65.9, Result [dB μ V] = 63.9

2.0 dB μ V = 65.9 dB μ V - 63.9 dB μ V

	<p style="text-align: center;">http://www.lab-t.net</p> <p style="text-align: center;">2182-42 Baegok-daero, Mohyeon-eup, Cheoin-gu Yongin-si, Gyeonggi-do 17036, Korea (Republic of) Main: +82-31-322-6767 / Fax: +82-31-322-6768</p>	<p style="text-align: center;">Test report No.: TREFCC22-0066</p>
---	---	--

6.2 Radiated emission (30 MHz ~ 1 000 MHz)

Test standard	47 CFR FCC Part 15 Subpart B §15.109
Test date	2022.07.20
Test facility	Building A 10 m chamber
Test voltage	AC 120 V, 60 Hz
Temperature	(21.4 ~ 21.8) °C
Relative humidity	(51.4 ~ 51.8) % R.H.
Test result	Complied

6.2.1 Measurement procedure

If the EUT is tabletop equipment, it was placed on a wooden table with a height of 0.8 m above the reference ground plane and 3 m away from the interference receiving antenna in the 10 m semi-anechoic chamber.

Also if the EUT is floor-standing equipment, it was placed either directly on the reference ground plane or on insulating material as described in ANSI C 63.4 6.3.3.2. Rotate the EUT from (0 - 360)° and position the receiving antenna at heights from (1 - 4) m above the reference ground plane continuously to determine associated with higher emission levels and record them.

The measurement was made in both the vertical and horizontal polarization, and the maximum value is presented in the report. For 30 MHz ~ 1 000 MHz frequency range, quasi-peak detector with 120 kHz RBW was used.

	<p style="text-align: center;">http://www.lab-t.net</p> <p style="text-align: center;">2182-42 Baegok-daero, Mohyeon-eup, Cheoin-gu Yongin-si, Gyeonggi-do 17036, Korea (Republic of) Main: +82-31-322-6767 / Fax: +82-31-322-6768</p>	<p style="text-align: center;">Test report No.: TREFCC22-0066</p>
---	---	--

6.2.2 Test equipment used

Equipment	Model	Manufacturer	Serial number	Next cal. date
EMI test receiver	ESW44	R&S	101839	2023.06.14
Preamplifier	BPA00T30W01-S	L2 MICROWAVE	2003-0003	2023.06.14
Bi-Log Antenna	VULB9168	Schwarzbeck	00822	2023.03.31
Attenuator	50FPE-006 N 6dB	JFW	6dB-1	2023.03.31
Controller	C3000	Innco	45450119	-
Antenna mast	MA4000-EP	Innco	-	-
Turn table	-	-	-	-
EMI RE software	EMI-R	TSJ	-	-

* All test equipment used is calibrated on a regular basis.

6.2.3 Radiated emission limit

- The test frequency range of radiated disturbance measurements are listed below

Highest frequency generated or used in the device or on which the device operates or tunes (MHz)	Upper frequency of measurement range (MHz)
Below 108	1 000
108 - 500	2 000
500 - 1 000	5 000
Above 1 000	5th harmonic of the highest frequency or 40 GHz, whichever is lower

- Limit for radiated emission below 1 000 MHz

Frequency range (MHz)	Class A Equipment (10 m distance)	Class B Equipment (3 m distance)
	Quasi-peak (dB(μV/m))	Quasi-peak (dB(μV/m))
30 to 88	39.1	40
88 to 216	43.5	43.5
216 to 960	46.4	46
960 to 1 000	49.5	54

Note 1 The lower limit shall apply at the transition frequency.

Note 2 Additional provisions may be required for cases where interference occurs.

Note 3 According to 15.109(g), as an alternative to the radiated emission limit shown above, digital devices may be shown to comply with the standards(CISPR), Pub. 22 shown as below.



<http://www.lab-t.net>

2182-42 Baegok-daero, Mohyeon-eup, Cheoin-gu
Yongin-si, Gyeonggi-do 17036, Korea (Republic of)
Main: +82-31-322-6767 / Fax: +82-31-322-6768

Test report No.:
TREFCC22-0066

6.2.4 Radiated emission test data

* Basic model (EME501-DP) Minimum limit margin is 2.1 dB at 33.105 MHz. (Quasi-peak / Vertical)

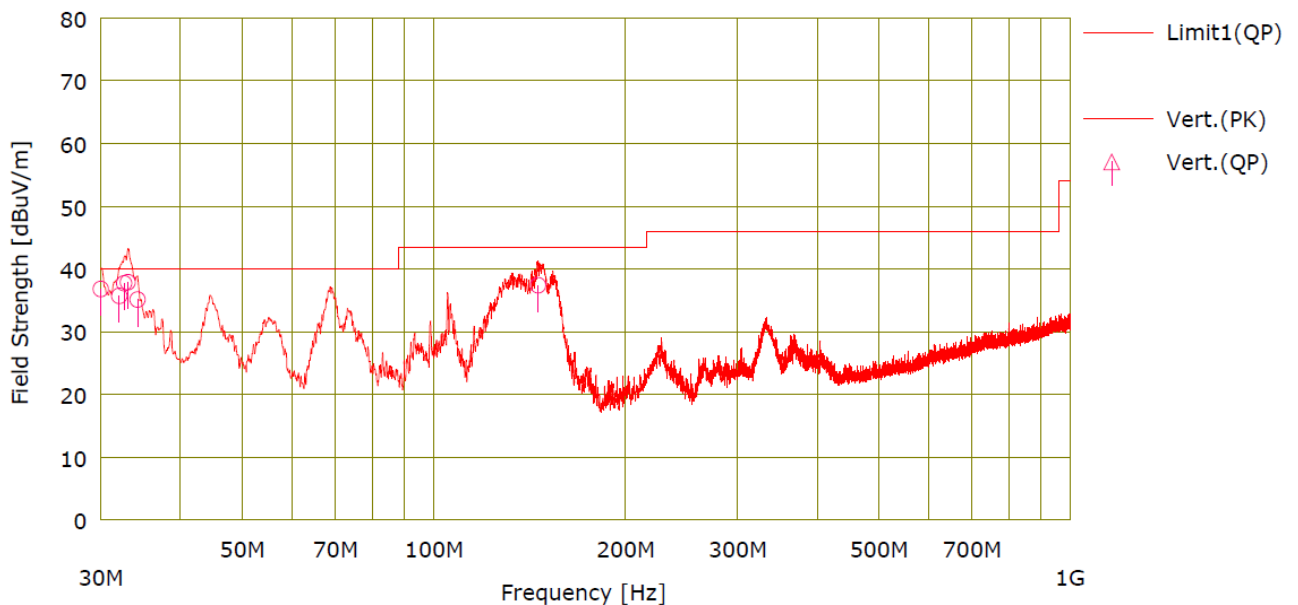
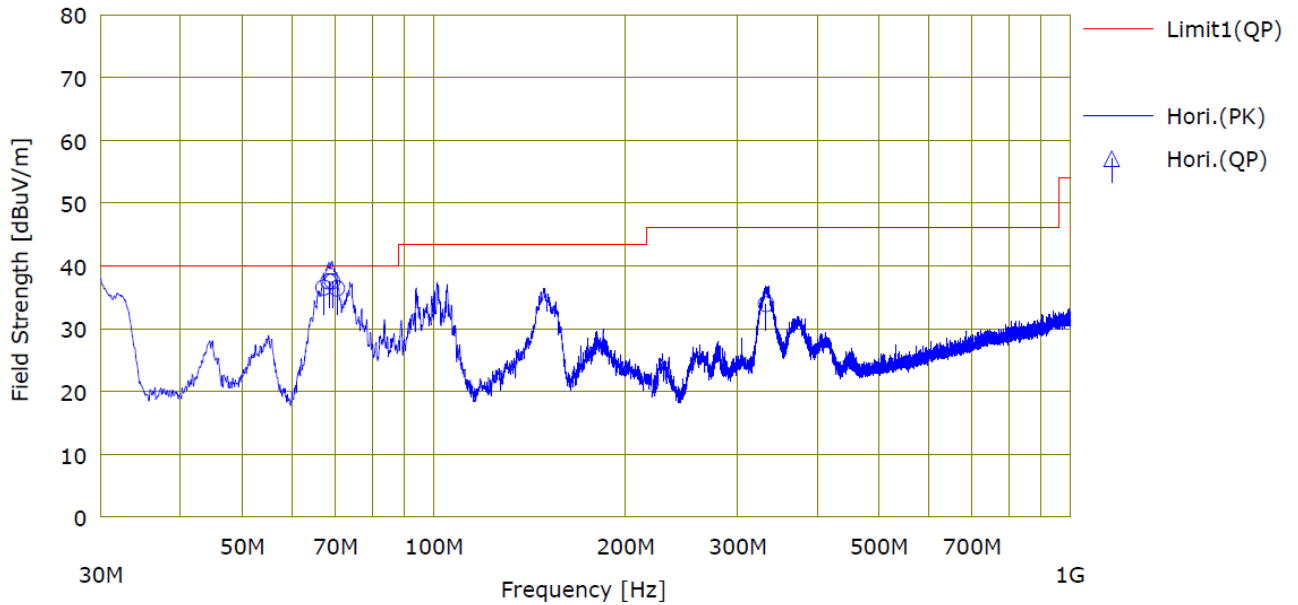



<http://www.lab-t.net>

2182-42 Baegok-daero, Mohyeon-eup, Cheoin-gu
Yongin-si, Gyeonggi-do 17036, Korea (Republic of)
Main: +82-31-322-6767 / Fax: +82-31-322-6768

Test report No.:
TREFCC22-0066

<< QP DATA >>

No.	Freq. [MHz]	Reading	Ant. Fac [dB/m]	Loss [dB]	Gain [dB]	Result	Limit	Margin	Pola. [H/V]	Height [cm]	Angle [deg]	Ant. Type
		<QP> [dBuV]				<QP> [dBuV/m]	<QP> [dB]					
1	67.121	63.7	18.1	-45.3	0.0	36.5	40.0	3.5	Hori.	300	254	VULB9
2	68.412	64.9	17.9	-45.3	0.0	37.5	40.0	2.5	Hori.	300	265	VULB9
3	69.276	65.0	17.7	-45.3	0.0	37.5	40.0	2.5	Hori.	300	265	VULB9
4	70.427	64.1	17.5	-45.3	0.0	36.4	40.0	3.6	Hori.	300	245	VULB9
5	332.541	55.5	20.3	-41.9	0.0	33.9	46.0	12.1	Hori.	100	109	VULB9
6	30.011	63.2	18.3	-44.7	0.0	36.8	40.0	3.2	Vert.	100	1	VULB9
7	32.091	62.3	18.4	-45.0	0.0	35.7	40.0	4.3	Vert.	100	241	VULB9
8	32.658	64.3	18.5	-45.1	0.0	37.7	40.0	2.3	Vert.	100	268	VULB9
9	33.105	64.5	18.5	-45.1	0.0	37.9	40.0	2.1	Vert.	100	234	VULB9
10	34.255	61.8	18.6	-45.3	0.0	35.1	40.0	4.9	Vert.	100	261	VULB9
11	145.917	61.7	19.4	-43.7	0.0	37.4	43.5	6.1	Vert.	100	153	VULB9

* Results [dB(μV/m)] = Reading [dB(μV)] + Antenna factor [dB/m] - Loss

* Loss = Cable loss [dB] - Amp gain [dB]

* Margin [dB] = Limit [dB(μV/m)] - Results [dB(μV/m)]

* QP: Quasi-peak

* ex) Measure Value [QP]

Frequency: 67.121 MHz

Result [dB μ V/m] = 36.5, Reading [dB μ V/m] = 63.7, Antenna factor [dB/m] = 18.1, Loss [dB] = -45.3, Amp gain [dB] = 0.0

36.5 dB μ V/m = 63.7 dB μ V/m + 18.1 dB/m - 45.3 dB - 0.0 dB

Margin [dB μ V/m] = 3.5, Limit [dB μ V/m] = 40.0, Result [dB μ V/m] = 36.5

3.5 dB μ V/m = 40.0 dB μ V/m - 36.5 dB μ V/m



<http://www.lab-t.net>

2182-42 Baegok-daero, Moheon-eup, Cheoin-gu
Yongin-si, Gyeonggi-do 17036, Korea (Republic of)
Main: +82-31-322-6767 / Fax: +82-31-322-6768

Test report No.:
TREFCC22-0066

* Derivative model (EME501-SP) Minimum limit margin is 3.9 dB at 30.048 MHz. (Quasi-peak / Vertical)

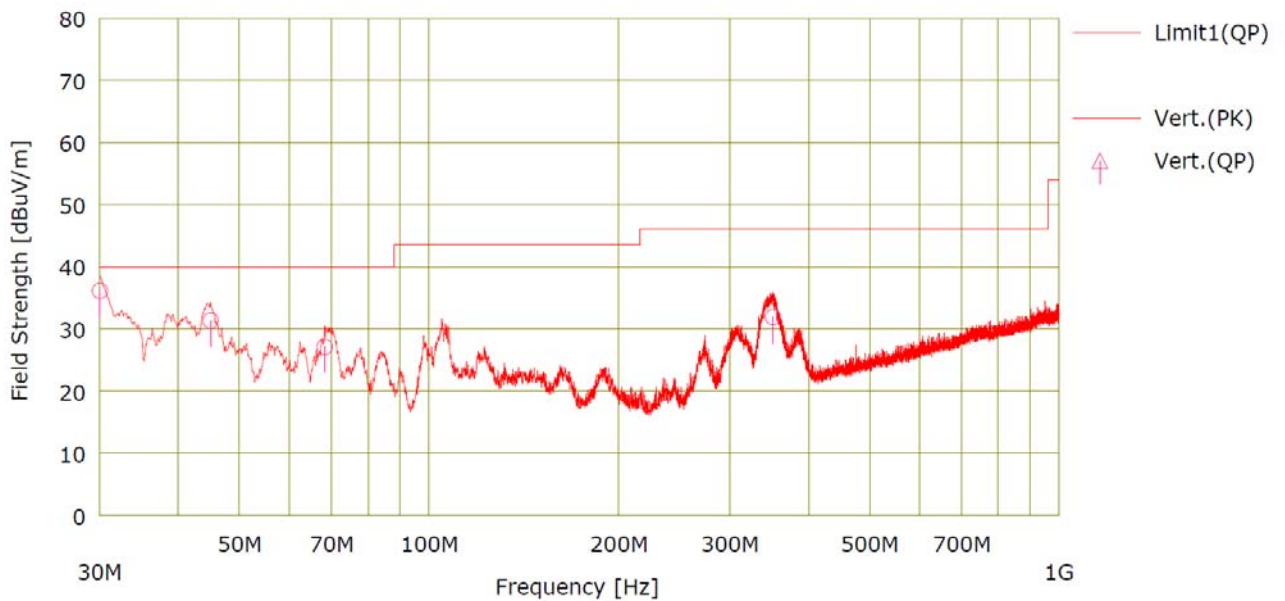
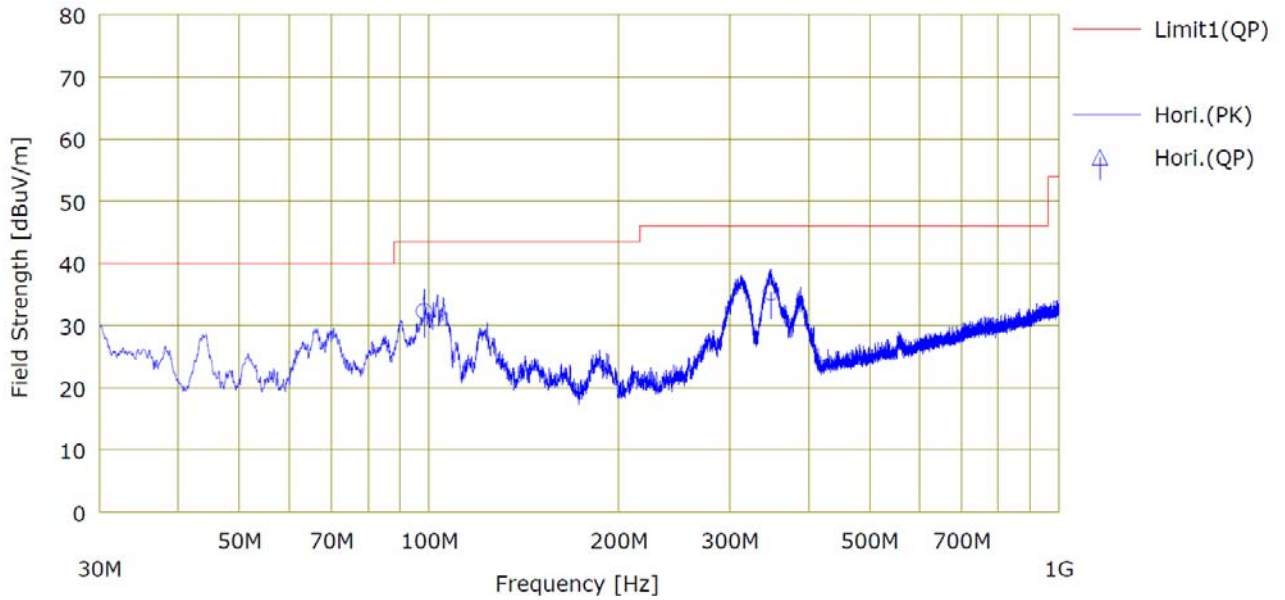



<http://www.lab-t.net>

2182-42 Baegok-daero, Mohyeon-eup, Cheoin-gu
Yongin-si, Gyeonggi-do 17036, Korea (Republic of)
Main: +82-31-322-6767 / Fax: +82-31-322-6768

Test report No.:
TREFCC22-0066

<< QP DATA >>

No.	Freq. [MHz]	Reading	Ant. Fac [dB/m]	Loss [dB]	Gain [dB]	Result	Limit	Margin	Pola. [H/V]	Height [cm]	Angle [deg]	Ant. Type
		<QP> [dBuV]				<QP> [dBuV/m]	<QP> [dB]					
1	98.190	62.5	14.5	-44.7	0.0	32.3	43.5	11.2	Hori.	200	285	VULB9
2	348.839	56.8	20.3	-41.9	0.0	35.3	46.0	10.7	Hori.	100	108	VULB9
3	30.048	62.5	18.3	-44.8	0.0	36.1	40.0	3.9	Vert.	100	0	VULB9
4	45.037	57.4	19.6	-45.7	0.0	31.3	40.0	8.7	Vert.	100	215	VULB9
5	68.315	54.5	17.9	-45.3	0.0	27.1	40.0	12.9	Vert.	100	217	VULB9
6	351.250	53.4	20.4	-41.8	0.0	31.9	46.0	14.1	Vert.	100	298	VULB9

* Results [dB(μV/m)] = Reading [dB(μV)] + Antenna factor [dB/m] - Loss

* Loss = Cable loss [dB] - Amp gain [dB]

* Margin [dB] = Limit [dB(μV/m)] - Results [dB(μV/m)]

* QP: Quasi-peak

* ex) Measure Value [QP]

Frequency: 98.190 MHz

Result [dB μ V/m] = 32.3, Reading [dB μ V/m] = 62.5, Antenna factor [dB/m] = 14.5, Loss [dB] = -44.7, Amp gain [dB] = 0.0

32.3 dB μ V/m = 62.5 dB μ V/m + 14.5 dB/m - 44.7 dB - 0.0 dB

Margin [dB μ V/m] = 11.2, Limit [dB μ V/m] = 43.5, Result [dB μ V/m] = 32.3

11.2 dB μ V/m = 43.5 dB μ V/m - 32.3 dB μ V/m

	<p style="text-align: center;">http://www.lab-t.net</p> <p style="text-align: center;">2182-42 Baegok-daero, Mohyeon-eup, Cheoin-gu Yongin-si, Gyeonggi-do 17036, Korea (Republic of) Main: +82-31-322-6767 / Fax: +82-31-322-6768</p>	<p style="text-align: center;">Test report No.: TREFCC22-0066</p>
---	---	--

6.3 Radiated emission (Above 1 GHz)

Test standard	47 CFR FCC Part 15 Subpart B §15.109
Test date	2022.07.20
Test facility	Building A 10 m chamber
Test voltage	AC 120 V, 60 Hz
Temperature	(22.1 ~ 22.6) °C
Relative humidity	(52.0 ~ 52.5) % R.H.
Test result	Complied

6.3.1 Measurement procedure

If the EUT is tabletop equipment, it was placed on a wooden table with a height of 0.1 m above the reference ground plane and 3 m away from the interference receiving antenna in the 10 m chamber. Also if the EUT is floor-standing equipment, it was placed either directly on the reference ground plane or on insulating material as described in ANSI C 63.4 6.3.3.2. Rotate the EUT from (0 - 360)° and position the receiving antenna at heights from (1 - 4) m above the reference ground plane continuously to determine associated with higher emission levels and record them. The measurement was made in both the vertical and horizontal polarization, and the maximum value is presented in the report. For peak and average detector with 1 MHz RBW were used for above 1 GHz frequency range.

	<p style="text-align: center;">http://www.lab-t.net</p> <p style="text-align: center;">2182-42 Baegok-daero, Mohyeon-eup, Cheoin-gu Yongin-si, Gyeonggi-do 17036, Korea (Republic of) Main: +82-31-322-6767 / Fax: +82-31-322-6768</p>	<p style="text-align: center;">Test report No.: TREFCC22-0066</p>
---	---	--

6.3.2 Test equipment used

Equipment	Model	Manufacturer	Serial number	Next cal. date
EMI test receiver	ESW44	R&S	101839	2023.06.14
Horn Antenna	BBHA 9120 D	Schwarzbeck	01735	2023.04.18
Low Noise amplifier	TK-PA18H	TESTEK	170004-L	2023.04.13
Controller	C3000	Innco	45450119	-
Antenna mast	MA4640-XP-ET	Innco	-	-
Turn table	-	-	-	-
EMI RE Software	EMI-R	TSJ	-	-

* All test equipment used is calibrated on a regular basis

6.3.3 Radiated emission limits

Frequency (GHz)	Class A equipment (3 m distance) (dB(μV/m))		Class B equipment (3 m distance) (dB(μV/m))	
	Peak	CISPR Average	Peak	CISPR Average
1 to 13	80	60	74	54

6.3.4 Radiated emission test data

* Basic model (EME501-DP)

Minimum limit margin is 14.6 dB at 12400.120 MHz. (CISPR Average / Horizontal)

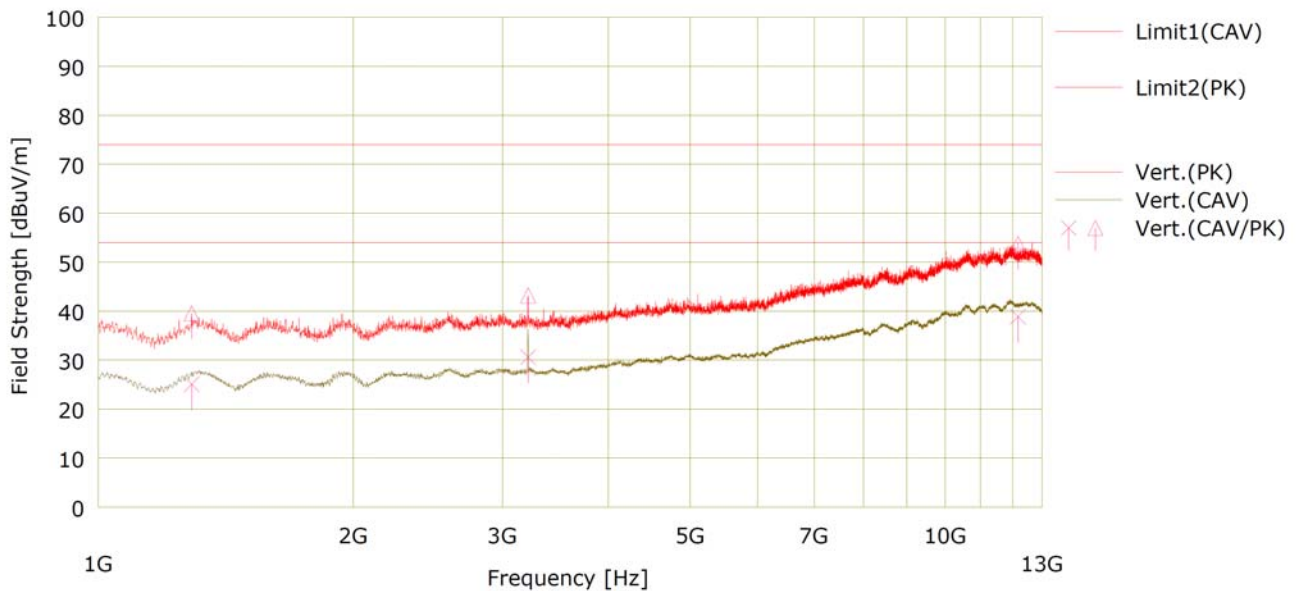
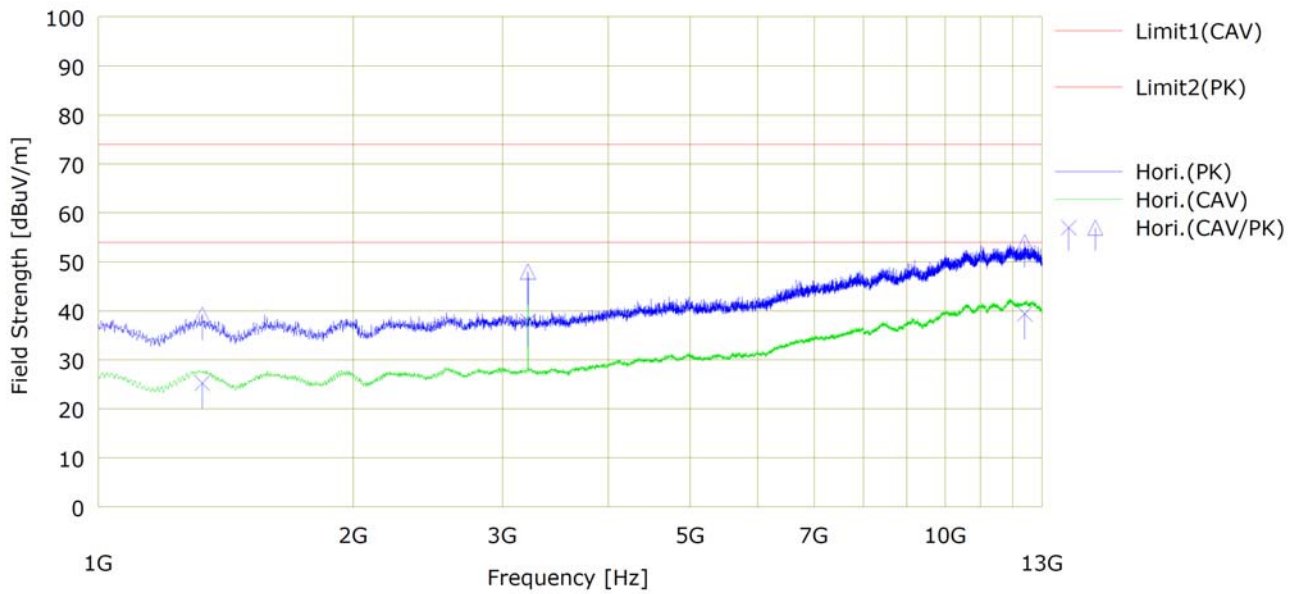



<http://www.lab-t.net>

2182-42 Baegok-daero, Moheon-eup, Cheoin-gu
Yongin-si, Gyeonggi-do 17036, Korea (Republic of)
Main: +82-31-322-6767 / Fax: +82-31-322-6768

Test report No.:
TREFCC22-0066

<< CAV/PK DATA >>

No.	Freq. [MHz]	Reading		Ant.Fac [dB/m]	Loss [dB]	Gain [dB]	S.Fac [dB]	Result		Limit		Margin		Pola. [H/V]	Height [cm]	Angle [deg]	Ant. Type
		<CAV>	<PK>					<CAV>	<PK>	<CAV>	<PK>						
		[dBuV]	[dBuV]					[dBuV/m]	[dBuV/m]	[dBuV/m]	[dBuV/m]						
1	1326.380	31.2	45.2	25.4	10.5	45.5	3.5	25.2	39.2	54.0	74.0	28.8	34.8	Hori.	100	353	HORN_
2	3215.428	38.6	48.7	28.6	11.8	44.5	3.5	37.9	48.0	54.0	74.0	16.1	26.0	Hori.	300	258	HORN_
3	12400.120	16.3	30.9	39.0	21.7	41.1	3.5	39.4	54.0	54.0	74.0	14.6	20.0	Hori.	100	218	HORN_
4	1289.147	31.2	45.7	25.3	10.6	45.5	3.5	25.1	39.6	54.0	74.0	28.9	34.4	Vert.	100	173	HORN_
5	3216.447	31.3	43.9	28.6	11.8	44.5	3.5	30.6	43.2	54.0	74.0	23.4	30.8	Vert.	200	0	HORN_
6	12176.960	16.1	30.9	39.0	21.4	41.2	3.5	38.9	53.7	54.0	74.0	15.1	20.3	Vert.	100	11	HORN_

* Results [dB(μV/m)] = Reading [dB(μV)] + Antenna factor [dB/m] - Loss [dB]

* Loss = Cable loss [dB] - Amp gain [dB] + S.Fac

* Margin [dB] = Limit [dB(μV/m)] - Results [dB(μV/m)]

* QP: Quasi-peak, CAV: CISPR Average

* ex) Measure Value[CAV]

Frequency: 1326.380 MHz

Results [dB μ V/m] = 25.2, Reading [dB μ V/m] = 31.2, Antenna factor [dB/m] = 25.4, Loss [dB] = 10.5,

Amp gain [dB] = 45.5, S.Fac [dB] = 3.5

25.2 dB μ V/m = 31.2 dB μ V/m + 25.4 dB/m + 10.5 dB - 45.5 dB + 3.5 dB

Margin [dB μ V/m] = 28.8, Limit [dB μ V/m] = 54.0, Result [dB μ V/m] = 25.2

28.8 dB μ V/m = 54.0 dB μ V/m - 25.2 dB μ V/m



<http://www.lab-t.net>

2182-42 Baegok-daero, Mohyeon-eup, Cheoin-gu
Yongin-si, Gyeonggi-do 17036, Korea (Republic of)
Main: +82-31-322-6767 / Fax: +82-31-322-6768

Test report No.:
TREFCC22-0066

* Derivative model (EME501-SP)

Minimum limit margin is 14.1 dB at 11939.080 MHz. (CISPR Average / Vertical)

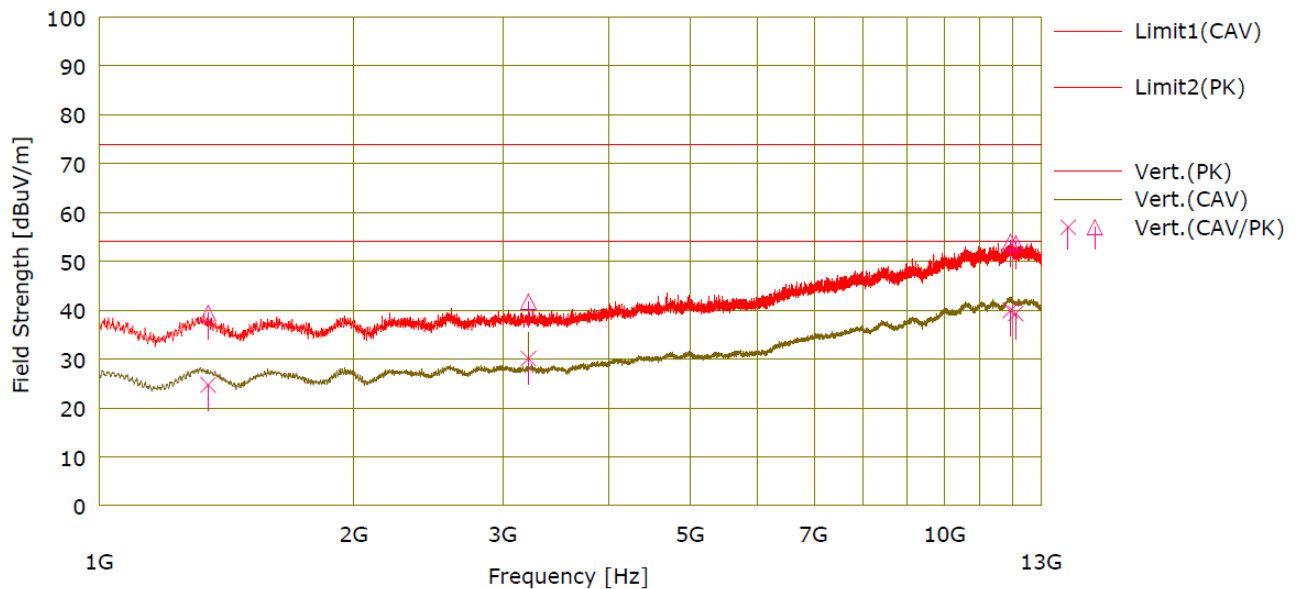
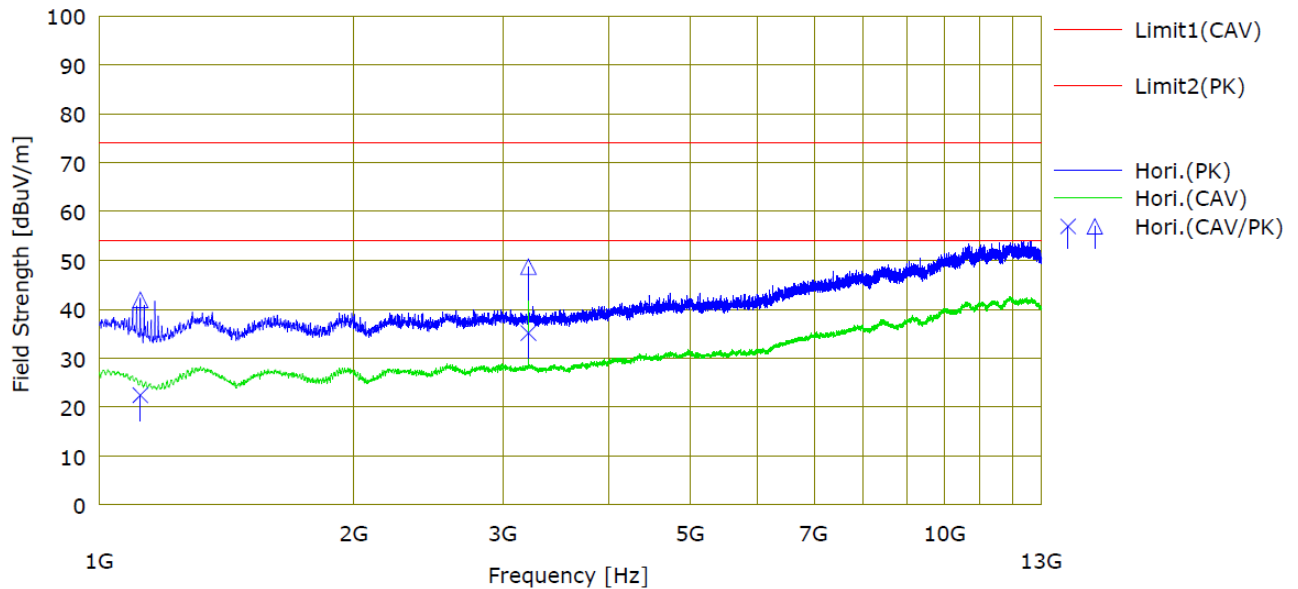



<http://www.lab-t.net>

2182-42 Baegok-daero, Mohyeon-eup, Cheoin-gu
Yongin-si, Gyeonggi-do 17036, Korea (Republic of)
Main: +82-31-322-6767 / Fax: +82-31-322-6768

Test report No.:
TREFCC22-0066

<< CAV/PK DATA >>

No.	Freq. [MHz]	Reading		Ant.Fac [dB/m]	Loss [dB]	Gain [dB]	S.Fac [dB]	Result		Limit		Margin		Pola. [H/V]	Height [cm]	Angle [deg]	Ant. Type
		<CAV>	<PK>					<CAV>	<PK>	<CAV>	<PK>						
		[dBuV]	[dBuV]					[dBuV/m]	[dBuV/m]	[dB]	[dB]						
1	1117.631	28.9	48.4	24.9	10.6	45.6	3.5	22.4	41.9	54.0	74.0	31.6	32.1	Hori.	400	324	HORN_
2	3215.280	35.8	49.4	28.6	11.8	44.5	3.5	35.1	48.7	54.0	74.0	18.9	25.3	Hori.	100	231	HORN_
3	1344.368	30.7	45.4	25.4	10.5	45.5	3.5	24.7	39.4	54.0	74.0	29.3	34.6	Vert.	100	255	HORN_
4	3215.194	30.8	42.4	28.6	11.8	44.5	3.5	30.1	41.7	54.0	74.0	23.9	32.3	Vert.	200	2	HORN_
5	11939.080	17.5	31.6	39.1	21.2	41.4	3.5	39.9	54.0	54.0	74.0	14.1	20.0	Vert.	100	181	HORN_
6	12119.950	16.6	30.9	39.0	21.4	41.2	3.5	39.3	53.6	54.0	74.0	14.7	20.4	Vert.	300	191	HORN_

* Results [dB(μV/m)] = Reading [dB(μV)] + Antenna factor [dB/m] - Loss [dB]

* Loss = Cable loss [dB] - Amp gain [dB] + S.Fac

* Margin [dB] = Limit [dB(μV/m)] - Results [dB(μV/m)]

* QP: Quasi-peak, CAV: CISPR Average

* ex) Measure Value[CAV]

Frequency: 1117.631 MHz

Results [dB μ V/m] = 22.4, Reading [dB μ V/m] = 28.9, Antenna factor [dB/m] = 24.9, Loss [dB] = 10.6,

Amp gain [dB] = 45.6, S.Fac [dB] = 3.5

22.4 dB μ V/m = 28.9 dB μ V/m + 24.9 dB/m + 10.6 dB - 45.6 dB + 3.5 dB

Margin [dB μ V/m] = 31.6, Limit [dB μ V/m] = 54.0, Result [dB μ V/m] = 22.4

31.6 dB μ V/m = 54.0 dB μ V/m - 22.4 dB μ V/m